



#### Digital – in the vehicle

Familiarize yourself with the contents of the Operator's Manual directly via the vehicle's multimedia system (menu item "Vehicle information"). Start with the quick guide or broaden your knowledge with practical tips.



#### Vehicle document wallet

Here you can find comprehensive information about operating your vehicle and about services and guarantees in printed form.



#### Digital – on the Internet

You can find the Operator's Manual on the Mercedes-Benz homepage.



#### Digital – as an app

The Mercedes-Benz Guides app is available free-of-charge in familiar app stores.

GLC



## GLC

Operator's Manual

Mercedes-Benz



2535843011

Order no. P253 1104 13 Part no. 253 584 30 11  
Edition C-2020



Apple® iOS



Android™

Mercedes-Benz

## Front passenger airbag warning

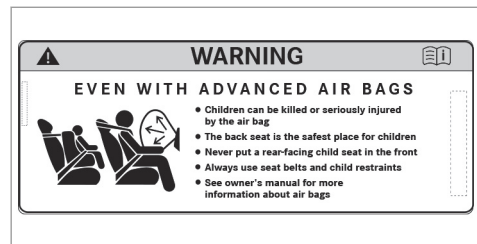

Example

**⚠ WARNING** Risk of injury or fatal injuries if the front-passenger airbag is enabled

If the front-passenger front airbag is enabled, a child on the front-passenger seat may be struck by the front-passenger airbag during an accident.

NEVER use a rearward-facing child restraint system on a seat with an ENABLED FRONT AIRBAG, DEATH or SERIOUS INJURY to the CHILD can occur.

Observe the chapter "Children in the vehicle".

## Publication details

### Internet

Further information about Mercedes-Benz vehicles and about Daimler AG can be found on the following websites:

<http://www.mbusa.com> (USA only)

<http://www.mercedes-benz.ca> (Canada only)

### Documentation team

©Daimler AG: not to be reprinted, translated or otherwise reproduced, in whole or in part, without written permission from Daimler AG.

### Vehicle manufacturer

Daimler AG

Mercedesstrasse 137

70327 Stuttgart

Germany

As at 28.02.2019

## Welcome to the world of Mercedes-Benz

Before you first drive off, read this Operator's Manual carefully and familiarize yourself with your vehicle. For your own safety and a longer operating lifespan of the vehicle, follow the instructions and warning notices in this Operator's Manual. Disregarding them may lead to damage to the vehicle or injury to people.

Damage to the vehicle resulting from the disregard of the instructions is not covered by the Mercedes-Benz Limited Warranty.

The standard equipment and product description of your vehicle may vary and depends on the following factors:

- Model
- Order
- National version
- Availability

Mercedes-Benz reserves the right to introduce changes in the following areas:

- Design
- Equipment

- Technical features

The equipment in your vehicle may therefore differ from that shown in the descriptions and illustrations.

The following documents are integral parts of the vehicle:

- Digital Operator's Manual
- Printed Operator's Manual
- Maintenance Booklet
- Equipment-dependent Supplements

Keep these documents in the vehicle at all times. If you sell the vehicle, always pass all of the documents on to the new owner.

Mercedes-Benz USA, LLC  
Mercedes-Benz Canada, Inc.  
A Daimler Company

2535843011



|  |    |   |    |   |     |
|--|----|---|----|---|-----|
| <b>Symbols</b> .....                           | 5  | Qualified specialist workshop .....       | 26 | Roller sun blinds .....                     | 88  |
|  |    | Correct use of the vehicle .....          | 27 | Anti-theft protection .....                 | 90  |
|  |    | Problems with your vehicle .....          | 27 |   |     |
| <b>At a glance</b> .....                       | 6  | Reporting safety defects .....            | 27 | <b>Seats and stowing</b> .....              | 94  |
| Cockpit .....                                  | 6  | Limited Warranty .....                    | 28 | Notes on the correct driver's seat posi-    |     |
| Indicator and warning lamps (standard) .....   | 10 | QR code for rescue card .....             | 28 | tion .....                                  | 94  |
| Indicator and warning lamps (Wide-             |    | Data storage .....                        | 28 | Seats .....                                 | 95  |
| screen Cockpit) .....                          | 12 | Copyright .....                           | 31 | Steering wheel .....                        | 103 |
| Overhead control panel .....                   | 14 |   |    | Easy entry and exit feature .....           | 104 |
| Door control panel and seat adjustment .....   | 16 | <b>Occupant safety</b> .....              | 33 | Operating the memory function .....         | 105 |
| Emergencies and breakdowns .....               | 18 | Restraint system .....                    | 33 | Stowage areas .....                         | 106 |
|  |    | Seat belts .....                          | 35 | Cup holder .....                            | 121 |
| <b>Digital Operator's Manual</b> .....         | 20 | Airbags .....                             | 40 | Ashtray and cigarette lighter .....         | 123 |
| Calling up the Digital Operator's Manual ..... | 20 | PRE-SAFE® system .....                    | 47 | Sockets .....                               | 124 |
|  |    | Safely transporting children in the vehi- |    | Wireless charging of the mobile phone       |     |
| <b>General notes</b> .....                     | 21 | cle .....                                 | 49 | and connection with the exterior antenna .. | 127 |
| Protecting the environment .....               | 21 | Notes on pets in the vehicle .....        | 64 | Installing/removing the floor mats .....    | 129 |
| Genuine Mercedes-Benz parts .....              | 21 |   |    |   |     |
| Operator's Manual .....                        | 22 | <b>Opening and closing</b> .....          | 65 | <b>Light and visibility</b> .....           | 130 |
| Service and vehicle operation .....            | 23 | SmartKey .....                            | 65 | Exterior lighting .....                     | 130 |
| Operating safety .....                         | 24 | Doors .....                               | 70 | Interior lighting .....                     | 135 |
| Declaration of conformity for wireless         |    | Cargo compartment .....                   | 74 | Windshield wiper and windshield washer      |     |
| vehicle components .....                       | 25 | Side windows .....                        | 79 | system .....                                | 137 |
| Diagnostics connection .....                   | 26 | Sliding sunroof .....                     | 83 | Mirrors .....                               | 140 |

|   |            |  |            |   |            |
|---|------------|--|------------|---|------------|
| Operating the sun visors .....                            | 143        | Setting the design .....                                     | 255        | <b>Maintenance and care</b> .....                             | <b>420</b> |
| <b>Climate control</b> .....                              | <b>145</b> | Setting the area for additional values .....                 | 255        | ASSYST PLUS service interval display .....                    | 420        |
| Overview of climate control systems .....                 | 145        | Overview of displays on the multifunc-<br>tion display ..... | 256        | Engine compartment .....                                      | 421        |
| Operating the climate control system .....                | 146        | Adjusting the instrument lighting .....                      | 257        | Cleaning and care .....                                       | 428        |
| <b>Driving and parking</b> .....                          | <b>152</b> | Menus and submenus .....                                     | 257        | <b>Breakdown assistance</b> .....                             | <b>437</b> |
| Driving .....   | 152        | Head-up Display .....  | 263        | Emergency .....   | 437        |
| DYNAMIC SELECT switch .....                               | 165        | <b>Voice Control System</b> .....                            | <b>265</b> | Flat tire .....   | 437        |
| Automatic transmission .....                              | 167        | Notes on operating safety .....                              | 265        | Battery (vehicle) .....                                       | 443        |
| Function of 4MATIC .....                                  | 172        | Operation .....  | 266        | Tow starting or towing away .....                             | 449        |
| Refueling .....   | 172        | Using the Voice Control System effec-<br>tively .....        | 268        | Electrical fuses .....  | 454        |
| Parking .....   | 174        | Essential voice commands .....                               | 269        | <b>Wheels and tires</b> .....                                 | <b>458</b> |
| Driving and driving safety systems .....                  | 184        | <b>MBUX multimedia system</b> .....                          | <b>284</b> | Notes on noise or unusual handling char-<br>acteristics ..... | 458        |
| Trailer hitch .....                                       | 247        | Overview and operation .....                                 | 284        | Notes on regularly inspecting wheels and<br>tires .....       | 458        |
| Vehicle towing instructions .....                         | 251        | System settings .....  | 317        | Notes on snow chains .....                                    | 459        |
| <b>Instrument Display and on-board<br/>computer</b> ..... | <b>252</b> | Navigation .....   | 326        | Tire pressure .....   | 460        |
| Instrument Display overview .....                         | 252        | Telephone .....  | 366        | Loading the vehicle .....                                     | 467        |
| Overview of the buttons on the steering<br>wheel .....    | 253        | Online and Internet functions .....                          | 394        | Tire labeling .....   | 471        |
| Operating the on-board computer .....                     | 253        | Media .....  | 401        | Definition of terms for tires and loading .....               | 476        |
|   |            | Radio .....  | 408        | Changing a wheel .....  | 479        |
|   |            | Sound .....  | 416        | Emergency spare wheel .....                                   | 488        |

## 4 Contents

---

|   |            |
|---|------------|
| <b>Technical data</b> .....   | <b>492</b> |
| Notes on technical data .....   | 492        |
| Vehicle electronics .....   | 492        |
| Vehicle identification plate, VIN and<br>engine number overview ..... | 494        |
| Operating fluids .....  | 496        |
| Vehicle data .....  | 501        |
| Trailer hitch .....   | 503        |
| <hr/>   |            |
| <b>Display messages and warning/indi-<br/>cator lamps</b> .....       | <b>505</b> |
| Display messages .....  | 505        |
| Warning and indicator lamps .....                                     | 553        |
| <hr/>   |            |
| <b>Index</b> .....  | <b>568</b> |

In this Operator's Manual, you will find the following symbols:

 **DANGER** Danger due to not observing the warning notices

Warning notices draw your attention to hazards that may endanger your health or life, or the health or life of others.

 Observe the warning notices.

 **ENVIRONMENTAL NOTE** Environmental damage due to failure to observe environmental notes

Environmental notes include information on environmentally responsible behavior or environmentally responsible disposal.

 Observe environmental notes.

 **NOTE** Damage to property due to failure to observe notes on material damage

Notes on material damage inform you of risks which may lead to your vehicle being damaged.

 Observe notes on material damage.

 Useful instructions or further information that could be helpful to you.

 Instruction

(→ page) Further information on a topic

**Display** Information on the multifunction display/media display



Highest menu level, which is to be selected in the multimedia system



Corresponding submenus, which are to be selected in the multimedia system

\*

Marks a cause

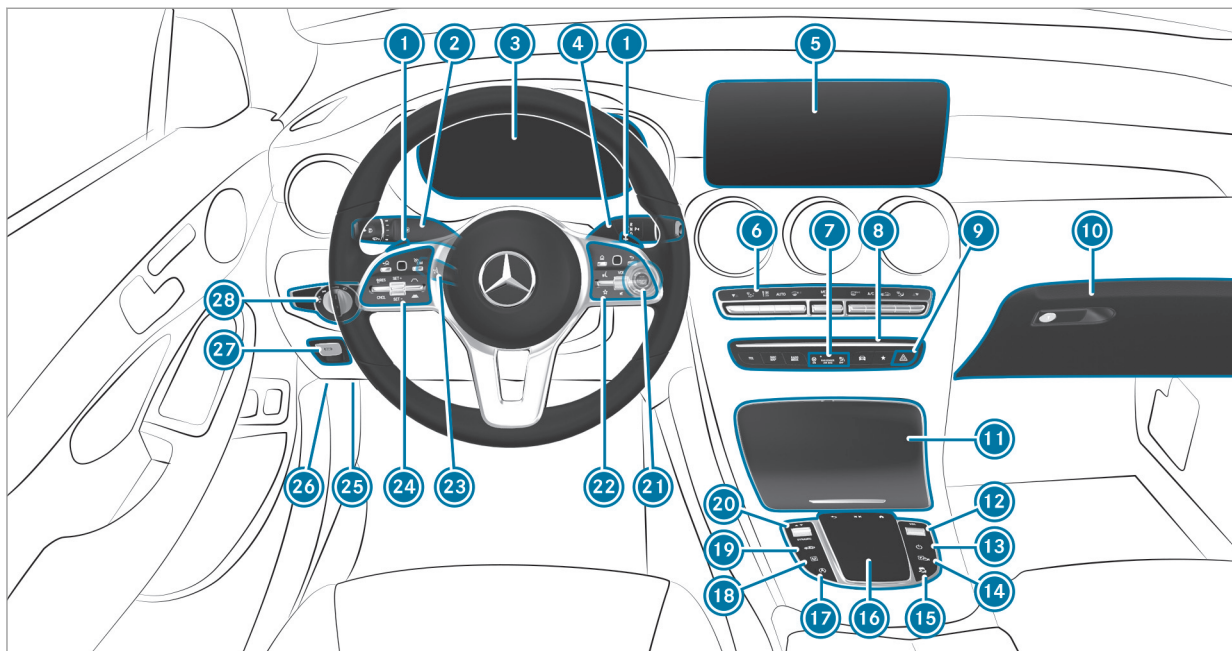

Left-hand drive vehicles



|   |  |   |     |   |   |   |     |
|---|--|---|-----|---|---|---|-----|
| ① | Steering wheel gearshift paddles             | → | 169 | ⑩ | Glove box   | → | 108 |
| ② | Combination switch                           | → | 131 | ⑪ | Stowage compartment   | → | 108 |
| ③ | Instrument Display                           | → | 252 | ⑫ | Control knob for volume and switching sound on/off            | → | 284 |
| ④ | DIRECT SELECT lever                          | → | 167 | ⑬ | Switches the MBUX multimedia system on/off                    | → | 284 |
| ⑤ | Media display                                | → | 284 | ⑭ | Active Parking Assist   | → | 234 |
| ⑥ | Climate control systems                      | → | 146 | ⑮ | ESP®  | → | 186 |
| ⑦ | PASSENGER AIR BAG indicator lamp             | → | 45  | ⑯ | Touchpad  | → | 287 |
| ⑧ | Control panel for the MBUX multimedia system | → | 284 | ⑰ | ECO start/stop function                                       | → | 164 |
| ⑨ | Hazard warning lights                        | → | 132 | ⑱ | Manual gearshifting   | → | 169 |
|   |  |   |     | ⑲ | Sets the vehicle level  | → | 216 |
|   |  |   |     | ⑳ | DYNAMIC SELECT switch   | → | 166 |
|   |  |   |     | ㉑ | Start/stop button   | → | 153 |
|   |  |   |     | ㉒ | Control panel for the MBUX multimedia system (steering wheel) | → | 253 |
|   |  |   |     | ㉓ | Adjusts the steering wheel electrically                       | → | 103 |
|   |  |   |     |   | Switches the steering wheel heater on/off                     | → | 103 |
|   |  |   |     | ㉔ | Control panel for:  |   |     |
|   |  |   |     |   | On-board computer   | → | 253 |
|   |  |   |     |   | Cruise control  | → | 198 |
|   |  |   |     |   | Active Distance Assist DISTRONIC                              | → | 203 |
|   |  |   |     | ㉕ | Diagnostics connection  | → | 26  |
|   |  |   |     | ㉖ | Opens the hood  | → | 421 |

## 8 At a glance – Cockpit

---

27 Electric parking brake



180























28 Light switch



130









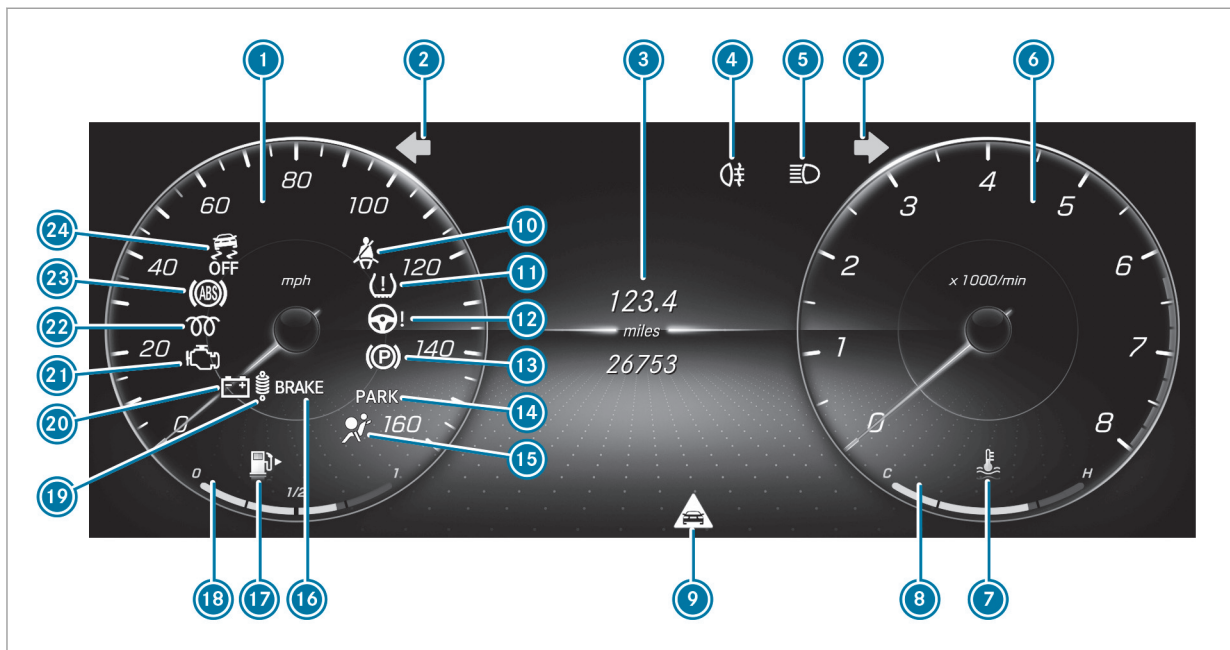



















|   |   |   |     |   |   |   |     |
|---|---|---|-----|---|---|---|-----|
| ① | Speedometer   | → | 252 | ⑫ | Coolant temperature display   | → | 252 |
| ② |  Distance warning                    | → | 562 | ⑬ |  Electric parking brake (yellow)                      | → | 560 |
| ③ |  Electric power steering malfunction | → | 556 | ⑭ |  ABS malfunction                                      | → | 563 |
| ④ |  Turn signal lights                  | → | 131 | ⑮ |  Restraint system                                     | → | 555 |
| ⑤ | Multifunction display   | → | 256 | ⑯ |  Seat belt not fastened                               | → | 555 |
| ⑥ | Tachometer  | → | 252 | ⑰ |  High beam  | → | 131 |
| ⑦ |  Check Engine                        | → | 557 | ⑱ |  Low beam   | → | 130 |
| ⑧ |  This indicator lamp has no function |   |     | ⑲ |  Fuel reserve with fuel filler cap location indicator | → | 557 |
| ⑨ | Electric parking brake applied (red)  | → | 560 | ⑳ | Fuel level indicator  |   |     |
|   |  USA only                            |   |     | ㉑ |  Parking lamps  | → | 130 |
|   |  Canada only                         |   |     | ㉒ |  Rear fog lamp  | → | 131 |
| ⑩ | Brakes (red)  | → | 560 | ㉓ |  Tire pressure monitor                                | → | 566 |
|   |  USA only                            |   |     | ㉔ |  ESP® OFF   | → | 563 |
|   |  Canada only                         |   |     | ㉕ |  ESP®   | → | 563 |
| ⑪ |  Coolant too hot/cold                | → | 557 |   |   |   |     |

12 At a glance – Indicator and warning lamps (Widescreen Cockpit)









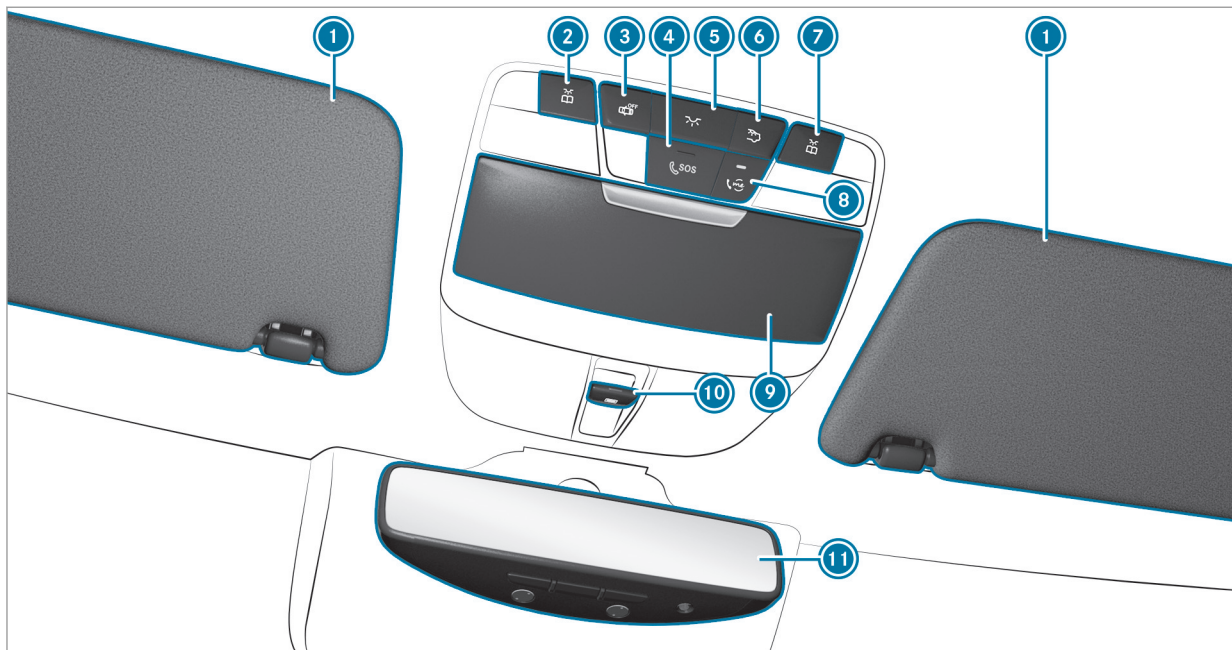

Widescreen Cockpit Instrument Display

|   |  |   |     |
|---|--|---|-----|
| ① | Speedometer  | → | 252 |
| ② |   Turn signal lights | → | 131 |
| ③ | Multifunction display  | → | 256 |
| ④ |  Rear fog lamp  | → | 131 |
| ⑤ |  High beam  | → | 131 |
|   |  Low beam   | → | 130 |
|   |  Parking lamps  | → | 130 |
| ⑥ | Tachometer   | → | 252 |
| ⑦ |  Coolant too hot/cold   | → | 557 |
| ⑧ | Coolant temperature display  | → | 252 |
| ⑨ |  Distance warning   | → | 562 |
| ⑩ |  Seat belt not fastened   | → | 555 |
| ⑪ |  Tire pressure monitor  | → | 566 |
| ⑫ |  Electric power steering malfunction  | → | 556 |
| ⑬ |  Electric parking brake (yellow)  | → | 560 |
| ⑭ | Electric parking brake applied (red)   | → | 560 |
|   |  USA only  |   |     |
|   |  Canada only   |   |     |
| ⑮ |  Restraint system  | → | 555 |
| ⑯ | Brakes (red)   | → | 560 |
|   |  USA only  |   |     |
|   |  Canada only   |   |     |
| ⑰ |  Fuel reserve with fuel filler cap location indicator  | → | 557 |
| ⑱ | Fuel level indicator   |   |     |
| ⑲ |  Suspension malfunction  | → | 562 |
| ⑳ |  Electrical malfunction  | → | 557 |
| ㉑ |  Check Engine  | → | 557 |
| ㉒ |  This indicator lamp has no function   |   |     |
| ㉓ |  ABS malfunction   | → | 563 |
| ㉔ |  ESP® OFF  | → | 563 |
|   |  ESP®  | → | 563 |

14 At a glance – Overhead control panel





|   |   |   |     |   |   |   |     |
|---|---|---|-----|---|---|---|-----|
| ① | Sun visors  | → | 143 | ⑦ |  Switches the right-hand reading lamp on/off                  | → | 135 |
| ② |  Switches the left-hand reading lamp on/off          | → | 135 | ⑧ |  me button  | → | 387 |
| ③ |  Switches automatic interior lighting control on/off | → | 135 | ⑨ | Eyeglasses compartment  | → | 108 |
| ④ |  SOS button  | → | 387 | ⑩ |  Opens/closes the panorama roof with power tilt/sliding panel | → | 83  |
| ⑤ |  Switches the front interior lighting on/off         | → | 135 |   |  Opens/closes the roller sunblinds                            | → | 83  |
| ⑥ |  Switches the rear interior lighting on/off          | → | 135 | ⑪ | Inside rearview mirror  | → | 141 |

16 At a glance – Door control panel and seat adjustment

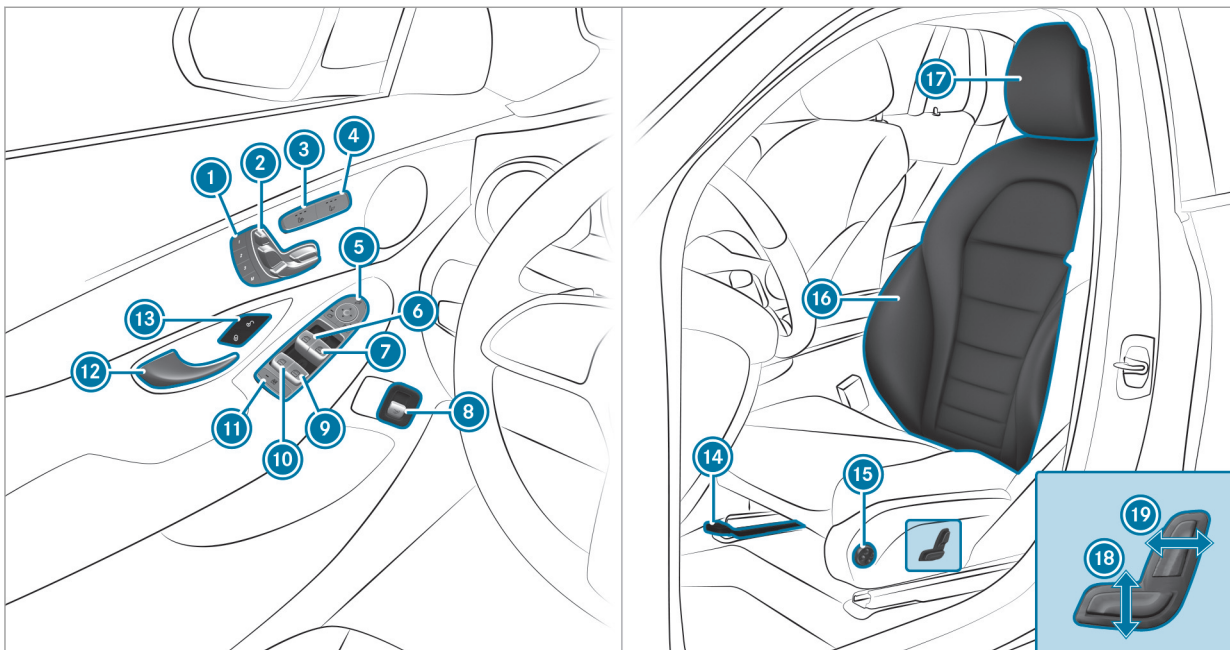

|   |   |     |   |   |    |
|---|---|-----|---|---|----|
| ① Operates the memory function            | → | 105 | ⑪ Child safety lock for the rear side windows | → | 63 |
| ② Adjusts the seats electrically          | → | 97  | ⑫ Opens the door                              | → | 70 |
| ③ Switches the seat heating on/off        | → | 101 | ⑬ Locks/unlocks the vehicle                   | → | 70 |
| ④ Switches the seat ventilation on/off    | → | 102 | ⑭ Sets the seat fore-and-aft position         | → | 95 |
| ⑤ Operates the outside mirrors            | → | 140 | ⑮ Adjusts the 4-way lumbar support            | → | 97 |
| ⑥ Opens/closes the left side window       | → | 79  | ⑯ Seat adjustment using the multimedia system | → | 99 |
| ⑦ Opens/closes the right side window      | → | 79  | ⑰ Adjusts the head restraints                 | → | 98 |
| ⑧ Opens/closes the tailgate               | → | 74  | ⑱ Adjusts the seat height                     | → | 95 |
| ⑨ Opens/closes the rear right side window | → | 79  | ⑲ Adjusts the seat backrest inclination       | → | 95 |
| ⑩ Opens/closes the rear left side window  | → | 79  |   |   |    |

18 At a glance – Emergencies and breakdowns

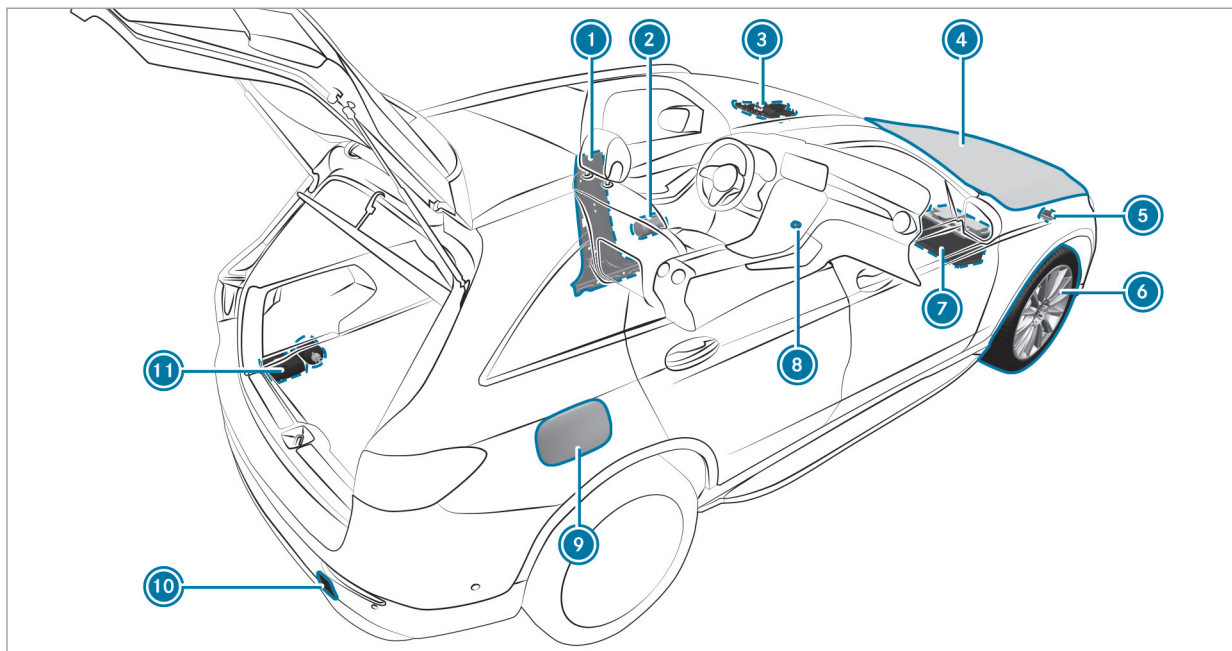

|   |   |     |
|---|---|-----|
| ① QR code for accessing the rescue card | → | 28  |
| ② Safety vests                          | → | 437 |
| ③ me button and SOS button              | → | 387 |
| ④ Checking and adding operating fluids  | → | 496 |
| ⑤ Tow-starting and towing away          | → | 449 |
| ⑥ Flat tire                             | → | 437 |
| ⑦ Starting assistance                   | → | 447 |

|   |   |     |
|---|---|-----|
| ⑧ Hazard warning lamps  | → | 132 |
| ⑨ Fuel filler flap with instruction labels for tire pressure, fuel type and QR code for accessing the rescue card | → | 172 |
| ⑩ Tow-starting and towing away  | → | 449 |
| ⑪ TIREFIT kit   | → | 439 |

### Calling up the Digital Operator's Manual

Multimedia system:

→ [Home] » Info » Operator's Manual  
» [Info]

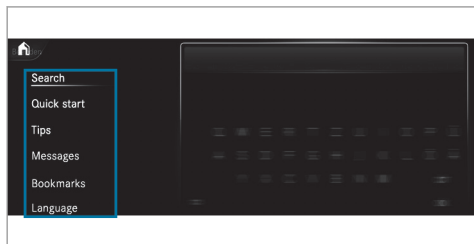

The Digital Operator's Manual describes the function and operation of:

- The vehicle
- The multimedia system

▶ Select one of the following menu items in the Digital Operator's Manual:

- **Search:** search for keywords in order to find quick answers to questions about the operation of the vehicle.
- **Quick start:** find the first steps towards setting up your vehicle.
- **Tips:** find information that prepares you for certain everyday situations with your vehicle.
- **Messages:** receive additional information about the messages in the instrument display.
- **Bookmarks:** gain access to your personally saved bookmarks.
- **Language:** select the language for the Digital Operator's Manual.

Some sections in the Digital Operator's Manual, e.g. warning notes, can be opened and closed.

#### Additional methods of calling up the Digital Operator's Manual:

**Direct access:** open the required content in the Digital Operator's Manual by pressing and holding an entry on the tab bar in the multimedia system:

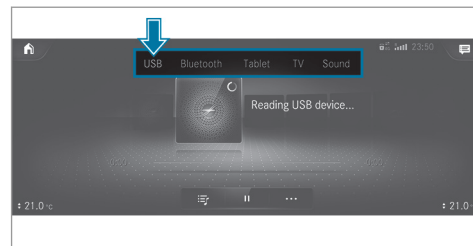

**Instrument Display:** call up brief information as display messages in the instrument cluster.

**Voice Control System:** call up via the voice control system

**Global search:** call up search results for contents of the Digital Operator's Manual in the home screen

For safety reasons, the Digital Operator's Manual is deactivated while driving.

**i** The Operator's Manual can also be found in the Mercedes-Benz Guides app in all common app stores.

## Protecting the environment

**Plug-in hybrid:** observe the notes in the Supplement. Otherwise, you may fail to recognize dangers.



**ENVIRONMENTAL NOTE** Environmental damage due to operating conditions and personal driving style

The pollutant emission of the vehicle is directly related to the way you operate the vehicle.

Operate your vehicle in an environmentally responsible manner to help protect the environment. Please observe the following recommendations on operating conditions and personal driving style.

### Operating conditions:

- ▶ Make sure that the tire pressure is correct.
- ▶ Do not carry any unnecessary weight (e.g. roof luggage racks once you no longer need them).

- ▶ Adhere to the service intervals. A regularly serviced vehicle will contribute to environmental protection.
- ▶ Always have maintenance work carried out at a qualified specialist workshop.

### Personal driving style:

- ▶ Do not depress the accelerator pedal when starting the engine.
- ▶ Do not warm up the engine while the vehicle is stationary.
- ▶ Drive carefully and maintain a suitable distance from the vehicle in front.
- ▶ Avoid frequent, sudden acceleration and braking.
- ▶ Change gear in good time and use each gear only up to  $\frac{2}{3}$  of its maximum engine speed.
- ▶ Switch off the engine in stationary traffic, e.g. by using the ECO start/stop function.
- ▶ Drive fuel-efficiently. Observe the ECO display for a fuel-efficient driving style.

## Environmental issues and recommendations:

It is recommended that you re-use or recycle materials instead of just disposing of them.

The relevant environmental guidelines and regulations serve to protect the environment and must be strictly observed.

## Genuine Mercedes-Benz parts



**ENVIRONMENTAL NOTE** Environmental damage caused by not using recycled/reconditioned components

Daimler AG offers recycled/reconditioned components and parts with the same quality as new parts. The same entitlement from the Limited Warranty is valid as for new parts.

- ▶ Use recycled/reconditioned components and parts from Daimler AG.

**!** **NOTE** Impairment of the operating efficiency of the restraint systems from installing accessory parts or from repairs or welding

Airbags and Emergency Tensioning Devices, as well as control units and sensors for the restraint systems, may be installed in the following areas of your vehicle:

- Doors
- Door pillars
- Door sills
- Seats
- Cockpit
- Instrument cluster
- Center console
- Lateral roof frame

- ▶ Do not install accessory parts such as audio systems in these areas.
- ▶ Do not carry out repairs or welding.

▶ Have aftermarket installation of accessories carried out at a qualified specialist workshop.

You could jeopardize the operating safety of your vehicle if you use parts, tires and wheels as well as accessories relevant to safety which have not been approved by Mercedes-Benz. Safety-relevant systems, e.g. the brake system, may malfunction. Only use Mercedes-Benz Genuine Parts or parts of equal quality. Only use tires, wheels and accessories that have been specifically approved for your vehicle model.

Mercedes-Benz Genuine Parts are subject to strict quality control. Each part has been specially developed, manufactured or selected for Mercedes-Benz vehicles and fine-tuned for them. Therefore, only Mercedes-Benz Genuine Parts should be used.

More than 300,000 different Mercedes-Benz Genuine Parts are available for Mercedes-Benz models.

All authorized Mercedes-Benz Centers maintain a supply of Mercedes-Benz Genuine Parts for

necessary service and repair work. In addition, strategically located parts delivery centers provide for quick and reliable parts service.

Always specify the vehicle identification number (VIN) (→ page 494) when ordering Mercedes-Benz Genuine Parts.

### Operator's Manual

This Operator's Manual describes all models and all standard and optional equipment available for your vehicle at the time of this Operator's Manual going to press. Country-specific differences are possible. Note that your vehicle may not be equipped with all features described. This is also the case for systems and functions relevant to safety. Therefore, the equipment on your vehicle may differ from that in the descriptions and illustrations.

The original purchase agreement for your vehicle contains a list of all of the systems in your vehicle.

Should you have any questions concerning equipment and operation, please consult an authorized Mercedes-Benz Center.



The Operator's Manual and Maintenance Booklet are important documents and should be kept in the vehicle.

### Service and vehicle operation

#### Vehicle operation outside the USA or Canada

When you are abroad with your vehicle, observe the following points:

- service points or replacement parts may not be available immediately.
- unleaded fuel may not be available for vehicles with a catalytic converter. Leaded fuel may cause damage to the catalytic converter.
- the fuel may have an extremely low octane number. Unsuitable fuel can cause engine damage.

Some Mercedes-Benz models are available in Europe through our European Delivery Program. For more information, please consult an authorized Mercedes-Benz service center, or write to one of the following address:

#### **in the USA:**

Mercedes-Benz USA, LLC  
European Delivery Department  
One Mercedes-Benz Drive  
Sandy Springs, GA 30328

#### **in Canada:**

Mercedes-Benz Canada, Inc.  
European Delivery Department  
98 Vanderhoof Avenue  
Toronto, Ontario M4G 4C9

#### Maintenance

Your customer advisor confirms the service in the service report.

#### Roadside Assistance

The Mercedes-Benz Roadside Assistance Program offers technical help in the case of a breakdown. Your calls to the toll-free Roadside Assistance Hotline are answered by our agents 24 hours a day, 365 days a year.

1-800-FOR-MERCEdes (1-800-367-6372) (USA)

1-800-387-0100 (Canada)

You can find further information in the Mercedes-Benz Roadside Assistance Program brochure (USA) or the "Roadside Assistance" section in the Service and Warranty booklet (Canada). You will find both in the vehicle document wallet.

#### Change of address or change of ownership

In the event of a change of address, please send us the "Notification of address change" in the Service and Guarantee booklet or simply call the Mercedes-Benz Customer Assistance Center (USA) on the hotline number 1-800-FOR-MERCEdes (1-800-367-6372) or Customer Service (Canada) on 1-800-387-0100. We can then reach you in a timely fashion, if necessary.

If you sell your Mercedes, please leave all literature in the vehicle so that it is available to the next owner. If you have purchased a used vehicle, please send us the "Notice of Purchase of Used Car" in the Service and Guarantee booklet or simply call the Mercedes-Benz Customer

Assistance Center (USA) at the hotline number 1-800-FOR-MERCEdes (1-800-367-6372) or Customer Service (Canada) at 1-800-387-0100.

### Possible danger due to substances hazardous to health

In compliance with Proposition 65 ("Prop65"), the following detachable label has been added to each vehicle sold in California:



## WARNING



Operating, servicing and maintaining a passenger vehicle, pickup truck, van or off-road motor vehicle can expose you to chemicals including engine exhaust, carbon monoxide, phthalates, and lead, which are known to the State of California to cause cancer and birth defects or other reproductive harm. To minimize exposure, avoid breathing exhaust, do not idle the engine except as necessary, service your vehicle in a well-ventilated area and wear gloves or wash your hands frequently when servicing your vehicle. For more information go to [www.P65Warnings.ca.gov/passenger-vehicle](http://www.P65Warnings.ca.gov/passenger-vehicle)

A 000 817 82 02

### Operating safety

**Plug-in hybrid:** observe the notes in the Supplement. Otherwise, you may fail to recognize dangers.

**⚠ WARNING** Risk of accident due to malfunctions or system failures

If you do not have the prescribed service/maintenance work or any required repairs carried out, this could result in malfunctions or system failures.

- ▶ Always have the prescribed service/maintenance work as well any required repairs carried out at a qualified specialist workshop.

**⚠ WARNING** Risk of accident and injury as a result of incorrect modifications to electronic component parts

Modification to electronic components, their software or wiring could impair their function and/or the function of other networked com-

ponent parts. In particular, systems relevant to safety could also be affected.

As a result, they may no longer function as intended and/or endanger the operating safety of the vehicle.

- ▶ Never tamper with the wiring and electronic component parts or their software.
- ▶ You should have all work on electrical and electronic components carried out at a qualified specialist workshop.

Observe the "On-board electronics" section in "Technical data".

**⚠ WARNING** Risk of fire due to flammable materials on hot parts of the exhaust system

Flammable material such as leaves, grass or twigs may ignite if they come into contact with hot parts of the exhaust system.

- ▶ When driving on unpaved roads or off-road, regularly check the vehicle underside.
- ▶ Remove trapped plants or other flammable material.
- ▶ If there is damage, consult a qualified specialist workshop immediately.

#### **!** NOTE Damage to the vehicle

In the following situations, in particular, there is a risk of damage to the vehicle:

- The vehicle becomes grounded, e.g. on a high curb or an unpaved road
- The vehicle is driven too fast over an obstacle, e.g. a curb, speed bump or pothole
- A heavy object strikes the underbody or chassis components

In situations such as this, the body, the underbody, chassis components, wheels or tires could be damaged without the damage being visible. Components damaged in this

way can unexpectedly fail or, in the case of an accident, may not absorb the loads that arise as intended.

If the underbody paneling is damaged, flammable materials such as leaves, grass or twigs can collect between the underbody and the underbody paneling. These materials may ignite if they come into contact with hot parts on the exhaust system.

- ▶ Have the vehicle checked and repaired immediately at a qualified specialist workshop.
- or
- ▶ If driving safety is impaired while continuing your journey, pull over and stop the vehicle immediately in accordance with the traffic conditions, and contact a qualified specialist workshop.

#### Declaration of conformity for wireless vehicle components

**USA:** "The wireless devices of this vehicle comply with Part 15 of the FCC Rules. Operation is

subject to the following two conditions: 1) These devices may not cause harmful interference, and 2) These devices must accept any interference received, including interference that may cause undesired operation. Changes or modifications not expressly approved by the party responsible for compliance could void the user's authority to operate the equipment."

**Canada:** "The wireless devices of this vehicle comply with Industry Canada license-exempt RSS standard(s). Operation is subject to the following two conditions: (1) These devices may not cause interference, and (2) These devices must accept any interference, including interference that may cause undesired operation of the device."

**USA:** "Wireless charging system for mobile devices (model: WM12 Wireless Mobile Interface): this device complies with Part 18 of the FCC Rules."

The name and address of the responsible party is:

peiker acoustic GmbH  
Max-Planck-Str. 28-32

61381 Friedrichsdorf  
Germany

### Diagnosics connection

The diagnostics connection is only intended for the connection of diagnostic devices at a qualified specialist workshop.

**⚠ WARNING** Risk of accident due to connecting devices to the diagnostics connection

If you connect equipment to a diagnostics connection in the vehicle, it may affect the operation of vehicle systems.

As a result, the operating safety of the vehicle could be affected.

- ▶ Only connect equipment to a diagnostics connection in the vehicle which is approved for your vehicle by Mercedes-Benz.

**⚠ WARNING** Risk of accident due to objects in the driver's footwell

Objects in the driver's footwell may impede pedal travel or block a depressed pedal.

This jeopardizes the operating and road safety of the vehicle.

- ▶ Stow all objects in the vehicle securely so that they cannot get into the driver's footwell.
- ▶ Always install the floor mats securely and as prescribed in order to ensure that there is always sufficient room for the pedals.
- ▶ Do not use loose floor mats and do not place floor mats on top of one another.

**! NOTE** Battery discharging from using devices connected to the diagnostics connection

Using devices at the diagnostics connection drains the battery.

- ▶ Check the charge level of the battery.

- ▶ If the charge level is low, charge the battery, e.g. by driving a considerable distance.

Connecting equipment to the diagnostics connection can lead to emissions monitoring information being reset, for example. This may lead to the vehicle failing to meet the requirements of the next emissions inspection during the main inspection.

### Qualified specialist workshop

**Plug-in hybrid:** observe the notes in the Supplement. Otherwise, you may fail to recognize dangers.

An authorized Mercedes-Benz Center is a qualified specialist workshop. It has the necessary special skills, tools and qualifications to correctly carry out the work required on your vehicle. This particularly applies to safety-relevant works.

For the following, always have your vehicle checked at an authorized Mercedes-Benz Center:

- safety-relevant works
- service and maintenance work
- repair work
- modifications as well as installations and conversions
- work on electronic components

Mercedes-Benz recommends a Mercedes-Benz service center.

### Correct use of the vehicle

If you remove any warning stickers, you or others could fail to recognize certain dangers. Leave warning stickers in position.

Observe the following information in particular when driving your vehicle:

- the safety notes in this manual
- technical data for the vehicle
- traffic rules and regulations

- laws and safety standards pertaining to motor vehicles

### Problems with your vehicle

If you should experience a problem with your vehicle, particularly one that you believe may affect its safe operation, we urge you to contact an authorized Mercedes-Benz Center immediately to have the problem diagnosed and rectified. If the problem is not resolved to your satisfaction, please discuss the problem again with an authorized Mercedes-Benz Center or, if necessary, contact us at one of the following addresses:

#### In the USA:

Mercedes-Benz USA, LLC  
Customer Assistance Center  
One Mercedes-Benz Drive  
Sandy Springs, GA 30328

#### In Canada:

Mercedes-Benz Canada, Inc.  
Customer Relations Department

98 Vanderhoof Avenue  
Toronto, Ontario M4G 4C9

### Reporting safety defects

#### USA only:

The following text is published as required of manufacturers under Title 49, Code of U.S. Federal Regulations, Part 575 pursuant to the "National Traffic and Motor Vehicle Safety Act of 1966".

If you believe that your vehicle has a defect which could cause a crash or could cause injury or death, you should immediately inform the National Highway Traffic Safety Administration (NHTSA) in addition to notifying Mercedes-Benz USA, LLC.

If NHTSA receives similar complaints, it may open an investigation, and if it finds that a safety defect exists in a group of vehicles, it may order a recall and remedy campaign. However, NHTSA cannot become involved in individual problems between you, your dealer, or Mercedes-Benz USA, LLC.

To contact NHTSA, you may call the Vehicle Safety Hotline toll-free at 1-888-327-4236 (TTY: 1-800-424-9153) (inside the USA), go to <http://www.safercar.gov>; or write to: Administrator, NHTSA, 400 Seventh Street, SW., Washington, DC 20590, USA.

Further information on vehicle safety can be found at: <http://www.safercar.gov>

### Limited Warranty

**!** **NOTE** Damage to the vehicle arising from violation of these operating instructions.

Damage to the vehicle can arise from violation of these operating instructions.

This damage is not covered either by the Mercedes-Benz implied warranty or by the New- or Used-Vehicle Warranty.

- ▶ Follow the instructions in these operating instructions on proper operation of your vehicle as well as on possible vehicle damage.

### QR code for rescue card

The QR code is secured in the fuel filler flap and on the opposite side on the B-pillar. In the event of an accident, rescue services can use the QR code to quickly find the appropriate rescue card for your vehicle. The current rescue card contains the most important information about your vehicle in a compact form, e.g. the routing of the electric lines.

Further information can be obtained at <http://www.mercedes-benz.de/qrcode>.

### Data storage

#### Electronic control units

Electronic control units are installed in your vehicle. Some of these are necessary for the safe operation of your vehicle, while some assist you when driving (driver assistance systems). In addition, your vehicle provides comfort and entertainment functions, which are also made possible by electronic control units.

Electronic control units contain data memories which can temporarily or permanently store

technical information about the vehicle's operating state, component loads, maintenance requirements and technical events or malfunctions.

In general, this information documents the state of a component part, a module, a system or the surroundings such as:

- Operating status of system components (e.g. fill levels, battery status, tire pressure)
- Status messages concerning the vehicle or its individual components (e.g. number of wheel revolutions/speed, longitudinal acceleration, lateral acceleration, display of fastened seat belts)
- Malfunctions or faults in important system components (e.g. lights, brakes)
- Information on events leading to vehicle damage
- System reactions in special driving situations (e.g. airbag deployment, intervention of stability control systems)
- Ambient conditions (e.g. temperature, rain sensor)

In addition to providing the actual control unit function, this data assists the manufacturer in detecting and rectifying malfunctions and optimizing vehicle functions. The majority of this data is temporary and is only processed in the vehicle itself. Only a small portion of the data is stored in the event or fault memory.

When your vehicle is serviced, technical data from the vehicle can be read out by service network employees (e.g. workshops, manufacturers) or third parties (e.g. breakdown services). Services include repair services, maintenance processes, warranty claims and quality assurance measures, for example. The read out is performed via the legally prescribed port for the diagnostics connection in the vehicle. The respective service network locations or third parties collect, process and use the data. They document technical statuses of the vehicle, assist in finding malfunctions and improving quality and are transmitted to the manufacturer, if necessary. Furthermore, the manufacturer is subject to product liability. For this, the manufacturer requires technical data from vehicles.

Fault memories in the vehicle can be reset by a service outlet as part of repair or maintenance work.

Depending on the selected equipment, you can import data into vehicle convenience and information functions yourself.

This includes, for example:

- Multimedia data such as music, films or photos for playback in an integrated multimedia system
- Address book data for use in connection with an integrated hands-free system or an integrated navigation system
- Entered navigation destinations
- Data about the use of Internet services

This data can be saved locally in the vehicle or it is located on a device which you have connected to the vehicle (e.g. a smartphone, USB flash drive or MP3 player). If this data is stored in the vehicle, you can delete it at any time. This data is sent to third parties only at your request, particularly when you use online services in accordance with the settings that you have selected.

You can store or change convenience settings/individualization in the vehicle at any time.

Depending on the equipment, this includes, for example:

- Settings for the seat and steering wheel positions
- Suspension and climate control settings
- Customizations such as interior lighting

If your vehicle is accordingly equipped, you can connect your smartphone or another mobile end device to the vehicle. You can control this by means of the control elements integrated in the vehicle. Images and audio from the smartphone can be output via the multimedia system. Certain information is simultaneously transferred to your smartphone.

Depending on the type of integration, this can include:

- General vehicle data
- Position data

This allows you to use selected apps on your smartphone, such as navigation or music play-

back. There is no further interaction between the smartphone and the vehicle; in particular, vehicle data is not directly accessible. Which type of further data processing occurs is determined by the provider of the specific app used. Which settings you can make, if any, depends on the specific app and the operating system of your smartphone.

### Online services

---

#### Wireless network connection

If your vehicle has a wireless network connection, it enables data to be exchanged between your vehicle and additional systems. The wireless network connection is enabled via the vehicle's transmission and reception unit or via connected mobile end devices (e.g. smartphones). Online functions can be used via the wireless network connection. This includes online services and applications/apps provided by the manufacturer or other providers.

#### Manufacturer's services

Regarding online services of the manufacturer, the individual functions are described by the

manufacturer in a suitable place (e.g. Operator's Manual, website of the manufacturer) along with the relevant data protection information. Personal data may be used for the provision of online services. Data is exchanged via a secure connection, e.g. the manufacturer's designated IT systems. Personal data is collected, processed and used via the provision of services exclusively on the basis of legal permissions or with prior consent.

The services and functions (sometimes subject to a fee) can usually be activated or deactivated. In some cases, this also applies to the entire vehicle's data connection. This excludes, in particular, legally prescribed functions and services.

#### Third party services

If it is possible to use online services from other providers, these services are the responsibility of the provider in question and subject to that provider's data protection conditions and terms of use. The manufacturer has no influence on the content exchanged.

For this reason, please ask the service provider for information about the type, extent and pur-

pose of the collection and use of personal data when services are provided by third parties.

### MBUX multimedia system/Mercedes me connect

---

If the vehicle is equipped with the MBUX multimedia system or Mercedes me connect, additional data about the vehicle's operation, the use of the vehicle in certain situations, and the location of the vehicle may be compiled by the MBUX multimedia system or Mercedes me connect.

For additional information, please refer to the "MBUX multimedia system" section and/or the Mercedes me connect Terms and Conditions.

### Event data recorders

---

#### USA only:

This vehicle is equipped with an event data recorder (EDR). The main purpose of an EDR is to record, in certain crash or near crash-like situations, such as an airbag deployment or hitting a road obstacle, data that will assist in under-



standing how a vehicle's systems performed. The EDR is designed to record data related to vehicle dynamics and safety systems for a short period of time, typically 30 seconds or less. The EDR in this vehicle is designed to record such data as:

- How various systems in your vehicle were operating
- Whether or not the driver and front passenger seat belts were buckled/fastened
- How far (if at all) the driver was depressing the accelerator and/or brake pedal and
- How fast the vehicle was traveling

This data can help provide a better understanding of the circumstances in which accidents and injuries occur. NOTE: EDR data is recorded by your vehicle only if a non-trivial crash situation occurs; no data is recorded by the EDR under normal driving conditions and no personal data (e.g. name, gender, age and accident location) is recorded. However, other parties, such as law enforcement, could combine EDR data with the type of personally identifying data routinely acquired during a crash investigation.

To read data recorded by an EDR, special equipment is required, and access to the vehicle or the EDR is needed. In addition to the vehicle manufacturer, other parties that have the special equipment, such as law enforcement, can read the information by accessing the vehicle or the EDR.

EDR data may be used in civil and criminal matters as a tool in accident reconstruction, accident claims and vehicle safety. Since the Crash Data Retrieval (CDR) tool that is used to extract data from the EDR is commercially available, Mercedes-Benz USA, LLC ("MBUSA") expressly disclaims any and all liability arising from the extraction of this information by unauthorized Mercedes-Benz personnel.

MBUSA will not share EDR data with others without the consent of the vehicle owner or, if the vehicle is leased, without the consent of the lessee. Exceptions to this representation include responses to subpoenas by law enforcement; by federal, state or local government; in connection with or arising out of litigation involving MBUSA or its subsidiaries and affiliates; or, as required by law.

Warning: The EDR is a component of the Restraint System Module. Tampering with, altering, modifying or removing the EDR component may result in a malfunction of the Restraint System Module and other systems.

State laws or regulations regarding EDRs that conflict with federal regulation are pre-empted. This means that in the event of such conflict, the federal regulation governs. As of December 2016, 17 states have enacted laws relating to EDRs.

### Copyright

#### Free and open-source software

Information on license for free and open-source software used in your vehicle can be found on the data carrier in your vehicle document wallet and with updates on the following website:

<http://www.mercedes-benz.com/opensource>

### Registered trademarks

- Bluetooth® is a registered trademark of Bluetooth SIG Inc.
- DTS™ is a registered trademark of DTS, Inc.
- Dolby® and MLP™ are registered trademarks of DOLBY Laboratories.
- BabySmart™, ESP® and PRE-SAFE® are registered trademarks of Daimler AG.
- HomeLink® is a registered trademark of Johnson Controls.
- iPod® and iTunes® are registered trademarks of Apple Inc.
- Burmester® is a registered trademark of Burmester Audiosysteme GmbH.
- Microsoft® and Windows Media® are registered trademarks of Microsoft Corporation.
- SIRIUS® is a registered trademark of Sirius XM Radio Inc.
- HD Radio™ is a registered trademark of iBiquity Digital Corporation.
- Gracenote® is a registered trademark of Gracenote, Inc.
- ZAGATSurvey® and related brands are registered trademarks of ZagatSurvey, LLC.

## Restraint system

### Protection by the restraint system

The restraint system includes the following components:

- Seat belt system
- Airbags
- Child restraint system
- Child seat securing systems

The restraint system can help prevent the vehicle occupants from coming into contact with parts of the vehicle interior in the event of an accident. In the event of an accident, the restraint system can also reduce the forces to which the vehicle occupants are subjected.

A seat belt can only provide the best level of protection if it is worn correctly. Depending on the detected accident situation, Emergency Tensioning Devices and/or airbags supplement the protection offered by a correctly worn seat belt. Emergency Tensioning Devices and/or airbags are not deployed in every accident.

In order for the restraint system to provide the intended level of protection, each vehicle occupant must observe the following information:

- Fasten seat belts correctly.
- Sit in an almost upright seat position with their back against the seat backrest.
- Sit with their feet resting on the floor, if possible.
- Always secure persons under 5 ft (1.50 m) tall in an additional restraint system suitable for Mercedes-Benz vehicles.

However, no system available today can completely eliminate injuries and fatalities in every accident situation. In particular, the seat belt and airbag generally do not protect against objects penetrating the vehicle from the outside. It is also not possible to completely rule out the risk of injury caused by the airbag deploying.

### Reduced restraint system protection

**▲ WARNING** Risk of injury or death from modifications to the restraint system

The restraint system can no longer function correctly after alterations have been made.

The restraint system may then not protect the vehicle occupants as intended by failing in an accident or triggering unexpectedly, for example

- ▶ Never alter the parts of the restraint system.
- ▶ Never tamper with the wiring or any electronic component parts or their software.

If it is necessary to modify the vehicle to accommodate a person with disabilities, contact an authorized Mercedes-Benz Center for details.



USA only: for details, contact our Customer Assistance Center on 1-800-FOR-MERCEDES (1-800-367-6372).

### Restraint system functionality

When the ignition is switched on, a self-test is performed, during which the  restraint system warning lamp lights up. It goes out no later than a few seconds after the vehicle is started. The components of the restraint system are then functional.

### Malfunctioning restraint system

A malfunction has occurred in the restraint system if:

- The  restraint system warning lamp does not light up when the ignition is switched on
- The  restraint system warning lamp lights up continuously or repeatedly during a journey

**⚠ WARNING** Risk of injury due to malfunctions in the restraint system

If the restraint system is malfunctioning, restraint system components may be trig-

gered unintentionally or may not deploy as intended during an accident. This may affect the Emergency Tensioning Devices or airbags, for example.

- ▶ Have the restraint system checked and repaired immediately at a qualified specialist workshop.

### Function of the restraint system in an accident

How the restraint system works is determined by the severity of the impact detected and the type of accident anticipated:

- Frontal impact
- Rear impact
- Side impact
- Rollover

The activation thresholds for the components of the restraint system are determined based on the evaluation of the sensor values measured at various points in the vehicle. This process is pre-emptive in nature. The triggering/deployment of

the components of the restraint system must take place in good time at the start of the collision.

Factors which can only be seen and measured after a collision has occurred do not play a decisive role in the deployment of an airbag. Nor do they provide an indication of airbag deployment.

The vehicle may be deformed significantly without an airbag being deployed. This is the case if only parts which are relatively easily deformed are affected and the rate of vehicle deceleration is not high. Conversely, an airbag may be deployed even though the vehicle suffers only minor deformation. If very rigid vehicle parts such as longitudinal members are hit, for example, this may result in sufficiently high levels of vehicle deceleration.

**The components of the restraint system can be activated or deployed independently of each other:**

| Component                               | Detected deployment situation                      |
|---|--|
| Front Emergency Tensioning Devices      | Frontal impact, rear impact, side impact, rollover |
| Rear Emergency Tensioning Devices       | Frontal impact, rear impact, rollover              |
| Driver's airbag, front passenger airbag | Frontal impact                                     |
| Knee airbag                             | Frontal impact                                     |
| Side airbag                             | Side impact  |
| Window curtain airbag                   | Side impact, rollover, frontal impact              |

The front passenger airbag can only be deployed in an accident if the PASSENGER AIR BAG OFF indicator lamp is off. If the front passenger seat is occupied, make sure, both before and during

the journey, that the status of the front passenger airbag is correct (→ page 45).

**⚠ WARNING** Risk of burns from hot air bag components

The air bag parts are hot after an air bag has been deployed.

- ▶ Do not touch the air bag parts.
- ▶ Have a deployed air bag replaced at a qualified specialist workshop as soon as possible.

Mercedes-Benz recommends that you have the vehicle towed to a qualified specialist workshop after an accident. Take this into account, particularly if an Emergency Tensioning Device is triggered or an airbag deployed.

If the Emergency Tensioning Devices are triggered or an airbag is deployed, you will hear a bang, and a small amount of powder may also be released:

- The bang will not generally affect your hearing.

- In general, the powder released is not hazardous to health but may cause short-term breathing difficulties to persons suffering from asthma or other pulmonary conditions. Provided it is safe to do so, leave the vehicle immediately or open the window in order to prevent breathing difficulties.

Airbags and pyrotechnic Emergency Tensioning Devices contain perchlorate material, which may require special handling or environmental protection measures. National guidelines regarding waste disposal must be observed. In California, see <http://www.dtsc.ca.gov/HazardousWaste/Perchlorate/index.cfm>.

## Seat belts

### Protection provided by the seat belt

Always fasten your seat belt correctly before starting a journey. A seat belt can only provide the best level of protection if it is worn correctly.

**▲ WARNING** Risk of injury or death due to incorrectly fastened seat belt

If the seat belt is not worn correctly, it cannot perform its intended protective function. In addition, an incorrectly fastened seat belt can also cause injuries, for example, in the event of an accident or when braking or changing direction suddenly.

- ▶ Always ensure that all vehicle occupants have their seat belts fastened correctly and are sitting properly.

Always observe the instructions about the correct driver's seat position and adjusting the seats (→ page 94).

In order for the correctly worn seat belt to provide the intended level of protection, each vehicle occupant must observe the following information:

- The seat belt must not be twisted and must fit tightly and snugly across the body.

- The seat belt must be routed across the center of the shoulder and as low down across the hips as possible.
- The shoulder section of the seat belt should not touch your neck nor be routed under your arm or behind your back.
- Avoid wearing bulky clothing, e.g. a winter coat.
- Push the lap belt down as far as possible across your hips and pull tight with the shoulder section of the belt. Never route the lap belt across your abdomen.

Pregnant women must also take particular care with this.

- Never route the seat belt across sharp, pointed, abrasive or fragile objects.
- Only one person may use each seat belt at any one time. Infants and children must never travel sitting on the lap of a vehicle occupant.
- Never secure objects with a seat belt if the seat belt is being used by one of the vehicle's occupants. Always observe the instruc-

tions for loading the vehicle when securing objects, luggage or loads (→ page 106).

Also ensure that no objects, e.g. a cushion, are ever placed between a person and the seat.

The seat belts on the following seats are equipped with a special seatbelt retractor:

- Co-driver seat
- Rear seats

Activate or deactivate the special seatbelt retractor of the seat belt (→ page 55).

If children are traveling in the vehicle, be sure to observe the instructions and safety notes on "Children in the vehicle" (→ page 50).

### Limitations of the protection provided by the seat belt

#### **⚠ WARNING** Risk of injury or death due to incorrect seat position

The seat belt does not offer the intended level of protection if you have not moved the seat backrest to an almost vertical position.

When braking or in the event of an accident, you could slide underneath the seat belt and sustain abdominal or neck injuries, for example.

- ▶ Adjust the seat properly before beginning your journey.
- ▶ Always ensure that the seat backrest is in an almost vertical position and that the shoulder section of your seat belt is routed across the center of your shoulder.

#### **⚠ WARNING** Risk of injury or death when additional restraint systems are not used for persons with a smaller build

Persons under 5 ft (1.50 m) tall cannot wear the seat belt correctly without a suitable additional restraint system.

If the seat belt is not worn correctly, it cannot perform its intended protective function. In addition, an incorrectly fastened seat belt can also cause injuries, for example, in the event of an accident or when braking or changing direction suddenly.

- ▶ Always secure persons under 5 ft (1.50 m) tall in a suitable restraint system.

#### **⚠ WARNING** Risk of injury or death due to damaged or modified seat belts

Seat belts cannot provide protection in the following situations:

- The seat belt is damaged, has been modified, is extremely dirty, bleached or dyed

- The seat belt buckle is damaged or extremely dirty
- Modifications have been made to the Emergency Tensioning Device, seat belt anchorage or seat belt retractor

Seat belts may sustain non-visible damage in an accident, e.g. due to glass splinters.

Modified or damaged seat belts could tear or fail in the event of an accident, for example.

Modified Emergency Tensioning Devices may be deployed unintentionally or not function as intended.

- ▶ Never modify the seat belts, Emergency Tensioning Devices, seat belt anchorages or seat belt retractors.
- ▶ Make sure that the seat belts are not damaged, are not worn and are clean.
- ▶ Always have the seat belts checked immediately after an accident at a qualified specialist workshop.

Only use seat belts that are approved for your vehicle by Mercedes-Benz.

**⚠ WARNING** Risk of injury or death from deployed pyrotechnic Emergency Tensioning Devices

Pyrotechnic Emergency Tensioning Devices that have been deployed are no longer operational and are unable to perform their intended protective function.

- ▶ Therefore, have deployed pyrotechnic Emergency Tensioning Devices immediately replaced at a qualified specialist workshop.

Mercedes-Benz recommends that you have the vehicle towed to a qualified specialist workshop after an accident.

**! NOTE** Damage caused by trapping the seat belt

If an unused seat belt is not fully retracted, it may become trapped in the door or in the seat mechanism.

- ▶ Always ensure that an unused seat belt is fully retracted.

### Releasing the rear passenger compartment center seat belt

If the left-hand rear seat backrest is folded down and back up again, it may not be possible to pull out the rear passenger compartment center seat belt. The seat belt must be released.

- ▶ Pull the seat belt out approximately 1 in (25 mm) at the seat belt outlet on the seat backrest and then release it again. The seat belt is retracted and released.

### Fastening and adjusting the seat belts

If the seat belt is pulled quickly or sharply, the seat belt retractor locks. The seat belt strap cannot be pulled out any further.

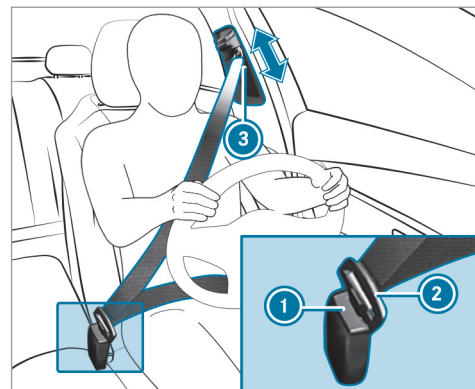

- ▶ Always engage seat belt tongue ② of the seat belt into seat belt buckle ① of the corresponding seat.
- ▶ Press and hold the seat belt outlet release and slide seat belt outlet ③ into the desired position.
- ▶ Let go of the seat belt outlet release and ensure that seat belt outlet ③ locks into position.



### Vehicles with automatic front passenger airbag shutoff:

**!** **NOTE** Deployment of the Emergency Tensioning Device and side air bag when the front passenger seat is unoccupied

If the seat belt tongue is engaged in the seat belt buckle of the unoccupied front passenger seat, the Emergency Tensioning Device and the side air bag may also deploy in the event of an accident along with other systems.

▶ Only one person should use each seat belt at any one time.

### Vehicles without automatic front passenger airbag shutoff:

**!** **NOTE** Deployment of the Emergency Tensioning Device when the front-passenger seat is unoccupied

If the seat belt tongue is engaged in the seat belt buckle of the unoccupied front-passenger seat, the Emergency Tensioning

Device may also deploy in the event of an accident along with other systems.

▶ Only one person should use each seat belt at any one time.

### Seat belt adjustment function

**Vehicles with PRE-SAFE®:** If the front seat belt is not pulled tight across your body, the seat belt adjustment may automatically apply a certain tightening force. Do not hold the seat belt tightly while it is adjusting.

You can activate and deactivate the seat belt adjustment function using the multimedia system (→ page 39).

### Releasing seat belts

▶ Press the release button in the seat belt buckle and guide the seat belt back with the seat belt tongue.

### Activating/deactivating seat belt adjustment via the multimedia system

Multimedia system:

→  ▶ Settings ▶ Vehicle

▶ Activate or deactivate **Belt Adjustment**.

### Seat belt warning function for the driver and front passenger

The  seat belt warning lamp in the Instrument Display is a reminder that all vehicle occupants must wear their seat belts correctly.

The  seat belt warning lamp lights up for six seconds every time the vehicle is started.

In addition, a warning tone may sound.

When the driver's and front passenger's doors are closed and the driver and front passenger have fastened their seat belts, the seat belt warning goes out.

In the following cases, the seat belt warning lights up during a journey if:

- The vehicle speed exceeds 15 mph (25 km/h) and the driver's or front passenger seat belt is not fastened.
- The driver or front passenger unfastens their seat belt while the vehicle is in motion.

## Airbags

### Overview of airbags

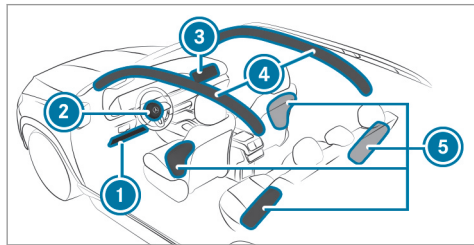

- ① Driver's knee airbag
- ② Driver's airbag

- ③ Front passenger airbag
- ④ Window curtain airbag
- ⑤ Side airbag

The installation location of an airbag can be recognized by the AIRBAG marking.

When enabled, an airbag can provide additional protection for the respective vehicle occupant.

### Potential protection from each airbag:

| AIRBAG                                  | Potential protection for: |
|---|---------------------------|
| Knee airbag                             | Thigh, knee and lower leg |
| Driver's airbag, front passenger airbag | Head and ribcage          |
| Window curtain airbag                   | Head                      |
| Side airbag                             | Ribcage and pelvis        |

**Mercedes-AMG vehicles:** observe the notes in the Supplement. Otherwise, you may not recognize dangers.

**⚠ WARNING** Risk of injury or fatal injuries if the front-passenger airbag is enabled

If the front-passenger front airbag is enabled, a child on the front-passenger seat may be struck by the front-passenger airbag during an accident.

NEVER use a rearward-facing child restraint system on a seat with an ENABLED FRONT AIRBAG, DEATH or SERIOUS INJURY to the CHILD can occur.

When installing a child restraint system to the front passenger seat, observe the vehicle-specific information (→ page 60). Also, always observe the notes on rearward-facing or forward-facing child restraint systems on the front passenger seat.

### Vehicles with automatic front passenger airbag shutoff:

The front passenger airbag can only be deployed in an accident if the PASSENGER AIR BAG OFF indicator lamp is off. If the front passenger seat is occupied, make sure, both before and during

the journey, that the status of the front passenger airbag is correct (→ page 45).

**!** **NOTE** Important points to remember if the front passenger seat is unoccupied

In an accident, the components of the restraint system may deploy unnecessarily on the front passenger side if:

- There are heavy objects on the front passenger seat.
- The seat belt tongue is engaged in the seat belt buckle of the front passenger seat and the front passenger seat is unoccupied.

- ▶ Stow objects in a suitable place.
- ▶ Only one person should use each seat belt at any one time.

Depending on the detected accident situation, the window curtain airbag on the front passenger side may deploy. The airbag is deployed regardless of whether the front passenger seat is occupied.

### Protection by the airbags

Depending on the accident situation, an airbag may supplement the protection offered by a correctly fastened seat belt.

**!** **WARNING** Risk of injury or death due to incorrect seat position

If you deviate from the correct seat position, the airbag cannot perform its intended protective function and deployment may even cause further injuries.

In order to avoid risks, each vehicle occupant must always make sure of the following:

- Fasten seat belts correctly. Pregnant women must take particular care to ensure that the lap belt never lies across the abdomen.
- Adopt the correct seat position and keep as far away as possible from the airbags.
- Observe the following information.

- ▶ Always make sure that there are no objects between the airbag and vehicle occupant.

To avoid the risks resulting from the deployment of an airbag, each vehicle occupant must observe the following information in particular:

- Before starting your journey, adjust your seat correctly; the driver's seat and front passenger seat should be moved as far back as possible.

When doing so, always observe the information on the correct driver's seat position (→ page 94).

- Only hold the steering wheel by the steering wheel rim. This allows the airbag to be fully deployed.
- Always lean against the seat backrest when the vehicle is in motion. Do not lean forwards or against the door or side window. You may otherwise be in the deployment area of the airbags.
- Always keep your feet on the floor. Do not put your feet on the cockpit, for example.

Your feet may otherwise be in the deployment area of the airbag.

- If children are traveling in the vehicle, observe the additional notes (→ page 50).
- Always stow and secure objects correctly.

Objects in the vehicle interior may prevent an airbag from functioning correctly. Each vehicle occupant must always make sure of the following in particular:

- There are no people, animals or objects between the vehicle occupants and an airbag.
- There are no objects between the seat, door and door pillar (B-pillar).
- There are no hard objects, e.g. coat hangers, hanging on the grab handles or coat hooks.
- There are no accessory parts, such as mobile navigation devices, mobile phones or cup holders, attached to the vehicle within the deployment area of an airbag, e.g. on the cockpit, on the door, on the side window or on the side wall trim.

In addition, no connecting cables, tensioning straps or retaining straps must be routed or attached to the vehicle within the deployment area of an airbag. Always comply with the accessory manufacturer's installation instructions and, in particular, the notes on suitable places for installation.

- There are no heavy, sharp-edged or fragile objects in the pockets of your clothing. Store such objects in a suitable place.

### Limited protection provided by airbags

**⚠ WARNING** Risk of injury due to modifications to the airbag cover

If you modify the cover of an airbag or affix objects such as stickers to it, the airbag may no longer function correctly.

- ▶ Never modify the cover of an airbag and do not affix objects to it.

The installation location of an airbag is identified by the AIRBAG symbol (→ page 40).

**⚠ WARNING** Risk of injury or death due to the use of unsuitable seat covers

Unsuitable seat covers can obstruct or prevent the deployment of air bags integrated into the seats.

Consequently, the air bags cannot protect vehicle occupants as they are designed to do. In addition, operation of the automatic front passenger air bag shutoff may be restricted.

- ▶ You should only use seat covers that have been approved for the corresponding seats by Mercedes-Benz.

**⚠ WARNING** Risk of injury due to malfunctions of the sensors in the door paneling

Sensors to control the airbags are located in the doors. Modifications or work not performed correctly to the doors or door paneling, as well as damaged doors, can lead to the function of the sensors being impaired. The airbags might therefore not function properly any more.

Consequently, the airbags cannot protect vehicle occupants as they are designed to do.

- ▶ Never modify the doors or parts of the doors.
- ▶ Always have work on the doors or door paneling carried out at a qualified specialist workshop.

**⚠ WARNING** Risk of injury due to deployed airbag

A deployed airbag no longer has a protective function and cannot protect as intended in the event of an accident.

- ▶ Have the vehicle towed to a qualified specialist workshop in order to have the deployed airbag replaced.

Have deployed airbags replaced immediately.

### Status of the front passenger front airbag

#### **Function of the automatic front passenger airbag shutoff**

The automatic front passenger airbag shutoff is able to detect whether the front passenger seat is occupied by a person or a child restraint system. The front passenger airbag is enabled or disabled accordingly.

When installing a child restraint system on the front passenger seat, always make sure of the following:

- Ensure that the child restraint system is positioned correctly (→ page 49).
- Always observe the child restraint system manufacturer's installation instructions.
- Never place objects, e.g. cushions, under or behind the child restraint system.
- Fully retract the seat cushion length adjustment.
- The entire base of the child restraint system must always rest on the seat cushion of the front-passenger seat.

- The backrest of the forward-facing child restraint system must lie as flat as possible against the backrest of the front-passenger seat.
- The child restraint system must not touch the roof or be put under strain by the head restraints. Adjust the seat backrest inclination and the head restraint setting accordingly.

**⚠ WARNING** Risk of injury or death due to objects between the sitting surface and the child restraint system

Objects between the sitting surface and the child restraint system could affect the function of the automatic front passenger airbag shutoff.

This could result in the front passenger airbag not functioning as intended during an accident.

- ▶ Do not place any objects between the sitting surface and the child restraint system.

## 44 Occupant safety

- ▶ The entire base of the child restraint system must always rest on the sitting surface of the front passenger seat.
- ▶ The backrest of the forward-facing child restraint system must, as far as possible, be resting on the seat backrest of the front passenger seat.
- ▶ Always comply with the child restraint system manufacturer's installation instructions.

A person on the front passenger seat must observe the following information:

- Fasten seat belts correctly (→ page 35).
- Sit in an almost upright seat position with their back against the seat backrest.
- Sit with their feet resting on the floor, if possible.

The front passenger airbag may otherwise be disabled by mistake, for example in the following situations:

- The front passenger transfers their weight by supporting themselves on a vehicle armrest.

- The front passenger sits in such a way that their weight is raised from the sitting surface.

### **▲ WARNING** Risk of injury or death due to deactivated front passenger airbag

If the PASSENGER AIR BAG OFF indicator lamp is lit, the front passenger airbag is disabled. It will not be deployed in the event of an accident and cannot perform its intended protective function.

A person in the front passenger seat could then, for example, come into contact with the vehicle interior, especially if the person is sitting too close to the cockpit.

If the front passenger seat is occupied, always ensure that:

- The classification of the person in the front passenger seat is correct and the front passenger airbag is enabled or disabled in accordance with the person in the front passenger seat.

- The front passenger seat has been moved as far back as possible.
- The person is seated correctly.
- ▶ Ensure, both before and during the journey, that the status of the front passenger airbag is correct.

If the front passenger seat is occupied, the classification of the person or child restraint system on the front passenger seat takes place after the front passenger airbag shutoff self-test. The PASSENGER AIR BAG indicator lamps display the status of the front passenger airbag.

Always observe the notes on the function of the PASSENGER AIR BAG indicator lamps (→ page 45).

### Function of the PASSENGER AIR BAG indicator lamps

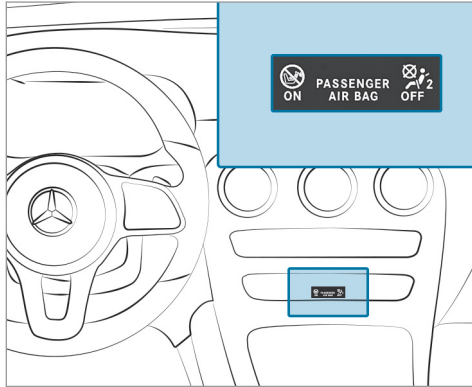

### Self-test of automatic front passenger airbag shutoff

When the ignition is switched on, a self-test is performed during which the two PASSENGER AIR BAG ON and OFF indicator lamps light up simultaneously.

The status of the front passenger airbag is displayed after the self-test:

- PASSENGER AIR BAG ON lights up for 60 seconds, subsequently both indicator lamps are off (PASSENGER AIR BAG ON and OFF): the front passenger airbag is able to deploy in the event of an accident.
- PASSENGER AIR BAG OFF lights up continuously: the front passenger airbag is disabled. It will then not be deployed in the event of an accident.

If the PASSENGER AIR BAG ON indicator lamp is off, only the PASSENGER AIR BAG OFF indicator lamp shows the status of the front passenger airbag. The PASSENGER AIR BAG OFF indicator lamp may be lit continuously or be off.

If the PASSENGER AIR BAG OFF indicator lamp and the  restraint system warning lamp light up simultaneously, the front passenger seat may not be used. Also in this case, do not install a child restraint system on the front passenger seat. Have automatic front passenger airbag shutoff checked and repaired immediately at a qualified specialist workshop.

### Status display

If the front passenger seat is occupied, ensure, both before and during the journey, that the status of the front passenger airbag is correct for the current situation.

**After installing a rearward-facing child restraint system on the front passenger seat:** PASSENGER AIR BAG OFF must be lit continuously.

**⚠ WARNING** Risk of injury or death from using a rearward-facing child restraint system when the front passenger front airbag is enabled

If you secure a child in a rearward-facing child restraint system on the front passenger seat and the PASSENGER AIR BAG OFF indicator lamp is off, the front passenger airbag can deploy in the event of an accident.

The child could be struck by the airbag.

Always ensure that the front passenger airbag is deactivated. The PASSENGER AIR BAG OFF indicator lamp must be lit.

NEVER use a rearward-facing child restraint system on a seat protected by an ENABLED FRONT AIRBAG in front of it, DEATH or SERIOUS INJURY to the CHILD can occur.

When installing a child restraint system on the front passenger seat, observe the vehicle-specific information (→ page 60).

Depending on the child restraint system and the stature of the child, the PASSENGER AIR BAG OFF indicator lamp may be off. In this case, do not install the rearward-facing child restraint system on the front passenger seat.

Instead, install the rearward-facing child restraint system on a suitable rear seat.

**After installing a forward-facing child restraint system on the front passenger seat:** depending on the child restraint system and the stature of the child, PASSENGER AIR BAG OFF may be lit continuously or be off. Always observe the following information.

**⚠ WARNING** Risk of injury or death due to incorrect positioning of the forward-facing child restraint system

If you secure a child in a forward-facing child restraint system on the front passenger seat and you position the front passenger seat too close to the cockpit, in the event of an accident, the child could:

- Come into contact with the vehicle interior if the PASSENGER AIR BAG OFF indicator lamp is lit, for example.
- Be struck by the air bag if the PASSENGER AIR BAG OFF indicator lamp is off.

▶ Always move the front passenger seat as far back as possible and fully retract the seat cushion length adjustment. Always make sure that the shoulder belt strap is correctly routed from the seat belt outlet on the vehicle to the shoulder belt guide on the child restraint system. The shoulder belt strap must be routed forwards and downwards from the vehicle belt outlet. If necessary,

adjust the seat belt outlet and the front passenger seat accordingly.

- ▶ Always observe the child restraint system manufacturer's installation instructions.

When installing a child restraint system on the front passenger seat, observe the vehicle-specific information (→ page 60).

**If a person is sitting on the front passenger seat:** PASSENGER AIR BAG OFF may be lit continuously or be off, depending on the person's stature.

A person on the front passenger seat must always observe the following information:

- If the front passenger seat is occupied by an adult or a person with a stature corresponding to that of an adult, the PASSENGER AIR BAG OFF indicator lamp must be off. This indicates that the front passenger airbag is enabled.

If the PASSENGER AIR BAG OFF indicator lamp is lit continuously, an adult or person



with a build corresponding to that of an adult should not use the front passenger seat.

Instead, they should use a rear seat.

- If the front passenger seat is occupied by a person of smaller stature (e.g. a teenager or small adult), the PASSENGER AIR BAG OFF indicator lamp either lights up continuously or remains off, depending on the result of the classification.
  - If the PASSENGER AIR BAG OFF indicator lamp is off: move the front passenger seat as far back as possible, or the person of smaller stature should use a rear seat.
  - If the PASSENGER AIR BAG OFF indicator lamp is lit continuously: the person of smaller stature should not use the front passenger seat.

**⚠ WARNING** Risk of injury or death when the PASSENGER AIR BAG OFF indicator lamp is lit

If the PASSENGER AIR BAG OFF indicator lamp remains lit after the system self-test, the front passenger air bag is deactivated. It will not be deployed in the event of an accident. In this case, the front passenger air bag cannot perform its intended protective function, e.g. when a person is seated in the front passenger seat.

That person could, for example, come into contact with the vehicle interior, especially if the person is sitting too close to the cockpit.

If the front passenger seat is occupied, always ensure that:

- The classification of the person in the front passenger seat is correct and the front passenger air bag is enabled or deactivated in accordance with the person in the front passenger seat.

- The person is seated properly with a correctly fastened seat belt.
- The front passenger seat has been moved as far back as possible.

Be sure to also observe the following further related subjects:

- Child restraint system on the front passenger seat (→ page 60).

#### PRE-SAFE® system

#### PRE-SAFE® (anticipatory occupant protection)

PRE-SAFE® is able to detect certain critical driving situations and implement pre-emptive measures to protect the vehicle occupants.

PRE-SAFE® can implement the following measures independently of each other:

- Tightening the seat belts on the driver's seat and front passenger seat.
- Closing the side windows.

- **Vehicles with sliding sunroof:** Closing the sliding sunroof.
- **Vehicles with memory function:** Moving the front passenger seat to a more favorable seat position.
- **Vehicles with multicontour seat:** Increasing the air pressure in the seat side bolsters of the seat backrest.
- **PRE-SAFE® Sound:** provided that the multimedia system is switched on, generates a brief noise signal to stimulate the innate protective mechanism of a person's hearing.

**!** **NOTE** Damage caused by objects in the footwell or behind the seat

The automatic adjustment of the seat position may result in damage to the seat and/or the object.

- ▶ Stow objects in a suitable place.

### Reversing the PRE-SAFE® system measures

If an accident did not occur, the pre-emptive measures that were taken are reversed.

You will need to perform certain settings yourself.

- ▶ If the seat belt pre-tensioning is not reduced, move the seat backrest back slightly. The locking mechanism releases.

### Function of PRE-SAFE® PLUS (anticipatory occupant protection plus)

PRE-SAFE® PLUS can detect certain impacts, particularly an imminent rear impact, and take pre-emptive measures to protect the vehicle occupants. These measures cannot necessarily prevent an imminent impact.

PRE-SAFE® PLUS can implement the following measures independently of each other:

- Tightening the seat belts on the driver's seat and front passenger seat.
- Increasing brake pressure when the vehicle is stationary. This brake application is can-

celed automatically when the vehicle pulls away.

If an accident did not occur, the pre-emptive measures that were taken are reversed.

### **System limits**

The system will not initiate any action in the following situations:

- when backing up  
or
- when the vehicle is towing a trailer and there is a risk of a rear impact

The system will not initiate any braking application in the following situations:

- whilst driving  
or
- when entering or exiting a parking space while using Active Parking Assist

## Safely transporting children in the vehicle

### Always observe when children are traveling in the vehicle

- i Also strictly observe the safety notes for the specific situation. In this way you can recognize potential risks and avoid dangers if children are traveling in the vehicle (→ page 50).

#### Be diligent

Bear in mind that neglecting to secure a child in the child restraint system may have serious consequences. Always be diligent in securing a child carefully before every journey.

To improve protection for children younger than 12 years old or under 5 ft (1.50 m) in height, Mercedes-Benz recommends you observe the following information:

- Always secure the child in a child restraint system suitable for this Mercedes-Benz vehicle.
  - The child restraint system must be appropriate to the age, weight and size of the child.
- The vehicle seat must be suitable for installing a child restraint system.

Accident statistics show that children secured on the rear seats are generally safer than children secured on the front seats. For this reason, Mercedes-Benz strongly advises that you install a child restraint system on a rear seat.

#### Generic term "child restraint system"

The generic term child restraint system is used in this Operator's Manual. A child restraint system is, for example:

- a baby car seat
  - a rearward-facing child seat
  - a forward-facing child seat
  - a child booster seat with a backrest and seat belt guide
- Mercedes-Benz recommends using a child booster seat with a backrest.

The child restraint system must be appropriate to the age, weight and size of the child.

#### Observing laws and legal requirements

Always observe the legal requirements when using a child restraint system in the vehicle.

#### Observing standards for child restraint systems

All child restraint systems must meet the following standards:

- U.S. Federal Motor Vehicle Safety Standards 213 and 225
- Canadian Motor Vehicle Safety Standards 213 and 210.2

Confirmation that the child restraint system complies with the standards can be found on an instruction label on the child restraint system. This confirmation can also be found in the installation instructions that are included with the child restraint system.

## Detecting risks, avoiding danger

### Securing systems for child restraint systems in the vehicle

Only use the following securing systems for child restraint systems:

- the LATCH-type (ISOFIX) mounting brackets
- the vehicle's seat belt system
- the Top Tether anchorages

Installing a LATCH-type (ISOFIX) child restraint system is preferred.

Simply attaching to the securing rings on the vehicle can reduce the risk of installing the child restraint system incorrectly.

When securing a child with the integrated seat belt of the LATCH-type (ISOFIX) child restraint system, always comply with the permissible gross weight for the child and child restraint system (→ page 56).

A booster seat may be necessary to achieve proper seat belt positioning for children over 40 lbs (18 kg) in weight or until they reach a

height where a three-point seat belt can be installed properly without a booster seat.

Mercedes-Benz recommends a suitable child booster seat with a backrest and seat belt guide.

#### Advantage of a rearward-facing child restraint system

It is preferable to transport a baby or a small child in a suitable rearward-facing child restraint system. In this case, the child sits in the opposite direction to the direction of travel and faces backwards.

Babies and small children have comparatively weak neck muscles in relation to the size and weight of their head. The risk of injury to the cervical spine during an accident can be reduced in a rearward-facing child restraint system.

### Always secure a child restraint system correctly

**⚠ WARNING** Risk of injury or death caused by incorrect installation of the child restraint system

If the child restraint system is incorrectly installed on a suitable seating position, it cannot perform its intended protective function.

The child cannot be restrained in the event of an accident, heavy braking or a sudden change of direction.

- ▶ Always comply with the manufacturer's installation instructions for the child restraint system and its correct use.
- ▶ Make sure that the entire base of the child restraint system always rests on the sitting surface of the seat.
- ▶ Never place objects under or behind the child restraint system, e.g. cushions.

- ▶ Always use child restraint systems with the original cover designed for them.
- ▶ Always replace damaged covers with genuine covers.

**⚠ WARNING** Risk of injury or death from unsecured child restraint systems in the vehicle

If the child restraint system is not correctly installed or secured, it could release in the event of an accident, sudden braking or a sudden change in direction.

The child restraint system could be flung around and hit vehicle occupants.

- ▶ Always install child restraint systems correctly, even when not in use.
- ▶ Always comply with the child restraint system manufacturer's installation instructions.

- Always observe the child restraint system manufacturer's installation and operating

instructions as well as the vehicle-specific information:

- Install the LATCH-type (ISOFIX) child restraint system on the rear seat (→ page 56).
- Secure the child restraint system with the seat belt on the rear seat (→ page 59).
- Secure the child restraint system with the seat belt on the front passenger seat (→ page 61). Observe the specific instructions for the rearward-facing and forward-facing child restraint systems (→ page 60).

If the front passenger seat is occupied, ensure, both before and during the journey, that the status of the front passenger airbag is correct for the current situation (→ page 45).

- Observe the warning labels in the vehicle interior and on the child restraint system.
- Also secure Top Tether if present.

**Do not modify the child restraint system**

**⚠ WARNING** Risk of injury due to modifications to the child restraint system

The child restraint system may no longer function as it is supposed to if you make modifications or attach objects to it, e.g. toys or unsuitable accessories. This poses an increased risk of injury!

Never modify the child restraint system. Only attach accessories which the manufacturer of the child restraint system has authorized especially for this child restraint system.

**Only use child restraint systems which are in proper working condition**

**⚠ WARNING** Risk of injury or death caused by the use of damaged child restraint systems

Child restraint systems or their retaining systems that have been subjected to a load in an accident may then not be able to perform their intended protective function.

The child cannot be restrained in the event of an accident, heavy braking or a sudden change of direction.

- ▶ Always replace child restraint systems immediately that have been damaged or involved in an accident.
- ▶ Have the securing systems for the child restraint systems checked at a qualified specialist workshop before installing a child restraint system again.

### Avoid direct sunlight

**⚠ WARNING** Risk of burns when the child seat is exposed to direct sunlight

If the child restraint system is exposed to direct sunlight or heat, parts could heat up.

Children could suffer burns from these parts, particularly on metallic parts of the child restraint system.

- ▶ Always make sure that the child restraint system is not exposed to direct sunlight.

- ▶ Protect it with a blanket, for example.
- ▶ If the child restraint system has been exposed to direct sunlight, allow it to cool before securing a child into it.
- ▶ Never leave children unattended in the vehicle.

### Observe when stopping or parking

**⚠ WARNING** Risk of accident and injury due to children left unattended in the vehicle

If children are left unattended in the vehicle, they could:

- Open doors, thereby endangering other persons or road users.
- Get out and be struck by oncoming traffic.
- Operate vehicle equipment and become trapped, for example.

In addition, the children could also set the vehicle in motion, for example by:

- Releasing the parking brake.
  - Changing the transmission position.
  - Starting the vehicle.
- ▶ Never leave children unattended in the vehicle.
  - ▶ When leaving the vehicle, always take the key with you and lock the vehicle.
  - ▶ Keep the vehicle key out of reach of children.

**⚠ WARNING** Risk of fatal injury due to exposure to extreme heat or cold in the vehicle



If people – particularly children – are exposed to extreme temperatures over an extended period of time, there is a risk of serious or even fatal injury.

- ▶ Never leave anyone – particularly children – unattended in the vehicle.

- ▶ Never leave animals in the vehicle unattended.

## Overview of suitable seats in the vehicle for installing a child restraint system

### Securing systems for child restraint systems

| Vehicle seat                |  |   |
|-----------------------------|--|---|
| <b>Left/right rear seat</b> | Preferred securing system:<br> LATCH-type (ISOFIX) child seat securing system<br><br> Also secure Top Tether if present<br>(→ page 58) | Alternative securing system: <ul style="list-style-type: none"> <li>• Vehicle seat belt</li> </ul>  |
| <b>Front passenger seat</b> | Securing system: <ul style="list-style-type: none"> <li>• Vehicle seat belt</li> </ul>   | Be sure to observe: <ul style="list-style-type: none"> <li>• If the front passenger seat is occupied, ensure, both before and during the journey, that the status of the front passenger airbag is correct for the current situation (→ page 45).</li> <li>• Notes on automatic front passenger airbag shut-off (→ page 43).</li> </ul> |



## Vehicle seat

### Center rear seat

Securing system:

- Vehicle seat belt



Also secure Top Tether if present  
(→ page 58)

### Activating/deactivating the seat belt's child special seat belt retractor

**⚠ WARNING** Risk of injury or death if a seat belt is unfastened while the vehicle is in motion

If the seat belt is released while the vehicle is in motion, the child restraint system is no longer correctly secured. The child seat safety feature is deactivated and the seat belt is drawn in a bit by the inertia reel.

It is therefore not possible to engage the seat belt again.

- ▶ Pull over and stop the vehicle safely as soon as possible, paying attention to road and traffic conditions.
- ▶ Activate the child seat safety feature again and correctly secure the child restraint system.

When enabled, the special seat belt retractor ensures that the seat belts of the front passenger seat and rear seats do not slacken once the child restraint system is secured.

The seat belts on the following seats are equipped with a special seat belt retractor:

- Front passenger seat
- Rear seats

- ▶ **To install a child restraint system:** when installing a child restraint system, always observe the manufacturer's installation and operating instructions as well as the information in this Operator's Manual.
- ▶ Pull the seat belt smoothly from the seat belt outlet.
- ▶ Engage the seat belt tongue in the seat belt buckle.
- ▶ **To activate the special seat belt retractor:** pull the seat belt out fully and let the inertia reel retract it again. When the special seat belt retractor is activated, you should hear a ratcheting sound.
- ▶ Push the child restraint system down until the seat belt sits tightly.

- ▶ **To deactivate the special seat belt retractor:** press the release button of the seat belt buckle.
- ▶ Hold the seat belt tongue and guide back to the seat belt outlet.

### Installing the LATCH-type (ISOFIX) child restraint system on the rear seat

#### Installing a LATCH-type (ISOFIX) child restraint system on the rear seat

**⚠ WARNING** Risk of injury if the rear bench seat/rear seat and seat backrest are not engaged

If the rear bench seat/rear seat and seat backrest are not engaged they could fold forwards, e.g. when braking suddenly or in the event of an accident.

- If this is the case, the vehicle occupant would be forced into the seat belt by the rear bench seat/rear seat or by the seat backrest. The seat belt cannot protect as

intended and could result in additional injury.

- Objects or loads in the trunk/cargo compartment cannot be restrained by the seat backrest.
- ▶ Make sure that the seat backrest and the rear bench seat/rear seat are engaged before every trip.

If the left and right seat backrests are not engaged and locked in place, this will be shown on the multifunction display on the instrument cluster.

If the center seat backrest is not engaged and locked in place, the red lock verification indicator will be visible.

**⚠ WARNING** Risk of injury or death if the permissible gross mass of the child and child restraint system is exceeded

For LATCH-type (ISOFIX) child restraint systems in which the child is secured using the integrated seat belt in the child restraint sys-

tem, the permissible gross mass of the child and child restraint system is 73 lb (33 kg).

If the child and the child restraint system together weigh more than 73 lb (33 kg), the LATCH-type (ISOFIX) child restraint system with integrated seat belt does not offer sufficient protection. An excessive load may be placed on the LATCH-type (ISOFIX) child seat attachments and the child may not be restrained in the event of an accident, for example.

- ▶ If the child and the child restraint system together weigh more than 73 lb (33 kg), use only a LATCH-type (ISOFIX) child restraint system that secures the child with the vehicle seat belt.
- ▶ Also secure the child restraint system with the Top Tether belt, if available.

Always comply with the information about the mass of the child restraint system:

- In the manufacturer's installation and operating instructions for the child restraint system used

- On a label on the child restraint system, if present

Regularly check that the permissible gross mass of the child and child restraint system is still complied with.

When installing a child restraint system, observe the following:

- ✓ Always observe the correct use of the seats and consider their suitability for attaching a child restraint system.
- ✓ Always comply with the manufacturer's installation and operating instructions for the child restraint system used.
- ✓ Make sure that the child's feet do not come into contact with the front seat. If necessary, move the front seat forward slightly.
- 🚗 When installing a LATCH-type (ISOFIX) child restraint system, also observe the following:
  - ✓ **When using a Group 0/0+ baby car seat and a Group I rearward-facing child restraint system on a rear seat:** adjust

the front seat so that the seat does not touch the child restraint system.

- ✓ **When using a Group I forward-facing child restraint system:** the backrest of the child restraint system must, as far as possible, lie flat against the backrest of the vehicle seat.
- ✓ For certain child restraint systems in weight group II or III, there may be restrictions on the maximum size setting, e.g. due to possible contact with the roof.
- ✓ The child restraint system must not be tensioned between the roof and the seat cushion and/or be installed facing the wrong direction. Where possible, adjust the seat cushion inclination accordingly.
- ✓ The child restraint system must not be put under strain by the head restraints. Adjust the head restraints accordingly.

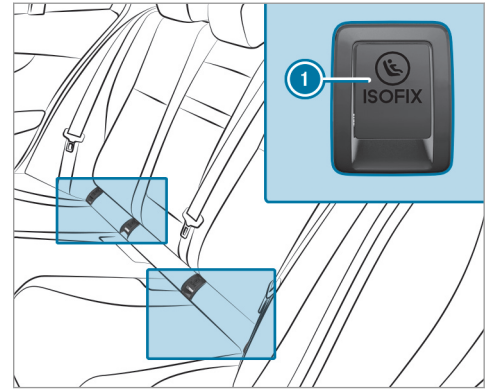

① LATCH-type (ISOFIX) mounting bracket

Before every journey, make sure that the LATCH-type (ISOFIX) child restraint system is engaged correctly in both mounting brackets in the vehicle.

**NOTE** Be careful not to damage the seat belt for the center seat when installing the child restraint system

- ▶ Make sure that the seat belt is not trapped.

- ▶ Attach the LATCH-type (ISOFIX) child restraint system to both mounting brackets in the vehicle.

### Securing Top Tether

**WARNING** Risk of injury or death if the rear seat backrests are not locked after installing Top Tether belts

If the rear seat backrests are not locked, they could fold forwards in the event of an accident or during braking or sudden changes of direction.

As a result, child restraint systems cannot perform their intended protective function. Rear seat backrests that are not locked can

also cause additional injuries, e.g. in the event of an accident.

- ▶ Always lock rear seat backrests after installing Top Tether belts.
- ▶ Observe the lock verification indicator.

If the left and right seat backrests are not engaged and locked in place, this will be shown on the multifunction display on the instrument cluster.

If the center seat backrest is not engaged and locked in place, the red lock verification indicator will be visible.



If the child restraint system is equipped with a Top Tether belt:

The risk of injury can be reduced by a Top Tether. The Top Tether belt facilitates an additional connection between the child restraint system attached with LATCH-type (ISOFIX) and the vehicle.

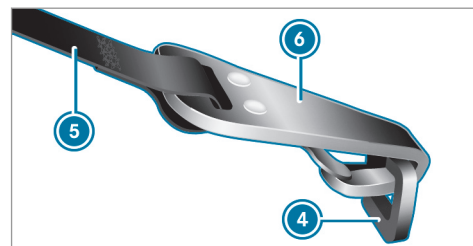
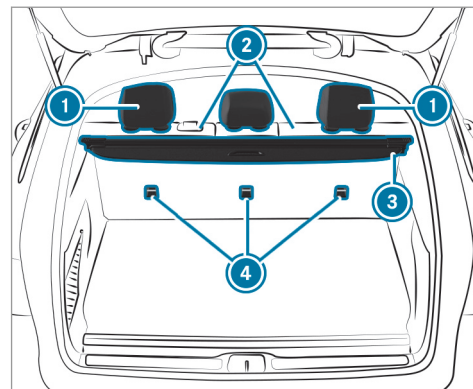

- ▶ If necessary, slide head restraint ① upwards (→ page 99).
- ▶ Install the LATCH-type (ISOFIX) child restraint system with Top Tether. Comply with the child restraint system manufacturer's installation instructions when doing so.
- ▶ Guide Top Tether belt ⑤ under head restraint ① between the two head restraint bars.
- ▶ Guide Top Tether belt ⑤ downwards between cargo compartment cover ③ and seat backrest ②.
- ▶ Hook Top Tether hook ⑥ of Top Tether belt ⑤ into Top Tether anchorage ④ without twisting.
- ▶ Tension Top Tether belt ⑤. Comply with the child restraint system manufacturer's installation instructions when doing so.
- ▶ If necessary, slide head restraint ① downwards (→ page 99). Make sure that you do not interfere with the correct routing of Top Tether belt ⑤.

### Securing the child restraint system with the seat belt

#### Securing the child restraint system with the seat belt on the rear seat

**⚠ WARNING** Risk of injury if the rear bench seat/rear seat and seat backrest are not engaged

If the rear bench seat/rear seat and seat backrest are not engaged they could fold forwards, e.g. when braking suddenly or in the event of an accident.

- If this is the case, the vehicle occupant would be forced into the seat belt by the rear bench seat/rear seat or by the seat backrest. The seat belt cannot protect as intended and could result in additional injury.
- Objects or loads in the trunk/cargo compartment cannot be restrained by the seat backrest.

- ▶ Make sure that the seat backrest and the rear bench seat/rear seat are engaged before every trip.

If the left and right seat backrests are not engaged and locked in place, this will be shown on the multifunction display on the instrument cluster.

If the center seat backrest is not engaged and locked in place, the red lock verification indicator will be visible.

When installing a belt-secured child restraint system, observe the following:

- Always comply with the manufacturer's installation and operating instructions for the child restraint system used.
- When using a category 0/0+ baby car seat and a category I rearward-facing child restraint system on a rear seat:** adjust the front seat so that the seat does not touch the child restraint system.
- The backrest of the forward-facing child restraint system must, as far as possible, be

resting on the seat backrest of the rear seat.

- ✓ For certain child restraint systems in weight category II or III, there may be restrictions on the maximum size setting, e.g. due to possible contact with the roof.
- ✓ The child restraint system must not be tensioned between the roof and the seat cushion and/or be installed facing the wrong direction. Where possible, adjust the seat cushion inclination accordingly.
- ✓ The child restraint system must not be put under strain by the head restraints. Adjust the head restraints accordingly.
- ✓ Make sure that the child's feet do not come into contact with the front seat. If necessary, move the front seat forward slightly.

The seat belts on the following seats are equipped with a child seat safety feature:

- Front passenger seat
- Rear seats

When enabled, the child seat safety feature ensures that the seat belts of the front

passenger seat and rear seats do not slacken once the child restraint system is secured (→ page 55).

- ▶ Install the child restraint system. The entire base of the child restraint system must always rest on the sitting surface of the rear seat.
- ▶ Always make sure that the shoulder belt strap is correctly routed from the seat belt outlet of the vehicle to the shoulder belt guide on the child restraint system. The shoulder belt strap must be routed forwards and downwards from the seat belt outlet.

### Notes on rearward-facing and forward-facing child restraint systems on the front passenger seat

**⚠ WARNING** Risk of injury or death from using a rearward-facing child restraint system when the front passenger front airbag is enabled

If you secure a child in a rearward-facing child restraint system on the front passenger seat and the PASSENGER AIR BAG OFF indicator lamp is off, the front passenger airbag can deploy in the event of an accident.

The child could be struck by the airbag.

Always ensure that the front passenger airbag is deactivated. The PASSENGER AIR BAG OFF indicator lamp must be lit.

NEVER use a rearward-facing child restraint system on a seat protected by an ENABLED FRONT AIRBAG in front of it, DEATH or SERIOUS INJURY to the CHILD can occur.

Observe the specific instructions for the rearward-facing and forward-facing child restraint systems (→ page 61).

Always observe the status of the front passenger airbag on the PASSENGER AIR BAG OFF indicator lamp:

- When using a rearward-facing child restraint system on the front passenger seat, the front passenger airbag must always be disabled. This is only the case if the PASSENGER AIR BAG OFF indicator lamp is lit continuously (→ page 45).
- If the PASSENGER AIR BAG OFF indicator lamp is off, the front passenger airbag is enabled. The front passenger airbag may deploy during an accident.

### Securing the child restraint system with the seat belt on the front passenger seat

When installing a belt-secured child restraint system on the front passenger seat, always observe the following:

- ☑ Observe the child restraint system manufacturer's installation and operating instructions.
  - ☑ When using a forward-facing child restraint system in category I: remove the head restraint from the respective seat, if possible.
- After the child restraint system has been removed, replace the head restraints immediately and adjust them correctly.
- ☑ The backrest of the forward-facing child restraint system must, as far as possible, be resting on the seat backrest of the front passenger seat.
  - ☑ For certain child restraint systems in weight category II or III, there may be restrictions on the maximum size setting, e.g. due to possible contact with the roof.

- ☑ The child restraint system must not be tensioned between the roof and the seat cushion and/or be installed facing the wrong direction.
- ☑ The child restraint system must not be put under strain by the head restraints. Adjust the head restraints accordingly.
- ☑ Never place objects under or behind the child restraint system, e.g. cushions.

The seat belt on the front passenger side is equipped with a special seat belt retractor.

When enabled, the special seat belt retractor function ensures that the seat belt does not slacken once the child restraint system is secured (→ page 55).

- ▶ Set the front passenger seat as far back as possible and move the seat into the highest position if possible.
- ▶ Fully retract the seat cushion length adjustment.
- ▶ Adjust the seat cushion inclination so that the front edge of the seat cushion is in the

highest position and the rear edge of the seat cushion is in the lowest position.

- ▶ Set the seat backrest to the most vertical position possible.
- ▶ Install the child restraint system. The entire base of the child restraint system must always rest on the sitting surface of the front passenger seat.
- ▶ Always make sure that the shoulder belt strap is correctly routed from the seat belt outlet of the vehicle to the shoulder belt guide on the child restraint system. The shoulder belt strap must be routed forwards and downwards from the seat belt outlet.
- ▶ If necessary, adjust the seat belt outlet and the front passenger seat accordingly.

### Child safety locks

#### Activating/deactivating the child safety lock for the rear doors

**▲ WARNING** Risk of accident and injury due to children left unattended in the vehicle

If children are left unattended in the vehicle, they could:

- Open doors, thereby endangering other persons or road users.
- Get out and be struck by oncoming traffic.
- Operate vehicle equipment and become trapped, for example.

In addition, the children could also set the vehicle in motion, for example by:

- Releasing the parking brake.
- Changing the transmission position.
- Starting the vehicle.

- ▶ Never leave children unattended in the vehicle.
- ▶ When leaving the vehicle, always take the key with you and lock the vehicle.
- ▶ Keep the vehicle key out of reach of children.

**▲ WARNING** Risk of fatal injury due to exposure to extreme heat or cold in the vehicle

If people – particularly children – are exposed to extreme temperatures over an extended period of time, there is a risk of serious or even fatal injury.

- ▶ Never leave anyone – particularly children – unattended in the vehicle.
- ▶ Never leave animals in the vehicle unattended.



**⚠ WARNING** Risk of accident and injury due to children left unattended in the vehicle

If children are traveling in the vehicle, they could, in particular:

- Open doors, thereby endangering other persons or road users
  - Get out and be struck by oncoming traffic
  - Operate vehicle equipment and become trapped, for example
- ▶ Always activate the child safety locks installed if children are traveling in the vehicle.
- ▶ Never leave children unattended in the vehicle.
- ▶ When leaving the vehicle, always take the SmartKey with you and lock the vehicle.

There are child safety locks for the rear doors and the rear passenger compartment side windows.

The child safety lock on the rear doors secures each door separately. The doors can no longer be opened from the inside.

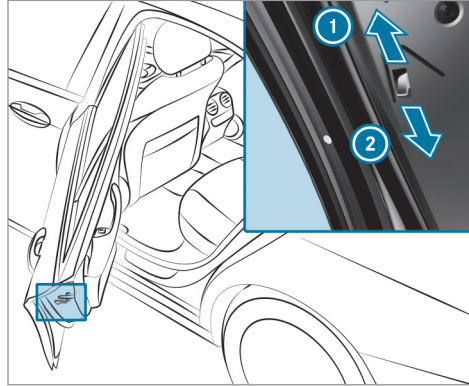

- ▶ Press the lever in direction ① (activate) or ② (deactivate).
- ▶ Make sure that the child safety locks are working properly.

**Activating/deactivating the child safety lock for the rear passenger compartment side windows**

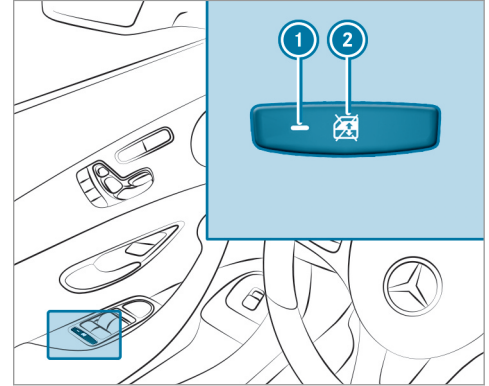

▶ **To activate/deactivate:** press button ②.

The rear passenger compartment side window can be opened or closed in the following cases:

- With indicator lamp ① lit: via the switch on the driver's door.
- With indicator lamp ① off: via the switch on the corresponding rear door or driver's door.

#### Notes on pets in the vehicle

**▲ WARNING** Risk of accident and injury due to animals left unsecured or unattended in the vehicle

If you leave animals in the vehicle unattended or unsecured, they could possibly press down buttons or switches.

Thereby an animal may:

- activate vehicle equipment and become trapped, for example

- switch systems on or off and endanger other road users

Unsecured animals may be thrown around in the vehicle in the event of an accident or sudden steering and braking maneuver and injure vehicle occupants in the process.

- ▶ Never leave animals in the vehicle unattended.
- ▶ Always correctly secure animals while driving, for example using a suitable animal carrier.

## SmartKey

### Overview of SmartKey functions

**⚠ WARNING** Risk of accident and injury due to children left unattended in the vehicle

If children are left unattended in the vehicle, they could:

- Open doors, thereby endangering other persons or road users.
- Get out and be struck by oncoming traffic.
- Operate vehicle equipment and become trapped, for example.

In addition, the children could also set the vehicle in motion, for example by:

- Releasing the parking brake.
  - Changing the transmission position.
  - Starting the vehicle.
- ▶ Never leave children unattended in the vehicle.

- ▶ When leaving the vehicle, always take the key with you and lock the vehicle.
- ▶ Keep the vehicle key out of reach of children.



**⚠ NOTE** Damage to the key caused by magnetic fields

- ▶ Keep the key away from strong magnetic fields.

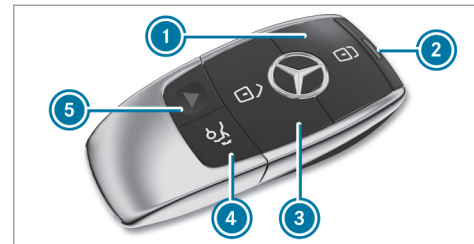
**i** The SmartKey may vary from the one shown in the diagram, depending on the vehicle equipment.



- ① Locks
- ② Battery check lamp
- ③ Unlocks
- ④ Opens/closes the tailgate
- ⑤ Panic alarm

**i** If battery check lamp ② does not light up after pressing the  or  button, the battery is discharged.

Replacing the SmartKey battery (→ page 67).

The SmartKey locks and unlocks the following components:

- The doors
- The fuel filler flap

- The tailgate

If the vehicle is not opened within approximately 40 seconds after unlocking, it locks again. Anti-theft protection is armed again.

Do not keep the SmartKey together with electronic devices or metal objects. This can affect the SmartKey's functionality.

### Activating/deactivating the acoustic locking verification signal

Multimedia system:

→  » Settings » Vehicle

- ▶ Activate or deactivate [Acoustic Lock](#).

### Activating/deactivating the panic alarm

Requirements:

- The ignition is switched off.

- ① The panic alarm function is only available in certain countries.





- ▶ **To activate:** press button ① for approximately one second. A visual and audible alarm is triggered.
  - ▶ **To deactivate:** briefly press button ① again.
- or
- ▶ Press the start/stop button on the cockpit (the SmartKey is inside the vehicle).

### Changing the unlocking settings

Possible unlocking functions of the SmartKey:

- Central unlocking
- Unlocking the driver's door and fuel filler flap

- ▶ **To switch between settings:** press the  and  buttons simultaneously for approximately six seconds until the battery check lamp flashes twice.

Options if the unlocking function for the driver's door and fuel filler flap has been selected:

- **To unlock the vehicle centrally:** press the  button twice.
- **Vehicles with KEYLESS-GO:** if you touch the inner surface of the door handle on the driver's door, only the driver's door and fuel filler flap are unlocked.

### Deactivating the SmartKey functions

If you do not use the vehicle or a SmartKey for an extended period of time, you can reduce the energy consumption of the respective SmartKey. To do so, deactivate the SmartKey functions.

- ▶ **To deactivate:** press the  button on the SmartKey twice in quick succession. The battery check lamp of the SmartKey flashes twice briefly and lights up once.

▶ **To activate:** press any button on the SmartKey.

❶ When the vehicle is started with the SmartKey in the marked space of the center console, the SmartKey functions are automatically activated (→ page 153).

### Removing/inserting the emergency key

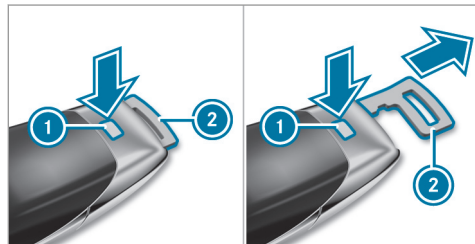

- ▶ **To remove:** press release knob ❶. Emergency key ❷ is pushed out slightly.
- ▶ Pull out emergency key ❷ until it engages in the intermediate position.

▶ Press release knob ❶ again and fully remove emergency key ❷.

▶ **To insert:** press release knob ❶.

▶ Insert emergency key ❷ to the intermediate position or fully until it engages.

❶ You can use the intermediate position of emergency key ❷ to attach the SmartKey to a key ring.

### Replacing the SmartKey battery

**⚠ DANGER** Serious damage to health caused by swallowing batteries

Batteries contain toxic and corrosive substances. Swallowing batteries may cause serious damage to health.

There is a risk of fatal injury.

- ▶ Keep batteries out of the reach of children.
- ▶ If batteries are swallowed, seek medical attention immediately.

**🔥 ENVIRONMENTAL NOTE** Environmental damage caused by improper disposal of batteries



Batteries contain pollutants. It is illegal to dispose of them with the household rubbish.



Dispose of batteries in an environmentally responsible manner. Take discharged batteries to a qualified specialist workshop or to a collection point for used batteries.

### Requirements:

- You require a CR 2032 3 V cell battery.

Mercedes-Benz recommends that you have the battery replaced at a qualified specialist workshop.

## 68 Opening and closing

- ▶ Remove the emergency key (→ page 67).

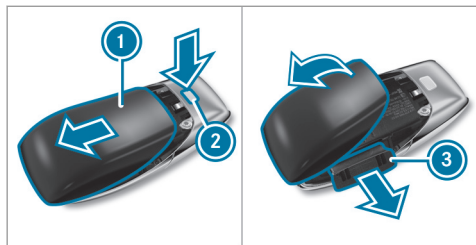

- ▶ Re-attach cover ① and push it until it engages.

- ▶ Press release button ② down fully and slide cover ① in the direction of the arrow.
- ▶ Fold out cover ① in the direction of the arrow and remove.
- ▶ Remove battery compartment ③ and take out the discharged battery.
- ▶ Insert the new battery into battery compartment ③. Observe the positive pole marking in the battery compartment and on the battery when doing this.
- ▶ Push in battery compartment ③.

### Problems with the SmartKey

| Problem                                       | Possible causes/consequences and ► Solutions   |
|---|--|
| You can no longer lock or unlock the vehicle. | <p>Possible causes:</p> <ul style="list-style-type: none"><li>• The SmartKey battery is discharged or nearly discharged.</li><li>• There is interference from a powerful radio signal source.</li><li>• The SmartKey is faulty.</li></ul> <p>► Check the battery using the battery check lamp and replace if necessary (→ page 67).</p> <p>► Use the emergency key to lock or unlock (→ page 67).</p> <p>► Have the SmartKey checked at a qualified specialist workshop.</p> |
| You have lost a SmartKey.                     | <p>► Have the SmartKey deactivated at a qualified specialist workshop.</p> <p>► If necessary, have the mechanical lock changed as well.</p>  |

## Doors

### Unlocking and opening doors from the inside

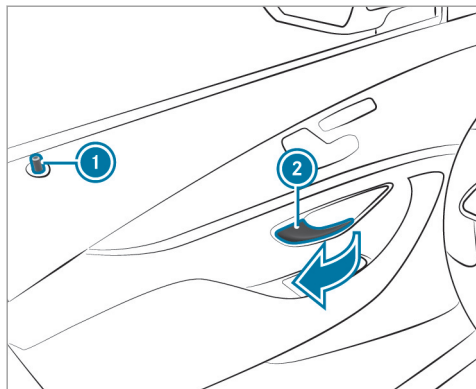

- ▶ **To unlock and open a front door:** pull door handle ②. Locking pin ① pops up when the door is unlocked.

- ▶ **To unlock a rear door:** pull the rear door handle. The locking pin pops up when the rear door is unlocked.
- ▶ **To open a rear door:** pull the rear door handle again.

### Centrally locking and unlocking the vehicle from the inside

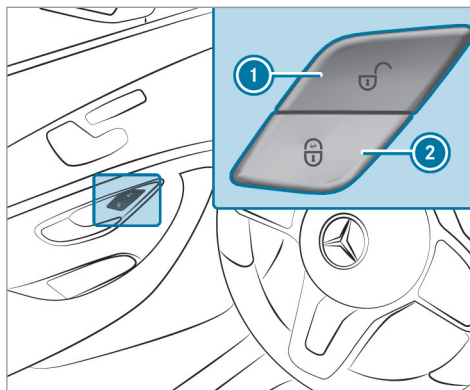

- ▶ **To unlock:** press button ①.
- ▶ **To lock:** press button ②.

This does not lock or unlock the fuel filler flap.

The vehicle is not unlocked:

- If you have locked the vehicle using the SmartKey.
- If you have locked the vehicle using KEY-LESS-GO.

### Locking/unlocking the vehicle with KEY-LESS-GO

#### Requirements:

- The SmartKey is outside the vehicle.
- The distance between the SmartKey and the vehicle does not exceed 3 ft (1 m).
- The driver's door and the door at which the door handle is used are closed.



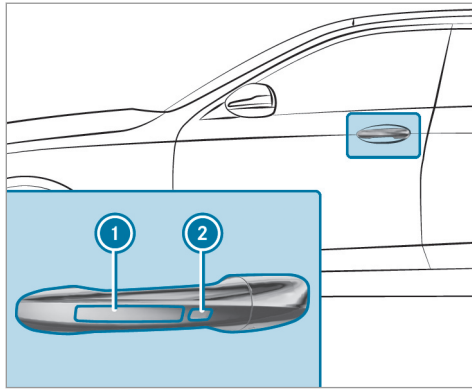

If you open the tailgate from outside it is automatically unlocked.

- ▶ **To unlock the vehicle:** touch the inner surface of the door handle.
  - ▶ **To lock the vehicle:** touch sensor surface ① or ②.
  - ▶ **Convenience closing:** touch recessed sensor surface ② until the closing process has been completed.
- ⓘ Further information on convenience closing (→ page 81).

### Problems with KEYLESS-GO

| Problem  | Possible causes/consequences and ► Solutions  |
|--|---|
| You can no longer lock or unlock the vehicle using KEYLESS-GO. | <p>Possible causes are:</p> <ul style="list-style-type: none"><li>• The key functions have been deactivated (→ page 66).</li><li>• The SmartKey battery is discharged or nearly discharged.</li><li>• There is interference from a powerful radio signal source.</li><li>• The SmartKey is faulty.</li></ul> <p>► Activate the SmartKey functions (→ page 66).</p> <p>► Check the battery using the battery check lamp and replace if necessary (→ page 67).</p> <p>► Use the emergency key to unlock or lock the vehicle (→ page 67).</p> <p>► Have the vehicle and SmartKey checked at a qualified specialist workshop.</p> |

### Activating/deactivating the automatic locking feature

The vehicle is locked automatically when the ignition is switched on and the wheels are turning faster than walking pace.

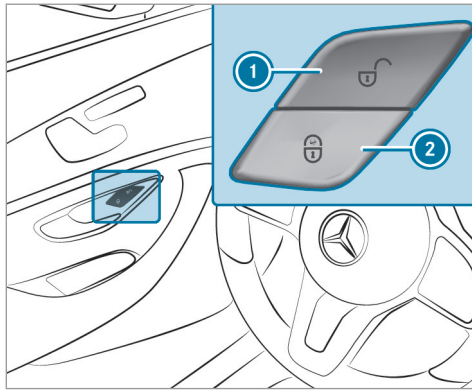

- ▶ **To activate:** press and hold button ② for approximately five seconds until an acoustic signal sounds.
- ▶ **To deactivate:** press and hold button ① for approximately five seconds until an acoustic signal sounds.

In the following situations, there is a danger of being locked out when the function is activated:

- While the vehicle is being tow started/ pushed.
- If the vehicle is being tested on a roller dynamometer.

#### Locking/unlocking the driver's door with the emergency key

- ① If you wish to lock the vehicle entirely using the emergency key, first press the button for locking from the inside while the driver's door is open. Then proceed to lock the driver's door using the emergency key.

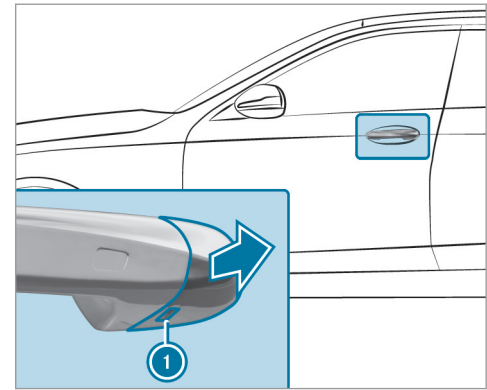

- ▶ Insert the emergency key as far as it will go into opening ① in the cover.
- ▶ Pull and hold the door handle.
- ▶ Pull the cover on the emergency key as straight as possible away from the vehicle until it releases.
- ▶ Release the door handle.

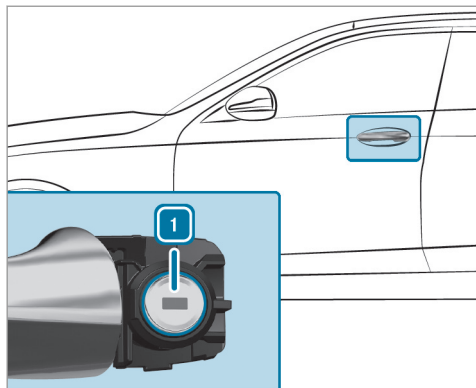

- ▶ **To unlock:** turn the emergency key counter-clockwise to position 1.
- ▶ **To lock:** turn the emergency key clockwise to position 1.
- ▶ Carefully press the cover onto the lock cylinder until it engages and is seated firmly.

## Cargo compartment

### Opening the tailgate

#### ⚠ DANGER Risk of exhaust gas poisoning

Combustion engines emit poisonous exhaust gases such as carbon monoxide. Exhaust gases can enter the vehicle interior if the tailgate is open when the engine is running, especially if the vehicle is in motion.

- ▶ Always switch off the engine before opening the tailgate.
- ▶ Never drive with the tailgate open.

#### ! NOTE Damage to the tailgate caused by obstacles above the vehicle

The tailgate swings rearwards and upwards when it is opened.

- ▶ Make sure that there is sufficient space behind and above the tailgate.

**You have the following options for opening the tailgate:**

- ▶ Pull the tailgate handle.
- ▶ **Vehicles with HANDS-FREE ACCESS:** Use your foot to kick below the bumper (→ page 77).

### Vehicles with an EASY-PACK tailgate

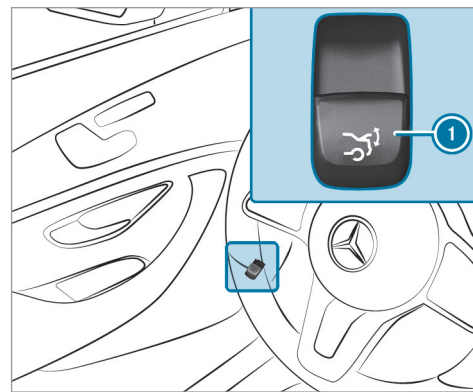

- ▶ Pull remote opening switch 1 for the tailgate.

- ▶ Press and hold the  button on the SmartKey.
- ▶ If the tailgate is unlocked, pull the tailgate handle and release it again immediately.
- ▶ For a tailgate stopped in an intermediate position, pull it upwards and release it as soon as it starts to open.

The tailgate is equipped with an automatic obstruction detection function. If a solid object blocks or restricts the tailgate during automatic opening, this process will be stopped. The automatic obstruction detection function is only an aid. It is not a substitute for your attentiveness when you are opening the tailgate.

### Closing the tailgate

**⚠ WARNING** Risk of injury from unsecured items in the vehicle

If objects, luggage or loads are not secured or not secured sufficiently, they could slip, tip over or be thrown around and thereby hit vehicle occupants.

There is a risk of injury, particularly in the event of sudden braking or a sudden change in direction.

- ▶ Always stow objects in such a way that they cannot be thrown around.
- ▶ Before the journey, secure objects, luggage or loads against slipping or tipping over.

Observe the notes on loading the vehicle.

**To close the tailgate, the following options are available:**

- ▶ Pull the tailgate downwards with the handle and let it drop into the lock.

### Vehicles with an EASY-PACK tailgate

**⚠ WARNING** Risk of becoming trapped during automatic closing of the tailgate

Parts of the body could become trapped during automatic closing of the tailgate. Moreover, people, e.g. children, may be standing in the closing area or may enter the closing area during the closing process.

- ▶ Make sure that nobody is in the vicinity of the closing area during the closing process.

Use one of the following options to stop the closing process:

- Press the  button on the SmartKey.
- Press or pull the remote operating switch on the driver's door.
- Press the closing or locking button on the tailgate.
- Pull the tailgate handle.

- ▶ **Vehicles with HANDS-FREE ACCESS:** it is also possible to stop the closing process by making a kicking movement below the rear bumper.

**To close the tailgate, the following options are available:**

- ▶ Pull the tailgate downwards slightly. Release it as soon as it begins to close.

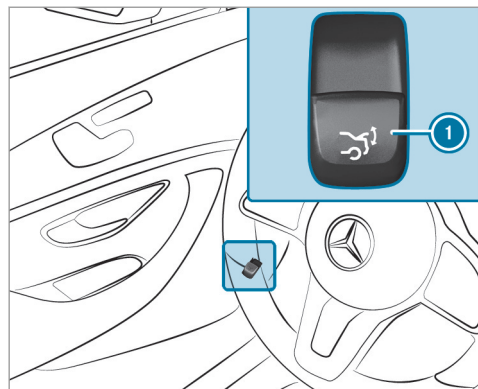

- ▶ Switch on the power supply or the ignition.
- ▶ Press remote operating switch ① for the tailgate.

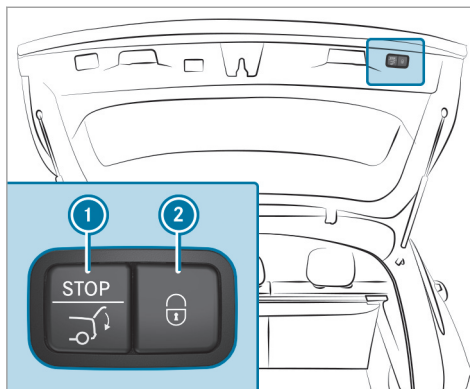

- ▶ Press closing button ① on the tailgate.

#### Vehicles with KEYLESS-GO

- ▶ Press locking button ② on the tailgate. If a SmartKey is detected outside the vehicle, the tailgate will close and the vehicle will be locked.

- ▶ Press and hold the  button on the SmartKey (with the SmartKey in the vicinity of the vehicle).

#### Vehicles with HANDS-FREE ACCESS

- ▶ Make a kicking movement with your foot below the bumper (→ page 77).

#### Automatic reversing function for the tailgate

The tailgate is equipped with automatic obstruction detection with reversing function. If a solid object blocks or restricts the tailgate when it is automatically closing, the tailgate will automatically open again slightly. Automatic obstruction detection with reversing function is only an aid. It is not a substitute for your attentiveness when you are closing the tailgate.

- ▶ During the closing process, make sure that no body parts are in the closing area.

**⚠ WARNING** Risk of becoming trapped despite the reversing function

The reversing function does not react:

- To soft, light and thin objects, e.g. fingers.
- Over the last  $\frac{1}{3}$  in (8 mm) of the closing path.

In these situations in particular, the reversing function cannot prevent someone being trapped.

▶ When closing, make sure that no body parts are in the closing area.

If someone is trapped:

- Press the  button on the SmartKey, or
- Press or pull the remote operating switch on the driver's door, or
- Press the closing or locking button on the tailgate, or
- Pull the tailgate handle.

### HANDS-FREE ACCESS function

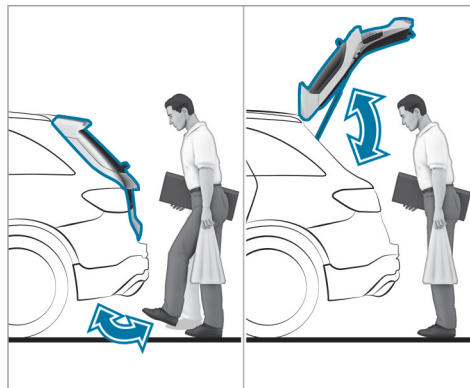

With HANDS-FREE ACCESS you can open, close or stop the closing process of the tailgate by performing a kicking movement under the rear bumper.

The kicking movement triggers the opening or closing process alternately.

Observe the notes when opening (→ page 74) and closing (→ page 75) the tailgate.

**i** Two warning tones sound when the tailgate is opening or closing.

**⚠ WARNING** Risk of burns caused by a hot exhaust system

The vehicle exhaust system can become very hot. If you use HANDS-FREE ACCESS, you could burn yourself by touching the exhaust system.

▶ Always ensure that you only make a kicking movement within the detection range of the sensors.

**!** **NOTE** Vehicle damage due to unintentional opening of the tailgate

- when using an automatic car wash
  - when using a high pressure cleaner
- ▶ Deactivate KEYLESS-GO or make sure that the key located is at least 10 ft

## 78 Opening and closing

(3 m) away from the vehicle in such situations.

When making the kicking movement, make sure that your feet are firmly on the ground, otherwise you could lose your balance, e.g. on ice.

Observe the following notes:

- The SmartKey is behind the vehicle.
- Stand at least 12 in (30 cm) away from the vehicle while performing the kicking movement.
- Do not come into contact with the bumper while making the kicking movement.
- Do not carry out the kicking movement too slowly.
- The kicking movement must be towards the vehicle and back again.

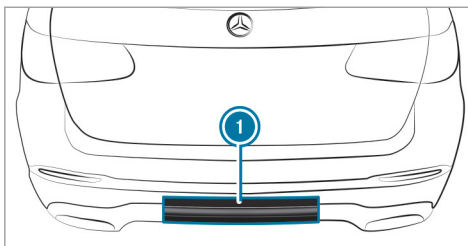

### ① Detection range of the sensors

If several consecutive kicking movements are not successful, wait ten seconds.

### System limits

The system may be impaired or may not function in the following cases:

- The area around the sensor is dirty, e.g. due to road salt or snow.
- The kicking movement is made using a prosthetic leg.

The tailgate can open or close unintentionally in the following situations:

- If a person's arms or legs are moving in the sensor detection range, e.g. when polishing the vehicle or picking up objects.
- If objects are moved or placed behind the vehicle, e.g. tensioning straps or luggage.
- If clamping straps, tarps or other coverings are pulled over the bumper.
- If a protective mat with a length reaching over the trunk sill down into the detection range of the sensors is used.
- If the protective mat is not secured correctly.
- When working on the trailer hitch, trailers or rear bicycle racks.

Deactivate the key functions (→ page 66) or do not carry the SmartKey about your person in such situations.



### Limiting the opening angle of the tailgate

#### Activating the opening angle limiter

You can limit the opening angle of the tailgate in the top half of its opening range to approximately 8 in (20 cm) before the end position.

- ▶ Stop the opening procedure of the tailgate at the desired position.
- ▶ Press and hold the closing button on the tailgate until you hear a short acoustic signal. The opening angle limiter will be activated. The tailgate will then stop in the stored position when opened.

To open the tailgate fully, pull the handle on the outside of the tailgate again after it has stopped automatically.

#### Deactivating the opening angle limiter

- ▶ Press and hold the closing button on the tailgate until two short acoustic signals sound.

### Unlocking the tailgate with the emergency key

- ▶ Fold the rear seat backrest forward.

- ▶ Remove the cargo compartment cover (→ page 113).

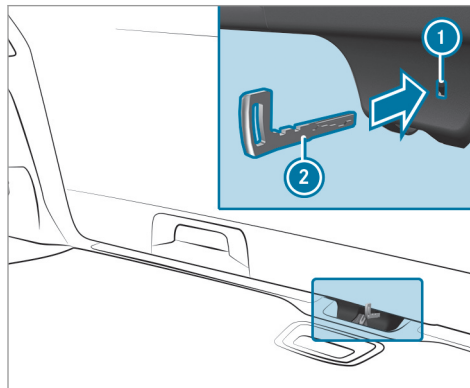

- ▶ Insert emergency key ② into opening ① in the trim and push it in. The tailgate will be unlocked.

### Side windows

#### Opening and closing the side windows

**⚠ WARNING** Risk of entrapment when opening a side window

When opening a side window, parts of the body could be drawn in or become trapped between the side window and window frame.

- ▶ When opening, make sure that nobody is touching the side window.
- ▶ If someone is trapped, release the button immediately or pull it in order to close the side window again.

**⚠ WARNING** Risk of becoming trapped when closing a side window

When closing a side window, body parts could be trapped in the closing area in the process.

- ▶ When closing, make sure that no body parts are in the closing area.

- ▶ If someone is trapped, release the button immediately or press the button in order to reopen the side window.

**⚠ WARNING** Risk of becoming trapped when children operate the side windows

Children could become trapped if they operate the side windows, particularly when unattended.

- ▶ Activate the child safety lock for the rear side windows.
- ▶ When leaving the vehicle, always take the SmartKey with you and lock the vehicle.
- ▶ Never leave children unattended in the vehicle.

**Requirements:**

- The power supply or the ignition is switched on.

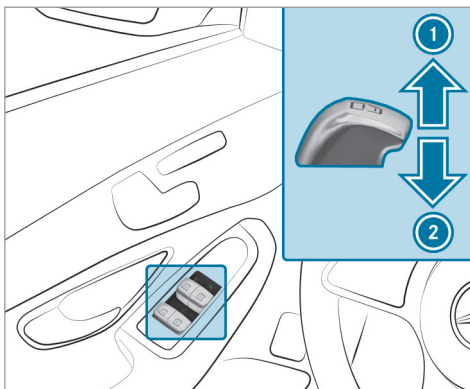

- ① Closes
- ② Opens

The buttons on the driver's door take precedence.

- ▶ **To start automatic operation:** press the  button beyond the point of resistance or pull and release it.

- ▶ **To interrupt automatic operation:** press or pull the  button again.

When the vehicle is switched off, the side windows can continue being operated.

This function is available for around four minutes or until a front door is opened.

**Automatic reversing function of the side windows**

If an object blocks a side window during the closing process, the side window will open again automatically. The automatic reversing function is only an aid and is not a substitute for your attentiveness.

- ▶ During the closing process, make sure that no body parts are in the closing area.

**⚠ WARNING** Risk of becoming trapped despite there being reversing protection on the side window

The reversing function does not react:

- To soft, light and thin objects, e.g. fingers
- During resetting

This means that the reverse function cannot prevent someone from becoming trapped in these situations.

- ▶ When closing, make sure that no body parts are in the closing area.
- ▶ If someone becomes trapped, press the  button to open the side window again.

### Convenience opening (ventilating the vehicle before starting a journey)

**⚠ WARNING** Risk of entrapment when opening a side window

When opening a side window, parts of the body could be drawn in or become trapped between the side window and window frame.

- ▶ When opening, make sure that nobody is touching the side window.
- ▶ Release the button immediately if somebody becomes trapped.

▶ Press and hold the  button on the SmartKey.

The following functions are performed:

- The vehicle is unlocked
- The side windows are opened.
- The panoramic sliding sunroof is opened.
- The seat ventilation of the driver's seat is switched on.

ⓘ If the roller sunblinds of the panoramic sliding sunroof are closed, the roller sunblinds are opened first.

▶ **To interrupt convenience opening:** release the  button.

▶ **To continue convenience opening:** press and hold the  button again.

### Convenience closing (closing the vehicle from outside)

**⚠ WARNING** Risk of entrapment caused by inadvertent convenience closing

When the convenience closing feature is operating, parts of the body could become trapped in the closing area of the side window and the sliding sunroof.

- ▶ Observe the complete closing procedure when using convenience closing.
- ▶ When closing, make sure that no body parts are in the closing area.

▶ Press and hold the  button on the SmartKey.

The following functions are performed:

- The vehicle is locked.
- The side windows are closed.
- The panoramic sliding sunroof is closed.

▶ **To interrupt convenience closing:** release the  button.

▶ **To close the roller sunblinds:** press and hold the  button again.

ⓘ Convenience closing can also be operated with KEYLESS-GO (→ page 70).

### Problems with the side windows

**⚠ WARNING** Risk of becoming trapped or fatally injured if reversing protection is not activated

If you close a side window again immediately after it has been blocked, the side window

will close with increased or maximum force. The reversing feature will then not be active.

Parts of the body could become trapped in the closing area in the process.

- ▶ Make sure that no parts of the body are in the closing area.
- ▶ To stop the closing process, release the button or press the button again to re-open the side window.

#### Problem

A side window cannot be closed and you cannot see the cause.

#### Possible causes/consequences and ▶ Solutions

- ▶ Check to see whether any objects are in the window guide.
- ▶ Adjust the side windows.

#### Adjusting the side windows

If a side window is obstructed during closing and reopens again immediately:

| Problem  | Possible causes/consequences and ► Solutions  |
|--|---|
|  | <ul style="list-style-type: none"> <li>► Immediately after this, pull the corresponding button again until the side window has closed, and hold the button for at least one more second (re-adjustment).<br/>The side window is closed without the automatic reversing function.</li> </ul> <p>If the side window is obstructed again and reopens again immediately:</p> <ul style="list-style-type: none"> <li>► Immediately after this, pull the corresponding button again until the side window has closed, and hold the button for at least one more second (follow-up adjustment).<br/>The side window is closed without the automatic reversing function.</li> </ul> |
| The side windows cannot be opened or closed using the convenience opening feature. | <p>The SmartKey battery is discharged or nearly discharged.</p> <ul style="list-style-type: none"> <li>► Check the battery using the battery check lamp and replace if necessary (→ page 67).</li> </ul>  |

### Sliding sunroof

#### Opening and closing the sliding sunroof

**i** The term "sliding sunroof" also refers to the panorama roof with power tilt/sliding panel.

**⚠ WARNING** Risk of becoming trapped while opening and closing the sliding sunroof

During opening and closing, parts of the body could get caught in the sweep of the sliding sunroof.

- When opening or closing, make sure that no body parts are in the sweep.

- Release the button immediately if somebody becomes trapped.

or

- Press the button in any direction during the automatic opening/closing process. The opening/closing process is stopped.

**⚠ WARNING** Risk of becoming trapped if the sliding sunroof is operated by children

Children operating the sliding sunroof could get caught in the moving parts, particularly if unattended.

- ▶ Never leave children unattended in the vehicle.
- ▶ When leaving the vehicle, always take the key with you and lock the vehicle.

**⚠ WARNING** Risk of becoming trapped while opening and closing the roller sun blind

When opening or closing, make sure that no body parts become trapped between the roller sun blind and frame or the sliding sunroof.

- ▶ When opening or closing, make sure that no body parts are in the sweep of the roller sun blind.

- ▶ Release the button immediately if somebody becomes trapped.

or

- ▶ Press the button in any direction during the automatic opening/closing process. The opening/closing process is stopped.

**! NOTE** Malfunction caused by snow and ice

Snow and ice may lead to a malfunction of the sliding sunroof.

- ▶ Only open the sliding sunroof if it is free of snow and ice.

**! NOTE** Damage caused by protruding objects

Objects that protrude from the sliding sunroof may damage the sealing strips.

- ▶ Do not allow anything to protrude from the sliding sunroof.

**! NOTE** Important points to remember when a roof rack is installed

When a roof rack is installed, raising or opening the sliding sunroof may be limited.

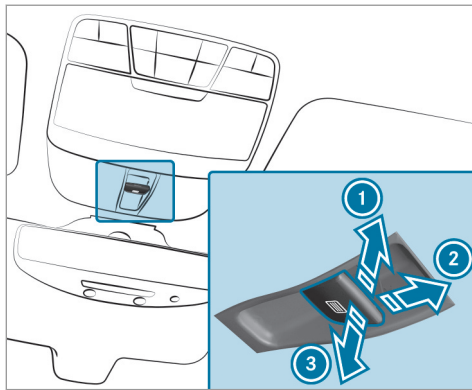

- ▶ Check whether the sliding sunroof can be raised or opened when a roof rack is installed.
- ▶ If in doubt, do not raise or open the sliding sunroof.



- ① Raises
- ② Opens
- ③ Closes/lowers

Use the  button to operate the panoramic sliding sunroof and the roller sunblind.

The panorama roof with power tilt/sliding panel can be operated only when the roller sunblind is open.

- ▶ Check whether the sliding sunroof can be raised or opened when a roof rack is installed.
- ▶ **To start automatic operation:** press the  button beyond the point of resistance or pull and release it.
- ▶ **To interrupt automatic operation:** briefly press the  button in any direction. The opening/closing process will be stopped.

**Vehicles with a panorama roof with power tilt/sliding panel:** The automatic raising feature is available only when the sliding sunroof is closed or raised.

#### Automatic reversing function of the sliding sunroof

If an object is obstructing the sliding sunroof during the closing process, the sliding sunroof will open again automatically. The automatic reversing function is only an aid and is not a substitute for your attentiveness.

- ▶ During the closing process, make sure that no body parts are in the closing area.

**⚠ WARNING** Risk of entrapment even with the reversing function active

The reversing feature does not react in particular:

- To soft, light and thin objects, e.g. fingers
- Over the last 1/8 in (4 mm) of the closing path
- During resetting

This means that the reverse function cannot prevent someone from becoming trapped in these situations.

- ▶ When closing, make sure that no body parts are in the closing area.
- ▶ Release the button immediately if somebody becomes trapped.

or

- ▶ Briefly press the button in any direction during automatic operation. The closing process is stopped.

### Automatic reversing function of the roller sunblind

If an object is obstructing the roller sunblind during the closing process, the roller sunblind will open again automatically. The automatic reversing function is only an aid and is not a substitute for your attentiveness.

- ▶ When closing the roller sunblind, make sure that no body parts are in the range of movement.

#### **⚠ WARNING** Risk of becoming trapped despite reversing feature

In particular, the reversing feature does not react to soft, light and thin objects, e.g. fingers.

This means that the reversing feature cannot prevent entrapment in these situations.

- ▶ When closing the roller sunblind, make sure that no body parts are in the range of movement.
- ▶ Release the button immediately if somebody becomes trapped.

or

- ▶ Press the button in any direction during the automatic closing process. The closing process is stopped.

### Automatic functions of the sliding sunroof

- ① The term "sliding sunroof" also refers to the panoramic sliding sunroof.

By pushing or pulling the  button, you can interrupt the automatic functions: "Rain closing function when driving" and "Automatic lowering".

#### **Rain closing function when driving** **Vehicles with a panoramic sliding sunroof:**

If it starts to rain, the raised sliding sunroof is automatically lowered while the vehicle is in motion.

#### **Automatic lowering function** **Vehicles with a panoramic sliding sunroof:**

If the sliding sunroof is raised at the rear, it is

automatically lowered slightly at higher speeds. At low speeds, it is raised again automatically.

#### **⚠ WARNING** Risk of entrapment by automatic lowering of the sliding sunroof

At high speeds the raised sliding sunroof automatically lowers slightly at the rear.



This could trap you or other persons.

- ▶ Make sure that nobody reaches into the sweep of the sliding sunroof whilst the vehicle is in motion.
- ▶ If somebody becomes trapped, briefly push the sliding sunroof button forwards or backwards. The sliding sunroof lifts during opening.

### Problems with the sliding sunroof

- ① The term "sliding sunroof" also refers to the panoramic sliding sunroof.



| Problem  | Possible causes/consequences and ► Solutions   |
|--|--|
| The sliding sunroof cannot be closed and you cannot see the cause. | <p><b>▲ WARNING</b> Risk of becoming trapped or fatal injury by closing the sliding sunroof again</p> <p>If you close the sliding sunroof again immediately after it has been blocked or reset, the sliding sunroof closes with increased force.</p> <p>Parts of the body could become trapped in the closing area in the process.</p> <ul style="list-style-type: none"><li>▶ Make sure that no parts of the body are in the closing area.</li><li>▶ Release the button immediately if somebody becomes trapped.</li></ul> <p>or</p> <ul style="list-style-type: none"><li>▶ Press the button in any direction during the automatic closing process.</li></ul> <p>The closing process is stopped.</p> <p>If the sliding sunroof is obstructed during closing and reopens again slightly:</p> <ul style="list-style-type: none"><li>▶ Immediately after automatic reversing, pull and hold the  button down again to the point of resistance until the sliding sunroof is closed.</li></ul> <p>The sliding sunroof will be closed with increased force.</p> <p>If the sliding sunroof is obstructed again and reopens again slightly:</p> <ul style="list-style-type: none"><li>▶ Repeat the previous step.</li></ul> <p>The sliding sunroof will be closed again with increased force.</p> |
|  | <ul style="list-style-type: none"><li>▶ Pull and hold the  button little by little until the sliding sunroof is fully closed.</li></ul>   |

**Problem**

**Vehicles with a panoramic sliding sunroof:** The sliding sunroof or the roller sunblind does not operate smoothly.

**Possible causes/consequences and ► Solutions**

- Pull and hold the  button little by little until the roller sunblind is fully closed.
- Use automatic operation to fully open and then close the sliding sunroof.

**Roller sun blinds****Extending the rear side window roller sunblinds**

**!** **NOTE** Damage to the inertia reel due to it snapping back

If suddenly snapped back, the inertia reel may be damaged.

- Always move the roller sun blind by hand.
- Do not drive with the roller sun blind hooked in and side windows opened at the same time.

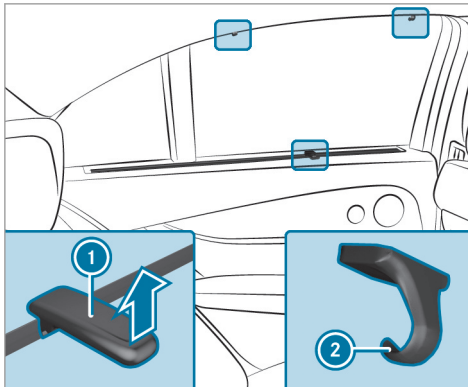

- Pull the roller sunblind out by tab **1** and hook it onto brackets **2** at the top of the window.

**Operating the roller sunblind for the panoramic roof**

**!** **WARNING** Risk of becoming trapped when opening and closing the roller sunblinds

Body parts can become trapped between the roller sunblind and frame when opening or closing.



- When opening or closing, make sure that no body parts are in the range of movement of the roller sunblind.

- ▶ Release the button immediately if somebody becomes trapped.
- or
- ▶ Briefly press the button in any direction during automatic operation. The opening/closing process is stopped.

**Requirements:**

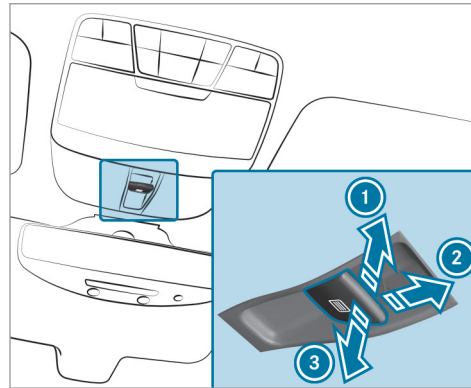
- The power supply is switched on (→ page 152).

**Opening and closing the roller sunblind**

- ▶ **To open:** push the  button in direction ① or pull in direction ②.
- ▶ **To close:** pull the  button in direction ③.

If you push or pull the  button beyond the point of resistance, you will start automatic operation in the direction in question. You can

stop automatic operation by pushing or pulling the button again.

**Automatic reversing function of the roller sunblind**

If an object is obstructing the roller sunblind during the closing process, the roller sunblind will open again automatically. The automatic reversing function is only an aid and is not a substitute for your attentiveness.

- ▶ When closing the roller sunblind, make sure that no body parts are in the range of movement.

**⚠ WARNING** Risk of becoming trapped despite reversing feature

In particular, the reversing feature does not react to soft, light and thin objects, e.g. fingers.

This means that the reversing feature cannot prevent entrapment in these situations.

- ▶ When closing the roller sunblind, make sure that no body parts are in the range of movement.

- ▶ Release the button immediately if somebody becomes trapped.
- or
- ▶ Press the button in any direction during the automatic closing process. The closing process is stopped.



### Adjusting the roller sunblind for the panoramic roof

#### Requirements:

- The power supply is switched on.

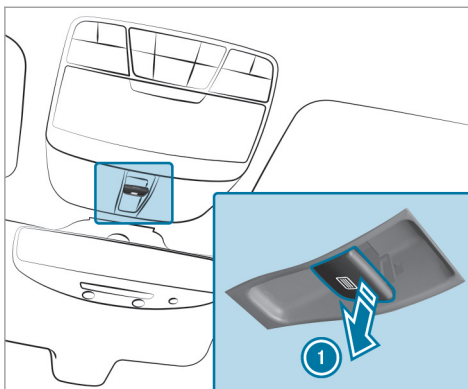
If the roller sunblind cannot be moved smoothly, re-adjust the roller sunblind.



- ▶ Pull the  button down repeatedly to the point of resistance in the direction of arrow ① until the roller sunblind is fully closed.
- ▶ Pull and hold the  button for another second.
- ▶ Check whether the roller sunblind can be completely opened again.

- ▶ If this is not the case, repeat the steps above.
- ▶ If the roller sunblind still cannot be moved smoothly, contact a qualified specialist workshop.

### Anti-theft protection

#### Function of the immobilizer

The immobilizer prevents your vehicle from being started without the correct SmartKey.

The immobilizer is automatically activated when the ignition is switched off and deactivated when the ignition is switched on.

When leaving the vehicle, always take the SmartKey with you and lock the vehicle. Anyone can start the engine if a valid SmartKey has been left inside the vehicle.

- ❗ In the event the engine cannot be started (yet the vehicle's battery is charged), the system is not operational. Contact an authorized Mercedes-Benz Center or call 1-800-FOR-MERCEdes (in the USA) or 1-800-387-0100 (in Canada).

## ATA (anti-theft alarm system)

### Function of the ATA system

If the ATA system is armed, a visual and audible alarm is triggered in the following situations:

- When a door is opened
- When the tailgate is opened
- When the hood is opened
- When the interior motion sensor is triggered (→ page 92)
- When the tow-away alarm is triggered (→ page 92)

The ATA system is armed automatically after approximately ten seconds in the following situations:

- After locking the vehicle with the SmartKey
- After locking the vehicle using KEYLESS-GO



Indicator lamp ① flashes when the ATA system is armed.



The ATA system is deactivated automatically in the following situations:

- After unlocking the vehicle with the SmartKey
- After unlocking the vehicle using KEYLESS-GO

- After pressing the start/stop button with the SmartKey in the stowage compartment (→ page 153)

- ① When the Mercedes-Benz emergency call system is active and the alarm stays on for more than 30 seconds, a message is automatically sent to the Customer Assistance Center (→ page 392).
- ① In the case of severe battery discharging, the anti-theft alarm system is automatically deactivated to facilitate the next engine start.

### Deactivating the ATA

- ▶ Press the ,  or  button on the SmartKey.

or

- ▶ Press the start/stop button with the SmartKey in the stowage compartment (→ page 153)

### Deactivating the alarm using KEYLESS-GO:

- ▶ Grasp the outside door handle with the SmartKey outside the vehicle.

### Function of the tow-away alarm

- ⓘ This function may not be available in all countries.

An audible and visual alarm is triggered if an alteration to your vehicle's angle of inclination is detected while the tow-away alarm is armed.



The tow-away alarm is automatically armed after approximately 60 seconds:

- After locking the vehicle with the SmartKey
- After locking the vehicle using KEYLESS-GO

The tow-away alarm is only armed when the following components are closed:

- The doors
- The tailgate

The tow-away alarm is automatically deactivated:

- After pressing the  or  button on the SmartKey
- After pressing the start/stop button with the SmartKey in the stowage compartment (→ page 153)

- After unlocking the vehicle using KEYLESS-GO
- When using HANDS-FREE ACCESS

Information on detecting damage on a parked vehicle (→ page 182).

### Arming/disarming the tow-away alarm

Multimedia system:

  **▶▶ Settings ▶▶ Quick Access**

▶ Activate or deactivate **Tow-away Protection**.

The tow-away alarm is armed again in the following cases:

- The vehicle is unlocked again.
- A door is opened.
- The vehicle is locked again.

- ⓘ If quick access is unavailable, select the **Vehicle** submenu in the **Settings** main menu to arm or disarm the tow-away alarm.

### Function of the interior motion sensor

- ⓘ This function may not be available in all countries.

When the interior motion sensor is activated, a visual and audible alarm is triggered if movement is detected in the vehicle interior.



The interior motion sensor is activated automatically after approximately ten seconds:

- after locking the vehicle with the SmartKey
- after locking the vehicle using KEYLESS-GO

The interior motion sensor is only activated when the following components are closed:

- the doors
- the tailgate

The interior motion sensor is automatically deactivated:

- after pressing the  or  button on the SmartKey
- after pressing the start/stop button with the SmartKey in the stowage compartment (→ page 153)

- after unlocking the vehicle using KEYLESS-GO
- when using HANDS-FREE ACCESS

The following situations can lead to a false alarm:

- moving objects such as mascots in the vehicle interior
- when the side window is open
- when the panoramic sliding sunroof is open

### Activating/deactivating the interior motion sensor

Multimedia system:

  **Settings** **Quick Access**

- ▶ Activate or deactivate **Interior Motion Sensor**.

The interior motion sensor is activated again in the following cases:

- The vehicle is unlocked again.
- A door is opened.
- The vehicle is locked again.

- ⓘ If quick access is unavailable, select the **Vehicle** menu under **Settings** to activate or deactivate the interior motion sensor.

**Notes on the correct driver's seat position**

**⚠ WARNING** Risk of injury from adjusting the vehicle settings while the vehicle is in motion

You could lose control of the vehicle in the following situations:

- if you adjust the driver's seat, the head restraint, the steering wheel or the mirror while the vehicle is in motion
- if you fasten your seat belt while the vehicle is in motion

► Before starting the engine: adjust the driver's seat, the head restraint, the steering wheel or the mirror and fasten your seat belt.

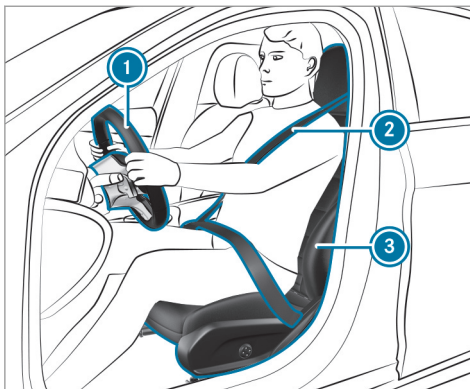

Ensure the following when adjusting steering wheel ①, seat belt ② and driver's seat ③:

- You are sitting as far away from the driver's airbag as possible, taking the following points into consideration.
- You are sitting in an upright position
- Your thighs are slightly supported by the seat cushion

- Your legs are not fully extended and you can depress the pedals properly
- The back of your head is supported at eye level by the center of the head restraint
- You can hold the steering wheel with your arms slightly bent
- You can move your legs freely
- You can see all the displays on the instrument cluster clearly
- You have a good overview of the traffic conditions
- Your seat belt sits snugly against your body and passes across the center of your shoulder and across your hips in the pelvic area



## Seats

### Adjusting the front seat mechanically and electrically (without Seat Comfort Package)

- ⚠ WARNING** Risk of becoming trapped if the seats are adjusted by children

Children could become trapped if they adjust the seats, particularly when unattended.

- ▶ When leaving the vehicle, always take the SmartKey with you and lock the vehicle.
- ▶ Never leave children unattended in the vehicle.

The seats can be adjusted when the ignition is switched off.

- ⚠ WARNING** Risk of becoming trapped when adjusting the seats

When you adjust a seat, you or other vehicle occupants could become trapped, e.g. on the seat guide rail.

- ▶ When adjusting a seat, make sure that no one has any body parts in the sweep of the seat.

Observe the safety notes on "Airbags" and "Children in the vehicle".

- ⚠ WARNING** Risk of accident due to the driver's seat not being engaged

If the driver's seat is not engaged, it could move unexpectedly while the vehicle is in motion.

This could cause you to lose control of the vehicle.

- ▶ Always make sure that the driver's seat is engaged before starting the vehicle.

- ⚠ WARNING** Risk of injury from adjusting the vehicle settings while the vehicle is in motion

You could lose control of the vehicle in the following situations:

- if you adjust the driver's seat, the head restraint, the steering wheel or the mirror while the vehicle is in motion
- if you fasten your seat belt while the vehicle is in motion

- ▶ Before starting the engine: adjust the driver's seat, the head restraint, the steering wheel or the mirror and fasten your seat belt.

- ⚠ WARNING** Risk of becoming trapped if the seat height is adjusted carelessly

If you adjust the seat height carelessly, you or other vehicle occupants could be trapped and thereby injured.

Children in particular could accidentally press the electrical seat adjustment buttons and become trapped.

- ▶ While moving the seats, make sure that hands or other body parts do not get under the lever assembly of the seat adjustment system.

**⚠ WARNING** Risk of injury due to head restraints which are not installed or are adjusted incorrectly

If head restraints are not installed or are adjusted incorrectly, the head restraints cannot provide protection as intended.

There is an increased risk of injury in the head and neck area, e.g. in the event of an accident or when braking.

- ▶ Always drive with the head restraints installed.
- ▶ Before driving off, make sure for every vehicle occupant that the center of the head restraint supports the back of the head at about eye level.

Do not interchange the head restraints of the front and rear seats. Otherwise, you will not be able to adjust the height and angle of the head restraints correctly.

Adjust the head restraint fore-and-aft position so that it is as close as possible to the back of your head.

**⚠ WARNING** Risk of injury or death due to incorrect seat position

The seat belt does not offer the intended level of protection if you have not moved the seat backrest to an almost vertical position.

When braking or in the event of an accident, you could slide underneath the seat belt and sustain abdominal or neck injuries, for example.

- ▶ Adjust the seat properly before beginning your journey.
- ▶ Always ensure that the seat backrest is in an almost vertical position and that the shoulder section of your seat belt is routed across the center of your shoulder.

**!** **NOTE** Damage to the seats when moving the seats back

The seats may be damaged by objects when moving the seats back.

- ▶ When moving the seats back, make sure that there are no objects in the footwell, under or behind the seats.

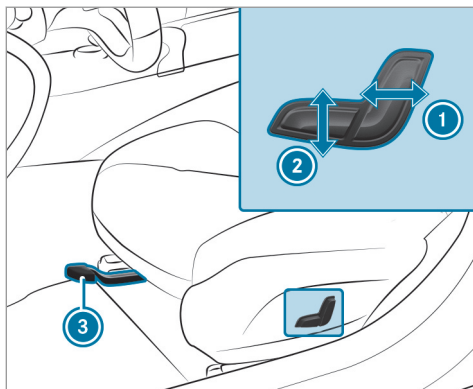

- ① Seat backrest inclination
- ② Seat height
- ③ Seat fore-and-aft position

- ▶ **To adjust the seat fore-and-aft position:** lift lever ③ and slide the seat into the desired position.
- ▶ Make sure that the seat is engaged in position.

### Adjusting the front seat electrically

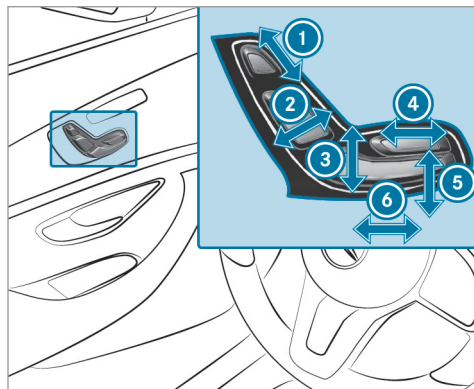

- ① Head restraint height
- ② Seat backrest inclination
- ③ Seat height
- ④ Seat cushion length
- ⑤ Seat cushion inclination
- ⑥ Seat fore-and-aft position

- ▶ Save the settings with the memory function (→ page 105).

### Adjusting the 4-way lumbar support

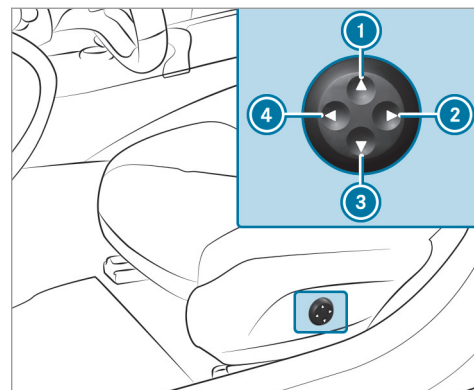

- ① Raise
- ② Soften
- ③ Lower
- ④ Harden

- ▶ Using buttons ① to ④, adjust the contour of the backrest individually to suit your back.

## Head restraints

### Adjusting the front seat head restraints mechanically

- ⚠ **WARNING** Risk of injury from adjusting the vehicle settings while the vehicle is in motion

You could lose control of the vehicle in the following situations:

- if you adjust the driver's seat, the head restraint, the steering wheel or the mirror while the vehicle is in motion
- if you fasten your seat belt while the vehicle is in motion
- ▶ Before starting the engine: adjust the driver's seat, the head restraint, the steering wheel or the mirror and fasten your seat belt.

- ⚠ **WARNING** Risk of injury due to head restraints which are not installed or are adjusted incorrectly

If head restraints are not installed or are adjusted incorrectly, the head restraints cannot provide protection as intended.

There is an increased risk of injury in the head and neck area, e.g. in the event of an accident or when braking.

- ▶ Always drive with the head restraints installed.
- ▶ Before driving off, make sure for every vehicle occupant that the center of the head restraint supports the back of the head at about eye level.

Do not interchange the head restraints of the front and rear seats. Otherwise, you will not be able to adjust the height and angle of the head restraints correctly.

Adjust the head restraint fore-and-aft position so that it is as close as possible to the back of your head.

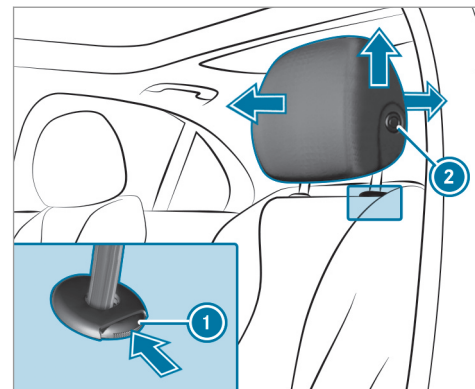

- ▶ **To raise:** pull the head restraint up.
- ▶ **To lower:** press release knob ① in the direction of the arrow and push the head restraint down.
- ▶ **To move forwards:** pull the head restraint forwards.
- ▶ **To move backwards:** press and hold release knob ②.

- ▶ Push the head restraint backwards and let go of release knob ②.

### Adjusting the head restraints of the rear seats mechanically

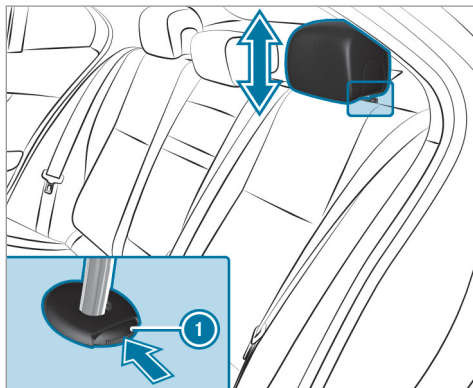

- ▶ **To raise:** pull the head restraint up.
- ▶ **To lower:** press the release knob ① in the direction of the arrow and push the head restraint down.

### Installing/removing the rear seat head restraints

#### Removing

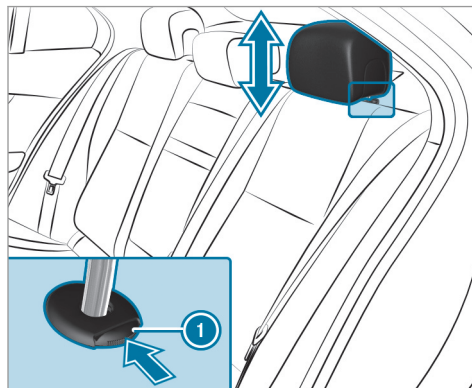

- ▶ Release the rear seat backrest and fold it forwards slightly (→ page 109).
- ▶ Pull the head restraint upwards as far as it will go.

- ▶ Push release knob ① in the direction of the arrow and pull out the head restraint.

#### Installing

- ▶ Insert the head restraint such that the notches on the bar are on the left when viewed in the direction of travel.
- ▶ Push the head restraint down until it engages.
- ▶ Fold the rear seat backrest back until it engages.

### Configuring the seat settings

Multimedia system:

→ ▶ Comfort ▶ Seat Comfort

### Adjusting the backrest contour in the lumbar region of the seat backrest (lumbar)

- ▶ Select **Lumbar**.
- ▶ Select the settings for the desired seat.
- ▶ Adjust the air cushions.

### Adjusting the backrest side bolsters

- ▶ Select [Side Bolsters](#).
- ▶ Adjust the air cushion for the desired seat.

### Setting the seat heating balance

- ▶ Select [Seat Heating Balance](#).
- ▶ Adjust the heat distribution for the desired seat.

### Setting automatic seat adjustment

**⚠ WARNING** Risk of becoming trapped during adjustment of the driver's seat after calling up a driver profile

Selecting a profile may trigger an adjustment of the driver's seat to the position saved under the profile. You or other vehicle occupants could be injured in the process.

- ▶ Make sure that when the position of driver's seat is being adjusted using the multimedia system, no people or body parts are in the seat's range of movement.

If there is a risk of someone becoming trapped, stop the adjustment process immediately:

- ▶ a) Tap the warning message on the media display.
  - or
  - ▶ b) Press a memory position button or a seat adjustment switch on the driver's door.
- The adjustment process is stopped.

#### Requirements:

- Adapting the driver's seat position to the body size: automatic seat adjustment has been switched on.

Multimedia system:

- ▶  ▶ [Settings](#) ▶ [Vehicle](#)
- ▶ [Auto. Seat Adjustment](#)

#### Switching automatic seat adjustment on/off

When the active user profile is changed while the vehicle is stationary, the driver's seat, out-

side mirror and seat contour will automatically be adapted to the driver.

- ▶ Select [On](#) or [Off](#).
- ⓘ This setting is available only for individual user profiles. For the guest profile, automatic seat adjustment cannot be switched on or off. Further information about user profiles (→ page 297).

#### Adjusting the driver's seat position to body size

The vehicle will calculate a suitable driver's seat position on the basis of the driver's body size and set this directly.

- ▶ Select [SEAT POSITIONING](#).
- ▶ **To set the unit of measurement:** select [cm](#) or [ft/in](#).
- ▶ Set the size using the scale.
- ▶ Select [Start Positioning](#).  
The driver's seat position will be adjusted to the body size that has been set.

- ❶ If the driver's seat position calculated by the vehicle is not practical or comfortable, it can be changed manually at any time via the control buttons.  
The outside mirrors are not set via this function. Instead, they have to be set manually via the switches.
- ❷ You can also make these settings via the Mercedes me portal for your user profile. By synchronizing the profiles in the vehicle and the Mercedes me connect profiles, you can carry over these settings for your vehicle. Further information about synchronizing user profiles (→ page 299).

### Setting the easy entry and exit feature

- ▶ Activate or deactivate the function.
- ❶ If you use an individual user profile and have set your body size, this information is carried over for the easy entry and exit feature. This causes the driver's seat to automatically move into the correct position (→ page 298).

### Selecting the message program for the front seats

Multimedia system:

→  ▶ Comfort ▶ Message

- ▶ Select **Wave Massage** or **Pulsating Massage**.  
The selected program will start.
- ▶ Start the program for the desired seat .
- ▶ **To set the message intensity:** switch **High Intensity** on or off.

### Resetting seat settings

Multimedia system:

→  ▶ Comfort ▶ Seat Comfort

- ▶ Select **Reset**.
- ▶ Select  for the desired seat.  
The settings for the selected seat are reset.

### Switching the seat heating on/off

**⚠ WARNING** Risk of burns due to repeatedly switching on the seat heating

Repeatedly switching on the seat heating can cause the seat cushion and seat backrest padding to become very hot.

The health of persons with limited temperature sensitivity or a limited ability to react to high temperatures may be affected or they may even suffer burn-like injuries.

- ▶ Do not repeatedly switch on the seat heating.

To protect against overheating, the seat heating may be temporarily deactivated after it is switched on repeatedly.

**! NOTE** Damage to the seats caused by objects or documents when the seat heating is switched on

When the seat heating is switched on, overheating may occur due to objects or docu-

ments placed on the seats, e.g. seat cushions or child seats. This could cause damage to the seat surface.

- ▶ Make sure that no objects or documents are on the seats when the seat heating is switched on.

**Requirements:**

- The power supply is switched on.

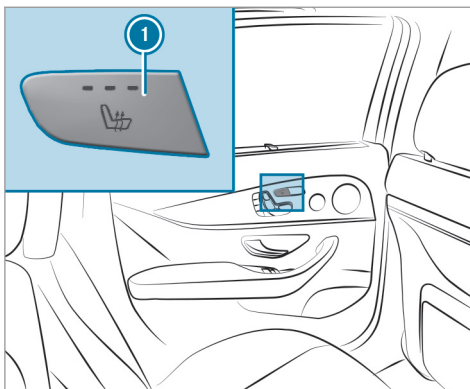
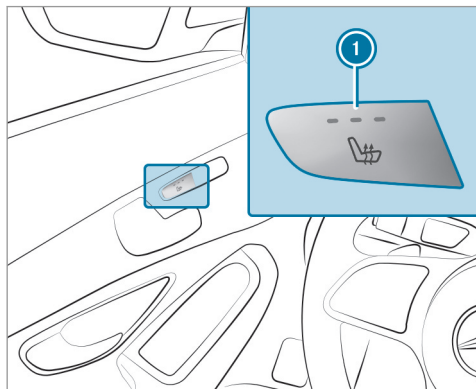

- ▶ **To switch on/increase the level:** press button ① repeatedly until the desired heating level is set. Depending on the heating level, up to three indicator lamps will light up.

- ▶ **To switch off/reduce the level:** press button ① repeatedly until the desired heating level is set. If all indicator lamps are off, the seat heating is switched off.

- ⓘ The seat heating will automatically switch down from the three heating levels after 8, 10 and 20 minutes until the seat heating is switched off.

**Switching the seat ventilation on/off**

**Requirements:**

- The power supply is switched on.



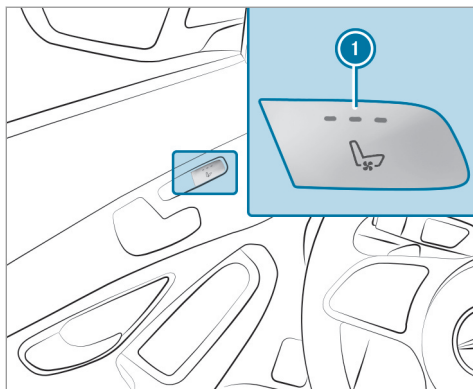

- ▶ **To switch on/increase the level:** press button ① repeatedly until the desired ventilation level is set. Depending on the ventilation level, up to three indicator lamps will light up.

- ▶ **To switch off/reduce the level:** press button ① repeatedly until the desired ventilation level is set. If all indicator lamps are off, the seat ventilation is switched off.

### Steering wheel

#### Adjusting the steering wheel electrically

The steering wheel can be adjusted when the power supply is switched off.

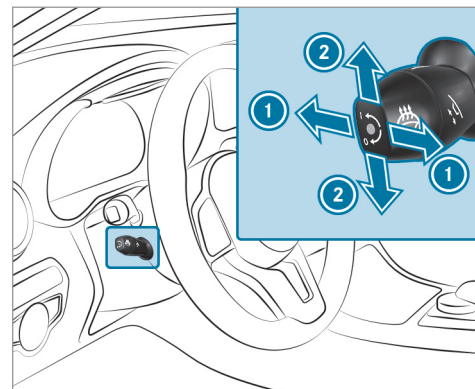

- ① Adjusts the distance to the steering wheel
- ② Adjusts the height
- ▶ Save the settings with the memory function (→ page 105).

#### Switching the steering wheel heater on/off

**Requirements:**

- The ignition is switched on.

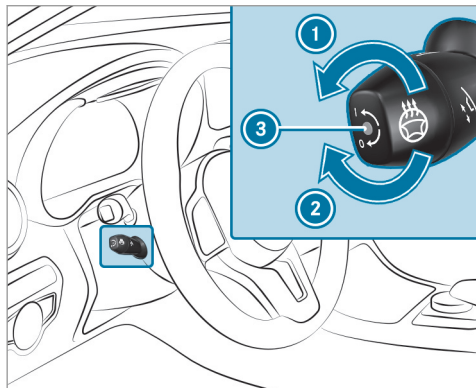

- ▶ Turn the lever in the direction of arrow ① or ②.  
If indicator lamp ③ lights up, the steering wheel heater is switched on.

When you switch the ignition off, the steering wheel heater will switch off.

### Easy entry and exit feature

#### Using the easy entry and exit feature

**⚠ WARNING** Risk of accident when driving off while adjusting the easy exit feature

- If you drive off while the easy entry and exit feature is making adjustments, you could lose control of the vehicle.

- ▶ Always wait until the adjustment process is complete before driving off.

**⚠ WARNING** Risk of becoming trapped while adjusting the easy entry and exit feature

When the easy entry and exit feature adjusts the steering wheel and the driver's seat, you and other vehicle occupants – particularly children – could become trapped.

- ▶ During the adjustment process of the easy entry and exit feature, make sure that no one has any body parts in the sweep of the seat or the steering wheel.

If there is a risk of becoming trapped by the steering wheel:

- ▶ Move the adjustment lever of the steering wheel.  
The adjustment process is stopped.

If there is a risk of becoming trapped by the driver's seat:

- ▶ Press the seat adjustment switch.  
The adjustment process is stopped.

**Vehicles with memory function:** You can stop the adjustment process by pressing one of the memory function position switches.

**⚠ WARNING** Risk of becoming trapped during activation of the easy entry and exit feature by children

If children activate the easy entry and exit feature, they can become trapped, particularly when unattended.

- ▶ Never leave children unattended in the vehicle.

- ▶ When leaving the vehicle, always take the SmartKey with you and lock the vehicle.

If the easy entry and exit feature is active, the steering wheel will move upwards and the driver's seat will move back in the following situations:

- You switch the ignition off with the driver's door open
- You open the driver's door with the ignition switched off

**i** The steering wheel will move upwards only if it is not already as high as it will go. The driver's seat will move backwards only if it is not already in the rearmost position.

The steering wheel and the driver's seat will move back to the last drive position in the following cases:

- You switch the power supply or the ignition on when the driver's door is closed
- You close the driver's door with the ignition switched on.

The last drive position will be stored when:

- You switch the ignition off.
- **Vehicles with memory function:** You call up the seat settings via the memory function.
- **Vehicles with memory function:** You save the seat settings via the memory function.

**Vehicles with memory function:** Press one of the memory function saved position buttons to stop the adjustment process.

### Operating the memory function

**⚠ WARNING** Risk of an accident if the memory function is used while driving

If you use the memory function on the driver's side while driving, you could lose control of the vehicle as a result of the adjustments being made.

- ▶ Only use the memory function on the driver's side when the vehicle is stationary.

**⚠ WARNING** Risk of entrapment when setting the seat with the memory function

When the memory function adjusts the seat or steering wheel, you and other vehicle occupants – particularly children – could become trapped.

- ▶ During the setting procedure of the memory function, ensure that no body parts are in the sweep of the seat or the steering wheel.
- ▶ If somebody becomes trapped, immediately release the memory function position button.  
The adjustment process is stopped.

**⚠ WARNING** Risk of entrapment if the memory function is activated by children

Children could become trapped if they activate the memory function, particularly when unattended.

- ▶ Never leave children unattended in the vehicle.

- ▶ When leaving the vehicle, always take the SmartKey with you and lock the vehicle.

The memory function can be used when the ignition is switched off.

### Storing

Seat adjustments for up to three people can be stored and called up using the memory function.

The following systems can be selected:

- Seat, backrest and head restraint
- Steering wheel
- Outside mirrors
- Head-up Display

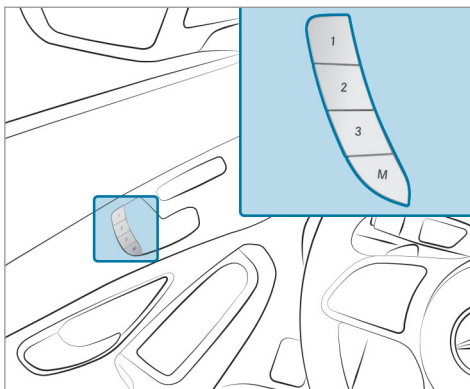

- ▶ Set the seat, the steering wheel, the Head-up Display and the outside mirrors to the desired position.
- ▶ Press memory button M and then press preset position button 1, 2 or 3 within three seconds.  
An acoustic signal sounds. The settings are stored.

- ▶ **To call up:** press and hold the relevant preset position button 1, 2 or 3 until the front seat, the steering wheel, Head-up Display and outside mirror are in the stored position.

- ⓘ When you release the preset position button, steering wheel, the seat and mirror setting functions stop immediately. The Head-up Display continues to be adjusted.

### Stowage areas

#### Notes on loading the vehicle

#### **⚠ DANGER** Risk of exhaust gas poisoning

Combustion engines emit poisonous exhaust gases such as carbon monoxide. Exhaust gases can enter the vehicle interior if the tailgate is open when the engine is running, especially if the vehicle is in motion.

- ▶ Always switch off the engine before opening the tailgate.
- ▶ Never drive with the tailgate open.

**⚠ WARNING** Risk of injury from unsecured items in the vehicle

If objects, luggage or loads are not secured or not secured sufficiently, they could slip, tip over or be thrown around and thereby hit vehicle occupants.

There is a risk of injury, particularly in the event of sudden braking or a sudden change in direction.

- ▶ Always stow objects in such a way that they cannot be thrown around.
- ▶ Before the journey, secure objects, luggage or loads against slipping or tipping over.

**⚠ WARNING** Risk of injury due to objects being stowed incorrectly

If you do not adequately stow objects in the vehicle interior, they could slip or be tossed around and thereby strike vehicle occupants. In addition, cup holders, open stowage spaces and mobile phone brackets cannot

always restrain the objects they contain in the event of an accident.

There is a risk of injury, particularly in the event of sudden braking or a sudden change in direction.

- ▶ Always stow objects in such a way that they cannot be tossed about in these or similar situations.
- ▶ Always make sure that objects do not project from stowage spaces, parcel nets or stowage nets.
- ▶ Close the lockable stowage spaces before starting a journey.
- ▶ Stow and secure objects that are heavy, hard, pointed, sharp-edged, fragile or too large in the cargo compartment.

**⚠ WARNING** Risk of burns from the tailpipe and tailpipe trims

The exhaust tailpipe and tailpipe trims can become very hot. If you come into contact with these parts of the vehicle, you could burn yourself.

- ▶ Always be particularly careful around the tailpipe and the tailpipe trims and supervise children especially closely in this area.
- ▶ Allow vehicle parts to cool down before touching them.

The driving characteristics of your vehicle are dependent on the distribution of the load within the vehicle. You should bear the following in mind when loading the vehicle:

- Never exceed the permissible gross mass or the gross axle weight rating for the vehicle (including occupants). The values are specified on the vehicle identification plate on the vehicle's B-pillar.
- The load must not protrude above the upper edge of the seat backrests.
- Always use the partition net when transporting objects in the cargo compartment.
- always place the load behind unoccupied seats if possible.
- secure the load using the tie-down eyes and distribute the load evenly.

## Storage spaces in the vehicle interior

### Overview of the front storage compartments

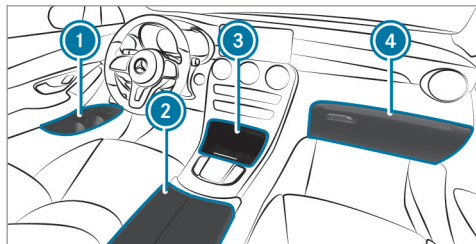

- ① Storage space in the doors
- ② Storage compartment in the armrest with a multimedia and USB connection
- ③ Storage compartment in the front center console with a USB connection
- ④ Glove box

### Locking/unlocking the glove box

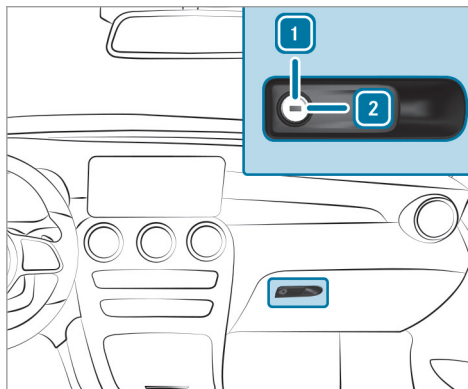

- ▶ Turn the emergency key a quarter turn clockwise ② (to lock) or counter-clockwise ① (to unlock).

### Opening the eyeglasses compartment

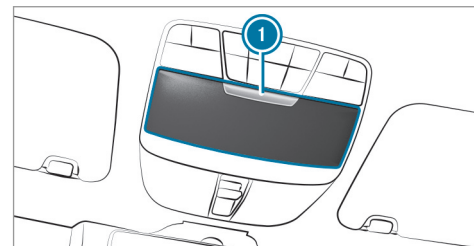

- ▶ Press button ①.

### Opening the storage compartment in the rear armrest

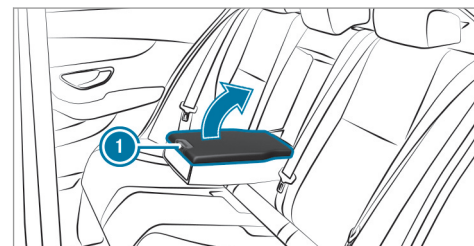

- ▶ Press release catch ① and swing the cover of the armrest upwards.

### Through-loading feature in the rear bench seat

#### Folding the rear seat backrest forwards

**⚠ WARNING** Risk of injury if the rear bench seat/rear seat and seat backrest are not engaged

If the rear bench seat/rear seat and seat backrest are not engaged they could fold forwards, e.g. when braking suddenly or in the event of an accident.

- If this is the case, the vehicle occupant would be forced into the seat belt by the rear bench seat/rear seat or by the seat backrest. The seat belt cannot protect as intended and could result in additional injury.
- Objects or loads in the trunk/cargo compartment cannot be restrained by the seat backrest.

- ▶ Make sure that the seat backrest and the rear bench seat/rear seat are engaged before every trip.

If the left and right seat backrests are not engaged and locked in place, this will be shown on the multifunction display on the instrument cluster. A warning tone will also sound.

If the center seat backrest is not engaged and locked, the red lock verification indicator will be visible.

The center and outer seat backrests can be folded forwards separately.

The outer seat backrests are unlocked electrically. The release buttons are located inside the cargo compartment.

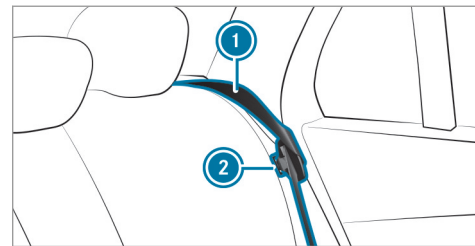

- ▶ Insert seat belt tongue ① into seat belt extender ②.

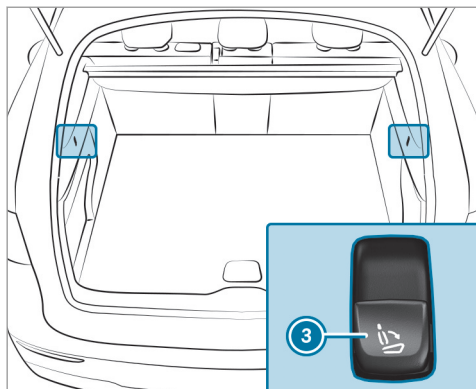

- ▶ If at least one section of the rear seat backrest is folded forwards, the corresponding front seat will move forwards slightly, if necessary, to avoid a collision.
- ▶ If necessary, fully insert the rear seat backrest head restraints.

- ▶ **Left and right seat backrests:** pull the left or right release handle ③. The corresponding seat backrest will fold forwards.

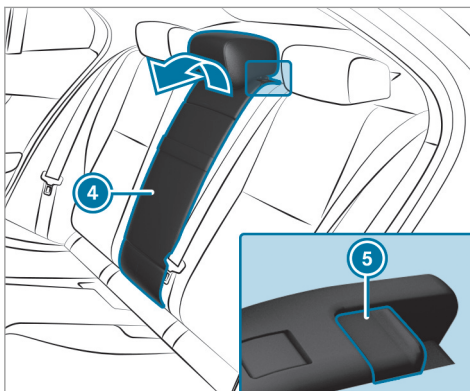

- ▶ **Center seat backrest:** pull release catch ⑤ of seat backrest ④ forwards.
- ▶ Fold seat backrest ④ forwards.

- ▶ If necessary, reset the driver's or front passenger seat.

#### Folding the rear seat backrest back

**!** **NOTE** Damage caused by trapping the seat belt when folding back the seat backrest

The seat belt could become trapped and thus damaged when the seat backrest is folded back.

- ▶ Make sure that the seat belt is not trapped when folding back the seat backrest.
- ▶ Move the driver's or front passenger seat forwards, if necessary.





- ▶ Fold corresponding seat backrest ① back until it engages.

**Left and right seat backrests:** if the seat backrest is not engaged and locked, this will be shown on the multifunction display on the instrument cluster.

A warning tone will also sound.

**Center seat backrest:** if the seat backrest is not engaged and locked, red lock verification indicator ② will be visible.

#### Locking the release catch of the center rear seat backrest

##### Requirements:

- The left and center seat backrests are engaged and joined together.

Lock the center seat backrest release catch if you want to secure the cargo compartment against unauthorized access. The center seat backrest can then be folded forwards only together with the left seat backrest.

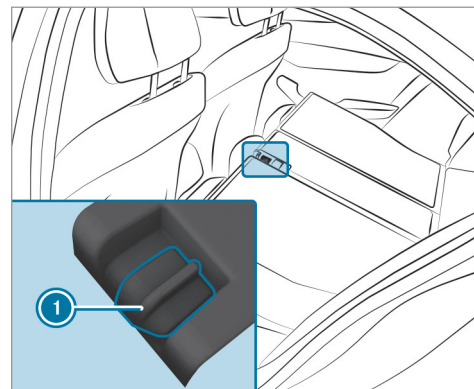

- ▶ Fold the center and left seat backrests forwards.
- ▶ **To lock:** slide catch ① upwards. The release catch of the center seat backrest will be locked.
- ▶ **To unlock:** slide catch ① downwards.

### Adjusting the angle of the rear seat backrests (cargo position)

To enlarge the cargo compartment, you can adjust the seat backrests so that they are ten degrees steeper (cargo position).

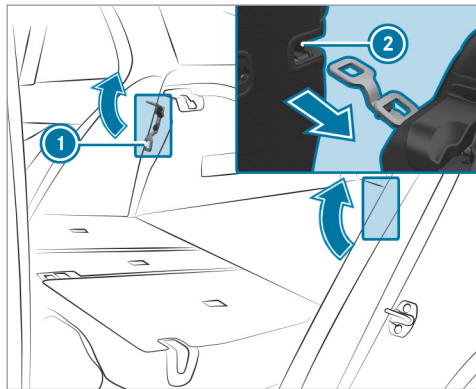

- ▶ Fold the seat backrest forwards (→ page 109).

- ▶ Move bracket ① in the direction of the arrow.
- ▶ Push seat backrest ② back to bracket ① until the backrest engages.

### Cargo compartment cover

#### Extending/retracting the cargo compartment cover

**⚠ WARNING** Risk of injury or death due to objects being poorly secured

On its own, the cargo compartment cover cannot secure or restrain heavy objects, items of luggage and heavy loads.

You could be hit by an unsecured load during sudden changes in direction, braking or in the event of an accident.

- ▶ Always stow objects in such a way that they cannot be thrown around.
- ▶ Secure objects, luggage or loads against slipping or tipping over, e.g. by

using tie-downs, even if you are using the cargo compartment cover.

**!** **NOTE** Damage to the cargo compartment cover when loading the vehicle

The cargo compartment cover may be damaged when loading the vehicle.

- ▶ Do not place any objects above the lower edge of the side windows or on the cargo compartment cover.

The cargo compartment cover is attached behind the seat backrest of the rear bench seat.

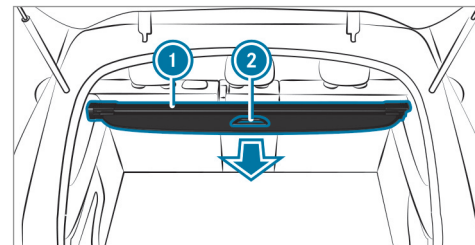

- ▶ **To extend:** pull cargo compartment cover ① back by grab handle ② and clip it into the holders on the left and right.
- ▶ **To retract:** unhook cargo compartment cover ① from the holders on the left and right and guide it forwards by grab handle ② until it is fully retracted.

**Installing/removing the cargo compartment cover**

**Requirements:**

- The cargo compartment cover is retracted.

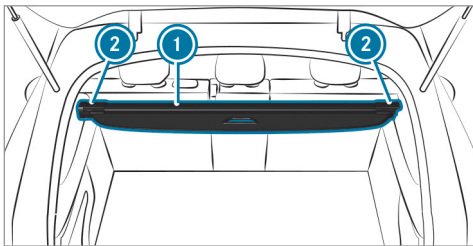

- ▶ **To remove:** press in the end cap of cargo compartment cover ① on the right-hand side.
- ▶ Push cargo compartment cover ① into recess ② on the opposite side.
- ▶ Take cargo compartment cover ① out by pulling it upwards.
- ▶ **To install:** place cargo compartment cover ① into recess ② on the left-hand side.
- ▶ Press in the end cap of cargo compartment cover ① on the opposite side and insert cargo compartment cover ① into other recess ②.
- ▶ Slide the end cap outwards.

**Attaching/removing the partitioning net**

**⚠ WARNING** Risk of injury or death due to objects being poorly secured

On its own, the partition net cannot secure or restrain heavy objects, items of luggage and heavy loads.

You could be hit by an unsecured load during sudden changes in direction, braking or in the event of an accident.

- ▶ Always stow objects in such a way that they cannot be thrown around.
- ▶ Secure objects, luggage or loads against slipping or tipping over, e.g. by using lashing material, even when you are using the partition net.

For safety reasons, always use a partitioning net when transporting a load.

Damaged partitioning nets can no longer fulfill their protective functions and must be replaced. Visit a qualified specialist workshop.

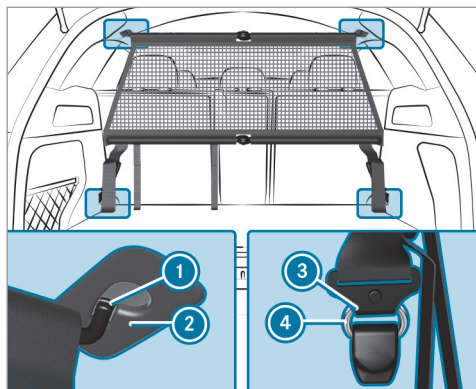

Partitioning net without cargo compartment enlargement

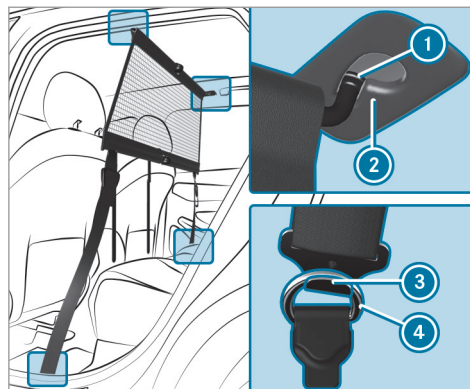

Partitioning net with cargo compartment enlargement

- ▶ Extend and unfold the partitioning net. The joints on the top and bottom guide rods will audibly engage.
- ▶ **To attach:** attach guide rod ① on the headliner to holders ②.

- ▶ Engage hooks ③ in tie-down eyes ④ on the left and right.
- ▶ Pull on the loose ends of the lashing straps until the partitioning net is tight.
- ▶ After driving a short distance, check the tension of the partitioning net and re-tension it if necessary.

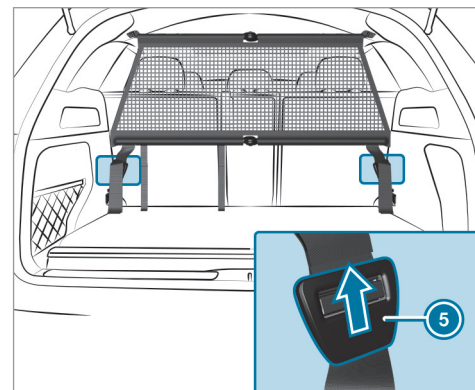

- ▶ **To remove:** pull belt clamp ⑤ upwards until the lashing straps are loose.
- ▶ Remove hooks ③ from tie-down eyes ④ on the left and right.
- ▶ Remove guide rod ① from holders ②.
- ▶ **To stow:** press the red buttons on the top and bottom guide rods.
- ▶ Collapse and roll up the partition net.

### Overview of the tie-down eyes

Observe the notes on loading the vehicle (→ page 106).

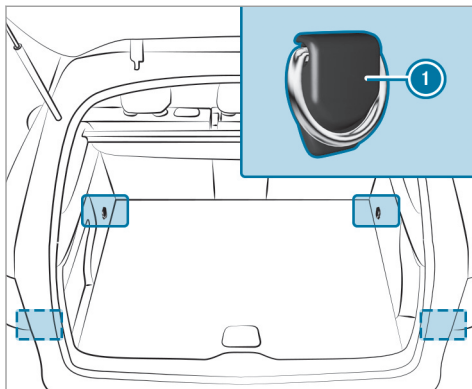

① Cargo tie-down rings

### Overview of bag hooks

**⚠ WARNING** Risk of injury when using bag hooks with heavy objects

The bag hooks cannot restrain heavy objects or items of luggage.

Objects or items of luggage could be thrown around and thereby hit vehicle occupants when braking or abruptly changing directions.

- ▶ Only hang light objects on the bag hooks.
- ▶ Never hang hard, sharp-edged or fragile objects on the bag hooks.

Observe the notes on loading the vehicle (→ page 106).

The bag hooks can bear a maximum load of 6.6 lbs (3 kg). Do not use them to secure a load.

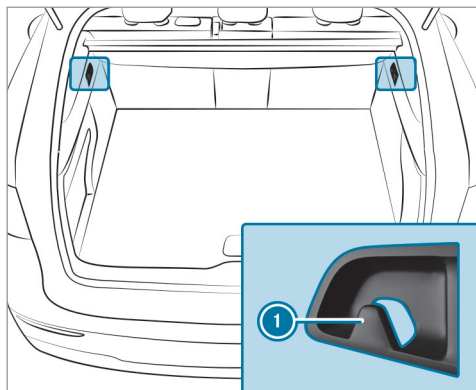

① Bag hook

### Overview of coat hooks on the tailgate

Observe the notes on loading the vehicle (→ page 106).

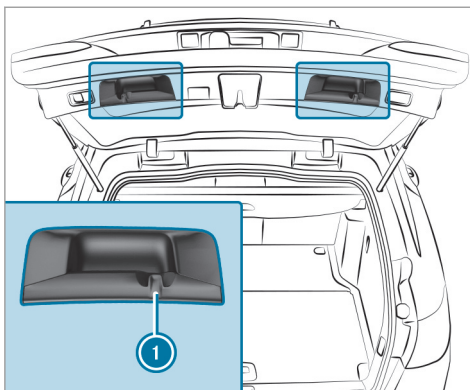

① Coat hook

Coat hooks are not suitable for hanging heavy objects as this can cause the tailgate to lower automatically. Use the coat hooks only for light objects such as jackets.

### Attaching the parcel net

**⚠ WARNING** Risk of injury due to objects being stowed incorrectly

If you do not adequately stow objects in the vehicle interior, they could slip or be tossed around and thereby strike vehicle occupants. In addition, cup holders, open stowage spaces and mobile phone brackets cannot always restrain the objects they contain in the event of an accident.

There is a risk of injury, particularly in the event of sudden braking or a sudden change in direction.

- ▶ Always stow objects in such a way that they cannot be tossed about in these or similar situations.
- ▶ Always make sure that objects do not project from stowage spaces, parcel nets or stowage nets.
- ▶ Close the lockable stowage spaces before starting a journey.

- ▶ Stow and secure objects that are heavy, hard, pointed, sharp-edged, fragile or too large in the cargo compartment.

Observe the notes on loading the vehicle.

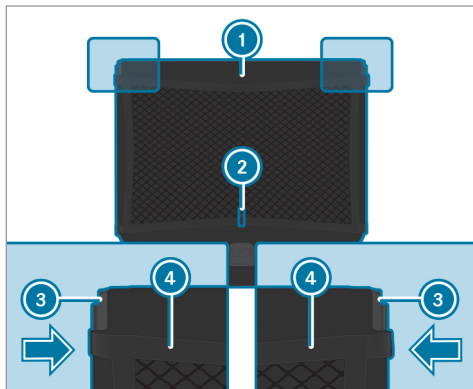

- ▶ Open cargo compartment floor (1), (→ page 119) swing it upwards to an angle

of around 45° and pull it out towards the rear.

- ▶ Put cargo compartment floor (1) down on a clean surface.
- ▶ Stretch the parcel net across cargo compartment floor (1).
- ▶ Make sure that:
  - The parcel net is centered on cargo compartment floor (1).
  - Rubber band (4) runs underneath fittings (3).
  - Tab (2) is facing forwards.

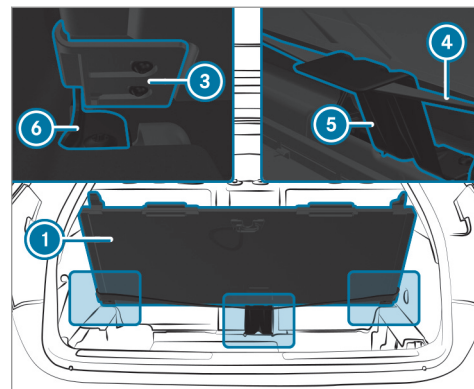

- ▶ Slide cargo compartment floor (1) into the cargo compartment horizontally until fittings (3) are in guides (6) on both sides.
- ▶ Swing cargo compartment floor (1) upwards to an angle of around 45° until fittings (3) audibly engage.
- ▶ Ensure that rubber band (4) runs underneath support (5).

- ▶ Fold cargo compartment floor ② down.
- ▶ Press cargo compartment floor ② down until it engages.

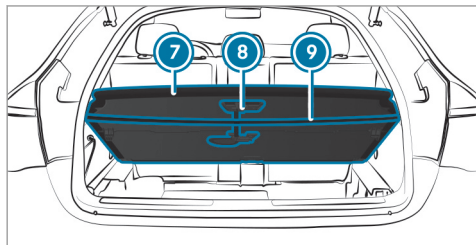

- ▶ Swing the cargo compartment floor down and fold out rear section ⑦.
  - ▶ Position rubber band ⑨ under fastener ⑧.
  - ▶ Fold down rear section ⑦ of cargo compartment floor ① and press it into the lock.
- ⓘ To avoid damaging the side trim in the cargo compartment, keep sufficient distance from the side trims in the cargo compartment when removing or inserting the cargo compartment floor.

### EASY-PACK load-securing kit

#### Notes on the snap-in module for the cargo compartment (telescopic rods)

The EASY-PACK load-securing kit allows you to use your cargo compartment for a variety of purposes. The components are located in the stowage space under the cargo compartment floor.

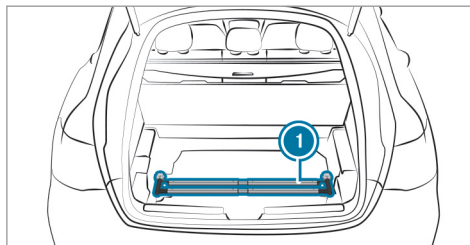

- ① Telescopic rod with mounting elements and holders

### Installing a telescopic rod

**⚠ WARNING** Risk of injury due to an open cargo compartment floor

If you drive when the cargo compartment floor is open, objects could be thrown around and thereby strike vehicle occupants. There is a risk of injury, particularly in the event of sudden braking or a sudden change in direction.



- ▶ Always close the cargo compartment floor before a journey.

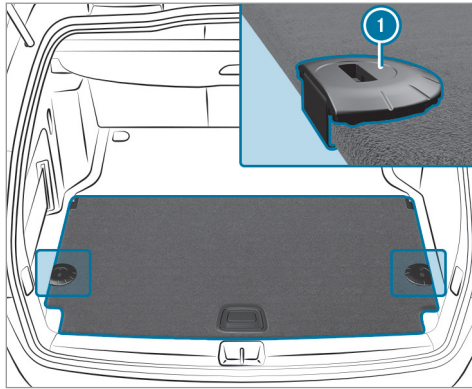

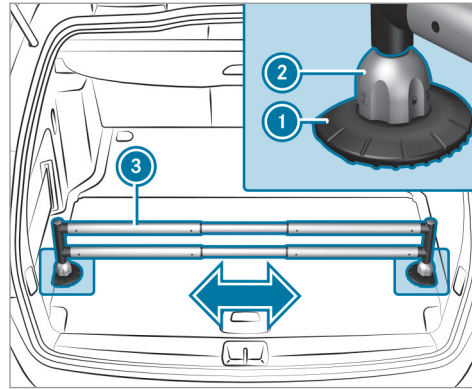

- ▶ Open the cargo compartment floor (→ page 119).
- ▶ Attach holders ① in the desired position to the side of the cargo compartment floor.
- ▶ Close the cargo compartment floor.



- ▶ Turn mounting elements ② to .
- ▶ Insert mounting elements ② into holders ①.
- ▶ Extend telescopic rod ③.
- ▶ Insert telescopic rod ③ into mounting elements ②.
- ▶ Turn both mounting elements ② to  until you feel them engage.

### Opening the stowage space under the cargo compartment floor

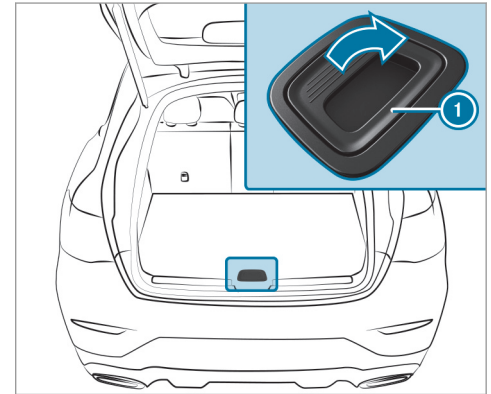

- ▶ **To open:** lift the cargo compartment floor with handle ① and fold it over at the hinge in the center of the cargo compartment floor.

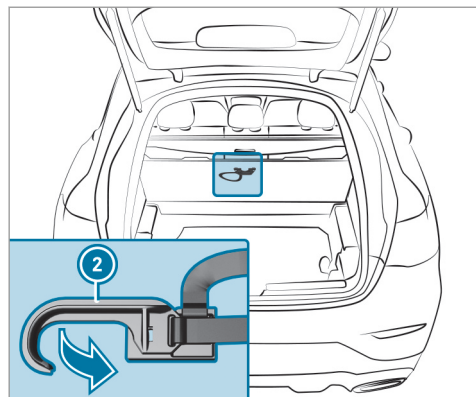

▶ Fold out hook ② on the underside of the cargo compartment floor.

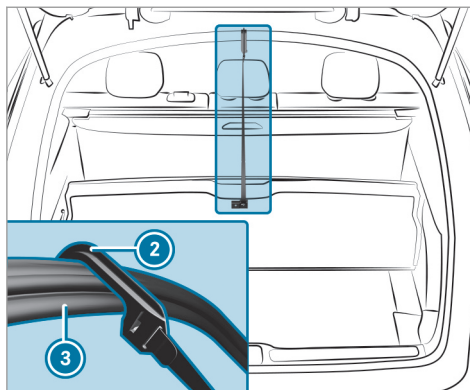

- ▶ Attach hook ② to top seal ③ of the cargo compartment.
- ▶ **To close:** remove hook ② from top seal ③ of the cargo compartment.
- ▶ Secure hook ② to the bracket on the underside of the cargo compartment floor.
- ▶ Fold the cargo compartment floor down.

### Locking and unlocking the cargo compartment floor

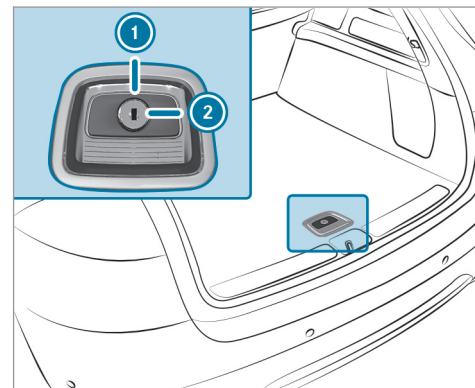

- ▶ Turn the emergency key a quarter turn clockwise ② (to lock) or counter-clockwise ① (to unlock).

### Attaching the roof carrier

**⚠ WARNING** Risk of injury if the maximum roof load is exceeded

When you load the roof, the center of gravity of the vehicle rises and the usual driving characteristics as well as the steering and braking characteristics change. During cornering, the vehicle tilts more strongly and may react more sluggishly to steering movements.

If you exceed the maximum roof load, the driving characteristics, as well as the steering and braking characteristics, will be greatly impaired.

- ▶ Always comply with the maximum roof load and adjust your driving style.

You will find information on the maximum roof load in the "Technical data" section.

**!** **NOTE** Damage to the panorama roof with power tilt/sliding panel caused by a non-approved roof rack

The panorama roof with power tilt/sliding panel may be damaged by the roof rack if you attempt to open it when using a roof rack that has not been tested and approved for Mercedes-Benz.

- ▶ When a roof rack is installed, open the panorama roof with power tilt/sliding panel only if the roof rack has been tested and approved for Mercedes-Benz.

In order to allow ventilation of the vehicle interior, you can raise the panorama roof with power tilt/sliding panel.

- ▶ Secure the roof rack to the roof railing.
- ▶ Observe the manufacturer's installation instructions.

### Cup holder

#### Installing the cup holder in or removing it from the center console (automatic transmission)

**⚠ WARNING** - Risk of accident or injury when using the cup holder while the vehicle is moving

The cup holder cannot secure containers while the vehicle is moving.

If you use a cup holder while the vehicle is moving, the container may be flung around and liquids may be spilled. The vehicle occupants may come into contact with the liquid and if it is hot, they could be scalded. You could be distracted from traffic conditions and you may lose control of the vehicle.

- ▶ Only use the cup holder when the vehicle is stationary.
- ▶ Only use the cup holder for containers of the right size.
- ▶ Close the container, particularly if the liquid is hot.

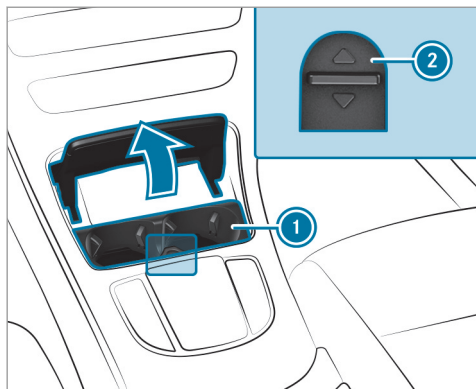

▶ **To remove:** slide catch ② forwards and pull out cup holder ①.

▶ **To install:** insert cup holder ① and slide back catch ②.

ⓘ The cup holder rubber mat can be removed for cleaning, e.g. using clean, lukewarm water.

### Opening or closing the cup holders in the rear armrest

❗ **NOTE** Damage to the rear armrest due to body weight

When folded out, the rear armrest can be damaged by body weight.

▶ Do not sit or support yourself on the rear seat armrest.

❗ **NOTE** Damage to the cup holder

When the rear armrest is folded back the cup holder could become damaged.

▶ Only fold the rear armrest back when the cup holder is closed.

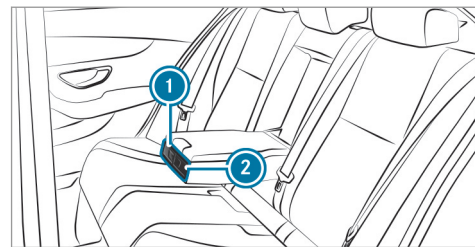

▶ **To open:** press cup holder ① or ②. Cup holder ① or ② will extend automatically.

▶ **To close:** push cup holder ① or ② back until it engages.

### Ashtray and cigarette lighter

#### Using the ashtray in the front center console

**!** **NOTE** Damage to the stowage compartment under the ashtray due to intense heat

The stowage compartment under the ashtray is not heat resistant and could be damaged if you rest a lit cigarette on it.

- ▶ Make sure that the ashtray is fully engaged.

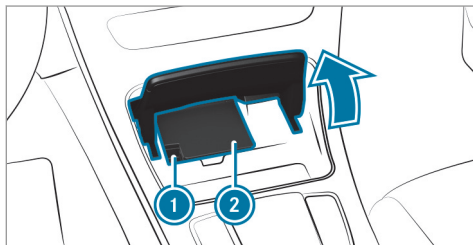

- ▶ **To open:** push up cover ② of the ashtray on its right or left side.
- ▶ **To remove the insert:** press insert ① forwards slightly and pull it out upwards.
- ▶ **To re-install the insert:** press insert ① into the holder until it engages.

#### Using the ashtray in the door stowage compartment

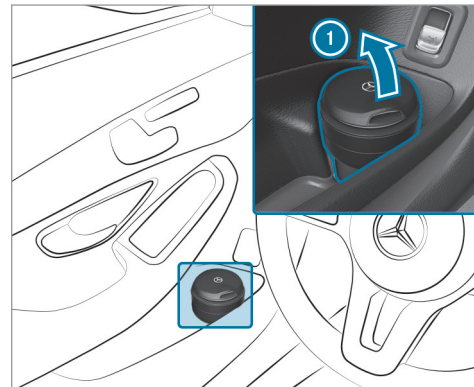

- ▶ **During a journey:** place the closed ashtray in the front door stowage compartment while the vehicle is in motion.
- ▶ Check that it is seated firmly.
- ▶ Comply with the notes on loading the vehicle (→ page 106).

▶ **To open:** fold lid ① upwards.

- ① Twist the top part of the ashtray to remove it for cleaning, e.g. with clean, lukewarm water, or for emptying.

### Using the cigarette lighter in the front center console

**⚠ WARNING** - Risk of fire and injury from hot cigarette lighter

You can burn yourself if you touch the hot heating element or the socket of the cigarette lighter.

In addition, flammable materials may ignite if:

- you drop the hot cigarette lighter
- a child holds the hot cigarette lighter to objects, for example

- ▶ Always hold the cigarette lighter by the knob.
- ▶ Always make sure that the cigarette lighter is out of reach of children.

▶ Never leave children unattended in the vehicle.

#### Requirements:

- The ignition is switched on.

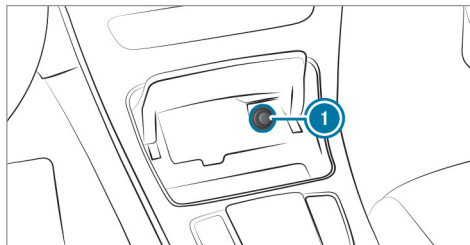

- ▶ Press in cigarette lighter ①. The cigarette lighter will pop out automatically when the heating element is red-hot.

### Using the cigarette lighter in the rear passenger compartment

#### Requirements:

- The ignition is switched on.

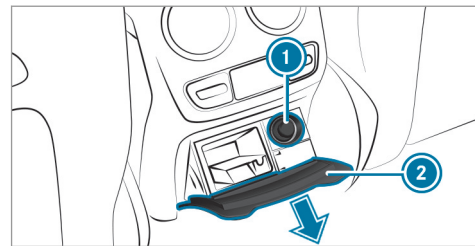

- ▶ **To open:** pull cover ② out by its top handle edge.
- ▶ Press in cigarette lighter ①. The cigarette lighter will pop out automatically when the heating element is red-hot.

### Sockets

#### Using the 12 V socket in the rear passenger compartment

#### Requirements:

- Only connect devices up to a maximum of 180 W (15 A).

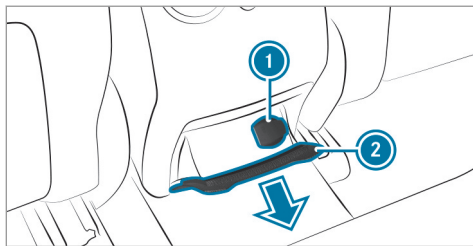

- ▶ Pull cover ② out by its top handle edge.
- ▶ Fold up the cap of socket ①.

### Using the 12 V socket in the front passenger footwell

#### Requirements:

- Only connect devices up to a maximum of 180 W (15 A).

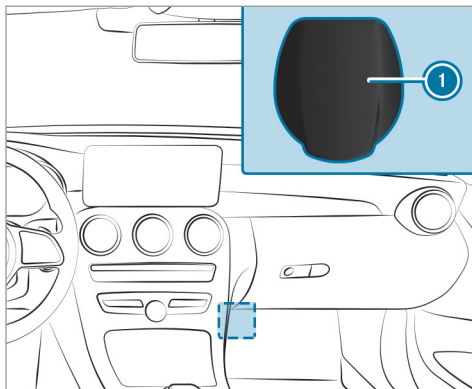

- ▶ Lift up socket cap ①.
- ▶ Make sure that no cables are running through or secured in the airbag deployment area when using the socket. Also observe the notes on airbag protection (→ page 41).

### Using the 115 V socket in the rear passenger compartment

**⚠ DANGER** Risk of fatal injury due to damaged connecting cables or sockets

If a suitable device is connected, the 115 V socket will be carrying a high voltage. If the connecting cable or the 115 V socket is pulled out of the trim or is damaged or wet, you could receive an electric shock.

- ▶ Only use dry and damage-free connecting cables.
- ▶ When the ignition is switched off, ensure that the 115 V socket is dry.
- ▶ If the 115 V socket is damaged or gets pulled out of the paneling, immediately have the socket checked or replaced at a qualified specialized workshop.
- ▶ Never plug the connecting cable into a 115 V socket that is damaged or has been pulled out of the trim.

**⚠ DANGER** Risk of fatal injury due to incorrect handling of the socket

You could receive an electric shock:

- if you reach into the socket.
- if you insert unsuitable devices or objects into the socket.

- ▶ Do not reach into the socket.
- ▶ Only connect suitable devices to the socket.

**Requirements:**

- Devices are equipped with a suitable plug which conforms to the standards specific to the country you are in.
- A device up to a maximum of 150 W is used.
- Do not use multiple socket outlets.

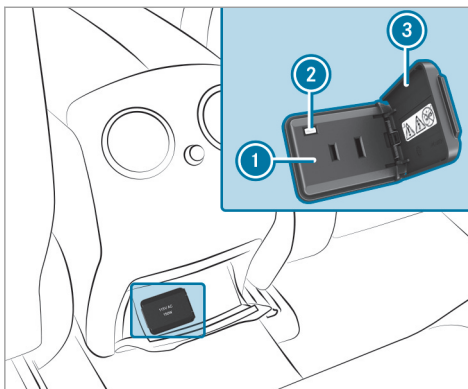

- ▶ Open flap ③.
- ▶ Insert the plug of the device into 115 V socket ①.  
When the on-board electrical system voltage is sufficient, indicator lamp ② lights up.

**Using the 12 V socket in the cargo compartment**

**Requirements:**

- Only connect devices up to a maximum of 180 W (15 A).

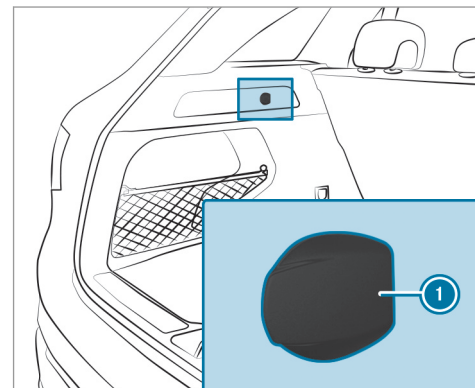

- ▶ Lift up cap ① of the socket and insert the plug of the device.



### USB port in the rear passenger compartment

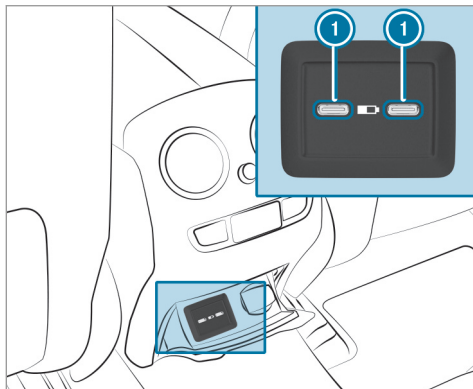

You can charge a USB device, e.g. a mobile phone, at USB ports ① using a suitable charging cable.

The devices can be charged with 5 V (up to 3 A) and when the ignition is switched on.

### Wireless charging of the mobile phone and connection with the exterior antenna

#### Notes on wirelessly charging the mobile phone

**⚠ WARNING** Risk of injury due to objects being stowed incorrectly

If objects in the vehicle interior are stowed incorrectly, they can slide or be thrown around and hit vehicle occupants. In addition, cup holders, open stowage spaces and mobile phone receptacles cannot always retain all objects they contain.

There is a risk of injury, particularly in the event of sudden braking or a sudden change in direction.

- ▶ Always stow objects so that they cannot be thrown around in such situations.
- ▶ Always make sure that objects do not protrude from stowage spaces, luggage nets or stowage nets.

- ▶ Close the lockable stowage spaces before starting a journey.
- ▶ Always stow and secure heavy, hard, pointed, sharp-edged, fragile or bulky objects in the trunk/load compartment.

Observe the notes on loading the vehicle.

**⚠ WARNING** Risk of fire from placing objects in the mobile phone stowage compartment

There is a risk of fire, in particular, if you place more than one mobile phone in the mobile phone stowage compartment.

- ▶ Apart from a mobile phone, do not place any other objects in the mobile phone stowage compartment, especially those made of metal.

**!** **NOTE** Damage to objects caused by placing them in the mobile phone stowage compartment

If objects are placed in the mobile phone stowage compartment, they may be damaged by electromagnetic fields.

- ▶ Do not place credit cards, storage media or other objects sensitive to electromagnetic fields in the mobile phone stowage compartment.

**!** **NOTE** Damage to the mobile phone stowage compartment caused by liquids

If liquids enter the mobile phone stowage compartment, the compartment may be damaged.

- ▶ Ensure that no liquids enter the mobile phone stowage compartment.

- Depending on the vehicle equipment, the mobile phone is connected to the vehicle's exterior antenna via the charging module.

- The charging function and wireless connection of the mobile phone to the vehicle's exterior antenna are only available if the ignition is switched on.
- Small mobile phones may not be able to be charged in every position of the mobile phone stowage compartment.
- Large mobile phones which do not rest flat in the mobile phone stowage compartment may not be able to be charged or connected with the vehicle's exterior antenna.
- The mobile phone may heat up during the charging process. This may particularly depend on the applications (apps) currently open in the background.
- To ensure more efficient charging and connection with the vehicle's exterior antenna, remove the protective cover from the mobile phone. Protective covers which are necessary for wireless charging are excluded.

### Wirelessly charging a mobile phone

#### Requirements:

- The mobile phone is suitable for wireless charging. You can find a list of compatible mobile phones at:

<https://www.mercedes-benz-mobile.com>

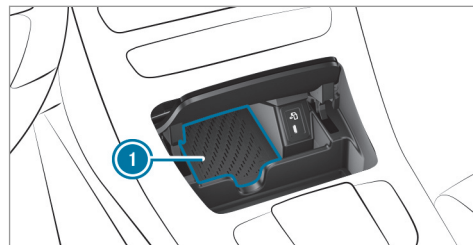

- ▶ Place the mobile phone as close to the center of mat **1** as possible with the display facing upwards. When a message is shown in the multimedia system, the mobile phone is being charged. Malfunctions during the charging process are shown in the media display.
- i** The mat can be removed by the tab for cleaning, e.g. using clean, lukewarm water.

### Installing/removing the floor mats

**⚠ WARNING** Risk of accident due to objects in the driver's footwell

Objects in the driver's footwell may impede pedal travel or block a depressed pedal.

This jeopardizes the operating and road safety of the vehicle.

- ▶ Stow all objects in the vehicle securely so that they cannot get into the driver's footwell.
- ▶ Always install the floor mats securely and as prescribed in order to ensure that there is always sufficient room for the pedals.
- ▶ Do not use loose floor mats and do not place floor mats on top of one another.

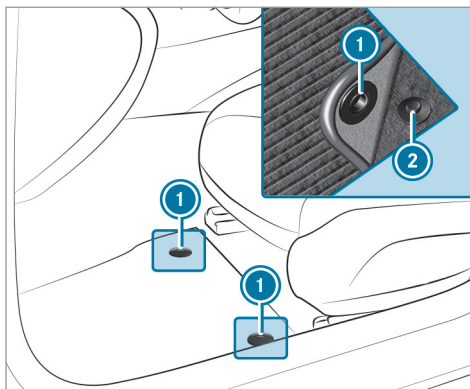

- ▶ **To install:** slide the corresponding seat backwards and lay the floor mat in the footwell.
- ▶ Press studs ① onto holders ②.
- ▶ Adjust the corresponding seat.
- ▶ **To remove:** pull the floor mat off holders ②.
- ▶ Remove the floor mat.

## Exterior lighting

### Information about lighting systems and your responsibility

The various lighting systems of the vehicle are only aids. The driver of the vehicle is responsible for correct vehicle illumination in accordance with the prevailing light and visibility conditions, legal requirements and traffic situation.

## Light switch

### Operating the light switch

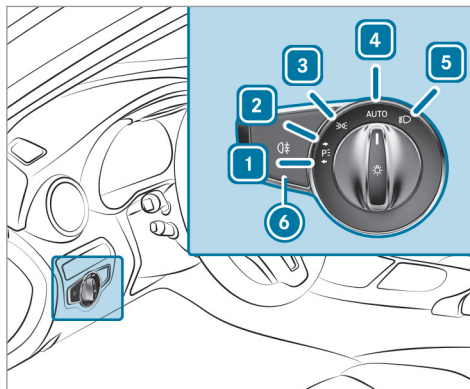

- 1 Left standing light
- 2 Right standing light
- 3 Parking lights and license plate lamp
- 4 **AUTO** Automatic driving lights (preferred light switch position)

- 5 Low beam/high beam
- 6 Switches the rear fog light on or off

When low beam is activated, the indicator lamp for the parking lights is deactivated and replaced by the low beam indicator lamp.

▶ Always park your vehicle safely using sufficient lighting, in accordance with the relevant legal stipulations.

**!** **NOTE** Battery discharging by operating the standing lights

Operating the standing lights over a period of hours puts a strain on the battery.

▶ Where possible, switch on the right or left parking light.

In the case of severe battery discharging, the standing lights or parking lights are automatically switched off to facilitate the next engine start.

The exterior lighting (except standing and parking lights) switches off automatically when the driver's door is opened.

- Observe the notes on surround lighting (→ page 135).

### Automatic driving lights function

The parking lights, low beam and daytime running lamps are switched on automatically depending on the ignition status and the ambient light.

**⚠ WARNING** Risk of accident when the low beam is switched off in poor visibility

When the light switch is set to **AUTO**, the low beam may not be switched on automatically if there is fog, snow or other causes of poor visibility such as spray.

- ▶ In such cases, turn the light switch to .

The automatic driving lights are only an aid. You are responsible for vehicle lighting.

### Switching the rear fog lights on or off

#### Requirements:

- The light switch is in the  or **AUTO** position.

- ▶ Press the  button.

Please observe the country-specific laws on the use of rear fog lamps.

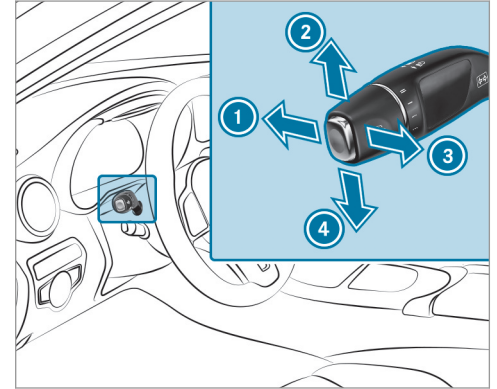

### Operating the combination switch for the lights



- ① High-beam headlamps
- ② Turn signal indicator, right
- ③ High-beam flasher
- ④ Turn signal indicator, left

- ▶ Use the combination switch to activate the desired function.

### High-beam headlamps

- ▶ **To switch on:** turn the light switch to the  or **AUTO** position.
- ▶ Press the combination switch beyond the point of resistance in the direction of arrow ①.  
When the high beam is activated, the  indicator lamp for low beam is deactivated and replaced by the  indicator lamp for the high beam.
- ▶ **To switch off:** move the combination switch back to its starting position.

### High-beam flasher

- ▶ Pull the combination switch in the direction of arrow ③.

### Turn signal lights

- ▶ **To indicate briefly:** press the combination switch briefly to the point of resistance in the direction of arrow ② or ④.  
The corresponding turn signal indicator will flash three times.

- ▶ **To indicate permanently:** press the combination switch beyond the point of resistance in the direction of arrow ② or ④.

Vehicles with Active Lane Change Assist:

- Indicator operation activated by the driver can extend for the duration of the lane change.
- If the driver indicated directly beforehand but a lane change was not immediately possible, the turn signal indicator may activate automatically.

### Activating/deactivating the hazard warning lamps

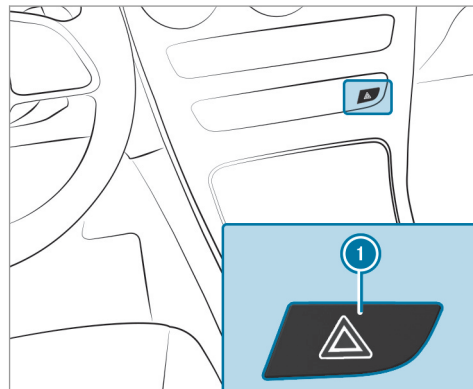

- ▶ Press button ①.

The hazard warning lamps will switch on automatically if:

- the airbag has been deployed.

## Cornering light

### Cornering light function

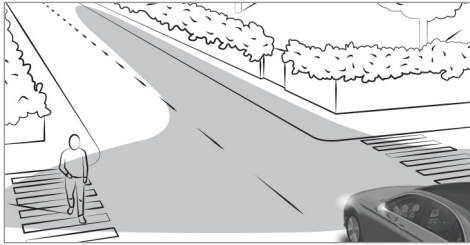

The cornering light function improves the illumination of the roadway over a wide angle in the turning direction, enabling better visibility on tight bends, for example. It can be activated only when the low beam is switched on.

The function is active in the following cases:

- At speeds below 25 mph (40 km/h) when the turn signal indicator is switched on or the steering wheel is turned

- At speeds between 25 mph (40 km/h) and 45 mph (70 km/h) when the steering wheel is turned

**Traffic circle and intersection function:** the cornering light will be activated on both sides based on an evaluation of the current GPS position of the vehicle. It will remain active until after the vehicle has left the traffic circle or the intersection.

## Adaptive Highbeam Assist

### Adaptive Highbeam Assist function

**⚠ WARNING** Risk of accident despite Adaptive Highbeam Assist

Adaptive Highbeam Assist does not recognize the following road users:

- Road users without lights, e.g. pedestrians
- Road users with poor lighting, e.g. cyclists

- Road users whose lighting is obstructed, e.g. by a barrier

On very rare occasions, Adaptive Highbeam Assist may fail to recognize other road users with their own lighting, or may recognize them too late.

In these or similar situations, the automatic high beam is not deactivated or is activated despite the presence of other road users.

- ▶ Always observe the traffic carefully and switch off the high beam in good time.

Adaptive Highbeam Assist cannot take into account road, weather or traffic conditions.

Detection may be restricted in the following cases:

- In poor visibility, e.g. fog, heavy rain or snow
- If there is dirt on the sensors or the sensors are obscured

Adaptive Highbeam Assist is only an aid. You are responsible for adjusting the vehicle's lighting to the prevailing light, visibility and traffic conditions.

## 134 Light and visibility

- i** Adaptive Highbeam Assist is available only in vehicles with LED high performance headlamps.

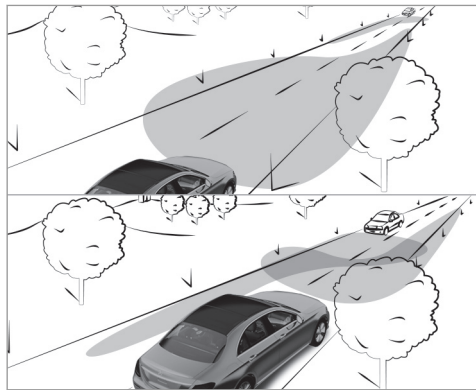

The Adaptive Highbeam Assist automatically switches between the following types of light:

- Low-beam headlamps
- High-beam headlamps

At speeds greater than 19 mph (30 km/h):

- If no other road users are detected, the high beam will be switched on automatically.

The high beam switches off automatically in the following cases:

- At speeds below 16 mph (25 km/h).
- If other road users are detected.
- If street lighting is sufficient.

At speeds greater than approximately 31 mph (50 km/h):

- The headlamp range of the low beam is regulated automatically based on the distance to other road users.

The system's optical sensor is located behind the windshield near the overhead control panel.

### Switching Adaptive Highbeam Assist on/off



- ▶ To switch on:** turn the light switch to the **AUTO** position.

- ▶** Switch on the high beam using the combination switch.  
When the high beam is switched on automatically in the dark, the  indicator lamp on the multifunction display comes on.
- ▶ To switch off:** switch off the high beam using the combination switch.

### Switching the daytime running lamps on/off

Multimedia system:

-  **▶▶ Settings ▶▶ Light**  
**▶▶ Daytime Run. Lights**

- ▶** Activate  or deactivate  the function.

### Setting the exterior lighting switch-off delay time

**Requirements:**

- The light switch is in the **AUTO** position.



Multimedia system:

→  » Settings » Light  
» Exterior Lighting Delay

- ▶ Set the switch-off delay time.  
The exterior lighting is activated for the set time when the vehicle is parked.

### Switching the surround lighting on/off

Multimedia system:

→  » Settings » Light  
» Locator Lighting

When **Locator Lighting** is active, the exterior lighting lights up for 40 seconds after the vehicle is unlocked. When you start the vehicle, the surround lighting is deactivated and the automatic driving lights are activated.





- ▶ Activate or deactivate the function.

## Interior lighting

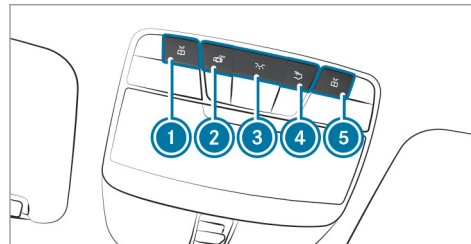
### Adjusting the interior lighting

#### Front overhead control panel



- ①  Front left reading lamp
- ②  Automatic interior lighting control
- ③  Front interior lighting
- ④  Rear interior lighting
- ⑤  Front right reading lamp

- ▶ **To switch on or off:** press button ① - ⑤ accordingly.

#### Control panel in the grab handle

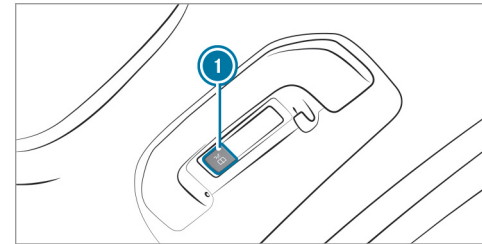

- ①  Rear passenger compartment reading lamp

- ▶ **To switch on or off:** press button ①.

### Adjusting the ambient lighting

Multimedia system:

→  » Comfort » Ambient Lighting

#### Setting the color

- ▶ Select **Color**.
- ▶ Set the desired color.

 There are 64 colors available.

### Adjusting the brightness

- ▶ Select **Brightness**.
- ▶ Adjust the brightness.

### Activating the brightness for zones

- ▶ Select **Brightness**.
- ▶ Select **Brightness Zones**.
- ▶ Activate or deactivate the function.  
The **ACCENT**, **AMBIANCE** and **VENTS** zones can be set separately.

### Activating multi-colored lighting

- ▶ Select **Color**.
- ▶ Select **Multi-color**.  
There are ten preset color combinations available.
- ▶ Select a color combination.

### Activating multi-colored animation

- ▶ Select **Color**.

- ▶ Select **Multi-color Animation**.  
The chosen color combination will change at predefined intervals.

### Activating welcome lighting

- ▶ Select **Color**.
- ▶ Select **Welcome**.  
When the vehicle is unlocked, a special ambient lighting sequence will run.

### Activating dependency on air conditioning settings

- ▶ Select **Color**.
- ▶ Select **Climate**.  
If changes are made to the temperature setting in the vehicle, the color of the ambient lighting will change briefly.

### Switching the interior lighting switch-off delay time on/off

---

Multimedia system:

 ▶▶ Settings ▶▶ Light  
▶▶ Interior Lighting Delay

- ▶ Switch the lighting switch-off delay time on or off.  
When this function is active, the interior lighting is lit up for short time after the vehicle has been locked.

## Windshield wiper and windshield washer system

### Switching the windshield wipers on/off

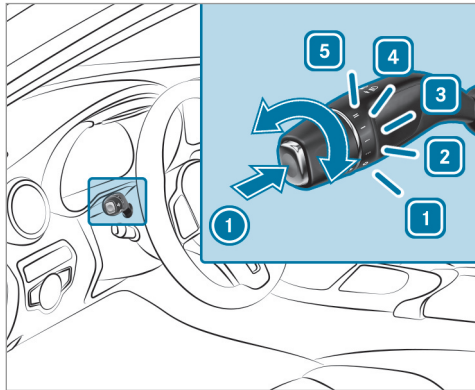

- 1 0 Windshield wipers off
- 2 ... Intermittent wiping, normal
- 3 .... Intermittent wiping, frequent



- 4 — Continuous wiping, slow
- 5 == Continuous wiping, fast

- ▶ Turn the combination switch to the correct position 1 - 5.
- ▶ **Single wipe/washing:** push the button on the combination switch in the direction of arrow 1.
  - Single wipe
  - Wipes with washer fluid

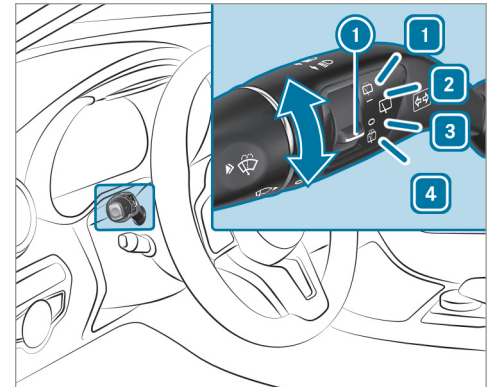
### Switching the rear window wiper on/off



- 1 Wipes with washer fluid
- 2 — Switches on intermittent wiping
- 3 0 Switches off intermittent wiping
- 4 Wipes with washer fluid

- ▶ Turn  switch ① to the correct position ① - ④.  
The  symbol will appear on the instrument cluster when the rear window wiper is switched on.

### Changing the windshield wiper blades

**⚠ WARNING** Risk of becoming trapped if the windshield wipers are switched on while wiper blades are being replaced

If the windshield wipers begin to move while you are changing the wiper blades, you can be trapped by the wiper arm.

- ▶ Always switch off the windshield wipers and the ignition before changing the wiper blades.

### Moving the wiper arms to the replacement position

- ▶ Switch the ignition on and switch off again immediately.

- ▶ Within around 15 seconds, press the  button on the combination switch for approximately three seconds (→ page 137). The wiper arms will move into the replacement position.

### Removing the wiper blades

- ▶ Fold the wiper arms away from the windshield.

- ▶ Hold the wiper arm with one hand. With the other hand, turn the wiper blade in the direction of arrow ① away from the wiper arm as far as it will go.
- ▶ Slide catch ② in the direction of arrow ③ until it engages in the removal position.
- ▶ Remove the wiper blade from the wiper arm in the direction of arrow ④.

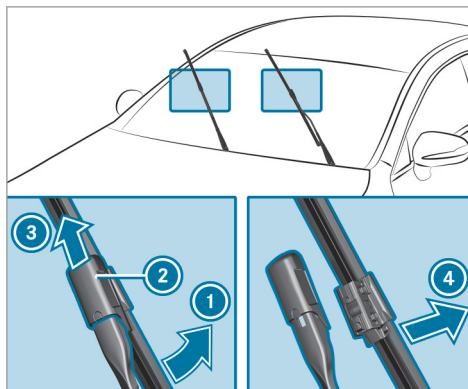

## Installing the wiper blades

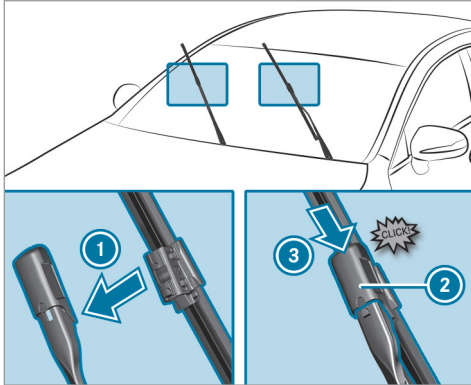

- ▶ Insert the new wiper blade into the wiper arm in the direction of arrow ①.
- ▶ Slide catch ② in the direction of arrow ③ until it engages in the locking position.
- ▶ Make sure that the wiper blade is seated correctly.

- ▶ Fold the wiper arms back onto the windshield.
- ▶ Switch on the ignition.
- ▶ Press the  button on the combination switch (→ page 137). The wiper arms will move into the original position.

## Maintenance display

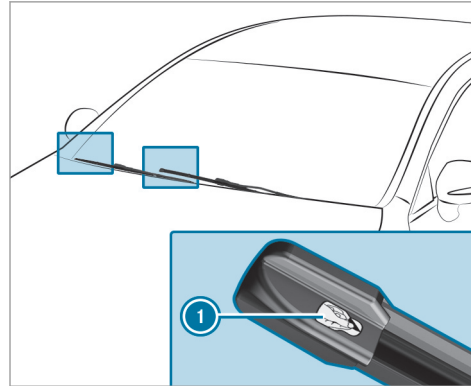

- ▶ Remove protective film ① from the maintenance display on the tip of the newly installed wiper blades.

If the color of the maintenance display changes from black to yellow, the wiper blades should be replaced.

- ① The duration until the color changes varies depending on the usage conditions.

## Replacing the rear window wiper blade

**⚠ WARNING** Risk of becoming trapped if the windshield wipers are switched on while wiper blades are being replaced

If the windshield wipers begin to move while you are changing the wiper blades, you can be trapped by the wiper arm.

- ▶ Always switch off the windshield wipers and the ignition before changing the wiper blades.

## Removing the wiper blade

- ▶ Switch the ignition off.

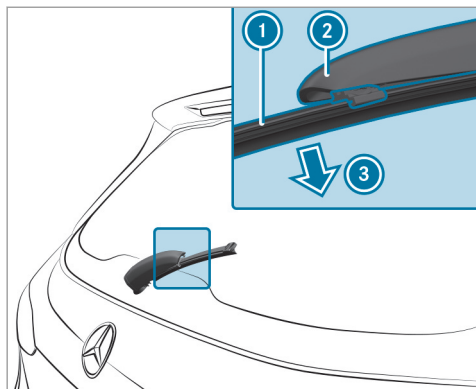

- ▶ Fold wiper arm ② away from the rear window until it engages in the replacement position.
- ▶ Unclip wiper blade ① from wiper arm ② and remove it in the direction of arrow ③.

### Installing the wiper blade

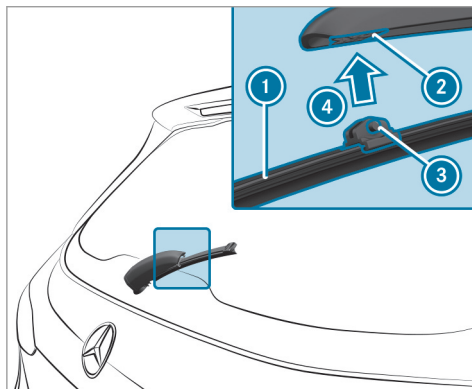

- ▶ Position wiper blade ① with both lugs ③ on holder ② on the wiper arm.
- ▶ Push wiper blade ① in the direction of arrow ④ until it engages in holder ②.
- ▶ Make sure that wiper blade ① is seated correctly.

- ▶ Fold the wiper arm from the replacement position back onto the rear window.

## Mirrors

### Operating the outside mirrors

**⚠ WARNING** Risk of injury from adjusting the vehicle settings while the vehicle is in motion

You could lose control of the vehicle in the following situations:

- if you adjust the driver's seat, the head restraint, the steering wheel or the mirror while the vehicle is in motion
  - if you fasten your seat belt while the vehicle is in motion
- ▶ Before starting the engine: adjust the driver's seat, the head restraint, the steering wheel or the mirror and fasten your seat belt.

**⚠ WARNING** Risk of accident due to misjudgment of distances when using the passenger mirror

The outside mirror on the front-passenger side reflects objects on a smaller scale. The objects in view are in fact closer than they appear.

As a result, you may misjudge the distance between you and the road user driving behind you, for example, when changing lanes.

- ▶ Therefore, always look over your shoulder in order to ensure that you are aware of the actual distance between you and the road users driving behind you.

### Folding the outside mirrors in/out

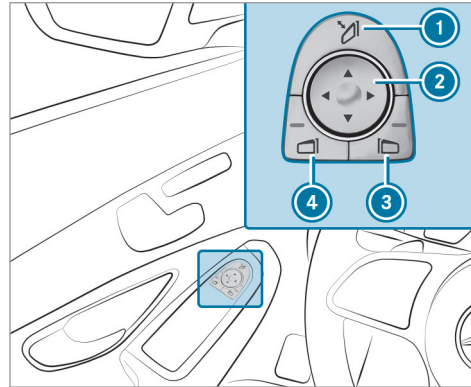

- ▶ Briefly press button ①.

### Resetting the outside mirrors

- ① If the battery has been disconnected or completely discharged, the outside mirrors must be reset. Only then will the automatic mirror folding function work properly.
- ▶ Briefly press button ①.

### Adjusting the outside mirrors

- ▶ Press button ③ or ④ to select the outside mirror to be adjusted.
- ▶ Press button ② to adjust the position of the mirror glass.

### Engaging the outside mirrors

- ▶ **Vehicles without electrically folding outside mirrors:** manually move the outside mirror into the correct position.
- ▶ **Vehicles with electrically folding outside mirrors:** press and hold button ①. You will hear a click and the mirror will audibly engage in position. The outside mirror will now be set to the correct position.

### Automatic anti-glare mirrors function

**⚠ WARNING** Risk of acid burns and poisoning due to the anti-glare mirror electrolyte

Electrolyte may escape if the glass in an automatic anti-glare mirror breaks.

The electrolyte is hazardous to health and causes irritation. It must not come into contact with your skin, eyes, respiratory organs or clothing or be swallowed.

- ▶ If you come into contact with electrolyte, observe the following:
  - Immediately rinse the electrolyte from your skin with water and seek medical attention.
  - If electrolyte comes into contact with your eyes, immediately rinse them thoroughly with clean water and seek medical attention.
  - If the electrolyte is swallowed, immediately rinse your mouth out thoroughly. Do not induce vomiting. Seek medical attention immediately.
  - Immediately change out of clothing which has been contaminated with electrolyte.
  - If an allergic reaction occurs, seek medical attention immediately.

The inside rearview mirror and the outside mirror on the driver's side will automatically go into anti-glare mode if light from a headlamp hits the sensor on the inside rearview mirror.

#### System limits

The system will not go into anti-glare mode if:

- The engine is switched off.
- Reverse gear is engaged.
- The interior lighting is switched on.

#### Front-passenger outside mirror parking position function

- ❗ The parking position is available only in vehicles with a memory function.

The parking position makes parking easier.

The front-passenger outside mirror will swivel downwards in the direction of the rear wheel on the front passenger's side when:

- The parking position is stored (→ page 143).
- The front-passenger mirror is selected.
- Reverse gear is engaged.

The front-passenger outside mirror will move back to its original position when:

- You shift the transmission to another transmission position.
- You are traveling at a speed greater than 9 mph (15 km/h).
- You press the button for the outside mirror on the driver's side.



### Storing the parking position of the front-passenger outside mirror using reverse gear

#### Storing

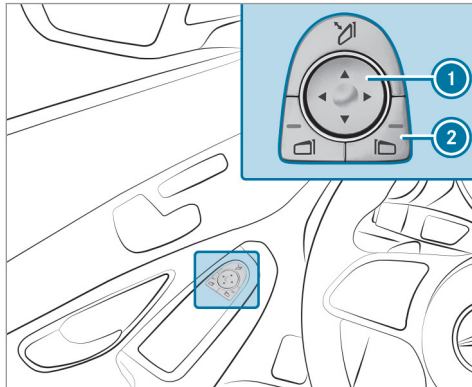

- ▶ Select the front-passenger outside mirror using button ②.
- ▶ Engage reverse gear.
- ▶ Move the front-passenger outside mirror into the desired parking position using button ①.

#### Calling up

- ▶ Select the front-passenger outside mirror using button ②.
- ▶ Engage reverse gear.  
The front-passenger outside mirror will move into the stored parking position.

### Activating/deactivating the automatic mirror folding function

Multimedia system:

- ▶  Settings ▶ Quick Access
- ▶ Switch **Automatic Folding** on or off.

### Operating the sun visors

#### Using the single sun visor

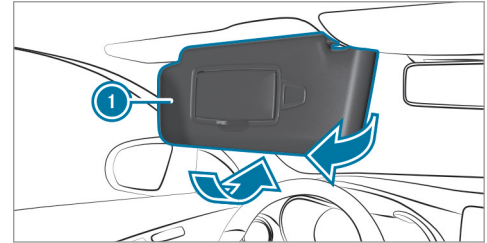

- ▶ **Glare from the front:** fold sun visor ① down.
- ▶ **Glare from the side:** swing sun visor ① to the side.

## 144 Light and visibility

---

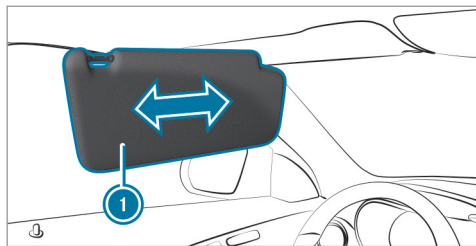

- ▶ Vehicles with an extendable sun visor: slide sun visor ① horizontally as required.

## Overview of climate control systems

### Notes on climate control

An interior air filter in combination with the pre-filter in the engine compartment must always be used so that the air conditioning system, pollution level monitoring and the air filtration work correctly. Make sure that the filter is installed correctly and the filter housing in the engine compartment is closed correctly using the cap and always tightly sealed when in operation. Use filters recommended and approved by Mercedes-Benz. Always have service work carried out at a qualified specialist workshop.

### Overview of the control panel for dual-zone automatic climate control

The indicator lamps on the buttons indicate that the corresponding function is activated.

**Plug-in hybrid:** be sure to observe the notes in the Supplement. Otherwise, you may not recognize dangers.

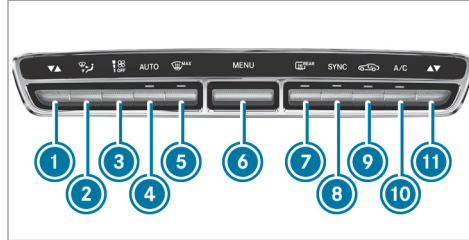

- ① Sets the temperature, left
- ② Sets the air distribution
- ③ Sets the airflow or switch off climate control
- ④ **AUTO** Sets climate control to automatic mode (→ page 147)
- ⑤ Defrosts the windshield
- ⑥ **MENU** Calls up the air conditioning menu
- ⑦ Switches the rear window heater on/off
- ⑧ **SYNC** Activates or deactivates synchronization (→ page 148)
- ⑨ Switches air-recirculation mode on/off (→ page 148)

- ⑩ Switches the A/C function on/off (→ page 146)
- ⑪ Sets the temperature, right





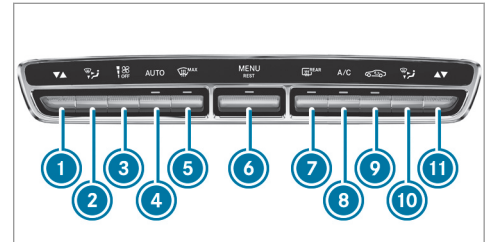

### Overview of the control panel for 3-zone automatic climate control

The indicator lamps on the buttons indicate that the corresponding function is activated.

**Plug-in hybrid:** be sure to observe the notes in the Supplement. Otherwise, you may fail to recognize dangers.



- ① Sets the temperature, left
- ② Sets the air distribution, left

- ③  Sets the airflow or switches off climate control
- ④ **AUTO** Sets climate control to automatic mode (→ page 147)
- ⑤  Defrosts the windshield
- ⑥  Calls up the air conditioning menu  
Switches the residual heat on or off (→ page 148)
- ⑦  Switches the rear window heater on/off
- ⑧ **A/C** Switches the A/C function on/off (→ page 146)
- ⑨  Switches air-recirculation mode on/off (→ page 148)
- ⑩  Sets the air distribution, right
- ⑪  Sets the temperature, right

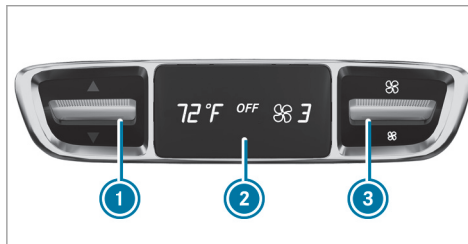

### Rear operating unit



- ① Sets the temperature
- ② Display
- ③ Sets the airflow

### Operating the climate control system

#### Switching climate control on/off

- ▶ **To switch on:** set the airflow to level 1 or higher using the  button.
- ▶ **To switch off:** set the airflow to level 0 using the  button.

- ⓘ If climate control is switched off, the windows may fog up more quickly. Switch off climate control only briefly.

#### Switching the A/C function on or off via the control panel

The A/C function heats, cools and dehumidifies the vehicle's interior air.

- ▶ Press the  button.

Switch off the A/C function only briefly; otherwise, the windows may fog up more quickly.

Condensation may drip from the underside of the vehicle when cooling mode is active. This is not a sign that there is a malfunction.

#### Calling up the air conditioning menu

##### Calling up the air conditioning menu using the multimedia system

- ▶ Select one of the temperature displays at the lower edge of the media display.

### Calling up the air conditioning menu using the button on the control panel

- ▶ Press the **MENU** button on the control panel.
- ⓘ The button on the control panel is not available on all equipment variants. In this case, the air conditioning menu can only be called up using the multimedia system.



### Activating/deactivating the A/C function via the multimedia system

The A/C function heats, cools and dehumidifies the vehicle's interior air.

- ▶ Call up the air conditioning menu (→ page 146).
- ▶ Select **First Row of Seats**.
- ▶ Select **A/C**.  
Depending on the previous status, the function is activated or deactivated.

### Setting climate control to automatic mode

In automatic mode, the set temperature is controlled and maintained at a constant level by the air supply.

- ▶ Press the **AUTO** button.
- ▶ **To switch to manual mode:** press the  or  button.

### Climate style

#### Climate style function

In automatic mode, you can select the following climate style settings for the driver's and front passenger areas:

- **FOCUS:** high airflow, slightly cooler setting
- **MEDIUM:** medium airflow, standard setting
- **DIFFUSE:** low airflow, slightly warmer and draft-free setting









#### Adjusting the climate mode settings

- ▶ Call up the air conditioning menu (→ page 146).

- ▶ Select **First Row of Seats** or **Second Row of Seats**.
- ▶ Call up the **CLIMATE MODE** menu.
- ▶ Select a climate style.



### Overview of the air distribution settings

The symbols on the display indicate which vents the airflow is being directed through:

-  defroster vents
-  center and side air vents
-  footwell vents
-  center, side and footwell vents
-  defroster and footwell vents
-  all vents
-  defroster, middle and side air vents
-  automatic air distribution

### Setting the air distribution

- ▶ Call up the air conditioning menu (→ page 146).

- ▶ Select **First Row of Seats** or **Second Row of Seats**.
- ▶ **To set the air distribution:** select ,  or .
- ▶ Set the airflow.

**i** Several air distribution options can be selected at the same time, for example to set the temperature/air conditioning for the windshield and the footwells simultaneously. The  climate control for the windshield can only be selected for the first seat row.

### Activating/deactivating the climate control synchronization function via the control panel

Climate control can be set centrally using the synchronization function. The temperature and air distribution settings for the driver's side are adopted automatically for the front passenger side.

- ▶ Press the **SYNC** button.

The synchronization function is deactivated if the settings for one of the other climate zones are changed.

### Activating/deactivating the climate control synchronization function using the multimedia system

Climate control can be set centrally using the synchronization function. The driver's settings for temperature, air quantity and air distribution are adopted automatically for all climate zones.

- ▶ Call up the air conditioning menu (→ page 146).
- ▶ Select **First Row of Seats**.
- ▶ Select **SYNC**.  
Depending on the previous status, the function is activated or deactivated.

### Removing condensation from the windows

#### Windows fogged up on the inside

- ▶ Press the **A/C** or **AUTO** button.

- ▶ If the windows continue to fog up: press the  button.

#### Windows fogged up on the outside

- ▶ Switch on the windshield wipers.
- ▶ Press the **AUTO** button.

### Switching air-recirculation mode on/off

- ▶ Press the  button.  
The interior air will be recirculated.

Air-recirculation mode automatically switches to fresh air mode after some time.

- i** If air-recirculation mode is switched on, the windows may fog up more quickly. Switch on air-recirculation mode only briefly.

### Switching the residual heat on or off

#### Requirements:

- The vehicle is parked.

It is possible to make use of the residual heat from the engine to continue heating or ventilat-

ing the front compartment of the vehicle for approximately 30 minutes.

- ▶ **To switch on:** press the  button.

Residual heat is switched off automatically.

### Activating/deactivating ionization

The ionization improves the quality of the vehicle's interior air. The ionization of the interior air is odorless.

- ▶ Call up the air conditioning menu (→ page 146).
- ▶ Select **Air Quality**.
- ▶ Select **IONIZATION**.  
Depending on the previous status, the function is activated or deactivated.

### Fragrance system

#### Setting the fragrance system Requirements:

- Automatic climate control is activated.
- The glove box is closed.

The fragrance system distributes a pleasant fragrance throughout the vehicle interior from a flacon located in the glove box.

- ▶ Call up the climate control menu (→ page 146).
  - ▶ Select **Air Quality**.
  - ▶ Select **AIR FRESHENER**.  
The fragrance system begins at the highest intensity.
  - ▶ Keep pressing until the desired intensity is reached.
-  The intensity levels can be selected in the following order: Strong - Medium - Weak - Off

#### Inserting or removing the flacon of the fragrance system

 **WARNING** Risk of injury from liquid perfume

If children open the flacon, they could drink the liquid perfume or it could come into contact with their eyes.

- ▶ Do not leave children unattended in the vehicle.
- ▶ Consult a doctor immediately if liquid perfume has been drunk.
- ▶ If liquid perfume comes into contact with your eyes or skin, rinse your eyes with clean water.
- ▶ If symptoms continue, consult a doctor.

 **ENVIRONMENTAL NOTE** Environmental damage due to improper disposal of full flacons



Full flacons must not be disposed of with household waste.



Full flacons must be taken to a harmful substance collection point.

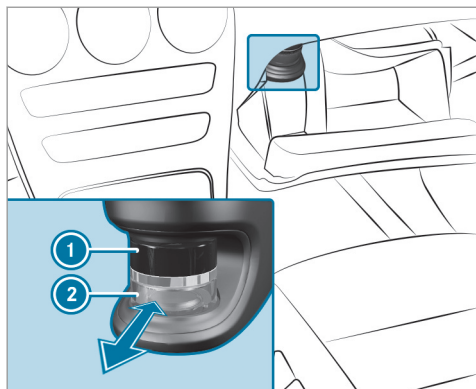

▶ **To insert:** slide flacon ② into the holder as far as it will go.

▶ **To remove:** pull out flacon ②.

If you do not use genuine Mercedes-Benz interior perfumes, observe the manufacturers' safety notices on the perfume packaging.

Dispose of the genuine Mercedes-Benz interior perfume flacon when it is empty and do not refill it.

#### Refillable flacon

- ▶ Unscrew cap ① of empty flacon ②.
- ▶ Fill flacon ② with a maximum of 0.5 fl. oz. (15 ml).
- ▶ Screw cap ① back onto flacon ②.

Always refill the empty refillable flacon with the same perfume. Observe the separate information sheet attached to the flacon.

#### Air vents

##### Adjusting the front air vents

**⚠ WARNING** - Danger of burns or frostbite due to being too close to the air vents

Very hot or very cold air can flow from the air vents.

This could result in burns or frostbite in the immediate vicinity of the air vents.

- ▶ Make sure that all vehicle occupants always maintain a sufficient distance to the air vents.
- ▶ If necessary, direct the airflow to another area of the vehicle interior.

To guarantee the flow of fresh air through the air vents into the vehicle interior, comply with the following:

- Always keep the vents and the ventilation grille in the vehicle interior free.
- Keep the air inlet free of deposits (→ page 428).

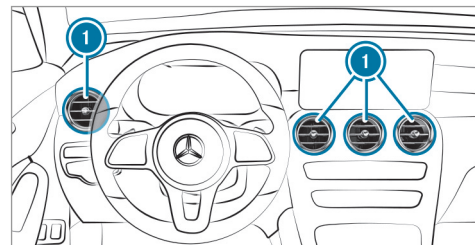



- ▶ **To open or close:** hold air vent ① in the center and turn it to the left (open) or right (closed) as far as it will go.
- ▶ **To adjust the air direction:** hold air vent ① in the center and move it up or down or to the left or right.

#### Adjusting the rear air vents

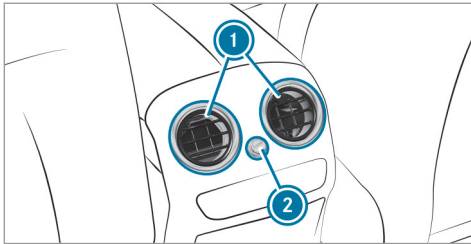

- ▶ **To open or close:** turn controller ② to the left or right as far as it will go.
- ▶ **To adjust the air direction:** hold air vent ① in the center and move it up or down or to the left or right.

## Driving

### Notes on Mercedes-AMG vehicles

Observe the notes on the following topics in the Supplement, as you may otherwise fail to recognize dangers:

- RACE START
- AMG adaptive sport suspension system
- (DYNAMIC SELECT switch) drive programs
- Functions of ESP®

### Switching on the power supply or the ignition (without engine start)

**⚠ WARNING** Risk of accident and injury due to children left unattended in the vehicle

If children are left unattended in the vehicle, they could:

- Open doors, thereby endangering other persons or road users.

- Get out and be struck by oncoming traffic.
- Operate vehicle equipment and become trapped, for example.

In addition, the children could also set the vehicle in motion, for example by:

- Releasing the parking brake.
  - Changing the transmission position.
  - Starting the vehicle.
- ▶ Never leave children unattended in the vehicle.
- ▶ When leaving the vehicle, always take the key with you and lock the vehicle.
- ▶ Keep the vehicle key out of reach of children.

Also observe the "Notes on pets in the vehicle".

#### Requirements:

- The SmartKey is located in the vehicle and the SmartKey battery is not discharged.
- The brake pedal is not depressed.

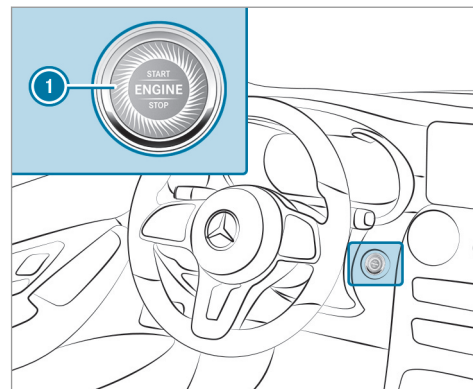

- ▶ **To switch on the power supply:** press button ① once. You can activate the windshield wipers, for example.

The power supply is switched off again if the following conditions are met:

- You open the driver's door.
- You press button ① twice more.

- ▶ **To switch on the ignition:** press button ① twice.  
The indicator lamps in the instrument cluster light up.

The ignition is switched off again if one of the following conditions is met:

- You do not start the vehicle within 15 minutes and the transmission is in position **P** or the electric parking brake is applied.
- You press button ① once.

### Starting the vehicle

#### Starting the vehicle with the start/stop button

**⚠ DANGER** Risk death caused by exhaust gases

Combustion engines emit poisonous exhaust gases such as carbon monoxide. Inhaling these exhaust gases is hazardous to health and leads to poisoning.

- ▶ Never leave the engine or, if present, the auxiliary heating running in an enclosed space without sufficient ventilation.

**⚠ WARNING** Risk of fire caused by flammable material on the exhaust system

Flammable materials brought in by either animals or environmental influences may ignite if they come into contact with hot parts of the engine or exhaust system.

- ▶ Therefore, check regularly that there are no flammable materials in the engine compartment or on the exhaust system.

#### Requirements:

- The SmartKey is located in the vehicle and the SmartKey battery is not discharged.
- ▶ Shift the transmission to position **P** or **N**.
- ▶ Depress the brake pedal and press button ① once.

- ▶ If the vehicle does not start: switch off non-essential consumers and press button ① once.

- ▶ If the vehicle still does not start and the [Place the Key in the Marked Space See Operator's Manual](#) display message also appears in the multifunction display: start the vehicle in emergency operation mode.

- ① You can switch off the engine while driving by pressing button ① for about three seconds or by pressing button ① three times within three seconds. Be sure to observe the safety notes under "Driving tips" (→ page 157).

#### Starting the vehicle with SmartKey in the marked space (emergency operation mode)

If the vehicle does not start and the [Place the Key in the Marked Space See Operator's Manual](#) message appears in the multifunction display, you can start the vehicle in emergency operation mode.

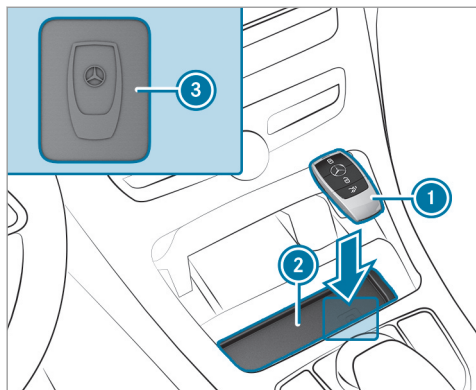

- ▶ Make sure that marked space ② is empty.
  - ▶ Remove SmartKey ① from the key ring.
  - ▶ Place SmartKey ① in marked space ② on the symbol ③.
- The vehicle will start after a short time.
- If you remove SmartKey ① from marked space ② the engine continues running. For further engine starts however, SmartKey ①

must be located in marked space ② on symbol ③ during the entire journey.

- ▶ Have SmartKey ① checked at a qualified specialist workshop.

**If the vehicle does not start:**

- ▶ Place SmartKey ① in marked space ② and leave it there.
  - ▶ Depress the brake pedal and start the vehicle using the start/stop button.
- ⓘ You can also switch on the power supply or the ignition with the start/stop button.

**Starting the vehicle via Remote Online services**

**Cooling or heating the vehicle interior before commencing your journey**

ⓘ This function is not available in all countries. If you start the vehicle via your smartphone, the previously selected air conditioning adjustment is active.

Ensure the following before starting the engine:

- The legal stipulations in the area where your vehicle is parked allow engine starting via smartphone.
  - It is safe to start and run the engine where your vehicle is parked.
  - The fuel tank is sufficiently filled.
  - The starter battery is sufficiently charged.
- ⓘ You can also set the temperature with your smartphone. Information on Mercedes me connect and other services: <https://www.mercedes.me>  
This function is not available for all models.

**Charging the battery before commencing your journey**

ⓘ This function is not available in all countries. If the vehicle battery is discharged, you receive a message on your smartphone. You can then start the vehicle with the smartphone to charge the battery. The vehicle is automatically switched off after ten minutes.

Ensure the following before starting the engine:

- The legal stipulations in the area where your vehicle is parked allow engine starting via smartphone.
- It is safe to start and run the engine where your vehicle is parked.
- The fuel tank is sufficiently filled.

#### Starting the vehicle (Remote Online)

**⚠ WARNING** Risk of crushing or entrapment due to unintentional starting of the engine

Limbs could be crushed or trapped if the engine is started unintentionally during service or maintenance work.

- ▶ Always secure the engine against unintentional starting before carrying out maintenance or repair work.

#### Requirements:

- Park position **P** is selected.
- The anti-theft alarm system is not activated.

- The panic alarm is not activated.
- The hazard warning lights are switched off.
- The hood is closed.
- The doors are closed and locked.
- The windows and sliding sunroof are closed.

- ▶ Start the vehicle using the smartphone. After every vehicle start, the engine runs for ten minutes.

You can carry out a maximum of two consecutive starting attempts. The vehicle must be started once with the SmartKey before trying to start the vehicle again with the smartphone. you can stop the vehicle again at any time.

- ⓘ Further information can be found in the smartphone app.

#### Securing the engine against starting before carrying out maintenance or repair work:

- ▶ Switch on the hazard warning lights.

or

- ▶ Unlock the doors.

or

- ▶ Open a side window or the sliding sunroof.

#### Breaking-in notes

**Mercedes-AMG vehicles:** observe the notes in the Supplement. Otherwise, you may fail to recognize dangers.

To preserve the engine during the first 1,000 miles (1,500 km):

- Drive at varying road speeds and engine speeds.
- Drive the vehicle in drive program **C** or **E**.
- Shift to the next highest gear at the very latest when the needle reaches the last third before the red area in the tachometer.
- Do not shift down a gear manually in order to brake.
- Avoid overstraining the vehicle, e.g. driving at full throttle.
- Do not depress the accelerator pedal past the pressure point (kickdown).

- Only increase the engine speed gradually and accelerate the vehicle to full speed after 1,000 miles (1,500 km).

This also applies when the engine or parts of the drivetrain have been replaced.

Please also observe the following breaking-in notes:

- In certain driving and driving safety systems, the sensors adjust automatically while a certain distance is being driven after the vehicle has been delivered or after repairs. Full system effectiveness is not reached until the end of this teach-in process.
- Brakepads, brake discs and tires that are either new or have been replaced only achieve optimum braking effect and grip after several hundred kilometers of driving. Compensate for the reduced braking effect by applying greater force to the brake pedal.

### Notes on optimized acceleration

If all necessary prerequisites and activation conditions are fulfilled, the best possible acceleration can be achieved from a standstill.

Do not use the optimized acceleration on public roads. Individual wheels could spin and you could lose control of the vehicle. There is an increased risk of skidding and/or accident.

Be sure to observe the safety notes and information on ESP® (→ page 186).

### Pulling away with optimized acceleration

**⚠ WARNING** Risk of skidding and having an accident from wheels spinning

When you use optimized acceleration, individual wheels could spin and you could lose control of the vehicle.

If ESP® is deactivated, there is a risk of skidding and accident.

- ▶ Make sure that no persons or obstacles are in the close vicinity of your vehicle.

Requirements:

- The vehicle has been broken in (→ page 155).
- The vehicle and tires are in good condition.
- You are on a high-grip roadway.
- The engine and transmission are at normal operating temperature.

**!** **NOTE** Increased wear due to optimized acceleration

When pulling away with optimized acceleration, all components of the drivetrain are subjected to a very high load.

This can lead to increased component wear.

- ▶ Do not always pull away with optimized acceleration.

- ▶ Engage the **[D]** drive position (→ page 169).
- ▶ Move the steering wheel to the straight-ahead position.
- ▶ Select the sportiest available drive program **[S]** or **[S]** (→ page 166).

- ▶ Deactivate ESP® (→ page 190).
- ▶ Depress and hold the brake pedal firmly with your left foot.
- ▶ With your right foot, fully depress the accelerator pedal.
- ▶ After no more than five seconds, take your left foot quickly off the brake, but keep the accelerator pedal depressed. The vehicle pulls away at maximum acceleration.
- ▶ Switch on ESP® once the acceleration procedure is complete.

#### Ending optimized acceleration

- ▶ Remove your foot from the accelerator pedal.
  - ▶ Reactivate the ESP®.
- i** After you pull away with optimized acceleration, components of the drivetrain can become very hot, which means that optimized acceleration values may be reached again only after a few minutes.

#### Notes on driving

##### **▲ WARNING** Risk of accident due to objects in the driver's footwell

Objects in the driver's footwell may impede pedal travel or block a depressed pedal.

This jeopardizes the operating and road safety of the vehicle.

- ▶ Stow all objects in the vehicle securely so that they cannot get into the driver's footwell.
- ▶ Always install the floor mats securely and as prescribed in order to ensure that there is always sufficient room for the pedals.
- ▶ Do not use loose floor mats and do not place floor mats on top of one another.

##### **▲ WARNING** Risk of accident due to unsuitable footwear

Operation of the pedals may be restricted due to unsuitable footwear such as:

- Shoes with platform soles
  - Shoes with high heels
  - Slippers
- ▶ When driving always wear suitable shoes in order to be able to operate the pedals safely.

##### **▲ WARNING** Risk of accident when switching off the ignition when driving

If you switch off the ignition while driving, safety functions are restricted or no longer available. This may affect the power steering system and the brake force boosting, for example.

You will then need to use considerably more force to steer and brake.

- ▶ Do not switch off the ignition while driving.

**⚠ DANGER** Risk death caused by exhaust gases

Combustion engines emit poisonous exhaust gases such as carbon monoxide. Inhaling these exhaust gases is hazardous to health and leads to poisoning.

- ▶ Never leave the engine or, if present, the auxiliary heating running in an enclosed space without sufficient ventilation.

**⚠ WARNING** Risk of skidding and of an accident due to shifting down on slippery road surfaces

If you shift down on slippery road surfaces to increase the engine braking effect, the drive wheels may lose traction.

- ▶ Do not shift down on slippery road surfaces to increase the engine braking effect.

**⚠ DANGER** Risk of fatal injury due to poisonous exhaust gases

If the tailpipe is blocked or sufficient ventilation is not possible, poisonous exhaust gases such as carbon monoxide may enter the vehicle. This is the case when the vehicle becomes stuck in snow, for example.

- ▶ Keep the tailpipe and the area around the vehicle free from snow when the engine or the stationary heater are running.
- ▶ Open a window on the side of the vehicle facing away from the wind to ensure an adequate supply of fresh air.

**⚠ WARNING** Risk of accident and injury due to being under the influence of alcohol and drugs while driving

Driving when under the influence of alcohol and/or drugs is an extremely dangerous combination. Even small quantities of alcohol or drugs may affect your reflexes, perception and judgment.

The probability of a serious or even fatal accident greatly increases if you drive when under the influence of alcohol or drugs.

- ▶ Do not drink alcohol or take drugs while driving, and do not allow anyone to drive who has been drinking alcohol or taking drugs.

**⚠ WARNING** Risk of accident due to the brake system overheating

If you leave your foot on the brake pedal when driving, the brake system may overheat.

This increases the braking distance and the brake system may even fail.

- ▶ Never use the brake pedal as a footrest.
- ▶ Do not depress the brake pedal and the accelerator pedal at the same time while driving.



**!** **NOTE** Wearing out the brake linings by continuously depressing the brake pedal

- ▶ Do not depress the brake pedal continuously whilst driving.
- ▶ To use the braking effect of the engine, shift to a lower gear in good time.

**!** **NOTE** Damage to the drivetrain and engine when pulling away

- ▶ Do not warm up the engine while the vehicle is stationary. Pull away immediately.
- ▶ Avoid high engine speeds and driving at full throttle until the engine has reached its operating temperature.

**!** **NOTE** Damage to the catalytic converter due to non-combusted fuel

The engine is not running smoothly and is misfiring.  
Non-combusted fuel may get into the catalytic converter.

- ▶ Only depress the accelerator pedal slightly.
- ▶ Have the cause rectified immediately at a qualified specialist workshop.

**Plug-in hybrid:** observe the notes in the Supplement. Otherwise, you may fail to recognize dangers.

#### Notes on driving on salt-treated roads

The braking effect is limited on salt-treated roads.

Therefore, observe the following notes:

- due to salt build-up on the brake discs and brakepads, the braking distance can increase considerably or result in braking only on one side
- maintain a much greater safe distance to the vehicle in front

To remove salt build-up:

- brake occasionally while paying attention to the traffic conditions

- carefully depress the brake pedal at the end of the journey and when starting the next journey

#### Notes on hydroplaning

Hydroplaning can take place once a certain amount of water has accumulated on the road surface.

Observe the following notes during heavy precipitation or in conditions in which hydroplaning may occur:

- reduce speed
- avoid tire ruts
- avoid sudden steering movements
- brake carefully

**i** Also observe the notes on regularly checking wheels and tires (→ page 458).

#### Notes on driving through water on the road surface

Water which has entered into the vehicle can damage the engine, electrics and transmission.

Water can also enter the air intake of the engine and cause engine damage.

Observe the following if you must drive through water:

- observe the maximum permissible fording depth (→ page 502)
- drive at walking pace at most, otherwise water can enter the vehicle interior or engine compartment
- vehicles traveling in front, or oncoming vehicles, can create waves which may exceed the maximum permissible height of the water

The braking effect of the brakes is reduced after fording. Brake carefully while paying attention to the traffic conditions until braking power has been fully restored.

### Notes on off-road driving

**⚠ WARNING** Risk of accident if you do not keep to line of fall on inclines

If you drive at an angle or turn on an incline, the vehicle could slip sideways, tip and roll-over.

- ▶ Always drive on inclines in the line of fall (straight up or down) and do not turn.

**⚠ WARNING** Risk of fire due to flammable materials on hot parts of the exhaust system

Flammable material such as leaves, grass or twigs may ignite if they come into contact with hot parts of the exhaust system.

- ▶ When driving on unpaved roads or off-road, regularly check the vehicle underside.
- ▶ Remove trapped plants or other flammable material.
- ▶ If there is damage, consult a qualified specialist workshop immediately.

When driving off-road, substances such as sand, mud and water or water mixed with oil may get into the brakes. This may lead to a reduction in braking effect or total brake failure as a result of increased wear. The braking characteristics will vary depending on the material that has entered

the system. Clean the brakes after driving off-road. If you then notice reduced braking effect or hear scraping noises, have the brake system checked at a qualified specialist workshop. Adjust your driving style to the changed braking characteristics.

**! NOTE** Damage caused by driving over obstacles

The vehicle can be damaged by:

- Driving up on high curbs or unpaved roads.
  - Quickly driving over obstacles such as curbs, speed bumps or potholes.
  - Heavy objects hitting the underbody or chassis components.
- ▶ Do not drive over obstacles that could damage the vehicle.
  - ▶ Check the vehicle regularly for damage during off-road driving.
  - ▶ Adjust the vehicle speed to suit the road surface conditions.

- ▶ If there is damage, consult a qualified specialist workshop immediately.

 **ENVIRONMENTAL NOTE** Environmental damage due to non-observance of prohibition signs

Environmental protection has priority. Treat nature with respect.

- ▶ Be sure to observe prohibition signs.



### Checklist before driving off-road

Check the following points before driving off-road:

- Fuel level
- Engine oil level: fill engine oil up to the maximum level to ensure full gradeability (→ page 424).
- Tire-change tool kit and spare wheel
- Tires and wheels

### Off-road driving

Read this section before driving your vehicle off-road. Practice by driving over more gentle off-road terrain first.

- Observe the notes on the cross-country ABS (→ page 185).
- If necessary, select the  or  drive program (vehicles with an Off-road package) before driving off-road (→ page 166).
- Select a vehicle level suitable for off-road terrain (→ page 216). To avoid damaging the vehicle, make sure there is always sufficient ground clearance.
- Always keep the engine running and in gear when driving on downhill gradients and slopes. Observe the notes on driving in mountainous terrain.
- Do not drive on unknown terrain that is not easily visible and stay on marked routes.
- Always keep the doors and windows closed while the vehicle is in motion.
- Deactivate Active Distance Assist DISTRONIC and cruise control.

- Adapt your driving style to the terrain.
- Do not use the HOLD function on steep downhill or uphill gradients with slippery or loose surfaces.

### Driving on sand

When driving on sand, also observe the following instructions:

- Select the  drive program.
- Select a higher vehicle level.
- Shift to a lower gear.
- Drive quickly to overcome the rolling resistance, otherwise the vehicle may dig itself in.
- Drive in the tracks of other vehicles if possible. Make sure that the following prerequisites are met:
  - The tire ruts are not too deep
  - The sand is firm enough
  - the ground clearance is sufficient

**Mercedes-AMG vehicles:** observe the notes in the Supplement. Otherwise, you may fail to recognize dangers.

### Fording

Also observe the following information when fording:

- Drive at no more than 6 mph (10 km/h).
- Observe the maximum permissible fording depth (→ page 502).
- Switch off automatic climate control (→ page 147).
- Ensure that a bow wave does not form as you drive.
- Do not stop in the water and do not switch off the engine. Ensure the ECO start/stop function is switched off (→ page 164).

### Driving in mountainous terrain



Also observe the following information when driving in mountainous terrain:

- Observe the values of the approach/departure angle and of the maximum gradient (→ page 502).
- Avoid high engine speeds.
- Use the braking power of the engine when driving downhill.

- Shift to a lower gear on uphill gradients and on long, steep downhill gradients.
- Activate DSR before driving downhill, if necessary (→ page 199).

### Checklist after driving off-road

Driving off-road places greater demands on your vehicle than driving on normal roads. Check the entire vehicle for damage and foreign bodies every time after driving off-road. Foreign bodies in the wheels or drivetrain can lead to imbalances and therefore vibrations.

- If the  or  drive program is selected: select another drive program.
- Switch DSR off.
- Lower the vehicle level again to a level suitable to the road conditions, e.g. to the normal level.
- Apply the brakes to dry them after fording.
- Check that the service brake is working normally after a long downhill stretch.
- Clean the following components every time after driving off-road:
  - License plate number

- Headlamps and tail lamps
- Tires, wheels and wheel arches
- underbody

- After driving through sand, mud, water or gravel, have the following components checked and cleaned:

- Brake discs and brakepads
- Tires and wheels
- axle joints

### ECO start/stop function

---

#### Operation of the ECO start/stop function

#### Vehicles with a 48 V on-board electrical system (EQ Boost technology)

The engine is switched off automatically in the following situations if all vehicle conditions for an automatic engine stop are met:



- You brake the vehicle to a standstill in transmission position **D** or **N**.
- You depress the brake pedal when traveling at a low speed.

If you switch on the HOLD function or select a different transmission position than **R**, the engine will automatically stop in the following situations:





- You stop behind a vehicle that is pulling away.
- You stop at a stop sign when there is no vehicle in front of you.
- You turn the steering wheel hard at a low speed.

The engine is restarted automatically if:

- You release the brake pedal in transmission position **D** when the HOLD function is not active and one of the following conditions are met:
  - Drive program **C** or **E** is not selected.
  - Drive program **C** or **E** is selected but the vehicle does not start to move.
  - Drive program **C** or **E** is selected, the vehicle is moving at a speed of more than 15 mph (20 km/h) and glide mode is not activated.

- You engage transmission position **D** or **R**.
- You release the brake pedal, the vehicle is not in glide mode and it starts to move on a gentle downhill gradient at a speed below 2 mph (3 km/h).
- You depress the accelerator pedal.
- You engage drive program **S**,  or  (vehicles with Offroad package).
- An automatic engine start is necessary.

ECO start/stop function symbols in the multifunction display:

- The  symbol (green) appears when the vehicle is at a standstill: the engine was switched off by the ECO start/stop function.
- The  symbol (yellow) appears when the vehicle is at a standstill: not all vehicle conditions for an engine stop have been met.
- Neither the  nor  symbol appears when the vehicle is at a standstill: an intelligent stop inhibitor was detected, e.g. a stop sign.

- If, in spite of an intelligent stop inhibitor, the engine should be switched off by the ECO start/stop function, activate the HOLD function or engage transmission position **P**.

If the engine was switched off by the ECO start/stop function and you leave the vehicle, a warning tone sounds and the engine is not restarted. The **Vehicle Ready to Drive Switch the Ignition Off Before Exiting** display message also appears in the multifunction display. If you do not switch off the ignition, the ignition is automatically switched off after three minutes.

#### **Vehicles without a 48 V on-board electrical system (EQ Boost technology)**



The engine is switched off automatically in the following situations if all vehicle conditions for an automatic engine stop are met:

- You brake the vehicle to a standstill in transmission position **D** or **N**.





If you switch on the HOLD function in transmission position **D** or **N**, the engine will automatically stop in the following situations:

- You stop behind a vehicle that is pulling away.
  - You stop at a stop sign when there is no vehicle in front of you.
  - You turn the steering wheel hard at a low speed.
- i** In transmission position **R**, the engine is not switched off automatically even when the HOLD function is switched on.

The engine is restarted automatically if:

- You release the brake pedal in transmission position **D** when the HOLD function is not active.
- You engage transmission position **D** or **R**.
- You engage drive program **S**,  or  (vehicles with Offroad package).
- You depress the accelerator pedal.
- An automatic engine start is necessary.

ECO start/stop function symbols in the multifunction display:

- The  symbol (green) appears when the vehicle is at a standstill: the engine was switched off by the ECO start/stop function.
- The  symbol (yellow) appears when the vehicle is at a standstill: not all vehicle conditions for an engine stop have been met.
- Neither the  nor  symbol appears when the vehicle is at a standstill: an intelligent stop inhibitor was detected, e.g. a stop sign.

**i** If, in spite of an intelligent stop inhibitor, the engine should be switched off by the ECO start/stop function, you have the following options:

- Switch on the HOLD function in transmission position **D** or **N**.
- Engage transmission position **P**.

If the engine was switched off by the ECO start/stop function and you leave the vehicle, a warning tone sounds and the engine is not restarted. The [Vehicle Ready to Drive Switch the Ignition](#)

[Off Before Exiting](#) display message also appears in the multifunction display. If you do not switch off the ignition, the ignition is automatically switched off after three minutes.

### Deactivating or activating the ECO start/stop function

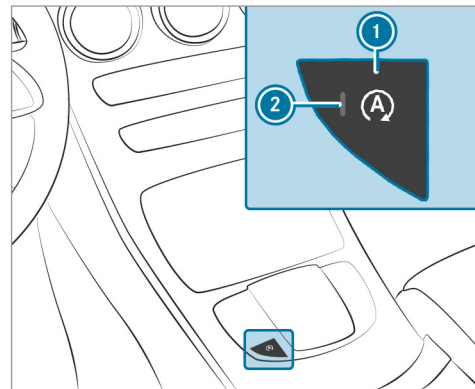

▶ Press button ①.  
If indicator lamp ② lights up, the ECO start/stop function is activated.

① Depending on the model and the vehicle equipment, the button may also be located at a different position in the center console.

### ECO display function

The ECO display summarizes your driving characteristics from the start of the journey to its completion and assists you in achieving the most economical driving style.

You can influence consumption by doing the following:

- driving with particular care
- driving the vehicle in drive program **E**
- observing the gearshift recommendations



The inner segment will light up and the outer segment will fill up when the following driving style is adopted:

- ① Moderate acceleration
- ② Gentle deceleration and rolling
- ③ Consistent speed

The inner segment will not light up and the outer segment will empty when the following driving style is adopted:

- ① Sporty acceleration
- ② Heavy braking
- ③ Fluctuations in speed

The ECO display will show you when you have driven economically:

- The three outer segments are completely filled simultaneously
- The ECO display lights up

The additional range achieved as a result of your driving style in comparison with a driver with a very sporty driving style is shown under **Bonus fr. Start**. The range displayed does not indicate a fixed reduction in consumption.

### DYNAMIC SELECT switch

#### Function of the DYNAMIC SELECT switch



**Plug-in hybrid:** observe the notes in the Supplement. Otherwise, you may fail to recognize dangers.

**Mercedes-AMG vehicles:** observe the notes in the Supplement. Otherwise, you may fail to recognize dangers.

Use the DYNAMIC SELECT switch to change between the following drive programs:

- I** **(Individual)**: individual settings
- S+** **(Sport +)**: particularly sporty driving style
- S** **(Sport)**: sporty driving style
- C** **(Comfort)**: comfortable and economical driving style
- E** **(Eco)**: particularly economical driving style

Vehicles with Off-road package:

-  **Offroad**: driving on less demanding off-road terrain
-  **(Offroad +)**: driving on difficult off-road terrain

**i** The drive program selected appears in the multifunction display of the on-board computer.

Depending on the drive program, the following systems change their characteristics:

- Drive:
  - Engine and transmission management

- Active Distance Assist DISTRONIC
- ESP®
- **Vehicles with AIR BODY CONTROL or DYNAMIC BODY CONTROL**: suspension
- Electric power steering

### Selecting the drive program

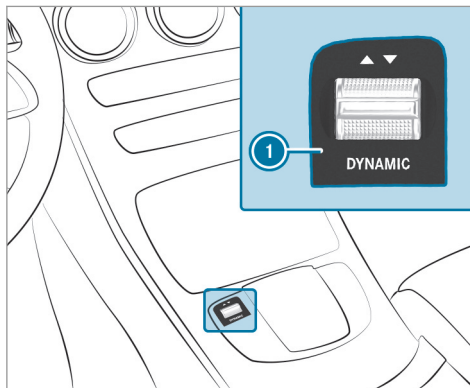

- ▶ Press DYNAMIC SELECT switch **1** forwards or backwards.  
The drive program selected appears in the multifunction display.

### Configuring DYNAMIC SELECT (multimedia system)

Multimedia system:

- ▶  ▶ Settings ▶ Vehicle
- ▶ DYNAMIC SELECT

#### Setting drive program I

- ▶ Select **Individual Config.**
- ▶ Select and set a category.

#### Switching the reset display on/off

- ▶ Switch **Request at Start** on or off.

**Function on:** the next time the vehicle is started a prompt appears asking whether the last active drive program should be restored. If the ECO start/stop function was deactivated, an additional prompt appears asking if the function should remain deactivated.



- ⓘ The prompt appears only if the previously active settings deviate from the standard settings.

**Function off:** the next time the vehicle is started the **[C]** drive program is set automatically. The ECO start/stop function is activated automatically.

- ⓘ This function must be activated for each user profile separately. Only when this function is activated will the drive program and Eco start/stop setting for the previous journey be saved for the respective user profile.

### Displaying vehicle data

Multimedia system:



- ▶ Select **Vehicle**.  
The vehicle data is displayed.

### Displaying engine data

Multimedia system:



- ▶ Select **Engine**.  
The engine data is displayed.
- ⓘ The values for engine output and engine torque may deviate from the nominal values. Items that can influence this are, for example:
- Sea level
  - Fuel grade
  - Outside temperature

### Calling up fuel consumption indicator

Multimedia system:



- ▶ Select **Consumption**.  
The current and average fuel consumption is displayed.

### Automatic transmission

#### DIRECT SELECT lever

#### Function of the DIRECT SELECT lever

**⚠ WARNING** Risk of accident due to incorrect gearshifting

If the engine speed is higher than the idle speed and you engage the transmission position **[D]** or **[R]**, the vehicle may accelerate sharply.

- ▶ If you engage the transmission position **[D]** or **[R]** always depress the brake pedal firmly and do not accelerate at the same time.

**⚠ WARNING** Risk of accident and injury due to children left unattended in the vehicle

If children are left unattended in the vehicle, they could:

- Open doors, thereby endangering other persons or road users.
- Get out and be struck by oncoming traffic.
- Operate vehicle equipment and become trapped, for example.

In addition, the children could also set the vehicle in motion, for example by:

- Releasing the parking brake.
  - Changing the transmission position.
  - Starting the vehicle.
- ▶ Never leave children unattended in the vehicle.
- ▶ When leaving the vehicle, always take the key with you and lock the vehicle.

▶ Keep the vehicle key out of reach of children.

Use the DIRECT SELECT lever to shift the transmission position. The current transmission position is displayed in the multifunction display.

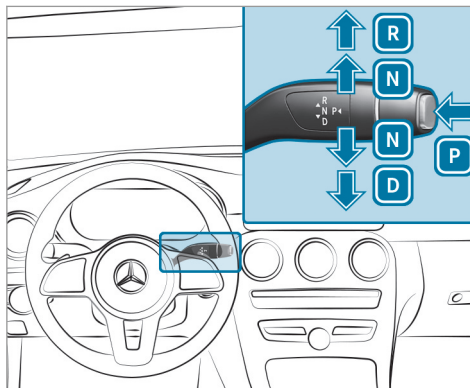

- ▶ **P** Park position
- ▶ **R** Reverse gear

- ▶ **N** Neutral
- ▶ **D** Drive position

### Engaging reverse gear R

▶ Depress the brake pedal and push the DIRECT SELECT lever upwards past the first point of resistance. The transmission position display shows **R** in the multifunction display.

### Engaging neutral N

▶ Depress the brake pedal and push the DIRECT SELECT lever up or down to the first point of resistance. The transmission position display shows **N** in the multifunction display.

Subsequently releasing the brake pedal will allow you to move the vehicle freely, e.g. to push it or tow it away.

**Proceed as follows if you want the automatic transmission to remain in neutral **N** even if the ignition is switched off:**

▶ Start the vehicle.

- ▶ Depress the brake pedal and engage neutral **N**.
- ▶ Release the brake pedal.
- ▶ Switch the ignition off.
- ⓘ If you then exit the vehicle leaving the SmartKey in the vehicle, the automatic transmission remains in neutral **N**.

#### Engaging park position P

- ▶ Observe the notes on parking the vehicle (→ page 174).
- ▶ Depress the brake pedal until the vehicle is stationary.
- ▶ When the vehicle is stationary, press button **P**.  
Park position is only engaged when the transmission position display **P** is shown in the multifunction display. If no transmission position display **P** appears, secure the vehicle to prevent it from rolling away.

Park position **P** is engaged automatically if one of the following conditions is met:

- You switch off the ignition when the vehicle is stationary and the transmission is in position **D** or **R**.
- You open the driver's door when the vehicle is stationary or when driving at a very low speed and the transmission is in position **D** or **R**.
- ⓘ To maneuver with an open driver's door, open the driver's door while stationary and engage transmission position **D** or **R** again.

#### Engaging drive position D

- ▶ Depress the brake pedal and push the DIRECT SELECT lever down past the first point of resistance.  
The transmission position display shows **D** in the multifunction display.

When the automatic transmission is in transmission position **D**, it shifts the gears automatically. This depends on the following factors:

- The selected drive program

- The position of the accelerator pedal
- The driving speed

#### Manual gearshifting

**▲ WARNING** Risk of skidding and of an accident due to shifting down on slippery road surfaces

If you shift down on slippery road surfaces to increase the engine braking effect, the drive wheels may lose traction.

- ▶ Do not shift down on slippery road surfaces to increase the engine braking effect.

### Permanent setting

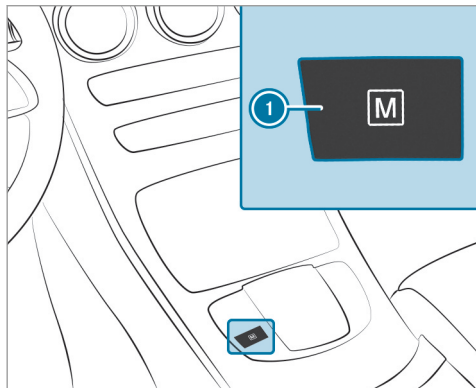

- ▶ **To activate/deactivate:** press button ①. Manual gearshifting is activated: transmission position **M** and the current gear appear in the multifunction display.  
Manual gearshifting is deactivated: transmission position **D** appears in the multifunction display.

### Temporary setting

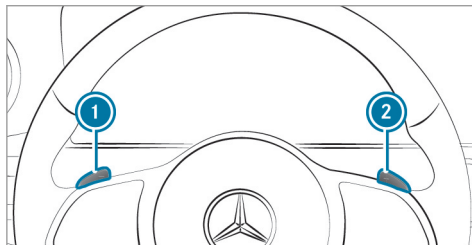

- ▶ **To activate:** pull steering wheel gearshift paddle ① or ②. Manual gearshifting is activated for a short time. Transmission position **M** and the current gear appear in the multifunction display.
  - ▶ **To deactivate:** pull steering wheel gearshift paddle ② and hold it in place. The transmission position **D** appears in the multifunction display.
- ⓘ To permanently shift the gears manually in drive program **[P+]** using the steering wheel gearshift paddles, select the **M** (manual) setting for the transmission.

### Gearshifting

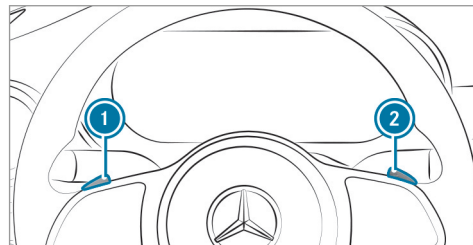

- ▶ **To shift up:** pull steering wheel gearshift paddle ②.
- ▶ **To shift down:** pull steering wheel gearshift paddle ①.

**Plug-in hybrid:** observe the notes in the Supplement. Otherwise, you may fail to recognize dangers.

**Mercedes-AMG vehicles:** observe the notes in the Supplement. Otherwise, you may fail to recognize dangers.

### Gearshift recommendation

**Mercedes-AMG vehicles:** observe the notes in the Supplement. Otherwise, you may fail to recognize dangers.

The gearshift recommendation assists you in adopting an economical driving style.

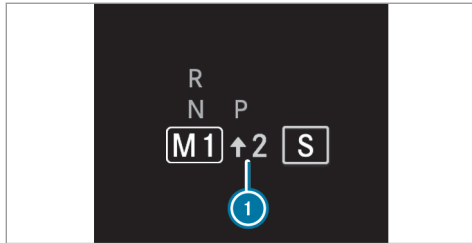

▶ If gearshift recommendation message ① is shown on the multifunction display, shift to the recommended gear.

### Using kickdown

**Mercedes-AMG vehicles:** observe the notes in the Supplement. Otherwise, you may fail to recognize dangers.

▶ **Maximum acceleration:** depress the accelerator pedal beyond the pressure point.

The automatic transmission shifts up to the next gear when the maximum engine speed is reached to protect the engine from overrevving.

### Glide mode function

**Mercedes-AMG vehicles:** observe the notes in the Supplement. Otherwise, you may not recognize dangers.

With an anticipatory driving style, glide mode helps you to reduce fuel consumption.

Glide mode is characterized by the following:

- The combustion engine is disconnected from the drivetrain and continues to run in neutral.
- The transmission position **D** is displayed in green in the multifunction display.

Glide mode is activated if the following conditions are met:

- Drive program **E** is selected.
- The speed is within a suitable range.
- The road's course is suitable, e.g. no steep uphill or downhill inclines or tight bends.
- There is no trailer coupled to the trailer hitch, and no bicycle rack installed.
- You do not depress the accelerator or brake pedal (except for light brake applications).

① Glide mode can also be activated if you have selected the "Eco" setting for the drive in the drive program **E\***.

Glide mode is deactivated again if one of the conditions is no longer met.

Glide mode can also be prevented by the following parameters:

- Incline
- Downhill gradient
- Temperature
- Height

- Speed
- Operating status of the engine
- Traffic situation

### Function of 4MATIC

4MATIC ensures that all four wheels are driven when needed. Together with ESP® and 4ETS, 4MATIC improves the traction of your vehicle whenever a driven wheel spins due to insufficient traction.

If you fail to adapt your driving style, 4MATIC can neither reduce the risk of an accident nor override the laws of physics. 4MATIC cannot take account of road, weather and traffic conditions. 4MATIC is only an aid. You are responsible especially for maintaining a safe distance from the vehicle in front, for vehicle speed, for braking in good time and for staying in lane.

- ① In wintry road conditions, the maximum effect of 4MATIC can be achieved only if you use winter tires (M+S tires), with snow chains if necessary.

### Refueling

#### Refueling the vehicle

**⚠ WARNING** Risk of fire or explosion from fuel

Fuels are highly flammable.

- ▶ Fire, open flames, smoking and creation of sparks must be avoided.
- ▶ Switch off the ignition and, if available, the stationary heater, before and while refueling the vehicle.

**⚠ WARNING** Risk of injury from fuels

Fuels are poisonous and hazardous to your health.

- ▶ Do not swallow fuel or let it come into contact with skin, eyes or clothing.
- ▶ Do not inhale fuel vapor.
- ▶ Keep children away from fuel.
- ▶ Keep doors and windows closed during the refueling process.

If you or other people come into contact with fuel, observe the following:

- ▶ Immediately rinse fuel off your skin with soap and water.
- ▶ If fuel comes into contact with your eyes, immediately rinse them thoroughly with clean water. Seek medical attention immediately.
- ▶ If you swallow fuel, seek medical attention immediately. Do not induce vomiting.
- ▶ Change immediately out of clothing that has come into contact with fuel.

**⚠ WARNING** Risk of fire and explosion due to electrostatic charge

Electrostatic charge can create sparks and thereby ignite fuel vapors.

- ▶ Before you open the fuel filler cap or take hold of the pump nozzle, touch the metallic vehicle body. This discharges any electrostatic charge that may have built up.
- ▶ Do not get into the vehicle again during the refueling process. Otherwise, electrostatic charge can build up again.

**!** **NOTE** Damage caused by the wrong fuel

Vehicles with a gasoline engine:

Even small amounts of the wrong fuel could result in damage to the fuel system, the engine and the emission control system.

- ▶ The RON requirement is located in the fuel filler flap.
- ▶ Only refuel with low-sulfur unleaded fuel.

This fuel may contain up to 10% ethanol. Your vehicle is suitable for use with E10 fuel.

Never refuel using any of the following fuels:

- Diesel
- Gasoline with more than 10% ethanol by volume, e.g. E15, E85, E100
- Gasoline with more than 3% methanol by volume, e.g. M15, M30, M85, M100
- Gasoline with additives containing metal

If you accidentally refuel with the wrong fuel:

- ▶ Do not switch the ignition on.
- ▶ Consult a qualified specialist workshop.

**!** **NOTE** Do not use diesel to refuel vehicles with a gasoline engine

If you have accidentally refueled with the wrong fuel:

- Do not switch the ignition on. Otherwise fuel can enter the engine.

Even small amounts of the wrong fuel could result in damage to the fuel system and the engine. The repair costs are high.

- ▶ Consult a qualified specialist workshop.
- ▶ Have the fuel tank and fuel lines drained completely.

**!** **NOTE** Damage to the fuel system caused by overfilled fuel tanks

- ▶ Only fill the fuel tank until the pump nozzle switches off.

**!** **NOTE** Fuel may spray out when you remove the fuel pump nozzle

- ▶ Only fill the fuel tank until the pump nozzle switches off.

### Requirements

**Plug-in-hybrid:** for vehicles with a gasoline engine, observe the notes in the Supplement. Otherwise, you may fail to recognize dangers.

- The vehicle is unlocked (→ page 66).
- ① Do not get into the vehicle again during the refueling process. Otherwise, electrostatic charge could build up again.

Observe the notes on operating fluids  
(→ page 496).

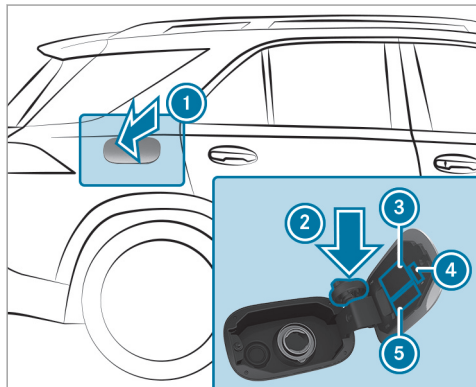

- ① Fuel filler flap
- ② Bracket for fuel filler cap
- ③ Tire pressure table
- ④ QR code for rescue card
- ⑤ Fuel type

- ▶ Press on the back area of fuel filler flap ①.
- ▶ Turn the fuel filler cap counter-clockwise and remove it.
- ▶ Insert the fuel filler cap from above into bracket ②.
- ▶ Completely insert the pump nozzle into the tank filler neck, hook in place and refuel.
- ▶ Only fill the fuel tank until the pump nozzle switches off.
- ▶ Replace the cap on the filler neck and turn clockwise until it engages audibly.
- ▶ Close fuel filler flap ①.
- ① Close the fuel filler flap before locking the vehicle.

## Parking

### Parking the vehicle

**⚠ WARNING** Risk of accident and injury caused by an insufficiently secured vehicle rolling away.

If the vehicle is not securely parked sufficiently, it can roll away in an uncontrolled way even at a slight downhill gradient.

- ▶ Ensure that the parked vehicle is always properly secured against rolling away as follows:
  - On uphill or downhill gradients, turn the front wheels so that the vehicle rolls towards the curb if it starts moving.
  - Apply the parking brake.
  - Switch the transmission to position **P**.



**▲ WARNING** Risk of fire caused by hot exhaust system parts

Flammable material such as leaves, grass or twigs may ignite if they come into contact with hot parts of the exhaust system or exhaust gas flow.

- ▶ Park the vehicle so that no flammable material can come into contact with hot vehicle components.
- ▶ In particular, do not park on dry grass-land or harvested grain fields.

**▲ WARNING** Risk of accident and injury due to children left unattended in the vehicle

If children are left unattended in the vehicle, they could:

- Open doors, thereby endangering other persons or road users.
- Get out and be struck by oncoming traffic.

- Operate vehicle equipment and become trapped, for example.

In addition, the children could also set the vehicle in motion, for example by:

- Releasing the parking brake.
  - Changing the transmission position.
  - Starting the vehicle.
- ▶ Never leave children unattended in the vehicle.
  - ▶ When leaving the vehicle, always take the key with you and lock the vehicle.
  - ▶ Keep the vehicle key out of reach of children.

**1 NOTE** Damage to the vehicle due to it rolling away

- ▶ Always secure the vehicle against rolling away.

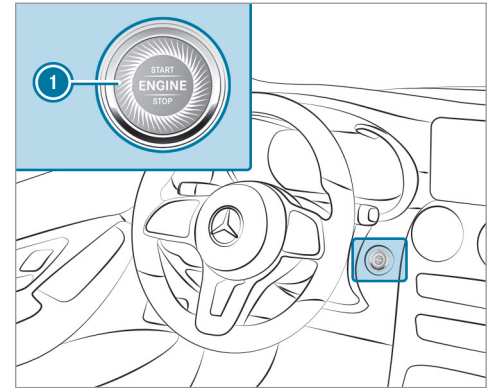

- ▶ Bring the vehicle to a standstill by applying the brake pedal.
- ▶ On uphill or downhill gradients, turn the front wheels so that the vehicle rolls towards the curb if it starts moving.
- ▶ Apply the electric parking brake.

- ▶ Engage transmission position **P** in a stationary vehicle with the brake pedal applied (→ page 169).
  - ▶ Switch off the engine and the ignition by pressing button **1**.
  - ▶ Release the service brake slowly.
  - ▶ Get out of the vehicle and lock it.
- i** When you park the vehicle, you can still operate the side windows and the panoramic sliding sunroof for approximately five minutes if the driver's door is closed.

### Garage door opener

#### Programming buttons for the garage door opener

**⚠ DANGER** Risk death caused by exhaust gases

Combustion engines emit poisonous exhaust gases such as carbon monoxide. Inhaling these exhaust gases is hazardous to health and leads to poisoning.

- ▶ Never leave the engine or, if present, the auxiliary heating running in an enclosed space without sufficient ventilation.

**⚠ WARNING** Risk of injury when opening or closing a door with the garage door opener

When you operate or program the door with the integrated garage door opener, people in the range of movement of the door may become trapped or struck by the door.

- ▶ When using the integrated garage door opener, always make sure that nobody is within the range of movement of the door.

Only operate the following doors using the garage door opener:

- Doors with a safety stop and reversing feature.
- Doors which conform to the current U.S. safety standards.

#### Requirements:

- The vehicle has been parked outside the garage or outside the range of movement of the door.
- The engine is switched off.
- The ignition is switched on.

**i** The garage door opener function is always available when the ignition is switched on.

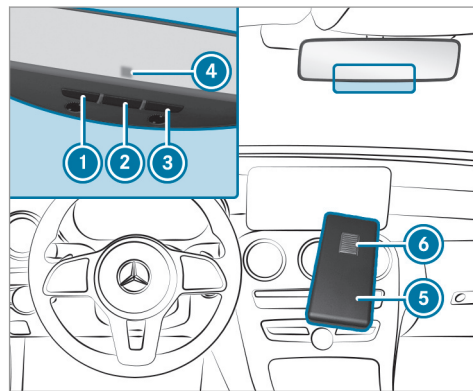

- ▶ Check if the transmission frequency of the remote control has the frequency range of 280 to 868 MHz.  
Radio equipment approval number:
  - NZLMUAHL5 (USA)
  - 4112A-MUAHL5 (Canada)
- ▶ Press and hold button ①, ② or ③ that you wish to program.  
Indicator lamp ④ flashes yellow.
- ⓘ It can take up to 20 seconds before the indicator lamp flashes yellow.
- ▶ Release the previously pressed button.  
Indicator lamp ④ continues to flash yellow.
- ▶ Point remote control ⑤ from a distance of 0.4 in (1 cm) to 3 in (8 cm) towards button ①, ② or ③.
- ▶ Press and hold button ⑥ of remote control ⑤ until one of the following signals appears:
  - Indicator lamp ④ lights up green continuously. Programming is complete.
  - Indicator lamp ④ flashes green. Programming was successful. Additionally,

synchronization of the rolling code with the door system must also be carried out.

- ▶ If indicator lamp ④ does not light up or flash green: repeat the procedure.
- ▶ Release all of the buttons.
- ⓘ The remote control for the door drive is not included in the scope of delivery of the garage door opener.

#### Synchronizing the rolling code Requirements:

- The door system uses a rolling code.
- The vehicle must be within range of the garage door or door drive.
- The vehicle as well as persons and objects, are located outside the range of movement of the door.

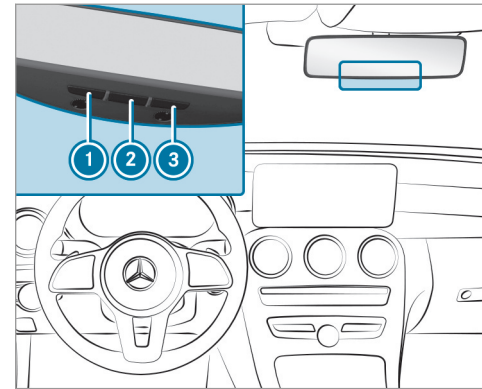

- ▶ Press the programming button on the door drive unit.  
Initiate the next step within approximately 30 seconds.
- ▶ Press previously programmed button ①, ② or ③ repeatedly until the door closes.  
When the door closes, programming is complete.

- ⓘ Please also read the operating instructions for the door drive.

### Troubleshooting when programming the remote control

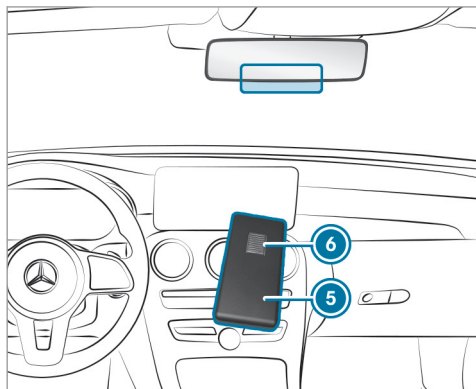

- ▶ Check if the transmitter frequency of remote control ⑤ is supported.
- ▶ Replace the batteries in remote control ⑤.

- ▶ Hold remote control ⑤ at various angles from a distance of 0.4 in (1 cm) to 3 in (8 cm) in front of the inside rearview mirror. You should test every position for at least 25 seconds before trying another position.
- ▶ Hold remote control ⑤ at the same angles at various distances in front of the inside rearview mirror. You should test every position for at least 25 seconds before trying another position.
- ▶ Note that some remote controls transmit only for a limited period, press button ⑥ on remote control ⑤ again before transmission ends.
- ▶ Align the antenna line of the door opener unit with the remote control.
- ⓘ Support and additional information on programming:

- On the toll free HomeLink® Hotline on 1-800-355-3515.
- On the Internet at <https://www.homelink.com/mercedes>.

### Opening or closing the door Requirements:

- The corresponding button is programmed to operate the door.

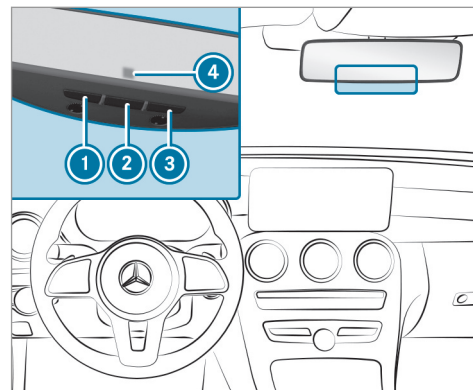

- ▶ Press and hold buttons ①, ② or ③ until the door opens or closes.
- ▶ If indicator lamp ④ flashes yellow after approximately 20 seconds: press and hold

the previously pressed button again until the door opens or closes.

### Clearing the garage door opener memory

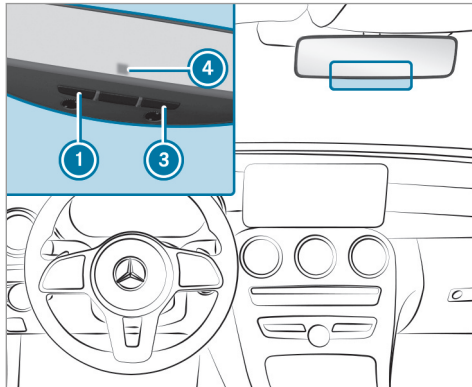

- ▶ Press and hold buttons ① and ③.
- ▶ Indicator lamp ④ lights up yellow.
- ▶ If indicator lamp ④ flashes green: release buttons ① and ③.
- ▶ The entire memory has been deleted.

### Radio equipment approval numbers for the garage door opener

#### Radio equipment approval numbers



#### Brazil

Este equipamento opera em caráter secundário, isto é, não tem direito à proteção contra interferência prejudicial, mesmo de estações do mesmo tipo, e não pode causar interferência a sistemas operando em caráter primário.

Para maiores informações acessar [www.anatel.gov.br](http://www.anatel.gov.br)

### Radio equipment approval numbers

| Country        | Radio type approval number |
|----------------|----------------------------|
| Egypt          | TAC.2511151293.WIR         |
| Andorra        | CE                         |
| Australia      | R-NZ                       |
| Barbados       | MED1578                    |
| Chile          | 2488/DFRS20576/F-74        |
| European Union | CE                         |
| Gibraltar      | CE                         |
| Iceland        | CE                         |
| Jordan         | TRC/LPD/2015/299           |
| Canada         | IC: 4112A-MUAHL5           |
| Kuwait         | CE                         |
| Liechtenstein  | CE                         |

| Country            | Radio type approval number  |
|--------------------|---|
| Mexico             | RCPGEMU15-0448  |
| Monaco             | CE  |
| New Zealand        | R-NZ  |
| Norway             | CE  |
| Russian Federation | Not required  |
| Saudi Arabia       | TA 10525  |
| Switzerland        | CE  |
| South Africa       | <br>TA-2015/1386 |
| Turkey             | Not required  |

| Country              | Radio type approval number          |
|----------------------|-------------------------------------|
| United Arab Emirates | ER41849/15<br>Dealer No: DA35176/14 |
| United States        | FCC ID: NZLMUAHL5                   |

Further information on the declaration of conformity for wireless vehicle components (→ page 25).

### Electric parking brake

#### Electric parking brake function (applying automatically)

**⚠ WARNING** Risk of accident and injury due to children left unattended in the vehicle

If children are left unattended in the vehicle, they could:

- Open doors, thereby endangering other persons or road users.
- Get out and be struck by oncoming traffic.
- Operate vehicle equipment and become trapped, for example.

In addition, the children could also set the vehicle in motion, for example by:

- Releasing the parking brake.
- Changing the transmission position.
- Starting the vehicle.

- ▶ Never leave children unattended in the vehicle.
- ▶ When leaving the vehicle, always take the key with you and lock the vehicle.
- ▶ Keep the vehicle key out of reach of children.

The electric parking brake is applied if the transmission is in position **P** and one of the following conditions is fulfilled:

- The engine is switched off.
- The seat belt tongue is not inserted in the seat belt buckle of the driver's seat and the driver's door is opened.

**i** To prevent application: pull the handle of the electric parking brake.

In the following situations, the electric parking brake is also applied:

- Active Distance Assist DISTRONIC is bringing the vehicle to a standstill.
- The HOLD function is keeping the vehicle stationary.

- Active Parking Assist is keeping the vehicle stationary.

This is the case if one of the following conditions is also fulfilled:

- The engine is switched off.
- The seat belt tongue is not inserted in the seat belt buckle of the driver's seat and the driver's door is opened.
- There is a system malfunction.
- The power supply is insufficient.
- The vehicle is stationary for a lengthy period.

When the electric parking brake is applied, the red **PARK** (USA) or **(P)** (Canada) indicator lamp appears in the instrument cluster.

The electric parking brake is not automatically applied if the engine is switched off by the ECO start/stop function.

### Electric parking brake function (releasing automatically)

The electric parking brake is released when the following conditions are fulfilled:

- The driver's door is closed.
- The engine is running.
- The transmission is in position **D** or **R** and you depress the accelerator pedal or you shift from transmission position **P** to **D** or **R** when on level ground with the driver's door closed.
- If the transmission is in position **R**, the tail-gate must be closed.
- The seat belt tongue is inserted into the seat belt buckle of the driver's seat.

If the seat belt tongue is not inserted into the seat belt buckle of the driver's seat, the following conditions must be fulfilled:

- You shift from transmission position **P**.
- You have previously driven at speeds greater than 2 mph (3 km/h).

When the electric parking brake is released, the red **PARK** (USA) or **(P)** (Canada) indicator lamp in the instrument cluster goes out.

### Applying/releasing the electric parking brake manually

#### Applying

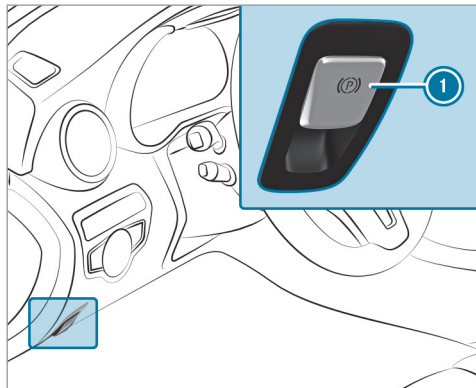

- ▶ Push handle ①.

The red **PARK** (USA) or **(P)** (Canada) indicator lamp appears in the instrument cluster.

- ① The electric parking brake is only securely applied if the indicator lamp is lit continuously.

#### Releasing

- ▶ Switch on the ignition.

- ▶ Pull handle ①.

The red **PARK** (USA) or **(P)** (Canada) indicator lamp in the instrument cluster goes out.

#### Emergency braking

- ▶ Press and hold handle ①.

As long as the vehicle is driving, the **Please Release Parking Brake** message is displayed.

When the vehicle has been braked to a standstill, the electric parking brake is applied. The red **PARK** (USA) or **(P)** (Canada) indicator lamp appears in the instrument cluster.

### Information on detecting damage on a parked vehicle

If a collision is detected when the tow-away alarm is armed on a locked vehicle, you will receive a notification in the multimedia system when you switch on the ignition.

You will receive information about the following points:

- The area of the vehicle that may have been damaged.
- The force of the impact.

The following situations can lead to inadvertent activation:

- The parked vehicle is moved, e.g. in a two-story garage.
- ① Deactivate the tow-away alarm in order to prevent inadvertent activation. If you deactivate the tow-away alarm, damage detection will also be deactivated.



- ⓘ In the case of severe battery discharging, the function for detecting damage on a parked vehicle is automatically deactivated to facilitate the next engine start.

### System limits

Detection may be restricted in the following situations:

- The vehicle is damaged without impact, e.g. if an outside mirror is torn off or the paint is damaged by a key.
- Impact occurs at low speed.
- The electric parking brake is not applied.

### Notes on parking the vehicle for an extended period

If you leave the vehicle parked for longer than six weeks, it may suffer damage through disuse.

The 12 V battery may also be impaired or damaged by heavy discharging.

- ⓘ Further information can be obtained at a qualified specialist workshop.

**Plug-in hybrid:** observe the notes on the high-voltage battery in the Supplement. Otherwise, you may fail to recognize dangers.

### Standby mode (extension of the starter battery's period out of use)

#### Standby mode function

ⓘ This function is not available for all models. If standby mode is activated, energy loss will be minimized during extended periods of non-operation.

Standby mode is characterized by the following:

- the starter battery is preserved.
- the maximum non-operational time appears in the media display.
- the connection to online services is interrupted.
- the ATA (anti-theft alarm system) is not available.
- the interior motion sensor and tow-away alarm functions are not available.

- the function for detecting damage on a parked vehicle is not available.

If the following conditions are fulfilled, standby mode can be activated or deactivated using the multimedia system:

- the engine is switched off.
- the ignition is switched on.

Exceeding the vehicle's displayed non-operational time may cause inconvenience, i.e. it cannot be guaranteed that the starter battery will reliably start the engine.

The starter battery must be charged first in the following situations:

- The vehicle's non-operational time must be extended.
- The **Battery Charge Insufficient for Standby Mode** message appears in the media display.

ⓘ Standby mode is automatically deactivated when the ignition is switched on.

**Activating/deactivating standby mode (parking the vehicle for an extended period)**  
Requirements:

- The engine is switched off.

Multimedia system:

→  » Settings » Vehicle

- ▶ Switch **Standby Mode** on or off. When you activate the function, a prompt appears.
- ▶ Select **Yes**. Standby mode is activated.

### Driving and driving safety systems

#### Driving systems and your responsibility

Your vehicle is equipped with driving systems which assist you in driving, parking and maneuvering the vehicle. The driving systems are aids and do not relieve you of your responsibility pertaining to road traffic law. Pay attention to the traffic conditions at all times and intervene when necessary. Be aware of the limitations regarding the safe use of these systems.

#### Information on radar and ultrasonic sensors

Some driving and driving safety systems use radar or ultrasonic sensors to monitor the area in front of, behind or next to the vehicle (depending on the vehicle's equipment).

Depending on the vehicle's equipment, the radar sensors are integrated behind the bumpers and/or behind the Mercedes star. The ultrasonic sensors are located in the front and rear bumpers. Keep these parts free of dirt, ice and slush (→ page 433). The sensors must not be covered, for example by bicycle racks, overhanging loads, stickers, foil or foils to protect against stone chipping. Additional license plate brackets can likewise impair the function of the ultrasonic sensors. In the event of damage to the bumpers or radiator grill, or following a collision impacting the bumpers or radiator grill, have the function of the sensors checked at a qualified specialist workshop. If the sensors are damaged, some driving systems and driving safety systems may no longer function properly.

#### Overview of driving systems and driving safety systems

In this section, you will find information about the following driving systems and driving safety systems:

- 360° Camera (→ page 228)
- ABS (**A**nti-lock **B**raking **S**ystem) (→ page 185)
- Active Distance Assist DISTRONIC (→ page 201)
- AIR BODY CONTROL (→ page 214)
- Active Brake Assist (→ page 191)
- Active Lane Keeping Assist (→ page 245)
- ATTENTION ASSIST (→ page 238)
- BAS (**B**rake **A**ssist **S**ystem) (→ page 186)
- Hill Start Assist (→ page 213)
- DSR (**D**ownhill **S**peed **R**egulation) (→ page 199)
- EBD (**E**lectronic **B**rakeforce **D**istribution) (→ page 191)

- ESP® (Electronic Stability Program) (→ page 186)
- Off-road ESP® (→ page 189)
- ESP® Crosswind Assist (→ page 190)
- ESP® trailer stabilization (→ page 191)
- Active Speed Limit Assist (→ page 204)
- HOLD function (→ page 213)
- STEER CONTROL (→ page 191)
- Active Steering Assist with rescue lane function (→ page 207)
- Active Emergency Stop Assist (→ page 210)
- Active Parking Assist (→ page 232)
- Parking Assist PARKTRONIC (→ page 220)
- Rear view camera (→ page 225)
- Active Lane Change Assist (→ page 209)
- Cruise control (→ page 197)
- Blind Spot Assist and Active Blind Spot Assist with exit warning (→ page 242)
- Traffic Sign Assist (→ page 240)

### Function of ABS

The Anti-lock Brake System (ABS) regulates the brake pressure in critical driving situations:



- During braking, e.g. at full brake application or insufficient tire traction, the wheels are prevented from locking.
- Vehicle steerability while braking is ensured.

If ABS intervenes when braking, you will feel a pulsing in the brake pedal. The pulsating brake pedal can be an indication of hazardous road conditions and can serve as a reminder to take extra care while driving.

### System limits

- ABS is active from speeds of approx. 5 mph (8 km/h).
- ABS may be impaired or may not function if a malfunction has occurred and the yellow  ABS warning lamp lights up continuously in the instrument cluster after the engine is started.

### Functions of Off-road ABS

 Off-road ABS is activated automatically when you select the  or  drive program.

Off-road ABS is specially adapted for driving off-road:

- The front wheels lock cyclically during braking.
- The braking distance is shortened due to the digging-in effect.

### System limits

- Off-road ABS functions at speeds below 25 mph (40 km/h).
- If Off-road ABS intervenes, the ability to steer may be restricted.

### Function of BAS (Brake Assist System)

**▲ WARNING** Risk of an accident caused by a malfunction in BAS (Brake Assist System)

If BAS is malfunctioning, the braking distance in an emergency braking situation is increased.

- ▶ Depress the brake pedal with full force in emergency braking situations. ABS prevents the wheels from locking.

BAS supports your emergency braking situation with additional brake force.

If you depress the brake pedal quickly, BAS is activated:

- BAS automatically boosts the brake pressure.
- BAS can shorten the braking distance.
- ABS prevents the wheels from locking.

The brakes will function as usual once you release the brake pedal. BAS is deactivated.

### Functions of ESP® (Electronic Stability Program)

**▲ WARNING** Risk of skidding if ESP® is malfunctioning

If ESP® is malfunctioning, ESP® cannot carry out vehicle stabilization. In addition, other driving safety systems are switched off.

- ▶ Drive on carefully.
- ▶ Have ESP® checked at a qualified specialist workshop.

**▲ WARNING** Risk of skidding if ESP® is deactivated

If you deactivate ESP®, ESP® cannot carry out vehicle stabilization.

- ▶ ESP® should only be deactivated in the following situations.

ESP® can monitor and improve driving stability and traction in the following situations, within physical limits:

- When pulling away on wet or slippery roadways.
- When braking.
- **Vehicles with trailer hitch:** in trailer operation from speeds of 40 mph (65 km/h), if the vehicle/trailer combination begins to sway from side to side.
- In strong side winds when you are driving faster than 47 mph (75 km/h).

If the vehicle deviates from the direction desired by the driver, ESP® can stabilize the vehicle by intervening in the following ways:

- One or more wheels are braked.
- The engine output is adapted according to the situation.

ESP® is deactivated if the  ESP® OFF warning lamp lights up continuously in the instrument cluster:

- Driving stability will no longer be improved.

- **Vehicles with trailer hitch:** stabilization of the vehicle/trailer combination is no longer active.
- Crosswind Assist is no longer active.
- The drive wheels could spin.
- ETS/4ETS traction control is still active.

 When ESP® is deactivated, you are still assisted by ESP® when braking.

If the  ESP® warning lamp flashes in the instrument cluster, one or several vehicle wheels has reached its grip limit:

- Adapt your driving style to suit the current road and weather conditions.
- Do not deactivate ESP®.
- Only depress the accelerator pedal as far as is necessary when pulling away.

It can be advantageous to deactivate ESP® in the following situations to improve traction:

- When using snow chains.
- In deep snow.
- On sand or gravel.

 Spinning the wheels results in a cutting action, which enhances traction.

If the  ESP® warning lamp lights up continuously, ESP® is not available due to a malfunction.

Observe the following information:

- Warning and indicator lamps (→ page 553)
- Display messages (→ page 505)

### **ETS/4ETS (Electronic Traction System)**

ETS/4ETS traction control is part of ESP® and makes it possible to pull away and accelerate on a slippery roadway.

ETS/4ETS can improve the vehicle's traction by intervening in the following ways:







- The drive wheels are braked individually if they spin.
- More drive torque is transferred to the wheel or wheels with traction.

### **Influence of drive programs on ESP®**



The drive programs enable ESP® to adapt to different weather and road conditions as well as the driver's preferred driving style. You can select the drive programs using the DYNAMIC SELECT switch (→ page 166).

## ESP® characteristics per drive program

| Drive program  | ESP® mode    | Characteristics   |
|--|--------------|---|
| <input type="checkbox"/> <b>C</b> (Comfort)<br><input type="checkbox"/> <b>E</b> (Economy) | ESP® Comfort | <p>These drive programs provide the ideal balance between traction and stability.</p> <p>Select drive program <input type="checkbox"/> <b>C</b> or <input type="checkbox"/> <b>E</b> both in dry and particularly in difficult road conditions, such as snow or ice, or when the road is wet from rain.</p> |
| <input type="checkbox"/> <b>S</b> (Sport)  | ESP® Sport   | <p>This drive program continues to offer stability but with a sporty setup which allows the enthusiastic driver a more active driving style.</p> <p>Select drive program <input type="checkbox"/> <b>S</b> in good road conditions, for example on dry roads and clear stretches of road.</p>               |

| Drive program  | ESP® mode                                   | Characteristics  |
|--|---|--|
|  (Sport +)  | ESP® Sport +                                | <p>The vehicle's own understeering and oversteering characteristics are accentuated. This allows a more active driving style to be adopted.</p> <p>Select drive program  in good road conditions, for example on dry roads and clear stretches of road.</p>   |
| <p><b>Vehicles with Off-road package:</b></p>  (Off-road)<br> (Off-road +) | <p>Off-road ESP®</p> <p>Off-road + ESP®</p> | <p>These drive programs assist you when driving off-road.</p> <p>Select the  drive program for easily negotiable off-road terrain, e.g. dirt tracks, gravel or sandy surfaces.</p> <p>Select the  drive program for rough terrain, e.g. for steep and/or uneven terrain or for driving on rocky terrain.</p> |

### Function of Off-road ESP®

Off-road ESP® is activated automatically when you select the  or  drive program. It intervenes later if there is oversteering or understeering, thus improving traction.

### Activating/deactivating ESP® (Electronic Stability Program)

Multimedia system:

→  ► Settings ► Quick Access

- ❗ ESP® can only be activated/deactivated using quick access when at least one other function is available in quick access. ESP® can otherwise be found in the [Assistance](#) menu.

**Mercedes-AMG vehicles:** observe the notes in the Supplement. Otherwise, you may fail to recognize dangers.

**Plug-in Hybrid:** observe the notes in the Supplement. Otherwise, you may fail to recognize dangers.

- Select **ESP**.  
A prompt appears.
- Select **On** or  **Off**.

ESP® is deactivated if the  ESP® OFF warning lamp lights up continuously in the instrument cluster.

Observe the information on warning lamps and display messages which may be shown in the instrument cluster.

### Activating/deactivating ESP® (Electronic Stability Program)

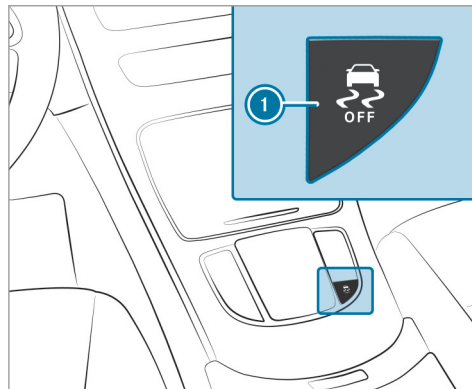

- **To deactivate ESP®:** press button ❶ until the  ESP® OFF warning lamp lights up in

the instrument cluster. The  **OFF** message appears in the multifunction display.

- **To activate ESP®:** briefly press button ❶. The  ESP® OFF warning lamp in the instrument cluster goes out.

Observe the information on warning lamps and display messages which may be shown in the instrument cluster.

### Function of ESP® Crosswind Assist

ESP® Crosswind Assist detects sudden gusts of side wind and helps the driver to keep the vehicle in the lane:

- ESP® Crosswind Assist is active at vehicle speeds between approx. 50 mph (80 km/h) and 125 mph (200 km/h) when driving straight ahead or cornering slightly.
- The vehicle is stabilized by means of individual brake application on one side.



### Function of ESP® trailer stabilization

**▲ WARNING** Risk of accident in poor road and weather conditions

In poor road and weather conditions, the trailer stabilization cannot prevent lurching of the vehicle/trailer combination. Trailers with a high center of gravity may tip over before ESP® detects this.

▶ Always adapt your driving style to suit the current road and weather conditions.

When driving with a trailer, ESP® can stabilize your vehicle if the trailer begins to swerve from side to side:

- ESP® trailer stabilization is active above speeds of 40 mph (65 km/h).
- Slight swerving is reduced by means of a targeted, individual brake application on one side.

- In the event of severe swerving, the engine output is also reduced and all wheels are braked.

ESP® trailer stabilization may be impaired or may not function if:

- The trailer is not connected correctly or is not detected properly by the vehicle.

### Function of EBD (electronic brake force distribution)

EBD is characterized by the following:

- Monitoring and regulating the brake pressure on the rear wheels.
- Improved driving stability when braking, especially on bends.

### Function of STEER CONTROL

STEER CONTROL helps you by transmitting a noticeable steering force to the steering wheel in the direction required for vehicle stabilization.

This steering recommendation is given particularly in the following situations:

- Both right wheels or both left wheels are on a wet or slippery road surface when you brake
- The vehicle starts to skid

### System limits

STEER CONTROL may be impaired or may not function in the following situations:

- ESP® is deactivated.
- ESP® is malfunctioning.
- The steering is malfunctioning.

If ESP® is malfunctioning, you will be assisted further by the electric power steering.

### Function of Active Brake Assist

Active Brake Assist consists of the following functions:

- Distance warning function
- Autonomous braking function

- Situation-dependent braking assistance
- **Vehicles with Driving Assistance Package:** Evasive Steering Assist and cornering function

Active Brake Assist can help you to minimize the risk of a collision with vehicles, cyclists or pedestrians, or reduce the effects of such a collision.

If Active Brake Assist has detected a risk of collision, a warning tone sounds and the  distance warning lamp lights up in the instrument cluster.

If you do not react to the warning, autonomous braking can be initiated in critical situations.

In especially critical situations, Active Brake Assist can initiate autonomous braking directly. In this case, the warning lamp and warning tone occur simultaneously with the braking application.

If you apply the brake yourself in a critical situation or apply the brake during autonomous braking, situation-dependent braking assistance

occurs. The brake pressure increases up to maximum full-stop braking if necessary.

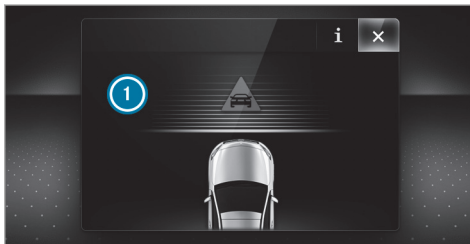

If autonomous braking or situation-dependent braking assistance has occurred, display  appears in the multifunction display and then automatically goes out after a short time.

If the autonomous braking function or the situation-dependent braking assistance is triggered, additional preventive measures for occupant protection (PRE-SAFE®) may also be initiated.

 **WARNING** Risk of an accident caused by limited detection performance of Active Brake Assist

Active Brake Assist cannot always clearly identify objects and complex traffic situations.

In such cases, Active Brake Assist might:

- Give a warning or brake without reason
- Not give a warning or not brake

▶ Always pay careful attention to the traffic situation; do not rely on Active Brake Assist alone. Active Brake Assist is only an aid. The driver is responsible for maintaining a suitable distance to the vehicle in front, vehicle speed and for braking in good time.

▶ Be prepared to brake or swerve if necessary.

 If the system is unavailable, the  display appears in the multifunction display.

Also observe the system limits of Active Brake Assist.

**The individual subfunctions are available in the following speed ranges:**

The distance warning function issues a warning in the following situations:

- From approximately 4 mph (7 km/h), if your vehicle is critically close to a vehicle or

pedestrian, you will hear an intermittent warning tone and the  distance warning lamp lights up in the instrument cluster.

Brake immediately or take evasive action, provided it is safe to do so and the traffic situation allows this.

**The distance warning function can aid you in the following situations with an intermittent warning tone and a warning lamp:**

|   | Vehicles traveling in front      | Stationary vehicles             | Crossing vehicles              | Moving pedestrians             | Stationary pedestrians         | Crossing cyclists              | Cyclists traveling in front    | Stationary cyclists            |
|---|----------------------------------|---------------------------------|--------------------------------|--------------------------------|--------------------------------|--------------------------------|--------------------------------|--------------------------------|
| Vehicles without Driving Assistance Package | Up to approx. 155 mph (250 km/h) | Up to approx. 50 mph (80 km/h)  | No reaction                    | Up to approx. 50 mph (80 km/h) | No reaction                    | Up to approx. 37 mph (60 km/h) | Up to approx. 50 mph (80 km/h) | No reaction                    |
| Vehicles with Driving Assistance Package    | Up to approx. 155 mph (250 km/h) | Up to approx. 62 mph (100 km/h) | Up to approx. 43 mph (70 km/h) | Up to approx. 50 mph (80 km/h) | Up to approx. 43 mph (70 km/h) | Up to approx. 43 mph (70 km/h) | Up to approx. 50 mph (80 km/h) | Up to approx. 43 mph (70 km/h) |

The autonomous braking function may intervene at speeds starting from approximately 4 mph (7 km/h) in the following situations:

|   | Vehicles traveling in front      | Stationary vehicles             | Crossing vehicles              | Moving pedestrians             | Stationary pedestrians         | Crossing cyclists              | Cyclists traveling in front    | Stationary cyclists            |
|---|----------------------------------|---------------------------------|--------------------------------|--------------------------------|--------------------------------|--------------------------------|--------------------------------|--------------------------------|
| Vehicles without Driving Assistance Package | Up to approx. 124 mph (200 km/h) | Up to approx. 31 mph (50 km/h)  | No reaction                    | Up to approx. 37 mph (60 km/h) | No reaction                    | Up to approx. 37 mph (60 km/h) | Up to approx. 50 mph (80 km/h) | No reaction                    |
| Vehicles with Driving Assistance Package    | Up to approx. 155 mph (250 km/h) | Up to approx. 62 mph (100 km/h) | Up to approx. 43 mph (70 km/h) | Up to approx. 43 mph (70 km/h) | Up to approx. 43 mph (70 km/h) | Up to approx. 43 mph (70 km/h) | Up to approx. 50 mph (80 km/h) | Up to approx. 43 mph (70 km/h) |

Situation-dependent braking assistance may intervene at speeds starting from approximately 4 mph (7 km/h) in the following situations:

|   | Vehicles traveling in front      | Stationary vehicles             | Crossing vehicles              | Moving pedestrians             | Stationary pedestrians         | Crossing cyclists              | Cyclists traveling in front    | Stationary cyclists            |
|---|----------------------------------|---------------------------------|--------------------------------|--------------------------------|--------------------------------|--------------------------------|--------------------------------|--------------------------------|
| Vehicles without Driving Assistance Package | Up to approx. 155 mph (250 km/h) | Up to approx. 50 mph (80 km/h)  | No reaction                    | Up to approx. 37 mph (60 km/h) | No reaction                    | Up to approx. 37 mph (60 km/h) | Up to approx. 50 mph (80 km/h) | No reaction                    |
| Vehicles with Driving Assistance Package    | Up to approx. 155 mph (250 km/h) | Up to approx. 62 mph (100 km/h) | Up to approx. 43 mph (70 km/h) | Up to approx. 43 mph (70 km/h) | Up to approx. 43 mph (70 km/h) | Up to approx. 43 mph (70 km/h) | Up to approx. 50 mph (80 km/h) | Up to approx. 43 mph (70 km/h) |

### Canceling a brake application of Active Brake Assist

You can cancel a brake application of Active Brake Assist at any time by:

- Fully depressing the accelerator pedal or with kickdown.
- Releasing the brake pedal.

Active Brake Assist may cancel the brake application when one of the following conditions is fulfilled:

- You maneuver to avoid the obstacle.
- There is no longer a risk of collision.
- An obstacle is no longer detected in front of your vehicle.

### Evasive Steering Assist (only vehicles with Driving Assistance Package)

Evasive Steering Assist has the following characteristics:

- The ability to detect stationary or moving pedestrians.
- Assistance through power-assisted steering if it detects a swerving maneuver.

- Activation by an abrupt steering movement during a swerving maneuver.
- Assistance during swerving and straightening of the vehicle.
- Reaction from a speed of approximately 12 mph (20 km/h) up to a speed of approximately 43 mph (70 km/h).

You can prevent the assistance at any time by actively steering.

#### **Cornering function (only vehicles with Driving Assistance Package)**

If a danger of collision from an oncoming vehicle is detected when turning across an oncoming lane, autonomous braking can be initiated at speeds below 9 mph (15 km/h) before you have left the lane in which you are driving.

**⚠ WARNING** Risk of an accident despite Evasive Steering Assist

Evasive Steering Assist cannot always clearly identify objects and complex traffic situations.

In addition, the steering support of Evasive Steering Assist is generally not sufficient to avoid a collision.

In such cases Evasive Steering Assist can:

- give an unnecessary warning or provide assistance
- not give a warning or not provide assistance

▶ Always pay careful attention to the traffic situation; do not rely on Evasive Steering Assist alone.

▶ Be ready to brake and take evasive action if necessary.

▶ Prevent the assistance by actively steering in non-critical driving situations.

▶ Drive at an appropriate speed if pedestrians are close to the path of your vehicle.

#### **System limits**

Full system performance is not available for a few seconds after switching on the ignition or after driving off.

The system may be impaired or may not function in the following situations:

- In snow, rain, fog, heavy spray, if there is glare, in direct sunlight or in greatly varying ambient light.
- If the sensors are dirty, fogged up, damaged or covered.
- If the sensors are impaired due to interference from other radar sources, e.g. strong radar reflections in parking garages.
- If a loss of tire pressure or a faulty tire has been detected and displayed.
- If DSR is activated.
- In complex traffic situations where objects cannot always be clearly identified.
- If pedestrians or vehicles move quickly into the sensor detection range.
- If pedestrians are hidden by other objects.

- If the typical outline of a pedestrian cannot be distinguished from the background.
  - If a pedestrian is not detected as such, e.g. due to special clothing or other objects.
  - On bends with a tight radius.
- i** The Active Brake Assist sensors adjust automatically while a certain distance is being driven after the vehicle has been delivered. Active Brake Assist is unavailable or only partially available during this teach-in period.

### Setting Active Brake Assist

#### Requirements:

- The ignition is switched on.

Multimedia system:

→  » Settings » Assistance  
» Active Brake Assist

The following settings are available:

- Early
- Medium
- Late

- ▶ Select a setting.  
The setting is retained when the engine is next started.

#### Deactivating Active Brake Assist

- i** It is recommended that you always leave Active Brake Assist activated.
- ▶ Select **Off**.  
The distance warning function, the autonomous braking function and the Evasive Steering Assist are deactivated.  
When the vehicle is next started, the middle setting is automatically selected.
- i** If Active Brake Assist is deactivated, the  symbol appears in the status bar of the multifunction display.

### Speed control cruise control

#### Function of cruise control

Cruise control regulates the speed to the value selected by the driver.

If you accelerate to overtake, for example, the stored speed is not deleted. If you remove your

foot from the accelerator pedal after overtaking, cruise control will resume speed regulation back to the stored speed.

Cruise control is operated using the corresponding steering wheel buttons. You can store any speed above 15 mph (20 km/h) up to the maximum speed.

If you fail to adapt your driving style, cruise control can neither reduce the risk of an accident nor override the laws of physics. It cannot take into account road, weather or traffic conditions. Cruise control is only an aid. The driver is responsible for the distance to the vehicle in front, for vehicle speed, for braking in good time and for staying in lane.

**Mercedes-AMG vehicles:** Cruise control is available up to a maximum speed of 155 mph (250 km/h).

#### Displays on the multifunction display

The status of cruise control and the stored speed are shown in the multifunction display.

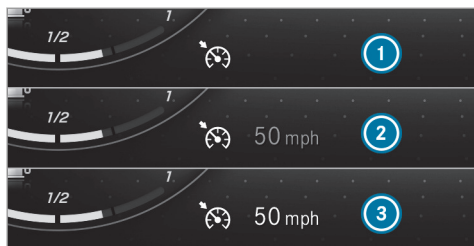

- 1 Cruise control is selected
  - 2 Speed is saved, cruise control is deactivated
  - 3 Speed is saved, cruise control is activated
- i The segments between the stored speed and the end of the segment display light up in the speedometer.

### System limits

Cruise control may be unable to maintain the stored speed on uphill gradients. The stored speed is resumed when the gradient evens out.

Change into a lower gear in good time on long and steep downhill gradients. Take particular note of this when driving a laden vehicle. By

doing so, you will make use of the engine's braking effect. This relieves the load on the brake system and prevents the brakes from overheating and wearing too quickly.

Do not use cruise control in the following situations:

- In traffic situations which require frequent changes of speed, e.g. in heavy traffic, on winding roads.
- On slippery roads. Accelerating can cause the drive wheels to lose traction and the vehicle could then skid.
- If you are driving when visibility is poor.

### Operating cruise control

**⚠ WARNING** Risk of accident due to stored speed

If you call up the stored speed and this is lower than your current speed, the vehicle decelerates.

- ▶ Take into account the traffic situation before calling up the stored speed.

### Requirements:

- ESP® must be activated, but not intervening.
- The driven speed is at least 15 mph (20 km/h).
- The transmission is in position **D**.

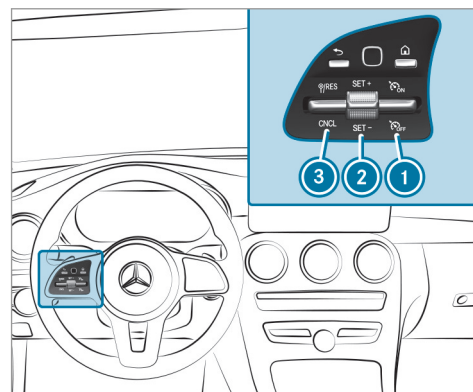

- ▶ **To activate cruise control:** press rocker switch 1 up.



- ▶ **To activate cruise control:** press rocker switch ② up (SET+) or down (SET-). The current speed is stored and maintained by the vehicle.
- or
- ▶ Press rocker switch ③ up (RES). The last stored speed is called up and maintained by the vehicle. If the last stored speed has previously been deleted, the currently driven speed is stored.
- ⓘ When you switch off the vehicle, the last speed stored is cleared.
- ▶ **To increase/reduce speed:** press rocker switch ② up (SET+) or down (SET-) to the pressure point. The stored speed is increased or reduced by 1 mph (1 km/h).
- or
- ▶ Press rocker switch ② up (SET+) or down (SET-) beyond the pressure point. The stored speed is increased or reduced by 5 mph (10 km/h).
- or

- ▶ Accelerate the vehicle to the desired speed.
- ▶ Press rocker switch ② up (SET+). If cruise control is activated and Traffic Sign Assist has detected a speed restriction sign with a maximum permissible speed and this is displayed in the instrument cluster, you can choose between the following options:
- ▶ **To adopt the detected speed:** press rocker switch ③ up (RES). The maximum permissible speed shown by the traffic sign is stored and the vehicle maintains this speed.
- ▶ **To deactivate cruise control:** press rocker switch ③ down (CNCL).
- ▶ **To deactivate cruise control:** press rocker switch ① down.
- ⓘ If you brake, deactivate ESP® or if ESP® intervenes, cruise control is deactivated.

### DSR (Downhill Speed Regulation)

#### Function of DSR (Downhill Speed Regulation)

DSR is an aid to assist you when driving downhill. It keeps the speed of travel at the selected

target speed. The steeper the downhill gradient, the greater the DSR braking effect on the vehicle. On flat stretches of road and uphill gradients, the DSR brakes the vehicle minimally or not at all.

When DSR is activated and the transmission is in position **D**, **R** or **N**, DSR controls the driving speed. The target speed can be set to a value between 1 mph (2 km/h) and 11 mph (18 km/h). By braking or accelerating, you can drive at a higher or lower speed than the target speed at any time.

DSR is deactivated automatically if you drive at speeds greater than 28 mph (45 km/h) or select drive program **S** or **S**. The  Off message then appears in the multifunction display. The status indicator in the multifunction display disappears. You also hear a warning tone.

## Notes on DSR

**⚠ WARNING** Risk of skidding and having an accident when DSR is activated on slippery road surfaces

If the speed driven and the target speed differ, and you activate DSR on a slippery road surface, the wheels may lose traction.

- ▶ Take into account the road surface and the difference between the driving speed and target speed before activating DSR.

If you fail to adapt your driving style, DSR can neither reduce the risk of an accident nor override the laws of physics. It cannot take into account road, weather or traffic conditions. DSR is only an aid. You are responsible for maintaining a safe distance to the vehicle in front, for vehicle speed, for braking in good time and for staying in lane.

You are always responsible for keeping control of the vehicle and for assessing whether the downhill gradient can be managed. Depending on road surface and tires, DSR may not always be

able to keep to the target speed. Select a target speed suitable for the environmental conditions and also apply the brakes yourself if required.

### Activating/deactivating DSR (Downhill Speed Regulation)

#### Requirements:

- You are driving at 24 mph (40 km/h) or slower.
- If the current vehicle speed is too high, the **Max. Speed 24 mph** message appears in the multifunction display.
- Active Distance Assist DISTRONIC is deactivated.

Multimedia system:

➔  **Settings** ➔ **Quick Access**

- ▶ Select .

A status display appears in the multifunction display when the function is activated.

### Changing the target speed

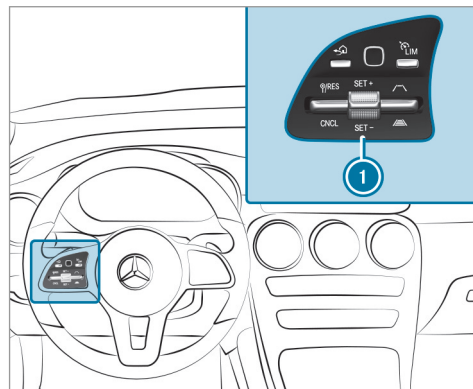

- ▶ **To increase or decrease the target speed:**

press rocker switch  up to the point of resistance for a higher target speed and down for a lower target speed.

The selected target speed increases or decreases by 1 mph (1 km/h) and appears with the DSR symbol in the multifunction display.

- ① The target speed always adjusts in 1 mph (1 km/h) increments. This is regardless of whether you press the rocker switch to or beyond the point of resistance.

### Active Distance Assist DISTRONIC

#### Function of Active Distance Assist DISTRONIC

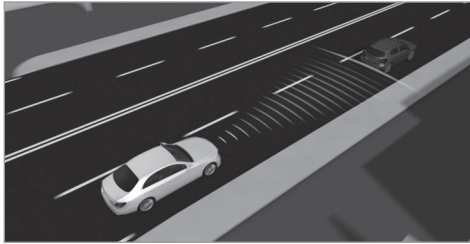

Active Distance Assist DISTRONIC maintains the set speed on free-flowing roads. If vehicles in front are detected, the set distance is maintained, if necessary, until the vehicle comes to a halt. The vehicle accelerates or brakes depending on the distance to the vehicle in front and

the set speed. The speed and distance to the vehicle in front are set and saved on the steering wheel on vehicles without the Driving Assistance Package, in the range between 15 mph (20 km/h) and 120 mph (200 km/h) and, on vehicles with the Driving Assistance Package, in the range between 15 mph (20 km/h) and 130 mph (210 km/h).

The adjustable set speed can vary due to the following factors:

- **Plug-in hybrid:** drive program selected, observe the relevant notes in the Supplement.
- Maximum speed, e.g. winter tire limit

Other features of Active Distance Assist DISTRONIC:

- Adjusts the driving style depending on the selected drive program (fuel efficient, comfortable or dynamic) (→ page 165)
- **Vehicles with Driving Assistance Package:** reacts to stationary vehicles detected in urban speed ranges (except bicycles and motorcycles).

- Initiates acceleration to the stored speed if the turn signal indicator is switched on to change to the overtaking lane.
- **Vehicles with Driving Assistance Package:** takes one-sided overtaking restrictions into account on highways or on multi-lane roads with separate roadways (country-dependent).

**Vehicles with Active Parking Assist and Driving Assistance Package:** if the vehicle has been braked to a standstill on multi-lane, separate roadways by Active Distance Assist DISTRONIC, it can automatically follow the vehicle in front driving off again within 30 seconds. If a critical situation is detected when driving off, a visual and acoustic warning is given indicating that the driver must now take control of the vehicle. The vehicle is not accelerated any further.

Active Distance Assist DISTRONIC is only an aid. The driver is responsible for keeping a safe distance to the vehicle in front, for vehicle speed and for braking in good time.

### System limits

The system may be impaired or may not function in the following situations:

- In snow, rain, fog, heavy spray, if there is glare, in direct sunlight or in greatly varying ambient light.
- If there is swirling dust, e.g. when driving off-road or on sandy surfaces.
- The windshield in the area of the camera is dirty, fogged up, damaged or covered.
- If the radar sensors are dirty or covered.
- In parking garages or on roads with steep uphill or downhill gradients.
- If there are narrow vehicles in front, such as bicycles or motorcycles.

In addition, on slippery roads, braking or accelerating can cause one or several wheels to lose traction and the vehicle could then skid.

Do not use Active Distance Assist DISTRONIC in these situations.

**⚠ WARNING** Risk of accident from acceleration or braking by Active Distance Assist DISTRONIC

Active Distance Assist DISTRONIC may accelerate or brake in the following cases, for example:

- If the vehicle pulls away using Active Distance Assist DISTRONIC.
  - If the stored speed is called up and is considerably faster or slower than the currently driven speed.
  - If Active Distance Assist DISTRONIC no longer detects a vehicle in front or does not react to relevant objects.
- ▶ Always carefully observe the traffic conditions and be ready to brake at all times.
- ▶ Take into account the traffic situation before calling up the stored speed.

**⚠ WARNING** Risk of accident due to insufficient deceleration by Active Distance Assist DISTRONIC

Active Distance Assist DISTRONIC brakes your vehicle with up to 50% of the maximum possible deceleration. If this deceleration is not sufficient, Active Distance Assist DISTRONIC alerts you with a visual and acoustic warning.

- ▶ In these cases, adjust your speed and keep a sufficient distance.
- ▶ Brake the vehicle yourself and/or take evasive action.

**⚠ WARNING** Risk of accident if detection function of Active Distance Assist DISTRONIC is impaired

Active Distance Assist DISTRONIC does not react or has a limited reaction:

- when driving on a different lane or when changing lanes

- to pedestrians, animals, bicycles or stationary vehicles, or unexpected obstacles
- to complex traffic conditions
- to oncoming vehicles and crossing traffic

As a result, Active Distance Assist DISTRONIC may neither give warnings nor intervene in such situations.

▶ Always observe the traffic conditions carefully and react accordingly.

#### Operating Active Distance Assist DISTRONIC Requirements:

- The vehicle has been started.
- The electric parking brake is released.
- ESP® is activated and is not intervening.
- The transmission is in position **D**.
- The driver's door is closed.
- The check of the radar sensor system has been successfully completed (vehicle traveling faster than 12 mph (20 km/h))

- Parking Assist PARKTRONIC is not being used to park the vehicle or to exit from a parking space.
- DSR is deactivated.
- The vehicle does not skid.

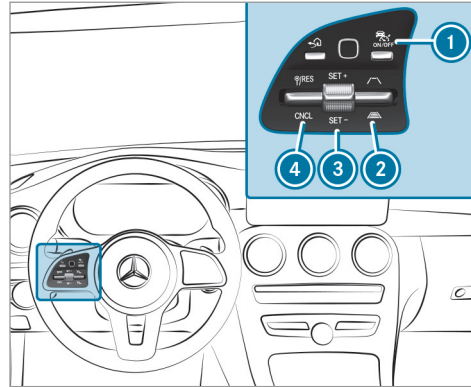

- ▶ **To activate/deactivate Active Distance Assist DISTRONIC:** press button ①.

- ▶ **To activate Active Distance Assist DISTRONIC:** press rocker switch ③ up (SET+) or down (SET-), or press rocker switch ④ up (RES). Remove your foot from the accelerator pedal. The current speed is stored and maintained by the vehicle.

or

- ▶ **To activate Active Distance Assist DISTRONIC with a stored speed:** press rocker switch ④ up (RES). Remove your foot from the accelerator pedal.

① By pressing rocker switch ④ up again, the speed limitation shown in the instrument cluster will be adopted by Active Distance Assist DISTRONIC.

- ▶ **To accept the displayed speed restriction when Active Distance Assist DISTRONIC is active:** press rocker switch ④ up (RES). The speed limit displayed in the instrument cluster is adopted as the stored speed. The vehicle adapts its speed to that of the vehicle in front, but only up to the stored speed.

▶ **To pull away with Active Distance Assist DISTRONIC:** remove your foot from the brake pedal and activate Active Distance Assist DISTRONIC.

▶ Press rocker switch ④ up (RES).

or

▶ Depress the accelerator pedal briefly and firmly.

The functions of Active Distance Assist DISTRONIC continue to be carried out.

**⚠ WARNING** Risk of accident due to Active Distance Assist DISTRONIC still being activated when you leave the driver's seat

If you leave the driver's seat while the vehicle is being braked by Active Distance Assist DISTRONIC only, the vehicle can roll away.

▶ Always deactivate Active Distance Assist DISTRONIC and secure the vehicle to prevent it from rolling away before you leave the driver's seat.

▶ **To deactivate Active Distance Assist DISTRONIC:** press rocker switch ④ down (CNCL).

▶ **To increase/reduce speed:** press rocker switch ③ up (SET+) or down (SET-) to the pressure point. The stored speed is increased or reduced by 1 mph (1 km/h).

or

▶ Press rocker switch ③ up (SET+) or down (SET-) to the pressure point and hold. The stored speed is increased or reduced in increments of 1 mph (1 km/h).

or

▶ Press rocker switch ③ up (SET+) or down (SET-) beyond the pressure point. The stored speed is increased or reduced by 5 mph (10 km/h).

or

▶ Press rocker switch ③ up (SET+) or down (SET-) and hold beyond the pressure point. The stored speed is increased or reduced in increments of 5 mph (10 km/h).

▶ **To increase or reduce the specified distance from the vehicle in front:** press rocker switch ② up or down.

### Function of Active Speed Limit Assist

ⓘ The following function is country-dependent and only available in conjunction with the Driving Assistance Package.

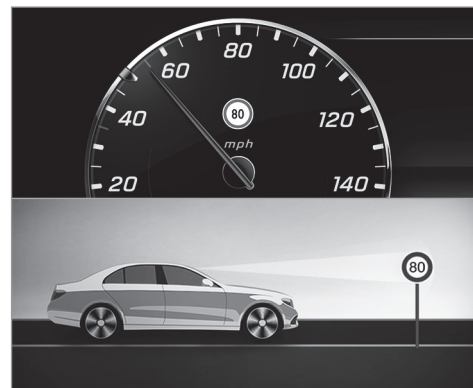

If a change in the speed limit is detected and automatic adoption of speed limits is activated, the new speed is automatically adopted as the stored speed (→ page 241).

The driven speed is adjusted when the vehicle is level with the traffic sign at the latest. In the case of signs indicating entry into an urban area, the speed is adapted according to the speed permitted within the urban area. The speed limit display in the Instrument Display is always updated when the vehicle is level with the traffic sign.

If there is no speed restriction on an unlimited stretch of road (e.g. on a freeway), the recommended speed is automatically adopted as the stored speed. The system uses the speed stored on an unlimited stretch of road as the recommended speed. If you do not alter the stored speed on an unlimited stretch of road, the recommended speed is 80 mph (130 km/h).

If Active Distance Assist DISTRONIC has been put into passive mode by pressing the accelerator pedal, only speed limits which are higher than the set speed are adopted.

Active Speed Limit Assist is only an aid. The driver is responsible for keeping a safe distance from the vehicle in front, for vehicle speed and for braking in good time. The maximum permissible speed also depends on factors such as the road surface and traffic conditions.

#### System limits

Temporary speed restrictions (e.g. for a certain time or due to weather conditions) cannot be properly detected by the system. The maximum permissible speed applying to a vehicle with a trailer is not detected by the system. In these situations you must adjust your speed yourself.

**⚠ WARNING** Risk of accident due to Active Speed Limit Assist adapting the vehicle's speed

The speed adopted by Active Speed Limit Assist may be too high or incorrect in some individual cases, such as:

- In the wet or in fog
- When towing a trailer

- ▶ Ensure that the driven speed complies with traffic regulations.
- ▶ Adjust the driving speed to suit current traffic and weather conditions.

#### Function of route-based speed adaptation

- ① The following function is country-dependent and only available in conjunction with the Driving Assistance Package.

When Active Distance Assist DISTRONIC is activated, the vehicle speed will be adjusted accordingly to the route events ahead. Depending on the drive program selected, the vehicle negotiates a route event ahead in a fuel-saving, comfortable or dynamic manner. When the route event has been passed, the vehicle accelerates again to the stored speed. The set distance to the vehicle in front, vehicles detected ahead and speed restrictions ahead are taken into account.

Route-based speed adaptation can be configured in the multimedia system (→ page 206).

The following route events are taken into account:

- Bends
- T-intersections, traffic circles and toll stations
- Turns and exits
- Traffic jams ahead (only with Live Traffic (→ page 351))

**i** When the toll station is reached, Active Distance Assist DISTRONIC adopts the speed as the stored speed.

Also, the speed is reduced if the turn signal indicator to change lanes is switched on and one of the following situations is detected:

- Turning off at intersections
- Driving on slowing-down lanes
- Driving on lanes adjacent to slowing-down lanes

The driver is responsible for choosing the right speed and observing other road users. This applies in particular to intersections, traffic circles and traffic lights, as route-based speed

adaptation does not brake the vehicle to a standstill.

When route guidance is active, the first speed adjustment is carried out automatically. If the turn signal indicator is switched on, the selected route is confirmed and further speed adjustment is activated.

Speed adjustment is canceled in the following cases:

- If the turn signal indicator is switched off before the route event.
- If the driver depresses the accelerator or brake pedal during the process.

### System limits

Route-based speed adaptation does not take right of way regulations into account. The driver is responsible for complying with road traffic regulations and driving at a suitable speed.

In difficult conditions, for example unclear roads, lane narrowing, wet road surfaces, snow or ice, or when driving with a trailer, the speed adjustment made by the system may not always be suitable. In these situations the driver must intervene accordingly.

### **⚠ WARNING** Risk of accident in spite of route-based speed adjustment

Route-based speed adjustment might malfunction or be temporarily unavailable in the following situations:

- If map data is not up to date or available
- If you do not follow the selected route guidance
- If the set route is re-planned
- In road construction areas
- When towing a trailer
- In bad weather or road conditions
- If the accelerator pedal is depressed

▶ Adjust the speed to the traffic situation.

### Setting route-based speed adaptation

#### Requirements:

- Active Distance Assist DISTRONIC is activated.



Multimedia system:

→  » Settings » Assistance  
 » Route-based Speed

▶ Activate or deactivate the function. When the function is active, the vehicle speed is adjusted depending on the route events ahead.

❶ Further information on the route-based speed adaptation (→ page 205).

## Active Steering Assist



### Function of Active Steering Assist

❶ The following function is country-dependent and only available in conjunction with the Driving Assistance Package.

Active Steering Assist is only available up to a speed of 130 mph (210 km/h). The system helps you to stay in the center of the lane by means of moderate steering interventions. Depending on the speed driven, Active Steering Assist uses the vehicles ahead and lane markings as a reference.

❶ Depending on the country, in the lower speed range Active Steering Assist can use the surrounding traffic as a reference. If necessary, Active Steering Assist can then also provide assistance when driving outside the center of the lane to form a rescue lane, for example.

When the system is actively steering, the  symbol is shown in green in the multifunction display.

If the detection of lane markings and vehicles ahead is impaired, Active Steering Assist switches to passive mode. The system provides no support in this case. During the transition from active to passive status, the  symbol is shown as enlarged and flashing. Once the system is passive, the  symbol is shown as gray in the multifunction display.

### Steering and touch detection

The driver is required to keep their hands on the steering wheel at all times and be able to intervene at any time to correct the course of the vehicle and keep it in lane. The driver must

expect a change from active to passive mode or vice versa at any time.

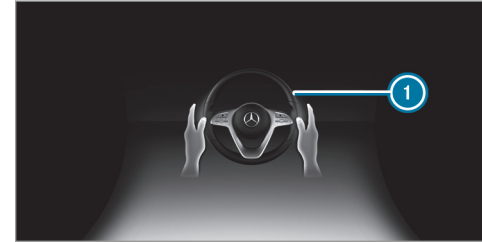

If the system detects that the driver has not steered the vehicle for a considerable period of time or has removed their hands from the steering wheel, an optical warning is given first. Display ❶ appears in the multifunction display. If the driver still does not steer the vehicle, or gives no confirmation to the system, a warning tone sounds in addition to the visual warning message.

The warning is not issued, or is stopped, when the driver gives confirmation to the system:

- The driver steers the vehicle.

- The driver presses a steering wheel button or operates Touch Control.

If Active Steering Assist detects that a system limit has been reached, a visual warning is issued and a warning tone sounds.

Active Steering Assist is only an aid. The driver is responsible for the distance to the vehicle in front, for vehicle speed, for braking in good time and for staying in lane. Before changing lanes, the driver must make sure that the neighboring lane is free (glance over the shoulder).

### System limits

Active Steering Assist has a limited steering torque for lateral guidance. In some cases, the steering intervention is not sufficient to keep the vehicle in the lane or to drive through exits.

The system may be impaired or may not function in the following instances:

- There is poor visibility, e.g. due to snow, rain, fog, heavy spray, greatly varying ambient light or strong shadows on the roadway.
- There is glare, e.g. from oncoming traffic, direct sunlight or reflections.

- Insufficient road illumination.
- The windshield is dirty, fogged up, damaged or covered in the vicinity of the camera, e.g. by a sticker.
- No, or several, unclear lane markings are present for one lane, or the markings change quickly, e.g. in a construction area or intersections.
- The lane markings are worn away, dark or covered up, e.g. by dirt or snow.
- The distance to the vehicle in front is too small and the lane markings thus cannot be detected.
- The road is narrow and winding.
- There are obstacles on the lane or projecting out into the lane, such as object markers.

The system does not provide assistance in the following conditions:

- On tight bends and when turning.
- When crossing intersections.
- At traffic circles or toll stations.
- When towing a trailer.

- When actively changing lane without switching on the turn signal indicator.
- When the tire pressure is too low.

Depending on the selected vehicle settings, Active Steering Assist may be unavailable. Observe the status display of Active Steering Assist in the multifunction display (→ page 211).

**⚠ WARNING** Risk of accident if Active Steering Assist unexpectedly stops functioning

If the system limits of Active Steering Assist are reached there is no guarantee that the system will remain active or will keep the vehicle in lane.

- ▶ Always keep your hands on the steering wheel and observe the traffic carefully.
- ▶ Always steer the vehicle paying attention to traffic conditions.

**⚠ WARNING** Risk of accident if Active Steering Assist unexpectedly intervenes

A malfunction in the detection of lane markings and objects can occur.

This could cause unexpected steering intervention.

▶ Steer according to traffic conditions.

### Activating/deactivating Active Steering Assist

#### Requirements:

- ESP® is activated, but is not intervening.
- Active Distance Assist DISTRONIC is activated.

Multimedia system:

➔  ➔ Settings ➔ Quick Access

▶ Select  Steering Assist.

#### Function of Active Lane Change Assist

**i** The following function is country-dependent and only available in conjunction with the Driving Assistance Package.

Active Lane Change Assist supports the driver when changing lanes by applying steering torque if the driver operates a turn signal indicator.

Assistance when changing lanes is provided if all the following conditions are met:

- You are driving on a freeway or road with multiple lanes in the direction of travel.
- The neighboring lane is separated by a broken lane marking.
- No vehicle is detected in the adjacent lane.
- The driven speed is between 50 mph (80 km/h) and 110 mph (180 km/h).
- Active Lane Change Assist is switched on in the multimedia system.
- Active Steering Assist is switched on and active.

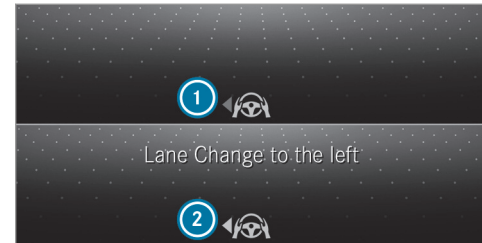

If no vehicle is detected in the adjacent lane and a lane change is permitted, the lane change begins after the driver has activated the turn signal indicator. This is shown to the driver with a green arrow **2** next to the steering wheel symbol. The **Lane Change to the Left** message also appears, for example. If Active Lane Change Assist has been activated with the turn signal indicator but a lane change is not immediately possible, a gray arrow **1** appears next to the steering wheel symbol, which remains green.

When the lane change assistance starts, the turn signal indicator is automatically activated along with the display in the multifunction display.

If the assistance graphic is shown when changing lanes, the lane change display appears with an additional arrow pointing towards the adjacent lane (→ page 211).

If a lane change is not possible, the arrow fades out after a few seconds and a new lane change must be initiated. An immediate lane change is only possible on freeway sections without speed limits.

If the system is impaired, Active Lane Change Assist may be canceled. If it is canceled, the **Lane Change Canceled** message appears in the multifunction display and a warning tone sounds.

**⚠ WARNING** Risk of accident from changing lane to an occupied adjacent lane

Lane Change Assist cannot always detect clearly if the adjacent lane is free.

The lane change might be initiated although the adjacent lane is not free.

- ▶ Before changing lanes, make sure that the neighboring lane is free and there is no danger to other road users.

- ▶ Monitor the lane change.

**⚠ WARNING** Risk of accident if Lane Change Assist unexpectedly stops functioning

If the system limitations for Lane Change Assist have been reached, there is no guarantee that the system will remain active.

Lane Change Assist cannot then assist you by applying steering torques.

- ▶ Always monitor the lane change and keep your hands on the steering wheel. Observe the traffic conditions and steer and/or brake if necessary.

### System limits

The system limitations of Active Steering Assist apply to Active Lane Change Assist (→ page 207).

The system may also be impaired or may not function in the following situations:

- The sensors in the rear bumper are dirty, damaged or covered by a sticker or ice and snow, for example.
- The exterior lighting is malfunctioning.
- ⓘ The Active Lane Change Assist sensors adjust automatically while a certain distance is being driven after the vehicle has been delivered. Active Lane Change Assist is unavailable or only partially available during this teach-in period, no arrow appears next to the  Active Steering Assist symbol when the turn signal indicator is activated.

### Activating/deactivating Active Lane Change Assist

Multimedia system:

-  ▶ [Settings](#) ▶ [Assistance](#)  
▶ [Active Lane Change Assist](#)
- ▶ Activate or deactivate the function.

### Function of Active Emergency Stop Assist

If the driver continually ignores the visual or acoustic warning to put their hands on the steer-

ing wheel, the **Beginning Emergency Stop** message appears in the multifunction display. If the driver still does not respond, Active Distance Assist DISTRONIC reduces the speed. The vehicle is decelerated in stages to a standstill.

Depending on the country, at speeds below 40 mph (60 km/h) the hazard warning lights switch on automatically.

When the vehicle is stationary, the following actions are carried out:

- the vehicle is secured with the electric parking brake
- Active Distance Assist DISTRONIC is ended
- the vehicle is unlocked
- if possible, an emergency call is placed to the Mercedes-Benz emergency call center

The driver can cancel the deceleration at any time by performing one of the following actions:

- steering
- braking or accelerating
- pressing a steering-wheel button
- operating Touch Control

- activating or deactivating Active Distance Assist DISTRONIC

### Overview of Active Distance Assist DISTRONIC displays in the instrument cluster

The assistance graphic and the status display show the status of the following functions in the instrument cluster:

- Active Distance Assist DISTRONIC
- Route-based speed adaptation
- Active Steering Assist

### Assistant display

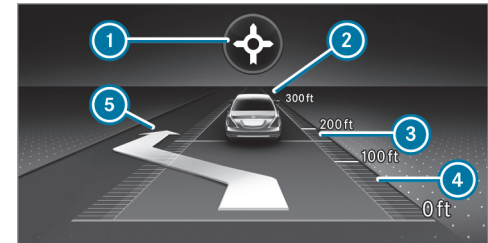

- 1 Route-based speed adaptation: type of route event
- 2 Vehicle in front
- 3 Distance indicator
- 4 Set specified distance
- 5 Active Lane Change Assist lane change display

### Active Distance Assist DISTRONIC status display and route-based speed adaptation

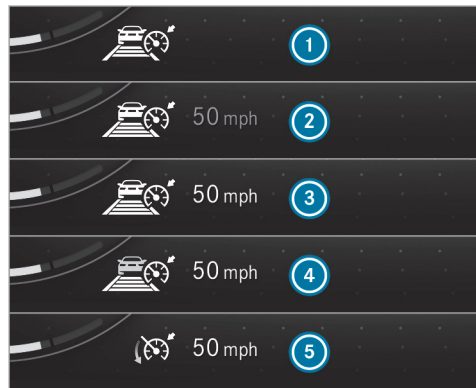

- ① Active Distance Assist DISTRONIC selected, set specified distance (number of segments below the vehicle)
- ② Active Distance Assist DISTRONIC deactivated, speed stored

- ③ Active Distance Assist DISTRONIC active, speed stored, no vehicle detected (bright vehicle symbol)
  - ④ Active Distance Assist DISTRONIC active, speed stored, vehicle detected (green vehicle symbol)
  - ⑤ Active Distance Assist DISTRONIC and route-based speed adaptation active, speed stored
- ⓘ On highways or high-speed major roads, the green vehicle symbol is displayed cyclically when the vehicle is ready to pull away.
- ⓘ If you depress the accelerator pedal beyond the setting of the Active Distance Assist DISTRONIC, the system is switched to passive mode. The **Suspended** message appears in the multifunction display.

### Speedometer

The stored speed is highlighted on the speedometer. If the speed of the vehicle in front or the speed adjustment is less than the stored speed due to the route event ahead, the segments in the speedometer light up. Deactivation of Active Distance Assist DISTRONIC, as well as alterations to the speed due to manual or automatic

adoption of the speed limit, are displayed in the control feedback of the multifunction display on a single line.

### Active Steering Assist status display

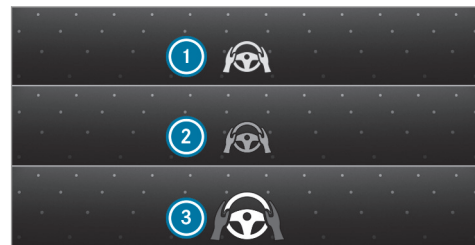

- ① Gray steering wheel: Active Steering Assist switched on and passive
- ② Green steering wheel: Active Steering Assist switched on and active
- ③ Flashing steering wheel: prompt to the driver to actively confirm or transition from active to passive status, system limits detected

During the transition from active to passive status, symbol ③ is shown as enlarged and flash-

ing. Once the system is passive, symbol  is shown as gray in the multifunction display.

### Function of Hill Start Assist

Hill Start Assist holds the vehicle for a short time when pulling away on a hill under the following conditions:

- The transmission is in position **D** or **R**.
- The electric parking brake is released.

This gives you enough time to move your foot from the brake pedal to the accelerator pedal and depress it before the vehicle begins to roll away.

**⚠ WARNING** Risk of accident and injury due to the vehicle rolling away

After a short time, Hill Start Assist no longer holds the vehicle and it can roll away.

- ▶ Therefore, swiftly move your foot from the brake pedal to the accelerator pedal. Never attempt to leave the vehicle if it is being held by Hill Start Assist.

### HOLD function

#### HOLD function

The HOLD function holds the vehicle at a standstill without requiring you to depress the brake pedal, e.g. while waiting in traffic.

The HOLD function is only an aid. The responsibility for the vehicle safely standing still remains with the driver.

#### System limits

The HOLD function is only intended to provide assistance when driving and is not a sufficient means of safeguarding the vehicle against rolling away when stationary.

- The incline must not be greater than 30%.

### Activating/deactivating the HOLD function

**⚠ WARNING** Risk of an accident due to the HOLD function being activated when you leave the vehicle

If you leave the vehicle while only the HOLD function is braking the vehicle, the vehicle can roll away in the following situations:

- If there is a malfunction in the system or in the power supply.
- If the HOLD function is deactivated by depressing the accelerator pedal or brake pedal, e.g. by a vehicle occupant.

▶ Always deactivate the HOLD function and secure the vehicle against rolling away before leaving the vehicle.

**!** **NOTE** Damage from automatic braking

If one of the following functions is switched on, the vehicle brakes automatically in certain situations:

- Active Brake Assist
- Active Distance Assist DISTRONIC
- HOLD function
- Active Parking Assist

To avoid damage to the vehicle, deactivate these systems in the following or similar situations:

- ▶ During towing
- ▶ In a car wash

**Requirements:**

- The vehicle is stationary.
- The driver's door is closed or the seat belt on the driver's side is fastened.
- The engine is running or has been automatically switched off by the ECO start/stop function.

- The electric parking brake is released.
- Active Distance Assist DISTRONIC is deactivated.
- The transmission is in position **D**, **R** or **N**.

**Activating the HOLD function**

- ▶ Depress the brake pedal and after a short time quickly depress further until the **HOLD** display appears in the multifunction display.
- ▶ Release the brake pedal.

**Deactivating the HOLD function**

- ▶ Depress the accelerator pedal to pull away.
- or
- ▶ Depress the brake pedal until the **HOLD** display disappears from the multifunction display.

The HOLD function is deactivated in the following situations:

- Active Distance Assist DISTRONIC is activated.
- The transmission is switched to position **P**.

- The vehicle is secured with the electric parking brake.

In the following situations, the vehicle is held by transmission position **P** or by the electric parking brake:

- The seat belt is unfastened and the driver's door is opened.
- The vehicle is switched off.
- There is a malfunction in the system or the power supply is insufficient.

**AIR BODY CONTROL**

**AIR BODY CONTROL function**

AIR BODY CONTROL is an air suspension system with variable damping for improved driving comfort. The all-round level control system ensures the best possible suspension and constant ground clearance, even with a laden vehicle. When driving at speed, the vehicle is lowered automatically to improve driving safety and to reduce fuel consumption. You also have the option of manually adjusting the vehicle level.





AIR BODY CONTROL includes the following components and functions:

- air suspension with variable spring rate
- automatic level control system
- speed-dependent lowering to reduce fuel consumption
- manually selectable high level setting for greater ground clearance
- ADS PLUS (Adaptive Damping System with constant damping force adjustment)
- DYNAMIC SELECT switch and level button

### Available suspension settings

| Drive program      | Characteristics  |
|--------------------|--|
| <b>C</b> (Comfort) | <ul style="list-style-type: none"> <li>• The suspension setting is comfortable.</li> <li>• The vehicle is set to the normal level.</li> <li>• When driving at speeds of above 78 mph (125 km/h) the vehicle is lowered.</li> <li>• When driving at speeds below 50 mph (80 km/h) the vehicle is raised again.</li> </ul> |
| <b>E</b> (Eco)     | <ul style="list-style-type: none"> <li>• The suspension setting is comfortable.</li> <li>• The vehicle is set to low level -1.</li> <li>• The vehicle is not lowered any further if you are traveling at higher speeds.</li> </ul>   |
| <b>S</b> (Sport)   | <ul style="list-style-type: none"> <li>• The suspension setting is firmer.</li> <li>• The vehicle is set to low level -1.</li> <li>• The vehicle is not lowered any further if you are traveling at higher speeds.</li> </ul>  |

| Drive program  | Characteristics   |
|--|---|
|  (Sport +)  | <ul style="list-style-type: none"> <li>The suspension setting is even firmer.</li> <li>The vehicle is set to low level -1.</li> <li>The vehicle is not lowered any further if you are traveling at higher speeds.</li> </ul>  |
| <b>Vehicles with Off-road package:</b><br> (Off-road)<br> (Off-road +) | <ul style="list-style-type: none"> <li>The suspension setting is suitable for off-road terrain.</li> <li>The vehicle is set to the high level +1.</li> <li>When driving at speeds above approximately 50 mph (80 km/h), the vehicle is lowered.</li> <li>When driving at speeds below approximately 28 mph (45 km/h), the vehicle is raised.</li> </ul> |

Differences between different vehicle levels compared to the normal level (0):

- High level (+2):(only vehicles with Off-road package):** approx. +2.0 in (+50 mm)
- High level +1:** approx. +1.2 in (+30 mm)
- Low level -1:** approx. -0.6 in (-15 mm)

### Setting the vehicle level

 **WARNING** Risk of accident because vehicle level is too high

If you drive at a higher vehicle level, the driving characteristics may be impaired due to the higher vehicle center of gravity.

The vehicle can drift outwards, for example, when steering or cornering.

 Always choose a vehicle level which is suited to the driving style and the road surface conditions.

 **WARNING** Risk of entrapment from vehicle lowering

When lowering the vehicle, people could become trapped if their limbs are between the vehicle body and the tires or underneath the vehicle.

- ▶ Make sure no one is underneath the vehicle or in the immediate vicinity of the wheel arches when the vehicle is being lowered.

**⚠ WARNING** Risk of becoming trapped due to the vehicle lowering

**Vehicles with AIR BODY CONTROL or level control system:** when you unload luggage or leave the vehicle, the vehicle first rises slightly and then returns to the set level shortly afterwards.

You or anyone else in the vicinity of the wheel arches or the underbody could thus become trapped.

The vehicle can also be lowered after being locked.



- ▶ When leaving the vehicle, make sure that nobody is in the vicinity of the wheel arches or the underbody.

**⚠ NOTE** Damage due to vehicle lowering

Parts of the body could be damaged when the vehicle is lowered.

- ▶ Make sure that there are no obstacles such as curbs underneath or in the immediate vicinity of the body when the vehicle is being lowered.

#### Requirements:

- The vehicle has been started.
- **Vehicles without Off-road package:** the vehicle must not be moving faster than 37 mph (60 km/h).
- **Vehicles with Off-road package:**
  - If drive program **C**, **E**, **S** or **S** is selected: the vehicle must not be moving faster than 37 mph (60 km/h).
  - If the  or  drive program is selected: the vehicle must not be moving faster than 12 mph (20 km/h).

#### Raising the vehicle

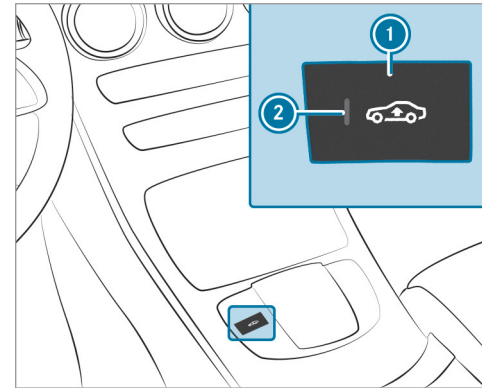



- ▶ Press button ①. Indicator lamp ② lights up.

**Vehicles without Off-road package:** the vehicle is set to the high level +1.

**Vehicles with Off-road package:**

## 218 Driving and parking

- If drive program **C**, **E**, **S** or **S** is selected: the vehicle is set to the high level +1.
- If the  or  drive program is selected: the vehicle is set to the high level +2.

Your selection is saved.

The vehicle is lowered again in the following situations:

### • Vehicles without Off-road package:

- When driving faster than 50 mph (80 km/h).
- When driving between 37 mph (60 km/h) and 50 mph (80 km/h) for approximately three minutes.

### • Vehicles with Off-road package:

- If drive program **C**, **E**, **S** or **S** is selected:  
When driving faster than 50 mph (80 km/h) or between 37 mph (60 km/h) and 50 mph (80 km/h) for approximately three minutes.

- If the  or  drive program is selected:

When driving faster than 12 mph (20 km/h).

- After changing a drive program using the DYNAMIC SELECT switch.

The vehicle is adjusted to the height of the last active drive program.

### Lowering the vehicle

- ▶ Press button **1**.
- Indicator lamp **2** goes out. The vehicle is adjusted to the height of the active drive program.

### Lowering and raising the rear of the vehicle

**⚠ WARNING** Risk of entrapment from vehicle lowering

When lowering the vehicle, people could become trapped if their limbs are between the vehicle body and the tires or underneath the vehicle.

- ▶ Make sure no one is underneath the vehicle or in the immediate vicinity of the wheel arches when the vehicle is being lowered.

### Requirements:

- All vehicle doors are closed
- There is no trailer coupled
- There is no bicycle rack installed
- The battery is sufficiently charged; if necessary, start the engine

### Lowering the rear of the vehicle

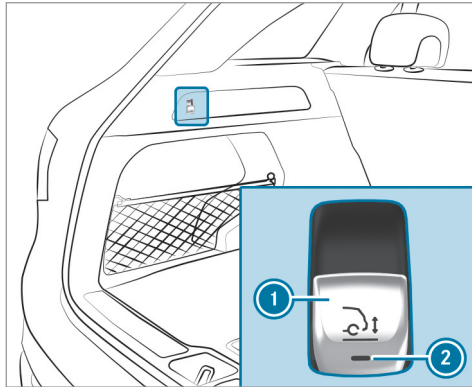

- ▶ Apply the electric parking brake.
- ▶ Shift the transmission to position **P** (→ page 169).
- ▶ Pull switch **1** in the right-hand cargo compartment trim briefly. Indicator lamp **2** flashes until the vehicle has been lowered.

When the rear of the vehicle has been completely lowered, indicator lamp **2** remains lit.

Lowering is interrupted in the following situations:

- A vehicle door is opened
- Switch **1** is pulled again
- The vehicle is being driven faster than 1.2 mph (2 km/h)
- i** The vehicle is automatically set to the level of the most recently active drive program if you drive at speeds greater than 1.2 mph (2 km/h) with the rear of the vehicle lowered. The **Vehicle Rising Please Wait** message appears in the multifunction display.

If indicator lamp **2** flashes twice and the rear of the vehicle does not lower:

- ▶ Make sure that the requirements are met.
- i** Lowering the rear of the vehicle allows the vehicle to be loaded more easily. Observe the notes on loading the vehicle when doing this (→ page 106).

### Raising the rear of the vehicle

- ▶ Check if the battery is sufficiently charged. If necessary, start the engine.
- ▶ Pull switch **1** briefly. Indicator lamp **2** goes out. The vehicle will be raised to the currently selected level.

**i** The vehicle is automatically set to the level of the most recently active drive program if you drive at speeds greater than 1.2 mph (2 km/h) with the rear of the vehicle lowered. The **Vehicle Rising Please Wait** message appears in the multifunction display.

If the vehicle cannot be raised:

- ▶ Ensure that the battery is sufficiently charged; if necessary, start the engine. The raising process continues.

## Parking Assist PARKTRONIC

### Function of Parking Assist PARKTRONIC

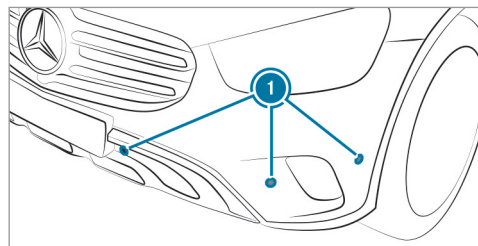

Parking Assist PARKTRONIC is an electronic parking assistance system with ultrasound. It monitors the area around your vehicle using multiple sensors ① on the front bumper and on the rear bumper. Parking Assist PARKTRONIC shows you the distance between your vehicle and a detected obstacle visually and audibly.

Parking Assist PARKTRONIC is only an aid. It is not a substitute for your attention to the surroundings. The responsibility for safe maneuvering and parking remains with you. Make sure that there are no persons, animals or objects in

the maneuvering area while maneuvering and parking in/exiting parking spaces.

In the standard setting, an intermittent warning tone sounds from a distance of approximately 1.0 ft (0.3 m) to an obstacle in front and approximately 3.3 ft (1.0 m) to an obstacle behind. A continuous warning tone sounds from a distance of approximately 0.7 ft (0.2 m). Using the **Warn Early All Around** setting in the multimedia system, the warning tones for front and side impact protection can be set to sound at a greater distance of approximately 3.3 ft (1.0 m) in front and 2.0 ft (0.6 m) on the sides (→ page 225).

① The **Warn Early All Around** setting is always active at the rear of the vehicle.

If Parking Assist PARKTRONIC is deactivated, Active Parking Assist is unavailable.

### Parking Assist PARKTRONIC display in the multimedia system

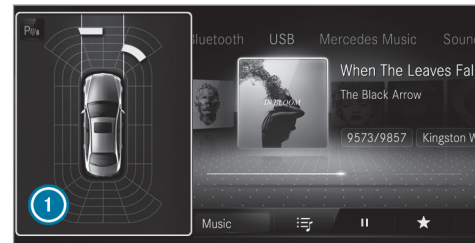

Vehicles with Active Parking Assist without a 360° Camera



Vehicles with Active Parking Assist and a 360° Camera

If Active Parking Assist is deactivated and an obstacle is detected in the path of the vehicle, a pop-up window for Parking Assist PARKTRONIC ① appears in the multimedia system at speeds below 6 mph (10 km/h).

The color of the individual segments of the warning display is based on the distance to the detected obstacle:

- **Yellow segments:** obstacles at a distance between approx. 2.0 ft (0.6 m) and 3.3 ft (1.0 m)

- **Orange segments:** obstacles at a distance between approx. 1.0 ft (0.3 m) and 2.0 ft (0.6 m)
- **Red segments:** obstacles at a very short distance of approx. 1.0 ft (0.3 m) or less

#### System limits

Parking Assist PARKTRONIC does not necessarily take into account the following obstacles:

- Obstacles below the detection range, e.g. persons, animals or objects.
- Obstacles above the detection range, e.g. overhanging loads, overhangs or loading ramps of trucks.

The sensors must be free of dirt, ice and slush. Otherwise, they may not function correctly. Clean the sensors regularly, especially after driving off-road, taking care not to scratch or damage them.

**Vehicles with trailer hitch:** Parking Assist PARKTRONIC is deactivated for the rear zone when you establish an electrical connection between your vehicle and a trailer.

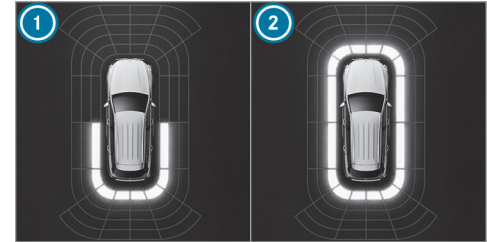

#### Problems with Parking Assist PARKTRONIC

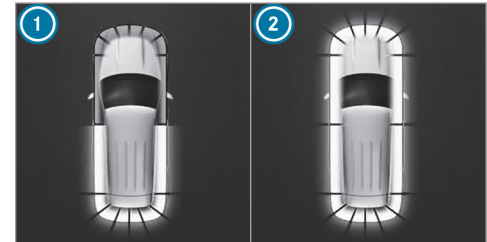

Vehicles without 360° Camera



Vehicles with 360° Camera

| Problem   | Possible causes/consequences and ► Solutions   |
|---|--|
| Rear segments ① or all-round segments ② light up red. The  symbol appears in the multifunction display.  | Parking Assist PARKTRONIC is malfunctioning and has been deactivated due to signal interference. <ul style="list-style-type: none"> <li>► Start the vehicle again.</li> <li>► Check if Parking Assist PARKTRONIC is working at a different location.</li> </ul>  |
| Rear segments ① or all-round segments ② light up red. At the same time, a warning tone sounds for approximately two seconds every time the vehicle is started. The  symbol appears in the multifunction display. | The sensors are dirty. <ul style="list-style-type: none"> <li>► Clean the sensors and observe the notes on care of vehicle parts (→ page 433).</li> </ul> Parking Assist PARKTRONIC has been deactivated due to a malfunction. <ul style="list-style-type: none"> <li>► Start the vehicle again.</li> <li>► If the problem persists, consult a qualified specialist workshop.</li> </ul> |

### Function of the passive side impact protection

Passive side impact protection is an additional Parking Assist PARKTRONIC function which warns the driver about obstacles at the side of the vehicle. A warning is issued when obstacles are detected between the front and rear detection range. In order for an object on the side to be detected, the sensors in the front and rear

bumper must first detect the object while you are driving past it.

During the parking procedure or maneuvering, objects are detected as the vehicle drives past. If you steer in the direction of a detected obstacle and there is a risk of a lateral collision, a warning is issued. The segments on the sides light up yellow or red, depending on the distance to the obstacle.

### Segment color depending on distance

| Color  | Lateral distance                  |
|--------|-----------------------------------|
| Yellow | Approx. 1.0 - 2.0 ft (30 - 60 cm) |
| Red    | Approx. < 1.0 ft (30 cm)          |



In order for lateral front or rear segments to be displayed, the vehicle must first travel a distance of at least half of the vehicle length. Once the vehicle has traveled the length of the vehicle, all of the lateral front and rear segments can be displayed.

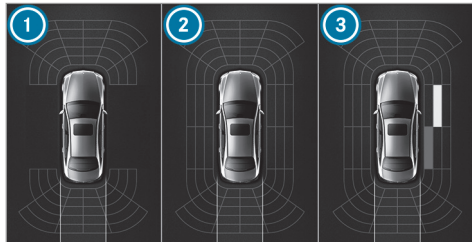

Parking Assist PARKTRONIC display: vehicles without a 360° Camera

- ① Operational front and rear
- ② Operational front, rear and sides
- ③ Obstacle detected at the front right (yellow) and rear (red)

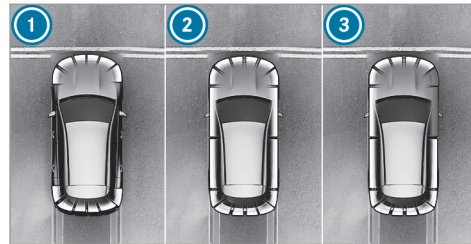

Parking Assist PARKTRONIC display: vehicles with a 360° Camera

- ① Operational front and rear
- ② Operational front, rear and sides
- ③ Obstacles detected at the front right (red)

Saved obstacles on the sides are deleted in the following situations, for example:

- You park the vehicle and switch off the ignition.
- You open the doors.

After the engine is restarted, obstacles on the sides must be detected again before a new warning can be issued.

### System limits

The system limits for Parking Assist PARKTRONIC apply to passive side impact protection.

The following objects are not detected, for example:

- Pedestrians who approach the vehicle from the side
- Objects placed next to the vehicle

### Activating/deactivating Parking Assist PARKTRONIC

**!** **NOTE** Risk of an accident from objects at close range

Parking Assist PARKTRONIC may not detect certain objects at close range.

- ▶ When parking or maneuvering the vehicle, pay particular attention to any objects which are above or below the sensors, e.g. flower pots or drawbars. The vehicle or other objects could otherwise be damaged.

- ① **Vehicles with AIR BODY CONTROL:** you can activate or deactivate Parking Assist PARKTRONIC in the multimedia system (→ page 224).

If indicator lamp ① is not lit, Parking Assist PARKTRONIC is active. If the indicator lamp is lit or the  symbol appears in the multifunction display, Parking Assist PARKTRONIC is not active.

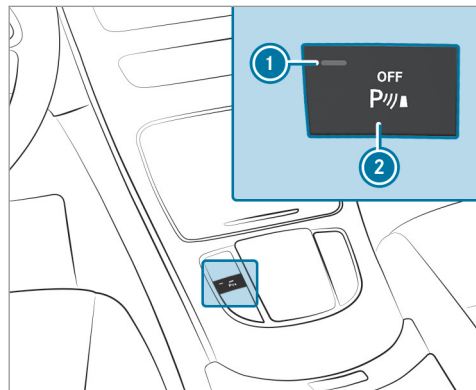

- ▶ Press button ②.

- ① Parking Assist PARKTRONIC is automatically activated when the vehicle is started.

### Activating/deactivating Parking Assist PARKTRONIC (Vehicles with AIR BODY CONTROL)

**!** **NOTE** Risk of an accident from objects at close range

Parking Assist PARKTRONIC may not detect certain objects at close range.

- ▶ When parking or maneuvering the vehicle, pay particular attention to any objects which are above or below the sensors, e.g. flower pots or drawbars. The vehicle or other objects could otherwise be damaged.

If the  symbol is shown in the multifunction display, Parking Assist PARKTRONIC is not active.

Multimedia system:

- ▶ [Settings](#) ▶ [Quick Access](#)  
▶ [PARKTRONIC](#)

- ▶ Activate or deactivate the function.

- ① Parking Assist PARKTRONIC is automatically activated when the vehicle is started.

### Activating/deactivating Parking Assist PARKTRONIC

**!** **NOTE** Risk of an accident from objects at close range

Parking Assist PARKTRONIC may not detect certain objects at close range.

- ▶ When parking or maneuvering the vehicle, pay particular attention to any objects which are above or below the sensors, e.g. flower pots or drawbars. The vehicle or other objects could otherwise be damaged.

If the  symbol is shown in the multifunction display, Parking Assist PARKTRONIC is not active.

Multimedia system:

→ Settings → Quick Access  
→ PARKTRONIC

▶ Activate or deactivate the function.

ⓘ Parking Assist PARKTRONIC is automatically activated when the vehicle is started.

### Adjusting the warning tones of Parking Assist PARKTRONIC

Multimedia system:

→ Home → Settings → Assistance  
→ Camera & Parking

### Adjusting the volume of the warning tones

- ▶ Select **Warning Tone Volume**.
- ▶ Set a value.

### Adjusting the pitch of the warning tones

- ▶ Select **Warning Tone Pitch**.
- ▶ Set a value.

### Specifying the starting point for the warning tones

You can specify whether the Parking Assist PARKTRONIC warning tones should commence

when the vehicle is further away from an obstacle.

- ▶ Select **Warn Early All Around**.
- ▶ Activate or deactivate the function.

### Activating/deactivating audio fadeout

You can specify whether the volume of a media source in the multimedia system is to be reduced when Parking Assist PARKTRONIC sounds a warning tone.

- ▶ Select **Audio Fadeout During Warning Tones**.
- ▶ Activate or deactivate the function.

## Reversing camera

### Function of the rear view camera

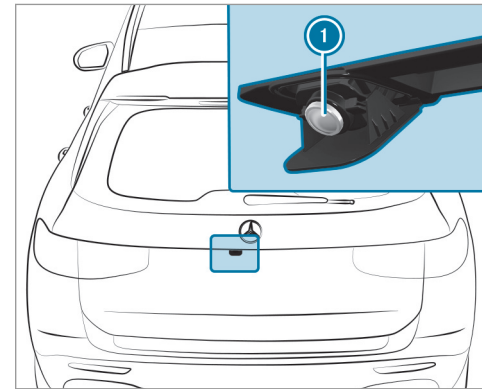

When you engage reverse gear, the image from rear view camera ① is shown in the media display. Dynamic guide lines show the path the vehicle will take with the steering wheel in its current position. This helps you to orient yourself and to avoid obstacles when backing up.

## 226 Driving and parking

The rear view camera is only an aid. It is not a substitute for your attention to the surroundings. The responsibility for safe maneuvering and parking remains with you. Make sure that there are no persons, animals or objects etc., in the maneuvering area while maneuvering and parking.

The guide lines in the media display show the distances to your vehicle. The distances displayed only apply to road level.

Depending on the vehicle equipment, you can select from the following views:

- Normal view
- Wide-angle view
- Trailer view

The area behind the vehicle is displayed as a mirror image, as in the inside rearview mirror.

### Vehicles without Active Parking Assist

The following camera views are available in the multimedia system:

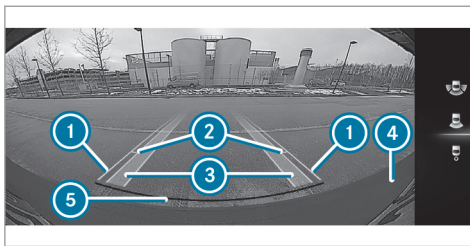

#### Normal view

- ① Yellow guide line, vehicle width (driven surface) depending on the current steering wheel angle (dynamic)
- ② Yellow guide line at a distance of approximately 3.3 ft (1.0 m) from the rear area
- ③ Yellow lane marking the course the tires will take at the current steering wheel angle (dynamic)
- ④ Bumper
- ⑤ Red guide line at a distance of approximately 1.0 in (0.3 m) from the rear area

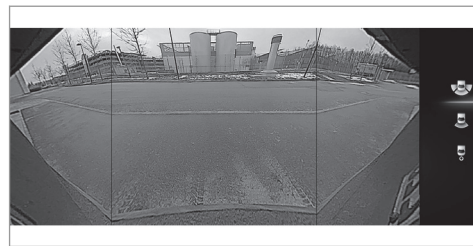

#### Wide-angle view

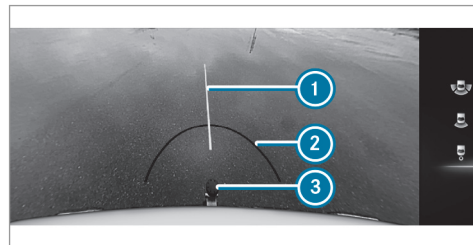

#### Trailer view (vehicles with a trailer hitch)

- ① Yellow guide line, locating aid

- ② Red guide line at a distance of approximately 1.0 in (0.3 m) from the ball head of the trailer hitch
- ③ Ball head of the trailer hitch

### Vehicles with Active Parking Assist

The following camera views are available in the multimedia system:

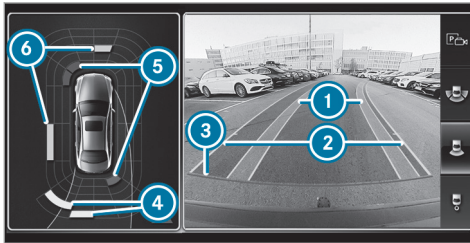

Normal view

- ① Yellow lane marking the course the tires will take at the current steering wheel angle (dynamic)

- ② Yellow guide line, vehicle width (driven surface) depending on the current steering wheel angle (dynamic)
  - ③ Red guide line at a distance of approximately 1.0 in (0.3 m) from the rear area
  - ④ Yellow warning display of Parking Assist PARKTRONIC: obstacles are at a distance of between approximately 2.0 ft (0.6 m) and 3.3 ft (1.0 m)
  - ⑤ Red warning display of Parking Assist PARKTRONIC: obstacles are very close (approximately 1.0 ft (0.3 m) or less)
  - ⑥ Orange warning display of Parking Assist PARKTRONIC: obstacles are a medium distance away (between approximately 1.0 ft (0.3 m) and 2.0 ft (0.6 m))
- ⓘ If the entire system fails, the segments of the warning display are shown in red. The indicator lamp on the PARKTRONIC button lights up and the  symbol appears in the multifunction display.

If the system fails at the rear, the display of the segments changes as follows:

- The rear segments are shown in red when backing up.
- The rear segments are hidden when driving forwards.

If Parking Assist PARKTRONIC is deactivated, the warning display fades out (→ page 221).



Wide-angle view

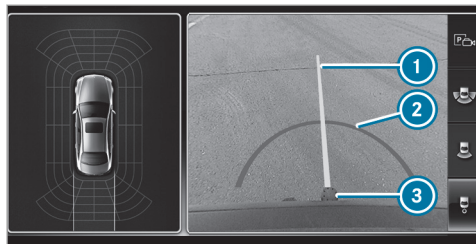

Trailer view (vehicles with a trailer hitch)

- ① Yellow guide line, locating aid
- ② Red guide line at a distance of approximately 1.0 in (0.3 m) from the ball head of the trailer hitch
- ③ Ball head of the trailer hitch

### System limits

The rear view camera will not function or will only partially function in the following situations:

- The tailgate is open.
- There is heavy rain, snow or fog.
- The ambient light conditions are poor, e.g. at night.

- The camera lens is obstructed, dirty or fogged up. Observe the notes on cleaning the rear view camera (→ page 433).
- The camera or rear passenger compartment of your vehicle is damaged. In this case, have the camera and its position and setting checked at a qualified specialist workshop.

- ① Do not use the rear view camera in these types of situation. You could otherwise injure others or collide with objects when parking the vehicle.

If the vehicle is carrying a heavy load, leaving the standard height can result in inaccuracies in the guide lines and in the display of the generated images, depending on technical conditions.

The field of vision and other functions of the rear view camera may be restricted due to additional accessories on the rear of the vehicle (e.g. license plate bracket or bicycle rack).

- ① The contrast of the display may be impaired by direct sunlight or by other light sources, e.g. when driving out of a garage. In this case, pay particular attention.

- ① Have the display repaired or replaced if, for example, pixel errors considerably restrict its use.

### 360° camera

#### Function of the 360° Camera

The 360° Camera is a system that consists of four cameras. The cameras cover the immediate vehicle surroundings. The system assists you, e.g. when parking or at exits with reduced visibility.

The views of the 360° Camera are always available when driving forwards up to a speed of approx. 10 mph (16 km/h) and when backing up.

The 360° Camera is only an aid and may show a distorted view of obstacles, show them incorrectly or not show them at all. It is not a substitute for your attention to the surroundings. The responsibility for safe maneuvering and parking remains with you. Make sure that there are no persons, animals or objects etc., in the maneuvering area while maneuvering and parking.

The system evaluates images from the following cameras:

- Rear view camera
- Front camera
- Two side cameras in the outside mirrors

### Views of the 360° Camera

You can select from different views:



- 1 Wide-angle view, front
- 2 Top view with image from the front camera
- 3 Top view with images from the side cameras in the outside mirrors
- 4 Wide-angle view, rear

- 5 Top view with image from the rear view camera
- 6 Top view with trailer view (vehicles with a trailer hitch)

### Top view

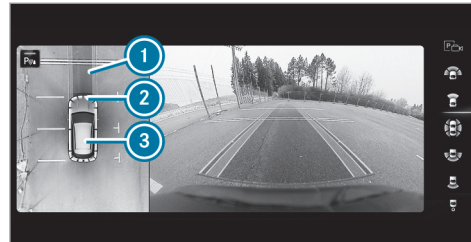

- 1 Lane indicating the route the vehicle will take at the current steering wheel angle
- 2 Warning display of Parking Assist PARKTRONIC
- 3 Your vehicle from above

The color of the individual segments of warning display ② is based on the distance to the detected obstacle:

- **Yellow segments:** obstacles at a distance between approx. 2.0 ft (0.6 m) and 3.3 ft (1.0 m)
- **Orange segments:** obstacles at a distance between approx. 1.0 ft (0.3 m) and 2.0 ft (0.6 m)
- **Red segments:** obstacles at a very short distance of approx. 1.0 ft (0.3 m) or less

When Parking Assist PARKTRONIC is operational and no object is detected, the segments of the warning display are shown in gray.

- i If the entire system fails, the segments of the warning display are shown in red. The indicator lamp on the PARKTRONIC button lights up and the  symbol appears in the multifunction display.

If the system fails at the rear, the display of the segments changes as follows:

- The rear segments are shown in red when backing up.

## 230 Driving and parking

- The rear segments are hidden when driving forwards.

If Parking Assist PARKTRONIC is deactivated, the warning display fades out (→ page 221).

### Guide lines

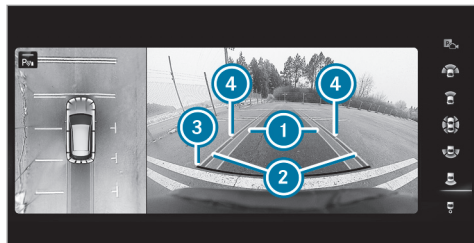

- 1 Yellow lane marking the course the tires will take at the current steering wheel angle (dynamic)
- 2 Yellow guide line, vehicle width (driven surface) depending on the current steering wheel angle (dynamic)

3 Red guide line at a distance of approximately 12 in (0.3 m) from the rear area

4 Mark at a distance of approx. 3.3 ft (1.0 m)

i When Active Parking Assist is active, lane markings 1 are displayed in green. The guide lines in the media display show the distances to your vehicle. The distances apply to road level. In trailer mode, the guide lines are shown at the level of the trailer hitch.

### Trailer view (vehicles with a trailer hitch)

If you select trailer view and no trailer is coupled to the vehicle, the following display appears:

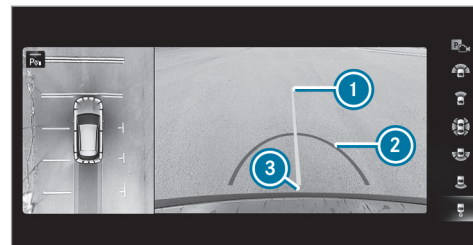

- 1 Yellow guide line, locating aid
- 2 Red guide line at a distance of approximately 12 in (0.3 m) to the ball head of the trailer hitch
- 3 Ball head of the trailer hitch





When the electrical connection is established between the vehicle and the trailer, the display changes to the side camera view.

This view supports maneuvering procedures with a trailer.

#### Side view of the mirror cameras

The sides of the vehicle can be seen in this view.

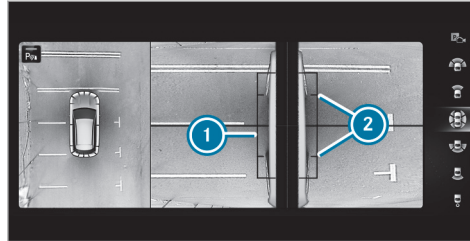

- ① Guide line of external vehicle dimensions with outside mirrors folded out
- ② Marker of the wheel contact points

#### System failure

If the 360° Camera is not ready for operation, the following message appears in the multimedia system:

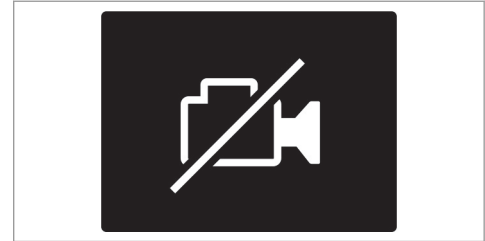

#### System limits

The 360° Camera will not function or will only partially function in the following situations:

- The doors are open.
- The side mirrors are folded in.
- The tailgate is open.
- There is heavy rain, snow or fog.
- The ambient light conditions are poor, e.g. at night.
- The camera lens is obstructed, dirty or fogged up.
- If cameras or vehicle components in which the cameras are installed are damaged. In

this event, have the cameras, their positions and their setting checked at a qualified specialist workshop.

- ⓘ Do not use the 360° Camera under such circumstances. You could otherwise injure others or collide with objects when parking the vehicle.

If the vehicle is carrying a heavy load, leaving the standard height can result in inaccuracies in the guide lines and in the display of the generated images, depending on technical conditions.

The field of vision and other functions of the camera system may be restricted due to additional attachments on the vehicle (e.g. license plate bracket, bicycle rack).

- ⓘ The contrast of the display may be impaired by abrupt direct sunlight or by other light sources, e.g. when driving out of a garage. In this case, pay particular attention.
- ⓘ Have the display repaired or replaced if, for example, pixel errors considerably restrict its use.

See the notes on cleaning the 360° Camera (→ page 433).

### Selecting a view for the 360° Camera

- ▶ Engage reverse gear.
- ▶ Select the desired view in the multimedia system (→ page 228).

### Opening the camera cover of the rear view camera

Multimedia system:

- ▶  ▶ Settings ▶ Assistance
- ▶ ▶ Camera & Parking
- ▶ Select **Open Camera Cover**.

- ⓘ The camera cover closes automatically after some time or after an ignition cycle.

### Active Parking Assist

#### Function of Active Parking Assist

Active Parking Assist is an electronic parking assistance system which uses ultrasound and is automatically activated during forward travel. The system is operational at speeds below approximately 22 mph (35 km/h).

If all requirements are met, the  display appears in the multifunction display. The system

then independently locates and measures parallel and perpendicular parking spaces on both sides of the vehicle.

When Active Parking Assist has detected parking spaces, the  display appears in the multifunction display. The arrows show on which side of the road detected parking spaces are located. They are then shown in the media display. The parking space and, if necessary, the parking direction can be selected as desired. Active Parking Assist calculates a suitable vehicle path, switches on the turn signal indicator and assists you in parking and exiting the parking space.

Active Parking Assist provides assistance when changing gear, accelerating, braking and steering the vehicle.

Active Parking Assist is only an aid. It is not a substitute for your attention to the surroundings. The responsibility for safe maneuvering and parking remains with you. Make sure that no persons, animals or objects etc. are in the maneuvering range.

Active Parking Assist is canceled if, among other things, one of the following actions is carried out:

- Parking Assist PARKTRONIC is deactivated.
- Active Parking Assist is deactivated.
- You begin steering.
- You apply the parking brake.
- You engage transmission position **P**.
- ESP® intervenes.
- You open the doors or the tailgate while driving.

### System limits

Objects located above or below the detection range of Parking Assist PARKTRONIC or Active Parking Assist are not detected when the parking space is being measured. These are also not taken into account when the parking maneuver is calculated, e.g. overhanging loads, overhangs or loading ramps of trucks or the boundaries of parking spaces. In some circumstances, Active Parking Assist may therefore guide you into the parking space prematurely.

**⚠ WARNING** Risk of accident due to objects located above or below the detection range of Active Parking Assist

If there are objects above or below the detection range, the following situations may arise:

- Active Parking Assist may steer too early.
- **Vehicles with automatic transmission:** The vehicle may not stop in front of these objects.

This could cause a collision.

▶ In these situations, do not use Active Parking Assist.

Snowfall or heavy rain may lead to a parking space being measured inaccurately. Parking spaces that are partially occupied by trailer drawbars might not be identified as such or be measured incorrectly. Only use Active Parking Assist on level, high-grip ground.

Do not use Active Parking Assist in the following situations:

- In extreme weather conditions such as ice, packed snow or in heavy rain.
- When transporting a load that protrudes beyond the vehicle.
- If the parking space is on a steep downhill or uphill gradient.
- When snow chains are installed.

Active Parking Assist may also display parking spaces that are not suitable for parking, e.g. the following:

- Parking spaces where parking is prohibited.
- Parking spaces on unsuitable surfaces.

Active Parking Assist will not assist you with parking spaces at right angles to the direction of travel in the following situations:

- If two parking spaces are located immediately next to each other.
- If the parking space is immediately next to a low obstacle such as a curb.

## 234 Driving and parking

Active Parking Assist will not assist you with parking spaces parallel or at right angles to the direction of travel in the following situations:

- If the parking space is on a curb.
- If the parking space is bordered by an obstacle, e.g. a tree, a post or a trailer.

### Parking with Active Parking Assist

- ① Depending on the vehicle's equipment, the button may also be located at a different position in the center console.

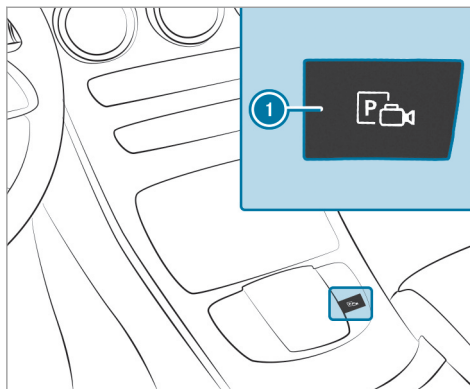

- ▶ Press button ①.

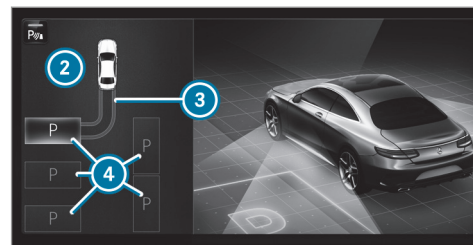

The media display shows the view of Active Parking Assist. Area ② displays detected parking spaces ④ and vehicle path ③.

- ① Vehicle path ③ shown on the media display may differ from the actual vehicle path.
- ▶ If you have driven past a parking space: bring the vehicle to a standstill.
- ▶ Select desired parking space ④.
- ▶ Where necessary, select the parking direction: forwards or reverse. Vehicle path ③ is shown, depending on selected parking space ④ and the parking direction.

▶ Confirm selected parking space ④.

① The turn signal indicator is switched on automatically when the parking procedure begins. The turn signal indicator is switched off automatically when you switch to [D].

You are responsible for selecting the turn signal indicator in accordance with the traffic conditions. If necessary, select the turn signal indicator accordingly.

**⚠ WARNING** Risk of accident due to vehicle swinging out while parking or pulling out of a parking space

While parking or exiting a parking space, the vehicle swings out and can drive onto areas of the oncoming lane.

This could cause you to collide with objects or other road users.

- ▶ Pay attention to objects and other road users.
- ▶ Where necessary, stop the vehicle or cancel the parking procedure with Active Parking Assist.

▶ If, for example, the **Please Engage Reverse Gear** message appears in the media display: select the corresponding transmission position. The vehicle drives into the selected parking space.

On completion of the parking procedure, the **Parking Assist Finished, Take Control of Vehicle** display message appears. Further maneuvering may still be necessary.

▶ After completion of the parking procedure, safeguard the vehicle against rolling away. When required by legal requirements or local conditions: turn the wheels towards the curb.

① You can stop the vehicle and change the transmission position during the parking procedure. The system then calculates a new vehicle path. The parking procedure can then be continued. If no new vehicle path is available, the transmission position will be changed again. If the vehicle has not yet reached the parking space, the parking procedure will be canceled, should a gear be changed.

### Exiting a parking space with Active Parking Assist

#### Requirements:

- The vehicle has been parked with Active Parking Assist.

Please note that you are responsible for the vehicle and surroundings during the entire parking procedure.

▶ Start the vehicle.

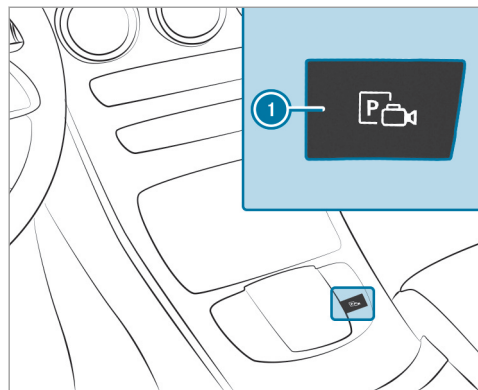

- ▶ Press button ①. The media display shows the view of Active Parking Assist.

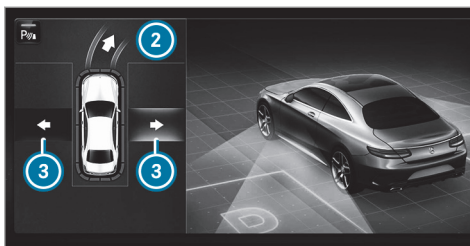

- ▶ If the vehicle has been parked at right angles to the direction of travel: in area ②, select direction of travel ③, **left** or **right**.

① The vehicle path shown on the media display may differ from the actual vehicle path.

- ▶ Confirm direction of exit ③ to drive out of the parking space.

① The turn signal indicator is switched on automatically when the exiting procedure begins.

You are responsible for selecting the turn signal indicator in accordance with the traffic conditions. If necessary, select the turn signal indicator accordingly.

**⚠ WARNING** Risk of accident due to vehicle swinging out while parking or pulling out of a parking space

While parking or exiting a parking space, the vehicle swings out and can drive onto areas of the oncoming lane.

This could cause you to collide with objects or other road users.

- ▶ Pay attention to objects and other road users.
- ▶ Where necessary, stop the vehicle or cancel the parking procedure with Active Parking Assist.

- ▶ If, for example, the **Please Engage Forward Gear** message appears in the media display: select the corresponding transmission position. The vehicle moves out of the parking space. The turn signal indicator is switched off automatically.

After the exiting procedure has been completed, the **Parking Assist Finished, Take Control of**

**Vehicle** message appears in the media display. A warning tone and the following display in the media display prompt you to take over control of the vehicle:



You have to accelerate, brake, steer and change gear yourself again.

#### Function of Drive Away Assist

Drive Away Assist can reduce the severity of an impact when pulling away. If an obstacle is detected in the direction of travel, the vehicle's speed is briefly reduced to approx. 1 mph (2 km/h). If a critical situation is detected, symbol  appears in the media display.

**⚠ WARNING** Risk of accident caused by limited detection performance of Drive Away Assist

Drive Away Assist cannot always clearly identify objects and traffic situations.

In such cases, Drive Away Assist might:

- Warn you without reason and limit the vehicle speed.
- Not warn you or not limit the vehicle speed.
- ▶ Always pay careful attention to the traffic situation; do not rely on Drive Away Assist alone.
- ▶ Be prepared to brake or swerve as necessary, provided the traffic situation permits and that it is safe to take evasive action.

Drive Away Assist is only an aid. It is not a substitute for your attention to the surroundings. The responsibility for safe maneuvering and parking remains with you. Make sure that no persons, animals or objects etc. are in the maneuvering range.

A risk of a collision may arise in the following situations, for example:

- If the driver mixes up the accelerator and brake pedals.

- If the wrong gear is selected.

Drive Away Assist is active under the following conditions:

- If Parking Assist PARKTRONIC is activated.
- Every time the gear is changed to **R** or **D** when the vehicle is at a standstill.
- If the detected obstacle is less than approx. 3.3 ft (1.0 m) away.
- If the maneuvering assistant function is activated in the multimedia system.

#### System limits

The performance of Drive Away Assist is limited on inclines.

When driving with a trailer, Drive Away Assist is not available.

 Also observe the system limits of Parking Assist PARKTRONIC (→ page 220).

#### Function of Cross Traffic Alert

 Also read the instructions on Blind Spot Assist (→ page 242).



**Vehicles with Blind Spot Assist:** Cross Traffic Alert can warn drivers of any crossing traffic when backing up out of a parking space. The radar sensors in the bumper also monitor the area adjacent to the vehicle. If a critical situation is detected, symbol ① appears in the media display. If the driver does not respond to the warning, the vehicle's brakes can be applied automatically.

If the radar sensors are obstructed by vehicles or other objects, detection is not possible.

Cross Traffic Alert is active under the following conditions:

- If Blind Spot Assist is activated.

- If the vehicle is backing up at walking pace.
- If the maneuvering assistant function is activated in the multimedia system.

### System limits

Cross Traffic Alert is not available on inclines.

Cross Traffic Alert is not available when driving with a trailer.

- ① Also observe the system limits of Active Blind Spot Assist (→ page 242).

### Activating/deactivating maneuvering assistance

Multimedia system:

→ » Settings » Assistance  
» Camera & Parking

- ▶ Switch [Maneuvering Assistance](#) on or off.
- ① Maneuvering assistance must be active for the function of Drive Away Assist (→ page 237).

## ATTENTION ASSIST

### Function of ATTENTION ASSIST

ATTENTION ASSIST assists you on long, monotonous journeys, e.g. on highways and trunk roads. If ATTENTION ASSIST detects indicators of fatigue or increasing lapses in concentration on the part of the driver, it suggests taking a break.

ATTENTION ASSIST is only an aid. It cannot always detect fatigue or lapses in concentration in time. The system is not a substitute for a well-rested and attentive driver. On long journeys, take regular breaks in good time that allow for adequate recuperation.

You can choose between two settings:

- **Standard:** normal system sensitivity.
- **Sensitive:** higher system sensitivity. The driver is warned earlier and the attention level detected by ATTENTION ASSIST is adapted accordingly.

If drowsiness or increasing lapses in concentration are detected, the [ATTENTION ASSIST: Take a Break!](#) warning appears in the Instrument Display. You can acknowledge the message and



take a break where necessary. If you do not take a break and ATTENTION ASSIST continues to detect increasing lapses in concentration, you will be warned again after a minimum of 15 minutes.

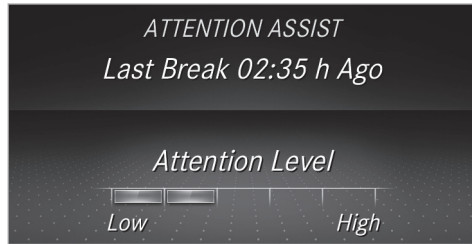

You can have the following status information for ATTENTION ASSIST displayed in the assistance menu of the on-board computer:

- The length of the journey since the last break.
- The attention level determined by ATTENTION ASSIST.

If ATTENTION ASSIST is unable to calculate the attention level and cannot issue a warning, the **System Suspended** message appears.

If a warning is given in the Instrument Display, the multimedia system offers to search for a rest area. You can select a rest area and start navigation to this rest area. This function can be activated and deactivated in the multimedia system.

If ATTENTION ASSIST is deactivated, the  symbol appears in the assistance graphic in the Instrument Display when the engine is running. ATTENTION ASSIST is activated automatically when the engine is re-started. The last selected sensitivity level remains stored.

#### System limits

ATTENTION ASSIST is active in the 37 mph (60 km/h) to 124 mph (200 km/h) speed range.

The functionality of ATTENTION ASSIST is restricted, and warnings may be delayed or not occur at all in the following situations:

- If you have been driving for less than approximately 30 minutes.

- If the road condition is poor (uneven road surface or potholes).
- If there is a strong side wind.
- If you adopt a sporty driving style (high cornering speeds or high rates of acceleration).
- If the Steering Assist function of Active Distance Assist DISTRONIC is active.
- If the time has been set incorrectly.
- In active driving situations, if you change lanes and vary your speed frequently.

The ATTENTION ASSIST tiredness or alertness assessment is deleted and restarted when continuing the journey in the following situations:

- If you switch off the engine.
- If you unfasten your seat belt and open the driver's door (e.g. changing drivers or taking a break).

### Setting ATTENTION ASSIST

Multimedia system:

-  » Settings » Assistance
- » Attention Assist

### Setting options

- ▶ Select **Standard**, **Sensitive** or **Off**.

### Suggesting a rest area

- ▶ Select **Suggest Rest Area**.
- ▶ Activate or deactivate the function. If ATTENTION ASSIST detects fatigue or increasing lack of attention, it suggests a rest area in the vicinity.
- ▶ Select the suggested rest area. You are guided to the selected rest area.

### Traffic Sign Assist

#### Function of Traffic Sign Assist

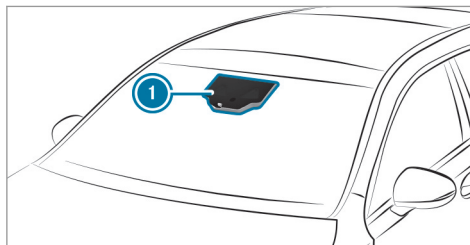

Traffic Sign Assist detects traffic signs with multifunction camera ①. It assists you by displaying detected speed limits and overtaking restrictions in the instrument cluster and optionally in the head-up display or central display.

Since Traffic Sign Assist also uses the data stored in the navigation system, it can update the display in the following situations without detecting traffic signs:

- When the vehicle changes roads, e.g. on a highway entry or exit road.

- When a village or city boundary which is stored in the digital map is passed.

The camera also detects traffic signs with a restriction indicated by an additional sign (e.g. in wet conditions).

Traffic Sign Assist is only an aid. The driver is responsible for keeping a safe distance from the vehicle in front, for vehicle speed and for braking in good time.

#### Warning when the maximum permissible speed is exceeded

The system can warn you if you unintentionally exceed the maximum permissible speed. To do this, you can specify in the multimedia system by how much the maximum permissible speed can be exceeded before a warning is issued. You can specify whether the warning is to be just a visual warning or an acoustic one as well.

## Display in the Instrument Display

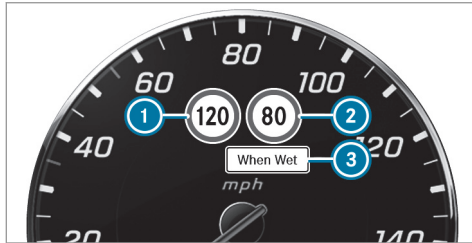

Instrument Display in the Widescreen Cockpit

- ① Permissible speed
- ② Permissible speed when there is a restriction
- ③ Additional sign with restriction

**i Vehicles with a standard Instrument Display:** a + symbol next to a traffic sign in the Instrument Display indicates that additional traffic signs have been detected. These can also be displayed in the media display and optionally in the head-up display.



Traffic Sign Assist is not available in all countries. If it is unavailable, display ① is shown in the speedometer.

### System limits

The system may be impaired or may not function in the following situations:

- If there is poor visibility, e.g. due to insufficient illumination of the road, if there are highly variable shade conditions or in rain, snow, fog or heavy spray.
- If there is glare, e.g. from oncoming traffic, direct sunlight or reflections.

- If the windshield in the area of the multifunction camera is dirty, or if the camera is fogged up, damaged or covered.
- If the traffic signs are hard to detect, e.g. due to dirt or snow, or because they are covered or due to insufficient lighting.
- If the information in the navigation system's digital map is incorrect or out-of-date.
- If the signs are ambiguous, e.g. traffic signs on construction sites or in adjacent lanes.
- If you turn sharply, when passing traffic signs outside the camera's field of vision.

### Setting Traffic Sign Assist Requirements:

- **Only vehicles with Driving Assistance Package:**  
Active Distance Assist DISTRONIC must be activated for the automatic adoption of speed limits.

Multimedia system:

→  → Settings → Assistance  
→ Traffic Sign Assist

### Activating/deactivating automatic adoption of speed limits (only vehicles with Driving Assistance Package)

▶ Select **Limit Adoption**.

▶ Activate or deactivate the function. The speed limits detected by Traffic Sign Assist are automatically adopted by Active Distance Assist DISTRONIC.

 If one of the following systems is activated, the speed detected can be manually adopted as the speed limit:

- Active Distance Assist DISTRONIC
- Cruise control
- Variable limiter

Further information (→ page 203).

### Displaying detected traffic signs in the media display

▶ Select **Display in Central Display**.

▶ Activate or deactivate the function.

### Adjusting the type of warning

▶ Select **Visual & Audible**, **Visual** or **Off**.

### Adjusting the warning threshold

This value determines the speed at which a warning is issued when exceeded.

▶ Select **Warning Threshold**.

▶ Set the desired speed.

### Blind Spot Assist and Active Blind Spot Assist with exit warning

#### Function of Blind Spot Assist and Active Blind Spot Assist with exit warning

Blind Spot Assist and Active Blind Spot Assist use two lateral, rear-facing radar sensors to monitor the area up to 130 ft (40 m) behind and 10 ft (3 m) next to your vehicle.

If a vehicle is detected at speeds above approximately 8 mph (12 km/h) and this vehicle subsequently enters the monitoring range directly next to your vehicle, the warning lamp in the outside mirror lights up red.

If a vehicle is detected close to the side of your vehicle, the red warning lamp in the outside mirror flashes. If you switch on the turn signal indicator in the corresponding direction, a warning tone sounds once. If the turn signal indicator remains switched on, all other detected vehicles are indicated only by the flashing of the red warning lamp.

If you overtake a vehicle quickly, no warning is given.

#### **WARNING** Risk of accident despite Blind Spot Assist

Blind Spot Assist does not react to vehicles approaching and overtaking you at a greatly different speed.

As a result, Blind Spot Assist cannot warn drivers in this situation.

▶ Always pay careful attention to the traffic situation and maintain a safe distance at the side of the vehicle.

Blind Spot Assist and Active Blind Spot Assist are only aids. They may fail to detect some vehi-

cles and are no substitute for attentive driving. Always ensure that there is sufficient distance to the side for other road users and obstacles.

### Exit warning

The exit warning is an additional function of Blind Spot Assist and can warn vehicle occupants about approaching vehicles when leaving the vehicle when stationary.

**⚠ WARNING** Risk of accident despite exit warning

The exit warning reacts neither to stationary objects nor to vehicles approaching you at a greatly different speed.

As a result, the exit warning cannot warn drivers in these situations.

- ▶ Always pay particular attention to the traffic situation when opening the doors and make sure there is sufficient clearance.

If there is a vehicle in the monitoring range, this is indicated in the outside mirror. If a vehicle occupant opens the door on the side with the

warning, a warning tone sounds and the warning lamp in the outside mirror starts to flash.

This additional function is only available when Blind Spot Assist is activated and up to a maximum of three minutes after the ignition has been switched off. The exit warning is no longer available once the warning lamp in the outside mirror flashes three times.

The exit warning is only an aid and not a substitute for the attention of vehicle occupants. The responsibility for opening and closing the doors and for leaving the vehicle remains with the vehicle occupants.

### System limits

Blind Spot Assist and Active Blind Spot Assist may be limited in the following situations:

- If there is dirt on the sensors or the sensors are obscured
- In poor visibility, e.g. due to fog, heavy rain or snow
- If there are narrow vehicles, e.g. bicycles or motorbikes
- If the road has very wide or narrow lanes

- If vehicles are not driving in the middle of their lane

Warnings may be issued in error when driving close to crash barriers or similar solid lane borders. Always make sure that there is sufficient distance to the side for other traffic or obstacles.

Warnings may be interrupted when driving alongside long vehicles, for example trucks, for a prolonged time.

Blind Spot Assist is not operational when reverse gear is engaged.

Blind Spot Assist is not operational when a trailer is coupled to the vehicle and the electrical connection has been correctly established.

The exit warning may be limited in the following situations:

- When the sensors are covered by adjacent vehicles in narrow parking spaces
- When people approach the vehicle
- In the event of stationary or slowly moving objects

### Function of brake application (Active Blind Spot Assist)

**i** The brake application function is only available for vehicles with a Driving Assistance Package.

If Active Blind Spot Assist detects a risk of a side impact in the monitoring range, a course-correcting brake application is carried out. This is designed to help you avoid a collision.

The course-correcting brake application is available in the speed range between approximately 20 mph (30 km/h) and 125 mph (200 km/h).

**⚠ WARNING** Risk of accident despite brake application of Active Blind Spot Assist

A course-correcting brake application cannot always prevent a collision.

▶ Always steer, brake or accelerate yourself, especially if Active Blind Spot Assist warns you or makes a course-correcting brake application.

▶ Always maintain a safe distance at the sides.

**⚠ WARNING** Risk of accident despite Active Blind Spot Assist

Active Blind Spot Assist does not react to the following:

- If vehicles overtake too closely on the side, placing them in the blind spot area
- Vehicles approaching and overtaking you at a greatly different speed

As a result, Active Blind Spot Assist may neither give warnings nor intervene in such situations.

▶ Always pay careful attention to the traffic situation and maintain a safe distance at the side of the vehicle.

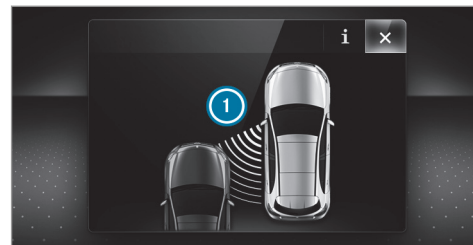

If a course-correcting brake application occurs, the red warning lamp flashes in the outside mirror and a warning tone sounds. In addition, a display **i** indicating the danger of a side collision appears in the multifunction display.

In rare cases, the system may make an inappropriate brake application. This brake application may be interrupted at any time if you steer slightly in the opposite direction or accelerate.

## System limits

Either a course-correcting brake application appropriate to the driving situation, or none at all, may occur in the following situations:

- Vehicles or obstacles, e.g. crash barriers, are located on both sides of your vehicle.
- A vehicle approaches too closely on the side.
- You have adopted a sporty driving style with high cornering speeds.
- You brake or accelerate significantly.
- A driving safety system intervenes, e.g. ESP® or Active Brake Assist.
- ESP® is deactivated.
- A loss of tire pressure or a faulty tire is detected.
- You are driving with a trailer and the electrical connection to the trailer hitch has been correctly established.

## Activating/deactivating Blind Spot Assist or Active Blind Spot Assist

Multimedia system:

→  ▶ Settings ▶ Assistance

▶ Activate or deactivate **Blind Spot Assist**.

or

▶ Activate or deactivate **Act. Blind Spot Assist**.

ⓘ Depending on the vehicle's equipment, Blind Spot Assist or Active Blind Spot Assist is available.

## Active Lane Keeping Assist

### Function of Active Lane Keeping Assist

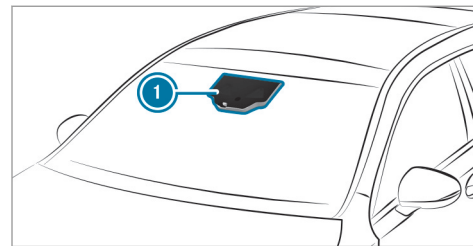

Active Lane Keeping Assist monitors the area in front of your vehicle by means of multifunction camera ①. It serves to protect you against unintentionally leaving your lane. You will be warned by vibration pulses in the steering wheel and guided by a course-correcting brake application back into your lane.

You are warned by vibration pulses in the steering wheel in the following circumstances:

- Active Lane Keeping Assist detects a lane marking.
- A front wheel drives over this lane marking.

You will also be guided back into your lane by means of a course-correcting brake application if the following conditions are met:

- Active Lane Keeping Assist detects lane markings on both edges of the lane.
- A front wheel drives over a solid lane marking.

You can activate or deactivate the Active Lane Keeping Assist warning.

Active Lane Keeping Assist can neither reduce the risk of an accident if you fail to adapt your

driving style nor override the laws of physics. It cannot take into account road, weather or traffic conditions. Active Lane Keeping Assist is only an aid. You are responsible for maintaining a safe distance to the vehicle in front, for vehicle speed, for braking in good time and for staying in lane.

**Vehicles with Driving Assistance Package or Driving Assistance Plus Package:**

Active Lane Keeping Assist can bring the vehicle back into the lane with a lane-correcting brake application. In the case of a broken lane marking being detected, a brake application will only be made if a vehicle has been detected in the adjacent lane. Oncoming vehicles, overtaking vehicles and vehicles in adjacent lanes can be detected.

Active Lane Keeping Assist is available in the speed range between 37 mph (60 km/h) and 124 mph (200 km/h).



If a lane-correcting brake application occurs, display  appears in the multifunction display.

**System limits**

No lane-correcting brake application occurs in the following situations:

- You clearly and actively steer, brake or accelerate.
- You have switched on the turn signal indicator (situation-dependent).
- A driving safety system intervenes, such as ESP®, Active Brake Assist or Active Blind Spot Assist.

- You have adopted a sporty driving style with high cornering speeds or high rates of acceleration.
- When ESP® is deactivated.
- When driving with a trailer, the electrical connection to the trailer has been correctly established.
- If a loss of tire pressure or a faulty tire has been detected and displayed.

The system may be impaired or may not function in the following situations:

- If there is poor visibility, e.g. due to insufficient illumination of the road, if there are highly variable shade conditions or in rain, snow, fog or heavy spray.
- If there is glare, e.g. from oncoming traffic, the sun or reflections.
- If the windshield in the area of the multifunction camera is dirty, or if the camera is fogged up, damaged or covered.
- If there are no lane markings, or several unclear lane markings are present for one lane, e.g. around roadworks.



- If the lane markings are worn, dark or covered.
- If the distance to the vehicle in front is too short and thus the lane markings cannot be detected.
- If the lane markings change quickly, e.g. lanes branch off, cross one another or merge.
- If the roadway is very narrow and winding.

### Activating/deactivating Active Lane Keeping Assist

Multimedia system:

→  » Settings » Quick Access  
» Active Lane Keeping Assist

▶ Activate or deactivate the function.

### Setting Active Lane Keeping Assist

Multimedia system:

→  » Settings » Assistance  
» Active Lane Keeping Assist

### Setting the sensitivity

- ⓘ The availability of this function is dependent on the country.

▶ Select **Standard**, **Sensitive** or **Off**.

### Activating/deactivating the haptic warning

▶ Select **Warning**.  
Activate or deactivate the function.

## Trailer hitch

### Notes on towing a trailer

**Mercedes-AMG vehicles:** be sure to observe the notes in the Supplement. Otherwise, you may fail to recognize dangers.

**Plug-in hybrid:** observe the notes in the Supplement. Otherwise, you may fail to recognize dangers.

**⚠ WARNING** Danger of accident due to unsuitable ball coupling

If you install an unsuitable ball coupling, overloading of the trailer hitch and rear axle will be the result. This is particularly the case if the ball coupling is relatively long or angled differently.

The handling characteristics may be heavily impaired and the trailer can become detached. There is a risk of fatal injury.

- ▶ Only install a ball coupling that meets the permitted dimensions and has been designed for the trailer operation requirements.
- ▶ Do not modify the ball coupling or the trailer hitch.

The values approved by the manufacturer can be found on the identification plates and in the "Technical data" section under "Trailer hitch" for the towing vehicle (→ page 503).

**⚠ WARNING** Swerving of the vehicle/trailer combination due to increased speed

If the vehicle/trailer combination swerves, you can lose control of it.

The vehicle/trailer combination can even tip over.

- ▶ Under no circumstances should you try to increase the speed to straighten the vehicle/trailer combination.
- ▶ Reduce speed and do not counter-steer.
- ▶ If necessary, apply the brakes.

**!** **NOTE** Damage to the engine as a result of overheating

- ▶ If you retrofit a trailer hitch, modifications to the engine cooling system may be necessary, depending on the vehicle model.

When retrofitting a trailer hitch, observe the fastening points on the chassis.

Retrofitting a trailer hitch is permissible only if a trailer load is specified in your vehicle documents. If this is not the case, the vehicle is not approved for trailer operation.

Further information can be obtained at a qualified specialist workshop.

If the trailer coupling is removable, it is essential to comply with the operating instructions of the trailer coupling manufacturer.

Couple and uncouple the trailer carefully. If you do not connect the trailer to the towing vehicle correctly, the trailer may become detached.

Observe the following notes on the tongue weight:

- Do not use a tongue weight that exceeds or falls below the permissible tongue weight
- Use a tongue weight as close as possible to the maximum tongue weight

Do not exceed the following values:

- Permissible trailer load
- Permissible rear axle load of the towing vehicle
- Permissible gross weight of the towing vehicle
- Permissible gross weight of the trailer
- Maximum permissible speed of the trailer

Ensure the following before starting a journey:

- The tire pressure on the rear axle of the towing vehicle is set for a maximum load
- The lighting of the connected trailer is operational
- **Vehicles without LED headlamps or MULTIBEAM LED headlamps:** the headlamps have been set correctly

In the event of increased rear axle load, the vehicle/trailer combination may not exceed a maximum speed of 62 mph (100 km/h) for reasons concerning the operating permit. This also applies in countries in which the permissible maximum speed for vehicle/trailer combinations is above 62 mph (100 km/h).

### Attaching the ball neck

**▲ WARNING** Risk of accident and injury due to an incorrectly installed ball coupling

If the ball coupling is not installed and engaged correctly, it may become detached during travel and endanger other road users. There is a risk of fatal injury.

- ▶ Install and secure the ball coupling as described in the ball coupling manufacturer's installation instructions.
- ▶ When the ball coupling has been installed, ensure that it is correctly secured before every trip.

**▲ WARNING** Risk of accident due to an incorrectly installed and secured ball coupling

If the ball coupling has not been correctly installed and secured, the trailer can become detached.

- ▶ Install and secure the ball coupling as described in the ball coupling manufacturer's installation instructions.
- ▶ When the ball coupling has been installed, ensure that it is correctly secured before every trip.

#### Requirements:

- The vehicle is secured against rolling away.

#### Attaching the ball neck

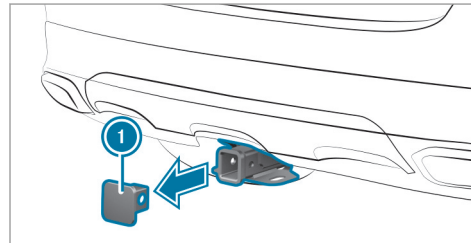

- ▶ Remove cover ① from the ball neck mount in the direction of the arrow.

- ▶ Store cover ① so that it cannot move around.
- ▶ Observe the manufacturer's installation instructions.

Observe the notes on loading the vehicle.

### Coupling up/uncoupling a trailer

**▲ WARNING** Risk of injury from the vehicle level being changed

**Vehicles with level control system:** the vehicle level may be changed unintentionally, e.g. by other persons. You may become trapped if you couple up or uncouple a trailer while the vehicle level is changing. In addition, other people could become trapped if their limbs are between the vehicle body and the tires or underneath the vehicle.

When coupling up or uncoupling a trailer, make sure that:

- ▶ The doors or tailgate are not opened or closed.

- ▶ You do not initiate the level control system and do not operate the DYNAMIC SELECT switch.
- ▶ Do not lock or unlock the vehicle.

### Requirements:

- The vehicle is secured with the electric parking brake.
- The transmission is in position **P**.

The trailer will be correctly detected by the vehicle only if the following conditions are met:

- The trailer is connected correctly.
- The trailer lighting system is in working order.

The functions of the following systems are affected by a correctly connected trailer:

- Active Lane Keeping Assist
- ESP® trailer stabilization
- Parking Assist PARKTRONIC
- Active Parking Assist
- Blind Spot Assist or Active Blind Spot Assist

- Drive Away Assist
- Cross Traffic Alert
- Rear view camera
- 360° Camera

**Vehicles without a level control system:** the ball head height will change depending on the vehicle's load. In this case, use a trailer with a height-adjustable drawbar.

### Coupling up a trailer

**!** **NOTE** Damage to the battery due to full discharge

Charging the trailer battery using the power supply of the trailer can damage the vehicle battery.

- ▶ Do not use the vehicle's power supply to charge the trailer battery.

Information about a suitable ball neck for Mercedes-Benz vehicles can be obtained from a qualified specialist workshop, e.g. an authorized Mercedes-Benz Center.

- ▶ Remove the cover from the ball neck mount and store it in a safe place (→ page 249).
- ▶ Position the trailer on a level surface behind the vehicle and couple it up to the vehicle.
- ▶ Establish the electrical connection between the vehicle and the trailer.

**i** Accessories can be connected to the permanent power supply up to 180 W and to the power supply that is switched on via the ignition lock.

### Decoupling a trailer

**!** **WARNING** Risk of being crushed and becoming trapped when uncoupling a trailer

When uncoupling a trailer with an engaged inertia-activated brake, your hand may become trapped between the vehicle and the trailer drawbar.

- ▶ Do not uncouple trailers with an engaged overrun brake.

**!** **NOTE** Damage when uncoupling in a state of overrun

Uncoupling in a state of overrun can damage the vehicle.

- ▶ Do not uncouple trailers with an engaged overrun brake.

**!** **WARNING** Risk of becoming trapped when disconnecting the trailer cable

**Vehicles with level control system:** The vehicle may lower when the trailer cable is disconnected.

This could result in you or other people becoming trapped if your or their limbs are between the vehicle body and the tires or underneath the vehicle.

- ▶ Make sure that nobody is underneath the vehicle or in the immediate vicinity of the wheel arches when you disconnect the trailer cable.

- ▶ Disconnect the electrical connection between the vehicle and the trailer.

- ▶ Uncouple the trailer.
- ▶ Place the cover on the ball neck mount.

### Vehicle towing instructions

The vehicle is not suitable for the use of tow bar systems that are used for flat towing or dinghy towing, for example. Attaching and using tow bar systems can lead to damage on the vehicle. When you are towing a vehicle with tow bar systems, safe driving characteristics cannot be guaranteed for the towing vehicle or the towed vehicle. The vehicle-trailer combination may swerve from side to side. Comply with the permitted towing methods (→ page 449) and the instructions for towing with both axles on the ground (→ page 450).

### Instrument Display overview

**Mercedes-AMG vehicles:** be sure to observe the notes in the Supplement. Otherwise, you may fail to recognize dangers.

**Plug-in hybrid:** be sure to observe the notes in the Supplement. Otherwise, you may fail to recognize dangers.

#### **⚠ WARNING** Risk of accident due to an instrument display malfunction

If the Instrument Display has failed or malfunctioned, you may not recognize function restrictions applying to safety relevant systems.

The operating safety of your vehicle may be impaired.

- ▶ Drive on carefully.
- ▶ Have the vehicle checked immediately at a qualified specialist workshop.

If the operating safety of your vehicle is impaired, park the vehicle immediately and safely. Contact a qualified specialist workshop.

### Instrument Display (standard)

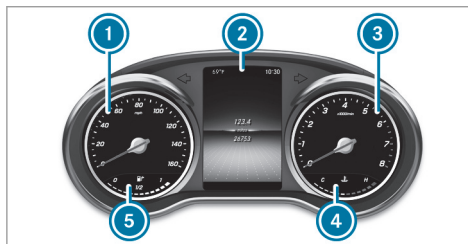

- ① Speedometer
- ② Multifunction display
- ③ Tachometer
- ④ Coolant temperature gauge
- ⑤ Fuel level and fuel filler flap location indicator

### Instrument Display in the Widescreen Cockpit

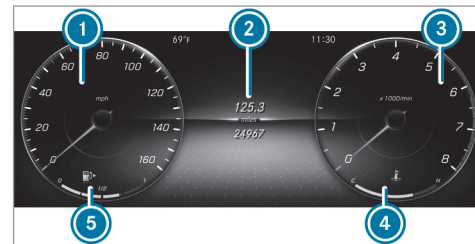

- ① Speedometer
- ② Multifunction display
- ③ Area for additional values
- ④ Coolant temperature gauge
- ⑤ Fuel level and fuel filler flap location indicator

**i** Further display content can be shown on the display for additional values (→ page 255).

The segments on speedometer ① indicate the system status for the following:

- Cruise control (→ page 197)

- Active Distance Assist DISTRONIC  
(→ page 201)

**!** **NOTE** Engine damage due to excessively high engine speeds

The engine will be damaged if you drive with the engine in the overrevving range.

- ▶ Do not drive with the engine in the overrevving range.

The fuel supply will be interrupted to protect the engine when the red mark on the tachometer (overrevving range) is reached.

During normal operating conditions, coolant temperature display ④ may rise to the red mark.

**!** **WARNING** Danger of burns when opening the hood

If you open the hood when the engine has overheated or during a fire in the engine compartment, you could come into contact with hot gases or other escaping operating fluids.

- ▶ Before opening the hood, allow the engine to cool down.
- ▶ In the event of a fire in the engine compartment, keep the hood closed and call the fire service.

### Overview of the buttons on the steering wheel

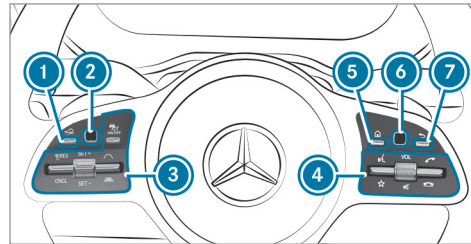

- ① Back/Home button (press and hold), on-board computer
- ② Touch Control, on-board computer

- ③ Control panel for cruise control or Active Distance Assist DISTRONIC
- ④ Control panel for MBUX multimedia system:
  - Voice Control System
  - Displays favorites
 VOL: control knob, adjusts the volume or switches the sound off (press)
  - Makes/accepts a call
  - Rejects/ends a call
  - ⑤ Calls up the home screen
  - ⑥ Touch Control multimedia system
  - ⑦ Back button

### Operating the on-board computer

**Mercedes-AMG vehicles:** observe the notes in the Supplement. Otherwise, you may fail to recognize dangers.

**⚠ WARNING** Risk of distraction from information systems and communications equipment

If you operate information and communication equipment integrated in the vehicle when driving, you will be distracted from the traffic situation. This could also cause you to lose control of the vehicle.

- ▶ Only operate this equipment when the traffic situation permits.
- ▶ If you cannot be sure of this, stop the vehicle whilst paying attention to road and traffic conditions and operate the equipment with the vehicle stationary.

Observe the legal requirements for the country in which you are currently driving when operating the on-board computer.

- ① The on-board computer displays will appear on the multifunction display (→ page 256).

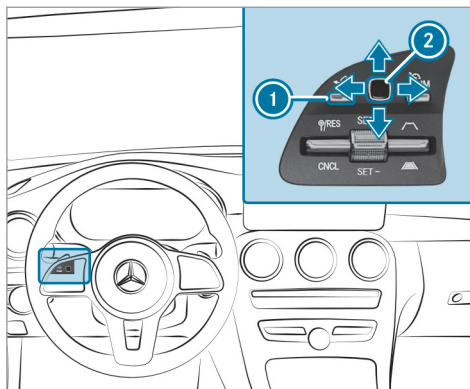

The on-board computer is operated using left-hand Touch Control ② and the left-hand back/home button ①.

When the on-board computer is being operated, different acoustic signals will sound as operating feedback, e.g. when the end of a list is reached or when you are scrolling through a list.

The following menus are available:

- [Service](#)

- [DriveAssist](#)
- [Trip](#)
- [Navigation](#)
- [Radio](#)
- [Media](#)
- [Phone](#)
- [Head-up Disp.](#)
- **Vehicles with an Instrument Display in the Widescreen Cockpit:** [Designs](#)

The menus can be called up from the menu bar on the multifunction display.

- ▶ **To call up the menu bar:** press back button on the left ① until the menu bar is displayed.

- ① Press the  button to call up the menu bar of the on-board computer.





- ▶ **To scroll in the menu bar:** swipe left or right on left-hand Touch Control ②.
- ▶ **To call up a menu or confirm a selection:** press left-hand Touch Control ②.
- ▶ **To scroll through displays or lists on the menu:** swipe upwards or downwards on left-hand Touch Control ②.
- ▶ **To call up a submenu or confirm a selection:** press left-hand Touch Control ②.
- ▶ **To exit a submenu:** press back button on the left ①.

### Setting the design

On-board computer:

↳ Designs

- ① This function is available only for vehicles with a Widescreen Cockpit.

The following designs can be selected:

- Classic
- Sport
- Progressive

- ▶ **To select a design:** swipe upwards or downwards on the left-hand Touch Control.
- ▶ Press the left-hand Touch Control. The Instrument Display will be shown in the selected design.

### Setting the area for additional values



G-meter (example)

- ① Area for additional values
- ② Index points

- ▶ **To select display content:** swipe to the right on the left-hand Touch Control.
- ▶ Swipe upwards or downwards on the left-hand Touch Control to select display content. When display content is selected, the area for additional values ① will briefly be highlighted. Index points ② will display the selected list item.

## 256 Instrument Display and on-board computer

The following display content can be selected in the **Classic** and **Sport** designs:

- Tachometer
- Navigation
- ECO display
- Consumption
- G-meter

The following content can be selected in the **Progressive** design:

- date
- Navigation
- ECO display
- Consumption
- G-meter

### Overview of displays on the multifunction display

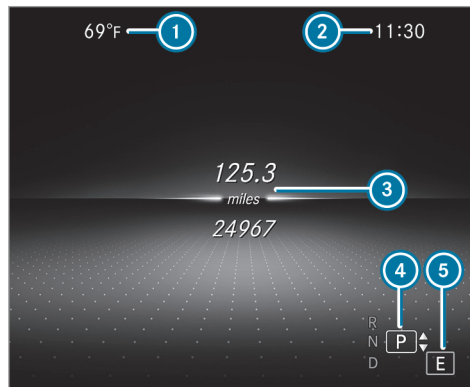

- 1 Outside temperature
- 2 Time
- 3 Display section
- 4 Transmission position
- 5 Drive program

Further displays on the multifunction display:

- ↑ Gearshift recommendation (→ page 171)
- Active Parking Assist activated (→ page 234)
- Parking Assist PARKTRONIC deactivated (→ page 224, 223, 224)
- Cruise control (→ page 197)
- DSR (→ page 199)
- Active Distance Assist DISTRONIC (→ page 201)
- Active Brake Assist (→ page 197)
- Active Steering Assist (→ page 207)
- Active Lane Keeping Assist (→ page 245)
- Active Lane Change Assist (→ page 209)
- ECO start/stop function (→ page 162)
- HOLD function (→ page 213)
- Adaptive Highbeam Assist (→ page 133)

**Vehicles with Traffic Sign Assist:** Detected instructions and traffic signs (→ page 240).

### Adjusting the instrument lighting

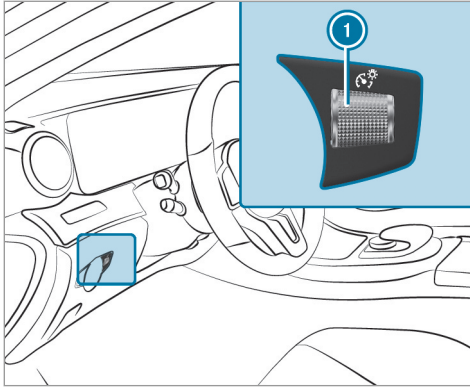

- ▶ Turn brightness control ① up or down. The lighting of the Instrument Display and in the control elements of the vehicle interior is adjusted.

### Menus and submenus

#### Calling up functions on the service menu of the on-board computer

On-board computer:

→ Service

- ▶ **To select a function:** swipe upwards or downwards on the left-hand Touch Control.
- ▶ Press the left-hand Touch Control.

Functions on the **Service** menu:

- Message memory (→ page 505)
- **Tires:**
  - Restart the tire pressure loss warning system (→ page 466)
  - Check the tire pressure with the tire pressure monitor (→ page 464)
  - Restart the tire pressure monitor (→ page 465)
- **ASSYST PLUS:** call up the service due date (→ page 420)
- **Vehicles with a Widescreen Cockpit:** **Coolant:** coolant temperature display

- **Engine Oil Level:** engine oil level

#### Calling up displays on the Assistance menu

On-board computer:

→ DriveAssist



The following displays are available on the Assistance menu:

- Assistant display
- Attention level (→ page 238)

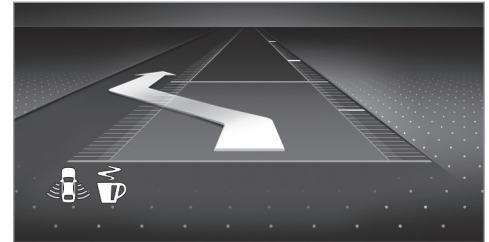
- ▶ **To switch between the displays:** swipe upwards or downwards on the left-hand Touch Control.



Status displays on the assistant display:

-  ATTENTION ASSIST: deactivated
- Light lane markings: Active Lane Keeping Assist enabled
- Green lane markings: Active Lane Keeping Assist active
-  Gray radar waves next to vehicle: Blind Spot Assist or Active Blind Spot Assist enabled
-  Green radar waves next to vehicle: Blind Spot Assist or Active Blind Spot Assist active
- Active Distance Assist DISTRONIC displays (→ page 201)
- Active Lane Change Assist displays (→ page 209)

### Calling up displays on the Trip menu

On-board computer:

 Trip

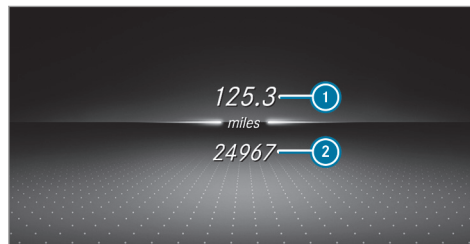

Standard display (example)

- ① Trip distance
- ② Total distance

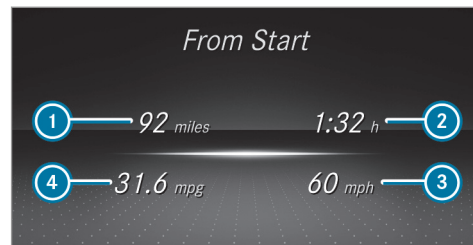

Trip computer (example)

- ① Total distance
- ② Driving time
- ③ Average speed
- ④ Average fuel consumption

 You can view information about the journey in the left-hand area of the Instrument Display.

 **To select a display:** swipe upwards or downwards on the left-hand Touch Control.

Displays on the Trip menu:

- Standard display
- Range and current fuel consumption

If there is only a small amount of fuel left in the fuel tank, the display will show a vehicle being refueled instead of the range.

- ECO display (→ page 165)
- Trip computer [From Start](#) and [From Reset](#)
- Digital speedometer

### Resetting values on the trip menu of the on-board computer

On-board computer:

↳ Trip

**i** The spelling of the main menu displayed may differ. Therefore, observe the menu overview for the Instrument Display (→ page 253).

You can reset the values of the following functions:

- Trip distance
- Trip computer [From Start](#) and [From Reset](#)
- ECO display (→ page 165)

- ▶ **To select the function to be reset:** swipe upwards or downwards on the left-hand Touch Control.
- ▶ Press the left-hand Touch Control.
- ▶ Select **Yes**.
- ▶ Press the left-hand Touch Control.

If you press and hold the left-hand Touch Control, the values of the function will be reset immediately.

### Calling up navigation instructions on the on-board computer

On-board computer:

↳ Navigation



Example: no change of direction announced

- ① Distance to the next change of direction
- ② Distance to the next destination
- ③ Estimated arrival time at next destination
- ④ Current road

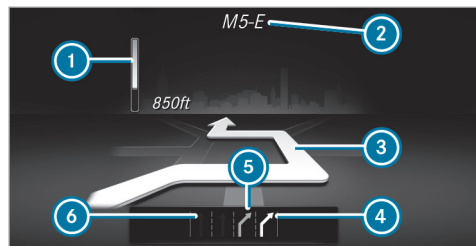

Example: change of direction announced

- ① Distance to the change of direction
- ② Road to which the change of direction leads
- ③ Change-of-direction symbol
- ④ Recommended lane (white)
- ⑤ Possible lane
- ⑥ Lane not recommended (dark gray)

Further possible displays on the [Navigation](#) menu:

- [Direction of Travel](#): display of direction of travel and road currently being traveled on.
- [New Route...](#) or [Calculating Route...](#): a new route is being calculated.

- [Road Not Mapped](#): the road is unknown, e.g. for newly built roads.
- [No Route](#): no route could be calculated to the selected destination.
- [Off Map](#): the map for the current location is not available.
- [Area of Destination Reached](#): you have reached the area of the destination.
- : you have reached the destination or an intermediate destination.

▶ **To exit the menu:** press the back button on the left.

**Vehicles with the MBUX multimedia system:** You can also start navigation to one of the recent destinations on the [Navigation](#) menu:

▶ Press the left-hand Touch Control.

▶ **To select a destination:** swipe upwards or downwards on the left-hand Touch Control.

▶ Press the left-hand Touch Control. Route guidance will start.

If route guidance has already been activated, a query will appear asking whether you wish to end the current route guidance.

▶ Select [Yes](#).

▶ Press the left-hand Touch Control. Route guidance will start.

## Selecting radio stations using the on-board computer

On-board computer:

↳ Radio

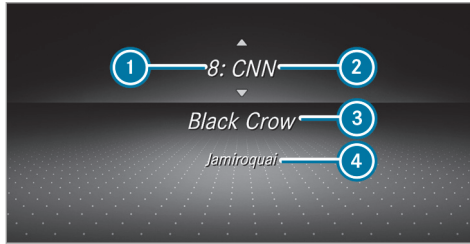

- ① Memory preset
- ② Channel name
- ③ Name of track
- ④ Name of artist

When you select a station from the memory presets, the preset will appear next to the station name. When you select a saved station in the frequency range, an asterisk will appear next to the station name.

- ▶ **To select a radio station:** swipe upwards or downwards on the left-hand Touch Control.

## Selecting the frequency range or memory preset

- ▶ Press the left-hand Touch Control.
- ▶ **To select the frequency range/station preset:** swipe upwards or downwards on the left-hand Touch Control.
- ▶ Press the left-hand Touch Control.

## Operating media playback using the on-board computer

On-board computer:

↳ Media



- ① Media source
- ② Track number and current track
- ③ Name of artist
- ④ Name of album

- ▶ **To change tracks on an active media source:** swipe upwards or downwards on the left-hand Touch Control.

### Changing a media source

- ▶ Press the left-hand Touch Control.
- ▶ **To select a media source:** swipe upwards or downwards on the left-hand Touch Control.
- ▶ Press the left-hand Touch Control.

### Dialing telephone numbers using the on-board computer

**⚠ WARNING** Risk of distraction from information systems and communications equipment

If you operate information and communication equipment integrated in the vehicle when driving, you will be distracted from the traffic situation. This could also cause you to lose control of the vehicle.

- ▶ Only operate this equipment when the traffic situation permits.
- ▶ If you cannot be sure of this, stop the vehicle whilst paying attention to road

and traffic conditions and operate the equipment with the vehicle stationary.

When using the phone, observe the legal requirements for the country in which you are currently driving.

#### Requirements:

- The mobile phone is connected to the multimedia system.

On-board computer:

➔ [Phone](#)

The most recent telephone calls (dialed, received and missed calls) are displayed on the [Phone](#) menu.

- ▶ **To select an entry:** swipe upwards or downwards on the left-hand Touch Control.
- ▶ Press the left-hand Touch Control.  
**If there is only one telephone number saved to an entry:** the telephone number will be selected.
- ▶ **If there are multiple telephone numbers saved to an entry:** swipe upwards or down-

wards on the left-hand Touch Control to select the desired telephone number.

- ▶ Press the left-hand Touch Control.  
The telephone number will be dialed.



The following displays may appear instead of the telephone numbers dialed:



- **Please Wait...:** the application is starting. If a Bluetooth® connection to the mobile phone is not established, the menu for authorizing and connecting a mobile phone will be displayed on the multimedia system (→ page 369).
- **Updating data...:** the call list is being updated.
- **Importing Contacts...:** contacts are being imported from the mobile phone or a storage medium.

#### Accepting/rejecting an incoming call

**Vehicles with Head-up Display:** when you receive a call, the [Incoming Call](#) message will appear on the Head-up Display.



- ▶ Swipe upwards or downwards on the left-hand Touch Control and select  (Accept) or  (Reject).
- ▶ Press the left-hand Touch Control.

You may accept or reject the call using the  or  button on the steering wheel.

### Adjusting the Head-up Display settings on the on-board computer

On-board computer:

→ Head-up Disp.



- ① Setting currently selected
- ② Digital speedometer
- ③ Traffic Sign Assist
- ④ Navigation displays

The following Head-up Display settings can be adjusted:

- Position
- Brightness

#### • Display Content

- ▶ **To select a setting:** swipe upwards or downwards on the left-hand Touch Control.
- ▶ Press the left-hand Touch Control.
- ▶ **To adjust a value:** swipe upwards or downwards on the left-hand Touch Control.
- ▶ Press the left-hand Touch Control.

### Head-up Display

#### Function of the Head-up Display

**Mercedes-AMG vehicles:** be sure to observe the notes in the Supplement. Otherwise, you may not recognize dangers.

The Head-up Display projects the following into the driver's field of vision:

- Information from the navigation system
- Information from the driver assistance systems
- Some warning messages

### Display elements

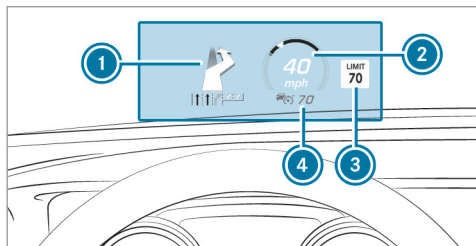

- ① Navigation instructions
- ② Current speed
- ③ Detected instructions and traffic signs
- ④ Set speed in the driver assistance system (e.g. cruise control)

When you receive a call, the  Incoming Call message will appear on the Head-up Display.

In audio mode, the station name or track will be shown temporarily when the audio source is being actively operated.

### System limitations

The visibility is influenced by the following conditions:

- Seat position
  - The positioning of the display image
  - Light conditions
  - Wet roads
  - Objects on the display cover
  - Polarization in sunglasses
- ⓘ In extreme sunlight, sections of the display may appear washed out. You can correct this by switching the Head-up Display off and on again.

### Switching the Head-up Display on/off

Multimedia system:

   Settings  Quick Access

- ▶ Select HUD.
- ▶ The Head-up Display is activated.

### Notes on operating safety

**▲ WARNING** Risk of distraction from information systems and communications equipment

If you operate information and communication equipment integrated in the vehicle when driving, you will be distracted from the traffic situation. This could also cause you to lose control of the vehicle.

- ▶ Only operate this equipment when the traffic situation permits.
- ▶ If you cannot be sure of this, stop the vehicle whilst paying attention to road and traffic conditions and operate the equipment with the vehicle stationary.

**▲ WARNING** Risk of an accident from operating mobile communication equipment while the vehicle is in motion

Mobile communications devices distract the driver from the traffic situation. This could

also cause the driver to lose control of the vehicle.

- ▶ As the driver, only operate mobile communications devices when the vehicle is stationary.
- ▶ As a vehicle occupant, only use mobile communications devices in the areas intended for this purpose, e.g. in the rear passenger compartment.

**▲ WARNING** Risk of injury due to objects being stowed incorrectly

If objects in the vehicle interior are stowed incorrectly, they can slide or be thrown around and hit vehicle occupants. In addition, cup holders, open stowage spaces and mobile phone receptacles cannot always retain all objects they contain.

There is a risk of injury, particularly in the event of sudden braking or a sudden change in direction.

- ▶ Always stow objects so that they cannot be thrown around in such situations.
- ▶ Always make sure that objects do not protrude from stowage spaces, luggage nets or stowage nets.
- ▶ Close the lockable stowage spaces before starting a journey.
- ▶ Always stow and secure heavy, hard, pointed, sharp-edged, fragile or bulky objects in the trunk/load compartment.

For your own safety, always observe the following points when operating mobile communications equipment and especially your voice control system:

- Observe the legal requirements for the country in which you are driving.
- While driving, only operate mobile communications equipment and your voice control system when the traffic conditions permit it. You may otherwise be distracted from the traffic conditions and cause an accident, injuring yourself and others.



- If you use the voice control system in an emergency your voice can change and your telephone call, e.g. an emergency call, can thereby be unnecessarily delayed.
- Familiarize yourself with the voice control system functions before starting the journey.
- Comply with the loading guidelines (→ page 106).

## Operation

### Overview of operating the multifunction steering wheel

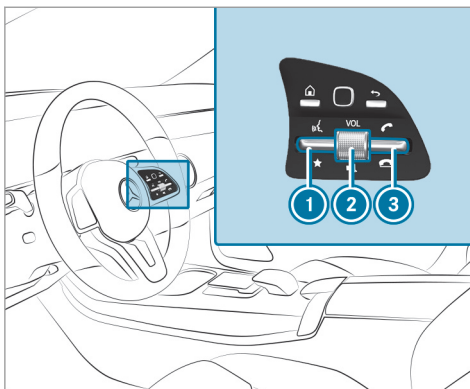
The Voice Control System is operational approximately thirty seconds after the ignition is switched on.



- 1 Press the rocker switch up:  starts the dialog
- 2 Press the control knob:  switches the sound off or on (ends the dialog)  
Turn the control knob up/down: increases/ decreases the volume
- 3 Press the rocker switch down:  rejects/ ends a call (ends the dialog)



### Conducting a dialog

For the dialog with the Voice Control System, you can use complete sentences of colloquial language as voice commands, such as, for example, "Please show me the list of the last calls" or "How warm is it outside?". It is not necessary to first change to the relevant application such as "Telephone" or "Vehicle function".

► **To activate or continue dialog by using a keyword:** say "Hello Mercedes" to activate the Voice Control System. Voice activation must be switched on in the multimedia system (→ page 267). For this, it is not necessary to press up the  rocker switch on the multifunction steering wheel. Voice activation can also be directly combined with a voice command, e.g. "Hi Mercedes, how fast can I drive?".

or

► Press the  rocker switch up on the multifunction steering wheel.  
You can say a voice command after an acoustic signal.

- ▶ **To correct an entry:** say the Correction voice command.
- ▶ **To select an entry from the selection list:** say the line number or the contents.
- ▶ **To browse the selection list:** say the Next or Back voice command.
- ▶ **To interrupt the dialog:** say the Pause voice command.  
The dialog can be continued with the "Hello Mercedes" voice command or by pressing up the  rocker switch on the multifunction steering wheel.
- ▶ **To jump to the preceding dialog:** say the Back voice command.
- ▶ **To jump back to the top dialog level:** say the Home voice command.
- ▶ **To cancel the dialog:** say the Close voice command or press the  or  button on the multifunction steering wheel.

- ▶ **To interrupt a voice output:** speak in the middle of a voice dialog when the system is still answering.  
The voice output is shortened and the conclusion is reached more quickly.
- ⓘ The **Speak During Voice Output** option must be switched on in the multimedia system for this (→ page 267).

### Overview of operable functions in the Voice Control System

You can use the Voice Control System to operate the following functions depending on the vehicle equipment:

- Telephone
- Text messages
- Navigation
- Address book
- Radio
- Media
- Vehicle functions
- Weather

Full functionality is only available for you with activation of online voice control (→ page 267).

### Notes on the language setting

You can change the language of the Voice Control System via the system language settings. If the set system language is not supported by the Voice Control System, English will be selected.

The Voice Control System is available in English, French, Portuguese and Spanish.

### Setting the Voice Control System (multimedia system)

#### Requirements:

- **For online voice control:** your vehicle is connected with your Mercedes me user account (→ page 390).
- There is an Internet connection (→ page 394).
- **For online use of contacts:** online voice control is activated.

Multimedia system:

→  → Settings → System  
 → LINGUATRONIC

### Switching voice activation of the Voice Control System on/off

- ▶ Select **Voice Activation "Hey Mercedes"**. Depending on the previous status, the function is activated or deactivated.

When the function is active, the "Hi Mercedes" voice command can activate the dialog.

### Activating/deactivating online voice control

- ▶ Activate **Online Voice Control**.
- ① Online voice control is activated at the factory.
- ▶ Select **Online Voice Control Subscr..** You will be connected with the Mercedes me portal.
- ▶ Activate online voice control in the Mercedes me portal.

### Activating contacts for online use

- ▶ Select **Contacts for Online Use**. When the function is active, contacts will be found more easily and accurately using voice input. The quality of the enunciation of contact names by the system will also be improved.

### Switching on voice interruption

- ▶ Select **Speak During Voice Output**. If the function is active, a command can be interjected during voice output of the system.



### Using the Voice Control System effectively

#### Voice Control System audible help functions

Using the corresponding voice commands you receive the following information and assistance in the following cases:

- **For optimal operation:** say the Voice control tutorial voice command or call up the Digital Operator's Manual with Could you go to the Voice Control System tutorial please?,

for example. The full extent of the Digital Operator's Manual is available when the vehicle is stationary. Here you can also find explanatory videos which introduce you to the functions of the Voice Control System.

- **Current application:** on the multifunction steering wheel, press the  rocker switch up and say the Help voice command. You will receive suggestions and information about operation of the Voice Control System for the current application.
- **Continued dialog:** say the Help voice command during a voice dialog. For every step of the dialog you receive matching information.
- **Specific function:** say the voice command for the desired function, e.g. with "Hello Mercedes, I need help with the radio" or after pressing the  rocker switch on the multifunction steering wheel up, say the Help for the telephone voice command, for example.

## Notes on optimal use of the Voice Control System

Notes on how to improve recognition:

- Activate online voice control (→ page 267).
- Only operate the Voice Control System from the driver's seat.
- Say the voice commands coherently and clearly, but do not exaggerate the words.
- Avoid loud noises that cause interference while making a voice command entry, e.g. the entertainment in the rear passenger compartment.
- **For telephone or address book entries:**
  - Only create sensible address book entries in the system/mobile phone, e.g. enter surname and first name in the correct field.
  - Do not use any abbreviations, unnecessary spaces or special characters.
- **For radio station names:** say the Read out station list voice command and say the desired station name in the way the voice output reads aloud to you.

- ① To improve recognition, depending on the outside temperature, either the blowers for ventilation or heating are reduced when the Voice Control System is started.

## Notes on online voice control

Online voice control improves recognition and makes additional results available as a result of external information, e.g. information about POIs and about the weather. We therefore recommend that you activate online voice control.

You will need a Mercedes me user account for this. If you do not yet have a user account you have to create one and connect it with your vehicle (→ page 298).

Then call up your Mercedes me user account. The Mercedes me services are shown and can be activated (→ page 299).

In addition, online voice control must be activated (→ page 267).

## Essential voice commands

### Notes on the voice commands

Aside from the exact voice commands (see the "Voice command" column in the following tables) to call up specific functions, in most cases the Voice Control System also understands a great many paraphrases from daily usage. Examples of these are listed in the "Colloquial examples" column. For some languages however these examples are only available to a limited extent.

- ① Content in angled brackets, e.g. <POI> or <contact>, is a placeholder which has to be completed by you with the desired term. The voice command Set <POI> as intermediate destination could, for example, be completed with: Set Mercedes-Benz Arena as intermediate destination.

## Overview of switch voice commands

Switch voice commands can be used to open certain applications.

**Switch voice commands**

| Voice command          | Colloquial example                              | Function                                      |
|------------------------|---|---|
| Switch to navigation   | I would like to go to navigation                | Switches to navigation                        |
| Switch to address book | I would like to switch to the address book      | Switches to the address book                  |
| Switch to telephone    | I would like to switch to the phone             | Switches to the telephone                     |
| Switch to messages     | Can you switch to messages please?              | Switches to the text message application      |
| Switch to radio        | I would like to switch to the radio             | Switches to radio                             |
| Switch to media        | I would like to switch to the media application | Switches to media                             |
| Switch to comfort      | I would like to go to the comfort application   | Switches to the comfort settings              |
| Switch to vehicle info | I would like to go to the vehicle application   | Switches to vehicle information               |
| Switch to settings     | I would like to go to the settings menu         | Switches to the menu with the setting options |



**i** It is not necessary to first call up a menu in order to operate a function it contains with the Voice Control System. You can operate the function directly using voice input, e.g. call a contact or enter a destination for navigation.

You can find further information in the overview tables for voice commands.

### Overview of navigation voice commands

Using the navigation voice commands you can enter POIs and conventional addresses or navigation.

to your own contacts. You can also carry out important navigation settings directly. The following list offers just a small selection of the possible navigation commands. You will receive additional suggestions if you say Help for navigation.

#### Navigation voice commands

| Voice command         | Colloquial example                                | Function  |
|-----------------------|---|---|
| Navigate to <address> | Navigate to Canal Street, New York                | Starts route guidance to the desired address.             |
| Navigate to <contact> | Drive/bring me to the contact address of John Doe | Starts route guidance to a contact from the address book. |

| Voice command                | Colloquial example   | Function   |
|------------------------------|--|--|
| Navigate to <3 word address> | <p>The example is for the English language:<br/>Drive to Parade.Help.Bleat</p> | <p>Starts route guidance to a 3 word address from what3words.<br/>The example mentioned navigates you to the Empire State Building.<br/>Observe the following information:</p> <ul style="list-style-type: none"> <li>• 3 word addresses are language dependent.</li> <li>• Searching for a destination using 3 word addresses is not possible in all countries and in all languages. Additional information on 3 word addresses from what3words can be found in the Navigation section under "Entering the destination as a 3 word address".</li> </ul> <p>The Empire State Building, for example, has the following 3 word addresses:</p> <ul style="list-style-type: none"> <li>• English: <b>parade.help.bleat</b></li> <li>• French: <b>commun.verbe.bisquer</b></li> <li>• Spanish: <b>suertes.diga.pesca</b></li> </ul> |
| Home                         | I would like to go home/I want to drive to my home address                     | Starts route guidance to the home address.   |
| Work                         | I would like to navigate to work   | Starts route guidance to work.   |
| Enter POI                    | Take me to a POI   | Enters a POI, e.g. Brandenburg Gate.   |
| Navigate to <POI>            | Navigate to "McDonald's"   | Starts route guidance to a POI.  |

| Voice command                             | Colloquial example  | Function   |
|---|---|--|
| Navigate to the online POI <POI>          | Navigate to online POI "McDonald's"                               | Searches online for a POI and starts route guidance.                 |
| Start route guidance                      | Begin route guidance/Can you start route guidance?                | Starts route guidance to a destination.                              |
| Cancel route guidance                     | Can you quit route guidance?                                      | Cancels route guidance.  |
| Restart route guidance                    | I would like to resume route guidance                             | Continues route guidance after a break.                              |
| Set <address> as intermediate destination | Set "9 Euclid Avenue in Cleveland" as an intermediate destination | Selects an intermediate destination for the route.                   |
| Set <contact> as intermediate destination | Set "John Doe" as intermediate destination                        | Selects an intermediate destination from the contacts for the route. |
| Set <POI> as intermediate destination     | Set "Trump Tower" as an intermediate destination                  | Selects a POI as an intermediate destination for the route.          |
| Enter address in <country>                | I would like to enter a new address in "France"                   | Selects a destination in another country.                            |
| Enter ZIP code                            | Start route guidance to a new ZIP code                            | Enters a ZIP code.   |
| Last destinations                         | Show the previous destinations                                    | Selects a destination from the previous destinations.                |

| <b>Voice command</b>        | <b>Colloquial example</b>                         | <b>Function</b>                                 |
|-----------------------------|---|---|
| Show alternative routes     | Search for alternative routes                     | Shows one of the alternative routes calculated. |
| Driving recommendations on  | Switch on driving recommendations                 | Switches on voice output for route guidance.    |
| Driving recommendations off | Mute the driving instructions                     | Switches off voice output for route guidance.   |
| Show traffic map            | Switch on traffic jam info                        | Displays traffic information on the map.        |
| Hide traffic map            | Switch off the traffic jam messages               | Hides the traffic information.                  |
| POI icons on                | Show me point of interest icons on the map please | Displays the POI symbols on the map.            |
| Hide POI icons              | I would like to hide all POI symbols              | Hides the POI symbols.                          |

### Overview of telephone voice commands

You can use the telephone voice commands to make phone calls or search through the address

book. The following list offers just a small selection of the possible telephone commands. You

will receive additional suggestions if you say Help for phone.

**Telephone voice commands**

| Voice command                            | Colloquial example                                      | Function  |
|--|---|---|
| Call <telephone number>                  | I would like you to dial 0171xxxxxx                     | Makes a telephone call by entering the telephone number directly.         |
| Call <contact>                           | Call Jane Smith on her mobile                           | Makes a telephone call directly by entering a name from the address book. |
| Call Mercedes-Benz emergency call center | Could you call the Mercedes-Benz emergency center?      | Triggers an emergency call to the Mercedes-Benz emergency call center.    |
| Call Mercedes me                         | I'd like you to call the MB breakdown assistance please | Places a call with Mercedes-Benz breakdown assistance.                    |
| Latest calls                             | Show me the list of missed calls                        | Shows the list of missed calls.   |
| Previous calls                           | Show me the last calls                                  | The list shows all outgoing, incoming and missed calls.                   |
| Incoming calls                           | Show me the calls received                              | Shows the list of incoming calls.   |
| Outgoing calls                           | Show me the list of outgoing calls                      | Shows the list of outgoing calls.   |
| Search for <contact>                     | Could you open the contact "John Doe"?                  | Opens the contact data of a contact in the address book.                  |

| Voice command | Colloquial example                           | Function  |
|---------------|--|---|
| Redial        | Redial/Call last phone number                | Makes a call to the last telephone number dialed. |
| Change phone  | Could you please switch to the second phone? | Changes the primary telephone                     |

### Overview of radio voice commands

Radio voice commands can also be used when the radio application runs in the background and

another application is visible in the foreground. The following list offers just a small selection of the possible radio voice commands. You will

receive additional suggestions if you say Help for radio.

### Radio voice commands

| Voice command          | Colloquial example   | Function  |
|------------------------|--|---|
| Station <station name> | I would like to select station "Cool FM"                           | To select the radio station mentioned             |
| Frequency <frequency>  | Go to station/radio frequency "eighty seven point five megahertz". | To enter a radio frequency, e.g. for the FM range |
| Next radio station     | Call up the next radio station                                     | The next radio station in a list is called up     |
| Previous station       | Switch to the last station/to the previous program                 | To switch to the previous station                 |

| Voice command               | Colloquial example   | Function  |
|-----------------------------|--|---|
| Save radio station          | Save the radio station, please                             | To save a station name for a radio station          |
| Show station list           | Please show me the list of all stations                    | To show the list of stations that can be received   |
| Read out radio station list | I'd like to listen to the station/<br>program list, please | To listen to the names of all receivable stations   |
| Traffic information on      | Switch on the traffic info                                 | To switch on traffic announcements                  |
| Traffic information off     | I'd like to switch off traffic info                        | To switch off traffic announcements                 |
| Radio info on               | I want you to turn on additional<br>radio station text     | To switch on information about the current station  |
| Radio info off              | I want you to turn off additional<br>radio station text    | To switch off information about the current station |

### Overview of media player voice commands

Media player voice commands can also be used when the media player application runs in the

background and another application is visible in the foreground. The following list offers just a small selection of the possible media player

voice commands. You will receive additional suggestions if you say Help for media or Help for player.

**Media player voice commands**

| <b>Voice command</b>                               | <b>Colloquial example</b>                            | <b>Function</b>  |
|--|--|--|
| Play <track/albums/artists/composers/music genres> | Play "Yellow Submarine"                              | The names of all available tracks, albums, artists, composers or genres are accepted during the search. In the case of a clear search result the track found is played back immediately.                               |
| Play track <track>                                 | Play song "So What"                                  | The available tracks are played back.  |
| Play album <album>                                 | Play album "A Night at the Opera"                    | The available albums are played back.  |
| Play artist <artist>                               | I want to listen to the artist "Madonna"             | The available artists are played back.   |
| Play composer <composer>                           | I'd like to hear the composer "Ludwig van Beethoven" | The available composers are played back.   |
| Play music genre <music genre>                     | I'd like to hear the music genre "Bebop"             | The available music genres are played back.  |
| Search for track <track>                           | I would like to search for the song "Sailing"        | The names of all available tracks are accepted during the search. A selection list appears from which you can select the desired music. If you wish to play all the tracks in a selection list, say "Play all tracks". |
| Search for album <album>                           | Search for album "A Night at the Opera"              | The names of all available albums are accepted during the search. A selection list appears from which you can select the desired music. If you wish to play all the tracks in a selection list, say "Play all tracks". |



| Voice command                        | Colloquial example                                 | Function   |
|--------------------------------------|--|--|
| Search for artist <artist>           | I would like to search for the artist "Elton John" | The names of all available artists are accepted during the search. A selection list appears from which you can select the desired music. If you wish to play all the tracks in a selection list, say "Play all tracks".      |
| Search for composer <composer>       | Search for composer "Beethoven"                    | The names of all available composers are accepted during the search. A selection list appears from which you can select the desired music. If you wish to play all the tracks in a selection list, say "Play all tracks".    |
| Search for music genre <music genre> | Search for music genre "Classical"                 | The names of all available music genres are accepted during the search. A selection list appears from which you can select the desired music. If you wish to play all the tracks in a selection list, say "Play all tracks". |
| Next track                           | Start the next song/video clip/film                | Plays back the next track.   |
| Previous track                       | Play the last song/track/clip again                | Plays back the previous track.   |
| Repeat this track                    | I'd like to listen to this track again             | The current track is played back from the beginning.   |
| Play similar music                   | I'd like to hear similar music                     | Plays back similar tracks.   |
| Play random music                    | Play me a random track                             | Plays back random tracks.  |
| Random playback on                   | Turn random playback on                            | Switches to random mode.   |

| Voice command           | Colloquial example                | Function   |
|-------------------------|-----------------------------------|--|
| Random track list off   | Switch off shuffle mode           | Switches off random mode.  |
| What am I listening to? | Which music is currently playing? | The information about the track currently playing is read aloud. |

### Overview of message voice commands

Messages can be created, edited and listened to using the message voice commands. The follow-

ing list offers just a small selection of the possible message commands. You will receive additional suggestions if you say Help for messaging.

### Message voice commands

| Voice command                              | Colloquial example  | Function   |
|--|---|--|
| Text message to <Name>                     | I would like to write a new text to "John Doe's mobile number"                                  | Creates a text message. All address book names are available.  |
| Text message to <Name> <Text>              | I would like you to write a new text to "Jane Doe" with the following text: "I am running late" | Writes a text message to the person mentioned. The content of the text can be spoken immediately if online voice control has been activated. |
| Read out new text messages                 | I would like you to read out the new text messages  | Reads out new text messages.   |
| Read out the last text message from <Name> | I would like you to read out the last text message from "John Doe"                              | Reads out the last text message from the person mentioned.   |

### Overview of vehicle voice commands

You can use the vehicle voice commands to directly call up the corresponding menus for the vehicle settings and operate vehicle functions.

The following list offers just a small selection of the possible vehicle voice commands. You will receive additional suggestions if you say Help for vehicle settings or Help for vehicle functions.

- i If no seat or side is mentioned for commands that relate to a seat or side of vehicle

then all actions are carried out automatically for the driver's seat.

### Vehicle voice commands

| Voice command                       | Colloquial example  | Function  |
|-------------------------------------|---|---|
| Temperature colder                  | I would like to reduce the temperature  | Lowers the temperature of the air conditioning system.                          |
| Air recirculation on                | I would like to activate the air circulation                                  | Switches on air recirculation mode for the air conditioning system.             |
| Automatic climate control driver on | I would like to switch on the automatic climate control for the driver's seat | Switches on automatic climate control for the driver's or front passenger side. |
| Ambient light blue                  | I would like to set the interior lighting to blue                             | Switches the ambiance light, e.g. to blue.                                      |
| Wave massage driver on              | I would like to switch on the wave massage for the driver's seat              | Switches on the wave massage for the driver's or front passenger seat.          |

| Voice command                        | Colloquial example   | Function  |
|--------------------------------------|--|---|
| Massage driver's seat off            | Switch the driver's side massage off                             | Switches off the massage function for the driver's or front passenger seat. |
| Seat heating driver on               | I would like to switch on the seat heating for the driver's seat | Switches on the seat heating for the driver's or front passenger seat.      |
| Seat heating front passenger level 2 | Seat heating front-passenger on level 2                          | Sets the seat heating for the driver's or front passenger seat to level 2.  |
| Current speed limit                  | I would like to hear the speed limit                             | Calls up the current speed limit.   |
| Outside temperature                  | I would like to find out what the temperature outside is like    | Calls up the outside temperature.   |
| Average consumption                  | What is the current average consumption?                         | Calls up average consumption.   |
| Vehicle data                         | Can you please display the vehicle data menu?                    | Calls up the vehicle data.  |
| Range                                | Tell me the current range  | Calls up the current range data.  |
| Assistance menu                      | Show me the driver assistance settings                           | Displays the assistance settings.   |

| Voice command        | Colloquial example                              | Function                               |
|----------------------|---|--|
| Climate control menu | I would like to see the climate control menu    | Displays the climate control settings. |
| Light menu           | I would like to change the light settings       | Displays the light settings.           |
| Seats menu           | I would like to switch to seat menu             | Displays the seat adjustment settings. |
| Massage menu         | I would like to switch to the massage seat menu | Displays the massage settings.         |
| Next service         | Tell me my next service appointment             | Calls up the next service due date.    |

## Overview and operation

### Overview of the MBUX multimedia system

**⚠ WARNING** Risk of distraction from information systems and communications equipment

If you operate information and communication equipment integrated in the vehicle when driving, you will be distracted from the traffic situation. This could also cause you to lose control of the vehicle.

- ▶ Only operate this equipment when the traffic situation permits.
- ▶ If you cannot be sure of this, stop the vehicle whilst paying attention to road and traffic conditions and operate the equipment with the vehicle stationary.

You must observe the legal requirements for the country in which you are currently driving when operating the multimedia system.

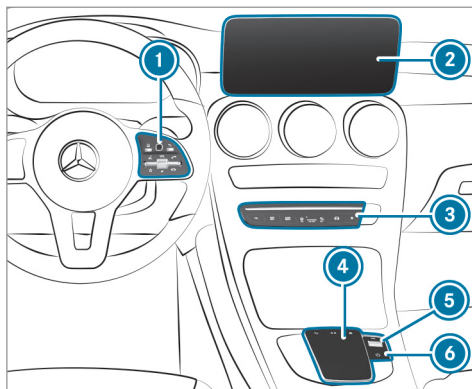

- ① Touch Control and control panel for the MBUX multimedia system  
MBUX stands for Mercedes-Benz User Experience.
  - Operating Touch Control (→ page 287)
- ② Media display with touch functionality
  - Home screen overview (→ page 286)
  - Operating the touchscreen (→ page 288)

- ③ Control panel for telephone, navigation, radio/media, vehicle functions/system settings and favorites/themes
  - Calling up applications (→ page 296)
- ④ Touchpad
  - Operating the touchpad (→ page 289)
- ⑤ Control knob
  - Turn: adjusts the volume
  - Press: switches sound on or off
- ⑥  button
  - Switches the MBUX multimedia system or media display on or off



You can operate the MBUX multimedia system with the following central control elements:

- Touch Control ①
  - Touchpad ④
  - Media display (touchscreen) ②
- ⓘ Alternatively, you can conduct a dialog with the Voice Control System (→ page 266).



- ① If the vehicle is equipped with gesture mode, selected functions of the multimedia system can be operated contact-free as well as turning the reading light on or off (→ page 291).

Numerous application, online services, services and apps are available for you. These can be called up via the home screen or using buttons



You can conveniently call up and add favorites on the steering wheel using the  rocker switch or using the  button on control panel

- ③ Quick-access in the home screen and in the applications serve to select functions more quickly.

If you use the learn function of the multimedia system, you will receive suggestions during operation of the most probable navigation destinations, media sources, radio stations and contacts. The configuration of the suggestions takes place in your profile. You can compile your profile from various vehicle settings and settings of the multimedia system. You can create themes for various driving situations in the home screen as well as using the  rocker switch or the  button.

The Notifications Center collects incoming notifications, e.g. about an available software update. Depending on the type of notification it offers various actions. You can call up the Notifications Center on the home screen and in the application menus.

With the global search in the vehicle you can search on-board across many categories as well as online in the Internet. You can use the global search in the home screen and in the notifications.

#### Protection against theft

This device is equipped with technical provisions to protect it against theft. Further information on protection against theft can be obtained from an authorized Mercedes-Benz Center.

#### Notes on the media display

Observe the notes on caring for the interior (→ page 435).

**Automatic temperature-controlled switch-off feature:** if the temperature is too high, the brightness is initially reduced automatically. The

media display may then switch off completely for a while.

- ① If you are wearing polarized sunglasses, it may be difficult to read the multimedia system display.

## Home screen overview

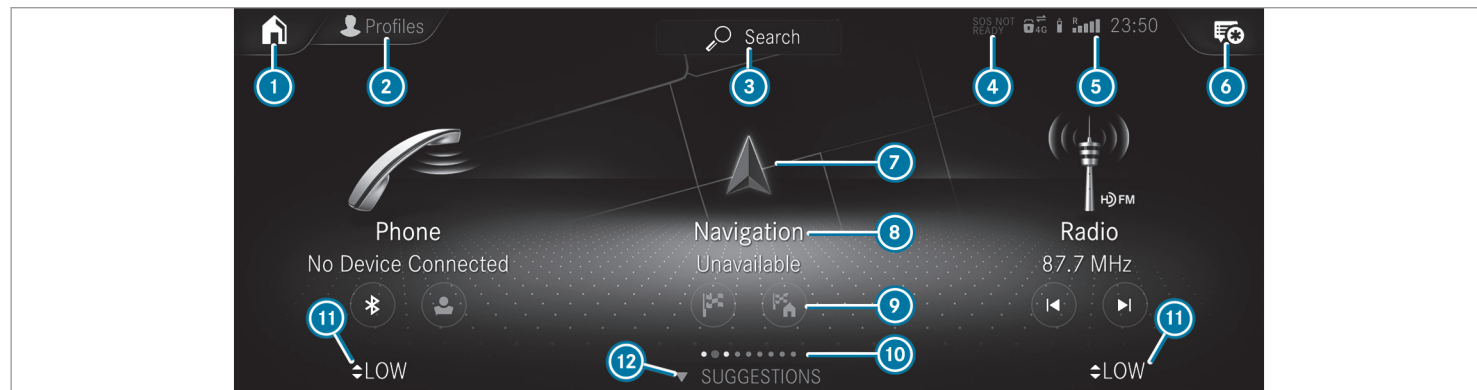

- ① On the home screen: displays the first three applications  
In other displays: calls up the home screen
- ② Calls up the profile
- ③ Calls up the global search
- ④ SOS NOT READY display only when the Mercedes-Benz emergency call system is not available
- ⑤ Displays, for example network display, battery status of the mobile phone connected, signal strength of the mobile phone network, time
- ⑥ Calls up the Notifications Center  
The star indicates new notifications.
- ⑦ Calls up an application using the symbol
- ⑧ Name of the application, beneath the current selection or information
- ⑨ Quick-access (in the example: calls up destination entry, enters the destination address for home)
- ⑩ Number of applications and currently selected display area



- ⑪ Calls up the air conditioning menu (→ page 146)
- ⑫ Calls up **SUGGESTIONS**, **THEMES** and **FAVORITES**

### Central control elements overview

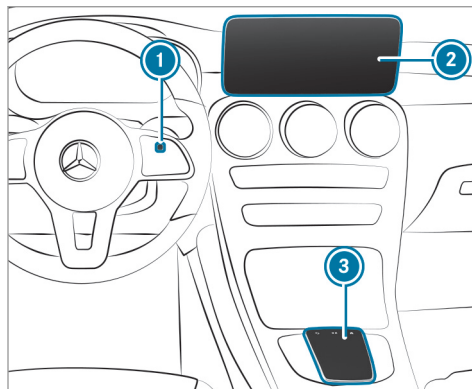



- ① Touch Control
- ② Media display with touch functionality
- ③ Touchpad

### Touch Control

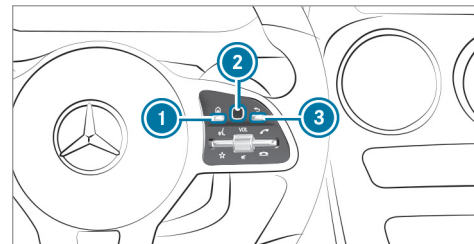
#### Operating Touch Control (MBUX multimedia system)



- ①  button  
Shows the home screen and calls up applications  
Calls up suggestions, themes and favorites: when the home screen is shown, swipe down on Touch Control ②.
- ② Touch Control
- ③  button  
Pressing briefly: returns to the previous display

You can navigate in menus and lists via the touch-sensitive surface of Touch Control  by using a **single-finger swipe**.

- ▶ **To select the menu item or entry:** swipe up, down, left or right.
- ▶ Press Touch Control .
- ▶ **To enter a character:** enter a character using the keyboard.
- ▶ **To move the digital map:** swipe in any direction.

**Setting the sensitivity for the Touch Control Multimedia system:**

- ▶  ▶ Settings ▶ System
- ▶ Controls ▶ Touch Control Sensitivity
- ▶ Select **Fast**, **Medium** or **Slow**.

**Setting acoustic operating feedback for the Touch Control**

Multimedia system:

- ▶  ▶ Settings ▶ System
- ▶ Controls

The function is supported by the selection in a list.

- ▶ Select **Acoustic Operating Feedback**.
- ▶ Set **Normal**, **Loud** or **Off**.  
If the function is activated you will hear a clicking sound when scrolling in a list. When the beginning or end of the list is reached you will hear another clicking sound.

## Touchscreen

### Operating the touchscreen

#### Tapping

- ▶ **To select a menu item or entry:** tap on a symbol or an entry.
- ▶ **To increase the map scale:** tap twice quickly with one finger.
- ▶ **To reduce the map scale:** tap with two fingers.
- ▶ **To enter characters with the keypad:** tap on a button.

#### Single-finger swipe

- ▶ **To navigate in menus:** swipe up, down, left or right.

- ▶ **To move the digital map:** swipe in any direction.
- ▶ **To use handwriting to enter characters:** write the character with one finger on the touchscreen.

#### Two-finger swipe

- ▶ **To zoom in and out of the map:** move two fingers together or apart.
- ▶ **To enlarge or reduce the size of a section of a website:** move two fingers together or apart.
- ▶ **To turn the map:** turn counter-clockwise or clockwise using two fingers.

#### Touching, holding and moving

- ▶ **To move the map:** touch the touchscreen and move your finger in any direction.
- ▶ **To set the volume on a scale:** touch the touchscreen and move the finger to the left or right.

## Touching and holding

- ▶ **To save the destination in the map:** touch the touchscreen and hold until a message is shown.
- ▶ **To call up a global menu in the applications:** touch the touchscreen and hold until the **OPTIONS** menu appears.

## Setting acoustic operation feedback for the touchscreen

Multimedia system:

- ▶  ▶ Settings ▶ System
- ▶ Controls



The function is supported by the selection in a list.

- ▶ Select **Acoustic Operating Feedback**.
- ▶ Set **Normal**, **Loud** or **Off**.  
If the function is activated you will hear a clicking sound when scrolling in a list. When the beginning or end of the list is reached you will hear another clicking sound.

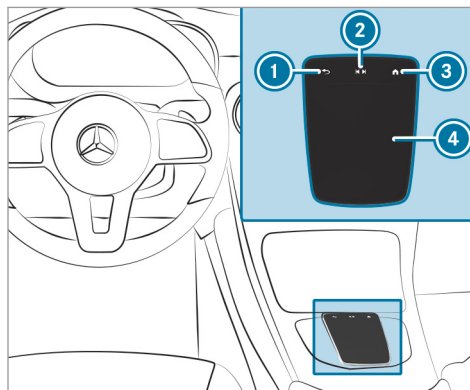

## Touchpad

### Operating the touchpad



- ①  button  
Pressing briefly: returns to the previous display
- ②  button  
Pressing: calls up the control menu of the last active audio source

Swiping to the left or right across :  
selects the previous or next radio station/  
music track

- ③  button  
Pressing: shows the home screen and calls up applications
- ④ Touchpad
- ④  Calls up suggestions, themes and favorites: when the home screen is shown, swipe down on touchpad ④.

You can navigate in menus and lists via the touch-sensitive surface of touchpad ④ by using **a single-finger swipe**.

- ▶ **To select the menu item or entry:** swipe up, down, left or right.
  - ▶ Press touchpad ④.
  - ▶ **To enter a character:** enter a character using the keyboard.
- or
- ▶ Write a character on the touchpad.
  - ▶ **To move the digital map:** swipe in any direction.

### Use the following functions with a two-finger swipe:

- ▶ **To call up the Notifications Center:** swipe down with two fingers.
- ▶ **To close the Notifications Center:** swipe up with two fingers.
- ▶ **To call up the control menu of the last active audio source:** swipe up with two fingers.
- ▶ **To zoom in and out of the map:** move two fingers together or apart.
- ▶ **To enlarge or reduce the size of a section of a website:** move two fingers together or apart.

### Setting the sensitivity for the touchpad

Multimedia system:

- ▶  ▶ Settings ▶ System
- ▶▶ Controls ▶ Touchpad Sensitivity
- ▶ Select **Fast**, **Medium** or **Slow**.

- ▶ **To set the pressure sensitivity:** switch **Touchpad Tap** on or off.  
If the function is switched on, a tap on the touchpad is enough to select a menu item.

### Switching the read-aloud function for handwriting recognition on/off

**Requirements:**

- The multimedia system is equipped with a voice control system.
- The read-aloud function is available for the selected system language.

Multimedia system:

- ▶  ▶ Settings ▶ System ▶ Audio
- ▶ Switch **Read Out Handwriting Recognition** on or off.  
If the function is activated, characters are read aloud as they are written on the touchpad.

### Activating/deactivating haptic operating feedback for the touchpad

Multimedia system:

- ▶  ▶ Settings ▶ System
- ▶▶ Controls

The function supports you when making entries on the touchpad and when selecting menus.

- ▶ Switch **Haptic Operating Feedback** on or off.  
When the function is activated, a tactile feedback in the form of a vibration is effected when the touchpad is operated.

### Setting acoustic operating feedback for the touchpad

Multimedia system:

- ▶  ▶ Settings ▶ System
- ▶▶ Controls

The function is supported by the selection in a list.

- ▶ Select **Acoustic Operating Feedback**.
- ▶ Set **Normal**, **Loud** or **Off**.  
If the function is activated you will hear a clicking sound when scrolling in a list. When

the beginning or end of the list is reached you will hear another clicking sound.

### Selecting a station and track using the touchpad

- ▶ Swipe to the left or right over the  button.
  - Radio: the previous or next station is set.
  - Media source: the previous or next track is selected.

or

- ▶ **To show the control menu:** press the  button on the touchpad.

or

- ▶ Swipe upwards using two fingers on the touchpad.
  - The control menu appears for the audio source that was last selected.
- ▶ Swipe left or right using one finger.
  - Radio: the previous or next station is set.
  - Media source: the previous or next track is selected.
- ▶ **To hide the control menu:** swipe down on the touchpad using two fingers.

## MBUX Interior Assistant

### Notes on lasers and laser classification

**⚠ WARNING** Risk of injury from laser radiation from the camera

This product uses a laser system. If the housing is opened or damaged, invisible laser beams can escape in an uncontrolled manner.

Laser radiation can damage your retina.

- ▶ Do not open the housing.
- ▶ Always have maintenance work and repairs carried out by a qualified specialist workshop.

This product complies with the requirements of the FDA 21 CFR 1040.10 and 1040.11 with exception of the variations according to the FDA Laser Notice No. 50 from 24. June 2007.

**⚠ WARNING** Risk of distraction from information systems and communications equipment

If you operate information and communication equipment integrated in the vehicle when driving, you will be distracted from the traffic situation. This could also cause you to lose control of the vehicle.

- ▶ Only operate this equipment when the traffic situation permits.
- ▶ If you cannot be sure of this, stop the vehicle whilst paying attention to road and traffic conditions and operate the equipment with the vehicle stationary.

You must observe the legal requirements for the country in which you are currently driving when operating the multimedia system.

### Overview of the MBUX Interior Assistant

If the vehicle is equipped with the MBUX Interior Assistant, selected functions of the multimedia system can be operated contact-free. In addition, the reading light or search light can be switched on or off contact-free.

The MBUX Interior Assistant can differentiate between driver and front passenger interactions.

The MBUX Interior Assistant recognizes certain hand positions (poses).

### The MBUX Interior Assistant supports the following interactions:

| Interaction area                                  | Interaction  | Description  |
|---|--|--|
| In front of the media display/above the touch-pad | Proximity to the control element                       | The MBUX Interior Assistant recognizes the approach of the hand towards a control element.<br>Depending on the active application, the display will be adjusted in the media display. Some functions differentiate between driver and front passenger.<br>No specific hand position is required. |
| Above the center console                          | Defined poses  | With defined poses a function is triggered depending on the application active.  |
| Below the inside rearview mirror                  | Brief up and down movements                            | With brief vertical up and down movements below the inside rearview mirror the reading light for the driver or the front passenger is switched on and off.   |
| Front passenger seat                              | Stretching out the hand above the front passenger seat | By stretching out the hand above the front passenger seat the search light is switched on. If the hand is withdrawn from this area, the search light is switched off again.  |

### Operating functions by proximity of the hand to the touchscreen and touchpad

#### Requirements:

- One of the following applications appears in the media display:
  - Seat settings with displays for the driver and front passenger seat, e.g. [Seat Comfort](#)
  - Home screen
  - Radio menu or media menu
  - Map in the navigation
  - Active Parking Assist
- Recognition occurs as the hand approaches to approximately 4 in (10 cm) from the touchpad or the touchscreen.

#### Seat adjustments by the driver or front passenger

In the seat settings menu, the MBUX Interior Assistant detects proximity to various control elements of the multimedia system. In addition, the MBUX Interior Assistant detects from which seat the action emanates.

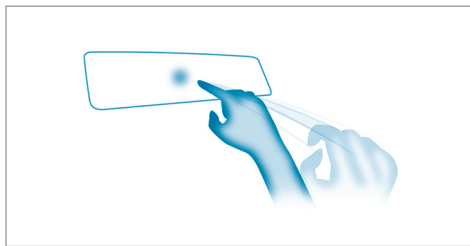

Hand approaching the touchscreen



Hand approaching the touchpad

▶ With the seat setting display active, move the hand towards the touchscreen or touchpad. The seat of the person operating, driver's seat or front passenger seat, is enlarged in the media display.

The appropriate control elements are pre-selected automatically.

▶ Depending on the function, the person operating can either switch the function on or off directly or make other settings.

#### Highlighting an application on the home screen

The MBUX Interior Assistant detects in which area the hand is in front of the touchscreen. The display of objects shown is adjusted to improve orientation.

▶ Move a hand towards the touchscreen. The symbol for the application is enlarged. The quick-access applications will be highlighted.

▶ Continue operation, e.g. select a quick-access application.

ⓘ Further information about the home screen (→ page 286).

### Activating cover change in the radio menu and media menu

The MBUX Interior Assistant reduces the number of operating steps.

- ▶ Move a hand towards the touchscreen or touchpad.  
The current information, e.g. about the radio station, track and artist are hidden. Cover change is activated.
- ▶ Continue operation and select a cover.
- ▶ As the hand is moved away from the touchscreen or touchpad, the current information is shown again.
- ❶ Further information on the radio menu (→ page 409) and the media menu (→ page 404).

### Showing the navigation menu on the map

The MBUX Interior Assistant shows the navigation menu.

- ▶ Move a hand towards the touchscreen or touchpad.  
The navigation menu is shown.
- ▶ Continue operation and select a symbol.

- ▶ As the hand is moved away from the touchscreen or touchpad, the media display hides the navigation menu.

❶ Further information on the navigation menu (→ page 326).

### Showing operating symbols in the Active Parking Assist camera image (only from driver's seat)

The MBUX Interior Assistant facilitates quick-access for the driver to various camera views.

- ▶ With the Active Parking Assist display active, move the hand in the direction of the touchscreen.  
The camera operation symbols are displayed.
- ▶ Continue operation and display the desired front, rear, left and right camera views.
- ❶ Further information on Active Parking Assist functions (→ page 232).

### Operating a function with the favorites pose Requirements:

- **To call up favorites:** there is at least one favorite.

- The area for recognition of the favorite's pose is above the center console at the height of the climate control vents and the media display. The hand should have a distance of at least 4 in (10 cm) from the media display.
- The pose is held for a brief time.

### Calling up favorites

A pose calls up a favorite.

The driver and front passenger can connect two different favorites with the V pose.

- ❶ If a favorite has not yet been saved and connected with the MBUX Interior Assistant, the multimedia system will assist you.





Carrying out the V pose

- ▶ Position the hand above the center console and in the direction of the media display. The back of the hand is facing upwards. In doing so the index and middle finger are extended with the other fingers bent inwards. The favorite is called up.

**Switching the reading light for the driver and front passenger on/off using gesture mode**  
**Requirements:**

- The function is available when it is dark.
- The gesture is carried out in the interaction area (under the inside rearview mirror).

Briefly moving the hand up and down under the inside rearview mirror switches the reading light specifically for the driver or front passenger on or off.



Carrying out operation of the reading light

- ▶ Move the hand up and down vertically under the reading light. The reading light is switched on or off.

**Switching the search light for the driver on/off using gesture mode**  
**Requirements:**

- The front passenger seat is not occupied.
- The function is available when it is dark.

- The gesture is completed in the interaction area (front-passenger seat).

Stretching out with the hand over the front passenger seat when unoccupied switches a search light on for the driver when it is dark. Pulling the hand back switches the search light off again.

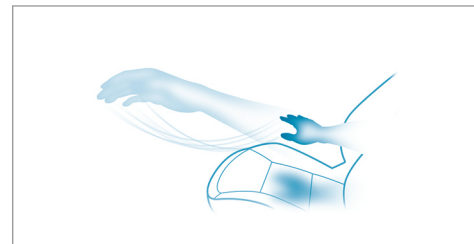

Interaction area for operating the search light

- ▶ **To switch on:** reach across the front passenger seat with your hand. The search light is switched on for the driver.

- ▶ **To switch off:** take your hand back away from the front passenger seat. The search light is switched off again.

### Settings for the MBUX Interior Assistant

Multimedia system:

→  ▶ Settings ▶ System





▶ Interior Assistant

- ▶ **To switch on full functionality of the MBUX Interior Assistant:** select **On**. The option is activated ●.
- ▶ **To activate additional functions for reading and search lights:** select **Including Reading Light**.  
When the option is switched on, the display button is activated.  
  
The functions for the reading and search lights are activated in addition to the proximity functions.
- ▶ **To switch off the MBUX Interior Assistant:** select **Off**.  
The option is activated ●.

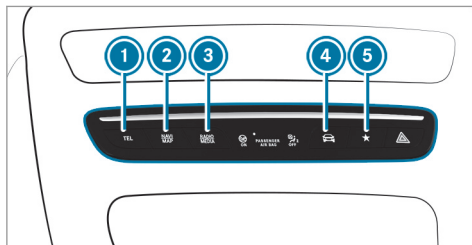
## Main functions

### Calling up applications



- 1  **TEL** button calls up the telephone
- 2  **NAVI MAP** button calls up navigation
- 3  **RADIO MEDIA** button calls up radio or media
- 4  button calls up vehicle functions
- 5  button

Press briefly: calls up favorites  
(→ page 304)

Press and hold: adds a favorite  
(→ page 304) or creates a new theme  
(→ page 300)

**Alternatively in the home screen:** when you start the vehicle the home screen is shown in the media display.

- ▶ Select the application by swiping and tapping.



or

- ▶ **In any display:** press the  button on the Touch Control or on the touchpad.

or

- ▶ Tap on the  symbol on the touchscreen. The applications are displayed.
- ▶ Select the application by swiping and tapping.

### Changing the arrangement of applications on the home screen

- ▶ Call up the home screen.
- ▶ Touch and hold an application on the touchscreen until symbols appear.
- ▶ Tap on  or  and move the application in the menu.
- ▶ Tap on .

## Profile

### Notes on profiles

The driver's seat is equipped with an anti-entrapment feature.

If the driver's door is open, the driver's seat will **not** be set after calling up the driver's profile.

### Overview of profiles

Using the multimedia system up to seven profiles can be created in the vehicle.

Profiles store your personal vehicle settings and settings for the multimedia system.

If the vehicle is used by several drivers, the driver can select their profile before the journey, without changing the settings of other drivers.

You can select the profile:

- When entering (→ page 299)
- Using the home screen (→ page 286)

The profile settings are activated as soon as a profile is selected.

**i** If you call up your profile when driving then the driver's seat position will not be adjusted.

You can cancel the setting process with the following actions:

- Tap on the **Positioning Seat and Steering Wheel... Please tap to cancel.** warning on the media display.
- Press one of the seat operating buttons in the driver's door.

### Profile content

Depending on the vehicle equipment, the following settings can be stored in your profile, for example:

- Driver's seat memory
- Radio (including station list)
- Last destinations
- Climate control
- Ambient lighting
- DYNAMIC SELECT I (individual)
- Instrument Display, Head-up Display and style (display style of the multimedia system)
- Themes, suggestions and favorites

**i** Settings for driver assistance systems cannot be saved in the profile.

### Mercedes me connect profile

If you use a profile from Mercedes me connect, the following online functions are available, for example:

- You can configure the settings in the vehicle using the Mercedes me app and the Mercedes me portal.
- You can synchronize your profile on Mercedes me connect with the profile in the vehicle (→ page 299).
- You can add a personal profile photo that is shown in the vehicle.
- You can take your profile and some of your settings with you in new vehicles.

### Requirements for using Mercedes me connect profiles:

For the vehicle owner:

- You have a Mercedes me user account.
- The vehicle has been connected with the user account.

- The personalization service is activated.



For additional users of the vehicle:

- You have a Mercedes me user account.
- The vehicle owner has invited you to connect your user account on Mercedes me with that of his vehicle.
- You have accepted the invitation.

### Creating a new profile

Multimedia system:

   Profiles

- ▶ Select  **Create Profile**.
  - ▶ Select an avatar.
  - ▶ Enter the name and confirm with .
  - ▶ Select **Continue** .
  - ▶ **To save the current settings in a profile:** select **Current Settings**.
  - ▶ Select **Save**.
- or
- ▶ **To adopt the factory settings:** select **Factory Settings**.

- ▶ Select **Save**.

 Further information on setting a user profile (→ page 298).

- ▶ Activate Bluetooth® and select **Connect Phone**, to connect a mobile phone with the user profile (→ page 369).

You can also set up a user profile without registering a mobile phone.

- ▶ Select **Finish**.  
The user profile is saved.

### Selecting profile options

Multimedia system:

   Profiles

- ▶ Select  for a profile.
- ▶ **To edit a profile:** select **Edit Profile**.
- ▶ Select an avatar.
- ▶ Change the name, if necessary.
- ▶ Select **Save**.
- ▶ **To configure suggestions:** select **Suggestion Settings** (→ page 303).

- ▶ **To reset favorites or themes:** select **Reset Favorite to Factory Settings** or **Reset Themes to Factory Settings**.

- ▶ Select **Yes**.

- ▶ **To reset a profile:** select **Reset Profile to Factory Settings**.

- ▶ Select **Yes**.

- ▶ **To delete a profile:** select **Delete Profile**.

- ▶ Select **Yes**.

 The guest profile cannot be deleted.

### Protecting profile content

To protect your profile content and settings you can create a PIN in the Mercedes me portal for your profile. When PIN protection is active, you have to enter the PIN to select your profile.

- ▶ Select **Protect Content**.

- ▶ Select **Mercedes me Portal**.  
The browser opens and you are transferred to the Mercedes me portal.

## Selecting a profile

Multimedia system:



- ① You can cancel the setting process with the following actions:
  - Tap on the [Positioning Seat and Steering Wheel... Please tap to cancel.](#) warning on the media display.
  - Press one of the seat operating buttons in the driver's door.

- ▶ Select a profile.
- ▶ Press the  button to confirm the message.  
The profile is loaded and activated.

- ① Alternatively, the profile can already be selected when the vehicle is entered (→ page 299).

## Synchronizing a profile Requirements:

- You have a Mercedes me user account.
- The vehicle is connected with your Mercedes me user account.

- The personalization service is activated on Mercedes me connect.

Multimedia system:



Synchronization enables the following:

- You can configure the vehicle settings using the Mercedes me app.
- The profile on Mercedes me connect and the profile in the vehicle are aligned (profile management).

- ▶ Activate [Synchronize Profiles Automatically.](#)  
The profiles in the vehicle are automatically synchronized with the profiles on Mercedes me connect when the ignition is switched on and off.

or

- ▶ Select [Synchronize Profiles Now.](#)  
After selecting this option, the profiles in the vehicle are synchronized with the profiles on Mercedes me connect.

- ① During synchronization the profile list and the profile functions are blocked.

- ① **Note on data protection:** if you do not wish to share your data with Mercedes me, make sure that the automatic synchronization is switched off and do not select [Synchronize Profiles Now.](#)

## Showing the profile selection when entering Requirements:

- At least one profile has been created.

Multimedia system:



If the option is activated, you can see a profile as soon as you get in.

- ▶ Select [General Settings.](#)
- ▶ Activate [Show Profile Selection When Getting In.](#)  
When the vehicle is started, the media display shows the active profile.

## Themes

### Overview of themes

You can configure the vehicle settings according to your preferences and save as a theme. A theme can be called up any time via the home screen. There is then no need to make the desired settings again.

There are pre-defined themes available, e.g. Journey, Efficiency and Lounge.

### Example for the use of themes

For recurring driving situations, such as long drives on the freeway, you can save your preferred settings in a theme in the vehicle.

You can save the following settings in a theme, for example:

- Displays (e.g. navigation map or tachometer)
- Preferred radio station
- Favored drive program

These settings are saved under the name you wish when setting up a theme (→ page 300). On the next freeway journey you can select this theme and thereby restore your settings.

### Content of a theme

Depending on vehicle equipment the following settings can be saved in a theme:

- Setting of the Instrument Display (→ page 252)
- Setting of the Head-up Display (→ page 263)
- Setting of the ambient lighting (→ page 135)
- Active audio source, e.g. radio or USB
- Starting screen for the media display
- Visual style (→ page 317)
- DYNAMIC SELECT drive program (→ page 166)
- Eco start/stop setting (→ page 164)
- Navigation system settings

 A theme contains the currently active settings in the vehicle.

### Calling up themes

Multimedia system:



- ▶ When the home screen is shown, swipe up until **THEMES** appears.

- ▶ Select a theme.



### Creating new themes



#### Requirements:

- The settings which are to be saved in the theme are active.  
The overview shows the settings which can be saved in a theme (→ page 300).



Multimedia system:





- ▶ Select  **Create Theme**.  
The settings which are saved in the theme are shown.
- ▶ Select **Continue** .
- ▶ Select additional settings which are to be saved in the theme.
  - Select **Audio**, to save the active audio settings in the theme.
  - Select **Navigation** (Navigation), to save the active navigation settings in the theme.
- ▶ Select **Continue** .





- ▶ Select an entry screen.
- ▶ Select **Continue** .
- ▶ Select an image.
- ▶ Enter the names into the entry field and confirm with .
- ▶ **To save a theme:** select **Save**.



#### When the maximum number that can be saved is reached:

- ▶ Select  from the prompt.
- ▶ Select a theme that should be overwritten. The settings which are saved in the theme are shown.
- ▶ Select **Continue** .
- ▶ Select additional settings which are to be saved in the theme.
  - Select **Audio**, to save the active audio settings in the theme.
  - Select **Navigation** (Navigation), to save the active navigation settings in the theme.
- ▶ Select **Continue** .

- ▶ Select an entry screen.
- ▶ Select **Continue** .
- ▶ Select an image.
- ▶ Enter the names into the entry field and confirm with .
- ▶ **To save a theme:** select **Save**.

#### Creating using the rocker switch or button

- ▶ Press and hold the bottom section of the  rocker switch on the steering wheel.
- or
- ▶ Press and hold the  button next to the touchpad.
- ▶ Select  **Create Theme**. The settings which are saved in the theme are shown.
- ▶ Select **Continue** .
- ▶ Select additional settings which are to be saved in the theme.
  - Select **Audio**, to save the active audio settings in the theme.

- Select **Navigation** (Navigation), to save the active navigation settings in the theme.
- ▶ Select **Continue** .
- ▶ Select an image.
- ▶ Enter the names into the entry field and confirm with .
- ▶ **To save a theme:** select **Save**.

#### Modifying themes

Multimedia system:

- ▶ 
- ▶ When the home screen is shown, swipe up until **THEMES** appears.
- ▶ Press on a theme until the **OPTIONS** menu is shown.
- ▶ Select **Rename**.
- ▶ Enter the name.
- ▶ Select **Save** ✓.

### Moving themes

Multimedia system:



- ▶ When the home screen is shown, swipe up until **THEMES** appears.
- ▶ Press on a theme until the **OPTIONS** menu is shown.
- ▶ Select **Move**.
- ▶ Tap on or .
- ▶ Tap on .

### Moving the themes menu in the home screen

- ▶ Select .
- ▶ Swipe upwards and select **Set New Order**.
- ▶ Select **Themes**.
- ▶ Tap on or .
- ▶ Tap on .

### Deleting themes

Multimedia system:



- ▶ When the home screen is shown, swipe up until **THEMES** appears.
- ▶ Press on a theme until the **OPTIONS** menu is shown.
- ▶ Select **Delete**.
- ▶ Select **Yes**.

### Suggestions

#### Suggestions overview

The vehicle can learn the habits of the driver. Based on previously used functions, the most likely navigation destinations, media sources, radio stations or contacts are offered under **SUGGESTIONS**.

Suggestions are shown when the following requirements are fulfilled:

- A profile has been created (→ page 298).
- A profile has been selected.
- You have accepted data recording.

- From the beginning of usage, the multimedia system must analyze the user habits. When sufficient data is collected then the suggestions are available.

If the requirements mentioned are not fulfilled, a preview with a description of the function appears in the **SUGGESTIONS** menu.

You can configure data recording (→ page 303) or delete the suggestions recorded (→ page 303).

#### Calling up suggestions

##### Requirements:

- A profile has been created and is selected (→ page 299).
- ▶ Tap on in the media display. The home screen is shown.
- ▶ Swipe up until the **SUGGESTIONS** menu is shown.
- ▶ Select a navigation destination, a media source, a radio station or a contact. If route guidance is already active, you cannot start a new route guidance or set an



intermediate destination for the existing route.

### Configuring suggestions

#### Requirements:

- **To protect settings using a PIN:** your profile is connected with Mercedes me and your Mercedes me account is PIN protected.

Multimedia system:



- ▶ Select  for a profile.
- ▶ Select **Suggestion Settings**.
- ▶ **To switch suggestions display on/off:** switch **Allow Destination Suggestions**, **Allow Music Suggestions** and **Allow Contact Suggestions** on or off.  
If an option is switched on, suggestions for navigation destinations, media sources, radio stations or contacts are shown.  
If the option is switched off, no suggestions are shown.

#### ▶ **To deactivate the learn function for one day:** activate **24h Learning Deact..**

For 24 hours no new actions will be trained and no data recorded for the active profile. Suggestions will continue to be shown. The remaining time is shown next to **24h Learning Deact..**

Before the time runs out, a message is shown that the multimedia system will continue the learn function shortly.

Example: if the option is switched on and a route to a new destination has been calculated, this destination would not be taken into account for the learn function.

#### ▶ **To reset the suggestion history:** select **Reset Suggestion History**.

 This process cannot be reversed.

▶ Select **Yes**.

#### ▶ **To protect settings with a PIN:** switch on **PIN Protection**.

If PIN protection is switched on, you must enter the Mercedes me PIN to set the suggestions. This PIN will be set in the Mercedes

me portal for the personalization service to protect your personal settings.

### Renaming suggestions

Only navigation destinations can be renamed.

- ▶ Tap on the  symbol in the media display. The home screen is shown.
- ▶ Swipe up until the **SUGGESTIONS** menu is shown.
- ▶ Highlight a navigation destination and press until the **OPTIONS** menu is shown.
- ▶ Select **Rename**.
- ▶ Enter the name.
- ▶ **To confirm the entry:** select **Yes**.

### Deleting a suggestion

- ▶ Tap on  in the media display. The home screen is shown.
- ▶ Swipe up until the **SUGGESTIONS** menu is shown.
- ▶ Highlight a suggestion and press until the **OPTIONS** menu is shown.

- ▶ Select **Delete**.  
The query as to whether the suggestion is deleted temporarily or permanently appears.
- ▶ **If the suggestion should be shown again at a later time:** select **Not Now**.
- ▶ **If the suggestion should not be shown again:** select **Never**.

## Favorites

### Overview of favorites

Favorites offer you quick access to frequently used applications. It is possible to create 20 favorites in total.



You can select favorites from categories or you add favorites directly from an application.

### Calling up favorites

#### In the media display



- ▶ Tap on .  
The home screen is shown.
- ▶ Swipe up until **FAVORITES** is shown.

#### On the steering wheel or the touchpad

- ▶ Press the  rocker switch on the steering wheel down.
- or
- ▶ Press the  button next to the touchpad.

### Adding favorites

#### Selecting favorites from categories

- ▶ Tap on  in the media display.  
The home screen is shown.
- ▶ Swipe up until **FAVORITES** is shown.
- ▶ Select  **Create Favorite**.  
The categories are displayed.
- ▶ Select the category.  
The favorites are displayed.
- ▶ Select a favorite.  
The favorite is stored at the next available position.
- ▶ **All positions in the favorites are taken:**  
confirm the message shown with **OK**.  
A list shows all the favorites.
- ▶ Select a favorite which should be overwritten.

#### Adding a favorite from an application

Examples of adding from an application are:



- Saving a contact.
  - Storing a radio station.
  - Adding a media source.
  - Saving a navigation destination.
  - Adding an ENERGIZING comfort program (if available).
- ▶ **To save a contact as a global favorite:**  
select a contact (→ page 374).  
The details are displayed.
  - ▶ Press on a telephone number until the **OPTIONS** menu is shown.
  - ▶ Select **Save as Favorite**.  
The contact is added as a favorite.
  - ▶ **To store a radio station as a global favorite:** set a radio station (→ page 410).
  - ▶ Press on the radio station until the **OPTIONS** menu is shown.
  - ▶ Select **Save as Favorite**.  
The radio station is added as a favorite.

### Renaming favorites



- ▶ Tap on  in the media display. The home screen is shown.
- ▶ Swipe up until **FAVORITES** is shown.
- ▶ Press on a favorite until the **OPTIONS** menu is shown.
- ▶ Select **Rename**.
- ▶ Enter the name.
- ▶ Select **OK**.

### Moving favorites

#### Moving favorites in the favorites menu

- ▶ Tap on  in the media display. The home screen is shown.
- ▶ Swipe up until **FAVORITES** is shown.
- ▶ Press on a favorite until the **OPTIONS** menu is shown.
- ▶ Select **Move**.
- ▶ Move the favorite to the new position.
- ▶ Tap on .

### Moving the favorites menu in the personalization

- ▶ Tap on  in the media display. The home screen is shown.
- ▶ Swipe up until **Set New Order** is shown.
- ▶ Select **Set New Order**.
- ▶ Move **Favorites** to the new position.
- ▶ Tap on .

### Deleting favorites

- ▶ Tap on  in the media display. The home screen is shown.
- ▶ Swipe up until **FAVORITES** is shown.
- ▶ Press on a favorite until the **OPTIONS** menu is shown.
- ▶ Select **Delete**.
- ▶ Select **Yes**.

## Notifications Center

### Overview of the Notifications Center

The following communications are collected in the Notifications Center:

- Communications which are generated by the vehicle or from multimedia system.
- Communications which are received through the use of services.

The following notification types are available for you:

- Navigable destinations and routes
- Messages (text messages)
- System information, e.g. **Important Software Update Available**
- Other notifications, e.g. from additional online services that can be subscribed to

The  Notifications Center can be found on the home screen, in menus and at the top right of the navigation map (→ page 286).

A star in the  symbol informs you of new notifications.

Notifications are normally briefly shown as they are received. This occurs for nearly every application that you are currently using. If you take no action, these are stored for future access in the Notifications Center.

The notifications are sorted chronologically. The most recent notifications are at the top.

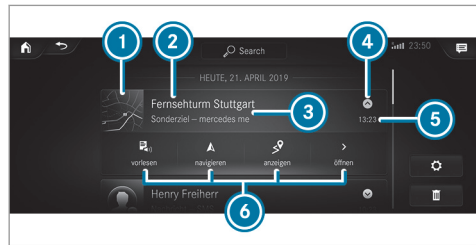

A notification shows the following information:

- Symbol or image **1** for the application
- Title **2**, which contains the name, a telephone number or a navigation destination, for example
- The service and additional information **3**

- A time stamp **5**
- If several actions are available, symbol **4** to open or close the notification.

Depending on the type of notification, up to four different actions **6** are available.

Examples of actions include:

- Read aloud
- Placing a call
- Reply
- Calling up a web page
- Navigation

Some notifications, e.g. a navigation destination, are stored longer. Therefore, it is not necessary to carry out available actions directly on the receipt of the notifications. A route guidance can be started at a later time.

- i** You can start a global search in the Notifications Center (→ page 308).

## Calling up notifications

### Opening the Notifications Center

▶ **On the touchpad:** swipe down with two fingers.

or

▶ **On the touchscreen:** tap on the  symbol for the Notifications Center.

or

▶ **On the Touch Control and on the touchpad:** mark the  symbol for the Notifications Center by swiping.

▶ Press on the control element.

### Selecting a notification

▶ Swipe up or down.

▶ Tap or press on the control element.

### Calling up old notifications

If notifications have not been called up after four hours, these are stored in the archive.

▶ Swipe upwards and select **Archive**.

▶ Select the notification.

## Closing the Notifications Center

- ▶ **On the touchpad:** swipe up with two fingers.

## Selecting actions for a notification

The following options are available:

- Select the action directly in an application after a notification is received and shown.
- Select the action later after calling up in the Notifications Center.

- ▶ **An action is available:** select the action.
- ▶ **Several actions are available:** if the notification is not open, select the  symbol.
- ▶ Select the action.  
The notification is still available.
- ▶ If **Additional information** is available, select the action.  
Additional information is shown in a window as text, image or text and image.
- ▶ **To close the window:** select **OK**.

## Editing notifications

- ▶ Call up the Notifications Center (→ page 306).

- ▶ **To make settings:** select .

- ⓘ If no settings can be made, a message appears.

- ▶ Select the service.
- ▶ Switch the options on or off.

The following options are available:

- [Allow Notifications](#)
- [Display in Notification Center](#)
- [Show Notifications](#)
- [Acoustic Notifications](#)

When [Allow Notifications](#) is switched on, the other options cannot be selected.

- ▶ **To delete:** touch a message on the touchscreen and slide to the left or right.

or

- ▶ Select the recycle bin.
- ▶ Select [Delete](#) or [Delete All](#).  
[Delete](#) deletes a single notification.  
[Delete All](#) deletes all notifications currently shown.
- ▶ With  you will exit delete mode.

## Global search

### Global search overview

You can use the global search in the home screen and in the notifications.

The global search provides search results for the following categories:

- Navigation
- Entertainment
- Telephone, social media
- User interface and Digital Operator's Manual
- Internet

This enables you to search for cities, roads and tourist attractions with the navigation system, for example.

- ⓘ You can also search for 3 word addresses (→ page 333).

When you enter a 3 word address in the global search, separate each of the words with a space or a full stop.

During the entry process the most likely suggestions are shown beneath the search field. When you enter "S", "Stuttgart", "Steak" and "Sandra"

are shown, for example. If you select "Stuttgart", you receive the suggestions "Starbucks", "Steak" and "City railway", for example.

The search results in the list are shown, sorted according to category. Next to the category is the number of results. You will be shown the best results from each category. Additional results can be found after selecting the respective category.

If you confirm an entry with **OK**, all categories and the number of results will be shown in a summary. After selecting a category you can select the search results within the category. When you select a search result the detailed view opens. In the detailed view you can choose whether and which actions you want to carry out with the respective search result. For example, you can start route guidance or place a call to somebody. The actions are named correspondingly.

The search can be carried out with the following input methods:

- Entering characters using the on-screen keypad

- Entering characters with handwriting recognition
- Dictation function

### Using the global search

Multimedia system:



▶ Select  Search.

or

- ▶ Call up the notifications (→ page 306).
- ▶ Select **Search**.
- ▶ Enter the search term into the search field. During the entry process the three most likely suggestions are offered beneath the search field.

In the list on the right, the top two search results are shown for each category.

- ① Use the character input function. Alternatively, you can use the  dictation function for the search.

- ▶ **To accept a suggestion:** select the suggestion. The three most likely suggestions are offered.
- ▶ Continue the search or accept a suggestion.
- ▶ **To accept the second search result:** select the search result. An action starts or a list is shown.
- ▶ Select a search result or an action in the list.
- ▶ **To show all categories:** select **OK**.
- ▶ **To show search results for a category:** select a category.
- ▶ **To show details:** select a search result.
- ▶ **To start an action:** select an action. After selection of an action, a track is played back or the route to a destination is calculated, for example.

### Switching the sound on/off

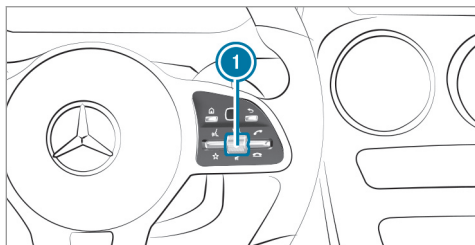

On the multifunction steering wheel

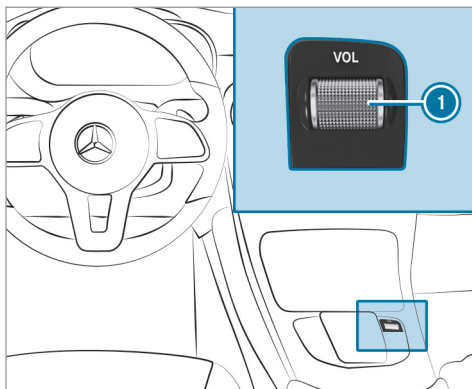

On the multimedia system

- ▶ **To mute:** press volume control ①.  
The  symbol appears in the status line of the media display.  
You will also hear traffic announcements and navigation announcements even when the sound is muted.

- ▶ **To switch on:** turn volume control ① or change the media source.

### Adjusting the volume

#### Adjusting with the control knob

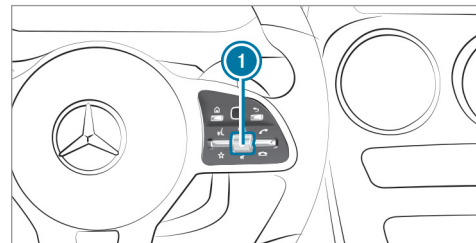

On the multifunction steering wheel

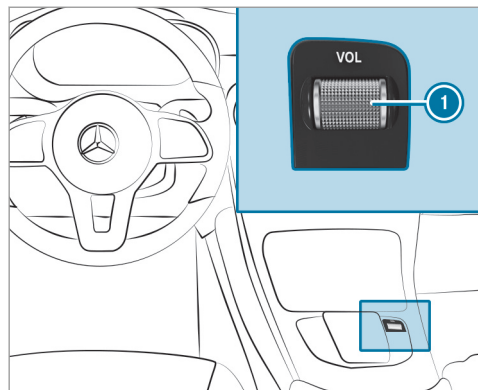

On the multimedia system

- ▶ Turn volume control ①.  
The volume of the current radio or media source is set. The volume of other audio sources can be adjusted separately.

Adjust the volume in the following situations:

- During a traffic announcement
- During a navigation announcement

The volume of the current media source changes in accordance with the volume of the navigation announcement.

- During a telephone call
- When entering or exiting a parking space while using Active Parking Assist

#### Setting in the menu

- ▶ Press the  button on the Touch Control or on the touchpad.
- ▶ Select **Settings**.
- ▶ Select **System**.
- ▶ Select **Audio**.
- ▶ Select a volume setting.
- ▶ Set the volume.

## Entering characters

### Using the character input function

**⚠ WARNING** Risk of distraction from information systems and communications equipment

If you operate information and communication equipment integrated in the vehicle when driving, you will be distracted from the traffic situation. This could also cause you to lose control of the vehicle.

- ▶ Only operate this equipment when the traffic situation permits.
- ▶ If you cannot be sure of this, stop the vehicle whilst paying attention to road and traffic conditions and operate the equipment with the vehicle stationary.

You must observe the legal requirements for the country in which you are currently driving when operating the multimedia system.

**Requirements:**



- **For the handwriting recognition read-aloud function:** the multimedia system is equipped with a voice control system.
- The read-aloud function is available for the selected system language.
- The handwriting recognition read-aloud function is activated.

Character entry can be carried out with these control elements:

- Touch Control
- Touchscreen (media display)
- Touchpad

Character input can be started with a control element and resumed with another.

▶ When the keypad is shown, enter the characters on the control element by swiping and pressing or by tapping (touchscreen).

or

▶ Write the characters on the touchpad or the touchscreen.

The touchpad supports character input with the following functions:

- Handwriting recognition offers character suggestions.
- If the read aloud function is activated for handwriting recognition then the entered characters are read aloud.

Examples of character entry:

- Renaming a favorite

- Looking for search results in the global search.
- Entering a destination address in the navigation system
- Entering a web address

#### **Entering characters on the touchpad Requirements:**

- If you wish to have the character input read aloud: the read aloud function of the handwriting recognition is switched on (→ page 290).
- An online connection is required for some functions.





#### Using the keyboard

- ① Input line
- ② Shows suggestions during input (if available)
- ③ Deletes an entry
- ④ Deletes
  - Pressing or pressing briefly deletes the last character entered
  - Pressing and holding deletes the entry
- ⑤ Accepts an entry

- ⑥ Switches to handwriting input
- ⑦ Enters a space
- ⑧ Changes the keyboard language
- ⑨ Switches to special characters
- ⑩ Switches to digits and additional special characters
  - ABC Switches to letters (level 2)
- ⑪ Pressing or pressing briefly switches between upper-case and lower-case letters

Pressing and holding switches to upper-case letters permanently

If available, the  symbol allows you to change to voice input.

**i** When **Touchpad Tap** is switched on , tapping is sufficient to select a character or an option (→ page 290).

**▶** Call up the character entry to rename a favorite, for example (→ page 305).

- ▶ Select the character by swiping and pressing. The character is entered in input line ❶. Suggestions are shown in ❷.
- ▶ **To select a suggestion:** select one of the entries.
- ▶ Resume character input.

- ▶ **To enter an alternative character:** press and hold a character.
- ▶ Select the character.
- ▶ **To end character input:** press the  button.

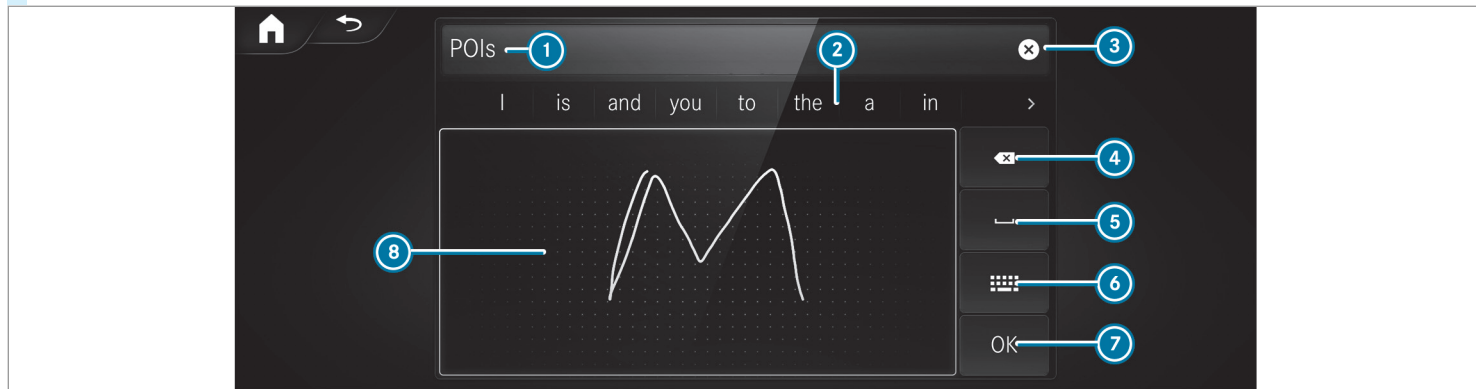

- ❶ The available editing functions depend on the editing task, the language set and the character level.
- ❶ Entry using the keyboard can also be completed using the Touch Control.



- Using handwriting input
- ❶ Input line
- ❷ Shows suggestions during input

- ❸ Deletes an entry
- ❹ Deletes

- Pressing or pressing briefly deletes the last character entered
- Pressing and holding deletes the entry

- 5 Enters a space
- 6 Switches to input using the keyboard
- 7 Accepts an entry
- 8 Writes characters on the drawing surface  
If available, the  symbol allows you to change to voice input.
- i When **Touchpad Tap** is switched on , tapping is sufficient to select an option (→ page 290).
- ▶ Call up the character entry to rename a favorite, for example (→ page 305).

- ▶ When the keyboard is displayed, select .
- ▶ Write the character on the touchpad with a finger.  
The character is entered in input line 1.  
Suggestions are shown in 2.
- ▶ **To select a suggestion:** select one of the entries.
- ▶ Resume character input. The letters can be written next to each other or above each other.

- ▶ **To end character input:** press the  button.

#### Entering characters on the touchscreen Requirements:

- If you wish to have the character input read aloud: the read aloud function of the handwriting recognition is switched on (→ page 290).
- An online connection is required for some functions.



#### Using the keyboard

- ① Input line
- ② Shows suggestions during input (if available)
- ③ Deletes an entry
- ④ Deletes  
Pressing briefly deletes the last character entered  
Pressing and holding deletes the entry
- ⑤ Accepts an entry
- ⑥ Switches to handwriting input
- ⑦ Enters a space
- ⑧ Changes the keyboard language
- ⑨ Switches to special characters
- ⑩ Switches to digits and additional special characters  
ABC Switches to letters (level 2)
- ⑪ Pressing or pressing briefly switches between upper-case and lower-case letters

Pressing and holding switches to upper-case letters permanently  
If available, the  symbol allows you to change to voice input.

▶ Call up the character entry to rename a favorite, for example (→ page 305).  
The keyboard is shown.

- ▶ Briefly press on a character. The character is entered in input line ①. Suggestions are shown in ②.
- ▶ **To select a suggestion:** select one of the entries.
- ▶ If available, display additional suggestions with < >.

- ▶ Resume character input.
- ▶ **To enter an alternative character:** press and hold a character.
- ▶ Select the character.
- ▶ **To end character entry:** press briefly on .

① The available editing functions depend on the editing task, the language set and the character level.

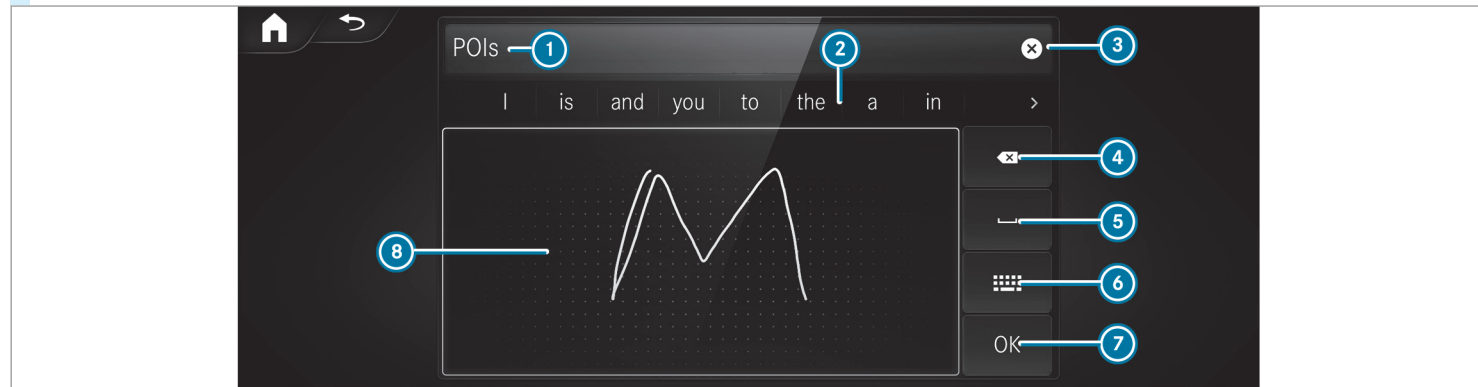

① Using handwriting input  
① Input line



② Shows suggestions during input  
③ Deletes an entry

④ Deletes

Pressing briefly deletes the last character entered

Pressing and holding deletes the entry

- 5 Enters a space
  - 6 Switches to input using the keyboard
  - 7 Accepts an entry
  - 8 Writes characters on the drawing surface
- If available, the  symbol allows you to change to voice input.

- ▶ Call up the character entry to rename a favorite, for example (→ page 305).
- ▶ When the keyboard is displayed, select .
- ▶ Write the character with one finger on the touchscreen.  
The character is entered in input line 1. Suggestions are shown in 2.
- ▶ **To select a suggestion:** select one of the entries.
- ▶ If available, display additional suggestions with  or .

- ▶ Resume character input. The letters can be written next to each other or above each other.

▶ **To end character entry:** press briefly on



### Setting the keyboard for character entry

Multimedia system:

- ↳ Settings ▶ System ▶ Controls
- ▶▶ Keyboards and Handwriting

- ▶ Confirm **Select keyboards**.  
Select the keyboard language in the list.

## System settings

### Display

#### Configuring display settings

Multimedia system:

- ↳  ▶▶ Settings ▶ System
- ▶▶ Designs & Display

#### Setting the design

- ▶ Select **Designs**.

- ▶ Select **Classic**, **Sport** or **Progressive**.  
The multimedia system display changes depending on the style selected. If you revert to the factory settings, the **Classic** style is set.

- ▶ **To adjust the ambient lighting to a style:** select **Ambient Lighting Adjustment**.  
This function adjusts the ambient lighting for the selected display style.

#### Setting the display brightness

- ▶ Select **Display Brightness**.
- ▶ Select a brightness value.

#### Switching the display off/on

- ▶ **Off:** select **Display Off**.
- ▶ **On:** press a button, , for example.

#### Selecting the display design

- ▶ Select **Day/Night Design**.
- ▶ Select **Automatic**, **Day Design** or **Night Design**.

**Switching the temperature display on/off**

- ▶ Select [Temperature Display](#).
- ▶ Select [Outside Temp.](#) or [Coolant Temp.](#).  
The selected temperature is displayed in the instrument cluster.

**Time and date****Setting the time and date automatically**

Multimedia system:

-  » [Settings](#) » [System](#)
- ▶ [Time and Date](#)

- ▶ Deactivate [Manual Time Adjustment](#).  
The time and date are set automatically for the selected time zone and summer time option.

- ⓘ The correct time is required for the following functions:
  - Route guidance with time-dependent traffic guidance.
  - Calculation of expected time of arrival.

**Setting the time zone Requirements:**

- For the manual time zone: [Automatic Time Zone](#) is switched off.

Multimedia system:

-  » [Settings](#) » [System](#)
- ▶ [Time and Date](#)

**Setting the time zone manually**

- ▶ Select [Time Zone](#).  
The list of countries is displayed.
- ⓘ If there are several time zones available in a country, these will be shown after the country is selected.
- ▶ Select a country and, if required, a time zone.  
The time zone set is displayed after [Time Zone](#).

**Setting the time zone automatically**

- ▶ Activate [Automatic Time Zone](#).

**Setting the time and date format**

Multimedia system:

-  » [Settings](#) » [System](#)
- ▶ [Time and Date](#) » [Set Format](#)

- ▶ Set the date and time format •.

**Setting the time and date manually Requirements:**

- The [Manual Time Adjustment](#) function is switched on.
- **For setting the date manually:** no GPS is installed in the vehicle.

Multimedia system:

-  » [Settings](#) » [System](#)
- ▶ [Time and Date](#)

**Setting the time (without time zone)**

- ▶ Select [Set Time](#).
- ▶ Set a time.

**Setting the time (with time zone)**

- ▶ Select [Set Time](#).



If a time zone is set the time is set automatically using the time zone. The time can be adjusted by a maximum of plus or minus 60 minutes.

- ▶ Adjust the time using the slide control.

### Setting the date

- ▶ Select **Set Date**.
- ▶ Set a date.

- ⓘ In vehicles with GPS, a date cannot be set even with active manual time adjustments. The date is then set automatically through the selected time zone.

## Connectivity

### Switching transmission of the vehicle position on/off

Multimedia system:

- ▶  ▶ **Settings** ▶ **System**
- ▶ **Wi-Fi & Bluetooth**

- ▶ Select **Transmit Vehicle Position**.
- ▶ Activate or deactivate the function.

## Bluetooth®

### Information about Bluetooth®

Bluetooth® technology is a standard for short-range wireless data transfer up to approximately 32.8 ft (10 m).

You can use Bluetooth® to connect your mobile phone to the multimedia system and use the following functions, for example:

- Hands-free system with access to the following options:
  - contacts (→ page 374)
  - call lists (→ page 377)
- Internet connection (→ page 394)
- Listening to music via Bluetooth® audio (→ page 405)
- Transferring business cards (vCards) into the vehicle

Bluetooth® is a registered trademark of Bluetooth Special Interest Group (SIG) Inc.

- ⓘ Internet connection via Bluetooth® is not available in all countries.

### Activating/deactivating Bluetooth®

Multimedia system:

- ▶  ▶ **Settings** ▶ **System**
- ▶ **Wi-Fi & Bluetooth**

- ▶ Switch **Bluetooth** on or off.

## Wi-Fi

### Wi-Fi connection overview

You can use Wi-Fi to establish a connection with a Wi-Fi network and to access the Internet or other network devices.

The following connection options are available:

- Wi-Fi connection
 

The Wi-Fi connection to a Wi-Fi-capable device, e.g. a mobile phone or a tablet PC is established.
- Multimedia system as a Wi-Fi hotspot
 

Using this function, a tablet PC or notebook can be connected, for example. The connected device can use the data tariff of the vehicle. A maximum of three devices can be connected with the hotspot at the same time.

- ❗ The use of the vehicle data tariff by external devices is not available in all countries.

To establish a connection, you can use the following methods:

- WPS PIN  
The connection to a secure Wi-Fi network is made via a PIN.
- WPS PBC  
The connection to a secure Wi-Fi network is made by pressing a button (push button).
- Security key  
The connection to a secure Wi-Fi network is made via a security key.

### Setting up Wi-Fi Requirements:

- **To set up the Wi-Fi connection of the multimedia system with new devices:** there is no communication module installed.
- The device to be connected supports one of the three means of connection described.

Multimedia system:

➔  ➔ Settings ➔ System  
➔ Wi-Fi & Bluetooth

### Activating/deactivating Wi-Fi

- ▶ Select **Wi-Fi**.  
If Wi-Fi is switched on, you can connect the multimedia system with external hotspots. If Wi-Fi is deactivated, communication via Wi-Fi to all devices is interrupted. This also means that a connection to the communication module cannot be established. Then some functions such as dynamic route guidance with Live Traffic Information are not available.

### Connecting the multimedia system with a new device via Wi-Fi

This function is available if a communication module is not installed.



The type of connection established must be selected on the multimedia system and on the device to be connected.

- ❗ The connection procedure may differ depending on the device. Follow the instruc-

tions that are shown in the display. Further information (see the manufacturer's operating instructions).

- ▶ Select **Internet Settings**.
- ▶ Select **Connect via Wi-Fi**.
- ▶ Select **Add Hotspot**.

### Connecting using a security key

- ▶ Select the options  of the desired Wi-Fi network.
- ▶ Select **Connect Using Security Key**.
- ▶ Have the security key displayed on the device to be connected (see the manufacturer's operating instructions).
- ▶ Enter this security key on the multimedia system.
- ▶ Confirm the entry with .

- ❗ All devices support a security key as a means of connection.

### Connecting using a WPS PIN

- ▶ Select the options  of the desired Wi-Fi network.

- ▶ Select **Connect via WPS PIN Input**.  
The multimedia system generates an eight-digit PIN.
- ▶ Enter this PIN on the device to be connected.
- ▶ Confirm the entry.

#### Connecting using a button

- ▶ Select the options  of the desired Wi-Fi network.
- ▶ Select **Connect via WPS PBC**.
- ▶ Select "Connect via WPS PBC" in the options on the device to be connected (see the manufacturer's operating instructions).
- ▶ Press the WPS button on the device to be connected.
- ▶ Select **Continue** in the multimedia system.

#### Activating automatic connection

- ▶ Select **Connect via Wi-Fi**.
- ▶ Select the options  of the desired Wi-Fi network.
- ▶ Activate **Permanent Internet Connection**.

#### Connecting with a known Wi-Fi

- ▶ Select **Connect via Wi-Fi**.
- ▶ Select a Wi-Fi network.  
The connection is established again.

#### Setting up a Wi-Fi hotspot

Multimedia system:

- ▶  ▶ **Settings** ▶ **System**
- ▶▶ **Wi-Fi & Bluetooth**

#### Configuring the multimedia system as a Wi-Fi hotspot

The type of connection established depends on the device to be connected. The function must be supported by the multimedia system and by the device to be connected. The type of connection established must be selected on the multimedia system and on the device to be connected.

- ▶ Select **Vehicle Hotspot**.
- ▶ Select **Connect Device to Vehicle Hotspot**.

#### Connecting using WPS PIN generation

- ▶ Select **Connect via WPS PIN Generation**.

- ▶ Enter the PIN shown in the media display on the device to be connected and confirm.

#### Connecting using WPS PIN entry

- ▶ Select **Connect via WPS PIN Input**.
- ▶ Enter the PIN that is shown on the external device's display on the multimedia system.

#### Connecting using a button

- ▶ Select **Connect via WPS PBC**.
- ▶ Press the push button on the device to be connected (see the manufacturer's operating instructions).
- ▶ Select **Continue**.

#### Connecting using a security key

- ▶ Select **Connect Device to Vehicle Hotspot**.  
A security key is displayed.
- ▶ Select the vehicle from the device to be connected. The vehicle is displayed with the **MB Hotspot XXXXX** network name.
- ▶ Enter the security key which is shown in the media display on the device to be connected.
- ▶ Confirm the entry.

### Connecting using NFC

- ▶ Select **Connect via NFC**.
- ▶ Activate NFC on the mobile device (see the manufacturer's operating instructions).
- ▶ Bring the mobile device into the NFC area of the vehicle .
- ▶ Select **Finished**.  
The mobile device is now connected to the multimedia system hotspot via NFC.

### Generating a new security key

- ▶ Select **Vehicle Hotspot**.
- ▶ Select **Generate Security Key**.  
A connection will be established with the newly created security key.
- ▶ **To save a security key:** select **Save**.  
When a new security key is saved, all existing Wi-Fi connections are then disconnected. If the Wi-Fi connections are being re-established, the new security key must be entered.

### System language

#### Notes on the system language

This function allows you to determine the language for the menu displays and the navigation announcements. The selected language affects the characters available for entry. The navigation announcements are not available in all languages. If a language is not available, the navigation announcements will be in English.

#### Setting the system language

Multimedia system:

↳  ▶ Settings ▶ System

▶  Language

- ▶ Set the language.

**i** If you are using Arabic map data, the text information can also be shown in Arabic on the navigation map. To do so, select العربية as the language from the language list. Navigation announcements are then also made in Arabic.

### Setting the distance unit

Multimedia system:

↳  ▶ Settings ▶ System ▶ Units

- ▶ Select **km** or **mi**.
- ▶ In the multifunction display of the Instrument Display, switch the **Additional Speedometer** display on.

### Data import and export

#### Data import/export function

The following functions are possible:

- Transferring data from one system or vehicle to another system or vehicle.
  - Creating a backup copy of your personal data and loading it again.
  - Protecting your personal data against unwanted export with PIN protection.
- i** Please note that the NTFS file system is not supported. The FAT32 file system is recommended.

## Importing/exporting data

**!** **NOTE** Loss of data due to premature removal

▶ Do not remove the data storage medium when data is being exported.

Mercedes-Benz is not liable for any loss of data.

### Requirements:

- The vehicle is stationary.
- The ignition is switched on.
- A USB device is connected.

Multimedia system:

➔  ➔ **Settings** ➔ **System**  
➔ **System Backup**

▶ Select **Import Data** or **Export Data**.

### Importing

▶ Select a data storage medium.  
A prompt appears asking whether you really wish to overwrite the current data. If data

originates from another vehicle, this is recognized during data reading.

▶ Confirm the prompt.

The files are imported. The multimedia system is restarted once the data has been imported.

**i** Current vehicle settings can be edited after the import.

### Exporting

If PIN protection is activated, your PIN is requested.

▶ Enter the four-digit PIN.

▶ Select a data storage medium.  
A prompt appears asking whether you really wish to carry out the export.

▶ Confirm the prompt.  
The data is exported. The data export may take several minutes.

**i** After successful export, the data is saved in the "MyMercedesBackup" directory which can be found on the storage medium.

## Activating/deactivating PIN protection

### Requirements:

- **To unlock the PIN:** there is an Internet connection.
- A Mercedes me account exists at <http://www.mercedes.me>.
- An individual user profile is active (→ page 299).

Multimedia system:

➔  ➔ **Settings** ➔ **System**  
➔ **PIN Protection**

### Setting the PIN

▶ Select **Set PIN**.  
▶ Enter a four-digit PIN.  
▶ Enter the four-digit PIN again.  
If both PINs match, PIN protection is active.

### Changing the PIN

▶ Select **Change Settings**.  
▶ Enter the current PIN.  
▶ Select **Change PIN**.

- ▶ Set a new PIN.

### Activating PIN protection for data export

- ▶ Select **Protect Data Export**.  
Activate or deactivate the function.

### Unlocking the PIN via the Mercedes me portal

If the PIN has been entered incorrectly three times, the PIN will be blocked. You can have a single-use password sent to you via the Mercedes me connect online portal to reset the PIN protection.

- ▶ Select **Unlock PIN**.
- ▶ Enter the single-use password.  
PIN protection is reset, and you can set a new PIN.

### Software update

#### Information on software updates

A software update consists of three steps:

- Downloading or copying of the data required for installation
- Installation of the update

- Activation of the update by restarting the system

The multimedia system provides a message when an update is available.

Depending on the source, you can perform various updates:

#### Software updates

| Source of the update                          | Update type   |
|---|---|
| Internet                                      | Navigation map, system updates, Digital Operator's Manual |
| External storage medium, e.g. USB flash drive | Navigation maps   |

- ⓘ Installation can take several minutes and cancellation is not possible. If you do not install the software updates then the status of your vehicle will not be up-to-date. During the installation, individual functions or con-

trol elements are not available or only available to a limited degree.

#### Advantages of updating software

Software updates ensure your vehicle's technology is up-to-date.

In order to improve the quality of our services you will receive future updates for your multimedia system, the Mercedes me connect services and your vehicle's communication module.

These will conveniently be sent to you via the mobile phone connection in your vehicle and, in many cases, installed automatically. You can monitor the status of your updates at any time on the Mercedes me portal and find information about potential innovations.

Your advantages at a glance:

- conveniently receive software updates via the mobile phone network
- improves the quality and availability of Mercedes me connect services
- keeps your multimedia system and communication module up-to-date

Further information about software updates can be found at <https://me.mercedes-benz.com>

### Performing a software update

#### Requirements:

- **For online updates:** an Internet connection is established (→ page 394).
- **For automatic online updates:** your vehicle has a permanently installed communication module.

Multimedia system:

→  » Settings » System  
» Software Update

#### Automatically

- ▶ Activate [Automatic Online Update](#).  
The updates will be downloaded and installed automatically.  
The current status of the updates is displayed.

#### Manually

- ▶ Deactivate [Automatic Online Update](#).

- ▶ Select an update from the list and start the update.

#### Activating the software update

- ▶ Restart the system.  
The modifications from the software update will be active.

#### Function of important system updates

Important system updates may be necessary for the security of your multimedia system's data. Install these updates, or else the security of your multimedia system cannot be ensured.

- ⓘ If automatic software updates are activated, the system updates will be downloaded automatically (→ page 325).

As soon as an update is available for download, a corresponding message appears on the media display.

You have the following selection options:

- [Accept and Install](#)  
The update will be downloaded in the background.
- [Information](#)

Information about the pending system update is displayed.

- [Later](#)

The update can be downloaded manually at a later time (→ page 325).

#### Deep system updates

Deep system updates access vehicle or system settings and can therefore only be carried out when the vehicle is stationary and the ignition is switched off.

If the download of a deep system update is completed and the update is ready for installation, you will be informed of this after the next ignition cycle, for example.

- ⓘ Park the vehicle safely in a suitable location before starting the installation.

Requirements for the installation:

- The ignition is switched off.
- Notes and warnings have been read and accepted.
- The electric parking brake is applied.

If all requirements are met, the update will be installed. The multimedia system cannot be operated while the update is being installed and vehicle functions are restricted.

If errors should occur during the installation, the multimedia system automatically attempts to restore the previous version. If restoration of the previous version is not possible, a symbol appears on the media display. Please consult a qualified specialist workshop to resolve the problem.

### Resetting the multimedia system (reset function)

Multimedia system:

→  » Settings » System » Reset

Personal data is deleted, for example:

- Station presets
- Connected mobile phones
- Individual user profiles

 The guest profile is reset when the settings are restored to the factory settings.

A prompt appears again asking whether you really wish to reset.

- ▶ Select **Yes**.  
The multimedia system is reset to the factory settings. If you have set a PIN for your system, this will also be reset.

### Navigation

#### Switching navigation on

Multimedia system:

→  » Navigation (Navigation)

- ▶ Alternatively: press the  button.  
The map appears. The current vehicle position is shown. The navigation menu is shown.  
The navigation menu is hidden if route guidance is active.

#### Showing/hiding the navigation menu

→  » Navigation

If route guidance is not active the map appears. The navigation menu is shown.

The navigation menu is hidden if route guidance is active.

- ▶ **To show:** tap on the touchscreen.  
or
- ▶ Press the Touch Control or the touchpad.
- ▶ **To hide:** the navigation menu is hidden automatically.



## Navigation overview

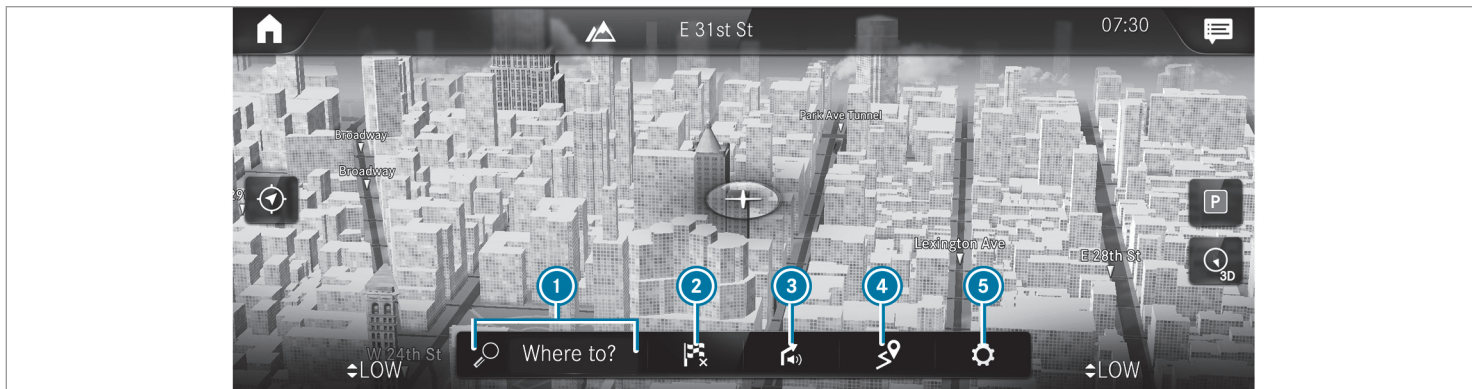

Example: digital map with navigation menu

- ① To enter a POI or address and additional destination entry options
- ② To interrupt route guidance (if route guidance is active)
- ③ To repeat a navigation announcement and switch navigation announcements on or off
- ④ To call up the **ON THE WAY** menu

- To show **Route Overview**
- To select **Alternative Routes**
- **Report Traffic Incident** (Car-to-X)
- To call up the **TRAFFIC** menu
  - ◇ To show **Traffic Announcements**
  - ◇ To show **Area Alerts**
  - ◇ To show **Live Traffic Subscription Info**

- To show **Route List**
- To call up the **POSITION** menu
  - ◇ **Save Position**
  - ◇ To show **Compass**
- ⑤ Quick-access and settings
  - To show **Traffic**
  - To show **Parking**

- To show [Highway Information](#)
- Via [Advanced](#) options to use [View](#), [Announcements](#) and [Route](#)

- ① The options are not available in all countries.
- ① You can enter 3 word addresses in the online search (→ page 333). This option is not available in all countries.

### Destination entry

#### Notes on destination entry

**⚠ WARNING** Risk of distraction from operating integrated communication equipment while the vehicle is in motion

If you operate communication equipment integrated in the vehicle when driving, you will be distracted from the traffic situation. This could also cause you to lose control of the vehicle.

- ▶ Only operate this equipment when the traffic situation permits.
- ▶ If you cannot be sure of this, stop the vehicle whilst paying attention to road and traffic conditions and operate the equipment with the vehicle stationary.

You must observe the legal requirements for the country in which you are currently driving when operating the multimedia system.

#### Entering a POI or address

**⚠ WARNING** Risk of distraction from information systems and communications equipment

If you operate information and communication equipment integrated in the vehicle when driving, you will be distracted from the traffic situation. This could also cause you to lose control of the vehicle.

- ▶ Only operate this equipment when the traffic situation permits.
- ▶ If you cannot be sure of this, stop the vehicle whilst paying attention to road and traffic conditions and operate the equipment with the vehicle stationary.

You must observe the legal requirements for the country in which you are currently driving when operating the multimedia system.

#### Requirements:

- **For the online search:** Mercedes me connect is available.
- You have set up a user account in the Mercedes me portal.
- The vehicle has been activated for use of Mercedes me connect and you have accepted the terms and conditions for the service. Further information can be found at: <http://www.mercedes.me>
- The service is available.

- The service has been activated at an authorized Mercedes-Benz Center.

Multimedia system:

→ [Home] ▶ Navigation ▶ [Search] Where to?

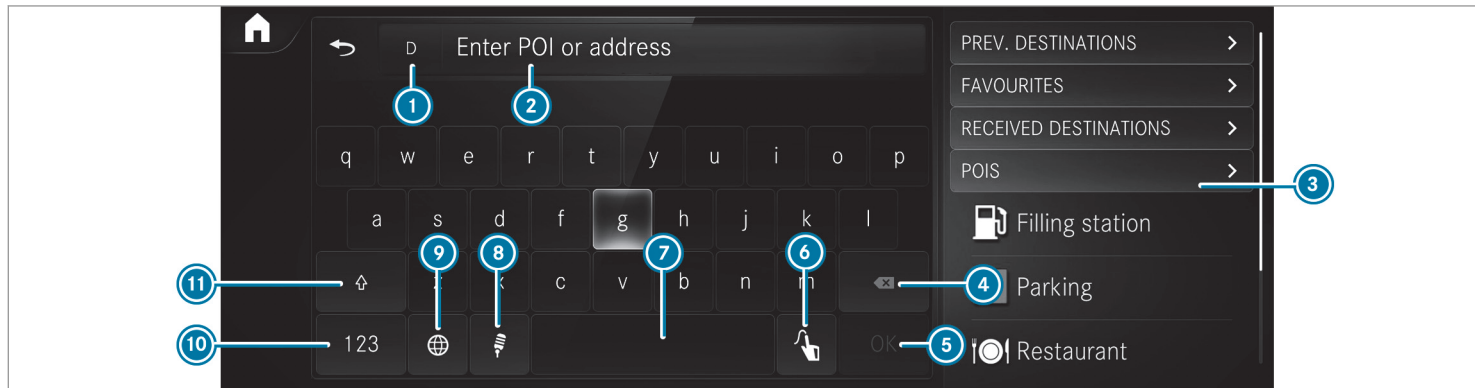

On-board search with the keypad  
Destination entry uses the on-board search of the database stored in the multimedia system. The federal state or province in which the vehicle is located is set ①.

▶ Enter the POI or the address using the keyboard (in the image) or using handwriting

recognition ⑥ in input line ②. The entries can be made in any order. During destination entry, suggestions are offered in ③ by the multimedia system. Destination selection takes place in list ③ or with ⑤ [OK].

The following entries can be made, for example:

- City, street, house number
- Street, city
- ZIP code
- POI name

- POI categories, e.g. [Gas Station](#)
- City, POI name
- Telephone number, if this is available for the POI
- Contact name

▶ Alternatively, use voice input [8](#).

▶ **To switch to handwriting recognition:** select [6](#).

▶ Write the character on the touchpad. The letters can be written next to each other or above each other (→ page 311).

▶ **To return to entry using the keyboard:** select .

or

▶ Press the touchpad.

▶ **To delete an entry:** select [4](#).  
The characters are deleted individually.

or

▶ If characters have been entered in [2](#), select  next to the input line.  
The complete entry is deleted.

▶ **To switch to upper-case or lower-case letters:** select [11](#).

▶ **To switch to digits, special characters and symbols:** select [10](#).  
123 changes to ABC.

Display [11](#) changes to #+=.

▶ Select [11](#) and switch to additional special characters.

▶ **To enter a space:** select [7](#).

▶ **To set the language:** select [9](#).

▶ Select the language.

[i](#) This function is useful for countries in which several character sets are supported. An example is Russia, which uses Cyrillic and Latin characters.

▶ **To change the state:** select indicator for federal state or province [1](#).

▶ Select the state in [1](#).

▶ Enter the country indicator, e.g. [CA](#) for Canada.  
The list is filtered.

▶ Select the country on list [3](#).  
The destination can be entered.

▶ **To change the state or province:** select the state or the province in list [3](#).

▶ **To accept a destination:** select the destination in list [3](#).

▶ If the destination is ambiguous, select the destination in the list.  
The destination address is shown. The route can be calculated.

### Using online search

[i](#) Requirements: the media display shows an Internet connection with a double-arrow symbol in the status line.

Online search is not available in all countries.

Destination entry uses online map services. If the on-board search finds no suitable destinations or if you change countries, the online search is available.

For the destination you can enter an address, a POI or a 3 word address.

[i](#) Enter a 3 word address (→ page 333).

- ▶ Select country indicator .
- ▶ Select the provider for the online service from the countries list.

or

- ▶ If the on-board search delivers no results, enter the destination in the input line. The entry order is not relevant, e.g. street and city. Use the functions described for the on-board search.  
The search results are displayed.
- ▶ Select the destination in the list.  
The detailed view for the route is displayed.

### Selecting previous destinations Requirements:

- Previous destinations are stored.
- **For destination suggestions:** you have created a profile (→ page 298).
- The [Allow Destination Suggestions](#) option is switched on (→ page 303).
- The multimedia system has already gathered sufficient data in order to show destination suggestions.

Multimedia system:

  ▶ Navigation ▶  Where to?  
▶ PREV. DESTINATIONS

The following entries can be selected in the previous destinations:

- Destination suggestions (→ page 350)
- Destinations
- Routes

▶ Select the destination or route  
The destination address is shown. The route can be calculated.

- ① You can save a previous destination or a destination suggestion as a favorite (→ page 350).  
Using the favorites, you have quick access to the destinations (→ page 334).

### Selecting a POI Requirements:

- **For use of personal POIs:** a USB device is connected with the multimedia system.

- Personal POIs with the GPS Exchange format (.gpx) have been saved in the "PersonalPOI" folder on the USB device.

Multimedia system:

  ▶ Navigation ▶  Where to?  
▶ POIS

### Searching using categories (no route guidance)

▶ Select the category.

or

- ▶ Select [All Categories](#).
- ▶ Select the category and the sub-category (if available).

The search takes place in the vicinity of the vehicle's current position. The search result are sorted by distance in ascending order.

The POIs show the following information:

- direction of the linear distance to the POI (arrow)
- name of POI
- linear distance to the POI

- ▶ **To filter according to categories or in search results:** enter a search entry in the  **Search** text field.
- ▶ Select a POI from the list.  
The destination address is shown. The route can be calculated.

#### Searching using categories (route guidance active)

- ▶ Select the category.
- or
- ▶ Select **All Categories**.
- ▶ Select the category and the sub-category (if available).
- ▶ **To filter according to categories or in search results:** enter a search entry in the  **Search** text field.
- ▶ Select the search positions **In the Vicinity**, **Near Destination** or **Along the Route**.
- ▶ If there are intermediate destinations for the route and **Near Destination** has been selected, select the search position in the route overview.

- ▶ Select a POI from the list.  
The destination address is shown. The route can be calculated.

#### Searching for personal POIs

- ▶ Select **Personal POIs**.
- ▶ Select a category.
- ▶ If route guidance is active, select a search position **In the Vicinity**, **Near Destination** or **Along the Route**.
- ▶ Select a personal POI.  
The destination address is shown. The route can be calculated.
- or
- ▶ Enter a search entry into the search field and filter the list.
- ▶ Select a personal POI.

#### Editing personal POI categories





- ▶ Select a personal POI category from the list .  
A menu opens.
- ▶ **To change a name:** select **Change Name**.

- ▶ Enter the name.
- ▶ Select .
- ▶ **To change a symbol:** select **Change Icon**.
- ▶ Select a symbol.
- ▶ **To delete a personal POI category:** select **Delete**.
- ▶ Select **Yes**.

#### Configuring categories for quick-access

You can configure the categories for quick-access.

If you calculate the route, for example, the first three of these categories can be selected as symbols.

- ▶ Select **All Categories**.
- ▶ Select the category and the sub-category (if available).
- ▶ Select   or  .
- ▶   adds the category.
- ▶   removes the category.
- ▶ If all available quick-access positions are full, select the category to be replaced.

### Selecting a contact for destination entry

#### Requirements:

- A mobile phone is connected to the multimedia system (→ page 369).

Multimedia system:

→  » Navigation »  Where to?  
» CONTACTS

#### Using the contact list

- ▶ Select a contact.  
The contact details are displayed.
- ▶ Select the address.

#### Using search entry



- ▶ Enter a name or telephone number, for example, into the search field.
- ▶ Select .
- ▶ Select the contact.
- ▶ Select the address.  
The destination address is shown. The route can be calculated.

- ① Route guidance to a contact address is reliable in the following cases:
  - the contact address is complete.
  - the contact data matches the map data in the digital map.

### Entering geo-coordinates

Multimedia system:

→  » Navigation »  Where to?  
» GEO-COORDINATES

- ▶ Select **Latitude** or **Longitude**.
- ▶ Select geo-coordinates as latitude and longitude coordinates in degrees, minutes and seconds. To do this swipe up or down respectively.  
The map shows the position.
- ▶ Confirm the entry with .
- ▶ **To set the destination:** select  or .
- ▶ Calculate the route (→ page 335).

### Entering the destination as a 3 word address

#### Requirements:

- Searching for a destination using 3 word addresses is possible in the online search (→ page 328).
- The media display shows an Internet connection with a double-arrow symbol in the status line.
- ① Searching for a destination using 3 word addresses is not possible in all countries and in all languages.

Multimedia system:

→  » Navigation »  Where to?

- ▶ Select the country indicator.
  - ▶ Select the provider for the online service from the countries list.
- or
- ▶ If the on-board search delivers no search results, enter the destination address as a 3 word address. Separate each of the words with a full stop.  
The search results are displayed.
  - ▶ Select the destination in the list.  
The destination address is shown. The route can be calculated.

- ① 3 word addresses from what3words are an alternative addressing system for multilingual georeferencing of global locations with a resolution of three meters. Using this grid, locations on the Earth's surface are included which do not have a building address such as street and house number, for example.

The Empire State Building has this language dependent 3 word address:

- English: parade.help.bleat
- French: commun.verbe.bisquer
- Spanish: suertes.diga.pesca

3 word addresses are unique, easy to remember and suffice for most routine applications.

You can convert addresses to 3 word addresses and back again:

- at the website <http://what3words.com>
- in the what3words apps

### Selecting a destination on the map

Multimedia system:



- ▶ Move the map (→ page 356).
- ▶ **Using the touchscreen:** press and hold on the touchscreen.  
The destination address is shown.  
If several destinations are located at the selected position, a list shows the available roads and POIs.
- ▶ Select the destination in the list.  
The destination address is shown. The route can be calculated.
- ▶ **Using the touchpad:** when the crosshair marks the destination, press and hold on the control element.  
The destination address is shown.  
If several destinations are located around the crosshair, a list shows the available roads and POIs.
- ▶ Select the destination in the list.  
The destination address is shown. The route can be calculated.

### Showing POIs in the vicinity of the map

If several destinations are located around the crosshair, the function is available.

- ▶ Select .
- ▶ Select **POIs in the Vicinity**.  
The map appears.
- ▶ Swipe left or right on the control element.  
The previous or next POI is highlighted on the map. The name or the address is shown.
- ▶ Select the POI symbol.

or

- ▶ **To filter the display according to the POI category:** scroll on the control element.
- ▶ Select the POI category.

### Selecting a destination from favorites Requirements:

- Destinations are saved as favorites.  
Save a previous destination or a destination suggestion as a favorite (→ page 350).



Multimedia system:

→  » Navigation »  Where to?  
» FAVORITES

- ▶ Select a favorite.  
The destination address is shown. The route can be calculated.

The following options are available in the favorites menu:

- Saving addresses for home and work
- Creating favorites
- Deleting favorites

▶ **If no address has been saved for home and work:** select [Home](#) or [Work](#).

- ▶ Confirm the prompt with [Yes](#).
- ▶ Enter the favorite as a POI or address (→ page 328).
- ▶ **To save a favorite:** select [Add Favorites](#).
- ▶ Enter the favorite as a POI or address (→ page 328).

or

- ▶ If all the positions in the favorites are full, first select a favorite which is to be overwritten (→ page 304).

- ▶ Follow the instructions provided.
- ▶ **To delete a favorite:** select  for a destination.
- ▶ Select [Delete](#).

or

- ▶ Press on a favorite until the [OPTIONS](#) menu is shown.
- ▶ Select [Delete](#).

### Selecting received destinations

#### Requirements:

- There is an Internet connection.
- A destination has been sent to the vehicle.

Multimedia system:



→  » Navigation »  Where to?  
» REC. DESTINATIONS

The vehicle can receive destinations from services or apps.

- ▶ Select a destination.  
The destination address is shown. The route can be calculated.

- ▶  You can save a received destination in the favorites (→ page 350).  
You have fast access to the destinations via the favorites (→ page 334).

### Deleting a received destination

- ▶ **To delete a destination:** select  for a destination.
- ▶ Select [Delete](#).
- ▶ Select [Yes](#).
- ▶ **To delete all destinations:** select .
- ▶ Select [Delete All](#).
- ▶ Select [Yes](#).

### Route

#### Calculating a route

- Requirements:**
- The destination has been entered.
  - The destination address is shown.

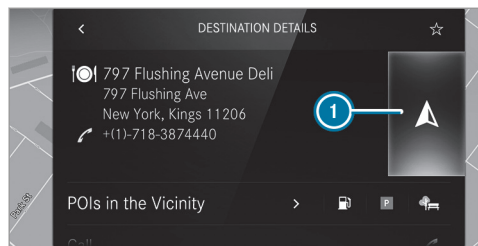

- 1 No route yet
- A route has been mapped

▶ Select .  
The route to the destination is calculated. The map shows the route. Route guidance then begins.

or

- ▶ Select .  
If a route is already mapped, a prompt is shown.
- ▶ Select **Set as Way Point**.  
The selected destination address is set as the next intermediate destination. Route guidance begins.

If there are already four intermediate destinations, the multimedia system asks whether intermediate destination 4 should be deleted. Confirm the prompt with **Yes**.

or

- ▶ Select **Start New Route Guidance**.  
The selected destination address is set as a new destination. The previous destination and the intermediate destinations are deleted. Route guidance to the new destination begins.

#### Searching for POIs in the vicinity of the destination shown

- 1 The POI symbols to the right of **POIs in the Vicinity** show the first three categories for quick-access. You can configure these categories (→ page 331).
- ▶ Select a POI symbol.  
The search results are displayed.
- ▶ Select a POI.  
The destination address is shown. The route can be calculated.

or

- ▶ Select **POIs in the Vicinity** .
- ▶ Search using categories, enter a search entry or search for a personal POI (→ page 331).
- ▶ Select a POI.  
The destination address is shown. The route can be calculated.

#### Other menu functions

- ▶ **To save the destination:** select .
- ▶ Select an option.

The following options are available:

- **Save in "Previous Destinations"**
- **Save as Favorite**
- **Save as "Home"**
- **Save as "Work"**

- ▶ **To call the destination:** if a telephone number is available, select **Call**.
- ▶ **To share the destination using NFC or QR code:** select **Share via NFC or QR Code**.
- ▶ Hold the NFC area of the mobile phone (see manufacturer's operating instructions) on the mat or place the mobile phone on it .

or

- ▶ Hold the mobile phone near to the multimedia system and scan the QR code.
- ▶ **To call up an Internet address:** if a web address is available, select [www](#).
- ▶ **To show on the map:** select [Show on Map](#).

### Selecting a route type

Multimedia system:



▶▶ [Advanced](#) ▶▶ [Route](#)

- ▶ Select the route type.  
If no route has been created, the next route is calculated on the basis of the new route type.  
If a route has already been created, the route is calculated on the basis of the new route type.

The following route types are available:

- **Fast**  
A route with a quick journey time is calculated.
- **Short**

A route with a short driving distance is calculated.

- **Eco**  
An economical route is calculated. The journey time may be somewhat longer than for quicker routes.
- **Trailer**  
The option is available if a trailer has been coupled with the vehicle.  
A prompt is shown in the multimedia system. Confirm the prompt.  
The route is optimized for trailer operation with a maximum speed of 50 mph (80 km/h).

### Traffic information can be taken into account for the route types:

- ▶ Select [Dynamic Route Guidance](#) .
- ▶ Select [Automatic](#), [On Request](#) or [Off](#).

Explanation of the options:

- **Automatic**  
The route is calculated with the currently set route type.

Traffic reports via Live Traffic Information are taken into account (→ page 351).

Live Traffic Information is not available in all countries.

- **On Request**  
A prompt appears when a new route is detected with a shorter journey time based on traffic reports. You can continue to use the current route or use the dynamic route instead (→ page 337).
- **Off**  
No traffic reports are taken into account for the route.

### Calculating alternative routes

- ▶ Activate [Suggest Alternative Route](#).  
The display button is activated. Alternative routes are calculated for every route.
- ▶ Select an alternative route (→ page 341).

### Accepting a detour recommendation after a prompt

**Requirements:**

- On **Request** is switched on (→ page 337) in the **DYNAMIC ROUTE GUIDANCE** menu.
- Route guidance is active.
- There are traffic reports for the current route.

If a new route with a shorter driving time is determined, the current and new routes will be shown.

The notification is shown in another application. Confirm the notification.

- ▶ **To accept the new route:** select **Accept Recommended Detour**.
- ▶ **To maintain the current route:** select **Keep to Current Route**.

### Selecting route options

Multimedia system:



### Avoiding areas

- ▶ Select **Avoid Options**.
- ▶ Select **Avoid Areas** (→ page 359).

### Avoiding or using highways, ferries, tunnels, motorail trains, unpaired roads

- ▶ Select **Avoid Options**.
- ▶ Activate or deactivate the avoid option.  
**To avoid:** the display button is activated. The route avoids highways, for example.

**To use:** the display button is off. The route takes highways into consideration, for example.

The selected route options cannot always be taken into account. Therefore, a route may include a ferry, for instance, even though the **Avoid Ferries** avoid option is enabled. A message then appears and you will hear a corresponding message.

### Avoiding or using toll roads

- ▶ Select **Avoid Options**.
- ▶ Select **Toll Roads**.
- ▶ Switch **Avoid All** on or off.

or

- ▶ Switch the **Cash or Card Payment** and **Electronic Billing** options on or off.  
**To avoid:** the display button is activated. The route avoids toll roads with the selected method of payment.  
**To use:** the display button is off. The route takes into account roads that require the payment of a usage fee (toll) corresponding with the payment type selected.

### Using carpool lanes

When using carpool lanes, observe the applicable legal requirements as well as any conditions pertaining to when and where such lanes may be used. Carpool lanes may only be used if certain conditions are met.

Carpool lanes are not available in all countries.

- ▶ Select **Avoid Options**.
- ▶ Select **Carpool Lanes**.
- ▶ Select **For Two Occupants** or **For 3 Occupants or More** .

or

- ▶ Select **On Request** . When this option is selected and a carpool lane is available, a prompt appears. You can continue to use the current route or select a route with the carpool lane.

 If the **Avoid** option is selected, then no carpool lanes will be used for the route.

#### Selecting notifications for the route Requirements:

- **For an audible indication when approaching a personal POI:** the USB device contains personal POIs.
- The USB device is connected with the multimedia system.
- The category in which the personal POI belongs is activated.

Multimedia system:

  **Navigation**   
 ▶ **Advanced** ▶ **Announcements**

- ▶ Switch **No Driving Recomm.** on or off. No navigation announcements are issued when the display button is switched on.

- ▶ **To select a navigation announcement:** select an option  under the **DRIVING RECOMMENDATION** category.

The following options are available:

- **Tone Only**  
In place of the spoken navigation announcement you hear a gong. The gong signals an upcoming driving maneuver and also sounds during the driving maneuver.
- **Reduced Driving Recomm.**  
If a navigation announcement is available, you hear a brief announcement, e.g. "turn right".
- **Detailed Driving Recomm.**  
If a navigation announcement is available and the **Announce Street Names** option is switched on, you hear a complete announcement, e.g. "In 600 ft (200 m) at the end of the street turn right into Station Road".

- ▶ **To have street names announced during a driving maneuver:** switch on **Announce Street Names**.

- ▶ Select **Reduced Driving Recomm.** or **Detailed Driving Recomm.**  
The name of the street into which you should turn is announced.

 The options in the **DRIVING RECOMMENDATION** category are not available in every country and in all languages.

#### Selecting messages for **TRAFFIC**

- ▶ Activate a message. The display button is activated. The following options are available:

- **Traffic Incidents**  
Traffic incidents are announced, e.g. roadworks and road blocks. This function is not available in all countries and languages.
- **Announce Traffic Warnings**

Warning messages are announced, e.g. before tailbacks that pose a risk (if available).

This function is not available in all countries and languages.

### Audible indication when approaching a personal POI

- ▶ Select the **Personal POIs** option in the **ALERTS** category.
- ▶ Activate a category.  
The display button is activated. When approaching a personal POI in this category an audible indication will be issued.

### Showing destination information for the route

#### Requirements:

- A destination is entered.

Multimedia system:



▶▶ **Navigation**



- ▶ Select **Route Overview**.

When route guidance is active, the destination and intermediate destinations are

shown, if these have been entered and not yet been passed.

The route can include up to four intermediate destinations.

- ▶ Select a destination or an intermediate destination.

The following information is displayed:

- Remaining driving distance
- Time of arrival
- Remaining journey time
- Name, destination address
- Phone number (if available)
- Web address (if available)

### Planning routes

Multimedia system:



▶▶ **Navigation**



▶▶ **Route Overview**

- ▶ Select **Set Way Point**.

- ▶ Enter the intermediate destination as a POI or address, for example (→ page 328).

- ▶ Select the intermediate destination.  
After selection of an intermediate destination, the route overview is shown again.

- ▶ Calculate the route with intermediate destinations (→ page 341)

- ▶ **i** If there are already four intermediate destinations, delete an intermediate destination (→ page 340).

### Editing a route with intermediate destinations

#### Requirements:

- The destination and at least one intermediate destination have been entered.

Multimedia system:



▶▶ **Navigation**







▶▶ **Route Overview**

- ▶ **To change the sequence of destinations:**  
select  for a destination.

A menu opens.

- ▶ Select **Move**.

 is highlighted.

- ▶ Move the intermediate destination or the destination with  or  to the desired position.
- ▶ Tap on .
- ▶ **To delete a destination:** select  for an intermediate destination or destination.
- ▶ Select **Delete**.  
The destination is deleted.

### Calculating a route with intermediate destinations

#### Requirements:

- The destination and at least one intermediate destination have been entered.

Multimedia system:

  ▶▶ Navigation

▶▶  ▶▶ Route Overview

- ▶ Select **Start Route Guidance**.

or

- ▶ If the route has been edited, select **To Navigation** .

- ▶ Confirm the prompt with **Yes**.  
The route is calculated. Route guidance begins.

### Displaying the route list

Multimedia system:

  ▶▶ Navigation ▶▶ 

- ▶ Select **Route List**.  
The route sections are displayed. The current vehicle position is marked on the map.  
The current vehicle position is shown with the following information:
  - The  symbol for the current vehicle position is displayed.
  - The name of the road on which you are currently driving is shown.
  - The road number of the road on which you are currently driving is shown.

The route list is updated during the journey.

- ▶ **To show route sections:** swipe up or down on the control element.  
The route section is shown on the map.

### Selecting an alternative route

#### Requirements:

- The **Suggest Alternative Route** option is switched on (→ page 337).

Multimedia system:

  ▶▶ Navigation ▶▶ 

- ▶ Select **Alternative Routes**.  
The routes are displayed in accordance with the setting made in the route settings.  
The routes are numbered.
- ▶ Select the alternative route.
- ▶ **To show the route on the map:** select **Show on Map**.
- ▶ Move the map (→ page 356).
- ▶ Set the map scale (→ page 355).
- ▶ **To avoid or use route options:** select .
- ▶ Switch the route option, e.g. **Highways**, on or off.  
**To avoid:** the display button is activated. The alternative route avoids highways.  
**To use:** the display button is off. The alternative route uses highways.

**Activating a commuter route****Requirements:**

- You have created a profile (→ page 298).
- The [Allow Destination Suggestions](#) option is switched on (→ page 303).
- The [Activate Commuter Route](#) option is switched on.
- The multimedia system has gathered sufficient data in order to show destination suggestions.
- Routes have been learned for these destination suggestions.

 This commuter route is not available in all countries.

Multimedia system:

  **Navigation**   
 **Advanced**  **Route**

 Activate [Activate Commuter Route](#).

The display button is activated. The navigation system automatically detects that the vehicle is on a commuter route. It automati-

cally starts a route guidance without voice output.

For the daily commuter route, traffic incidents on the route are also reported when driving without active route guidance.

**Switching the automatic gas station search on/off**

Multimedia system:

  **Settings**  **Vehicle**

- ▶ Switch [Gas Station Search](#) on or off. When the fuel reserve level is reached, and the display button is switched on, a message appears to start searching for gas stations.

**Starting an automatic gas station search****Requirements:**

- The automatic gas station search is activated (→ page 342) .

**Driving situation**

The fuel level in the fuel tank reaches the reserve fuel level.

The following notification is shown in the media display [Reserve Fuel Tap here to search for gas stations](#).

- ▶ Confirm the notification. The automatic gas station search begins. The available gas stations along the route or in the vicinity of the vehicle's current position are displayed.
- ▶ Select a gas station. The address of the gas station is displayed.
- ▶ Calculate the route (→ page 335). The gas station is set as the destination or the next intermediate destination.
- ▶ **If there are already four intermediate destinations:** select [Yes](#) in the prompt. The gas station is entered in the route overview. Intermediate destination 4 is deleted. Route guidance begins.

**Starting the automatic service station search****Requirements:**

- ATTENTION ASSIST and the [Suggest Rest Area](#) function are activated (→ page 240).



- There are service stations along the route section ahead.

### Driving situation



The following notification is shown in the media display **ATTENTION ASSIST** [Tap here to search for rest areas.](#)

- ▶ Confirm the notification.  
The service station search starts. The available service stations along the route or in the vicinity of the vehicle's current position are displayed.
- ▶ Select a service station.  
The service station address is displayed.
- ▶ Calculate the route (→ page 335).  
The service station is set as the destination or the next intermediate destination.
- ▶ **If there are already four intermediate destinations:** select **Yes** in the prompt.  
The service station is entered in the route overview. Intermediate destination 4 is deleted. Route guidance begins.

### Showing a stored route on the map Requirements:

- A USB device with stored routes is connected with the multimedia system (→ page 405).
- The route is stored in the "Routes" folder with the GPS Exchange format (.gpx).





Multimedia system:

- ▶  ▶ [Navigation](#) ▶  [Where to?](#)
- ▶ [SAVED ROUTES](#)
- ▶ Select a route.
- ▶ Select [Show on Map](#).
- ▶ Move the map (→ page 356).

### Starting a saved route Requirements:

- A USB device with stored routes is connected with the multimedia system (→ page 405).
- The route is stored in the "Routes" folder with the GPS Exchange format (.gpx).



Multimedia system:

- ▶  ▶ [Navigation](#) ▶  [Where to?](#)
- ▶ [SAVED ROUTES](#)
- ▶ Select a route.
- ▶ Select [Start Route Guid.](#) from [Beginning of Route](#) or [Start Route Guidance from Curr. Position](#).  
Route guidance starts.
- ▶  The route can be saved with  in the menu (→ page 335).

### Recording a route Requirements:

- A USB device is connected with the multimedia system (→ page 405).

Multimedia system:

- ▶  ▶ [Navigation](#) ▶  [Where to?](#)
- ▶ [SAVED ROUTES](#)
- ▶ **To start recording:** select [Start Recording a New Route](#).  
A red recording symbol is shown.  
The route is stored on the USB device.

▶ **To stop recording:** select [End Recording](#).

### Saving a recorded route

#### Requirements:

- A USB device is connected with the multimedia system (→ page 405).

Multimedia system:

→  ▶ [Navigation](#) ▶  [Where to?](#)

▶ [SAVED ROUTES](#)

▶ Select a route.

▶ Select .

▶ Select [Save in "Previous Destinations"](#). The route is stored in the "Previous destinations" memory and can be called up from there for route guidance.

### Editing a stored route

#### Requirements:

- A USB device with stored routes is connected with the multimedia system (→ page 405).

Multimedia system:

→  ▶ [Navigation](#) ▶  [Where to?](#)

▶ [SAVED ROUTES](#)

▶ Select a route with .

▶ **To enter a name:** select [Change Name](#).

▶ Enter the name.

▶ Select [OK](#).

or

▶ When the name has been changed, press the  button.

▶ Select [Yes](#).

▶ **To delete a route:** select [Delete](#).

▶ Select [Yes](#).

## Route guidance

### Notes on route guidance

**⚠ WARNING** Risk of distraction from operating integrated communication equipment while the vehicle is in motion

If you operate communication equipment integrated in the vehicle when driving, you will be distracted from the traffic situation. This could also cause you to lose control of the vehicle.

- ▶ Only operate this equipment when the traffic situation permits.
- ▶ If you cannot be sure of this, stop the vehicle whilst paying attention to road and traffic conditions and operate the equipment with the vehicle stationary.

You must observe the legal requirements for the country in which you are currently driving when operating the multimedia system. Route guidance begins once a route has been calculated.

The road and traffic rules and regulations always have priority over multimedia system driving instructions.

Driving instructions are:

- Navigation announcements
- Route guidance displays
- Lane recommendations

If you do not follow the driving instructions or if you leave the calculated route, a new route is calculated automatically.

Driving instructions may differ from the actual road and traffic conditions if:

- The route is diverted
- The direction of a one-way street has been changed

For this reason, you must always observe road and traffic rules and regulations during your journey as well as the prevailing traffic conditions.

The route may differ from the ideal route due to the following:

- Roadworks

- Incomplete digital map data

### Notes on GPS reception

The correct function of the navigation system depends amongst other things on GPS reception. In certain situations GPS reception can be impaired, defective or even not possible, e.g. in tunnels or in parking garages.

### Changing direction overview

Changes of direction are shown in the following displays:

- Detailed image of the intersection  
The display appears when you drive into an intersection.
- 3D image  
The display appears when driving on intersection-free, multi-lane roads, for example on freeway exits and freeway interchanges.

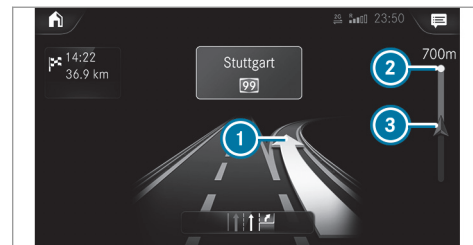

Example: 3D image of the upcoming change of direction

- ① Driving maneuver
- ② Maneuver point, above this the current distance to the change of direction
- ③ Current vehicle position

There are three phases when changing direction:

- Preparation phase

If there is enough time between the changes of direction, the multimedia system prepares you for the upcoming change of direction. A navigation announcement is issued depend-

ing on the settings for driving recommendations, e.g. "Prepare to turn right".

Select navigation announcements for driving recommendations (→ page 339).

The map appears in full-screen mode.

The status line shows: the direction information or the name of the road which is to be turned into and the distance to the change of direction.

- Announcement phase

The multimedia system announces the upcoming change of direction depending on the settings for driving recommendations, e.g. by announcing "In 600 ft (200 m) at the end of the street turn right into Station Road".

The display is split into two parts. The map is displayed on the left; on the right, there is a detailed image of the intersection or a 3D image of the upcoming change of direction.

- Change-of-direction phase

The multimedia system announces the imminent change of direction depending on the

settings for driving recommendations, e.g. by announcing "Now turn right".

The display is split into two parts.

The change of direction takes place when the distance to maneuver point ② is shown with 0 ft (0 m) and the symbol for vehicle position ③ has reached maneuver point ②.

When the change of direction is complete, the map appears in full-screen mode.

- ① Changes of direction are also shown in the Instrument Display.

### Lane recommendations overview

This display appears for multi-lane roads.

The multimedia system can show lane recommendations if the digital map contains the relevant data.

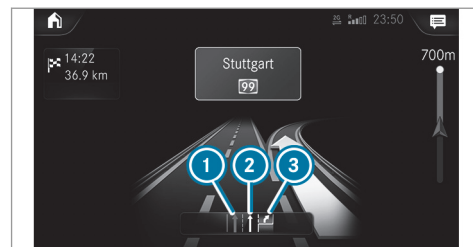

- ① Lane not recommended (gray arrow)
- ② Possible lane (white arrow)
- ③ Recommended lane (white arrow, blue background)

Explanation of the displayed lanes:

- Lane not recommended ①  
In this lane, you will not be able to complete the next change of direction without changing lane.
- Possible lane ②  
In this lane, you will only be able to complete the next change of direction.
- Recommended lane ③

In this lane, you will be able to complete both the next change of direction and the one after that.

During the change of direction, new lanes may be added.

Bus lanes are also shown.

- ① Lane recommendations can also be displayed in the Instrument Display and in the Head-up Display.

### Using freeway information Requirements:

- The [Highway Information](#) option is switched on (→ page 358).



When driving on the freeway, upcoming freeway facilities ① and available service facilities ② are shown in the overview. These include parking lots, service stations and freeway exits, for example.

- ▶ **To open the display:** select . The entries are sorted according to increasing distance from the current vehicle position.

- ▶ **To close the display:** tap on the map.

or

- ▶ **To use freeway information:** select an entry.
- ▶ If several service facilities are available, select a service facility from the list. The destination address and the map position are shown.
- ▶ Calculate the route (→ page 335).

or

- ▶ Search for a POI in the vicinity.

or

- ▶ Use other functions, e.g. save the destination address of the service facility.

### Using quick-access for a destination information, alternative route and POIs Requirements:

- The POI categories for quick-access are configured (→ page 331).
- ▶ If route guidance is active, select the symbol with arrival time and distance to the destination on the map. The address of the destination or the next intermediate destination is shown.

### Using alternative routes

- ▶ Select [Alternative Route](#). The routes are displayed in accordance with the setting made in the route settings. The routes are numbered.
- ▶ Select the alternative route.

### Setting a POI as an intermediate destination

- ▶ Select a category symbol, e.g. for a parking lot.

- ▶ Select a POI from the list. The selection takes place on the route. The destination address is shown. The route can be calculated.
- ▶ **To use POI categories for quick-access:** select a search position [In the Vicinity](#), [Near Destination](#) or [Along the Route](#).
- ▶ Select a POI from the list.

or

- ▶ Enter a search entry into the search field and filter the list.
- ▶ Select a POI from the list. The destination address is shown. The route can be calculated.

### Saving the current vehicle position

- ▶ Select [Save Position](#). The current vehicle position is saved to the "Previous destinations" memory.

### Destination reached





Once the destination is reached, you will see the  checkered flag. Route guidance is finished. The navigation menu is shown.

When an intermediate destination has been reached, you will see the intermediate destination flag with the number of your  intermediate destination. Route guidance is continued.

### Switching navigation announcements on/off

- ▶ **To switch off:** turn the volume control on the steering wheel or next to the touchpad during a navigation announcement (→ page 309). The [Voice Guidance has been deactivated](#) message appears.

or



- ▶ Show the navigation menu (→ page 326).
- ▶ Select . The symbol changes to .
- ▶ **To activate:** select . The current navigation announcement is played. The symbol changes to .

- ① This function can be added and called up from the favorites within the navigation category.

### Switching navigation announcements on or off during a phone call





- ▶ Press the  button on the steering wheel or on the touchpad.

or

- ▶ Tap on  in the media display.
- ▶ Select [Settings](#).
- ▶ Select [System](#).
- ▶ Select [Audio](#).
- ▶ Select [Navigation and Traffic Announcements](#).
- ▶ Switch [Voice Guidance During Call](#) on or off. When the option is switched on, the display button is activated.
- ▶ **To leave the menu:** select .

### Adjusting the volume of navigation announcements

Multimedia system:

- ▶   [Settings](#)  [System](#)  [Audio](#)  [Navigation and Traffic Announcements](#)
- ▶ Select [Voice Guidance Volume](#).



- ▶ Set the volume.
- ▶ **To leave the menu:** select .

### Route guidance is active

- ▶ Turn the volume control on the steering wheel or next to the touchpad during a navigation announcement.

### Switching audio fadeout on or off during navigation announcements

- ▶ Press the  button on the steering wheel or on the touchpad.
- or

- ▶ Tap on  in the media display.
- ▶ Select **Settings**.
- ▶ Select **System**.
- ▶ Select **Audio**.
- ▶ Switch **Audio Fadeout** on or off. When the option is switched on, the display button is activated.
- ▶ **To leave the menu:** select .



### Repeating navigation announcements

**Requirements:**

- A route has already been created.
- Route guidance is active.

Multimedia system:

→ **Navigation** (Navigation)

- ▶ Select .
  - ▶ Select .
- The current navigation announcement is repeated.
- ⓘ This function can be added and called up from the favorites within the navigation category.

### Canceling route guidance

**Requirements:**

- a route has already been created.
  - route guidance is active.
- ▶ Show the navigation menu.
  - ▶ Select  in the navigation menu (→ page 327).

### Overview of route guidance to an off-road destination

An off-road destination is within the digital map. The map contains no roads that lead to the destination.

You can enter geo-coordinates or a 3 word address for off-road destinations on the map. Route guidance guides you for as long as possible with navigation announcements and displays on roads that are known to the multimedia system.

Shortly before you reach the last known position on the map, you will hear the "Please follow the direction arrow" announcement, for example. The display shows a direction arrow and the linear distance to the destination.

### Overview of route guidance from an off-road location to a destination

In an off-road position, the current vehicle position is located within the digital map on roads that are not available.

The following displays appear when route guidance begins:

- A message appears that the road is not on the map.
- A direction arrow showing the linear direction to the POI.

When the vehicle is back on a road known to the multimedia system, route guidance continues as normal.

### Overview of off-road status during route guidance

Due to roadworks, for example, there may be differences between the data on the digital map and the actual course of the road. In such cases, the multimedia system will temporarily be unable to locate the vehicle's current position on the digital map. The vehicle is off-road.

When the vehicle is off-road, the following displays are shown:

- A message appears that the road is not on the map.
- A direction arrow showing the linear direction to the POI.

When the vehicle is back on a road known to the multimedia system, route guidance continues as normal.

## Destination

### Saving the current vehicle position

Multimedia system:

  **Navigation**  **Position**

- ▶ Select **Save Position**.

The current vehicle position is saved to the "Last destinations" memory.

### Using quick-access

- ▶ If route guidance is active, select the  symbol with arrival time and distance to the destination on the map. The address of the destination or the next intermediate destination is shown.
- ▶ Select **Save Position**.

### Editing the previous destinations Requirements:

- To edit destination suggestions: the [Allow Destination Suggestions](#) option is activated (→ page 303).
- The multimedia system has gathered sufficient data in order to show destination suggestions.



Multimedia system:

  **Navigation**  **Where to?**  
▶ **PREV. DESTINATIONS**

The following entries can be edited:

- Destination suggestions
- Destinations
- Routes
- ▶ **To no longer display a destination suggestion:** select  for a destination suggestion.
- ▶ Select **No Longer Suggest**.



### Saving the last destination as a favorite

- ▶  After saving, the destination can be called up via the favorites (→ page 304).
- ▶ Select  for a destination.



- ▶ Select  [Save as Favorite](#).
- ▶ **To save as a favorite:** select [Save as Favorite](#).
- ▶ **To save as "Home" address:** select [Save as "Home"](#).
- ▶ **To save as "Work" address:** select [Save as "Work"](#).

#### Deleting a previous destination

- ▶ **To delete a destination:** select  for a destination.
- ▶ Select [Delete](#).
- ▶ Select [Yes](#).
- ▶ **To delete all destinations:** select .
- ▶ Select [Delete All](#).
- ▶ Select [Yes](#).

#### Using external destinations and routes

External destinations and routes can be received from the following sources, for example:

- Mercedes-Benz Apps

- door-to-door navigation with the Companion app (USA)
- a call with the Mercedes-Benz Customer Assistance Center via the me button (→ page 387)

A prompt appears on the media display. Received destinations and routes are saved in the previous destinations.

- ▶ **A destination has been received:** select [Yes](#).
- ▶ Calculate the route.
- ▶ If route guidance is already active, select [Set as Way Point](#) or [Start New Route Guidance](#).
- or
- ▶ If a destination was received with photo information, select [Start Route Guidance](#).
- ▶ Calculate the route.
- or
- ▶ If a destination has been received from an app, select [Details](#).
- ▶ Calculate the route.
- ▶ **A route has been received:** select [Yes](#).

- ▶ Select [Start Route Guid. from Beginning of Route](#) or [Start Route Guidance from Curr. Position](#).  
Route guidance starts from the selected position.

#### Route guidance with current traffic reports

##### Traffic information overview

Traffic reports are received using Live Traffic Information and are used for route guidance.

This service is unavailable in some countries.

There may be differences between the traffic reports received and the actual road and traffic conditions.

Important information on Live Traffic Information:

- Current traffic reports are received via the Internet connection.
- The traffic situation is updated at short, regular intervals.
- The subscription information shows the status (→ page 352).

Information on the vehicle's position is regularly sent to Daimler AG. The data is immediately rendered anonymous by Daimler AG and forwarded to the traffic data provider. Using this data, traffic reports relevant to the vehicle's position are sent to the vehicle. The vehicle acts as a sensor for the flow of traffic and helps to improve the quality of the traffic reports.

If you do not wish to transmit your vehicle position, you can have this service deactivated at an authorized Mercedes-Benz Center.

#### Showing information from the service provider for Live Traffic Information Requirements:

- The vehicle is equipped with Live Traffic Information.

Multimedia system:

→  » Navigation »  » Traffic

- ▶ Select **Provider Information**.  
The logo of the service provider for Live Traffic Information is shown.

- ❗ Further information on Live Traffic Information can be called up on the home screen using **Mercedes me & Apps** (→ page 390).
- ❗ You have the following options for extending the subscription:
  - at an authorized Mercedes-Benz Center
  - with a call to the Mercedes-Benz Customer Assistance Center via the me button

#### Showing traffic information Requirements:

- The **Traffic** display is switched on (→ page 353).
- The following traffic displays are switched on (→ page 353):

Traffic Incidents  
Free Flowing Traffic  
Delay

Multimedia system:

→ 

- ▶ Select **Navigation**.

The map shows the following traffic information:

- traffic incidents, for example:
  - roadworks
  - road blocks
  - warning messages

When route guidance is active, the symbols for traffic incidents will be shown in color on the route. Off the route they are gray.

- warning message symbols:
  - Symbol 
  - road safety notes, e.g. when approaching the end of a traffic jam

If the vehicle approaches a danger area on the route, a warning message is displayed on the map. In addition, an audible notification can follow a hazard warning.

- traffic flow information:
  - traffic jam (red line)
  - slow-moving traffic (orange line)
  - heavy traffic (yellow line)
  - free-flowing traffic (green line)

- display for traffic delays on the route lasting at least one minute

### Displaying traffic incidents

#### Requirements:

- The [Traffic Incidents](#) display is switched on (→ page 353).

Multimedia system:

  **»» Navigation**  **»» Traffic**

- ▶ Select [Traffic Announcements](#).

If there are traffic reports, you will see a list. Traffic reports include accidents and other traffic events, for example. The list is sorted according to distance and shows the traffic reports received both on and off the route.

A traffic report shows the following information:

- Street number or street name
- Traffic incident symbol
  - On the route: color
  - Off the route: gray
- Cause

- Street symbol for a traffic incident on the route
- Distance from current vehicle position

- ▶ Select a traffic report . The detailed information is shown, for example the route section.

#### Showing traffic incidents in the vicinity of the map

- ▶ Select a traffic incident symbol on the map. The details about the traffic incident are displayed.

- ▶ Select .

- ▶ Select [Traffic Incidents in Vicinity](#). The map shows the traffic incident symbols in the vicinity.

Traffic incident information is displayed in the status line:

- Traffic incident symbol
- Cause of the traffic incident, e.g. construction work
- Warning message (highlighted red)

- ▶ **To select a traffic incident symbol:** select  or .

- ▶ **To select a map section:** tap on the touchscreen.

or

- ▶ Press the Touch Control or the touchpad.

- ▶ Move the map.

- ▶ **To return to the navigation map:** tap on .

or

- ▶ Press the  button on the Touch Control or on the touchpad.

#### Switching the traffic information display on

Multimedia system:

  **»» Navigation** 

- ▶ Activate [Traffic](#). The display button is activated.

#### Activating Incidents, Free Flow and Delay

- ▶ Select [Advanced](#).
- ▶ Select [View](#).
- ▶ Select [Map Elements](#).

▶ In the **TRAFFIC** category, activate the **Traffic Incidents**, **Free Flowing Traffic** and **Delay** entries.

The display buttons are activated.

If traffic information has been received, then traffic incidents such as roadworks, road blocks, local area reports (e.g. fog) and warning messages are displayed.

The traffic delay is displayed for the current route. Traffic delays lasting one minute or longer are taken into consideration.

### Showing local area messages

Multimedia system:

  **▶▶ Navigation**  **▶▶ Traffic**

▶ Select **Area Alerts**.

Local area messages are shown, for example fog or heavy rain.

▶ Select a local area message.

The details are displayed.

## Car-to-X-Communication

### Car-to-X-Communication overview

The following requirements apply for using Car-to-X-Communication:

- The vehicle is equipped with a multimedia system featuring navigation and a communication module with an activated, integrated SIM card.
- Car-to-X-Communication is activated.

 Car-to-X-Communication is available in selected countries.

The communication module automatically establishes an Internet connection once the ignition is switched on. If there are any hazard warnings, they will be provided shortly thereafter. Depending on the mobile phone connection, the provision takes place from within a second up to about a minute.

Benefits of Car-to-X-Communication:

- Hazards are recognized automatically in the background by the vehicle or may be reported by the driver. These are then sent to vehi-

cles with Car-to-X-Communication in the immediate vicinity.

- If available, current details relating to hazard spots near the vehicle's current position are received.

This gives you sufficient time to adapt your driving style to the traffic conditions.

The use of Car-to-X-Communication requires the regular transmission of vehicle data to Daimler AG. The data is then immediately pseudonymized by Daimler AG. The vehicle data is deleted after an appropriate amount of time has elapsed (several weeks) and is not stored permanently.

-  Data which serves as identification is replaced during the pseudonymization process. In this way, your identity is protected against access by unauthorized third parties.

### Displaying hazard warnings

Multimedia system:

  **▶▶ Navigation** (Navigation)

If hazard warnings are available these can be shown as symbols on the map. The display

depends on the settings for the [Traffic](#) and [Traffic Incidents](#) options.

▶ Set the options (→ page 353).

The following displays are available:

- Show all symbols

The [Traffic](#) and [Traffic Incidents](#) options are switched on.

- Only show symbols on the expected route

The [Traffic](#) option is switched off, the [Traffic Incidents](#) option is switched on.

- Show no symbols

The [Traffic Incidents](#) option is switched off.

The following hazard warnings are shown on the map:

- Broken-down vehicles
- Accidents
- Hazardous weather
- General hazards
- Hazard warning lights, when switched on
- Crosswind warning

- ① If the vehicle is approaching a hazard spot with a vehicle speed of at least 37 mph (60 km/h), the voice output "Traffic incident ahead" is issued.  
The voice output is not issued for hazardous weather.

### Sending hazard warnings

Automatically detected hazard warnings are sent by the vehicle.

- ▶ **To send a hazard warning yourself:** tap on the media display when the map is shown. The navigation menu is shown.
- ▶ Select .
- ▶ Select [Report Traffic Incident](#). A prompt is shown.
- ▶ Select [Yes](#).  
The [Thank You for Supporting Accident Prevention](#) message appears.

## Map and compass

### Setting the map scale

Multimedia system:

  ▶▶ [Navigation](#)

### Zooming in

- ▶ When the map is shown, tap twice quickly with one finger on the media display or the touchpad.

or

- ▶ Move two fingers apart on the media display or on the touchpad.

### Zooming out

- ▶ Tap with two fingers on the media display or the touchpad.

or

- ▶ Move two fingers together on the media display or on the touchpad.

- ① You can set the unit of measurement of the map scale (→ page 322).

## Moving the map

Multimedia system:

→ 🏠 ▶ Navigation

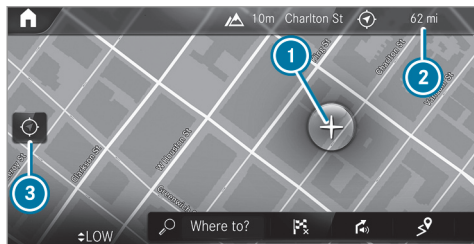

- ▶ **On the touchscreen:** move the finger in any direction when the map is shown.
- ▶ **On the touchpad:** call up the navigation menu by pressing.
- ▶ Swipe your finger up.
- ▶ Press the touchpad. Crosshair ❶ appears. The map can be moved.

- ▶ Touch the touchpad and move your finger in any direction. The map moves in the opposite direction under crosshair ❶.

When the map has been moved the following information appears in the status line, for example:

- Distance ❷ from the vehicle's current position is shown.
- Information about the current map position is shown, e.g. the name of the road.

The following functions are available:

- Select a destination on the map (→ page 334).
- Select a POI (→ page 331).
- Show traffic incidents on the map (→ page 353).
- ▶ **To reset the map to the current vehicle position:** select ❸.

## Rotating the map

- ▶ With two fingers, rotate counter-clockwise or clockwise on the media display or the touchpad.

## Selecting the map orientation

Multimedia system:

→ 🏠 ▶ Navigation ▶ ⚙️

▶ Advanced

- ▶ Select **View**.
- ▶ Select **Map Orientation**.
- ▶ Select an option.

The ● dot indicates the current setting.

The following options are available:

- **2D Heading Up** option: the 2D map view is aligned to the direction of travel.
- **2D North Up** option: the 2D map view is displayed so that north is always at the top.
- **3D** option: the 3D map view is aligned to the direction of travel.

or

- ▶ **To use quick-access:** repeatedly tap or press on the  compass symbol on the map.  
The view changes in the sequence **3D, 2D Heading Up** to **2D North Up**.  
If the map is moved, it can switch between **3D** and **2D North Up**.

### Selecting POI symbols for the map display

Multimedia system:



POIs include restaurants and hotels, for example. These can be displayed as symbols on the map. Not all POIs are available everywhere.

Personal POIs are destinations which you have saved on a USB device, for example.

- ⓘ The display of POI symbols on the map can be activated or deactivated as a favorite.

- ▶ **To switch on/off using quick-access:** if available, switch **POI Symbols** on or off.  
The POI symbols for the selected categories are shown on the map.

or

- ▶ **To switch on/off in the menu:** select **Advanced**.
- ▶ Select **View**.
- ▶ Select **Map Elements**.
- ▶ Select **POI Symbols** .  
The **POI SYMBOLS** menu is shown.
- ▶ Switch **Display POIs** on or off.



### Selecting categories

- ▶ Select  in the **POI SYMBOLS All Categories** menu.
- ▶ Switch **Show All** on or off.  
When the option is switched on, the POI symbols for all categories are shown on the map.

or

- ▶ Select the categories and sub-categories (if available) .
- ▶ Activate or deactivate the categories.  
The POI symbols for the selected categories are shown on the map.

### Selecting personal POI categories

- ▶ Select  in the **POI SYMBOLS Personal POIs** menu.
- ▶ Select a category .
- ▶ Switch **Show on Map** on or off.  
When the display is switched on and the vehicle approaches a personal POI in this category, a visual and audible notification can be issued.
- ▶ **To set a notification when approaching:** select a category or a personal POI .
- ▶ Switch **Visual Notification** and **Acoustic Notification** on or off.

### Switching display of categories for quick-access on/off

- ▶ Switch a category on or off in the **POI SYMBOLS** menu.

### Resetting the POI symbol display

- ▶ Select **POI SYMBOLS Reset POIs** in the menu.  
The settings are reset to the standard settings.

### Selecting the display of text information in the map

Multimedia system:



» Advanced

▶ Select **View**.

▶ Select **Text Information**.

▶ Select an option in the **FOOTER** category. The • dot indicates the current setting.

The following options are available:

- **Current Street** option

The street you are currently on is shown in the bottom bar.

When the map is moved, the street name, the POI name or the area name appears under the crosshair.

- The **Geo-coordinates** option shows the following information in the bottom bar:

- longitude and latitude
- elevation

The elevation shown may deviate from the actual elevation.

- **None** option

The media display shows no text information in the bottom bar.

### Switching freeway information on/off

Multimedia system:



▶ **Using quick-access:** switch **Highway Information** on or off.

The display button is activated or off.

or

▶ **Using the menu:** select **Advanced**.

▶ Select **View**.

▶ Select **Text Information**.

▶ Switch **Highway Information** on or off. When the display button is switched on, additional information about the freeway facilities ahead appears during the freeway journey. These include parking lots, service stations and freeway exits, for example.

### Displaying the next intersecting street Requirements:

- Route guidance is not active.

Multimedia system:



» Advanced

▶ Select **View**.

▶ Select **Text Information**.

▶ Activate **Next Intersecting Street**.

The display button is activated. If the option is switched on and the journey continues without route guidance, the name of the next intersecting street will be displayed at the upper edge of the display.

### Displaying the map version

Multimedia system:



» Advanced

▶ Select **View**.

▶ Select **Map Version**.

The detail information is displayed.

**i** The online map update service from Mercedes me connect can be used to update the map data (→ page 360).



A message is shown in the media display when a new map version is available.

- Information about new versions of the digital map can be obtained from an authorized Mercedes-Benz Center.

### Overview of avoiding an area for the route

You can define areas along a route that you would like to avoid.

Highways or multi-lane highways, which are routed through an area to be avoided are taken into account for the route.

### Avoiding a new area for the route

Multimedia system:



- Advanced
- Route
- Avoid Options
- Avoid Areas

- Select **Avoid New Area**.
- To start in the map:** select **Using Map**.
- Move the map (→ page 356).
- To start via destination search:** select **Via Address Entry**.

- Enter the address (→ page 328).
- Select the destination in the list or accept with **OK**.  
The map appears.
- To show an area:** tap or press on the control element.  
A red rectangle appears. This designates the area that should be avoided.
- To change the map scale:** move two fingers apart or together on the media display or on the touchpad.  
The map is zoomed in or out.
- To set an area:** select **OK**.  
The **Avoid area has been set.** message appears. The area is entered into the list.

### Changing an area to be avoided

Multimedia system:



- Advanced
- Route
- Avoid Options
- Avoid Areas

- Select an area in the list.
- Select **Edit**.

- To move an area on the map:** swipe in any direction on the control element.
- To change the size of the area:** tap or press on the control element.
- Swipe up or down on the control element.
- Select **OK**.  
The **Avoid area has been set.** message appears. The area is entered into the list.
- To take account of an area for the route:** select an area from the list.
- Activate **Avoid Area**.  
The display button is activated.  
If route guidance is active, a new route is calculated.
- If there is no route yet, the setting is carried over to the next route guidance.  
The route can include an area that is to be avoided in the following cases:
  - the destination is located in an area that is to be avoided.
  - the route includes highways or multi-lane expressways which pass through an area to be avoided.

- there is no sensible alternative route.

### Deleting an area

Multimedia system:

→  >> Navigation >>   
>> Advanced >> Route >> Avoid Options  
>> Avoid Areas

- ▶ **To delete an area:** select an area in the list.
- ▶ Select **Delete**.
- ▶ Confirm the prompt with **Yes**.
- ▶ **To delete all areas:** if at least two areas to avoid are set, select **Delete All**.
- ▶ Confirm the prompt with **Yes**.

### Map data update overview

#### Updating at the authorized Mercedes-Benz Center

The digital maps generated by the map software become outdated in the same way as conventional road maps. Optimal route guidance can only be provided by the navigation system in conjunction with the most up-to-date map data. Information about new versions of the digital

map can be obtained from an authorized Mercedes-Benz Center.

You can receive updates to the digital map there.

#### Online map update

The online map update service from Mercedes me connect can be used to update the map data.

- ⓘ The online map update service is not available in all countries.

The following options are available for the update:

- for one region (automatic map update)  
For automatic map updates the **Automatic Online Update** system setting must be activated (→ page 325).
- for several or all regions (manual map update)

The map data will first be downloaded onto a storage medium and then updated on the multimedia system.

Further information on online map updates is available here:

- at any authorized Mercedes-Benz Center
- at: <http://www.mercedes.me>

Further information on updates can be found at: [http://manuals.daimler.com/baix/cars/connectme/en\\_GB/index.html](http://manuals.daimler.com/baix/cars/connectme/en_GB/index.html).

#### Overview of map data

Your vehicle is supplied with map data at the factory. Depending on the country, map data for your region is either pre-installed or the map data is supplied on a data storage medium.

If the map data on your vehicle has been installed at the factory and you wish to reinstall it, you do not need to enter the activation code.

For map data that you have purchased in the form of a data storage medium, you must enter the accompanying activation code.

- ⓘ If you save the map data on a data storage medium with the online map update service, no entry is required. The activation code is stored on the data storage medium during the downloading process.

Observe the following when entering the activation code:

- The activation code can be used for one vehicle
- The activation code is not transferable
- The activation code has six digits

In the event of the following problems, please contact an authorized Mercedes-Benz Center:

- The multimedia system does not accept the activation code
- You have lost the activation code

### Displaying the compass

Multimedia system:

 **Navigation**  **Position**

- ▶ Select **Compass**.

The compass display shows the following information:

- The current direction of travel with bearing (360° format) and compass direction
- Longitude and latitude coordinates in degrees, minutes and seconds

- Height (rounded)
- Number of satellites from which a signal can be received

### Setting the map scale automatically

Multimedia system:

 **Navigation** 

▶ **Advanced**

- ▶ Select **View**.
- ▶ Select **Map Orientation**.
- ▶ Activate **Auto Zoom**.

The display button is activated. The map scale is set automatically depending on your driving speed and the type of road.

- ⓘ The automatically selected map scale can be changed manually. After a few seconds, this is automatically reset.

### Displaying the satellite map

Multimedia system:

 **Navigation** 

▶ **Advanced**

- ▶ Select **View**.

- ▶ Select **Map Elements**.

- ▶ Switch **Satellite Map** on or off.

If the display button is activated, satellite maps are displayed in map scales from 2 mi (2 km).

If the display button is deactivated, satellite maps are not displayed in map scales from 2 mi (2 km) to 20 mi (20 km).

- ⓘ The satellite maps for these map scales are not available in all countries.

### Displaying the range

**Requirements:**

- The multimedia system supports the function.

Multimedia system:

 **Navigation** 

▶ **Advanced**

- ▶ Select **View**.
- ▶ Select **Map Elements**.
- ▶ Activate **Range**.  
The display button is activated.

The range is shown on the map with the following displays:

- For gasoline and diesel vehicles: green display

When the lower reserve capacity is reached then the range display on the map is switched off.

 The range display on the map is not available in all countries.

### Displaying weather information and other map contents

#### Requirements:

- Mercedes me connect is available.
- You have a user account for the Mercedes me portal.
- The service is available.
- The service has been activated at an authorized Mercedes-Benz Center.

Multimedia system:

   Navigation 

 Advanced

 Select View.

 Select **Map Elements**.

 Scroll up and show the **ONLINE MAP CONTENT** category.

The available services are displayed. The services are provided by Mercedes me connect.

 Switch on a service, e.g. **Weather**.

Current weather information is displayed on the navigation map, e.g. temperature or cloud cover. The service information is not shown in all map scales, e.g. weather symbols.

Further information about available services and about displaying information in the map scales can be found in the Mercedes me Portal: <https://me.secure.mercedes-benz.com>

### Showing map view in the multifunction display of the instrument cluster

Multimedia system:

   Navigation 

 Advanced

 Select View.

 Select **Map Orientation**.

 Scroll up and show the **INSTRUMENT CLUSTER VIEW** category.

 **To set the map scale automatically:** switch on **Auto Zoom**.

The display button is activated. The map scale is set automatically depending on your driving speed and the type of road.

 **To select map orientation:** select an option. The **•** dot indicates the current selection.

The following options are available:

- **2D Heading Up** option: the 2D map view is aligned to the direction of travel.
- **2D North Up** option: the 2D map view is displayed so that north is always at the top.
- **3D** option: the 3D map view is aligned to the direction of travel.

## Parking service

### Notes on the parking service

**⚠ WARNING** Risk of accident and injury due to not observing the maximum permitted access height

If the vehicle height exceeds the maximum permitted access height for parking garages and underground parking lots, the vehicle roof as well as other vehicle parts could be damaged.

There could be a risk of injury to the vehicle occupants.

- ▶ Before driving into a parking garage or underground parking lot observe the locally signposted access height.
- ▶ If the vehicle height, including any additional equipment, exceeds the maximum permitted access height, do not drive into the parking garage or underground parking lot.

This service is not available in all countries.

### Selecting parking options

**!** **NOTE** Before selecting the parking option

The data is based on information provided by the respective service provider.

Mercedes Benz accepts no liability for the accuracy of the information provided relating to the parking garage/parking lot.

- ▶ Always observe the local Information and conditions.

#### Requirements:

- The navigation services option is available, subscribed to and activated in the Mercedes me portal.
- The parking service is within the scope of the navigation service.
- [Parking](#) is activated (→ page 364).

Multimedia system:

→  ▶ [Navigation](#)

- ▶ Tap on  in the map.

Select a parking option.  
The map shows the parking options in the vicinity.

The following information is displayed (if available):

- Destination address, distance from current vehicle position and arrival time
- Information on the parking garage/parking lot

For example, opening times, parking charges, current occupancy, maximum parking time, **maximum access height**.

The maximum access height shown by the parking service does not replace the need for observation of the actual circumstances.

- Available payment options (Mercedes pay, coins, bank notes, cards)
- Details on parking tariffs
- Number of available parking spaces
- Payment method (e.g. at the parking machine)
- Services/facilities at the parking option

- Telephone number
- ▶ Calculate the route (→ page 335).

The following functions can also be selected (if available):

- Search for POIs in the vicinity.
- Save the destination.
- Place a call at the destination.
- Share the destination using NFC or QR code.
- Call up the web address.
- Show the destination on the map.

### Displaying parking options on the map Requirements:

- The navigation services option is available, subscribed to and activated in the Mercedes me portal.
- The parking service is within the scope of the navigation service.

Multimedia system:



### ▶ Activate Parking.

The display button is activated. The parking options within the vicinity of the current vehicle position are shown.

## Dashcam

### Notes on the dashcam

#### ! NOTE Before using the dashcam

You are legally responsible for operation and use of the dashcam functions. The legal requirements relating to operation and use of the dashcam can vary depending on the country in which the dashcam is operated. Therefore, observe the legal requirements, in particular the data protection regulations, in your country.

For this reason, before using the dashcam inform yourself about the regulation details for the respective country.

This function is not permitted in all countries.

- ▶ Observe the country-specific regulations.

The dashcam is available in the navigation system in combination with the augmented reality function.

### Selecting a USB device for a video recording with the dashcam

#### Requirements:

- At least one USB device is connected with the multimedia system (→ page 405).

Multimedia system:



- ▶ Select the USB device.

### Starting/stopping video recording with the dashcam

#### Requirements:

- A USB device is connected with the multimedia system (→ page 405).
- The ignition is switched on.

Multimedia system:

→  ► Mercedes me & Apps  
► Dashcam

- If several USB devices are connected with the multimedia system, select the USB device (→ page 364).
- Select the **Individual Recording** or **Loop Recording** recording mode.  
If **Individual Recording** is selected and the memory is full the recording stops. An individual recording is automatically protected against being overwritten.  
If **Loop Recording** has been selected, several short video files are recorded. When the memory limit is reached, the oldest video file is deleted and recording is continued automatically.
- **To start:** select **Start Recording**.  
The length of the recording is shown. The **Please do not remove the storage medium** message appears. The video file is stored on the USB device.
- **To end:** select **End Recording**.

A report may appear in the following cases:

- For the **Individual Recording** recording mode: the memory is full or there are only a few minutes recording time available. The video recording stops or will be stopped imminently.  
Change the USB device or delete a video file.
- If a video recording has started and a national border is detected, the **National Border Crossed. Please observe the country-specific regulations on video recording** message appears.  
This function is not available in all countries.
- The camera is not functional, the **Camera Unavailable** message appears.  
Have the camera checked at an authorized Mercedes-Benz Center.

#### Deleting a dashcam video recording Requirements:



- A USB device with video recordings is connected with the multimedia system (→ page 405).

- ① You are legally responsible for operation and use of the dashcam functions. The legal requirements relating to operation and use of the dashcam can vary depending on the country in which the dashcam is operated. Therefore, observe the legal requirements, in particular the data protection regulations, in your country.  
For this reason, before using the dashcam inform yourself about the regulation details for the respective country.

This function is not permitted in all countries.

Multimedia system:

→  ► Mercedes me & Apps  
► Dashcam

- Select the  symbol.  
The **RECORDINGS** menu appears.
- Select  for a video file.
- Select **Delete**.
- Select **Yes**.
- **To delete all video files:** select .
- Select **Delete All Entries**.

## Configuring dashcam settings

### Requirements:

- A USB device is connected with the multimedia system (→ page 405).

Multimedia system:

→  → Mercedes me & Apps

→ Dashcam

▶ Select .

▶ **To show messages after passing a national border:** switch on [National Borders Alert](#).

The display button is activated.

A message appears in the following situations:

- A video is being recorded.
- The vehicle has passed a national border.

 This function is not available in all countries.

▶ **To start automatic video recording:** select [Automatic Video Recording](#).

▶ Activate [Automatic Video Recording](#).  
The display button is activated. When the vehicle is started, video recording starts automatically.

 This function is not available in all countries.

## Telephone

### Telephony

#### Notes on telephony

 **WARNING** Risk of distraction from operating integrated communication equipment while the vehicle is in motion

If you operate communication equipment integrated in the vehicle when driving, you will be distracted from the traffic situation. This could also cause you to lose control of the vehicle.

- ▶ Only operate this equipment when the traffic situation permits.
- ▶ If you cannot be sure of this, stop the vehicle whilst paying attention to road

and traffic conditions and operate the equipment with the vehicle stationary.

 **WARNING** Risk of an accident from operating mobile communication equipment while the vehicle is in motion

Mobile communications devices distract the driver from the traffic situation. This could also cause the driver to lose control of the vehicle.

- ▶ As the driver, only operate mobile communications devices when the vehicle is stationary.
- ▶ As a vehicle occupant, only use mobile communications devices in the areas intended for this purpose, e.g. in the rear passenger compartment.

You must observe the legal requirements for the country in which you are currently driving when operating mobile communication equipment in the vehicle.



**▲ WARNING** Risk of injury due to objects being stowed incorrectly

If objects in the vehicle interior are stowed incorrectly, they can slide or be thrown around and hit vehicle occupants. In addition, cup holders, open stowage spaces and mobile phone receptacles cannot always retain all objects they contain.

There is a risk of injury, particularly in the event of sudden braking or a sudden change in direction.

- ▶ Always stow objects so that they cannot be thrown around in such situations.
- ▶ Always make sure that objects do not protrude from stowage spaces, luggage nets or stowage nets.
- ▶ Close the lockable stowage spaces before starting a journey.
- ▶ Always stow and secure heavy, hard, pointed, sharp-edged, fragile or bulky objects in the trunk/load compartment.

Observe the additional information on stowing mobile communications devices correctly:

- Loading the vehicle (→ page 106)
- Further information can be obtained from an authorized Mercedes-Benz Center or at: <http://www.mercedes-benz.com/connect>.

### Telephone menu overview

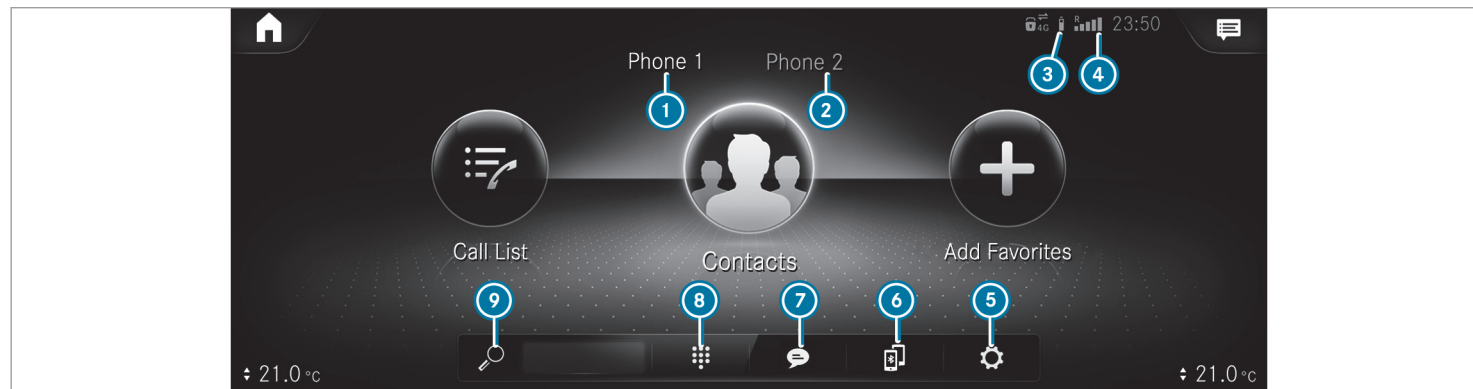

- ❶ Bluetooth® device name of the currently connected mobile phone/of the mobile phone
- ❷ Bluetooth® device name of the currently connected mobile phone/of the mobile phone (two phone mode)
- ❸ Battery status of the connected mobile phone

- ❹ Signal strength of the mobile phone network
- ❺ Options
- ❻ Device manager
- ❼ Messages
- ❽ Numerical pad
- ❾ Contact search

### Bluetooth® profile overview

| Bluetooth® profile of the mobile phone | Function  |
|--|---|
| PBAP (Phone Book Access Profile)       | Contacts are automatically displayed in the multimedia system |

| Bluetooth® profile of the mobile phone | Function                      |
|--|-------------------------------|
| MAP (Message Access Profile)           | Message functions can be used |

### Telephony operating modes overview

Depending on your equipment, the following telephony operating modes are available:

- A mobile phone is connected to the multimedia system via Bluetooth® (→ page 369).
- Two mobile phones are connected with the multimedia system via Bluetooth® (two phone mode) (→ page 370).
  - You can use all the functions of the multimedia system with the mobile phone in the foreground.
  - You can receive incoming calls and messages with the mobile phone in the background.

You can interchange the mobile phone in the foreground and background any time (→ page 370).

 Irrespective of this, Bluetooth® audio functionality can be used with any mobile phone (→ page 405).

### Information on telephony

The following situations can lead to the call being disconnected while the vehicle is in motion:

- there is insufficient network coverage in the area
- you move from one transmission/reception station to another and no communication channels are free
- the SIM card used is not compatible with the network available
- a mobile phone with "Twincard" is logged into the network with the second SIM card at the same time

The multimedia system supports calls in HD Voice® for improved speech quality. A requirement for this is that the mobile phone and the mobile phone network provider of the person you are calling support HD Voice®.

Depending on the quality of the connection, the voice quality may fluctuate.

### Connecting a mobile phone Requirements:

- Bluetooth® is activated on the mobile phone (see the manufacturer's operating instructions).
- Bluetooth® is activated on the multimedia system (→ page 319).

Multimedia system:

  **Phone**

### Searching for a mobile phone

- ▶ Select .
- ▶ Select **Connect New Device**.

### Connecting a mobile phone (authorization using Secure Simple Pairing)

- ▶ Select a mobile phone.
- ▶ A code is displayed in the multimedia system and on the mobile phone.
- ▶ **If the codes match:** confirm the code on the mobile phone.

- ❶ For older mobile phone models, enter a one to sixteen-digit number code on the mobile phone and on the multimedia system for authorization.
- ❷ Up to 15 mobile phones can be authorized on the multimedia system. Authorized mobile phones are reconnected automatically.
- ❸ The connected mobile phone can also be used as Bluetooth® audio equipment (→ page 405).

### Connecting a second mobile phone (two phone mode)

#### Requirements:

- At least one mobile phone is already connected to the multimedia system via Bluetooth®.

Multimedia system:



- ▶ Select .
- ▶ Select **Connect New Device**.
- ▶ Select the mobile phone.

- ▶ Select **Device name 1 + Device name 2**.  
The selected mobile phone is connected to the multimedia system.

### Functions of the mobile phone in two phone mode

#### Functions overview

| Mobile phone in the foreground | Mobile phone in the background |
|--------------------------------|--------------------------------|
| Full range of functions        | Incoming calls and messages    |

### Interchanging mobile phones (two phone mode)

Multimedia system:



Both mobile phones are shown individually in separate tabs.

- ▶ Select the tab with the desired mobile phone.  
The mobile phone in the selected tab is the mobile phone in the foreground.

With the exception of telephone settings, the submenus in the telephone menu relate to the mobile phone in the foreground. In the telephone settings, settings can be made for both mobile phones.

### Changing the function of a mobile phone Requirements:

- At least one mobile phone is connected to the multimedia system via Bluetooth® (→ page 369).

Multimedia system:



### Activating a function

- ▶ Select the  device manager.
- ▶ Select a gray symbol in the line of a mobile phone.  
The corresponding function is activated.

### Deactivating a function

- ▶ Select the  device manager.

- ▶ **One function is active:** select the color symbol in the line of a mobile phone. The mobile phone is disconnected from the multimedia system.
- ▶ **Several functions are active:** select a color symbol in the line of a mobile phone. The corresponding function is deactivated.

### Replacing mobile phones

Multimedia system:



- ▶ Select .
- ▶ **No authorized mobile phone available:** select [Connect New Device](#).
- ▶ Select a mobile phone.
- ▶ **Newly authorized mobile phone:** confirm the number code on the mobile phone.

### Using in single telephone mode

- ▶ Select [Device name](#).  
A newly authorized mobile phone is connected in single telephone mode.  
If the mobile phone has already been authorized and connected in single telephone

mode, it is connected again in single telephone mode.

If a mobile phone has already been authorized and connected in two phone mode with another mobile phone, it will be connected in future in single telephone mode.



### Using in two phone mode

- ▶ Select [Device name 1 + Device name 2](#).  
A newly authorized mobile phone is connected with the selected mobile phone in two phone mode.  
If the mobile phone has already been authorized and connected in single telephone mode, it will be connected in future with the selected mobile phone in two phone mode.  
If the mobile phone was previously connected with another mobile phone, this connection is canceled.

### Disconnecting/de-authorizing a mobile phone

Multimedia system:



- ▶ Select .
- ▶ Select  in the line of the mobile phone.
- ▶ **To disconnect:** select [Disconnect](#).  
If applicable, the mobile phone will be automatically reconnected when the vehicle is next started.
- ▶ **To de-authorize:** select [Deauthorize](#).

### Information on Near Field Communication (NFC)

NFC enables short-range wireless data transfer or (re)connection of a mobile phone with the multimedia system.

The following functions are available without having authorized a mobile phone:

- Transferring a URL or a contact to be viewed in the multimedia system (see the manufacturer's operating instructions).
- Setting up the vehicle's Wi-Fi access data via the system settings (→ page 321).

Further information can be obtained at: <http://www.mercedes-benz.com/connect>

### Setting the reception and transmission volume

#### Requirements:

- A mobile phone is connected (→ page 369).

Multimedia system:



This function ensures optimal language quality.

- ① Please note that the respective mobile phone must be selected for adjustment of the reception and transmission volume.
- ▶ Select **Volume**.
- ▶ Set the reception and transmission volume using **Reception** and **Transmission**.

Further information on the recommended reception and transmission volume: <http://www.mercedes-benz.com/connect>

### Setting the ringtone

Multimedia system:



- ▶ Select **Ringtones**.
- ▶ Set the ringtone.
- ① If the mobile phone supports the transfer of the ringtone, you will hear the ringtone of the mobile phone instead of that of the vehicle audio system.

### Starting/stopping mobile phone voice recognition



#### Requirements:

- The mobile phone in the foreground is connected with the multimedia system (→ page 369).

### Starting mobile phone voice recognition

- ▶ Press and hold the  button on the multifunction steering wheel for more than one second.  
You can use mobile phone voice recognition.

### Stopping mobile phone voice recognition

- ▶ Press the  or  button on the multifunction steering wheel.
- ① If a mobile phone is connected via Smartphone Integration, the voice recognition of this mobile phone is started or stopped.



## Calls

### Using the telephone

Multimedia system:



### Making a call by entering the numbers

- ▶ Select .
- ▶ Enter a number.
- ▶ Select .  
The call is made.

### Accepting a call

- ▶ Select  **Accept**.

### Rejecting a call





- ▶ Select  **Reject**.

### Ending a call

- ▶ Select .

### Activating functions during a call

The following functions are available during a call:

-  **End Call**
-  **Microphone Off**
-  **Numeric Keypad** (show to send DTMF tones)
-  **Add Call**
-  **Transfer to Phone** (an active call in hands-free mode is transferred over to the telephone)

- ▶ Select a function.

### Conducting calls with several participants Requirements:

- There is an active call (→ page 372).
- Another call is being made.

### Switching between calls

- ▶ Select the contact.  
The selected call is active. The other call is on hold.

### Activating a call on hold

- ▶ Select the contact of the call on hold.

### Conducting a conference call

- ▶ Select  **Create Confer. Call**.  
The new participant is included in the conference call.

### Ending an active call

- ▶ Select  **End Call**.
- ⓘ On some mobile phones, the call on hold is activated as soon as the active call is ended.

### Accepting/rejecting a waiting call Requirements:

- There is an active call (→ page 372).

If you receive a call while already in a call, a message is displayed.

Depending on the mobile phone and mobile network operator you will hear a call-waiting sound.

In addition, in two phone mode you will hear an acoustic signal when the call goes through to the other (not yet active) mobile phone.

- ▶ Select  **Accept**.  
The incoming call is active.

If only one mobile phone is connected with the multimedia system, the previous call will be put on hold.

If during a call you accept a call with the other mobile phone when in two phone mode then the existing call is ended.

- ▶ Select  **Reject**.
- ⓘ This function and behavior depends on your mobile phone network provider and the mobile phone (see the manufacturer's operating instructions).

## Contacts

### Information about the contacts menu

The contacts menu contains all contacts from existing data sources, e.g. mobile phone or data storage medium.

Depending on the data source, it is possible to save/load the following number of contacts:

- Permanently saved contacts: 3,000 entries
- Contacts loaded from the mobile phone: 5,000 entries per mobile phone

From the contacts menu, you can perform the following actions:

- Make a call, for example call a contact (→ page 375)
- Navigation (→ page 333)
- Compose messages (→ page 379)
- Additional options (→ page 376)

If a mobile phone is connected to the multimedia system (→ page 369) and automatic calling up (→ page 374) is activated, the mobile phone's contacts are displayed in the address book.

The multimedia system can show suggestions based on frequently used contacts as well as incoming and outgoing calls (→ page 303). These are shown at the top of the contact list.

### Downloading mobile phone contacts

Multimedia system:

→  >> Phone >> <device name>  
 >> 

- ▶ Select **Contacts & Recent Calls**.

### Automatically

- ▶ If the **Synchronize Contacts Automatically** function is not active: activate the function by pressing once.

### Manually

- ▶ If the **Synchronize Contacts Automatically** function is active: deactivate the function by pressing once.
- ▶ Select **Synchronize Contacts**.

You can see from the status of controller to the right of the **Synchronize Contacts Automatically** display text whether the function is active.

### Calling up contacts

Multimedia system:

→  >> Phone >> 

The following options can be used to search for contacts:

- searching by initials
- searching by name
- searching by phone number

- ▶ Enter characters into the search field.
- ▶ Select the contact.

A contact can contain the following details:

- phone numbers
- navigation addresses
- geo-coordinates
- Internet address
- e-mail addresses
- voice tag (if set)
- relation (if set)



## Editing the format of a contact's name

Multimedia system:



- ▶ Select **General**.
- ▶ Select **Name Format**.

The following options are available:

- **Last Name, First Name**
  - **Last Name First Name**
  - **First Name Last Name**
- ▶ Select an option.

## Overview of importing contacts

### Contacts from various sources

| Source                | Requirements  |
|-----------------------|---|
| USB device            | The USB device is connected with the USB port.  |
| Bluetooth® connection | <p>If the sending of vCards via Bluetooth® is supported, vCards can be received on mobile phones or notebooks, for example.</p> <p>Bluetooth® is activated in the multimedia system and on the respective device (see the manufacturer's operating instructions).</p> |

## Importing contacts into the contacts menu

Multimedia system:



- ▶ Select a mobile phone <device name>, from which the contacts should be imported.
- ▶ Select an option.

### Saving a mobile phone contact

Multimedia system:



- ▶ Select in the line of the mobile phone contact.
- ▶ Select .
- ▶ Select **Save to Vehicle**.
- ▶ Select **Yes**.  
The contact saved in the multimedia system is identified by the symbol.

### Calling a contact

Multimedia system:



- ▶ Select **Search for Contacts**.

- ▶ Enter characters into the search field.
- ▶ Select the contact.
- ▶ Select the telephone number.  
The number is dialed.

### Selecting further options in the contacts menu

Multimedia system:



- ▶ Select in the line of the contact.
- ▶ Select .

Depending on the stored data, the following options are available:

- [Add Voice Tag/Delete Voice Tag](#)
- [Set Relationship/Delete Relationship](#)
- [Send DTMF Tones](#) (for a number with DTMF tones)  
The function is available when a call is active.
- ▶ Select an option.

### Selecting options for suggestions in the contacts menu

#### Requirements:

- A profile has been created (→ page 298).
- The [Allow Contact Suggestions](#) setting is switched on (→ page 303).

Multimedia system:



- ▶ Select [Recent Calls](#).
- ▶ Select in the line of a suggested contact.

The following options are available:

- [Save as Favorite](#)  
The suggestions are saved as global favorites and do not appear on the home screen.
- [No Longer Suggest](#)
- ▶ Select an option.

### Deleting contacts

#### Requirements:

- The contacts are saved in the vehicle.

- To delete an individual contact, this has been imported manually into the vehicle.

Multimedia system:



### Deleting all contacts

- ▶ Select .
- ▶ Select [General](#).
- ▶ Select [Delete Contacts](#).
- ▶ Select an option.

### Deleting a contact

- ▶ Select .
- ▶ Select in the line of the contact.
- ▶ Select .
- ▶ Select [Delete Contact](#).
- ▶ Select [Yes](#).

### Saving a contact as a favorite

Multimedia system:



- ▶ Select a contact.

- ▶ Select  in the line of the contact.
- ▶ Select the telephone number.  
The contact is stored as a favorite in the telephone menu overview.



### Deleting favorites in the telephone menu overview

Multimedia system:



- ▶ Select a favorite in the telephone menu overview (→ page 376).
- ▶ Press and hold the favorite.
- ▶ Select **Delete**.
- ▶ Select **Yes**.

### Deleting all favorites

- ▶ Tap on  in the media display.
- ▶ Select **Phone**.
- ▶ Select .
- ▶ Select the connected telephone.
- ▶ Select **Contacts & Recent Calls**.

- ▶ Select **Delete All Favorites**.  
A pop-up window appears: **Do you want to delete all favorites?**
- ▶ Select **Yes**.

### Call list

#### Overview of the call list

Depending on whether your mobile phone supports the PBAP Bluetooth® profile or not, this can have different effects on the presentation and functions of the call list.

If the PBAP Bluetooth® profile is supported, the effects are as follows:

- The call lists from the mobile phone are displayed in the multimedia system.
- When connecting the mobile phone, you may have to confirm the connection for the PBAP Bluetooth® profile.

If the PBAP Bluetooth® profile is not supported, the effects are as follows:

- The multimedia system generates a call list independently as soon as calls are made in the vehicle.
- The call list is not synchronized with the call lists in the mobile phone.

The multimedia system can show suggestions based on frequently used contacts as well as incoming and outgoing calls (→ page 303). These are shown at the top of the call list.

#### Making a call from the call list

Multimedia system:





- ▶ Select  **Recent Calls**.
- ▶ Select an entry.  
The call is made.

#### Calling up additional options in the call list

Multimedia system:



- ▶ Select  **Recent Calls**.

- ▶ For previously stored contacts: select  in the line of an entry. The search results are displayed.
- ▶ For contacts who have not been stored: select .



### Selecting options for suggestions in the call list

#### Requirements:

- A profile has been created (→ page 298).
- The [Allow Contact Suggestions](#) setting is switched on (→ page 303).

Multimedia system:

  ▶ Phone

- ▶ Select  [Recent Calls](#).
- ▶ Select  in the line of a suggested entry. The following options are available:
  - [Save as Favorite](#)
  - [No Longer Suggest](#)
- ▶ Select an option.

### Deleting the call list

Multimedia system:

  ▶ Phone ▶ <device name>

▶ 

- ▶ Select [Contacts & Recent Calls](#).
- ▶ Select [Delete Recent Calls](#).
- ▶ Select [Yes](#).

 This function is only available if your mobile does not support the PBAP Bluetooth® profile.

### Text messages

#### Overview of message functions

In the messages menu you can receive and send text messages.

If the connected mobile phone supports the Bluetooth® MAP profile, the message function can be used on the multimedia system.

You can obtain further information about settings and supported functions of Bluetooth®-capable mobile phones from an authorized

Mercedes-Benz Center or at: <http://www.mercedes-benz.com/connect>

Some mobile phones require further settings after being connected to the multimedia system (see manufacturer's operating instructions).

### Setting message displays

Multimedia system:

  ▶ Phone ▶ <device name>

▶ 

- ▶ Select [Message Display](#).

The following options are available:

- [All Messages](#)
- [New and Unread Messages](#)
- [Messages While Driving](#)
- [Off](#) (the message function is no longer available.)

- ▶ Select a setting.

### Reading messages

Multimedia system:

-  ➤ Phone ➤ <device name>
- 

### Using the read-aloud function

- ▶ Select a contact.
- ▶ Select  to read aloud.  
The message is read aloud.

### Dictating and sending a new message

**Requirements:**

- There is an Internet connection.

Multimedia system:

-  ➤ Phone ➤ <device name>
- 

- ▶ Select a new message using .

### Adding a recipient

- ▶ Select .
- ▶ Select a contact.

### Dictating text

- ▶ Select .  
The dictating function is started.
- ▶ Say the message.  
After the voice message has been processed, it is shown as text.

### Sending a message

- ▶ Select **Send**.
- ⓘ When the vehicle is stationary you can use the keyboard to write a message. No Internet connection is required to use the keyboard.

### Replying to a message in the messaging history

Multimedia system:

-  ➤ Phone ➤ <device name>
- 

A message list is shown.

- ▶ Select  next to a contact.  
The messaging history with this contact is shown.



- ▶ Select .  
The dictating function is started.
- ▶ Say the message.  
After the voice message has been processed, it is shown as text.
- ▶ Select **Send**.

### Using message templates



Multimedia system:

-  ➤ Phone ➤ <device name>
- 

### Using a template as a new message

- ▶ Select  to write a new message.
- ▶ Add a recipient using .
- ▶ Select a  template.

### Answering a message with a template

- ▶ Select a message sequence with a contact.
- ▶ Select a  template.
- ▶ Select a  template.

### Forwarding a message

Multimedia system:



A message list is shown.

- ▶ Select next to a contact. The messaging history with this contact is shown.
- ▶ Press and hold on a message.
- ▶ **To forward a message:** select [Forward](#).

### Calling a message sender

Multimedia system:



A message list is shown.

- ▶ Select next to a contact. The messaging history with this contact is shown.
- ▶ Select .
- ▶ Select [Call](#).

### Using telephone numbers or URLs from a text message

Requirements:

- An Internet connection is available to call up a URL.

Multimedia system:



A message list is shown.

- ▶ Select next to a contact. The messaging history with this contact is shown.
- ▶ Select a telephone number or a URL in the message. If a URL is selected the web browser opens. If a telephone number is selected the following options are available:
  - [Call](#)
  - [New Message](#)
- ▶ Select an option.

### Deleting a message

Multimedia system:



- ▶ Select a contact.
- ▶ Press and hold on a message.
- ▶ **To delete the message:** select [Delete](#).

### Mercedes-Benz link

#### Overview of Mercedes-Benz Link

**⚠ WARNING** Risk of distraction from information systems and communications equipment

If you operate information and communication equipment integrated in the vehicle when driving, you will be distracted from the traffic situation. This could also cause you to lose control of the vehicle.

- ▶ Only operate this equipment when the traffic situation permits.

▶ If you cannot be sure of this, stop the vehicle whilst paying attention to road and traffic conditions and operate the equipment with the vehicle stationary.

You must observe the legal requirements for the country in which you are currently driving when operating the multimedia system.

With Mercedes-Benz Link you can use mobile phone functions via the multimedia system. It is operated using the touchscreen or the voice-operated control system. You can activate the voice-operated control system by pressing and holding the  button on the multifunction steering wheel.

When using Mercedes-Benz Link via the voice-operated control system, the multimedia system can still be operated via the Voice Control System (→ page 266).

The Mercedes-Benz Link control box supplementary equipment is required for this. This is available at an authorized Mercedes-Benz Center.

Only one mobile phone at a time can be connected via Mercedes-Benz Link to the multimedia system.

When a mobile phone is connected with Mercedes-Benz Link, only one additional mobile phone can be connected using Bluetooth® with the multimedia system when in two phone mode.

- ❶ The Mercedes-Benz Link control box uses the Android operating system.
- ❷ The service provider is responsible for these apps and the services and content connected to it.

#### Notes on Mercedes-Benz Link

If a mobile phone is used with Mercedes-Benz Link, USB access using the media menu is possible for this mobile phone.

- ❶ Only one route guidance can be active at a time. If route guidance is active on the multimedia system, it is closed when route guidance is started on the mobile phone.

#### Connecting Mercedes-Benz Link with the multimedia system

##### Requirements:

- The vehicle is equipped with the Mercedes-Benz Link control box.
- The Mercedes-Benz Link app is installed on the mobile phone.
- The mobile phone is switched on.
- Mercedes-Benz Link is connected to the multimedia system via the  USB port using a suitable cable (→ page 405).
- ❶ The first activation of Mercedes-Benz Link on the multimedia system must be carried out when the vehicle is stationary for safety reasons.

Multimedia system:

- ➔  ➔ Mercedes me & Apps
- ➔ Smartphone ➔ Mercedes-Benz Link
- ➔ Start Mercedes-Benz Link

### Accepting/rejecting the data protection regulations

For the initial start of the application: a message with the data protection provisions appears.

- ▶ Select **Accept & Start**.

### Quitting Mercedes-Benz Link



- ▶ Press the  button.

- ⓘ Mercedes-Benz Link starts automatically when it is connected with the system using a cable. If Mercedes-Benz Link was not displayed in the foreground before disconnecting, the application starts in the background when reconnected. You can call up Mercedes-Benz Link using the main menu.

You can find more information in the Mercedes-Benz Link control box operating instructions.

### Calling up Mercedes-Benz Link sound settings

Multimedia system:

- ➔  ➔ Mercedes me & Apps
- ➔ Smartphone ➔ Mercedes-Benz Link
- ➔ 

- ▶ Select sound settings.

### Ending Mercedes-Benz Link

- ▶ Disconnect the connecting cable between Mercedes-Benz Link and the multimedia system.
- ⓘ Mercedes-Benz recommends disconnecting the connecting cable only when the vehicle is stationary.

## Apple CarPlay®

### Overview of Apple CarPlay®

**⚠ WARNING** Risk of distraction from information systems and communications equipment

If you operate information and communication equipment integrated in the vehicle when driving, you will be distracted from the traffic situation. This could also cause you to lose control of the vehicle.

- ▶ Only operate this equipment when the traffic situation permits.
- ▶ If you cannot be sure of this, stop the vehicle whilst paying attention to road and traffic conditions and operate the equipment with the vehicle stationary.

You must observe the legal requirements for the country in which you are currently driving when operating the multimedia system.

iPhone® functions can be used via the multimedia system using Apple CarPlay®. They are operated using the touchscreen, touchpad, Touch



Control or the Siri® voice-operated control system. You can activate the voice-operated control system by pressing and holding the  button on the multifunction steering wheel.

When using Apple CarPlay® via the voice-operated control system, the multimedia system can still be operated via the Voice Control System (→ page 266).

Only one iPhone® at a time can be connected via Apple CarPlay® with the multimedia system.

Also for use of Apple CarPlay® with two phone mode, only one additional mobile phone can be connected using Bluetooth® with the multimedia system.

The availability of Apple CarPlay® may vary according to the country.

The service provider is responsible for this application and the services and content connected to it.

Apple CarPlay® is a registered trademark of Apple Inc.

### Information on Apple CarPlay®

When Apple CarPlay® is being used, the iPod® media source is not available for the respective iPhone®.



Only one route guidance can be active at a time. If route guidance is active on the multimedia system, it is closed when route guidance is started on the mobile phone.



### Connecting an iPhone® via Apple CarPlay® (cable)

#### Requirements:

- The current version of your device's operating system is being used (see the manufacturer's operating instructions).
- There is an Internet connection for the full range of functions for Apple CarPlay®.
- The iPhone® is connected to the multimedia system via the USB port  using a suitable cable (→ page 405).

Multimedia system:

  **Mercedes me & Apps**  
 ▶▶ Smartphone ▶▶ Apple CarPlay  
 ▶▶ Start Apple CarPlay

▶ Alternative: If an Apple CarPlay® application is active (e.g. when music is being played or route guidance is active), you can call up the active application using the ,  or  application buttons (→ page 296).

ⓘ Control using the application buttons can be switched on or off (→ page 384).

### Accepting/rejecting the data protection regulations

For the initial start of the application: a message with the data protection provisions appears.

▶ Select **Accept & Start**.



### Exiting Apple CarPlay®

▶ Press the  button.

- ① Apple CarPlay® starts automatically when the iPhone® is connected with the system using a cable. If Apple CarPlay® was not displayed in the foreground before disconnecting, the application starts in the background when reconnected. You can call up Apple CarPlay® in the main menu.



### Calling up Apple CarPlay® sound settings

Multimedia system:

-  → Mercedes me & Apps
- Smartphone → Apple CarPlay → 
- ▶ Select sound settings.

### Setting control of the application buttons (Apple CarPlay®)

Multimedia system:

-  → Mercedes me & Apps
- Smartphone → Apple CarPlay → 
- General
- ▶ To switch on **Control via Application Buttons**: activate the display button.
- ▶ To switch off **Control via Application Buttons**: deactivate the display button.

### Ending Apple CarPlay®

- ▶ **To end the connection of Apple CarPlay®(with cable)**: disconnect the connection via the connecting cable between the mobile phone and multimedia system.
- ① Mercedes-Benz recommends disconnecting the connecting cable only when the vehicle is stationary.

### Android Auto

#### Android Auto overview

**⚠ WARNING** Risk of distraction from information systems and communications equipment

If you operate information and communication equipment integrated in the vehicle when driving, you will be distracted from the traffic situation. This could also cause you to lose control of the vehicle.

- ▶ Only operate this equipment when the traffic situation permits.

- ▶ If you cannot be sure of this, stop the vehicle whilst paying attention to road and traffic conditions and operate the equipment with the vehicle stationary.

You must observe the legal requirements for the country in which you are currently driving when operating the multimedia system.

Mobile phone functions can be used with Android Auto using the Android operating system on the multimedia system. It is operated using the touchscreen or the voice-operated control system. You can activate the voice-operated control system by pressing and holding the  button on the multifunction steering wheel.

When using Android Auto via the voice-operated control system, the multimedia system can still be operated via the Voice Control System (→ page 266).

Only one mobile phone at a time can be connected via Android Auto with the multimedia system.

Also for use of Android Auto with two phone mode, only one additional mobile phone can be

connected using Bluetooth® with the multimedia system.

The availability of Android Auto and Android Auto apps may vary according to the country.

The service provider is responsible for this application and the services and content connected to it.

#### Information on Android Auto

If a mobile phone is used with Android Auto, USB access using the media menu is not possible for this mobile phone.

Only one route guidance can be active at a time. If route guidance is active on the multimedia system, it is closed when route guidance is started on the mobile phone.

#### Connecting a mobile phone via Android Auto (wired)

##### Requirements:

- The mobile phone supports Android Auto from Android 5.0.
- The Android Auto app is installed on the mobile phone.



- In order to use the telephone functions, the mobile phone must be connected to the multimedia system via Bluetooth® (→ page 369).

If there was no prior Internet connection, this is established with the use of the mobile phone with Android Auto.

- The mobile phone is connected to the multimedia system via the USB port  using a suitable cable (→ page 405).
- There is an Internet connection for the full range of functions for Android Auto.

Multimedia system:

- ➔  ➔ Mercedes me & Apps
- ➔ Smartphone ➔ Android Auto
- ➔ Start Android Auto

▶ Alternative: If an Android Auto application is active (e.g. when music is being played or route guidance is active), you can call up the active application using the   or  application buttons (→ page 296).

- ⓘ Control using the application buttons can be switched on or off (→ page 386).

- ⓘ The first activation of Android Auto on the multimedia system must be carried out when the vehicle is stationary for safety reasons.

#### Accepting/rejecting the data protection regulations

For the initial start of the application: a message with the data protection provisions appears.

- ▶ Select **Accept & Start**.

#### Exiting Android Auto

- ▶ Press the  button.

- ⓘ Android Auto starts automatically when the mobile phone is connected with the system using a cable. If Android Auto was not displayed in the foreground before disconnecting, the application starts in the background when reconnected. You can call up Android Auto in the main menu.

### Calling up the Android Auto sound settings

Multimedia system:

→  >> Mercedes me & Apps  
 >> Smartphone >> Android Auto >> 

▶ Select sound settings.

### Setting control of the application buttons (Android Auto)

Multimedia system:

→  >> Mercedes me & Apps  
 >> Smartphone >> Android Auto >>   
 >> General

▶ To switch on **Control via Application Buttons**: activate the display button.

▶ To switch off **Control via Application Buttons**: deactivate the display button.

### Ending Android Auto

▶ **To end the connection of Android Auto (with cable)**: disconnect the connection via the connecting cable between the mobile phone and multimedia system.

 Mercedes-Benz recommends disconnecting the connecting cable only when the vehicle is stationary.

### Transferred vehicle data with Android Auto and Apple CarPlay®

#### Overview of transferred vehicle data

When using Android Auto or Apple CarPlay®, certain vehicle data is transferred to the mobile phone. This enables you to get the best out of selected mobile phone services. Vehicle data is not directly accessible.

The following system information is transmitted:

- Software release of the multimedia system
- System ID (anonymized)

The transfer of this data is used to optimize communication between the vehicle and the mobile phone.

To do this, and to assign several vehicles to the mobile phone, a vehicle identifier is randomly generated.

This has no connection to the vehicle identification number (VIN) and is deleted when the multimedia system is reset (→ page 326).

The following driving status data is transmitted:

- Transmission position engaged
- Distinction between parked, standstill, rolling and driving
- Day/night mode of the instrument cluster

The transfer of this data is used to alter how content is displayed to correspond to the driving situation.

The following position data is transmitted:

- Coordinates
- Speed
- Compass direction
- Acceleration direction

This data is only transferred while the navigation system is active, in order to improve it (e.g. so it can continue functioning when in a tunnel).

## Mercedes me calls

### Making a call via the overhead control panel

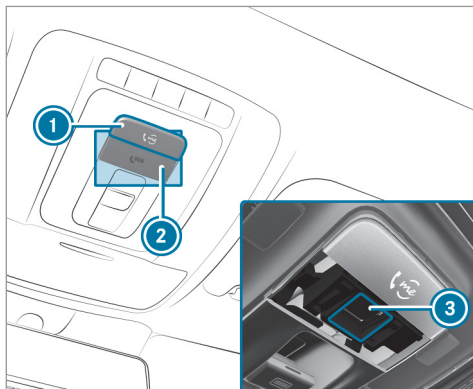

- ① me button for service, concierge or information calls
- ② SOS button cover
- ③ SOS button (emergency call system)

- ▶ **To make a Mercedes me call:** press me button ①.
- ▶ **To make an emergency call:** press SOS button cover ② briefly to open.
- ▶ Press and hold SOS button ③ for at least one second.

If a Mercedes me call is active, an emergency call can still be triggered. This has priority over all other active calls.

#### Information about the Mercedes me call using the me button

A call to the Mercedes-Benz Customer Center has been initiated via the me button in the overhead control panel or the multimedia system (→ page 387).

Using the voice dialog system you access the desired service:

- Concierge Service (if the service is activated)
- Accident and breakdown management (→ page 389)
- Mercedes-Benz Customer Center for general information about the vehicle

You can find information on the following topics:

- Activation of Mercedes me connect
- Operating the vehicle
- Nearest authorized Mercedes-Benz Center
- Other products and services from Mercedes-Benz

Data is transferred during the connection to the Mercedes-Benz Customer Center (→ page 388).

#### Calling the Mercedes-Benz Customer Center using the multimedia system

**Requirements:**

- Access to a GSM network is available.
- The contract partner's GSM network coverage is available in the respective region.
- The ignition must be switched on so that vehicle data can be transferred automatically.

Multimedia system:



▶ Call **Mercedes me connect**.

After confirmation, the multimedia system sends the required vehicle data. The data transfer is shown in the media display.

Then, you can select a service and be connected to a specialist at the Mercedes-Benz Customer Center.

Further information on Mercedes me connect, the provided service scope and operation are available at: [http://manuals.daimler.com/baix/cars/connectme/en\\_GB/index.html](http://manuals.daimler.com/baix/cars/connectme/en_GB/index.html)

### Arranging a service appointment via a Mercedes me call

If you have activated the maintenance management service, relevant vehicle data is transferred automatically to the Mercedes-Benz Customer Center. You will then receive individual recommendations regarding the maintenance of your vehicle.

Regardless of whether you have consented to the maintenance management service, the multi-

media system reminds you after a certain amount of time that a service is due. A prompt appears asking if you would like to make an appointment.

▶ **To arrange a service appointment:** select **Call**.

After your agreement the vehicle data is sent and a Mercedes-Benz Customer Center employee deals with your appointment. The information is then sent to your desired service outlet.

This will contact you to confirm the appointment and if necessary consult about the details.

❗ If you select **Later** after the service message appears, the message is hidden and reappears after a certain period of time.

### Transferred data during a Mercedes me call

The data transferred during a Mercedes me call depends on which service is selected in the voice control system and whether Mercedes me connect services are activated.

If no Mercedes me connect services are activated and the data protection prompt has been confirmed the following data is transmitted:

- Vehicle identification number
- Mercedes me customer identification number
- Reason for the initiation of the call
- Language set in the multimedia system
- Confirmation of the data protection prompt

If a call is made for a service appointment via the service reminder, the following data may be transmitted:

- Current mileage and maintenance data  
Transfer is possible assuming the required data transfer technology is supported by the mobile service operator and the quality of the mobile connection is sufficient.

If Accident and Breakdown Management is called via the voice control system and no service has been activated, but the data protection query has been confirmed, the following data can also be called up from the vehicle by the Mercedes-Benz Customer Center:

- Current vehicle location
- **i** At the time of going to press, this function is technically not yet available but can be supported in the future.

If the data protection prompt has been rejected the following data is transmitted:

- Reason for the initiation of the call
- Rejection of the data protection prompt

### Mercedes me connect

#### Notes on Mercedes me connect

Mercedes me connect consists of multiple services.

Depending on whether the services are activated and on the vehicle equipment, you can use the following services via the multimedia system and the overhead control panel, for example:

- Accident and breakdown management (me button)
- If the service is activated: Concierge Service (me button)
- Mercedes-Benz emergency call system (automatic emergency call or SOS button)

Mercedes me connect accident and breakdown management, the Mercedes me connect Concierge Service (if service is activated) and the Mercedes-Benz emergency call center are available for you around the clock.

The me button and the SOS button can be found on the vehicle's overhead control panel (→ page 387).

You can also call the Mercedes-Benz Customer Center using the multimedia system (→ page 387).

Please note that Mercedes me connect is a Mercedes-Benz service. In emergencies, always

call the national emergency services first using the standard national emergency service phone numbers. In emergencies, you can also use the Mercedes-Benz emergency call system (→ page 391).

Observe the conditions of use for Mercedes me connect and other services. These can be obtained in the Mercedes me portal: <https://me.secure.mercedes-benz.com>

Further information about Mercedes me connect services can be obtained in the Mercedes me portal: <https://me.secure.mercedes-benz.com>

#### Information on Mercedes me connect accident and breakdown management

The accident and breakdown management can include the following functions:

- Supplement to the Mercedes-Benz emergency call system (→ page 391)

If necessary, the contact person at the Mercedes-Benz emergency call center forwards the call to Mercedes me connect breakdown and accident management. Forwarding the call is however not possible in all countries.

- Breakdown assistance by a mechanic on location and/or the towing away of the vehicle to the nearest authorized Mercedes-Benz Center

You may be charged for these services.

More information about Mercedes me connect services can be obtained in the Mercedes me portal: <https://me.secure.mercedes-benz.com>

#### Data transferred during Mercedes me connect call services

The data transferred during a Mercedes me connect call depends on the reason the call was initiated, which service is selected in the voice control system and which Mercedes me connect services are activated.

Which data is transferred for the services can be taken from the currently valid terms of use. These can be obtained in the Mercedes me portal: <https://me.secure.mercedes-benz.com>

### Mercedes me and apps

#### Information about Mercedes me

When you log in with a user account to the Mercedes me portal, then services and offers from Mercedes-Benz will be available to you.

Availability is country-dependent.

For more information consult an authorized Mercedes-Benz Center or visit the Mercedes me portal: <http://me.secure.mercedes-benz.com>

- ⓘ Make sure you always keep the Mercedes me apps updated.

#### Calling up the Mercedes me user account

Multimedia system:

↳  » Mercedes me & Apps

#### Your vehicle is connected with a user account

- ▶ Select [Mercedes me](#). Information about the connected user account appears.

#### Your vehicle is not yet connected with a user account

- ▶ Select [Mercedes me](#).
- ▶ The instructions for creating a user account and connecting the vehicle with this follow on the media display.

- ⓘ If the Mercedes me app is available on a mobile phone, the vehicle connection can be accomplished using the QR code shown.

#### Calling up the Mercedes me services Requirements:

- The vehicle is connected with the user account.

Multimedia system:

↳  » Mercedes me & Apps

- ▶ Select [Services](#). Within the various categories you can see the Mercedes me services you have already purchased and also those still available to purchase.



To activate or deactivate the services, log in to your user account in the Mercedes me portal.

### Deleting a connection between a user account and the vehicle

#### Requirements:

- The (vehicle) profile of the user account that was first connected with the vehicle is selected.
- The profile is synchronized (→ page 299).
- A PIN has been set.

Multimedia system:

→  » Mercedes me & Apps  
 » Mercedes me

- ▶ Select **Delete Vehicle Assignment**.
- ▶ Enter the PIN of the connected user account.
- ⓘ Only the user, whose user account was first connected with the vehicle can delete the connection between all user accounts and the vehicle.

### Mercedes-Benz emergency call system

#### Information on the Mercedes-Benz emergency call system

Your vehicle is equipped with the Mercedes-Benz emergency call system ("eCall"). This feature can help save lives in the event of an accident. eCall in no way replaces assistance provided from dialing 911.

Mercedes-Benz eCall only functions in areas where mobile phone coverage is available from the wireless service providers. Insufficient network coverage from the wireless service providers may result in an emergency call not being transmitted.

eCall is a standard feature in your Mercedes-Benz vehicle. In order to function as intended, the system relies on the transmission of data detailed in the "Mercedes-Benz emergency call system data transmission" section that follows (→ page 393).

To disable eCall, a customer must visit an authorized Mercedes-Benz Service department to deactivate the vehicle's communication module.

**Deactivation of this module prevents the activation of any and all Mercedes me connect services. After the deactivation of eCall, automatic emergency call and manual emergency call will not be available.**

The ignition must be switched on before an automatic emergency call can be made.

- ⓘ eCall is activated at the factory.
- ⓘ eCall can be deactivated by an authorized Mercedes-Benz dealer. Please note that in the event ownership of the vehicle is transferred to another owner in its deactivated state, eCall will remain deactivated unless the new owner visits an authorized Mercedes-Benz dealership to reactivate the system.

#### Overview of the Mercedes-Benz emergency call system

eCall can help to reduce the time between an accident and the arrival of emergency services at the site of the accident. It helps locate an accident site in places that are difficult to access. However, even if a vehicle is equipped with eCall, this does not mean the system is ON.

As such, eCall does not replace dialing 911 in the event of an accident.

The emergency call can be made automatically (→ page 392) or manually (→ page 393). Only make emergency calls if you or others are in need of rescue.

Only make emergency calls if you or others are in need of rescue. Do not make an emergency call in the event of a breakdown or a similar situation.

#### Notification in the multimedia system display:

**SOS NOT READY:** the ignition is not on or eCall not available.

During an active emergency call,  appears in the display.

You can find more information on the regional availability of eCall at: [http://www.mercedes-benz.com/connect\\_ecall](http://www.mercedes-benz.com/connect_ecall)

- ❗ If there is a malfunction in the Mercedes-Benz emergency call system (e.g. a malfunction with the speaker, microphone, airbag, SOS button), a corresponding message

appears in the multifunction display of the instrument cluster.

#### Triggering an automatic Mercedes-Benz emergency call Requirements

- The ignition is switched on.
- The starter battery is sufficiently charged.

The Mercedes-Benz emergency call system triggers an emergency call automatically in the following cases:

- After activation of the restraint systems such as airbags or Emergency Tensioning Devices after an accident.
- After an automatically initiated emergency stop by Active Emergency Stop Assist.

The emergency call has been made:

- A voice connection is made to the Mercedes-Benz emergency call center.
- A message with accident data is transmitted to the Mercedes-Benz emergency call center.

The Mercedes-Benz emergency call center can transmit the vehicle position data to one of the emergency call centers.

The SOS button in the overhead control panel flashes until the emergency call is finished.

It is not possible to immediately end an automatic emergency call.

If no connection can be made to the emergency services either, a corresponding message appears in the media display.

- ▶ Dial the local emergency number on your mobile phone.

If an emergency call has been initiated:

- Remain in the vehicle if the road and traffic conditions permit you to do so until a voice connection is established with the emergency call center operator.
- Based on the call, the operator decides whether it is necessary to call rescue teams and/or the police to the accident site.
- If no vehicle occupant answers, an ambulance is sent to the vehicle immediately.

### Triggering a manual Mercedes-Benz emergency call

- ▶ **To use the SOS button in the overhead control panel:** press the SOS button at least one second long .
- ▶ **To use voice control:** use the Voice Control System voice commands (→ page 274).

The emergency call has been made:

- A voice connection is made to the Mercedes-Benz emergency call center.
- A message with accident data is transmitted to the Mercedes-Benz emergency call center.  
The Mercedes-Benz emergency call center can transmit the vehicle position data to one of the emergency call center.
- Remain in the vehicle if the road and traffic conditions permit you to do so until a voice connection is established with the emergency call center service provider.
- On the basis of the call, the service provider decides whether it is necessary to call rescue teams and/or the police to the accident site.

If no connection can be made to the emergency services either, a corresponding message appears in the media display.

- ▶ Dial the local emergency number on your mobile phone.

### Ending an unintentionally triggered manual Mercedes-Benz emergency call

- ▶ Select  on the multifunction steering wheel. Depress the button for several seconds.

### Data transfer of the Mercedes-Benz emergency call system

In the event of an automatic or manual emergency call the following data is transmitted, for example:

- Vehicle's GPS position data
- GPS position data on the route (a few hundred meters )before the incident)
- Direction of travel
- Vehicle identification number
- Vehicle drive type

- Number of people determined to be in the vehicle
- Whether Mercedes me connect is available or not
- Whether the emergency call was initiated manually or automatically
- Time of the accident
- Language setting on the multimedia system

Data transmitted is vehicle information. For any questions about the collection, use and sharing of the eCall system data, please contact MBUSA's Customer Assistance Center at 800-FOR-MERC.

For Canada, please contact MBC's Customer Assistance Center at 1-800-387-0100.

Customer requests for covered information should be submitted via the same channels.

For accident clarification purposes, the following measures can be taken up to an hour after the emergency call has been initiated:

- The current vehicle position can be called up.

- A voice connection to the vehicle occupants can be established

## Online and Internet functions

### Internet connection

#### Information on connecting to the Internet

**⚠ WARNING** Risk of distraction from information systems and communications equipment

If you operate information and communication equipment integrated in the vehicle when driving, you will be distracted from the traffic situation. This could also cause you to lose control of the vehicle.

- ▶ Only operate this equipment when the traffic situation permits.
- ▶ If you cannot be sure of this, stop the vehicle whilst paying attention to road and traffic conditions and operate the equipment with the vehicle stationary.

You must observe the legal requirements for the country in which you are currently driving when operating the multimedia system.

**⚠ WARNING** Risk of an accident from operating mobile communication equipment while the vehicle is in motion

Mobile communications devices distract the driver from the traffic situation. This could also cause the driver to lose control of the vehicle.

- ▶ As the driver, only operate mobile communications devices when the vehicle is stationary.
- ▶ As a vehicle occupant, only use mobile communications devices in the areas intended for this purpose, e.g. in the rear passenger compartment.

You must observe the legal requirements for the country in which you are currently driving when operating mobile communication equipment in the vehicle.

The Internet functions can only be used to a limited degree whilst driving.

#### Function of the communication module

On vehicles with a built-in communication module, the Internet connection is established via an integrated SIM card.

To use Internet access via the communication module the following conditions must be met:

- Mercedes me connect is active and ready for operation.
- Mercedes me connect is activated for Internet access.
- In some countries: data volume via Mercedes me connect is available.

In some countries: if the data volume limit is reached, the availability of Mercedes me connect services is limited. The data volume must be purchased via Mercedes me connect.

- ⓘ Contact an authorized Mercedes-Benz Center to find out whether it is possible to purchase data volume in your country.

## Establishing an Internet connection

Multimedia system:

→ [Home] → Mercedes me & Apps

▶ For example, select [Browser].

- ① The multimedia system usually establishes the Internet connection automatically. If the multimedia system is not connected to the Internet, the Internet connection is established when an Internet application is used.
- ① The availability of the function is dependent on the country.

## Connection status

### Connection status overview

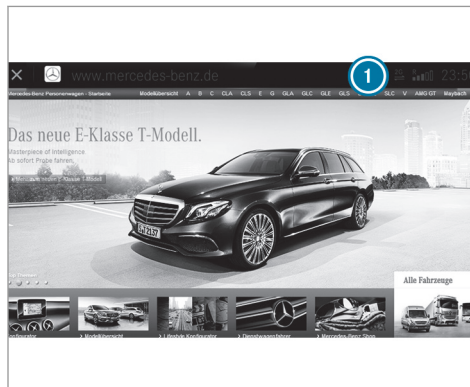

- ① Display of existing connection (double arrow) and reception field strength of the communication module

## Displaying the connection status

Multimedia system:

→ [Home] → Settings → System

▶ Wi-Fi & Bluetooth

▶ Select Internet Status.

- ① In the case of a connection via the communication module the following status information is shown:
  - Type of network
  - Status online/offline

## Web browser

### Calling up a web page



**⚠ WARNING** Risk of distraction from information systems and communications equipment

If you operate information and communication equipment integrated in the vehicle when driving, you will be distracted from the traffic situation. This could also cause you to lose control of the vehicle.

- ▶ Only operate this equipment when the traffic situation permits.
- ▶ If you cannot be sure of this, stop the vehicle whilst paying attention to road and traffic conditions and operate the equipment with the vehicle stationary.

You must observe the legal requirements for the country in which you are currently driving when operating the multimedia system.

Multimedia system:

- ▶  ▶ Mercedes me & Apps
- ▶  Browser

#### Calling up a new web page

- ▶ Select **URL**.
- ▶ Entering a web address
- ▶ Select **ok**.
- ⓘ The function is country-dependent.
- ⓘ Websites cannot be shown while the vehicle is in motion.

#### Calling up a website from the browser history

- ▶ To call up the previous or next page from the history: select **←** or **→**.

## Web browser overview

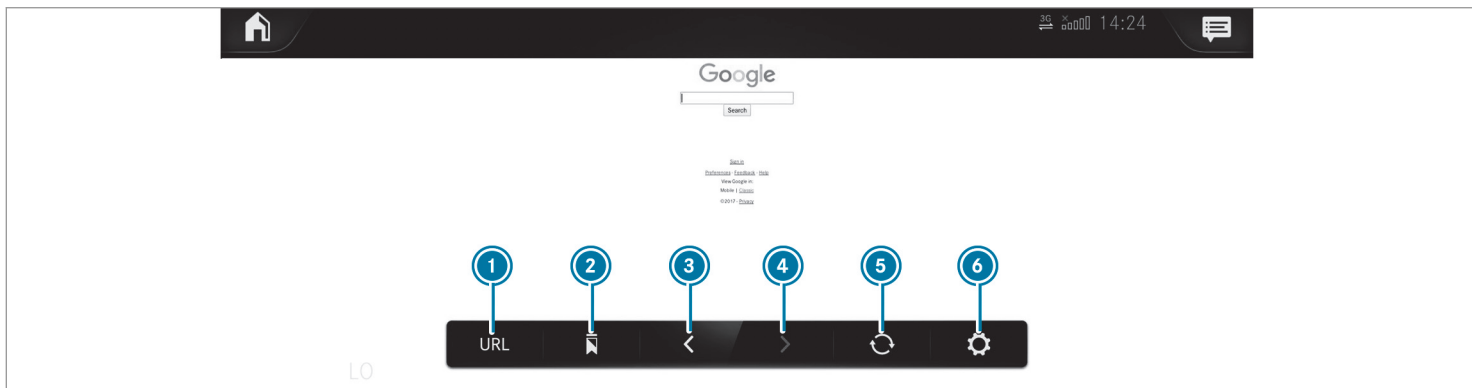

- ① URL entry
- ② Bookmarks
- ③ Web page, back
- ④ Web page, forwards
- ⑤ To refresh/stop
- ⑥ Options

### Calling up web browser options

Multimedia system:

→ [Home] ▶▶ Mercedes me & Apps  
 ▶▶ [Browser] ▶▶ [Settings]

The following functions are available:

- [Bookmarks](#)
- [Options](#) with the settings:

- [Browser Settings](#)
- [Delete Browser Data](#)

- ▶ Select an option.
- ▶ Change the settings.

### Calling up the web browser settings

Multimedia system:

- ▶  ▶ Mercedes me & Apps
- ▶  Browser ▶ 
- ▶ Browser Settings



The following functions are available:

- Block Pop-ups
- Activate Javascript
- Allow Cookies

- ▶ **To switch a function on:** activate the display button.
- ▶ **To switch a function off:** deactivate the display button.

### Deleting Internet history

Multimedia system:

- ▶  ▶ Mercedes me & Apps
- ▶  Browser ▶ 
- ▶ Delete Browser Data

The following options are available:



- All
- Cache

- Cookies
- History
- Entered URLs
- Form Data

- ▶ Select an option.
- ▶ Select **Yes**.

### Managing bookmarks

Multimedia system:

- ▶  ▶ Mercedes me & Apps
- ▶  Browser
- ▶ Select .

### Selecting a bookmark

- ▶ Select an entry.

### Creating a bookmark

- ▶ Select **Add Current Page to Bookmarks**. The bookmark is created.

### Editing a bookmark

- ▶ Select  after a bookmark.
- ▶ Select **Edit**.



- ▶ Enter the name.
- ▶ Select **OK**.

### Deleting a bookmark

- ▶ Select  after a bookmark.
- ▶ Select **Delete**.
- ▶ Select **Yes**.

### Closing the browser

Multimedia system:

- ▶  ▶ Mercedes me & Apps
- ▶  Browser
- ▶ Select .

### Tuneln radio

#### Calling up Tuneln radio

##### Requirements:

- The Tuneln radio service is activated.
- The data volume is available.  
Depending on the country, data volume may need to be purchased.



- A fast Internet connection for data transmission free of interference.
- ① The functions and services are country-dependent. For more information, consult an authorized Mercedes-Benz Center.

Multimedia system:

 **Radio**

- ▶ Select **TuneIn Radio**.  
The TuneIn menu appears. The last station set starts playing.
- ① The connection quality depends on the local mobile phone reception.

## Overview of Tuneln radio

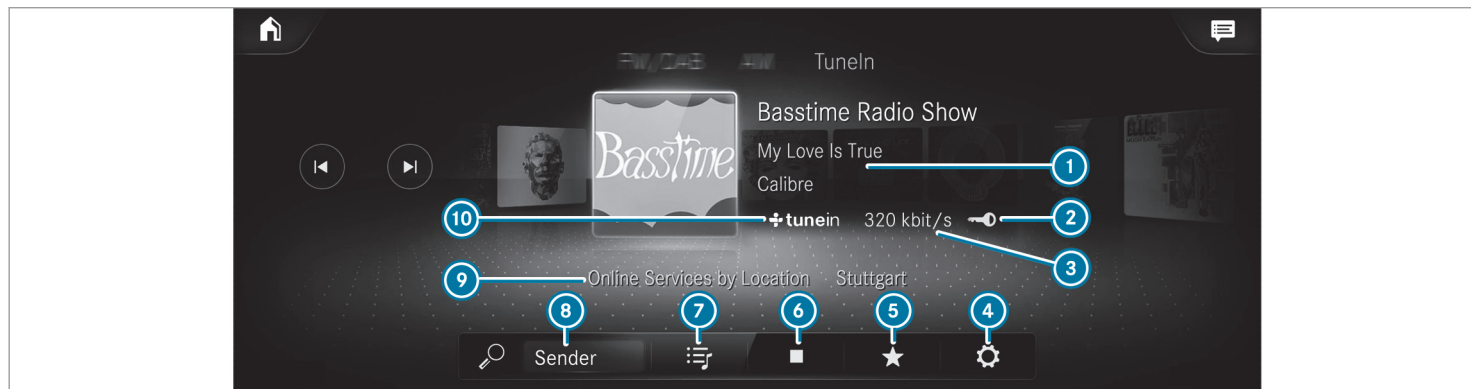

- ① Additional information on the current station
- ② Display (if connected to private user account)
- ③ Data transfer rate
- ④ Options
- ⑤ Favorites
- ⑥ To start/end
- ⑦ To browse
- ⑧ Search
- ⑨ Selected category
- ⑩ Internet Radio provider

### Selecting and connecting to a Tuneln radio station

Multimedia system:

➤ ➤ Radio ➤ Tuneln Radio

➤ Select .

➤ Select a category.

- ▶ Select a station.  
The connection is established automatically.
- or

- ▶ Select the search field.
- ▶ Enter a station name.

 A relatively large volume of data can be transmitted when using Tuneln radio.

### Saving/deleting a Tuneln radio station as a favorite

Multimedia system:

 ▶▶ Radio ▶▶ Tuneln Radio

- ▶ Select a station.
- ▶ Select .
- ▶ The list of saved favorite stations appears.
- ▶ Select [Add to Favorites](#).

or

- ▶ Create an account for the online provider (Tuneln radio) and then log in on the multimedia system.  
Your favorites are imported to the multimedia system.

### Deleting favorites

- ▶ Select a station.
- ▶ Select .
- ▶ Select [Delete Favorite](#).

### Setting the Tuneln radio options

Multimedia system:

 ▶▶ Radio ▶▶ Tuneln Radio ▶▶ 

▶▶ Tuneln Radio

The following options are available:

- [Select Stream](#): select the stream quality.
  - [Login to Tuneln Account](#): log in to your Tuneln user account.
  - [Log Out of Account](#): log out of your Tuneln user account.
- ▶ Select an option.

### Showing the station list for the last category selected

Multimedia system:

 ▶▶ Radio ▶▶ Tuneln Radio

- ▶ Press the cover of the current station.  
Depending on how the station was selected, a station list is shown.

## Media

### Information about media mode

### Information about supported formats and data storage media

 **WARNING** Risk of distraction when handling data storage media

If you handle a data storage medium while driving, your attention is diverted from the traffic conditions. This could also cause you to lose control of the vehicle.

- ▶ Only handle a data storage medium when the vehicle is stationary.

**The multimedia system supports the following formats and data media:**

|                           |   |
|---------------------------|---|
| Permissible file systems  | FAT32, exFAT, NTFS  |
| Permissible data carriers | USB devices, iPod®/iPhone®, MTP devices, Bluetooth® audio equipment |
| Supported audio formats   | MP3, WMA, AAC, WAV, FLAC, ALAC                                      |

**i** Observe the following notes:

- The multimedia system supports a total of up to 50,000 files.
- Data storage media up to 2 TB are supported (32-bit address space).
- Due to the large variety of available music and video files regarding encoders, sampling rates and data transfer rates, playback cannot be guaranteed.

- Due to the wide range of USB devices available on the market, playback cannot be guaranteed for all USB devices.
- Videos up to FullHD (1920x1080) are supported.
- Copy-protected music and video files or DRM (Digital Rights Management) encrypted files cannot be played back.
- MP3 players must support Media Transfer Protocol (MTP).

**Information on copyright protection and trademarks**

Audio files which you create yourself (e.g. copies of data storage media you make yourself) are generally subject to copyright protection. In many countries, reproductions are not permitted without the prior consent of the copyright holder, even for private use. Make sure that you know about the applicable copyright regulations and that you comply with these.



Manufactured under license from Dolby Laboratories. Dolby, Dolby Audio and the double-D symbol are trademarks of Dolby Laboratories.



TIDAL and TIDAL logo are registered trademark of Aspiro AB in the European Union and other countries.

### Overview of the media menu



1 Previous track or fast rewind

2 Next track or fast forward

3 Album cover

4 Active media source

5 Track and artist

6 Current track number/track in playback list and active data storage medium

7 Repeat

8 Settings

9 Additional options

10 Controls playback

11 Timeline

12 Categories

13 Music search

14 Random playback

## Connecting the data storage medium to the multimedia system

### Connecting USB devices

**!** **NOTE** Damage caused by high temperatures

High temperatures can damage USB devices.

- ▶ Remove the USB device after use and take it out of the vehicle.

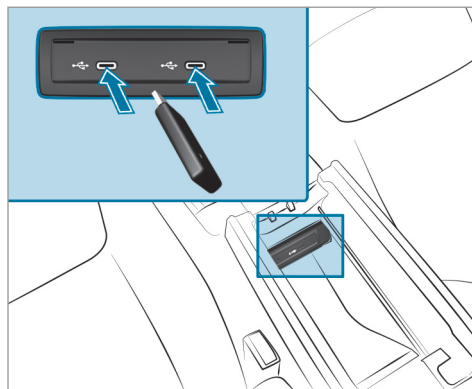

The multimedia connection unit is found in the stowage compartment under the armrest and has two type C USB ports. Depending on the vehicle's equipment, additional USB ports can be found in the stowage compartment of the center console or rear folding compartment.

- ▶ Connect the USB device to the USB port.
- ⓘ USB splitters cannot be connected with the multimedia system.

- ⓘ When connecting several Apple® devices simultaneously, pay attention to the order in which the devices are connected. The multimedia system only connects with the device that is connected first. Additional Apple® devices that are connected at the same time are only supplied with power.

### Searching for and authorizing a Bluetooth® audio device

**Requirements:**

- Bluetooth® is activated on the multimedia system and audio equipment.
- The audio equipment supports the Bluetooth® audio profiles A2DP and AVRCP.
- The audio equipment is "visible" for other devices.

Multimedia system:



### Authorizing a new Bluetooth® audio device

- ▶ Select **Connect New Device**.  
Detected equipment is displayed in the device list.
- ▶ Select an audio device.  
Authorization starts. A code is displayed on the multimedia system and on the mobile phone.
- ▶ If the codes are identical, confirm on the audio equipment.
- ▶ Select **Only as Bluetooth Audio Device**.  
The Bluetooth® audio equipment is connected with the multimedia system.

### Connecting previously authorized Bluetooth® audio equipment

- ▶ Select a Bluetooth® audio device from the list.  
The connection is established.

### Starting media playback

#### Requirements:

- A data storage medium is connected to the multimedia system.

Multimedia system:



- ▶ Select **USB** or **Bluetooth** as the media source.

### Controlling media playback

Multimedia system:



- ▶ **To pause playback:** select
- ▶ **To continue playback:** select
- ▶ **To repeat a track:** select

For the repeat function there are the following settings:

- **Select once:** the active playlist is repeated.

- **Select twice:** the current track is repeated.
- **Select three times:** the repeat function is deactivated.

- ▶ **To play back tracks in random order:** select .

- ▶ **To wind a track forwards or backwards:** tap on the desired point on the timeline.

- ▶ **To select the next track:** select .

- ▶ **To select the previous track:** select .

- ▶ **To scroll through tracks quickly:** press and hold or .

- ▶ **To show the current track list:** select the track image shown.



## Additional options for setting media playback

Multimedia system:



### Calling up additional options

- ▶ Select . The additional options are shown.

The following options are available:

- [Surprise Mix](#)  
A playlist with randomly selected tracks is created.
- [Add to Favorite Songs](#)  
The current track is added to the favorite songs.
- [Remove from Favorite Songs](#)  
The current track is removed from the favorite songs.
- ▶ Select an option.

## Media search

### Notes about the search function in categories

Under  you can search through all available media files. There are several categories available for selection. The categories shown depend on the connected device and data format.

Available categories with Bluetooth® audio:

- [Current Tracklist](#)  
The folders and categories of the connected device are shown.

Available categories with audio files:

- [Current Tracklist](#)
- [Playlists](#)
- [Folder](#)
- [Albums](#)
- [Artists](#)
- [Tracks](#)
- [Favorite Songs](#)
- [Often Played](#)
- [Most Recently Added](#)

- [Music Genres](#)
- [Year](#)
- [Composers](#)
- [Select By Cover](#)
- [Podcasts](#) (Apple® devices)
- [Audiobooks](#) (Apple® devices)

Available categories with video files:

- [Folder](#)
- [Videos](#)

 The categories are available as soon as the entire media content has been read in and analyzed.



### Starting a search in categories

Multimedia system:



- ▶ Select a category.
- ▶ Select  and enter a search term.

### Sorting results shown or playing back all media found

- ▶ Select .
  - ▶ **To play back all results found in the category:** select [Play All](#).  
If, for example, the [Albums](#) category is active, all albums found by the desired artist will be played back.
  - ▶ **To sort results alphabetically:** select [Sort from A-Z](#).
  - ▶ **To sort results in reverse alphabetical order:** select [Sort from Z-A](#).
-  The available options depend on the selected category and the connected device.

### Using the keyword search

Multimedia system:



You can look for content using the keyword search with free text input.

- ▶ Select .
- ▶ A keyboard for character entry appears.
- ▶ Enter the term searched for.

-  The search begins with the first character entered. The more characters entered the more concrete the search results become.
- ▶ Select the desired entry from the result list. If the selected result is an album, song or a playback list then playback is started. If the selected result is a new category then this is opened in the search.

## Radio

### Switching on the radio

Multimedia system:



- ▶ Alternatively: press the  button. The radio display appears. You will hear the last station played on the last frequency band selected.

## Radio overview

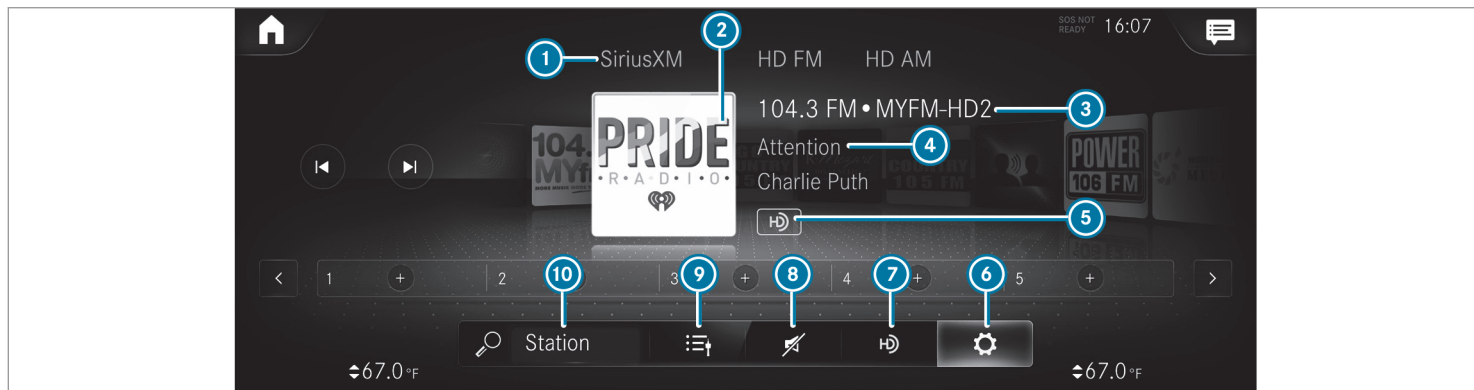

- ① Selects an active frequency band
- ② Station logo
- ③ Station name or set frequency
- ④ Artist, title, album and radio text
- ⑤ HD Radio logo
- ⑥ Options
- ⑦ Switches the HD Radio function on or off

- ⑧ Mute function
- ⑨ Calls up the station list
- ⑩ Search

### Switching the HD Radio function on/off

Multimedia system:

→ ▶▶ Radio ▶▶ HD FM



▶ Switch **HD** on or off.

① HD Radio Technology manufactured under license from iBiquity Digital Corporation. U.S. and Foreign Patents. For patents see DTS website. HD Radio and the HD, HD Radio, and "ARC" logos are registered trademarks or trademarks of iBiquity Digital Corporation in the United States and/or other countries.

### Setting the waveband

Multimedia system:

→ ▶▶ Radio

The following frequency bands are available:

- SiriusXM
- HD FM
- HD AM

▶ Select a frequency band.

### Selecting a radio station

Multimedia system:

→ ▶▶ Radio

▶ Swipe to the left or right on the control element.

### Calling up the radio station list

Multimedia system:

→ ▶▶ Radio

▶ Select .  
The station list appears.

▶ Select a station.

### Searching for radio stations using station names or frequency entry

Multimedia system:

→ ▶▶ Radio

▶ Select .

▶ Enter a station name or frequency.

▶ Select a station.

### Storing radio stations

Multimedia system:

→ ▶▶ Radio

▶ Select a radio station.

### Memory slots are available in station presets

- ▶ Select .

or

- ▶ Press and hold on the radio station.

### Replacing an entry in the station presets

- ▶ Press and hold on an entry in the station presets.
- ▶ Select **Yes**.

### Editing station presets

Multimedia system:



### Moving stations

- ▶ Press and hold a stored station.
- ▶ Select **Move**.
- ▶ Move the station to the new position.

### Deleting stations

- ▶ Press and hold a station.
- ▶ Select **Delete**.

### Replacing a station

- ▶ Press and hold a station.
- ▶ Select **Replace Radio Station**.

### Showing accident reports

Multimedia system:



- ① The availability of the function is dependent on the country.
- ▶ Switch **Display Emergency Warnings** on or off.

### Displaying radio text

Multimedia system:



- ▶ Switch **Radio Text Information** on or off.

### Satellite radio

#### Information on the satellite radio

SIRIUS XM<sup>®</sup> satellite radio offers more than 175 digital-quality radio channels providing 100% commercial-free music, sports, news and entertainment, for example. SIRIUS XM satellite radio employs a fleet of high-performance satellites to broadcast around the clock throughout the USA and Canada. The satellite radio program is available for a monthly fee. Information about this can be obtained from a Sirius XM<sup>®</sup> Service Center and at <http://www.siriusxm.com> (USA) or <http://www.siriusxm.ca> (Canada).

- ① Sirius, XM and all related marks and logos are trademarks of Sirius XM Radio Inc. and its subsidiaries. All other marks, channel names and logos are the property of their respective owners. All rights reserved.

#### Satellite radio restrictions

Satellite radio mode may be temporarily unavailable or interrupted for a variety of reasons. These include environmental or topographical conditions beyond the control of Mercedes-Benz

## 412 MBUX multimedia system

USA, LLC. Thus, operation at certain locations may not be possible.

### Registering satellite radio

#### Requirements:

- Satellite radio equipment is available.
- Registration with a satellite radio provider has been completed.
- If registration is not included when purchasing the system, your credit card details will be required to activate your account

Multimedia system:

 Radio **▶▶ SiriusXM**  
**▶▶**  Options

- ▶ Select **Service Information**.  
The service information screen appears showing the radio ID and the current subscription status.
- ▶ Establish a telephone connection.
- ▶ Follow the service staff's instructions.  
The activation process may take up to ten minutes.

- ① You can also have the satellite service activated online. To do so, please visit <http://www.siriusxm.com> (USA) or <http://www.siriusxm.ca> (Canada).

### Switching on satellite radio

Multimedia system:

 Radio

- ▶ Select **SiriusXM**.

## Overview of the satellite radio



- ① Active frequency band
- ② Logo or album art (if available)
- ③ Channel name
- ④ Track information
- ⑤ Traffic & Weather Now and Sports Flash
- ⑥ Options
- ⑦ Shows or hides playback controls

- ⑧ Stops playback controls
- ⑨ Station list
- ⑩ Search

### Selecting a satellite radio category

Multimedia system:

➔ [Home] ➔ [Radio] ➔ SiriusXM

- ▶ Select [List Icon].
- ▶ Select **Category**.
- ▶ Select a category.

**Selecting a satellite radio channel**

Multimedia system:

→ ▶ Radio ▶ SiriusXM

- ▶ Select .
- ▶ Select a channel.

**Saving or deleting a satellite radio channel**

Multimedia system:

→ ▶ Radio ▶ SiriusXM

**Storing the current channel**

- ▶ Press and hold the logo of the current station until the Options menu appears.
- ▶ Select [Add to Presets](#).

**Moving a channel**

- ▶ Press and hold a channel in the presets until the Options menu appears.
- ▶ Select [Move Highlighted Station](#).
- ▶ Move the channel to a new position.

**Deleting a channel**

- ▶ Press and hold a channel in the presets until the Options menu appears.
- ▶ Select [Delete Highlighted Station](#).

**Displaying EPG information for the current channel**

Multimedia system:

 → ▶ Radio ▶ SiriusXM  
▶ 

- ▶ Select [Electr. Program Guide](#).

**Setting parental control for radio**

Multimedia system:

 → ▶ Radio ▶ SiriusXM  
▶ 

- ▶ Select [Parental Control](#).
- ▶ Determine a four-digit character sequence and select .
- ▶ All channels with adult content are locked.

**Unlocking a channel**

- ▶ Enter the four-digit character sequence and select .
- ▶ All channels with adult content are unlocked.

**Music and sport alerts function**

This function enables you to program an alert for your favorite artists, tracks or sporting events. Music alerts can be saved whilst a track is being played and sport alerts can be saved during a live game. You can also specify sport alerts via the menu option. The system then continuously searches through all the channels. If a match is found with a stored alert, you will be informed.

**Setting music and sport alerts**

Multimedia system:

→ ▶ Radio ▶ SiriusXM ▶ Alerts

**Activating the music information function**

- ▶ Activate [Music Alerts](#) .

**Setting a music alert**

- ▶ Select [Add Alert](#).



- ▶ Select **Artists** or **Song** in the dialog window. The alert is set for the current artist or track. If a match is found, a prompt appears asking whether you wish to change to the station.

#### Activating sports information

- ▶ Activate  **Activate Sports Alerts**.

#### Setting a sport alert

- ▶ Select **Add Alert**.
- ▶ Select the team name or league in the dialog window.

#### Deleting individual sports and music alerts

- ▶ Select **Manage Music Alerts**.

or

- ▶ Select **Manage Sports Alerts**.
- ▶ Select an artist or track.

or

- ▶ Select a team.
- ▶ Select **Delete Selected Entries**. All highlighted alerts are deleted.

#### Deleting all sports and music alerts

- ▶ Select **Manage Music Alerts**.

or

- ▶ Select **Manage Sports Alerts**.
- ▶ Select **Delete All Entries**. All alerts are deleted.

#### Information about Smart Favorites and TuneStart

From the station presets you can set up to eight stations as Smart Favorites. Smart Favorites stations are automatically saved to temporary storage in the background. If you change to a Smart Favorites station, you can replay, pause or actively skip forward or back to broadcasts which you have missed. If Tune Start is activated and you change to another Smart Favorites station, the music track currently playing on the station is automatically restarted from the beginning of the track.

#### Adding a channel to Smart Favorites

Multimedia system:

 **▶▶ Radio ▶▶ SiriusXM**

- ▶ Press and hold on the station logo until the Options menu appears.
- ▶ **To add a channel:** select **Add to Smart Favorites** in the menu.
- ▶ **To remove a channel:** select **Delete from Smart Favorites** in the menu.

#### Creating a TuneMix list

Multimedia system:

 **▶▶  Radio ▶▶ SiriusXM**  
**▶▶  ▶▶ TuneMix Lists**

In order to listen to seamless music, you can put together a TuneMix list from various stations.

- ▶ Select **Create TuneMix List**.
- ▶ If necessary, limit the number of stations shown using the **Category** entry.
- ▶ Select the station shown .
- ▶ Press  to confirm. A TuneMix station logo is created in the radio menu.

**Activating/deactivating TuneStart**

Multimedia system:





- ▶ Switch **TuneStart** on or off.

**Switching on satellite radio playback control**

Multimedia system:



You can pause the playback of the current station or skip forward or backward in the timeline. This leaves live mode to access the internal temporary storage.

- ▶ **To show the timeline:** press .
- ▶ **To fast forward/rewind:** tap anywhere on the timeline.
- ▶ **To pause playback:** select .
- ▶ **To return to live mode:** navigate to the end of the timeline.

**Displaying satellite radio service information**

Multimedia system:



- ▶ Select **Service Information**.

**Sound****Tone settings****Information about the sound system**

The sound system has a total output of 125 W and is equipped with five speakers. It is available for all functions in the radio and media modes.

**Calling up the sound menu**

Multimedia system:



The following functions are available:

- **Equalizer**
- **Balance and Fader**
- **Volume**

- ▶ Select a function.

**Adjusting treble, mid-range and bass settings**

Multimedia system:



- ▶ Set **TREBLE**, **MID** or **BASS**.

**Activating/deactivating automatic volume adjustment**

Multimedia system:



Automatic volume adjustment compensates for differing volumes when changing between audio sources and within an audio source.

- ▶ Switch **Automatic Adjustment** on or off.

### Adjusting the balance/fader

Multimedia system:

→  » Media »  » Sound  
» Balance and Fader

#### Adjusting the balance

- ▶ Move the volume distribution between the right and left sides of the vehicle in the grid shown.  
The volume is distributed between the speakers on the left and right sides in the vehicle.

#### Adjusting the fader

- ▶ Move the volume distribution between the front and rear of the vehicle in the grid shown.  
The volume is distributed between the speakers in the front and rear of the vehicle.

### Burmester® surround sound system

#### Information about the Burmester® surround sound system

The Burmester® surround sound system has a total output of 590 W and is equipped with 13

speakers. It is available for all functions in the radio and media modes.

#### Calling up the sound menu in the Burmester® surround sound system

Multimedia system:

→  » Media »  » Burmester

The following functions are available:

- Equalizer
- Balance and Fader
- Sound Focus
- Sound Profiles
- Volume

- ▶ Select a function.

#### Adjusting the treble, mid and bass settings on the Burmester® surround sound system

Multimedia system:

→  » Media »  » Burmester  
» Equalizer

- ▶ Set TREBLE, MID or BASS.

#### Activating/deactivating volume adjustment in the Burmester® surround sound system

Multimedia system:

→  » Media »  » Burmester  
» Volume

Automatic volume adjustment compensates for differing volumes when changing between audio sources and within an audio source.

- ▶ Switch [Automatic Adjustment](#) on or off.

#### Adjusting the balance/fader in the Burmester® surround sound system

Multimedia system:

→  » Media »  » Burmester  
» Balance and Fader

#### Adjusting the balance

- ▶ Move the volume distribution between the right and left sides of the vehicle in the grid shown.  
The volume is distributed between the speakers on the left and right sides in the vehicle.

### Adjusting the fader

- ▶ Move the volume distribution between the front and rear of the vehicle in the grid shown.  
The volume is distributed between the speakers in the front and rear of the vehicle.

### Selecting a sound profile in the Burmester® surround sound system

Multimedia system:

- ▶  ▶ Media ▶  ▶ Burmester
- ▶▶ Sound Profiles

The following profiles are available:

- Pure
  - Surround
- ▶ Select a sound profile.

### Adjusting the sound focus in the Burmester® surround sound system

Multimedia system:

- ▶  ▶ Media ▶  ▶ Burmester
- ▶▶ Sound Focus

- ▶ Select a position for the sound focus or All Seats.

### Advanced sound system

#### Information about the Advanced sound system

The Advanced sound system has a total output of 225 W and is equipped with nine speakers. It is available for all functions in the radio and media modes.

#### Calling up the sound menu in the Advanced sound system

Multimedia system:

- ▶  ▶ Media ▶  ▶ Sound

The following functions are available:

- Equalizer
- Balance and Fader

- Volume

- ▶ Select a function.

#### Adjusting treble, mid-range and bass settings in the Advanced sound system

Multimedia system:

- ▶  ▶ Media ▶  ▶ Sound
- ▶▶ Equalizer

- ▶ Set TREBLE, MID or BASS.

#### Switching volume adjustment in the Advanced sound system on/off

Multimedia system:

- ▶  ▶ Media ▶  ▶ Sound
- ▶▶ Volume

Automatic volume adjustment compensates for differing volumes when changing between audio sources and within an audio source.

- ▶ Switch **Automatic Adjustment** on or off.

### Setting the balance/fader in the Advanced sound system

Multimedia system:

     
▶▶ Balance and Fader

#### Adjusting the balance

- ▶ Move the volume distribution between the right and left sides of the vehicle in the grid shown.  
The volume is distributed between the speakers on the left and right sides in the vehicle.

#### Adjusting the fader

- ▶ Move the volume distribution between the front and rear of the vehicle in the grid shown.  
The volume is distributed between the speakers in the front and rear of the vehicle.

## ASSYST PLUS service interval display

### Function of the ASSYST PLUS service interval display

The ASSYST PLUS service interval display on the Instrument Display provides information on the remaining time or distance before the next service due date.

You can hide this service display using the back button on the left-hand side of the steering wheel.

Depending on how the vehicle is used, the ASSYST PLUS service interval display may shorten the service interval, e.g. in the following cases:

- Mainly short-distance driving
- When the engine is often left idling for long periods
- In the event of frequent cold start phases

Mercedes-Benz recommends avoiding such operating conditions.

You can obtain information concerning the servicing of your vehicle from a qualified specialist

workshop, e.g. an authorized Mercedes-Benz Center.

### Displaying the service due date

On-board computer:

↪ Service ▶ ASSYST PLUS

The next service due date is displayed.

▶ **To exit the display:** press the back button on the left-hand side of the steering wheel.

Make sure to observe the following further related subject:

- Operating the on-board computer (→ page 253).

### Information on regular maintenance work

**!** **NOTE** Premature wear through failure to observe service due dates

Service work which is not carried out at the right time or incompletely can lead to increased wear and damage to the vehicle.

- ▶ Always observe the prescribed service intervals.
- ▶ Always have the prescribed service work carried out at a qualified specialist workshop.

### Special service requirements

The prescribed service interval is based on normal operation of the vehicle. Maintenance work will need to be performed more often if the vehicle is operated under arduous conditions or increased loads.

The ASSYST PLUS service interval display is only an aid. The driver of the vehicle bears responsibility as regards to whether maintenance work needs to be performed more often than specified based on the actual operating conditions and/or loads.

Examples of arduous operating conditions:

- regular city driving with frequent intermediate stops
- mainly short-distance driving

- frequent operation in mountainous terrain or on poor road surfaces
- when the engine is often left idling for long periods
- operation in particularly dusty conditions and/or if air-recirculation mode is frequently used

In these or similar operating conditions, have the interior air filter, engine air cleaner, engine oil and oil filter etc. changed more frequently. The tires must be checked more frequently if the vehicle is operated under increased loads. Further information can be obtained at a qualified specialist workshop.

### Battery disconnection periods

**The ASSYST PLUS service interval display can only calculate the service due date when the battery is connected.**

- ▶ Note down the service due date displayed on the instrument display before disconnecting the battery (→ page 420).

## Engine compartment

### Opening/closing the hood

**⚠ WARNING** Risk of accident if the engine hood is unlatched while driving

An unlocked engine hood may open up when the vehicle is in motion and block your view.

- ▶ Never unlatch the engine hood while driving.
- ▶ Before every trip, ensure that the engine hood is latched.

**⚠ WARNING** Risk of accident and injury when opening and closing the engine hood

When opening or closing the engine hood, it may suddenly drop into the end position.

There is a risk of injury for anyone in the engine hood's range of movement.

- ▶ Only open or close the engine hood when there are no persons in the engine hood's range of movement.

**⚠ WARNING** Danger of burns when opening the hood

If you open the hood when the engine has overheated or during a fire in the engine compartment, you could come into contact with hot gases or other escaping operating fluids.

- ▶ Before opening the hood, allow the engine to cool down.
- ▶ In the event of a fire in the engine compartment, keep the hood closed and call the fire service.

**⚠ WARNING** Risk of injury due to moving parts

Certain components in the engine compartment may continue to move or suddenly move again even after the ignition has been switched off, e.g. the cooler fan.

Make sure of the following before performing tasks in the engine compartment:

- ▶ Switch the ignition off.

- ▶ Never touch the danger zone surrounding moving component parts, e.g. the rotation area of the fan.
- ▶ Remove jewelry and watches.
- ▶ Keep items of clothing and hair away from moving parts.

**⚠ WARNING** Risk of injury from touching component parts under voltage

The ignition system and the fuel injection system work under high voltage. If you touch component parts which are under voltage, you could receive an electric shock.

- ▶ Never touch component parts of the ignition system or the fuel injection system when the ignition is switched on.

**⚠ WARNING** Risk of burns from hot component parts in the engine compartment

Certain components in the engine compartment can be very hot, e.g. the engine, the radiator and parts of the exhaust system.

- ▶ Allow the engine to cool down and only touch component parts described in the following.

**⚠ WARNING** Risk of injury from using the windshield wipers while the engine hood is open

When the engine hood is open and the windshield wipers are set in motion, you can be trapped by the wiper linkage.

- ▶ Always switch off the windshield wipers and ignition before opening the engine hood.

**Plug-in hybrid:** observe the notes in the Supplement. Otherwise, you may fail to recognize dangers.

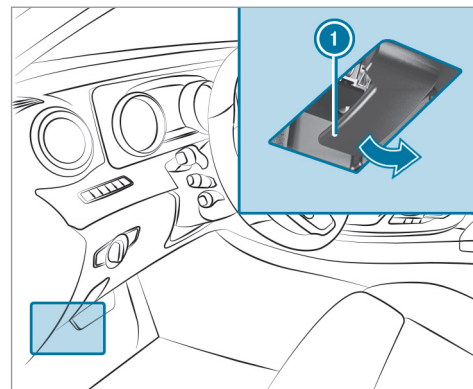

- ▶ **To open:** pull lever ① to release the hood.



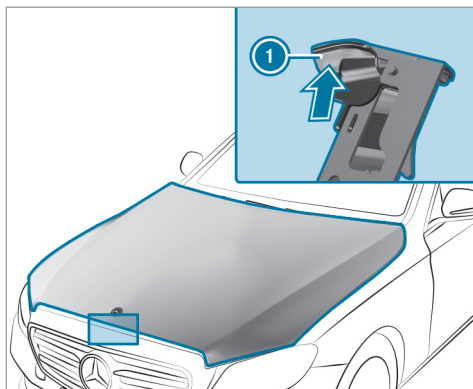

- ▶ Push handle ① of the hood catch upwards and lift the hood by approximately 15 in (40 cm).
- ▶ **To close:** lower the hood and let it fall from a height of approximately 8 in (20 cm).
- ▶ If the hood can still be lifted slightly, open the hood again and close it with a little more force until it engages correctly.

## Engine oil

### Checking the engine oil level using the oil dipstick

**⚠ WARNING** Risk of burns from hot component parts in the engine compartment

Certain components in the engine compartment can be very hot, e.g. the engine, the radiator and parts of the exhaust system.

- ▶ Allow the engine to cool down and only touch component parts described in the following.

**Plug-in hybrid:** be sure to observe the notes in the Supplement. Otherwise, you may not recognize dangers.

#### Requirements:

- The engine must have an oil dipstick. If not, the engine oil level can be checked only with the on-board computer (→ page 424).

Depending on the engine, the oil dipstick may be installed in the engine compartment in different locations.

The waiting time before checking the oil level when the engine is at normal operating temperature is five minutes.

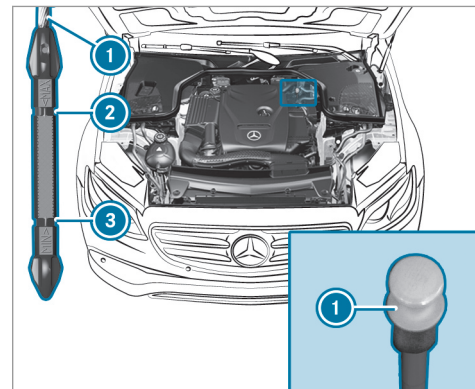

- ▶ Park the vehicle on a level surface.
- ▶ Pull oil dipstick ① out and wipe off.

- ▶ Slowly slide oil dipstick ① into the guide tube to the stop, and take it out again after approximately three seconds.
  - Oil level is correct: oil level is between ② and ③.
  - Oil level too low: oil level is at ③ or below.
  - Oil level too high: oil level is above ②.
- ▶ If the oil level is too low, add 1.1 US qt (1 liter) of engine oil.
- ▶ If the oil level is too high, drain off excess engine oil. Consult a qualified specialist workshop.

### Checking the engine oil level using the on-board computer

#### Requirements

The engine oil level is determined during driving. Determining the engine oil level can take up to 30 minutes with a normal driving style and even longer with an active driving style.

In order to receive a result as quickly as possible:

- warm up the engine

- park the vehicle on a level surface
- leave the engine running at idle speed

On-board computer:

↪ Service ▶▶ Engine Oil Level

You will see one of the following messages on the multifunction display:

- **Measuring Engine Oil Level...:** measurement of the oil level is not yet possible.
- ▶ Repeat the request after a maximum of 30 minutes driving.
- **Engine Oil Level OK** and the bar display for indicating the oil level on the multifunction display is green and is between "min" and "max": the oil level is correct.
- **Engine Oil Level Add 1.0 l** and the bar display for indicating the oil level on the multifunction display is orange and is below "min":
- ▶ Add 1.1 US qt (1 l) of engine oil.
- **Reduce Engine Oil Level** and the bar display for indicating the oil level on the multifunction display is orange and is above "max":

- ▶ Drain off any excess engine oil that has been added. To do so, consult a qualified specialist workshop.

- **For Engine Oil Level Switch Ignition On:**

- ▶ Switch on the ignition to check the engine oil level.

- **Engine Oil Level System Inoperative:** sensor faulty or not inserted.

- ▶ Consult a qualified specialist workshop.

- **Engine Oil Level System Currently Unavail.:**

- ▶ Close the hood.

### Adding engine oil

**⚠ WARNING** Risk of burns from hot component parts in the engine compartment

Certain components in the engine compartment can be very hot, e.g. the engine, the radiator and parts of the exhaust system.

- ▶ Allow the engine to cool down and only touch component parts described in the following.

**⚠ WARNING** Risk of fire and injury from engine oil

If engine oil comes into contact with hot component parts in the engine compartment, it may ignite.

- ▶ Make sure that no engine oil is spilled next to the filler opening.
- ▶ Allow the engine to cool off and thoroughly clean the engine oil from component parts before starting the vehicle.

**! NOTE** Engine damage caused by an incorrect oil filter, incorrect oil or additives

- ▶ Do not use engine oils or oil filters which do not correspond to the specifications explicitly prescribed for the service intervals.
- ▶ Do not alter the engine oil or oil filter in order to achieve longer change intervals than prescribed.
- ▶ Do not use additives.

- ▶ Follow the instructions in the service interval display regarding the oil change.

**! NOTE** Damage caused by adding too much engine oil

Too much engine oil can damage the engine or the catalytic converter.

- ▶ Have excess engine oil removed at a qualified specialist workshop.

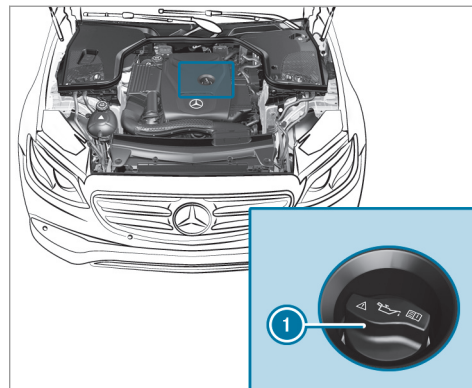

- ▶ Turn cap ① counter-clockwise and remove it.
- ▶ Add engine oil.
- ▶ Replace cap ① and turn it clockwise as far as it will go.
- ▶ Check the oil level again (→ page 423).

### Checking coolant level

**⚠ WARNING** Risk of burns from hot component parts in the engine compartment

Certain components in the engine compartment can be very hot, e.g. the engine, the radiator and parts of the exhaust system.

- ▶ Allow the engine to cool down and only touch component parts described in the following.

**⚠ WARNING** Danger of burns when opening the hood

If you open the hood when the engine has overheated or during a fire in the engine compartment, you could come into contact with hot gases or other escaping operating fluids.

- ▶ Before opening the hood, allow the engine to cool down.
- ▶ In the event of a fire in the engine compartment, keep the hood closed and call the fire service.

**⚠ WARNING** Risk of scalding from hot coolant

The engine cooling system is pressurized, particularly when the engine is warm. If you open the cap, you could be scalded by hot coolant spraying out.

- ▶ Let the engine cool down before opening the cap.
- ▶ When opening the cap, wear protective gloves and safety glasses.
- ▶ Open the cap slowly to release pressure.

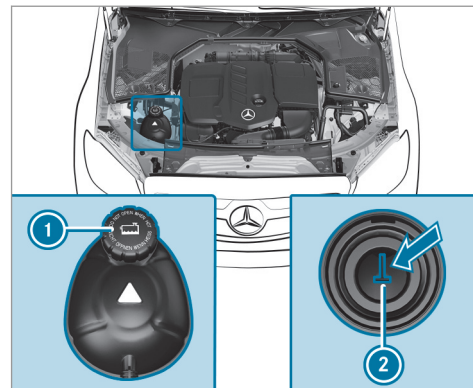

- ▶ Park the vehicle on a level surface.
- ▶ Check the coolant temperature display in the instrument cluster. The coolant temperature must be in the bottom quarter of the temperature display.
- ▶ Slowly turn cap ① counter-clockwise to relieve overpressure.

- ▶ Continue turning cap ① counter-clockwise and remove it.

The coolant level is correct in the following cases:

- if the engine is cold, up to marker bar ②
  - if the engine is warm, up to 0.6 in (1.5 cm) over marker bar ②
- ▶ If necessary, add coolant that has been approved for Mercedes-Benz.
- Further information on coolant (→ page 499).

### Adding washer fluid to the windshield washer system

**⚠ WARNING** Risk of burns from hot component parts in the engine compartment

Certain components in the engine compartment can be very hot, e.g. the engine, the radiator and parts of the exhaust system.

- ▶ Allow the engine to cool down and only touch component parts described in the following.

**⚠ WARNING** Danger of burns when opening the hood

If you open the hood when the engine has overheated or during a fire in the engine compartment, you could come into contact with hot gases or other escaping operating fluids.

- ▶ Before opening the hood, allow the engine to cool down.
- ▶ In the event of a fire in the engine compartment, keep the hood closed and call the fire service.

**⚠ WARNING** - Risk of fire and injury from windshield washer concentrate

Windshield washer concentrate is highly flammable. It could ignite if it comes into contact with hot engine component parts or the exhaust system.

- ▶ Make sure that no windshield washer concentrate spills out next to the filler opening.

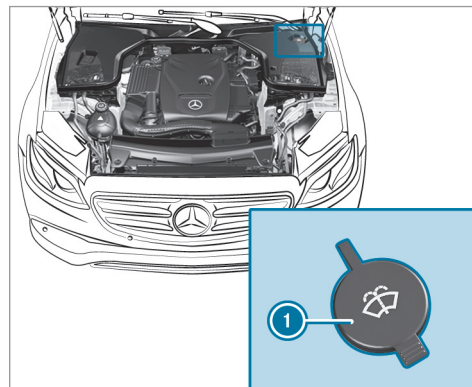

- ▶ Remove cap ① by the tab.
- ▶ Add washer fluid.

### Keeping the air-water duct free

- ▶ Keep the area between the hood and the windshield free of deposits, e.g. ice, snow and leaves.

### Cleaning and care

#### Notes on washing the vehicle in a car wash

**⚠ WARNING** Risk of accident due to reduced braking effect after washing the vehicle

The braking effect is reduced after washing the vehicle.

- ▶ After the vehicle has been washed, brake carefully while paying attention to the traffic conditions until the braking effect has been fully restored.

**!** **NOTE** Damage due to unsuitable car wash

- ▶ Before driving into a car wash make sure that the car wash is suitable for the vehicle dimensions.
- ▶ Ensure there is sufficient ground clearance between the underbody and the guide rails of the car wash.
- ▶ Ensure that the clearance width of the car wash, in particular the width of the guide rails, is sufficient.

To avoid damage to your vehicle when using a car wash, ensure the following beforehand:

- Active Distance Assist DISTRONIC and the HOLD function are deactivated.
- the 360° Camera or the rear view camera is switched off.
- the side windows and sliding sunroof are completely closed.
- the blower for the ventilation/heating is switched off.
- the windshield wiper switch is in position **0**.

- the SmartKey is at a minimum distance of 10 ft (3 m) away from the vehicle, otherwise the tailgate could open unintentionally.
- in car washes with a conveyor system: neutral **N** is engaged.

**i** In car washes with a conveyor system: if you would like to leave the vehicle while it is being washed, make sure the SmartKey is located in the vehicle. The park position **P** is otherwise automatically engaged.

**i** If, after the car wash, you remove the wax from the windshield and wiper rubbers, this will prevent smearing and reduce wiper noise.

#### Information on using a power washer

**⚠ WARNING** Risk of accident when using high-pressure cleaning equipment with round-spray nozzles

The water jet from a round-spray nozzle (dirt grinder) may cause damage to tires and suspension components that is not visible.

Components damaged in this way may fail unexpectedly.

- ▶ Do not use high-pressure cleaning equipment with round-spray nozzles to clean your vehicle.
- ▶ Damaged tires or suspension components must be replaced immediately.

To avoid damage to your vehicle, observe the following when using a power washer:

- Keep the SmartKey at least 10 ft (3 m) away from the vehicle. Otherwise the tailgate could open unintentionally.
- Maintain a distance of at least 11.8 in (30 cm) to the vehicle.
- **Vehicles with decorative foil:** parts of your vehicle are covered with a decorative foil. Maintain a distance of at least 27.6 in (70 cm) between the foil-covered parts of the vehicle and the nozzle of the power washer. Move the power washer nozzle around whilst cleaning. The water temperature of the power washer must not exceed 124 °F (60 °C).

- Observe the information on the correct distance in the equipment manufacturer's operating instructions.
- Do not point the nozzle of the power washer directly at sensitive parts such as tires, slits, electrical components, batteries, light bulbs and ventilation slots.

### Washing the vehicle by hand

Observe the legal requirements, e.g. in a number of countries, washing by hand is only permitted in specially designated wash bays.

- ▶ Use a mild cleaning agent, e.g. car shampoo.
- ▶ Wash the vehicle with lukewarm water using a soft car sponge. When doing so, do not expose the vehicle to direct sunlight.
- ▶ Carefully hose the vehicle off with water and dry using a chamois. Take care not to point the water jet directly towards the air inlet grille below the hood.

### Notes on paintwork/matte finish paintwork care

---

Observe the following information:

|                  | Cleaning and care  | Avoiding paintwork damage  |
|------------------|--|--|
| <b>Paintwork</b> | <ul style="list-style-type: none"><li>• Insect remains: soak with insect remover and rinse off the treated areas afterwards.</li><li>• Bird droppings: soak with water and rinse off afterwards.</li><li>• Tree resin, oils, fuels and greases: remove by rubbing gently with a cloth soaked in petroleum ether or lighter fluid.</li><li>• Coolant and brake fluid: remove with a damp cloth and clean water.</li><li>• Tar stains: use tar remover.</li><li>• Wax: use silicone remover.</li></ul> | <ul style="list-style-type: none"><li>• Do not attach stickers, films or similar materials.</li><li>• Remove dirt immediately, where possible.</li></ul> |



| Cleaning and care   |  | Avoiding paintwork damage   |
|---------------------|--|---|
| <b>Matte finish</b> | Only use care products approved for Mercedes-Benz. | <ul style="list-style-type: none"> <li>• Do not polish the vehicle and alloy wheels.</li> <li>• Only use car washes that correspond to the latest engineering standards.</li> <li>• Do not use car wash programs with a final hot wax treatment.</li> <li>• Do not use paint cleaners, buffing or polishing products, gloss preservers, e.g. wax.</li> <li>• Always have paintwork repairs carried out at a qualified specialist workshop.</li> </ul> |

### Notes on cleaning decorative foils

Observe the notes on matte finish care in the chapter "Notes on paintwork/matte finish paint-

work care" (→ page 430). They also apply to matte decorative foils.

**Observe the following information:**

| Cleaning   | Avoiding damage to the decorative foil  |
|--|---|
| <ul style="list-style-type: none"><li>• For cleaning, use plenty of water and a mild cleaning agent without additives or abrasive substances, e.g. a car shampoo approved for Mercedes-Benz.</li><li>• Remove dirt immediately, where possible, whilst avoiding rubbing too hard. There is otherwise a risk of damaging the decorative foil irreparably.</li><li>• If there is dirt on the finish or if the decorative foil is dull: use the Paint Cleaner recommended and approved for Mercedes-Benz.</li><li>• Insect remains: soak with insect remover and rinse off the treated areas afterwards.</li><li>• Bird droppings: soak with water and rinse off afterwards.</li><li>• To prevent water stains, dry a foil-wrapped vehicle with a soft, absorbent cloth after every car wash.</li></ul> | <ul style="list-style-type: none"><li>• The service life and color of decorative foils are impaired by:<ul style="list-style-type: none"><li>- Sunlight</li><li>- Temperature, e.g. hot air blower</li><li>- Weather conditions</li><li>- Stone chippings and dirt</li><li>- Chemical cleaning agents</li><li>- Oily products</li></ul></li><li>• Do not use polish on matte decorative foil. Polishing will have the effect of shining the foil-wrapped surface.</li><li>• Do not treat matte or structured decorative foils with wax. Permanent stains may occur.</li></ul> |

Scratches, corrosive deposits, areas affected by corrosion and damage caused by incorrect care cannot always be completely repaired. In such cases, visit a qualified specialist workshop.

You can obtain more information on care and cleaning products from the manufacturer.

In the case of foil-wrapped surfaces, optical differences may occur between the surfaces that were not protected by a decorative foil after removing a decorative foil.

**i** Have work or repairs to decorative foils carried out at a qualified specialist workshop, e.g. in an authorized Mercedes-Benz Center.

### Notes on care of vehicle parts

**⚠ WARNING** Risk of entrapment if the windshield wipers are switched on while the windshield is being cleaned

If the windshield wipers are set in motion while you are cleaning the windshield or wiper blades, you can be trapped by the wiper arm.

▶ Always switch off the windshield wipers and the ignition before cleaning the windshield or wiper blades.

**⚠ WARNING** Risk of burns from the tailpipe and tailpipe trims

The exhaust tailpipe and tailpipe trims can become very hot. If you come into contact

with these parts of the vehicle, you could burn yourself.

▶ Always be particularly careful around the tailpipe and the tailpipe trims and supervise children especially closely in this area.

▶ Allow vehicle parts to cool down before touching them.

### Observe the following information:

|                     | Notes on cleaning and care  | Avoiding vehicle damage   |
|---------------------|---|---|
| <b>Wheels/rims</b>  | Use water and acid-free wheel cleaners.   | <ul style="list-style-type: none"> <li>• Do not use acidic wheel cleaners to remove brake dust. This could damage wheel bolts and brake components.</li> <li>• To avoid corrosion of the brake discs and brakepads, drive the vehicle for a few minutes after cleaning before parking it. The brake discs and brakepads warm up and dry out.</li> </ul> |
| <b>Windows</b>      | Clean windows inside and outside with a damp cloth and with a cleaning agent recommended for Mercedes-Benz. | Do not use dry cloths or abrasive or solvent-based cleaning agents to clean the inside of windows.  |
| <b>Wiper blades</b> | Fold out the wiper blades and clean them using a damp cloth.  | Do not clean the wiper blades too often.  |

|   | Notes on cleaning and care   | Avoiding vehicle damage  |
|---|--|--|
| <b>Exterior lighting</b>                | Clean the lenses with a wet sponge and mild cleaning agent, e.g. car shampoo.  | Only use cleaning agents or cleaning cloths that are suitable for plastic lenses.  |
| <b>Sensors</b>                          | Clean the sensors in the front and rear bumper and in the radiator grill with a soft cloth and car shampoo.  | When using a power washer, maintain a minimum distance of 11.8 in (30 cm).   |
| <b>Side running boards</b>              | Use water and acid-free cleaning agents.   | Do not clean the aluminum trim inserts on the running board with alkaline or acidic cleaning agents. The aluminum trim inserts could otherwise be damaged. |
| <b>Rear view camera and 360° Camera</b> | <ul style="list-style-type: none"><li>• Open the camera cover with the multimedia system (→ page 232) .</li><li>• Use clean water and a soft cloth to clean the camera lens.</li></ul> | Do not use a power washer.   |
| <b>Tailpipes</b>                        | Clean with a cleaning agent recommended for Mercedes-Benz, especially in the winter and after washing the vehicle.   | Do not use acidic cleaning agents.   |

### Notes on care of the interior

**⚠ WARNING** Risk of injury from plastic parts breaking off after the use of solvent-based care products

Care and cleaning products containing solvents can cause surfaces in the cockpit to become porous.

When the airbags are deployed, plastic parts may break away.

- ▶ Do not use any care or cleaning products containing solvents to clean the cockpit.

**⚠ WARNING** Risk of injury or death from bleached seat belts

Bleaching or dyeing seat belts can severely weaken them.

This can, for example, cause seat belts to tear or fail in an accident.

- ▶ Never bleach or dye seat belts.

### Observe the following information:

|                     | Cleaning and care   | Avoiding vehicle damage  |
|---------------------|---|--|
| <b>Seat belts</b>   | Clean with lukewarm and soapy water.  | <ul style="list-style-type: none"> <li>• Do not use chemical cleaning agents.</li> <li>• Do not dry seat belts by heating them to over 176 °F (80 °C) or exposing them to direct sunlight.</li> </ul>              |
| <b>Display</b>      | Clean the surface carefully with a microfiber cloth and a suitable display care product (TFT/LCD).  | <ul style="list-style-type: none"> <li>• Switch off the display and let it cool down.</li> <li>• Do not use any other cleaning products.</li> </ul>  |
| <b>Plastic trim</b> | <ul style="list-style-type: none"> <li>• Clean with a damp microfiber cloth.</li> <li>• For heavy soiling: use care product recommended for Mercedes-Benz.</li> </ul> | <ul style="list-style-type: none"> <li>• Do not attach stickers, films or similar materials.</li> <li>• Do not allow cosmetics, insect repellent or sun cream to come in contact with the plastic trim.</li> </ul> |

|                                      | Cleaning and care  | Avoiding vehicle damage  |
|--------------------------------------|--|--|
| <b>Real wood/trim elements</b>       | <ul style="list-style-type: none"> <li>• Clean with a microfiber cloth.</li> <li>• Black piano-lacquer look: clean with a damp cloth and soapy water.</li> <li>• For heavy soiling: use care product recommended for Mercedes-Benz.</li> </ul> | Do not use solvent-based cleaning agents, polishes or waxes.   |
| <b>Headliner</b>                     | Clean with a brush or dry shampoo.   |  |
| <b>Carpet</b>                        | Use carpet and textile cleaning agents recommended for Mercedes-Benz.  |  |
| <b>Genuine leather seat covers</b>   | <ul style="list-style-type: none"> <li>• Clean with a damp cloth and then wipe with a dry cloth.</li> <li>• Leather care: use leather care agents that have been recommended for Mercedes-Benz.</li> </ul>                                     | <ul style="list-style-type: none"> <li>• Do not allow the leather to become too damp.</li> <li>• Do not use a microfiber cloth.</li> </ul> |
| <b>DINAMICA seat covers</b>          | Clean with a damp cloth.   | Do not use a microfiber cloth.   |
| <b>Imitation leather seat covers</b> | Clean with a damp cloth and 1% soapy water.  | Do not use a microfiber cloth.   |

## Emergency

### Removing the safety vest

The safety vests are located in the safety vest compartments in the driver's and front passenger door stowage compartments.

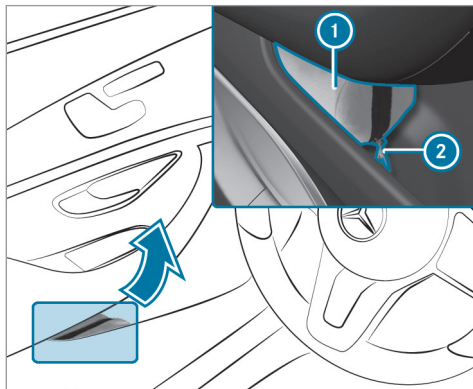

▶ **To remove:** pull out safety vest bag ① by loop ②.

▶ Open safety vest bag ① and pull out the safety vest.

① There are also safety vest compartments in the rear door stowage compartments in which safety vests can be stored.

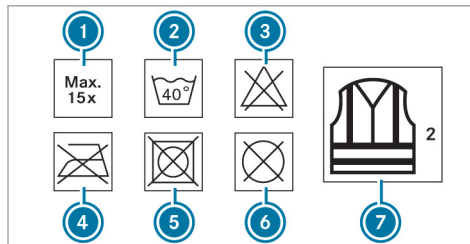

- ① Maximum number of washes
- ② Maximum wash temperature
- ③ Do not bleach
- ④ Do not iron
- ⑤ Do not tumble dry
- ⑥ Do not dry clean
- ⑦ Class 2 safety vest

The requirements defined by the legal standard are only fulfilled if the safety vest is the correct size and is fully closed.

The safety vest must be replaced in the following situations:

- the reflective strips are damaged or dirty
- the maximum permissible number of washes is exceeded
- the fluorescence has faded

## Flat tire

### Notes on flat tires

**⚠ WARNING** Risk of accident due to a flat tire

A flat tire severely affects the driving characteristics as well as the steering and braking of the vehicle.

#### Tires without run-flat characteristics:

- ▶ Do not drive on with a flat tire.
- ▶ Change the flat tire immediately with an emergency spare wheel or spare wheel.

Alternatively, consult a qualified specialist workshop.

#### Tires with run-flat characteristics:

- ▶ Observe the information and warning notes on MOExtended tires (run-flat tires).

In the event of a flat tire, the following options are available depending on your vehicle's equipment:

- **Vehicles with MOExtended tires:** it is possible to continue the journey for a short period of time. Make sure you observe the notes on MOExtended tires (run-flat tires) (→ page 438).
- **Vehicles with a TIREFIT kit:** you can repair the tire so that it is possible to continue the journey for a short period of time. To do this, use the TIREFIT kit (→ page 439).
- **Vehicles with Mercedes me connect:** you can make a call for breakdown assistance via the overhead control panel in the case of a breakdown (→ page 387).

- **All vehicles:** change the wheel (→ page 483).
- ⓘ The emergency spare wheel is only available in certain countries.

#### Notes on MOExtended tires (run-flat tire)

##### **⚠ WARNING** Risk of accident when driving in emergency mode

When driving in emergency mode, the handling characteristics are impaired. e.g. when cornering, when accelerating strongly and when braking.

- ▶ Do not exceed the permissible maximum speed for MOExtended tires.
- ▶ Avoid any abrupt steering and driving maneuvers as well as driving over obstacles (curbs, pot holes, off-road). This applies, in particular, to a loaded vehicle.
- ▶ Stop driving in the emergency mode if you notice:

- banging noise
- vehicle vibration
- smoke which smells like rubber
- continuous ESP® intervention
- cracks in tire side walls

- ▶ After driving in emergency mode have the rims checked by a qualified specialist workshop with regard to their further use.
- ▶ The defective tire must be replaced in every case.

With MOExtended tires (run-flat tire), you can continue to drive your vehicle even if there is a total loss of pressure in one or more tires. However, the tire affected must not show any clearly visible damage.

You can recognize MOExtended tires by the MOExtended marking which appears on the side wall of the tire.

**Vehicles with tire pressure loss system:** MOExtended tires may only be used in con-



junction with an activated tire pressure loss warning system.

**Vehicles with tire pressure monitoring system:** MOExtended tires may only be used in conjunction with an activated tire pressure monitoring system.

If a pressure loss warning message appears in the multifunction display, proceed as follows:

- Check the tire for damage.
- If driving on, observe the following notes.

**Driving distance possible in emergency mode after the pressure loss warning:**

| Load condition  | Driving distance possible in emergency mode |
|-----------------|---|
| Partially laden | 50 miles (80 km)                            |
| Fully laden     | 19 miles (30 km)                            |

The driving distance possible in emergency mode may vary depending on the driving style. Observe the maximum permissible speed of 50 mph (80 km/h).

If a tire has gone flat and cannot be replaced with an MOExtended tire, you can use a standard tire as a temporary measure.

### TIREFIT kit storage location

**Plug-in hybrid:** be sure to observe the notes in the Supplement. Otherwise, you may not recognize dangers.

The TIREFIT kit is located under the cargo compartment floor, under a cover on the left-hand side.

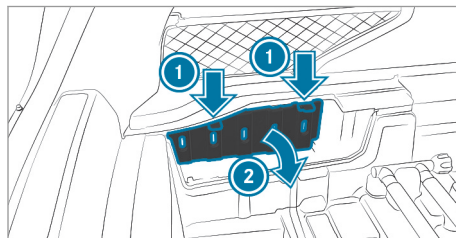

Push retaining clamps ① on the cover downwards to release them and fold out the cover in the direction of arrow ②.

### Using the TIREFIT kit

**Requirements:**

- Tire sealant bottle and tire inflation compressor (→ page 439).
- TIREFIT sticker
- Gloves (depending on the vehicle equipment)

You can use TIREFIT tire sealant to seal perforation damage of up to 0.16 in (4 mm), particularly those in the tire contact surface. You can use TIREFIT in outside temperatures down to  $-4^{\circ}\text{F}$  ( $-20^{\circ}\text{C}$ ).

**⚠ WARNING** Risk of accident when using tire sealant

In the following situations in particular, the tire sealant is unable to provide sufficient breakdown assistance, as it is unable to seal the tire properly:

- There are cuts or punctures in the tire larger than those previously mentioned.
- The wheel rim is damaged.

- You have driven at very low tire pressure or on a flat tire.
- ▶ Do not drive on.
- ▶ Consult a qualified specialist workshop.

**⚠ WARNING** Risk of injury and poisoning from tire sealant

The tire sealant is harmful and causes irritation. Do not allow it to come into contact with the skin, eyes or clothing, and do not swallow it. Do not inhale tire sealant fumes. Keep the tire sealant away from children.

If you come into contact with the tire sealant, observe the following:

- ▶ Rinse off the tire sealant from your skin immediately using water.
- ▶ If tire sealant gets into your eyes, thoroughly rinse out the eyes using clean water.
- ▶ If tire sealant has been swallowed, immediately rinse out the mouth thoroughly and drink plenty of water. Do not

induce vomiting and seek medical attention immediately.

- ▶ Change out of any clothes contaminated with tire sealant immediately.
- ▶ If allergic reactions occur, seek medical attention immediately.

**! NOTE** Overheating due to the tire inflation compressor running too long

- ▶ Do not run the tire inflation compressor for longer than ten minutes without interruption.

Comply with the manufacturer's safety notes on the sticker on the tire inflation compressor.

Have the tire sealant bottle replaced in a qualified specialist workshop every five years.

- ▶ Do not remove any foreign objects which have entered the tire.

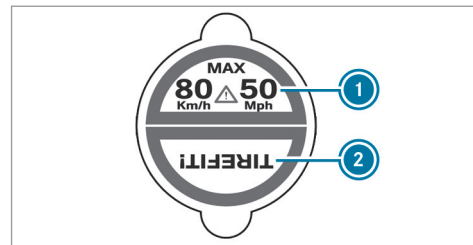

- ▶ Affix part ① of the TIREFIT sticker to the instrument cluster within the driver's field of vision.
- ▶ Affix part ② of the TIREFIT sticker near the valve on the wheel with the faulty tire.

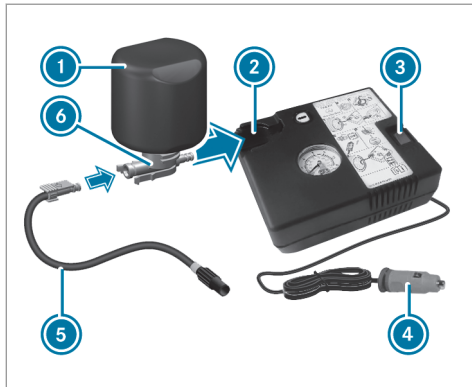

- ▶ Pull plug ④ with the cable and hose ⑤ out of the tire inflation compressor housing.
- ▶ Push the plug of hose ⑤ into flange ⑥ of tire sealant bottle ① until the plug engages.
- ▶ Place tire sealant bottle ① head downwards into recess ② of the tire inflation compressor.

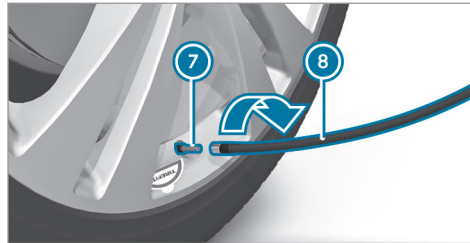

- ▶ Remove the valve cap from valve ⑦ on the faulty tire.
- ▶ Screw filling hose ⑧ onto valve ⑦.
- ▶ Insert plug ④ into a 12 V socket in your vehicle.
- ▶ Switch on the ignition.
- ▶ Press on and off switch ③ on the tire inflation compressor. The tire inflation compressor is switched on. The tire is inflated. First, tire sealant is pumped into the tire. The pressure may briefly rise to approximately 500 kPa (5 bar/73 psi).

**Do not switch off the tire inflation compressor during this phase.**

- ▶ Let the tire inflation compressor run for a maximum of ten minutes. The tire should then have attained a tire pressure of at least 200 kPa (2.0 bar / 29 psi).

If tire sealant leaks out, make sure you clean the affected area as quickly as possible. It is preferable to use clean water.

If you get tire sealant on your clothing, have it cleaned as soon as possible with perchloroethylene.

**If, after ten minutes, a tire pressure of 200 kPa (2.0 bar / 29 psi) has not been attained:**

- ▶ Switch off the tire inflation compressor.
- ▶ Unscrew the filling hose from the valve of the faulty tire.

Please note that tire sealant may leak out when unscrewing the filling hose.

## 442 Breakdown assistance

- ▶ Drive forwards or reverse very slowly for approximately 33 ft (10 m).
- ▶ Pump up the tire again.  
After a maximum of ten minutes the tire pressure must be at least 200 kPa (2.0 bar/29 psi).

**⚠ WARNING** Risk of accident due to the specified tire pressure not being achieved

If the specified tire pressure is not achieved after the specified time, the tire is too badly damaged. The tire sealant cannot repair the tire in this instance.

Damaged tires and a tire pressure that is too low can significantly impair braking and handling characteristics.

- ▶ Do not drive on.
- ▶ Consult a qualified specialist workshop.

**If, after ten minutes, a tire pressure of 200 kPa (2.0 bar/29 psi) has been attained:**

- ▶ Switch off the tire inflation compressor.

- ▶ Unscrew the filling hose from the valve of the faulty tire.

**⚠ WARNING** Risk of accident from driving with sealed tires

A tire temporarily sealed with tire sealant impairs driving characteristics and is not suitable for higher speeds.

- ▶ Adapt your driving style accordingly and drive carefully.
- ▶ Do not exceed the maximum speed limit with a tire that has been repaired using tire sealant.

- ▶ Observe the maximum permissible speed for a tire sealed with tire sealant 50 mph (80 km/h).
- ▶ Affix the upper section of the TIREFIT sticker to the instrument cluster in a location where it will be easily seen by the driver.

**! NOTE** Staining caused by leaking tire sealant

After use, excess tire sealant may leak out from the filling hose.

- ▶ Therefore, place the filling hose in the plastic bag that contained the TIREFIT kit.

**🔥 ENVIRONMENTAL NOTE** Environmental pollution caused by environmentally irresponsible disposal

Tire sealant contains pollutants.

- ▶ Have the tire sealant bottle disposed of professionally, e.g. at an authorized Mercedes-Benz Center.

- ▶ Stow the tire sealant bottle and the tire inflation compressor.
- ▶ **Pull away immediately.**

- ▶ Stop driving after approximately ten minutes and check the tire pressure using the tire inflation compressor. The tire pressure must now be at least 130 kPa (1.3 bar/ 19 psi).

**⚠ WARNING** Risk of accident due to the specified tire pressure not being reached

If the specified tire pressure is not reached after a brief drive, the tire is too badly damaged. The tire sealant cannot repair the tire in this instance.

Damaged tires and tire pressure that is too low can significantly impair the braking properties and the handling characteristics.

- ▶ Do not continue driving.
- ▶ Consult a qualified specialist workshop.

In cases such as the one mentioned above, contact an authorized Mercedes-Benz Center. Or call 1-800-FOR-MERCEdes (in the USA) or 1-800-387-0100 (in Canada).

- ▶ Correct the tire pressure if it is still at least 130 kPa (1.3 bar/ 19 psi). See the Tire and

Loading Information placard on the B-pillar on the driver's side or the tire pressure table in the fuel filler flap for values.

- ▶ **To increase the tire pressure:** switch on the tire inflation compressor.

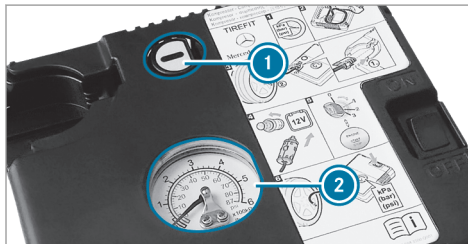

- ▶ **To reduce the tire pressure:** press pressure release button ① next to manometer ②.
- ▶ When the tire pressure is correct, unscrew the filling hose from the valve of the sealed tire.
- ▶ Screw the valve cap onto the valve of the sealed tire.

- ▶ Pull the tire sealant bottle out of the tire inflation compressor. The filling hose stays on the tire sealant bottle.
- ▶ Drive to the nearest qualified specialist workshop and have the tire, tire sealant bottle and filling hose replaced there.

## Battery (vehicle)

### Notes on the 12 V battery

**⚠ WARNING** Risk of an accident due to work carried out incorrectly on the battery

Work carried out incorrectly on the battery can, for example, lead to a short circuit. This can lead to function restrictions in safety-relevant systems, for example the lighting system, ABS (anti-lock braking system) or ESP® (Electronic Stability Program). The operating safety of your vehicle may be restricted.

You could lose control of the vehicle in the following situations:

- when braking
- in the event of abrupt steering maneuvers and/or when the vehicle's speed is not adapted to the road conditions
- ▶ In the event of a short circuit or a similar incident, contact a qualified specialist workshop immediately.
- ▶ Do not continue driving.
- ▶ Always have work on the battery carried out at a qualified specialist workshop.

- Further information on ABS (→ page 185)
- Further information on ESP® (→ page 186)

For safety reasons, Mercedes-Benz recommends that you only use batteries which have been tested and approved for your vehicle by Mercedes-Benz. These batteries provide increased impact protection to prevent vehicle occupants from suffering acid burns should the battery be damaged in the event of an accident.

#### All vehicles except vehicles with a lithium-ion battery

**⚠ WARNING** Risk of explosion due to electrostatic charge

Electrostatic charge can cause sparks which may ignite the highly flammable gas mixture in the battery.

- ▶ To discharge any electrostatic charge that may have built up, touch the metal vehicle body before handling the battery.

The highly flammable gas mixture is created while the battery is charging and during starting assistance.

**⚠ WARNING** Danger of chemical burns from the battery acid

Battery acid is caustic.

- ▶ Avoid contact with the skin, eyes or clothing.
- ▶ Do not lean over the battery.

- ▶ Do not inhale battery gases.
- ▶ Keep children away from the battery.
- ▶ Immediately rinse battery acid off thoroughly with plenty of clean water and seek medical attention immediately.

#### All vehicles

**🔥 ENVIRONMENTAL NOTE** Environmental damage caused by improper disposal of batteries



Batteries contain pollutants. It is illegal to dispose of them with the household rubbish.



Dispose of batteries in an environmentally responsible manner. Take discharged batteries to a qualified

specialist workshop or to a collection point for used batteries.

If you have to disconnect the 12 V battery, contact a qualified specialist workshop.

Comply with safety notes and take protective measures when handling batteries.



Risk of explosion.



Fire, open flames and smoking are prohibited when handling the battery. Avoid creating sparks.



Electrolyte or battery acid is corrosive. Avoid contact with the skin, eyes or clothing. Wear suitable protective clothing, in particular gloves, an apron and a face mask. Immediately rinse electrolyte or acid splashes off with clean water. Consult a doctor if necessary.



Wear safety glasses.



Keep children away.



Observe this Operator's Manual.

Observe the following if you do not intend to use the vehicle over an extended period of time:

- Activate standby mode.
- Alternatively: connect the battery to a battery charger approved by Mercedes-Benz or consult a qualified specialist workshop to disconnect the battery.

### Notes on starting assistance and on charging the 12 V battery

#### Vehicles with a lithium-ion battery

When charging the battery and during starting assistance, always use the jump-start connection point in the engine compartment.

**!** **NOTE** Damaging the battery through overvoltage

When charging using a battery charger without a maximum charging voltage, the battery or the vehicle electronics may be damaged.

▶ Only use battery chargers with a maximum charging voltage of 14.8 V.

#### All other vehicles

When charging the battery and during starting assistance, always use the jump-start connection point in the engine compartment.

**!** **NOTE** Damaging the battery through overvoltage

When charging using a battery charger without a maximum charging voltage, the battery or the vehicle electronics may be damaged.

- ▶ Only use battery chargers with a maximum charging voltage of 14.8 V.

**!** **WARNING** Risk of explosion from hydrogen gas igniting

A battery generates hydrogen gas during the charging process. If there is a short circuit or sparks start to form, there is a danger of the hydrogen gas igniting.

- ▶ Make sure that the positive terminal of the connected battery does not come into contact with vehicle parts.
- ▶ Never place metal objects or tools on a battery.
- ▶ When connecting and disconnecting the battery, you must observe the described order for the battery clamps.

- ▶ When giving starting assistance, always make sure that you only connect battery terminals with identical polarity.
- ▶ During starting assistance, you must observe the described order for connecting and disconnecting the jumper cables.
- ▶ Do not connect or disconnect the battery clamps while the engine is running.

**!** **WARNING** Risk of explosion during charging process and starting assistance

During the charging process and starting assistance, the battery may release an explosive gas mixture.

- ▶ Avoid fire, open flames, creating sparks and smoking.
- ▶ Make sure that there is sufficient ventilation during the charging process and during starting assistance.
- ▶ Do not lean over a battery.

**!** **WARNING** Risk of explosion from a frozen battery

A discharged battery may freeze at temperatures slightly above or below freezing point.

During starting assistance or battery charging, battery gas may be released.

- ▶ Always thaw a frozen battery out first before charging it or performing starting assistance.

If the indicator/warning lamps in the instrument cluster do not light up at low temperatures, it is very likely that the discharged battery has frozen. In this case you may neither jump-start the vehicle nor charge the battery.

The service life of a battery that has been thawed may be dramatically shortened. The starting characteristics may be impaired, especially at low temperatures.

It is recommended that you have a thawed battery checked at a qualified specialist workshop.



**Plug-in hybrid:** be sure to observe the notes in the Supplement. Otherwise, you may fail to recognize dangers.

#### All vehicles

**!** **NOTE** Damage caused by numerous or extended attempts to start the engine

Numerous or extended attempts to start the engine may damage the catalytic converter due to non-combusted fuel.

▶ Avoid numerous and extended attempts to start the engine.

Observe the following points during starting assistance and when charging the battery:

- Only use undamaged jumper cables/charging cables with a sufficient cross-section and insulated terminal clamps.
- Non-insulated parts of the terminal clamps must not come into contact with other metal parts while the jumper cable/charging cable is connected to the battery/jump-start connection point.

- The jumper cable/charging cable must not come into contact with any parts which may move when the engine is running.
- Always make sure that neither you nor the battery is electrostatically charged.
- Keep away from fire and open flames.
- Do not lean over the battery.

Observe the additional following points when charging the battery:

- Only use battery chargers tested and approved for Mercedes-Benz.
- Read the battery charger's operating instructions before charging the battery.

Observe the additional following points during starting assistance:

- Starting assistance may be performed using only batteries with a nominal voltage of 12 V.
- The vehicles must not touch.
- **Vehicles with a gasoline engine:** Jump-start the vehicle only when the engine and exhaust system are cold.

### Starting assistance and charging the 12 V battery

#### Requirements:

- The vehicle is secured with the electric parking brake.
- **Vehicles with automatic transmission:** The transmission is in position **P**.
- The ignition and all electrical consumers are switched off.
- The hood is open.

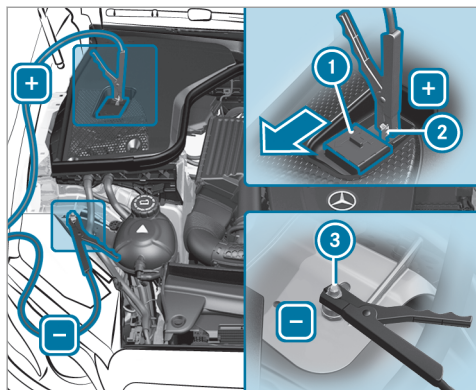

Example: engine compartment

- ▶ Slide cover ① of positive clamp ② on the jump-starting connection point in the direction of the arrow.
- ▶ Connect positive clamp ② on your vehicle to the positive pole of the donor battery using the jumper cable/charging cable. Always

begin with positive clamp ② on your own vehicle first.

- ▶ **During starting assistance:** start the engine of the donor vehicle and run at idle speed.
- ▶ Connect the negative pole of the donor battery and ground point ③ of your own vehicle by using the jumper cable/charging cable. Begin with the donor battery first.
- ▶ **During starting assistance:** start the engine of your own vehicle.
- ▶ **During the charging process:** start the charging process.
- ▶ **During starting assistance:** let the engines run for several minutes.
- ▶ **During starting assistance:** before disconnecting the jumper cable, switch on an electrical consumer in your own vehicle, e.g. the rear window heater or lighting.

When the starting assistance/charging process is complete, perform the following steps:

- ▶ First, remove the jumper cable/charging cable from ground point ③ and the negative pole of the donor battery, then from positive clamp ② and the positive pole of the donor battery. Begin each time with the contacts on your own vehicle first.
- ▶ After removing the jumper cable/charging cable, close cover ① of positive clamp ②.

Further information can be obtained at a qualified specialist workshop.

### Replacing the 12 V battery

- ▶ Observe the notes on the 12 V battery (→ page 443).

Mercedes-Benz recommends that you have the 12 V battery replaced at a qualified specialist workshop, e.g. at an authorized Mercedes-Benz Center.

Observe the following notes if you want to replace the battery yourself:

- Always replace a faulty battery with a battery which meets the specific vehicle requirements.

The vehicle is equipped with an AGM technology battery (Absorbent Glass Mat) or a lithium-ion battery. Full vehicle functionality is only guaranteed with an AGM battery or lithium-ion battery. For safety reasons, Mercedes-Benz recommends that you only use batteries which have been tested and approved for your vehicle by Mercedes-Benz.

- Carry over detachable parts, such as vent hoses, elbow fitting or terminal covers from the battery being replaced.

- Make sure that the vent hose is always connected to the original opening on the side of the battery.

Install any existing or supplied cell caps.

Otherwise, gases or battery acid could escape.

- Make sure that detachable parts are reconnected in the same way.

### Tow starting or towing away

#### Permitted towing methods

**Plug-in hybrid:** be sure to observe the notes in the Supplement. Otherwise, you may fail to recognize dangers.



Mercedes-Benz recommends transporting your vehicle in the case of a breakdown, rather than towing it away.

For towing, use a tow rope or tow bar with both axles on the ground. Do not use tow bar systems.

**!** **NOTE** Damage to the vehicle due to towing away incorrectly

**▶** Observe the instructions and notes on towing away.

## Permitted towing methods

| Vehicle equipment/towing method      | <br>Both axles on the ground | <br>Front axle raised | <br>Rear axle raised |
|--------------------------------------|---|--|---|
| Vehicles with manual transmission    | Yes, maximum 31 miles (50 km) at 31 mph (50 km/h)   | Yes, maximum 31 miles (50 km) at 31 mph (50 km/h)  | Yes, maximum 31 miles (50 km) at 31 mph (50 km/h)   |
| Vehicles with automatic transmission | Yes, maximum 31 miles (50 km) at 31 mph (50 km/h)   | No   | Yes, if the steering wheel is fixed in the center position with a steering wheel lock.                  |
| 4MATIC vehicles                      | Yes, maximum 31 miles (50 km) at 31 mph (50 km/h)   | No   | No  |

**To tow with a raised axle:** towing should be performed by a towing company.

### Towing the vehicle with both axles on the ground

► Observe the notes on the permitted towing methods (→ page 449).

► Make sure that the battery is connected and charged.

Observe the following points when the battery is discharged:

- The engine cannot be started
- The electric parking brake cannot be released or applied

- **Vehicles with automatic transmission:** The automatic transmission cannot be shifted to position **N** or **P**.

**i Vehicles with automatic transmission:** If the automatic transmission cannot be shifted to position **N**, or the multifunction display in the instrument cluster does not show anything, have the vehicle transported away (→ page 452). A towing vehicle with lifting equipment is required for vehicle transportation.

**!** **NOTE** Damage due to towing away at excessively high speeds or over long distances

The drivetrain could be damaged when towing at excessively high speeds or over long distances.

- ▶ A towing speed of 30 mph (50 km/h) must not be exceeded.
- ▶ A towing distance of 30 miles (50 km) must not be exceeded.

**!** **WARNING** Risk of accident when towing a vehicle which is too heavy

If the vehicle being tow-started or towed away is heavier than the permissible gross mass of your vehicle, the following situations can occur:

- The towing eye may become detached.
- The vehicle/trailer combination may swerve or even overturn.

▶ If another vehicle is tow-started or towed away, its weight must not exceed the permissible gross mass of your own vehicle.

If a vehicle must be tow-started or towed away, its permissible gross weight must not exceed the permissible gross weight of the towing vehicle.

▶ Information on the permissible gross mass of the vehicle can be found on the vehicle identification plate (→ page 494).

▶ **Vehicles with automatic transmission:** Do not open the driver's door or front passenger

door, otherwise the automatic transmission automatically shifts to position **P**.

▶ Install the towing eye (→ page 454).

▶ Fasten the tow bar.

**!** **NOTE** Damage due to incorrect connection of the tow bar

▶ Only connect the tow rope or tow bar to the towing eyes.

▶ Deactivate the automatic locking mechanism (→ page 72).

▶ Do not activate the HOLD function.

▶ Deactivate the tow-away alarm (→ page 92).

▶ Deactivate Active Brake Assist (→ page 197).

▶ **Vehicles with automatic transmission:** Shift the automatic transmission to position **N**.

▶ Release the electric parking brake.

**⚠ WARNING** Risk of accident due to limited safety-related functions during the towing process

Safety-related functions are limited or no longer available in the following situations:

- the ignition is switched off.
- the brake system or power steering system is malfunctioning.
- the energy supply or the on-board electrical system is malfunctioning.

When your vehicle is then towed away, significantly more effort may be required to steer and brake than is normally required.

- ▶ Use a tow bar.
- ▶ Make sure that the steering wheel can move freely, before towing the vehicle away.

**!** **NOTE** Damage due to excessive tractive power

If you pull away sharply, the tractive power may be too high and the vehicles could be damaged.

- ▶ Pull away slowly and smoothly.

### Loading the vehicle for transport

- ▶ Observe the notes on towing away (→ page 450).
- ▶ Connect the tow bar to the towing eye in order to load the vehicle.
- i** You can also attach the tow bar to the trailer hitch.
- ▶ **Vehicles with automatic transmission:** Shift the automatic transmission to position **N**.
- i** **Vehicles with automatic transmission:** The automatic transmission may be locked in position **P** in the event of damage to the electrical system. To shift to **N**, provide the

on-board electrical system with power (→ page 447).

- ▶ Load the vehicle onto the transporter.
- ▶ **Vehicles with automatic transmission:** Shift the automatic transmission to position **P**.
- ▶ Use the electric parking brake to secure the vehicle against rolling away.
- ▶ Only secure the vehicle by the wheels.

### AMG vehicles with ADS PLUS (Adaptive Damping System PLUS)

**⚠ WARNING** Risk of an accident when transporting vehicles with Adaptive Damping System PLUS

The reduced damping forces on the vehicle being transported can cause the vehicle/trailer combination to start to swing.

As a result, when transporting vehicles with the Adaptive Damping System PLUS, the vehicle/trailer combination may start to skid. Consequently, you could lose control of your vehicle.

- ▶ When transporting, ensure that:
  - The vehicle has been loaded onto the transporter correctly
  - The vehicle is secured at all four wheels with suitable tensioning straps
  - The maximum permissible speed of 35 mph (60 km/h) is not exceeded when transporting

**!** **NOTE** Damage to the vehicle from securing it incorrectly

- ▶ After loading, the vehicle must be secured on all four wheels. Otherwise, the vehicle could be damaged.
- ▶ A minimum distance of 8 in (20 cm) upwards and 4 in (10 cm) downwards must be kept to the transport platform.

- ▶ Secure the vehicle on all four wheels after loading.

#### 4MATIC vehicles/vehicles with automatic transmission

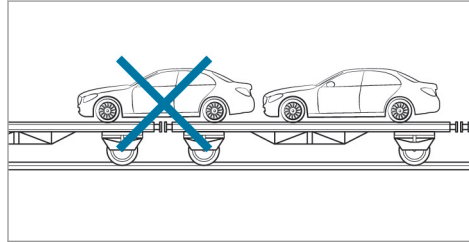

- ▶ Make sure that the front and rear axles come to rest on the same transportation vehicle.

**!** **NOTE** Damage to the drivetrain due to incorrect positioning

- ▶ Do not position the vehicle above the connection point of the transport vehicle.

#### Towing eye storage location

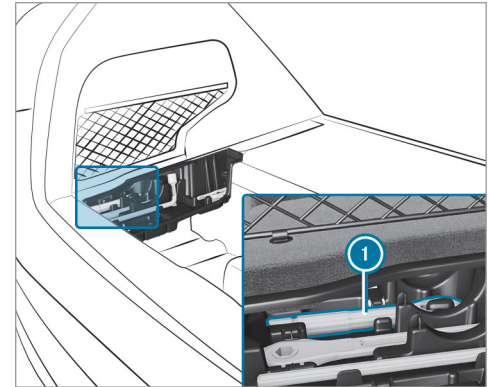

Towing eye ① is under the cargo compartment floor.

### Installing the towing eye

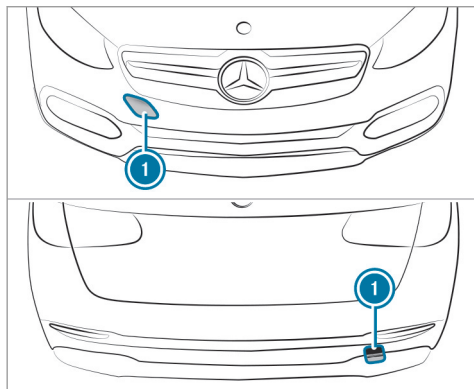

- ▶ Press the mark on cover ❶ inwards and remove.
- ▶ Screw in the towing eye clockwise as far as it will go and tighten.

**Vehicles with a trailer hitch:** Vehicles with a trailer hitch do not have a rear bracket for the

towing eye. Fasten the tow bar to the trailer hitch.

- ❶ Make sure that cover ❶ engages in the bumper when you remove the towing eye.

**!** **NOTE** Damage to the vehicle due to incorrect use of the towing eye

When a towing eye is used to recover a vehicle, the vehicle may be damaged in the process.

- ▶ Only use the towing eye to tow away or tow start the vehicle.

### Tow starting the vehicle (emergency engine start)

#### Vehicles with automatic transmission

**!** **NOTE** Damage to the automatic transmission due to tow starting

The automatic transmission may be damaged in the process of tow starting vehicles with automatic transmission.

- ▶ Vehicles with automatic transmission must not be tow started.

- ▶ Vehicles with automatic transmission must not be tow-started.

### Electrical fuses

#### Notes on electrical fuses

**!** **WARNING** Risk of accident and injury due to overloaded lines

If you manipulate or bridge a faulty fuse or if you replace it with a fuse with a higher amperage, the electric line could be overloaded.

This could result in a fire.

- ▶ Always replace faulty fuses with specified new fuses containing the correct amperage.



**!** NOTE Damage due to incorrect fuses

Electrical components or systems may be damaged by incorrect fuses, or their functionality may be significantly impaired.

- ▶ Only use fuses that have been approved by Mercedes-Benz and which have the correct fuse rating.

Blown fuses must be replaced with fuses of the same rating, which you can recognize by the color and fuse rating. The fuse ratings and further information to be observed can be found in the fuse assignment diagram.

**Fuse assignment diagram:** on the fuse box in the cargo compartment (→ page 457).

**!** NOTE Damage or malfunctions caused by moisture

Moisture may cause damage to the electrical system or cause it to malfunction.

- ▶ When the fuse box is open, make sure that no moisture can enter the fuse box.
- ▶ When closing the fuse box, make sure that the seal of the lid is positioned correctly on the fuse box.

If the newly inserted fuse also blows, have the cause traced and rectified at a qualified specialist workshop.

Ensure the following before replacing a fuse:

- The vehicle is secured against rolling away.
- All electrical consumers are switched off.
- The ignition is switched off.

The electrical fuses are located in various fuse boxes:

- Fuse box in the engine compartment on the driver's side (→ page 455)
- Fuse box on the driver's side of the cockpit (→ page 456)
- Fuse box in the front passenger footwell (→ page 456)

- Fuse box in the cargo compartment on the right-hand side of the vehicle, when viewed in the direction of travel (→ page 457)

### Opening and closing the fuse box in the engine compartment

#### Requirements:

- A dry cloth and a screwdriver are available.

Observe the notes on electrical fuses (→ page 454).

#### Opening

**!** WARNING Risk of injury from using the windshield wipers while the engine hood is open

When the engine hood is open and the windshield wipers are set in motion, you can be trapped by the wiper linkage.

- ▶ Always switch off the windshield wipers and ignition before opening the engine hood.

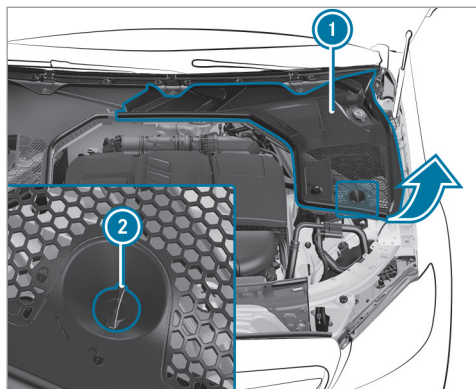

- ▶ Turn clip ② on cover ① a quarter-turn to the left.
- ▶ Fold cover ① up in the direction of the arrow.

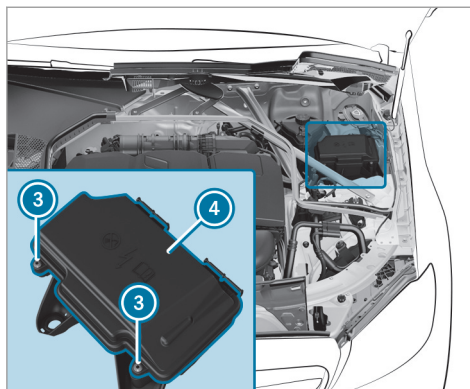

- ▶ Remove any existing moisture from the fuse box using a dry cloth.
- ▶ Loosen screws ③ and remove fuse box lid ④ from the top.

#### Closing

- ▶ Check whether the seal is positioned correctly in lid ④.

- ▶ Insert lid ④ into the bracket at the rear of the fuse box.
- ▶ Fold down lid ④ of the fuse box and tighten screws ③.
- ▶ Fold down cover ①.
- ▶ Turn clip ② on cover ① a quarter-turn to the right.
- ▶ Close the hood.

#### Opening and closing the fuse box in the cockpit

The fuse box is on the side of the dashboard under a cover.

- ▶ Contact an authorized Mercedes-Benz Center for further information.

#### Opening and closing the fuse box in the front passenger footwell

Observe the notes on electrical fuses (→ page 454).

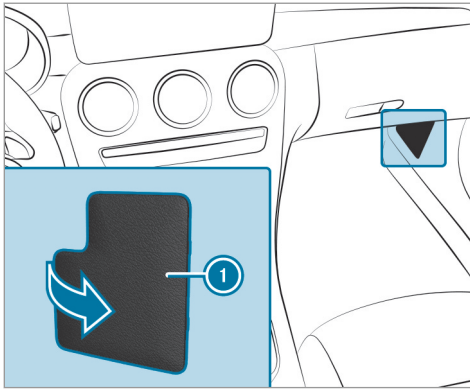

- ▶ Open cover ❶ in the direction of the arrow and remove it.

### Opening and closing the fuse box in the cargo compartment

Observe the notes on electrical fuses  
(→ page 454).

- ▶ Open the cargo compartment floor  
(→ page 119).

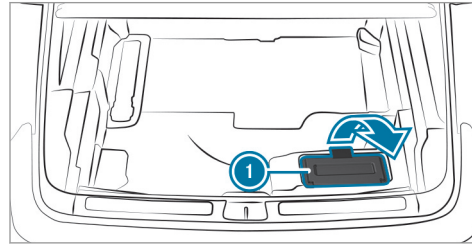

- ▶ Fold cover ❶ up in the direction of the arrow.

The fuse allocation chart is on the side of the fuse box.

### Notes on noise or unusual handling characteristics

While driving, pay attention to vibrations, noises and unusual handling characteristics, e.g. pulling to one side. This may indicate that the wheels or tires are damaged. If you suspect that a tire is defective, reduce your speed immediately. Stop the vehicle as soon as possible to check the wheels and tires for damage. Hidden tire damage could also be causing the unusual handling characteristics. If you find no signs of damage, have the tires and wheels checked at a qualified specialist workshop.

### Notes on regularly inspecting wheels and tires

**⚠ WARNING** Risk of accident from damaged tires

Damaged tires can cause tire pressure loss. As a result, you could lose control of your vehicle.

▶ Check the tires regularly for signs of damage and replace any damaged tires immediately.

**⚠ WARNING** Risk of aquaplaning due to insufficient tire tread

Insufficient tire tread will result in reduced tire grip. The tire tread is no longer able to dissipate water.

This means that in heavy rain or slush the risk of hydroplaning is increased, in particular if vehicle speed is not adapted to suit the conditions.

If the tire pressure is too high or too low, tires may exhibit different levels of wear at different locations on the tire contact surface.

▶ Thus, you should regularly check the tread depth and the condition of the tire contact surface across the entire width of all tires.

Minimum tread depth for:

- Summer tires:  $\frac{1}{8}$  in (3 mm)
- M+S tires:  $\frac{1}{8}$  in (4 mm)

▶ For safety reasons, replace the tires before the legally prescribed limit for the minimum tread depth is reached.

Carry out the following checks on all wheels regularly, at least once a month or as required, e.g. prior to a long journey or driving off-road:

- Check the tire pressure (→ page 460).
  - Visually inspect wheels and tires for damage.
  - Check the valve caps.
- The valves must be protected against moisture and dirt by the valve caps approved especially for your vehicle by Mercedes-Benz.
- Visual check of the tire tread depth and the tire contact surface across the entire width.

The minimum tread depth for summer tires is  $\frac{1}{8}$  in (3 mm) and for winter tires  $\frac{1}{8}$  in (4 mm).

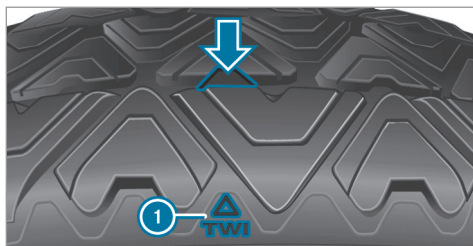

Six marks ① show where the bar indicators (arrow) are integrated into the tire tread. They are visible once a tread depth of approximately  $\frac{1}{16}$  in (1.6 mm) has been reached.

### Notes on snow chains

**⚠ WARNING** Risk of accident due to incorrect mounting of snow chains

If you have mounted snow chains to the front wheels, the snow chains may drag against the vehicle body or chassis components.

This could cause damage to the vehicle or the tires.

- ▶ Never mount snow chains on the front wheels.
- ▶ Only mount snow chains on the rear wheels in pairs.

**!** **NOTE** Damage to the wheel trim from mounted snow chains

If snow chains are mounted to steel wheels, the wheel trims can be damaged.

- ▶ Remove the wheel trims of steel wheels before mounting snow chains.

Observe the following notes when using snow chains:

- Snow chains are only permissible for certain wheel/tire combinations. You can obtain information about this from an authorized Mercedes-Benz Center.
- For safety reasons, only use snow chains that have been specifically approved for your

vehicle by Mercedes-Benz, or snow chains with the same quality standard.

- If snow chains are installed, the maximum permissible speed is 30 mph (50 km/h).
  - **Vehicles with Active Parking Assist:** Do not use Active Parking Assist when snow chains are installed.
  - **Vehicles with level control:** If snow chains are installed, only drive at raised vehicle level.
- ① You can deactivate ESP® to pull away (→ page 190). This allows the wheels to spin, achieving an increased driving force.

## Tire pressure

### Notes on tire pressure

**⚠ WARNING** Risk of accident due to insufficient or excessive tire pressure

Underinflated or overinflated tires pose the following risks:

- The tires may burst, especially as the load and vehicle speed increase.
  - The tires may wear excessively and/or unevenly, which may greatly impair tire traction.
  - The driving characteristics, as well as steering and braking, may be greatly impaired.
- Comply with the recommended tire pressure and check the tire pressure of all tires including the spare wheel regularly:
- at least once a month
  - when the load changes

- before embarking on a longer journey
  - if operating conditions change, e.g. off-road driving
- Adjust the tire pressure as necessary.

Tire pressure which is too high or too low can:

- Shorten the service life of the tires.
- Cause increased tire damage.
- Adversely affect driving characteristics and thus driving safety, e.g. due to hydroplaning.

**⚠ WARNING** Risk of an accident due to insufficient tire pressure

Tires with pressure that is too low can overheat and burst as a result.

In addition, they also suffer from excessive and/or irregular wear, which can significantly impair the braking properties and the handling characteristics.

- Avoid excessively low tire pressures in all the tires, including the spare wheel.

Tire pressure which is too low can cause:

- Tire defects as a result of overheating.
- Impaired handling characteristics.
- Irregular wear.
- Increased fuel consumption.

**⚠ WARNING** Risk of accident from excessive tire pressure

Tires with excessively high pressure can burst because they are damaged more easily by highway fill, pot holes etc.

In addition, they also suffer from irregular wear, which can significantly impair the braking properties and the handling characteristics.

- Avoid excessively high tire pressures in all the tires, including the spare wheel.

Tire pressure which is too high can cause:

- Increased braking distance.
- Impaired handling characteristics.
- Irregular wear.

- Impaired driving comfort.
- Susceptibility to damage.

**▲ WARNING** Risk of accident caused by repeated drop in tire pressure

If the tire pressure drops repeatedly, the wheel, valve or tire may be damaged.

Insufficient tire pressure can cause the tires to burst.

- ▶ Inspect the tire for signs of foreign objects.
- ▶ Check whether the wheel or valve has a leak.
- ▶ If you are unable to rectify the damage, contact a qualified specialist workshop.

You can find information on tire pressure for the vehicle's factory-installed tires on the following labels:

- Tire and Loading Information placard on the B-pillar of your vehicle (→ page 467).
- Tire pressure table on the inside of the fuel filler flap (→ page 461).

Observe the maximum tire pressure (→ page 473).

Use a suitable pressure gauge to check the tire pressure. The outer appearance of a tire does not permit any reliable conclusion about the tire pressure.

**Vehicles with a tire pressure monitoring system:** You can also check the tire pressure using the on-board computer.

Only correct tire pressure when the tires are cold. Conditions for cold tires:

- The vehicle has been parked with the tires out of direct sunlight for at least three hours.
- The vehicle has traveled less than 1 mile (1.6 km).

A rise in the tire temperature of 18 °F (10 °C) increases the tire pressure by approx. 10 kPa (0.1 bar/1.5 psi). Take this into account when checking the tire pressure of warm tires.

The tire pressure recommended for increased load/speed in the tire pressure table can affect the ride comfort.

**▲ WARNING** Risk of accident due to unsuitable accessories on tire valve

If you mount unsuitable accessories onto tire valves, the tire valves may be overloaded and malfunction, which can cause a loss of tire pressure. Aftermarket tire pressure monitoring systems will cause the tire valve to remain open, depending on the design. This can also result in a loss of tire pressure.

- ▶ Only screw standard valve caps or valve caps specifically approved by Mercedes-Benz for your vehicle onto the tire valve.

**Trailer operation notes**

Always inflate the rear axle tires to the recommended tire pressure on the tire pressure table for increased load.

**Tire pressure table**

The tire pressure table is on the inside of the fuel filler flap.

- ⓘ The data shown in the images is example data.

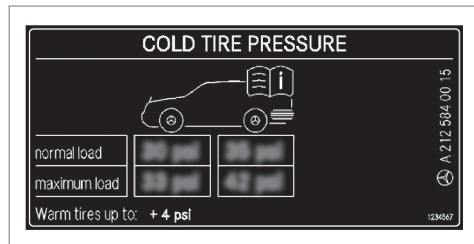

The tire pressure table shows the recommended tire pressure for all tires approved for this vehicle. The recommended tire pressures apply for cold tires under various operating conditions, i.e. loading and/or speed of the vehicle.

If one or more tire sizes precede a tire pressure, the tire pressure information following is only valid for those tire sizes.

The load conditions "partially laden" and "fully laden" are defined in the table for different numbers of passengers and amounts of luggage. The actual number of seats may differ from this.

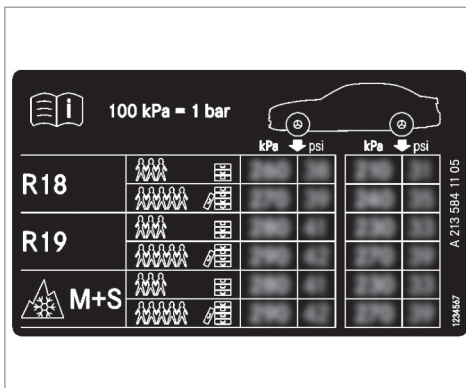

Some tire pressure tables only show the rim diameter instead of the complete tire size, e.g. **R18**. The rim diameter is part of the tire size and can be found on the tire side wall (→ page 474).

Be sure to also observe the following further related subjects:

- Notes on tire pressure (→ page 460)
- Tire and Loading Information placard (→ page 467)

- Maximum tire pressure (→ page 473)

### Checking tire pressures manually

- ▶ Read the tire pressure for the current operating conditions from the Tire and Loading Information placard or the tire pressure table. Observe the notes on tire pressure.
- ▶ Remove the valve cap of the tire to be checked.
- ▶ Press the tire pressure gauge securely onto the valve.
- ▶ Read the tire pressure.
- ▶ If the tire pressure is lower than the recommended value, increase the tire pressure to the recommended value.
- ▶ If the tire pressure is higher than the recommended value, release air. To do so, press down the metal pin in the valve, e.g. using the tip of a pen for example. Then check the tire pressure again using the tire pressure gauge.
- ▶ Screw the valve cap onto the valve.



Further related subjects:

- Notes on tire pressure (→ page 460)
- Tire pressure table (→ page 461)
- Tire and Loading Information placard (→ page 467)

### Tire pressure monitoring system

#### Function of the tire pressure monitoring system

**▲ DANGER** Risk of accident due to incorrect tire pressure

Each tire, including the spare (if provided), should be checked monthly when cold and inflated to the inflation pressure recommended by the vehicle manufacturer on the vehicle placard or tire inflation pressure label. (If your vehicle has tires of a different size than the size indicated on the vehicle placard or the tire inflation pressure label, you should determine the proper tire inflation pressure for those tires).

As an added safety feature, your vehicle has been equipped with a tire pressure monitoring system (TPMS) that illuminates a low tire pressure telltale when one or more of your tires is significantly under-inflated. Accordingly, when the low tire pressure telltale illuminates, you should stop and check your tires as soon as possible, and inflate them to the proper pressure. Driving on a significantly under-inflated tire causes the tire to overheat and can lead to tire failure. Under-inflation also reduces fuel efficiency and tire tread life, and may affect the vehicle's handling and stopping ability.

Please note that the TPMS is not a substitute for proper tire maintenance, and it is the driver's responsibility to maintain correct tire pressure, even if under-inflation has not reached the level to trigger illumination of the TPMS low tire pressure telltale.

Your vehicle has also been equipped with a TPMS malfunction indicator to indicate when the system is not operating properly. The TPMS malfunction indicator is combined with

the low tire pressure telltale. When the system detects a malfunction, the telltale will flash for approximately one minute and then remain continuously illuminated. This sequence will continue upon subsequent vehicle start-ups as long as the malfunction exists.

When the malfunction indicator is illuminated, the system may not be able to detect or signal low tire pressure as intended. TPMS malfunctions may occur for a variety of reasons, including the installation of replacement or alternate tires or wheels on the vehicle that prevent the TPMS from functioning properly.

Always check the TPMS malfunction telltale after replacing one or more tires or wheels on your vehicle to ensure that the replacement or alternate tires and wheels allow the TPMS to continue to function properly.

The system checks the tire pressure and the tire temperature of the tires installed on the vehicle by means of a tire pressure sensor.

New tire pressure sensor, e.g. in winter tires, are automatically taught-in during the first journey they are used.

The tire pressure and the tire temperature appear in the multifunction display (→ page 464).

If there is a substantial pressure loss or if the tire temperature is excessive, you will be warned in the following ways:

- via display messages (→ page 546)
- via the  warning lamp in the instrument cluster (→ page 566)

The tire pressure monitoring system is only an aid. It is the driver's responsibility to set the tire pressure to the recommended cold tire pressure suitable for the operating situation. Set the tire pressure for cold tires using a tire pressure gauge. Note that the correct tire pressure for the current operating situation must first be taught-in to the tire pressure monitoring system.

In most cases, the tire pressure monitoring system will automatically update the new reference values after you have changed the tire pressure. You can, however, also update the reference val-

ues by restarting the tire pressure monitoring system manually (→ page 465).

### System limits

The system may be impaired or may not function in the following situations:

- the tire pressure has been set incorrectly
- there is a sudden pressure loss caused, for example, by a foreign object penetrating the tire
- there is a malfunction caused by another radio signal source

Make sure to observe the following further related subject:

- notes on tire pressure (→ page 460)

### Checking the tire pressure with the tire pressure monitoring system

#### Requirements:

- The ignition is switched on.

On-board computer:

➔ [Service](#) ➔ [Tires](#)

One of the following displays appears:

- Current tire pressure and tire temperature of the individual wheels:

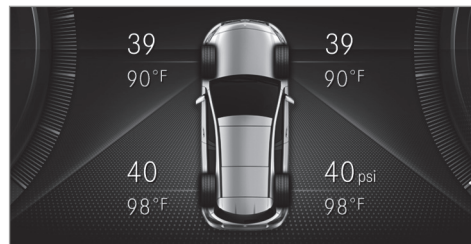

- [Tire pressure will be displayed after driving a few minutes](#)
  - [Tire Pressure Monitor Active](#): the teach-in process of the system is not yet complete. The tire pressures are already being monitored.
- ▶ Compare the tire pressure with the recommended tire pressure for the current operat-

ing condition (→ page 461). Observe the notes on tire temperature (→ page 460).

- ① The values displayed in the multifunction display may deviate from those of the tire pressure gauge as they refer to sea level. At high altitudes, the tire pressure value indicated by a pressure gauge are higher than those shown by the on-board computer. In this case, do not reduce the tire pressure.

Make sure to observe the following further related subject:

- Notes on tire pressure (→ page 460)

### Restarting the tire pressure monitoring system

#### Requirements:

- The recommended tire pressure is correctly set for the respective operating status on each of the four wheels (→ page 460).

Restart the tire pressure monitoring system in the following situations:

- The tire pressure has changed.
- The wheels or tires have been changed or newly installed.

On-board computer:

→ Service ▶ Tires

- ▶ Swipe downwards on Touch Control on the left-hand side of the steering wheel. The **Use Current Pressures as New Reference Values?** message is shown in the multifunction display.
- ▶ To begin restart, press Touch Control on the left-hand side of the steering wheel. The **Tire Press. Monitor Restarted** message is shown in the multifunction display. Current warning messages are deleted and the yellow  warning lamp goes out. After you have been driving for a few minutes, the system checks whether the current tire pressures are within the specified range. The current tire pressures are then accepted as reference values and monitored.

Make sure to observe the following further related subject:

- Notes on tire pressure (→ page 460)

### Radio-equipment approval of the tire pressure monitoring system

#### Radio equipment approval numbers

| Country | Radio type approval number                                  |
|---------|---|
| Canada  | IC: 2546A-GG4T<br>IC: 2546A-DG6W2D4<br>IC: 2546A-MC34MA4    |
| USA     | FCC ID: MRXGG4T<br>FCC ID: MRXDG6W2D4<br>FCC ID: MRXMC34MA4 |

Further information on the declaration of conformity for wireless vehicle components (→ page 25).

#### Tire pressure loss warning system

#### Function of the tire pressure loss warning system

The tire pressure loss warning system warns the driver by means of display messages when there is a severe tire pressure loss.

After a change in tire pressure, a wheel rotation or a tire change, or if you have re-installed wheels or tires, the tire pressure loss warning system has to be restarted (→ page 466).

The tire pressure loss warning system does not replace the need to regularly check the tire pressure.

### System limitations

The system may be impaired or may not function particularly in the following situations:

- Incorrectly set tire pressure
- Sudden pressure loss caused, for example, by a foreign object penetrating the tire
- Steady pressure loss in several tires

The system has a restricted or delayed function particularly in the following situations:

- Poor ground conditions, e.g. snow or gravel
- Driving with snow chains
- When adopting a very sporty driving style with high cornering speeds or sudden acceleration
- Driving with a high load

Be sure to also observe the following further related subjects:

- Notes on tire pressure (→ page 460)
- Display messages about the tires (→ page 546)

### Restarting the tire pressure loss warning system

#### Requirements:

- The recommended tire pressure is correctly set for the respective operating status on each of the four wheels (→ page 460).

Restart the tire pressure loss warning system in the following situations:

- The tire pressure has changed.
- The wheels or tires have been changed or newly installed.

On-board computer:

↪ [Service](#) ▶ [Tires](#)

- ▶ Swipe downwards on Touch Control on the left-hand side of the steering wheel.

The [Run Flat Indicator ActiveRestart: Press Touch Control](#) message is shown in the multifunction display

Restart the tire pressure loss warning system in the following situations:

- The tire pressure has changed.
- The wheels or tires have been changed or newly installed.

▶ To begin restart, press Touch Control on the left-hand side of the steering wheel. The [Tire Pressure Now OK?](#) message is shown in the multifunction display

▶ Select [Yes](#).

▶ To confirm restart, press Touch Control on the left-hand side of the steering wheel. The [Run Flat Indicator Restarted](#) message is shown in the multifunction display.

Be sure to also observe the following further related subjects:

- Notes on tire pressure (→ page 460)

## Loading the vehicle

### Notes on Tire and Loading Information placard

**⚠ WARNING** Risk of accident from overloaded tires

Overloaded tires may overheat and burst as a consequence. Overloaded tires can also impair the steering and handling characteristics and lead to brake failure.

- ▶ Observe the load-bearing capacity of the tires.
- ▶ The load-bearing capacity must be at least half the gross axle weight rating of the vehicle.
- ▶ Never overload the tires by exceeding the maximum load.

The Tire and Loading Information placard is on the B-pillar on the driver's side of the vehicle.

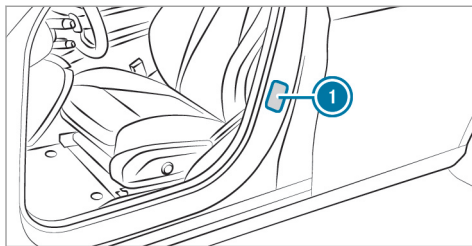

① Tire and Loading Information placard

| TIRE AN RENSEIGNEMENTS  |                     | LOADING INFORMATION                              |   |
|---|---------------------|--|---|
| RENSEIGNEMENTS POUR LES PNEUS   |                     | LE CHARGEMENT                                    |   |
| SEATING CAPACITY<br>NOMBRE DE PLACES  | TOTAL 7             | FRONT<br>AVANT                                   | 2   |
|   |                     | MIDDLE<br>EU                                     | 3   |
|   |                     | REAR<br>ARRIÈRE                                  | 2   |
| The combined weight of occupants and cargo should never exceed<br>Le poids total des occupants et du chargement ne doit jamais dépasser |                     | xxx  | kg or<br>xxx lbs.*  |
| TIRE<br>PNEU  | SIZE<br>DIMENSIONS  | COLD TIRE PRESSURE<br>PRESSION DES PNEUS À FROID | SEE OWNER'S<br>MANUAL FOR<br>ADDITIONAL<br>INFORMATION          |
| FRONT<br>AVANT  | 285/40 ZR18 99Y XL  | 200 KPA, 29 PSI                                  | VOIR LE MANUEL<br>DE L'USAGER<br>POUR PLUS DE<br>RENSEIGNEMENTS |
| REAR<br>ARRIÈRE   | 285/35 ZR18 101Y XL | 200 KPA, 29 PSI                                  |   |
| SPARE<br>DE SECOURS   | 175/55-18 95P       | 420 KPA, 60 PSI                                  |   |

① The data shown in the illustration is example data.

The Tire and Loading Information placard shows:

- Maximum number of seats ② according to the maximum number of people permitted to travel in the vehicle.
- Maximum permissible load ③ comprises the gross weight of all vehicle occupants, load and luggage.

- Recommended tire pressures **1** for cold tires. The recommended tire pressures are valid for the maximum permissible load and up to the maximum permissible vehicle speed.

Please also note:

- Information on permissible weights and loads on the vehicle identification plate (→ page 494).
- Information on tire pressure in the tire pressure table (→ page 461).

Further related subjects:

- Determining the maximum permissible load (→ page 468)
- Notes on tire pressure (→ page 460).

### Steps for Determining Correct Load Limit

The following steps have been developed as required of all manufacturers under Title 49, Code of U.S. Federal Regulations, Part 575, pursuant to the "National Traffic and Motor Vehicle Safety Act of 1966".

- ▶ **(1):** Locate the statement "The combined weight of occupants and cargo should never exceed XXX kg or XXX lbs." on your vehicle's placard.
- ▶ **(2):** Determine the combined weight of the driver and passengers that will be riding in your vehicle.
- ▶ **(3):** Subtract the combined weight of the driver and passengers from XXX kg or XXX lbs.
- ▶ **(4):** The resulting figure equals the available amount of cargo and luggage load capacity. For example, if the "XXX" amount equals 1400 lbs. and there will be five 150 lb passengers in your vehicle, the amount of available cargo and luggage load capacity is 650 lbs.  $(1400 - 750 (5 \times 150) = 650 \text{ lbs.})$
- ▶ **(5):** Determine the combined weight of luggage and cargo being loaded on the vehicle. The weight may not safely exceed the available cargo and luggage load capacity calculated in Step 4.
- ▶ **(6):** If your vehicle will be towing a trailer, load from your trailer will be transferred to

your vehicle. Consult this manual to determine how this reduces the available cargo and luggage load capacity of your vehicle.

- i** Not all vehicles are permitted to tow a trailer. Towing a trailer is only permitted if a trailer-hitch is installed. Please consult an authorized Mercedes-Benz dealer if you have any questions about towing a trailer with your vehicle.

Even if you have calculated the total load carefully, you should still make sure that the maximum permissible gross weight and the maximum gross axle weight rating of your vehicle are not exceeded. Details can be found on the vehicle identification plate.

- ▶ Have your loaded vehicle – including driver, occupants and load – weighed on a vehicle weighbridge. The measured values may not exceed the maximum permissible values stated on the vehicle identification plate.

Further related subjects:

- Calculation example for determining the maximum load (→ page 469)

- Tire and Loading Information placard (→ page 467)
- Tire pressure table (→ page 461)
- Vehicle identification plate

### Calculation example for determining the maximum load

The following table shows examples of how to calculate total and load capacities with varying seating configurations and different numbers and sizes of occupants. The following examples use a maximum load of 1500 lbs (680 kg). **This**

**is for illustration purposes only.** Make sure you are using the actual load limit for your vehicle stated on your vehicle's Tire and Loading Information placard (→ page 467).

The higher the weight of all the occupants, the smaller the maximum load for luggage.

#### Step 1

|  | Example 1         | Example 2         |
|--|-------------------|-------------------|
| Combined maximum weight of occupants and load (data from the Tire and Loading Information placard) | 1500 lbs (680 kg) | 1500 lbs (680 kg) |

#### Step 2

|  | Example 1           | Example 2 |
|--|---------------------|-----------|
| Number of people in the vehicle (driver and occupants) | 5                   | 1         |
| Distribution of the occupants                          | Front: 2<br>Rear: 3 | Front: 1  |

## 470 Wheels and tires

---

|                               | Example 1   | Example 2                   |
|-------------------------------|---|-----------------------------|
| Weight of occupants           | Occupant 1: 150 lbs (68 kg)<br>Occupant 2: 180 lbs (82 kg)<br>Occupant 3: 160 lbs (73 kg)<br>Occupant 4: 140 lbs (63 kg)<br>Occupant 5: 120 lbs (54 kg) | Occupant 1: 200 lbs (91 kg) |
| Total weight of all occupants | 750 lbs (340 kg)  | 200 lbs (91 kg)             |

### Step 3

|  | Example 1   | Example 2   |
|--|---|---|
| Permissible load (maximum gross vehicle weight rating from the Tire and Loading Information placard minus the gross weight of all occupants) | 1500 lbs (680 kg) - 750 lbs (340 kg) = 750 lbs (340 kg) | 1500 lbs (680 kg) - 200 lbs (91 kg) = 1300 lbs (589 kg) |



## Tire labeling

### Overview of tire labeling

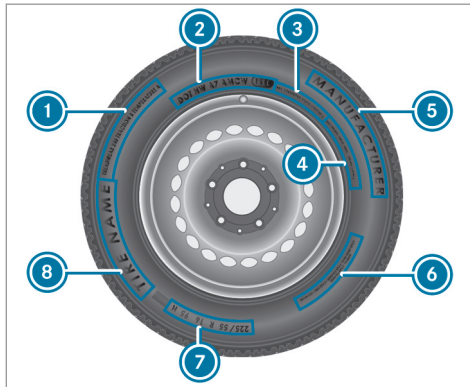

- ① Uniform Tire Quality Grading Standard (→ page 471)
- ② DOT, Tire Identification Number (→ page 472)
- ③ Maximum tire load (→ page 473)
- ④ Maximum tire pressure (→ page 473)

- ⑤ Manufacturer
  - ⑥ Characteristics of the tire (→ page 474)
  - ⑦ Tire size designation, load-bearing capacity, speed rating and load index (→ page 474)
  - ⑧ Tire name
- ① The data shown in the image is example data.

### Tire Quality Grading

In accordance with the US Department of Transportation's "Uniform Tire Quality Grading Standards", tire manufacturers are required to grade their tires on the basis of the following three performance factors:

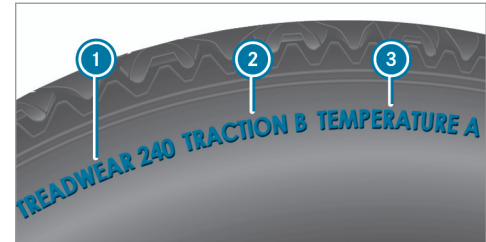

- ① Tread wear grade
  - ② Traction grade
  - ③ Temperature grade
- ① The data shown in the illustration is example data.
- ① The classification is not legally stipulated for Canada, but it is generally stated.

### Tread wear grade

The tread wear grade is a comparative rating based on the wear rate of the tire when tested under controlled conditions on a specified test track of the US Department of Transportation. For example, a tire graded 150 would wear one

and one-half times as well on the government test track as a tire graded 100.

The relative performance of tires depends upon the actual conditions of their use, however, and may depart significantly from the norm due to variations in driving habits, service practices and differences in road characteristics and climate conditions.

### Traction grade

**⚠ DANGER** Risk of accident due to inadequate traction

The traction grade assigned to this tire is based on straight-ahead braking traction tests, and does not include either acceleration, cornering, hydroplaning or peak traction characteristics.

- ▶ Always adapt your driving style and drive at a speed to suit the prevailing traffic and weather conditions.

**!** **NOTE** Damage to the drivetrain from wheelspin

- ▶ Avoid wheelspin.

The traction classes, from highest to lowest, are AA, A, B and C. Those grades represent the tire's ability to stop on wet pavement as measured under controlled conditions on specified government test surfaces of asphalt and concrete. A tire marked C may have poor traction performance.

### Temperature grade

**⚠ WARNING** Risk of accident from tire overheating and tire failure

The temperature grade for this tire is established for a tire that is properly inflated and not overloaded. Excessive speed, underinflation, or excessive loading, either separately or in combination, can cause excessive heat build-up and possible tire failure.

- ▶ Observe the recommended tire pressures and regularly check the tire pres-

sure of all tires including the spare wheel.

- ▶ Adjust the tire pressure as necessary.

The temperature grades are A (the highest), B and C. They represent the tire's resistance to the generation of heat and its ability to dissipate heat when tested under controlled conditions on a specified indoor laboratory test wheel. Sustained high temperature can cause the material of the tire to degenerate and reduce tire life, and excessive temperature can lead to sudden tire failure. Grade C corresponds to a level of performance which all passenger car tires must meet under the Federal Motor Safety Standard No. 109. Grades B and A represent higher levels of performance on the laboratory test wheel than the minimum required by law.

### DOT, Tire Identification Number (TIN)

US tire regulations stipulate that every tire manufacturer or retreader must imprint a TIN in or on the side wall of each tire produced.

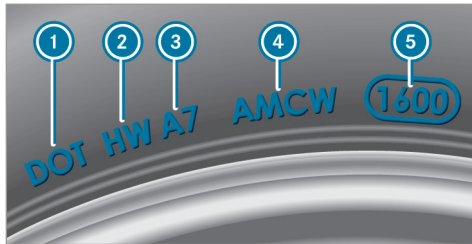

**i** The data shown in the image is example data.

The TIN is a unique identification number to identify tires and comprises the following:

- **DOT (Department of Transportation):** tire symbol marks **1** indicating that the tire complies with the requirements of the US Department of Transportation.
- **Manufacturer identification code:** manufacturer identification code **2** contains details of the tire manufacturer. New tires have a code with two symbols. Retreaded tires have a code with four symbols. Further information on retreaded tires (→ page 479).

- **Tire size:** identifier **3** describes the tire size.
- **Tire type code:** tire type code **4** can be used by the manufacturer as a code to describe specific characteristics of the tire.
- **Manufacturing date:** manufacturing date **5** provides information about the age of a tire. The 1st and 2nd positions represent the calendar week and the 3rd and 4th positions state the year of manufacture (e.g. "3208" represents the 32nd week of 2008).

#### Information on the maximum tire load

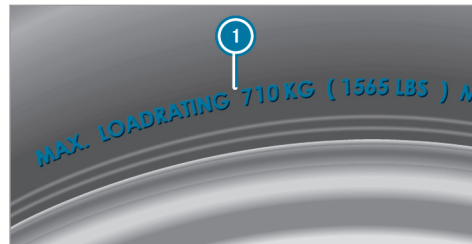

**i** The data shown in the image is example data.

Maximum tire load **1** is the maximum permissible weight for which the tire is approved.

Do not overload the tires by exceeding the specified load limit. The maximum permissible load can be found on the vehicle's Tire and Loading Information placard on the B-pillar on the driver's side (→ page 467).

#### Specifications for maximum tire pressure



**i** The data shown in the image is example data.

Never exceed maximum tire pressure ❶ specified for the tire.

### Information on tire characteristics



❶ The data shown in the image is example data.

This information describes the type of tire cord and the number of layers in side wall ❶ and under tire tread ❷.

### Tire size designation, load-bearing capacity, speed rating and load index

**⚠ WARNING** Risk of injury through exceeding the specified tire load rating or the permissible speed rating

Exceeding the specified tire load rating or the permissible speed rating may lead to tire damage and to the tires bursting.

- ▶ Therefore, only use tire types and sizes approved for your vehicle model.
- ▶ Observe the tire load rating and speed rating required for your vehicle.

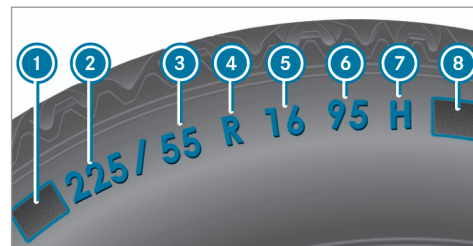

- ❶ Preceding letter
- ❷ Nominal tire width in millimeters
- ❸ Aspect ratio in %
- ❹ Tire code
- ❺ Rim diameter
- ❻ Load-bearing index
- ❼ Speed rating
- ❽ Load index

❶ The data shown in the image is example data.

Information about reading tire data can be obtained from any qualified specialist workshop.

**Preceding letter 1:**

- Without: passenger vehicle tires according to European manufacturing standards.
- "P": passenger vehicle tires according to US manufacturing standards.
- "LT": light truck tires according to US manufacturing standards.
- "T": compact emergency spare wheels with high tire pressure that are only designed for temporary use in an emergency.

**Aspect ratio 2:**

Ratio between tire height and tire width in percent (tire height divided by tire width).

**Tire code 3 (tire type):**

- "R": radial tire
- "D": bias ply tire
- "B": bias belted tires
- "ZR": radial tire with a maximum speed above 149 mph (240 km/h) (optional)

**Rim diameter 5:**

The diameter of the bead seat (not the diameter of the rim flange). The rim diameter is specified in inches (in).

**Load-bearing index 6:**

Numerical code that specifies the maximum load-bearing capacity of a tire (e.g. "91" corresponds to 1356 lbs (615 kg)).

The load-bearing capacity of the tire must be at least half the permissible axle load of your vehicle. Do not overload the tires by exceeding the specified load limit.

See also:

- Maximum permissible load on the Tire and Loading Information placard (→ page 467)
- Maximum tire load (→ page 473)
- Load index

**Speed rating 7:**

Specifies the approved maximum speed of the tire.

- **i** An electronic speed limiter prevents your vehicle from exceeding a speed of 130 mph (210 km/h).

Make sure that your tires have the required speed rating. You can obtain information on the required speed rating from an authorized Mercedes-Benz Center.

**Summer tires**

| Index | Speed rating             |
|-------|--------------------------|
| Q     | up to 100 mph (160 km/h) |
| R     | up to 106 mph (170 km/h) |
| S     | up to 112 mph (180 km/h) |
| T     | up to 118 mph (190 km/h) |
| H     | up to 130 mph (210 km/h) |
| V     | up to 149 mph (240 km/h) |
| W     | up to 168 mph (270 km/h) |
| Y     | up to 186 mph (300 km/h) |

| Index                   | Speed rating             |
|-------------------------|--------------------------|
| ZR...Y <sup>1</sup>     | up to 186 mph (300 km/h) |
| ZR...(..Y) <sup>1</sup> | over 186 mph (300 km/h)  |
| ZR <sup>1</sup>         | over 149 mph (240 km/h)  |

- Specifying the speed rating as the "ZR" index in tire code ④ is optional for tires up to 186 mph (300 km/h).
- If your tire code ④ includes "ZR" and there is no speed rating ⑦, find out what the maximum speed is from the tire manufacturer.
- If load-bearing index ⑥ and speed rating ⑦ are in brackets, the maximum speed rating of your tire is above 186 mph (300 km/h). To find out the maximum speed, ask the tire manufacturer.

<sup>1</sup> "ZR" stated in the tire code.

<sup>2</sup> Or "M+S"  " for winter tires

### All-weather tires and winter tires

| Index              | Speed rating             |
|--------------------|--------------------------|
| Q M+S <sup>2</sup> | up to 100 mph (160 km/h) |
| T M+S <sup>2</sup> | up to 118 mph (190 km/h) |
| H M+S <sup>2</sup> | up to 130 mph (210 km/h) |
| V M+S <sup>2</sup> | up to 149 mph (240 km/h) |

Winter tires bear the  snowflake symbol and fulfill the requirements of the Rubber Manufacturers Association (RMA) and the Rubber Association of Canada (RAC) regarding the tire traction on snow.

### Load index ⑧:

- No specification given: standard load (SL) tire
- "XL" or "Extra Load": extra load tire or reinforced tire
- "Light Load": light load tire

- "C", "D", "E": a load range that depends on the maximum load that the tire can carry at a certain pressure

### Definition of terms for tires and loading

**Tire structure and characteristics:** describes the number of layers or the number of rubber-coated belts in the tire contact surface and the tire wall. These are made of steel, nylon, polyester and other materials.

**Bar:** metric unit for tire pressure.

14.5038 pounds per square inch (psi) and 100 kilopascal (kPa) is the equivalent of one bar.

**DOT (Department of Transportation):** DOT-marked tires fulfill the requirements of the US Department of Transportation.

**Average weight of the vehicle occupants:** the number of vehicle occupants for which the vehicle is designed, multiplied by 150 lb (68 kg).

**Uniform Tire Quality Grading Standards:** a uniform standard to grade the quality of tires with regard to tread quality, tire traction and temperature characteristics. The quality grading assessment is made by the manufacturer following specifications from the U.S. government. The quality grade of a tire is imprinted on the side wall of the tire.

**Recommended tire pressure:** the recommended tire pressure is the tire pressure specified for the tires mounted to the vehicle at the factory.

The tire and information table contains the recommended tire pressures for cold tires, the maximum permissible load and the maximum permissible vehicle speed.

The tire pressure table contains the recommended tire pressures for cold tires under various operating conditions, i.e. loading and/or speed of the vehicle.

**Increased vehicle weight due to optional equipment:** the combined weight of all standard and optional equipment available for the vehicle,

regardless of whether it is actually installed on the vehicle or not.

**Rim:** the part of the wheel on which the tire is installed.

**GAWR (Gross Axle Weight Rating):** the GAWR is the maximum permissible axle load. The actual load on an axle must never exceed the gross axle weight rating. The gross axle weight rating can be found on the vehicle identification plate on the B-pillar on the driver's side.

**Speed rating:** the speed rating is part of the tire identification. It specifies the speed range for which a tire is approved.

**GVW (Gross Vehicle Weight):** the gross vehicle weight comprises the weight of the vehicle including fuel, tools, the spare wheel, accessories installed, occupants, luggage and the trailer drawbar noseweight, if applicable. The gross vehicle weight must not exceed the gross vehicle weight rating GVWR as specified on the vehicle identification plate on the B-pillar on the driver's side.

**GVWR (Gross Vehicle Weight Rating):** the GVWR is the maximum permitted gross weight

of the fully laden vehicle (weight of the vehicle including all accessories, occupants, fuel, luggage and the trailer drawbar noseweight if applicable). The gross vehicle weight rating is specified on the vehicle identification plate on the B-pillar on the driver's side.

**Maximum weight of the laden vehicle:** the maximum weight is the sum of the curb weight of the vehicle, the weight of the accessories, the maximum load and the weight of optional equipment installed at the factory.

**Kilopascal (kPa):** metric unit for tire pressure. 6.9 kPa corresponds to 1 psi. Another unit for tire pressure is bar. 100 kilopascal (kPa) equals 1 bar.

**Load index:** in addition to the load-bearing index, the load index may also be imprinted on the side wall of the tire. This specifies the load-bearing capacity of the tire more precisely.

**Curb weight:** the weight of a vehicle with standard equipment including the maximum capacity of fuel, oil and coolant. It also includes the air conditioning system and optional equipment if

these are installed on the vehicle, but does not include passengers or luggage.

**Maximum tire load:** the maximum tire load is the maximum permissible weight in kilograms or lbs for which a tire is approved.

**Maximum permissible tire pressure:** maximum permissible tire pressure for one tire.

**Maximum load on one tire:** maximum load on one tire. This is calculated by dividing the maximum axle load of one axle by two.

**PSI (pounds per square inch):** standard unit of measurement for tire pressure.

**Aspect ratio:** ratio between tire height and tire width in percent.

**Tire pressure:** pressure inside the tire applying an outward force to every square inch of the tire. The tire pressure is specified in pounds per square inch (psi), in kilopascals (kPa) or in bar. The tire pressure should only be corrected when the tires are cold.

**Cold tire pressure:** the tires are cold when the vehicle has been parked for at least 3 hours

without direct sunlight on the tires or the vehicle has been driven for less than 1 mile (1.6 km).

**Tire contact surface:** the part of the tire that comes into contact with the road.

**Tire bead:** the purpose of the tire bead is to ensure that the tire sits securely on the wheel rim. There are several wire cores in the tire bead to prevent the tire from changing length on the wheel rim.

**Side wall:** the part of the tire between the tread and the tire bead.

**Weight of optional equipment:** the combined weight of the optional equipment weighing more than the replaced standard parts and more than 5 lbs (2.3 kg). This optional equipment, such as high-performance brakes, level control system, a roof luggage rack or high-performance batteries, is not included in the curb weight and the weight of the accessories.

**TIN (Tire Identification Number):** a unique identification number which can be used by a tire manufacturer to identify tires, for example, in a product recall, and thus identify the purchasers. The TIN is made up of the manufactur-

er's identity code, tire size, tire type code and the manufacturing date.

**Load-bearing index:** the load-bearing index is a code that contains the maximum load-bearing capacity of a tire.

**Traction:** traction is the grip resulting from friction between the tires and the road surface.

**Wear indicator:** narrow bars (tread wear bars) that are distributed over the tire contact surface. If the tire tread is level with the bars, the wear limit of 1/16 in (1.6 mm) has been reached.

**Distribution of vehicle occupants:** distribution of vehicle occupants over designated seat positions in a vehicle.

**Maximum permissible payload weight:** nominal load and luggage load plus 150 lb (68 kg) multiplied by the number of seats in the vehicle.



## Changing a wheel

### Notes on selecting, installing and replacing tires

**Mercedes-AMG vehicles:** observe the notes in the Supplement. Otherwise, you may fail to recognize dangers.

You can ask for information regarding permitted wheel/tire combinations at an authorized Mercedes-Benz Center.

**⚠ WARNING** Risk of accident due to incorrect dimensions of wheels and tires

If wheels and tires of the wrong size are installed, the wheel brakes or wheel suspension components may be damaged.

- ▶ Always replace wheels and tires with those that fulfill the specifications of the original part.

When replacing wheels, make sure to fit the correct:

- Designation

- Model

When replacing tires, make sure to install the correct:

- Designation
- Manufacturer
- Model

**⚠ WARNING** Risk of injury through exceeding the specified tire load rating or the permissible speed rating

Exceeding the specified tire load rating or the permissible speed rating may lead to tire damage and to the tires bursting.

- ▶ Therefore, only use tire types and sizes approved for your vehicle model.
- ▶ Observe the tire load rating and speed rating required for your vehicle.

**! NOTE** Vehicle and tire damage through tire types and sizes that have not been approved

For safety reasons, only use tires, wheels and accessories which have been specially approved by Mercedes-Benz for your vehicle.

These tires are specially adapted to the control systems, such as ABS, ESP<sup>®</sup> and 4MATIC, and marked as follows:

- MO = Mercedes-Benz Original
- MOE = Mercedes-Benz Original Extended (run-flat tire only for certain wheels)
- MO1 = Mercedes-Benz Original (only certain AMG tires)

Certain characteristics, such as handling, vehicle noise emissions, fuel consumption, etc. may otherwise be adversely affected. Furthermore, other tire sizes could result in the tires rubbing against the body and axle components when loaded. This could result in damage to the tire or the vehicle.

Only use tires, wheels and accessories that have been checked and recommended by Mercedes-Benz.

**!** **NOTE** Risk to driving safety from retreaded tires

Retreaded tires are neither tested nor recommended by Mercedes-Benz, since previous damage cannot always be detected on retreaded tires.

For this reason driving safety cannot be guaranteed.

- ▶ Do not use used tires if you have no information about their previous usage.

**!** **NOTE** Possible damage to wheels or tires when driving over obstacles

Large wheels have a lower tire section width. The lower the tire section width, the greater is the risk of damage to wheels or tires when driving over obstacles.

- ▶ Avoid obstacles or drive particularly carefully.

**!** **NOTE** Damage to electronic component parts from the use of tire-mounting tools

**Vehicles with a tire pressure monitoring system:** Electronic component parts are located in the wheel. Tire-mounting tools should not be used in the area of the valve.

This could otherwise damage the electronic component parts.

- ▶ Have the tires changed at a qualified specialist workshop only.

**!** **NOTE** Damage to summer tires at low ambient temperatures

At low ambient temperatures, tears could form when driving with summer tires, causing permanent damage to the tires.

- ▶ At temperatures below 45 °F (7 °C), use M+S tires .

Accessory parts that are not approved for your vehicle by Mercedes-Benz or are not being used correctly can impair the operating safety.

Before purchasing and using non-approved accessories, visit a qualified specialist workshop and inquire about:

- Suitability
- Legal stipulations
- Factory recommendations

**!** **WARNING** Risk of accident with high performance tires

The special tire tread in combination with the optimized tire compound means that the risk of skidding or hydroplaning on wet roads is increased.

In addition, the tire grip is greatly reduced at a low outside temperature and tire running temperature.

- ▶ Switch on the ESP® and adapt your driving style accordingly.
- ▶ Use M+S tire at outside temperatures of less than 10 °C (50 °F).

Observe the following when selecting, installing and replacing tires:

- Only use tires and wheels of the same type (summer tires, winter tires, MOExtended tires) and the same make.
- Only install wheels of the same size on one axle (left and right).  
It is only permissible to install a different wheel size in the event of a flat tire in order to drive to the specialist workshop.
- Only install tires of the correct size onto the wheels.
- **Vehicles with a tire pressure monitoring system:** All installed wheels must be equipped with functioning sensors for the tire pressure monitoring system.
- At temperatures below 45 °F (7 °C), use winter tires or all-season tire marked M+S for all wheels.

Winter tires bearing the  snowflake symbol in addition to the M+S marking provide the best possible grip in wintry road conditions.

- For M+S tires, only use tires with the same tread.
- Observe the maximum permissible speed for the M+S tires installed.  
If this is below the vehicle's maximum speed, this must be indicated by an appropriate label in the driver's field of vision.
- Break in new tires at moderate speeds for the first 60 miles (100 km).
- Replace the tires after six years at the latest, regardless of wear.
- **When replacing with tires that do not feature run-flat characteristics:** vehicles with MOExtended tires are not equipped with a TIREFIT kit at the factory. Equip the vehicle with a TIREFIT kit after replacing with tires that do not feature run-flat characteristics, e.g. winter tires.

For more information on wheels and tires, contact a qualified specialist workshop.

Be sure to also observe the following further related subjects:

- Notes on tire pressure (→ page 460)

- Tire and Loading Information placard (→ page 467)
- Tire size designation, load-bearing capacity, speed rating and load index (→ page 474)
- Tire pressure table (→ page 461)
- Notes on the emergency spare wheel (→ page 488)

### Notes on rotating wheels

 **WARNING** Risk of injury through different wheel sizes

Interchanging the front and rear wheels if the wheels or tires have different dimensions may severely impair the driving characteristics.

The wheel brakes or wheel suspension components may also be damaged.

- ▶ Rotate front and rear wheels only if the wheels and tires are of the same dimensions.

The wear patterns on the front and rear wheels differ:

- Front wheels wear more on the shoulder of the tire
- Rear wheels wear more at the center of the tire

Do not drive with tires that have too little tread depth. This significantly reduces traction on wet roads (hydroplaning).

On vehicles that have the same size front and rear wheels, rotate the wheels according to the intervals in the tire manufacturer's warranty book in your vehicle documents. If this is not available, rotate the tires every 3,000 to 6,000 miles (5,000 to 10,000 km), depending on the wear. Ensure that the direction of rotation is maintained.

Observe the instructions and safety notes on "Changing a wheel" when doing so (→ page 483).

### Notes on storing wheels

When storing wheels, observe the following notes:

- After removing wheels, store them in a cool, dry and preferably dark place.
- Protect the tires from contact with oil, grease or fuel.

### Overview of the tire-change tool kit

**Mercedes-AMG vehicles:** observe the notes in the Supplement. Otherwise, you may fail to recognize dangers.

Apart from some country-specific variants, vehicles are not equipped with a tire-change tool kit. For more information on which tire-change tools are required and approved for performing a wheel change on your vehicle, consult a qualified specialist workshop.

You require the following tools, for instance, to change a wheel:

- Jack
- Chock

- Lug wrench
- Alignment bolt

The tire-change tool kit is located under the cargo compartment floor.

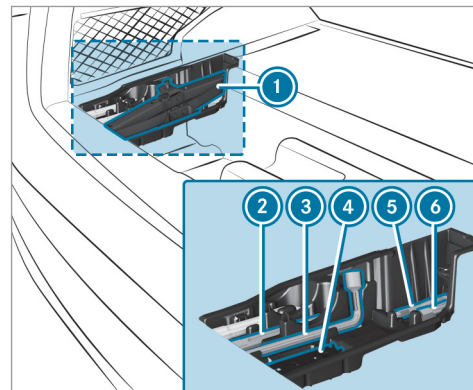

- ① Jack
- ② Ratchet for jack
- ③ Lug wrench

- ④ Folding chock
- ⑤ Alignment bolt
- ⑥ Socket wrench for ratchet

### Setting up the folding chock

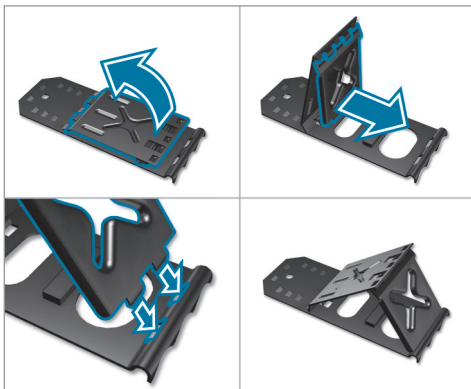

### Preparing the vehicle for a wheel change

#### Requirements:

- The required tire-change tool is available. If your vehicle is not equipped with the tire-change tool kit, consult a qualified specialist workshop to find out about suitable tools.
  - The vehicle is not on a slope.
  - The vehicle is on solid, non-slippery and level ground.
- ▶ Apply the electric parking brake manually.
  - ▶ Move the front wheels to the straight-ahead position.
  - ▶ **Vehicles with automatic transmission:** Shift into position **P**.
  - ▶ **Vehicles with level control system:** Set the normal vehicle level (→ page 216).
  - ▶ Switch off the engine.
  - ▶ Make sure that the engine cannot be started.
  - ▶ Place chocks or other suitable items under the front and rear of the wheel that is diagonally opposite the wheel you wish to change.
  - ▶ Remove the hub caps if necessary (→ page 483).
  - ▶ Raise the vehicle (→ page 484).

### Removing and installing hub caps

#### Requirements:

- The vehicle is prepared for a wheel change (→ page 483).

#### Plastic hub cap

- ▶ **To remove:** turn the center cover of the hub cap counter-clockwise and remove the hub cap.
- ▶ **To install:** make sure that the center cover of the hub cap is turned counter-clockwise.
- ▶ Position the hub cap and turn the center cover clockwise until the hub cap engages physically and audibly.

### Aluminum hub cap

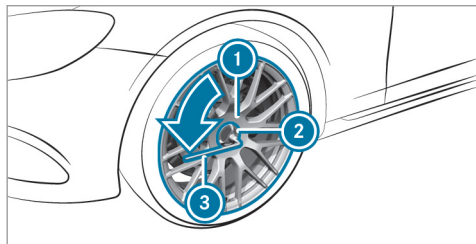

▶ **To remove:** position socket ② on hub cap ①.

① The socket can be found in the tire-change tool kit.

▶ Position wheel wrench ③ on socket ②.

▶ Using wheel wrench ③, turn hub cap ① counter-clockwise and remove it.

▶ **To install:** position hub cap ① and turn until it is completely flush with the wheel.

▶ Position socket ② on hub cap ①.

▶ Attach wheel wrench ③ to socket ② and tighten the hub cap clockwise.

**Specified tightening torque:** 18 lb-ft (25 Nm).

### Raising the vehicle when changing a wheel

#### Requirements:

- There are no persons in the vehicle.
- The vehicle has been prepared for a wheel change (→ page 483).

Important notes on using the jack:

- Use only a vehicle-specific jack that has been approved by Mercedes-Benz to raise the vehicle.
- The jack is only designed for raising and holding the vehicle for a short time while a wheel is being changed and not for maintenance work under the vehicle.
- The jack must be placed on a firm, flat and non-slip surface. If necessary, use a large, flat, load-bearing, non-slip underlay.

- The foot of the jack must be positioned vertically under the jack support point.

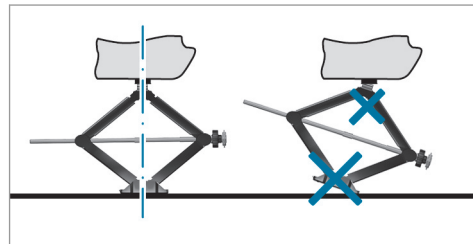

Rules of conduct when the vehicle is raised:

- Never place your hands or feet under the vehicle.
- Never lie under the vehicle.
- Do not start the engine and do not release the electric parking brake.
- Do not open or close any doors or the tail-gate.

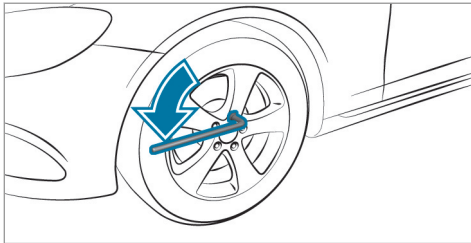

- ▶ Using the lug wrench, loosen the wheel bolts on the wheel you wish to change by about one full turn. Do not unscrew the bolts completely.

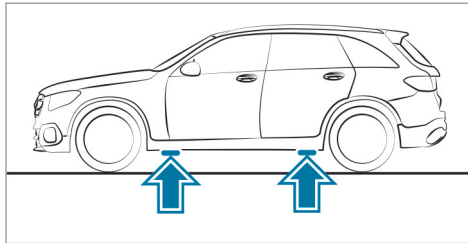

Position of jack support points

- ▲ **WARNING** Risk of injury from incorrect positioning of the jack

If you do not position the jack correctly at the appropriate jacking point of the vehicle, the jack could tip with the vehicle raised.

- ▶ Only position the jack at the appropriate jacking point of the vehicle. The base of the jack must be positioned vertically under the jacking point of the vehicle.

- ! **NOTE** Vehicle damage from the jack

If you do not position the jack correctly at the appropriate jack support point of the vehicle, the jack could tip over with the vehicle raised.

- ▶ The jack is designed exclusively for jacking up the vehicle at the jack support points.
- ▶ Take the ratchet out of the tire-change tool kit and place it on the hexagon nut of the jack so that the letters "AUF" are visible.

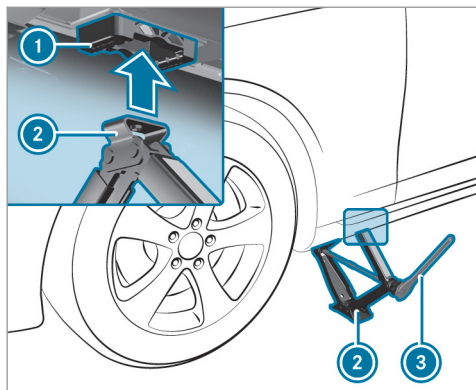

- ▶ Position jack ② at jack support point ①.
- ▶ Turn ratchet ③ clockwise until jack ② sits completely on jack support point ① and the base of the jack lies evenly on the ground.
- ▶ Turn ratchet ③ until the tire is raised a maximum of 1.2 in (3 cm) from the ground.
- ▶ Loosen and remove the wheel (→ page 486).

### Removing a wheel

#### Requirements:

- The vehicle is raised (→ page 484).

**Mercedes-AMG vehicles:** observe the notes in the Supplement. Otherwise, you may fail to recognize dangers.

When changing a wheel, avoid applying any force to the brake discs, since this could impair the level of comfort when braking.

**!** **NOTE** Damage to threading from dirt on wheel bolts

▶ Do not place wheel bolts in sand or on a dirty surface.

- ▶ Unscrew the uppermost wheel bolt completely.

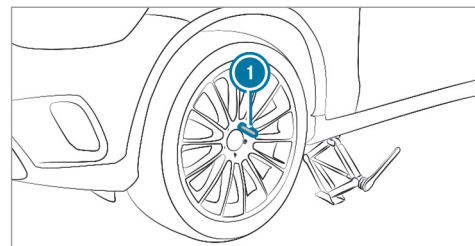

- ▶ Screw alignment bolt ① into the thread instead of the wheel bolt.
- ▶ Unscrew the remaining wheel bolts completely.
- ▶ Remove the wheel.
- ▶ Install the new wheel (→ page 486).

### Mounting a new wheel

#### Requirements:

- The wheel is removed (→ page 486).



**Mercedes-AMG vehicles:** observe the notes in the Supplement. Otherwise, you may not recognize dangers.

**⚠ WARNING** Risk of accident from losing a wheel

Oiled, greased or damaged wheel bolt/wheel nut threads or wheel hub/wheel mounting bolt threads can cause the wheel bolts/wheel nuts to come loose.

As a result, you could lose a wheel while driving.

- ▶ Never oil or grease the threads.
- ▶ In the event of damage to the threads, contact a qualified specialist workshop immediately.
- ▶ Have the damaged wheel bolts or damaged hub threads replaced.
- ▶ Do not continue driving.

- ▶ Observe the information on the choice of tires (→ page 479).

For tires with a specified direction of rotation, an arrow on the side wall of the tire indicates the correct direction of rotation. Observe the direction of rotation when installing.

- ▶ Slide the wheel to be mounted onto the alignment bolt and push it on.

**⚠ WARNING** Risk of injury from tightening wheel bolts and nuts

If you tighten the wheel bolts or wheel nuts when the vehicle is raised, the jack could tip.

- ▶ Only tighten wheel bolts or wheel nuts when the vehicle is on the ground.
- ▶ Be sure to observe the instructions and safety notes on "Changing a wheel" (→ page 479).
- ▶ For safety reasons, only use wheel bolts which have been approved by Mercedes-Benz and for the wheel in question.

**! NOTE** Damage to paintwork of the wheel rim when screwing on the first wheel bolt

If the wheel has too much play when screwing in the first wheel bolt, the wheel rim paint can be damaged.

- ▶ Press the wheel firmly against the wheel hub when screwing on the first wheel bolt.
- ▶ Tighten the wheel bolts evenly in a diagonal pattern in the order indicated until they are finger-tight.
- ▶ Unscrew the alignment bolt.
- ▶ Tighten the last wheel bolt until it is finger-tight.
- ▶ Lower the vehicle (→ page 487).

**Lowering the vehicle after a wheel change**

**Requirements:**

- The new wheel has been installed (→ page 486).

- ▶ Place the ratchet onto the hexagon nut of the jack so that the letters "AB" are visible.
- ▶ **To lower the vehicle:** turn the ratchet of the jack counter-clockwise.

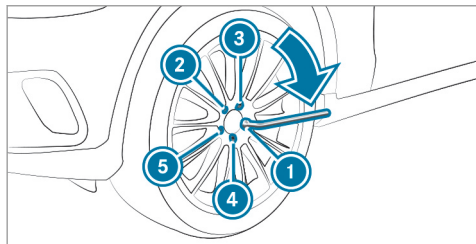

- ▶ Tighten the wheel bolts evenly in a diagonal pattern in the order indicated ① to ⑤ with a maximum of 59 lb-ft (80 Nm).
- ▶ Tighten the wheel bolts evenly in a diagonal pattern in the order indicated ① to ⑤ to the specified tightening torque of 111 lb-ft (150 Nm).

**⚠ WARNING** Risk of injury through incorrect tightening torque

The wheels could come loose if the wheel bolts or wheel nuts are not tightened to the prescribed tightening torque.

- ▶ Make sure the wheel bolts or wheel nuts are tightened to the prescribed tightening torque.
- ▶ If you are not sure, do not move the vehicle. Consult a qualified specialist workshop and have the tightening torque checked immediately.

- ▶ Check the tire pressure of the newly mounted wheel and adjust accordingly.
- ▶ **Vehicles with tire pressure loss warning system:** Restart the tire pressure loss warning system (→ page 466).  
**Exception:** the new wheel is an emergency spare wheel.

- ▶ **Vehicles with a tire pressure monitoring system:** Restart the tire pressure monitoring system (→ page 465).

**Exception:** the new wheel is an emergency spare wheel.

Make sure to observe the following further related subject:

- Notes on tire pressure (→ page 460)

### Emergency spare wheel

#### Notes on the emergency spare wheel

**⚠ WARNING** Risk of accident caused by incorrect wheel and tire dimensions

The wheel or tire size and the tire type of the emergency spare wheel or spare wheel and the wheel to be replaced may differ. Mounting an emergency spare wheel/spare wheel may severely impair the driving characteristics.

To prevent hazardous situations:

- ▶ Adapt your driving style accordingly and drive carefully.
- ▶ Never mount more than one emergency spare wheel or spare wheel that differs in size.
- ▶ Only use an emergency spare wheel or spare wheel of a different size briefly.
- ▶ Do not switch off ESP®.
- ▶ >Have the emergency spare wheel or spare wheel of a different size replaced at the nearest qualified specialist workshop. The new wheel must have the correct dimensions.

Check the tire pressure of the emergency spare wheel installed. Correct the pressure as necessary.

The maximum permissible speed with an emergency spare wheel installed is 50 mph (80 km/h).

Do not install the emergency spare wheel with snow chains.

Replace the emergency spare wheel after six years at the latest, regardless of wear.

- i Vehicles with a tire pressure loss warning system:** If an emergency spare wheel is installed the tire pressure loss warning system cannot function reliably. Only restart the system again when the emergency spare wheel has been replaced with a new wheel.
- Vehicles with a tire pressure monitoring system:** If an emergency spare wheel is installed the tire pressure monitoring system cannot function reliably. For a few minutes after an emergency spare wheel is installed, the system may still display the tire pressure of the removed wheel. Only restart the system again when the emergency spare wheel has been replaced with a new wheel.

Be sure to also observe the following further related subjects:

- Notes on tire pressure (→ page 460)
- Tire and Loading Information placard (→ page 467)
- Tire pressure table (→ page 461)

### Removing the emergency spare wheel

The emergency spare wheel is fastened in the cargo compartment under the cargo compartment floor.

- ▶ Observe the information on mounting tires (→ page 479).
- ▶ Open the tailgate.
- ▶ Open the cargo compartment floor.
- ▶ Remove the emergency spare wheel.

### Inflating the emergency spare wheel

**!** **NOTE** Overheating due to the tire inflation compressor running too long

- ▶ Do not run the tire inflation compressor for longer than ten minutes without interruption.

#### Requirements:

- Comply with the manufacturer's safety notes on the sticker of the emergency spare wheel and on the tire inflation compressor.

## 490 Wheels and tires

- Remove the tire inflation compressor from the stowage space under the trunk floor (→ page 439).



- Remove sticker 1 from the tire inflation compressor housing and affix it to the instrument cluster within the driver's field of vision.

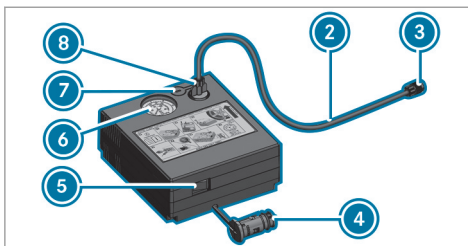

- Pull filler hose 2 and plug 4 out of the tire inflation compressor housing.
- Insert plug 8 of filler hose 2 in the socket on the tire inflation compressor and then turn it until plug 8 engages.
- Unscrew the cap from the valve on the emergency spare wheel.
- Screw union nut 3 of filler hose 2 onto the valve.
- Make sure on and off switch 5 of the tire inflation compressor is set to 0.
- Insert plug 4 in a socket in your vehicle.
  - Cigarette lighter socket: (→ page 124)

- 12 V socket:
- Observe the notes on the cigarette lighter: (→ page 124)
- Observe the notes on sockets:
  - Turn the SmartKey to position 1 in the ignition lock.
  - Press on and off switch 5 on the tire inflation compressor to I. The tire inflation compressor is switched on. The tire is inflated. The tire pressure is shown on manometer 6.
  - Pump the tire to the specified tire pressure. The specified tire pressure is stated on the label of the emergency spare wheel.
  - When the specified tire pressure has been reached, press on and off switch 5 on the tire inflation compressor to 0. The tire inflation compressor is switched off.
  - Turn the SmartKey to position 0 in the ignition lock.
  - If the tire pressure is higher than the specified pressure, press pressure release valve

button ⑦ until the correct tire pressure has been reached.

- ▶ Unscrew union nut ③ of filler hose ② from the valve.
- ▶ Screw the valve cap of the emergency spare wheel onto the valve again.
- ▶ Stow filler hose ② and plug ④ in the lower section of the compressor housing.
- ▶ Stow the tire inflation compressor in the vehicle.

### Notes on technical data

**Mercedes-AMG vehicles:** be sure to observe the notes in the Supplement. Otherwise, you may fail to recognize dangers.

**Plug-in hybrid:** be sure to observe the notes in the Supplement. Otherwise, you may fail to recognize dangers.

The data stated only applies to vehicles with standard equipment. You can obtain further information from an authorized Mercedes-Benz Center.

### Vehicle electronics

#### Two-way radios

##### Notes on installing two-way radios

**⚠ WARNING** Risk of accident due to improper work on two-way radios

The electromagnetic radiation from two-way radios can interfere with the on-board electronics if RF transmitters are manipulated or retrofitted incorrectly.

This could jeopardize the operating safety of the vehicle.

- ▶ You should have all work on electrical and electronic components carried out at a qualified specialist workshop.

**⚠ WARNING** Risk of accident from incorrect operation of two-way radios

If you operate two-way radios incorrectly in the vehicle, the electromagnetic radiation could interfere with the on-board electronics, e.g.:

- if the two-way radio is not connected to an exterior antenna
- if the exterior antenna is not correctly mounted or is not of low reflection

This could jeopardize the operating safety of the vehicle.

- ▶ Have the low-reflection exterior antenna installed at a qualified specialist workshop.

- ▶ When operating two-way radios in the vehicle, always connect them to the low-reflection exterior antenna.

**! NOTE** Invalidation of the operating permit due to failure to comply with the instructions for installation and use

The operating permit may be invalidated if the instructions for installation and use of two-way radios are not observed.

- ▶ Only use approved frequency bands.
- ▶ Observe the maximum permissible output power in these frequency bands.
- ▶ Only use approved antenna positions.

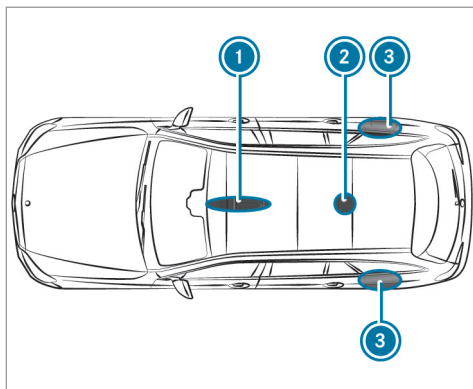

- ① Front roof area
- ② Rear roof area
- ③ Rear fenders

On vehicles with a panoramic sliding sunroof, installing an antenna to the front or rear roof area is not permitted.

On the rear fenders, it is recommended that you install the antenna on the side of the vehicle closest to the center of the road.

Use Technical Specification ISO/TS 21609 (Road Vehicles - "EMCs for installation of aftermarket radio frequency transmitting equipment") when retrofitting two-way radios. Comply with the legal requirements for detachable parts.

If your vehicle has installations for two-way radio equipment, use the power supply and antenna connectors provided in the pre-installation. Be sure to observe the manufacturer's supplements when installing.

#### Two-way radio transmission output

The maximum transmission output (PEAK) at the base of the antenna must not exceed the values in the following table.

#### Frequency band and maximum transmission output

| Frequency band                              | Maximum transmission output |
|---|-----------------------------|
| Short wave<br>3 - 54 MHz                    | (100 W)                     |
| 4 m frequency band<br>74 - 88 MHz           | (30 W)                      |
| 2 m frequency band<br>144 - 174 MHz         | (50 W)                      |
| trunked radio system/Tetra<br>380 - 460 MHz | (10 W)                      |
| 70 cm frequency band<br>400 - 460 MHz       | (35 W)                      |
| Two-way radio<br>(2G/3G/4G)                 | (10 W)                      |

## 494 Technical data

The following can be used in the vehicle without restrictions:

- Two-way radios with a maximum transmission output of up to 100 mW
- RF transmitters with transmitter frequencies in the 380 - 410 MHz frequency band and a maximum transmission output of up to 2 W (trunked radio system/Tetra)
- Mobile phones (2G/3G/4G)

There are no restrictions when positioning the antenna on the outside of the vehicle for some wavebands.

This applies to the following wavebands:

- Trunked radio system/Tetra
- 70 cm frequency band
- 2G/3G/4G

### Vehicle identification plate, VIN and engine number overview

#### Vehicle identification plate

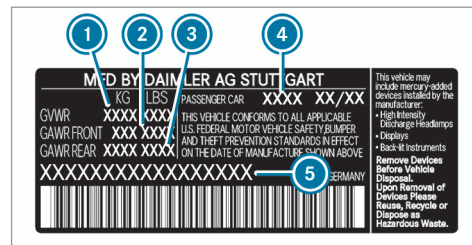
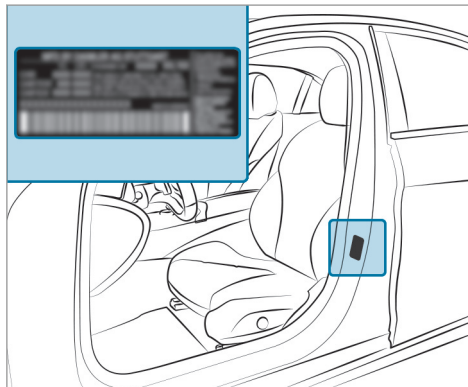

#### Vehicle identification plate (USA only)

- 1 Permissible gross weight
- 2 Permissible front axle load
- 3 Permissible rear axle load
- 4 Paint code
- 5 VIN (vehicle identification number)



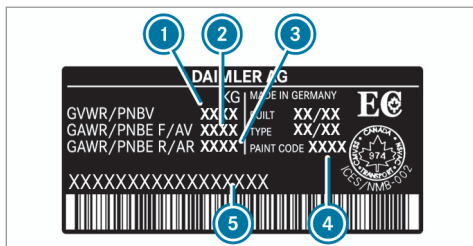

Vehicle identification plate (Canada only)

- ① Permissible gross weight
- ② Permissible front axle load
- ③ Permissible rear axle load
- ④ Paint code
- ⑤ VIN (vehicle identification number)

The permissible gross vehicle weight is made up of the vehicle weight, all vehicle occupants, the fuel and the load. The maximum gross axle weight rating is the maximum weight that can be carried on one axle (front or rear axle).

Never exceed the permissible gross vehicle weight or the maximum gross axle weight rating for the front or rear axle.

### VIN in front of the right-hand front seat

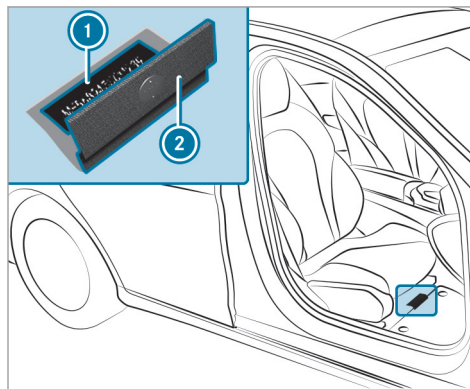

- ① Imprinted VIN (vehicle identification number)
- ② Floor covering

### Additional plates

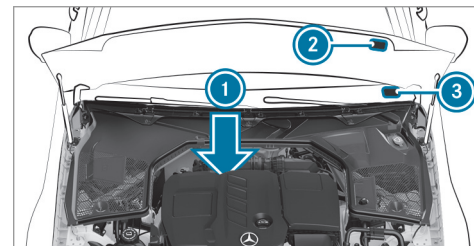

- ① Engine number stamped into the crankcase
- ② Plate with information about emissions testing, including confirmation of emissions guidelines at the U.S. federal level as well as for California
- ③ VIN (vehicle identification number) as a label at the lower edge of the windshield

## Operating fluids

### Notes on operating fluids

**Mercedes-AMG vehicles:** be sure to observe the notes in the Supplement. Otherwise, you may fail to recognize dangers.

**⚠ WARNING** Risk of injury from operating fluids harmful to your health

Operating fluids may be poisonous and harmful to your health.

- ▶ Observe the text on the original containers when using, storing or disposing of operating fluids.
- ▶ Always store operating fluids sealed in their original containers.
- ▶ Always keep children away from operating fluids.



**ENVIRONMENTAL NOTE** Environmental pollution caused by environmentally irresponsible disposal



Dispose of operating fluids in an environmentally responsible manner.

Operating fluids include the following:

- Fuels
- Lubricants
- Coolant
- Brake fluid
- Windshield washer fluid
- Climate control system refrigerant

Only use products approved by Mercedes-Benz. Damage caused by the use of products that have not been approved is not covered by the Mercedes-Benz warranty or goodwill gestures.

You can identify operating fluids approved by Mercedes-Benz by the following inscriptions on the container:

- MB-Freigabe (e.g. MB-Freigabe 229.51)

- MB-Approval (e.g. MB-Approval 229.51)

Further information on approved operating fluids is available at the following locations:

- In the Mercedes-Benz Specifications for Operating Fluids by entering the designation
  - At <http://bevo.mercedes-benz.com>
  - In the Mercedes-Benz BeVo app
- At a qualified specialist workshop



**WARNING** Risk of fire or explosion from fuel

Fuels are highly flammable.

- ▶ Fire, open flames, smoking and creation of sparks must be avoided.
- ▶ Switch off the ignition and, if available, the stationary heater, before and while refueling the vehicle.



**WARNING** Risk of injury from fuels

Fuels are poisonous and hazardous to your health.

- ▶ Do not swallow fuel or let it come into contact with skin, eyes or clothing.
- ▶ Do not inhale fuel vapor.
- ▶ Keep children away from fuel.
- ▶ Keep doors and windows closed during the refueling process.

If you or other people come into contact with fuel, observe the following:

- ▶ Immediately rinse fuel off your skin with soap and water.
- ▶ If fuel comes into contact with your eyes, immediately rinse them thoroughly with clean water. Seek medical attention immediately.
- ▶ If you swallow fuel, seek medical attention immediately. Do not induce vomiting.
- ▶ Change immediately out of clothing that has come into contact with fuel.

## Fuel

### Information on additives in gasoline

Observe the notes on operating fluids (→ page 496).

**!** **NOTE** Damage from use of unsuitable additives

Even small amounts of the wrong additive may lead to malfunctions occurring.

- ▶ Only add cleaning additives recommended by Mercedes-Benz to the fuel.

Mercedes-Benz recommends that you use fuel brands that have additives.

In some countries, the fuel available may not have sufficient additives. Residue could build up in the fuel injection system as a result. In this case, in consultation with an authorized Mercedes-Benz Center, the fuel may be mixed with the cleaning additive recommended by Mercedes-Benz. Be sure to observe the notes and mixing ratios specified on the container.

## Tank content and fuel reserve

### Capacity

| Model      | Total capacity         |
|------------|------------------------|
| All models | 17.4 gal (66.0 liters) |
| Model      | Of which reserve       |
| All models | 1.8 gal (7.0 liters)   |

## Engine oil

### Notes on engine oil

Observe the notes on operating fluids (→ page 496).



**!** **NOTE** Engine damage caused by an incorrect oil filter, incorrect oil or additives

- ▶ Do not use engine oils or oil filters other than those which meet the specifications necessary for the prescribed service intervals.
- ▶ Do not alter the engine oil or oil filter in order to achieve longer change intervals than prescribed.
- ▶ Do not use additives.
- ▶ Have the engine oil changed after the prescribed intervals.

Mercedes-Benz recommends that you have the oil change carried out at a qualified specialist workshop.

Further information on engine oil and oil filters is available at the following locations:

- In the Mercedes-Benz Specifications for Operating Fluids by entering the designation:
  - At <http://bevo.mercedes-benz.com>
  - In the Mercedes-Benz BeVo app

- at a qualified specialist workshop

### Quality and capacity of engine oil

#### MB-Freigabe or MB-Approval

| Gasoline engines | Engine oil specifications            |
|------------------|--------------------------------------|
| All models       | 229.51, 229.52,<br>229.61<br>229.71* |

\* Recommended for lowest possible fuel consumption (lowest SAE viscosity class in each case; observe possible restrictions of the approved SAE viscosity classes).

To achieve the lowest possible fuel consumption, it is recommended to use the engine oil specifications marked in the table for the lowest SAE viscosity class. Possible restrictions of the approved SAE viscosity classes must be observed.

The following values refer to an oil change, including the oil filter.

### Capacity

| Model      | Capacity               |
|------------|------------------------|
| All models | 6.3 US qt (6.0 liters) |

### Notes on brake fluid

Observe the notes on operating fluids (→ page 496).

**!** **WARNING** Risk of an accident due to vapor pockets forming in the brake system

The brake fluid constantly absorbs moisture from the air. This lowers the boiling point of the brake fluid. If the boiling point is too low, vapor pockets may form in the brake system when the brakes are applied hard.

This causes the braking effect to be impaired.

- ▶ Have the brake fluid renewed at the specified intervals.

Have the brake fluid regularly replaced at a qualified specialist workshop.  
Only use brake fluid approved by Mercedes-Benz according to MB-Freigabe or MB-Approval 331.0.  
You can obtain further information on brake fluid in the following places:

- in the Mercedes-Benz Specifications for Operating Fluids
  - at <http://bevo.mercedes-benz.com>
  - in the Mercedes-Benz BeVo App
- at a qualified specialist workshop

## Coolant

### Notes on coolant

Observe the notes on operating fluids (→ page 496).

**⚠ WARNING** - Risk of fire and injury from antifreeze

If antifreeze comes into contact with hot component parts in the engine compartment, it may ignite.

- ▶ Allow the engine to cool down before adding antifreeze.
- ▶ Make sure that no antifreeze spills out next to the filler opening.
- ▶ Thoroughly clean off any antifreeze from component parts before starting the vehicle.

**! NOTE** Damage caused by incorrect coolant

- ▶ Only add coolant that has been pre-mixed with the required antifreeze protection.

Information on coolant is available at the following locations:

- In the Mercedes-Benz Specification for Operating Fluids 310.1
  - At <http://bevo.mercedes-benz.com>
  - In the Mercedes-Benz BeVo app
- At a qualified specialist workshop

**! NOTE** Overheating at high outside temperatures

If an inappropriate coolant is used, the engine cooling system is not sufficiently protected against overheating and corrosion at high outside temperatures.

- ▶ Always use coolant approved by Mercedes-Benz.
- ▶ Observe the instructions in the Mercedes-Benz Specifications for Operating Fluids 310.1.

Have the coolant regularly replaced at a qualified specialist workshop.

The proportion of corrosion inhibitor/antifreeze concentrate in the engine cooling system should be:

- a minimum of 50% (antifreeze protection down to approximately -35 °F (-37 °C))
- a maximum of 55% (antifreeze protection down to -49 °F (-45 °C))

**Coolant capacity****Coolant capacity**

| Model      | Capacity               |
|------------|------------------------|
| All models | 9.5 US qt (9.0 liters) |

**Notes on windshield washer fluid**

Observe the notes on operating fluids (→ page 496).

**⚠ WARNING** - Risk of fire and injury from windshield washer concentrate

Windshield washer concentrate is highly flammable. It could ignite if it comes into contact with hot engine component parts or the exhaust system.

- ▶ Make sure that no windshield washer concentrate spills out next to the filler opening.

**! NOTE** Damage to the exterior lighting due to unsuitable windshield washer fluid

Unsuitable windshield washer fluid may damage the plastic surface of the exterior lighting.

- ▶ Only use windshield washer fluid which is also suitable for use on plastic surfaces, e.g. MB SummerFit or MB WinterFit.

**! NOTE** Blocked spray nozzles caused by mixing windshield washer fluids

- ▶ Do not mix MB SummerFit and MB WinterFit with other windshield washer fluids.

Do not use distilled or de-ionized water as the fill level sensor may be triggered erroneously.

Recommended windshield washer fluid:

- Above freezing point: e.g. MB SummerFit
- Below freezing point: e.g. MB WinterFit

For the correct mixing ratio, refer to the information on the antifreeze container.

Mix the washer fluid with the windshield washer fluid all year round.

**Refrigerant****Notes on refrigerant**

Observe the notes on operating fluids (→ page 496).

**! NOTE** Damage due to incorrect refrigerant

If a non-approved refrigerant is used, the climate control system may be damaged.

- ▶ Only use the refrigerant R-134a

**! NOTE** Damage to the climate control system due to incorrect refrigerant compressor oil

- ▶ Only use refrigerant compressor oil that has been approved by Mercedes-Benz.

- ▶ Do not mix the approved refrigerant compressor oil with a different refrigerant compressor oil.

Work on the climate control system may be carried out only by a qualified specialist workshop. All applicable regulations, as well as SAE standard J639, must be adhered to.

The instruction label on the climate control system for the refrigerant type and the refrigerant compressor oil is located on the inside of the hood.

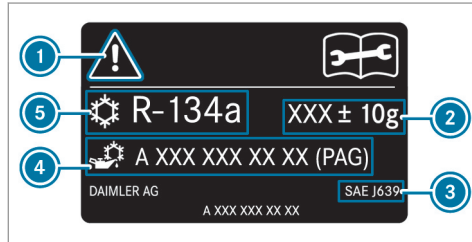

- ① Hazard and service warning symbols
- ② Refrigerant filling capacity

- ③ Applicable standards
- ④ PAG oil part number
- ⑤ Refrigerant type

Symbols ① warn of the following:

- Possible dangers
- Having service work carried out at a qualified specialist workshop

### Refrigerant filling capacity

#### Filling capacity for refrigerant and PAG oil

| Model      | Refrigerant                   |
|------------|-------------------------------|
| All models | 22.2 ± 0.4 oz<br>(630 ± 10 g) |
| Model      | PAG oil                       |
| All models | 2.8 ± 0.4 oz<br>(80 ± 10 g)   |

### Vehicle data

#### Vehicle dimensions

The heights specified may vary as a result of the following factors:

- Tires
- Load
- Condition of the suspension
- Optional equipment

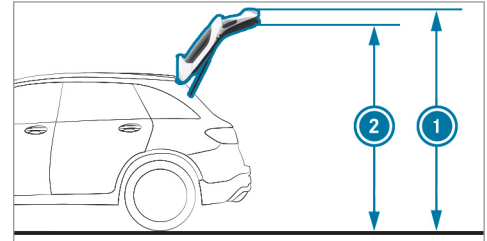

**Height when opened**

| Model      | ① Height when opened | ② Head-room          |
|------------|----------------------|----------------------|
| All models | 84.5 in<br>(2146 mm) | 78.4 in<br>(1992 mm) |

**Vehicle dimensions**

| All models                              |                       |
|---|-----------------------|
| Vehicle length                          | 184.0 in<br>(4669 mm) |
| Vehicle width including outside mirrors | 82.5 in<br>(2096 mm)  |
| Vehicle height                          | 65.3 in<br>(1659 mm)  |
| Wheelbase                               | 113.1 in<br>(2873 mm) |
| Turning radius                          | 38.71 ft<br>(11.80 m) |

**Weights and loads**

Please observe the following notes for the specified vehicle data:

- Items of optional equipment increase the curb weight and reduce the payload.

**Roof load**

| All models        |                  |
|-------------------|------------------|
| Maximum roof load | 165.4 lb (75 kg) |

**Off-road driving****Fording depth**

**!** **NOTE** Damage caused by water when fording

Water can enter the engine compartment and vehicle interior in the following cases:

- The maximum permissible fording depth when driving through standing water is exceeded

- A bow wave forms during fording
- Water accumulates during fording of flowing water
- ▶ Do not exceed the maximum permissible fording depth and drive slowly through the water.

The specified value indicates the maximum permissible fording depth for vehicles that are ready to drive and for slow driving through standing water.

Driving through flowing water reduces the permissible fording depth due to the accumulation of water.

Observe the notes on off-road driving and fording (→ page 160).



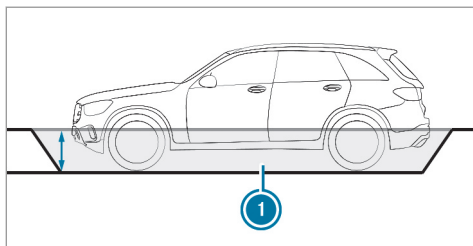

| Model      | ① Fording depth |
|------------|-----------------|
| All models | 11.8 in (30 cm) |

### Approach/departure angle

The specified values are maximum values for vehicles that are ready to drive.

On vehicles with AIR BODY CONTROL, loads up to the maximum permissible load have no influence on the approach/departure angle.

Observe the notes on driving in mountainous terrain (→ page 160).

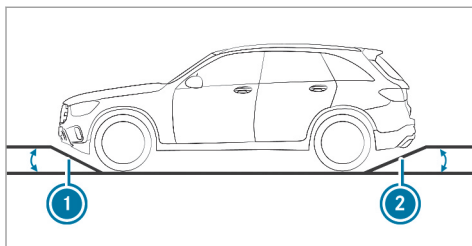

| Model      | ① Front | ② Rear |
|------------|---------|--------|
| All models | 29.6°   | 23.6°  |

### Maximum gradient climbing ability

The vehicle's gradient climbing ability depends on the weight distribution in the vehicle, the terrain conditions and the road surface conditions.

The specified value applies in the following cases:

- The vehicle is ready to drive
- The road surface conditions and thus traction are good

A gradient climbing ability of 100% corresponds to an incline of 45°.

Observe the notes on driving in mountainous terrain (→ page 160).

Missing values were not available at the time of going to press.

| Model      | Maximum gradient climbing ability |
|------------|-----------------------------------|
| All models |                                   |

### Trailer hitch

#### General notes on the trailer hitch

Modifications to the engine cooling system may be necessary, depending on the vehicle model. The retrofitting of a trailer hitch is only permissible if a towing capacity is specified in your vehicle documents.

Further information can be obtained at a qualified specialist workshop.

### Permissible trailer load

The tongue weight is not included in the towing capacity.

Missing values were not available at the time of going to press.

#### Permissible towing capacity, braked (at a minimum start-off gradeability of 12%)

| Model          | Permissible towing capacity, braked |
|----------------|-------------------------------------|
| GLC 300        |                                     |
| GLC 300 4MATIC |                                     |

#### Permissible towing capacity, unbraked

| Model          | Permissible towing capacity, unbraked |
|----------------|---------------------------------------|
| GLC 300        |                                       |
| GLC 300 4MATIC |                                       |

### Maximum tongue weight

**!** **NOTE** Damage caused by the trailer coming loose

If the tongue weight used is too low, the trailer may come loose.

- ▶ The tongue weight must not be below 110.2 lbs (50 kg).
- ▶ Use a tongue weight that is as close as possible to the maximum permissible tongue weight.

Missing values were not available at the time of going to press.

### Maximum tongue weight

| Model          | Maximum tongue weight |
|----------------|-----------------------|
| GLC 300        |                       |
| GLC 300 4MATIC |                       |

### Permissible rear axle load (trailer operation)

Missing values were not available at the time of going to press.

#### Axle load

| Model          | Axle load |
|----------------|-----------|
| GLC 300        |           |
| GLC 300 4MATIC |           |

## Display messages

### Introduction



#### Notes on display messages

Display messages appear on the multifunction display.

Display messages with graphic symbols are simplified in the Operator's Manual and may differ from the symbols on the multifunction display. The multifunction display shows high-priority display messages in red. Certain display messages are accompanied by a warning tone.

Please act in accordance with the display messages and follow the additional notes in the Operator's Manual.

For some display messages, a symbol will also be shown:

-  Further information
-  Hide display message

You can select the desired symbol by swiping left or right on the left-hand Touch Control. Press the  symbol to show further information

on the multifunction display. Press the  symbol to hide the display message.

You can hide low-priority display messages by pressing the  button or the left-hand Touch Control. The display messages will then be stored in the message memory.

Rectify the cause of a display message as quickly as possible.

High-priority display messages cannot be hidden. The multifunction display shows these display messages continuously until the cause of the display message has been rectified.



#### Calling up stored display messages

On-board computer:





 [Service](#)  [1 Message](#)



If there are no display messages, [No Messages](#) will appear on the multifunction display.

 Scroll through the display messages by swiping upwards or downwards on the left-hand Touch Control.

 **To exit the message memory:** press the  button.

## Occupant safety

| Display messages   | Possible causes/consequences and ► Solutions   |
|--|--|
|  <p data-bbox="144 381 395 433">SRS Malfunction Service Required</p>                  | <p data-bbox="476 288 1018 313">* The restraint system is malfunctioning (→ page 34).</p> <div data-bbox="500 332 1646 503" style="border: 1px solid gray; padding: 5px;"> <p data-bbox="513 339 1236 365">▲ <b>WARNING</b> Risk of injury due to malfunctions in the restraint system</p> <p data-bbox="513 381 1618 456">If the restraint system is malfunctioning, restraint system components may be triggered unintentionally or may not deploy as intended during an accident. This may affect the Emergency Tensioning Devices or airbags, for example.</p> <p data-bbox="513 467 1498 493">► Have the restraint system checked and repaired immediately at a qualified specialist workshop.</p> </div> <p data-bbox="500 519 962 544">Recognition of a restraint system malfunction:</p> <ul data-bbox="513 555 1480 617" style="list-style-type: none"> <li>• The  restraint system warning lamp does not light up when the ignition is switched on.</li> <li>• The  restraint system warning lamp lights up continuously or repeatedly during a journey.</li> </ul> <p data-bbox="500 617 1055 643">► Consult a qualified specialist workshop immediately.</p> |
|  <p data-bbox="144 754 421 806">Front Left Malfunction Service Required (example)</p> | <p data-bbox="476 660 1166 686">* The corresponding restraint system is malfunctioning (→ page 34).</p> <div data-bbox="500 705 1646 876" style="border: 1px solid gray; padding: 5px;"> <p data-bbox="513 712 1236 738">▲ <b>WARNING</b> Risk of injury due to malfunctions in the restraint system</p> <p data-bbox="513 754 1618 829">If the restraint system is malfunctioning, restraint system components may be triggered unintentionally or may not deploy as intended during an accident. This may affect the Emergency Tensioning Devices or airbags, for example.</p> <p data-bbox="513 840 1498 866">► Have the restraint system checked and repaired immediately at a qualified specialist workshop.</p> </div>   |

| Display messages   | Possible causes/consequences and ► Solutions  |
|--|---|
|  | <p>Recognition of a restraint system malfunction:</p> <ul style="list-style-type: none"> <li>• The  restraint system warning lamp does not light up when the ignition is switched on.</li> <li>• The  restraint system warning lamp lights up continuously or repeatedly during a journey.</li> </ul> <p>► Consult a qualified specialist workshop immediately.</p> |
|  <p>Left Side Curtain Airbag Malfunction Service Required (example)</p> | <p>* The corresponding window curtain airbag is malfunctioning (→ page 34).</p> <p><b>⚠ WARNING</b> Risk of injury or fatal injury due to malfunctions in the window airbag</p> <p>If the window airbag is malfunctioning, it might be triggered unintentionally or might not be triggered at all in the event of an accident with high deceleration.</p> <p>► Have the window airbag checked and repaired immediately at a qualified specialist workshop.</p> <p>► Consult a qualified specialist workshop immediately.</p>          |
| <p>Front Passenger Airbag Disabled See Operator's Manual</p>   | <p>* The front passenger airbag has been disabled even though an adult or a person with an adult stature is on the front passenger seat. If additional forces are applied to the seat, the weight the system detects may be too low.</p> <p><b>⚠ WARNING</b> Risk of injury or fatal injury due to a disabled front passenger airbag</p> <p>If the front passenger airbag is disabled, the front passenger airbag will not be deployed in the event of an accident and cannot perform its intended protective function.</p>           |

| Display messages  | Possible causes/consequences and ► Solutions   |
|---|--|
|   | <p>A person in the front passenger seat could then, for example, come into contact with the vehicle's interior, especially if the person is sitting too close to the cockpit.</p> <p>► Make sure, both before and during the journey, that the status of the front passenger airbag is correct.</p> <ul style="list-style-type: none"> <li>► Stop the vehicle immediately in accordance with the traffic conditions.</li> <li>► Check the status of the automatic front passenger airbag actuation (→ page 45).</li> <li>► If necessary, consult a qualified specialist workshop immediately.</li> </ul>   |
| <p>Front Passenger Airbag Enabled See Operator's Manual</p> | <p>* The front passenger airbag is enabled while the vehicle is in motion:</p> <ul style="list-style-type: none"> <li>• even when a child, a person of small stature or an object weighing less than the system weight threshold is located on the front passenger seat</li> <li>• even when the front passenger seat is not occupied</li> </ul> <p>The system may detect objects or forces that are adding to the weight applied to the seat.</p> <p><b>▲ WARNING</b> Risk of injury or fatal injury if a child restraint system is used while the front passenger front airbag is enabled</p> <p>If you secure a child in a child restraint system on the front passenger seat and the front passenger airbag is enabled, the front passenger airbag can deploy in the event of an accident. The child could be struck by the airbag.</p> <p>► Ensure, both before and during the journey, that the status of the front passenger airbag is correct.</p> |

| Display messages                                  | Possible causes/consequences and ► Solutions  |
|---|---|
|   | <p>NEVER use a rearward facing child restraint on a seat protected by an ACTIVE AIRBAG in front of it, DEATH or SERIOUS INJURY to the CHILD can occur.</p> <ul style="list-style-type: none"> <li>► Stop the vehicle immediately in accordance with the traffic conditions.</li> <li>► Check the status of the automatic front passenger airbag actuation (→ page 45).</li> <li>► If necessary, consult a qualified specialist workshop immediately.</li> </ul> |
| <p>PRE-SAFE Inoperative See Operator's Manual</p> | <p>* The PRE-SAFE® functions are malfunctioning.</p> <ul style="list-style-type: none"> <li>► Consult a qualified specialist workshop.</li> </ul>   |

### SmartKey

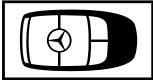
| Display messages  | Possible causes/consequences and ► Solutions   |
|---|--|
|  <p>Obtain a New Key</p> | <p>* The SmartKey needs to be replaced.</p> <ul style="list-style-type: none"> <li>► Consult a qualified specialist workshop.</li> </ul> |

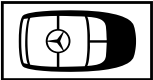
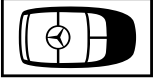
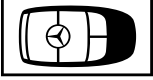
| Display messages  | Possible causes/consequences and ► Solutions  |
|---|---|
|  <p>Replace Key Battery</p>                      | <p>* The SmartKey battery is discharged.</p> <ul style="list-style-type: none"> <li>► Replace the battery (→ page 67).</li> </ul>   |
|  <p>Key Not Detected (white display message)</p> | <p>* The SmartKey is currently undetected.</p> <ul style="list-style-type: none"> <li>► Change the location of the SmartKey in the vehicle.</li> <li>► If the SmartKey is still not recognized, place it in the marked space for starting with the SmartKey (→ page 153).</li> </ul>  |
|  <p>Key Not Detected (red display message)</p>   | <p>* The SmartKey cannot be detected and may no longer be in the vehicle.<br/>The SmartKey is no longer in the vehicle and you switch off the engine:</p> <ul style="list-style-type: none"> <li>• You can no longer start the engine.</li> <li>• You cannot centrally lock the vehicle.</li> </ul> <p>► Ensure that the SmartKey is in the vehicle.</p> <p>If the SmartKey detection function has a malfunction due to a strong radio signal source:</p> <ul style="list-style-type: none"> <li>► Stop the vehicle immediately in accordance with the traffic conditions.</li> <li>► Place the SmartKey in the marked space for starting the engine with the SmartKey (→ page 153).</li> </ul> |



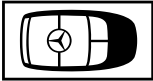





| Display messages  | Possible causes/consequences and ► Solutions   |
|---|--|
| <p>Place the Key in the Marked Space See Operator's Manual</p>  | <ul style="list-style-type: none"> <li>* SmartKey detection is malfunctioning.                             <ul style="list-style-type: none"> <li>► Change the location of the SmartKey in the vehicle.</li> <li>► Place the SmartKey in the marked space for starting the engine with the SmartKey (→ page 153).</li> </ul> </li> </ul> |
| <div style="text-align: center;">  <p>Don't Forget Your Key</p> </div> | <ul style="list-style-type: none"> <li>* A warning tone also sounds. This message reminds you to take your key with you when you leave the vehicle.</li> </ul>   |

## Lights

| Display messages  | Possible causes/consequences and ► Solutions  |
|---|---|
| <div style="text-align: center;">  <p>Check Left Low Beam (example)</p> </div> | <ul style="list-style-type: none"> <li>* The corresponding light source is faulty.                             <ul style="list-style-type: none"> <li>► Drive on carefully.</li> <li>► Consult a qualified specialist workshop immediately.</li> </ul> </li> <li>ⓘ LED light bulbs: the display message for the corresponding lamp appears only when all the light-emitting diodes in the lamp are faulty.</li> </ul> |

## 512 Display messages and warning/indicator lamps

| Display messages   | Possible causes/consequences and ► Solutions   |
|--|--|
|  <p data-bbox="144 342 384 391">Malfunction See Operator's Manual</p>   | <ul style="list-style-type: none"><li>* The exterior lighting is malfunctioning.<ul style="list-style-type: none"><li>► Consult a qualified specialist workshop.</li></ul></li></ul>   |
|  <p data-bbox="144 511 421 560">Automatic Headlamp Mode Inoperative</p> | <ul style="list-style-type: none"><li>* The light sensor is malfunctioning.<ul style="list-style-type: none"><li>► Consult a qualified specialist workshop.</li></ul></li></ul>  |
|  <p data-bbox="144 680 421 729">Active Headlamps Inoperative</p>        | <ul style="list-style-type: none"><li>* The active headlamps are malfunctioning.<ul style="list-style-type: none"><li>► Consult a qualified specialist workshop.</li></ul></li></ul>   |
|  <p data-bbox="144 849 369 871">Switch On Headlamps</p>                 | <ul style="list-style-type: none"><li>* You are driving without low-beam headlamps.<ul style="list-style-type: none"><li>► Turn the light switch to the  or <b>AUTO</b> position.</li></ul></li></ul> |



| Display messages  | Possible causes/consequences and ► Solutions   |
|---|--|
| <br>Switch Off Lights                | <ul style="list-style-type: none"> <li>* You are leaving the vehicle and the lights are still switched on.               <ul style="list-style-type: none"> <li>► Turn the light switch to the <b>AUTO</b> position.</li> </ul> </li> </ul>  |
| <br>Intell. Light System Inoperative | <ul style="list-style-type: none"> <li>* The Intelligent Light System is faulty. The lighting system continues to function properly without the functions of the Intelligent Light System.               <ul style="list-style-type: none"> <li>► Consult a qualified specialist workshop.</li> </ul> </li> </ul>  |
| Adaptive Highbeam Assist<br>Currently Unavailable See<br>Operator's Manual  | <ul style="list-style-type: none"> <li>* Adaptive Highbeam Assist is temporarily unavailable. The system limits have been reached (→ page 133).               <ul style="list-style-type: none"> <li>► Drive on.<br/>Once the cause of the problem is no longer present, the system will be available again. The <b>Adaptive Highbeam Assist Now Available</b> display message will appear.</li> </ul> </li> </ul> |
| Adaptive Highbeam Assist<br>Inoperative   | <ul style="list-style-type: none"> <li>* Adaptive Highbeam Assist is malfunctioning.               <ul style="list-style-type: none"> <li>► Consult a qualified specialist workshop.</li> </ul> </li> </ul>  |
| Adaptive Highbeam Assist<br>Camera View Restricted<br>See Operator's Manual   | <ul style="list-style-type: none"> <li>* The camera view is restricted. Possible causes are:               <ul style="list-style-type: none"> <li>• Dirt on the windshield in the camera's field of vision</li> </ul> </li> </ul>  |

## 514 Display messages and warning/indicator lamps



| Display messages                       | Possible causes/consequences and ► Solutions   |
|--|--|
|  | <ul style="list-style-type: none"><li>• Heavy rain, snow or fog</li></ul> <p>Driving systems and driving safety systems may be malfunctioning or temporarily unavailable.</p> <p>Once the cause of the problem is no longer present, the driving systems and driving safety systems will be available again.</p> <p>If the display message does not disappear:</p> <ul style="list-style-type: none"><li>► Pull over and stop the vehicle safely as soon as possible, paying attention to road and traffic conditions.</li><li>► Clean the windshield.</li></ul> |
| Hazard Warning Flashers Malfunctioning | <p>* The hazard warning lamp switch is malfunctioning.</p> <ul style="list-style-type: none"><li>► Consult a qualified specialist workshop.</li></ul>  |

## Vehicle

| Display messages   | Possible causes/consequences and ► Solutions   |
|--|--|
|  <p>Vehicle Ready to Drive<br/>Switch the Ignition Off<br/>Before Exiting</p> | <p>* You are leaving the vehicle when it is in a ready-to-drive state.</p> <ul style="list-style-type: none"><li>► When you leave the vehicle, switch off the ignition, secure the vehicle against rolling away and take the Smart-Key with you.</li><li>► If you do not leave the vehicle, switch off the electrical consumers, e.g. the seat heating. Otherwise, the 12 V battery may discharge and it will then be possible to start the vehicle only with the aid of a second battery (starting assistance).</li></ul> |

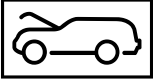
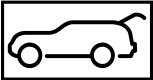

| Display messages  | Possible causes/consequences and ► Solutions   |
|---|--|
|  <p data-bbox="195 344 449 418">Steering Malfunction<br/>Increased Physical Effort<br/>See Operator's Manual</p> | <p data-bbox="528 249 1031 275">* The power steering assistance is malfunctioning.</p> <div data-bbox="561 291 1696 329" style="background-color: #f0f0f0; padding: 5px;"> <p data-bbox="569 301 1295 324">▲ <b>WARNING</b> Risk of an accident due to altered steering characteristics</p> </div> <p data-bbox="561 339 1633 365">If the power assistance of the steering fails partially or completely, you will need to use more force to steer.</p> <ul data-bbox="561 376 1193 433" style="list-style-type: none"> <li data-bbox="561 376 1045 401">▶ If safe steering is possible, drive on carefully.</li> <li data-bbox="561 407 1193 433">▶ Visit or consult a qualified specialist workshop immediately.</li> </ul> <ul data-bbox="543 464 1179 521" style="list-style-type: none"> <li data-bbox="543 464 1027 490">▶ If safe steering is possible, drive on carefully.</li> <li data-bbox="543 495 1179 521">▶ Visit or consult a qualified specialist workshop immediately.</li> </ul>  |
|  <p data-bbox="195 631 460 705">Steering Malfunction Stop<br/>Immediately See Operator's Manual</p>              | <p data-bbox="528 536 1289 562">* The steering is malfunctioning. Steering capability is significantly impaired.</p> <div data-bbox="561 578 1696 616" style="background-color: #f0f0f0; padding: 5px;"> <p data-bbox="569 588 1203 611">▲ <b>WARNING</b> Risk of accident if steering capability is impaired</p> </div> <p data-bbox="561 626 1461 652">If the steering does not function as intended, the vehicle's operating safety is jeopardized.</p> <ul data-bbox="561 663 1633 746" style="list-style-type: none"> <li data-bbox="561 663 1633 710">▶ Pull over and stop the vehicle safely as soon as possible, paying attention to road and traffic conditions. Do not continue driving under any circumstances.</li> <li data-bbox="561 721 994 746">▶ Consult a qualified specialist workshop.</li> </ul> <ul data-bbox="543 778 1670 860" style="list-style-type: none"> <li data-bbox="543 778 1670 825">▶ Stop the vehicle immediately in accordance with the traffic conditions. Do not continue driving under any circumstances.</li> <li data-bbox="543 836 975 860">▶ Consult a qualified specialist workshop.</li> </ul> |

| Display messages  | Possible causes/consequences and ► Solutions   |
|---|--|
|  | <ul style="list-style-type: none"><li>* At least one door is open.<ul style="list-style-type: none"><li>► Close all doors.</li></ul></li></ul>   |
|  | <ul style="list-style-type: none"><li>* The hood is open.<div data-bbox="495 399 1648 552" style="border: 1px solid black; padding: 5px;"><p><b>▲ WARNING</b> Risk of accident if the engine hood is unlatched while driving</p><p>An unlocked engine hood may open up when the vehicle is in motion and block your view.</p><ul style="list-style-type: none"><li>► Never unlatch the engine hood while driving.</li><li>► Before every trip, ensure that the engine hood is latched.</li></ul></div><ul style="list-style-type: none"><li>► Stop the vehicle immediately, paying attention to road and traffic conditions.</li><li>► Close the hood.</li></ul></li></ul> |
|  | <ul style="list-style-type: none"><li>* The tailgate is open.<div data-bbox="495 684 1648 866" style="border: 1px solid black; padding: 5px;"><p><b>▲ DANGER</b> Risk of exhaust gas poisoning</p><p>Combustion engines emit poisonous exhaust gases such as carbon monoxide. Exhaust gases can enter the vehicle interior if the tailgate is open when the engine is running, especially if the vehicle is in motion.</p><ul style="list-style-type: none"><li>► Always switch off the engine before opening the tailgate.</li><li>► Never drive with the tailgate open.</li></ul></div></li></ul>  |



| Display messages  | Possible causes/consequences and ► Solutions  |
|---|---|
|  <p data-bbox="195 384 426 436">Rear Left Backrest Not Latched (example)</p> | <ul style="list-style-type: none"> <li data-bbox="543 249 765 273">► Close the tailgate.</li> <li data-bbox="519 291 1147 314">* The seat backrest of the corresponding seat is not engaged.                             <ul style="list-style-type: none"> <li data-bbox="543 325 1023 349">► Fold the seat backrest back until it engages.</li> </ul> </li> </ul> |
|  <p data-bbox="195 552 399 576">Check Washer Fluid</p>                       | <ul style="list-style-type: none"> <li data-bbox="519 458 1387 482">* The washer fluid level in the washer fluid reservoir has dropped below the minimum.                             <ul style="list-style-type: none"> <li data-bbox="543 493 903 516">► Add washer fluid (→ page 427).</li> </ul> </li> </ul>  |

## Engine

| Display messages   | Possible causes/consequences and ► Solutions  |
|--|---|
|  <p data-bbox="195 819 449 871">Check Coolant Level See Operator's Manual</p> | <ul style="list-style-type: none"> <li data-bbox="519 726 824 750">* The coolant level is too low.                             <div data-bbox="547 767 1696 855" style="border: 1px solid black; padding: 5px; margin-top: 5px;"> <p data-bbox="565 778 1092 801"><b>!</b> <b>NOTE</b> Engine damage due to insufficient coolant</p> <ul style="list-style-type: none"> <li data-bbox="565 819 1045 843">► Avoid long journeys with insufficient coolant.</li> </ul> </div> </li> </ul> |

| Display messages  | Possible causes/consequences and ► Solutions  |
|---|---|
|  <p data-bbox="144 417 421 467">Coolant Too Hot Stop Vehicle Turn Engine Off</p> | <ul style="list-style-type: none"> <li>► Add coolant (→ page 426).</li> <li>► Have the cooling system checked at a qualified specialist workshop.</li> </ul> <p data-bbox="476 325 717 346">* The coolant is too hot.</p> <ul style="list-style-type: none"> <li>► Stop the vehicle immediately in accordance with the traffic conditions and switch off the engine.</li> </ul> <div data-bbox="500 410 1648 588" style="border: 1px solid gray; padding: 5px;"> <p data-bbox="513 417 1073 443"><b>▲ WARNING</b> Danger of burns when opening the hood</p> <p data-bbox="513 456 1591 508">If you open the hood when the engine has overheated or during a fire in the engine compartment, you could come into contact with hot gases or other escaping operating fluids.</p> <ul style="list-style-type: none"> <li>► Before opening the hood, allow the engine to cool down.</li> <li>► In the event of a fire in the engine compartment, keep the hood closed and call the fire service.</li> </ul> </div> <ul style="list-style-type: none"> <li>► Wait until the engine has cooled down.</li> <li>► Make sure that the air supply to the radiator is not impaired.</li> <li>► Avoiding high loads on the engine, drive to the nearest qualified specialist workshop. In doing so, ensure that the coolant temperature display remains below the red marking.</li> </ul> |
|    | <p data-bbox="476 743 722 764">* The fan motor is faulty.</p> <ul style="list-style-type: none"> <li>► Avoiding high loads on the engine, drive to the nearest qualified specialist workshop. In doing so, ensure that the coolant temperature display remains below the red marking.</li> </ul>  |



| Display messages   | Possible causes/consequences and ► Solutions  |
|--|---|
| <p>To switch engine off, press and hold Start/Stop button for at least 3 secs. or press 3 times.</p>   | <ul style="list-style-type: none"> <li>* You have pressed the start/stop button while driving.                             <ul style="list-style-type: none"> <li>► Information about switching off the engine while driving (→ page 153).</li> </ul> </li> </ul>   |
| <div style="text-align: center;">  </div> <p>Fuel Level Low</p> | <ul style="list-style-type: none"> <li>* The fuel supply has dropped into the reserve range.                             <ul style="list-style-type: none"> <li>► Refuel.</li> </ul> </li> </ul>  |
| <div style="text-align: center;">  </div> <p>Gas Cap Loose</p>  | <ul style="list-style-type: none"> <li>* The fuel filler cap is not closed correctly or the fuel system is leaking.                             <ul style="list-style-type: none"> <li>► Close the fuel filler cap.</li> <li>► <b>If the fuel filler cap was already properly closed:</b> consult a qualified specialist workshop.</li> </ul> </li> </ul> |

## Transmission

| Display messages                     | Possible causes/consequences and ► Solutions   |
|--------------------------------------|--|
| <p>Apply Brake to Shift from 'P'</p> | <ul style="list-style-type: none"> <li>* You have attempted to shift the transmission out of park position <b>P</b> and into another transmission position.                             <ul style="list-style-type: none"> <li>► Depress the brake pedal.</li> <li>► Select transmission position <b>D</b>, <b>R</b> or neutral <b>N</b>.</li> </ul> </li> </ul> |

## 520 Display messages and warning/indicator lamps





| Display messages  | Possible causes/consequences and ► Solutions   |
|---|--|
| To Deselect P or N,<br>Depress Brake and Start<br>Engine                      | <ul style="list-style-type: none"><li>* You have attempted to shift the transmission out of park position <b>P</b> or neutral <b>N</b> and into another transmission position.<ul style="list-style-type: none"><li>► Depress the brake pedal.</li><li>► Change the transmission position.</li><li>► Start the engine.</li></ul></li></ul>   |
| Only Shift to 'P' when Vehicle is Stationary                                  | <ul style="list-style-type: none"><li>* Park position <b>P</b> can be engaged only when the vehicle is stationary.<ul style="list-style-type: none"><li>► To stop, depress the brake pedal.</li><li>► Shift the transmission to park position <b>P</b> while the vehicle is stationary.</li></ul></li></ul>  |
| Apply Brake to Shift to 'R'   | <ul style="list-style-type: none"><li>* You have attempted to select transmission position <b>R</b>.<ul style="list-style-type: none"><li>► Depress the brake pedal.</li><li>► Select transmission position <b>R</b>.</li></ul></li></ul>  |
| Driver's Door Open &<br>Transmission Not in P Risk<br>of Vehicle Rolling Away | <ul style="list-style-type: none"><li>* The driver's door is not fully closed and transmission position <b>D</b>, <b>R</b> or neutral <b>N</b> is selected.<ul style="list-style-type: none"><li>► Select park position <b>P</b> when switching off the vehicle.</li></ul></li></ul>   |
| N Permanently Active Risk<br>of Rolling Away                                  | <ul style="list-style-type: none"><li>* While the vehicle is rolling or while you are driving, neutral <b>N</b> has been engaged.<ul style="list-style-type: none"><li>► To stop, depress the brake pedal.</li><li>► Shift the transmission to park position <b>P</b> while the vehicle is stationary.</li><li>► To continue driving, select transmission position <b>D</b> or <b>R</b>.</li></ul></li></ul> |





| Display messages  | Possible causes/consequences and ► Solutions  |
|---|---|
| Service Required Do Not Shift Gears Visit Dealer            | <p>* The transmission is malfunctioning. The transmission position can no longer be changed.</p> <ul style="list-style-type: none"> <li>► When transmission position <b>D</b> is selected, consult a qualified specialist workshop and do not change the transmission position.</li> <li>► For all other transmission positions, park the vehicle safely.</li> <li>► Consult a qualified specialist workshop or breakdown service.</li> </ul> |
| Reversing Not Possible Service Required                     | <p>* The transmission is malfunctioning. The transmission position <b>R</b> cannot be selected.</p> <ul style="list-style-type: none"> <li>► Consult a qualified specialist workshop.</li> </ul>  |
| Transmission Malfunction Stop                               | <p>* The transmission is malfunctioning. The transmission shifts to neutral <b>N</b> automatically.</p> <ul style="list-style-type: none"> <li>► Stop the vehicle immediately in accordance with the traffic conditions.</li> <li>► Depress the brake pedal.</li> <li>► Engage park position <b>P</b>.</li> <li>► Consult a qualified specialist workshop.</li> </ul>   |
| Stop Vehicle Leave Engine Running Wait Transmission Cooling | <p>* The transmission is overheating. Pulling away may be temporarily impaired or not possible.</p> <ul style="list-style-type: none"> <li>► Stop the vehicle immediately in accordance with the traffic conditions. Do not continue driving under any circumstances.</li> <li>► Leave the engine running.</li> <li>► Wait until the display message disappears before pulling away.</li> </ul>   |



## 522 Display messages and warning/indicator lamps

| Display messages              | Possible causes/consequences and ► Solutions   |
|-------------------------------|--|
| Auxiliary Battery Malfunction | <ul style="list-style-type: none"><li>* The auxiliary battery for the transmission is no longer being charged.<ul style="list-style-type: none"><li>► Consult a qualified specialist workshop.</li><li>► Until then, always select park position <b>P</b> manually before you switch off the engine.</li><li>► Before leaving the vehicle, apply the electric parking brake.</li></ul></li></ul> |



### Brakes

| Display messages   | Possible causes/consequences and ► Solutions   |
|--|--|
| <br>(USA only)<br><br>(Canada only)<br>Parking Brake See Operator's Manual | <ul style="list-style-type: none"><li>* The yellow  indicator lamp is lit. The electric parking brake is malfunctioning.<br/><b>To apply:</b><ul style="list-style-type: none"><li>► Switch the ignition off and switch it back on.</li><li>► Apply the electric parking brake manually (→ page 182).</li></ul><br/>If it is not possible to apply the electric parking brake:<ul style="list-style-type: none"><li>► Consult a qualified specialist workshop.</li><li>► Where necessary, also secure the parked vehicle against rolling away.</li></ul></li><li>* The yellow  indicator lamp and the red <b>PARK</b> (USA only) or  (Canada only) indicator lamp are lit. The electric parking brake is malfunctioning.<br/><b>To release:</b></li></ul> |

| Display messages | Possible causes/consequences and ► Solutions  |
|------------------|---|
|                  | <ul style="list-style-type: none"> <li>► Switch the ignition off and switch it back on.</li> <li>► Release the electric parking brake manually (→ page 182).</li> </ul> <p>or</p> <ul style="list-style-type: none"> <li>► Release the electric parking brake automatically (→ page 181).</li> </ul> <p>If it is still not possible to release the electric parking brake:</p> <ul style="list-style-type: none"> <li>► Do not continue driving under any circumstances. Consult a qualified specialist workshop.</li> </ul> <p>* The yellow  indicator lamp is lit and the red  (USA only) or  (Canada only) indicator lamp is flashing. The electric parking brake is malfunctioning.<br/>The electric parking brake could not be applied or released.</p> <ul style="list-style-type: none"> <li>► Switch the ignition off and switch it back on.</li> </ul> <p><b>To apply:</b></p> <ul style="list-style-type: none"> <li>► Release and then apply the electric parking brake manually (→ page 182).</li> </ul> <p><b>To release:</b></p> <ul style="list-style-type: none"> <li>► Apply and then release the electric parking brake manually.</li> </ul> <p>If the electric parking brake cannot be applied or the red  (USA only) or  (Canada only) indicator lamp continues to flash:</p> <ul style="list-style-type: none"> <li>► Do not continue driving under any circumstances. Consult a qualified specialist workshop.</li> <li>► Where necessary, also secure the parked vehicle against rolling away.</li> </ul> |

| Display messages | Possible causes/consequences and ► Solutions   |
|------------------|--|
|                  | <p>* The yellow  indicator lamp is lit and the red  indicator lamp (USA only) or  indicator lamp (Canada only) flashes for approximately ten seconds after the electric parking brake has been applied or released. It then remains lit or goes out. The electric parking brake is malfunctioning.</p> <p><b>If the battery charge level is too low:</b></p> <ul style="list-style-type: none"><li>► Charge the battery.</li></ul> <p><b>To apply:</b></p> <ul style="list-style-type: none"><li>► Switch off the ignition.<br/>The electric parking brake will be applied automatically.</li></ul> <p>If the electric parking brake is not to be applied, e.g. at an automatic car wash or when the vehicle is being towed, leave the ignition switched on. This does not include having the vehicle towed with the rear axle raised.</p> <p>If the electric parking brake is not applied automatically:</p> <ul style="list-style-type: none"><li>► Switch the ignition off and switch it back on.</li><li>► Release and then apply the electric parking brake manually (→ page 182).</li></ul> <p>If it is still not possible to apply the electric parking brake:</p> <ul style="list-style-type: none"><li>► Consult a qualified specialist workshop.</li><li>► Where necessary, also secure the parked vehicle against rolling away.</li></ul> <p><b>To release:</b></p> |



| Display messages  | Possible causes/consequences and ► Solutions  |
|---|---|
|   | <p>► If the conditions for automatic release are fulfilled and the electric parking brake is not released automatically, release the electric parking brake manually (→ page 182).</p> <p>If it is still not possible to release the electric parking brake:</p> <p>► Do not continue driving under any circumstances. Consult a qualified specialist workshop.</p>   |
| <div data-bbox="205 405 362 484" style="border: 1px solid black; padding: 5px; text-align: center; font-weight: bold; font-size: 1.2em;">PARK</div> <p data-bbox="205 495 306 519">(USA only)</p> <div data-bbox="205 532 362 612" style="border: 1px solid black; padding: 5px; text-align: center; font-weight: bold; font-size: 1.2em;">(P)</div> <p data-bbox="205 622 340 646">(Canada only)</p> <p data-bbox="195 656 430 705">Please Release Parking Brake</p> | <p>* The red <span style="border: 1px solid black; padding: 0 2px;">PARK</span> indicator lamp (USA only) or <span style="border: 1px solid black; border-radius: 50%; padding: 0 2px;">P</span> indicator lamp (Canada only) is flashing.</p> <p>The electric parking brake is applied while you are driving:</p> <ul style="list-style-type: none"> <li>• A condition for automatic release of the electric parking brake has not been fulfilled (→ page 181).</li> <li>• You are performing emergency braking using the electric parking brake (→ page 182).</li> </ul> <p>► Check the conditions for automatic release of the electric parking brake.</p> <p>► Release the electric parking brake manually.</p> |

| Display messages  | Possible causes/consequences and ► Solutions   |
|---|--|
| <div data-bbox="155 252 312 335" data-label="Image"></div> <p data-bbox="155 342 260 366">(USA only)</p> <div data-bbox="155 379 312 462" data-label="Image"></div> <p data-bbox="155 469 291 493">(Canada only)</p> <p data-bbox="147 505 412 554">Turn On the Ignition to Release the Parking Brake</p> | <p data-bbox="473 249 1363 308">* The red  (USA only) or  indicator lamp (Canada only) is lit. You have attempted to release the electric parking brake with the ignition switched off.</p> <ul data-bbox="495 319 753 342" style="list-style-type: none"> <li>► Switch on the ignition.</li> </ul>  |
| <div data-bbox="155 584 312 667" data-label="Image"></div> <p data-bbox="147 674 253 698">(USA only)</p> <div data-bbox="155 710 312 793" data-label="Image"></div> <p data-bbox="147 800 284 824">(Canada only)</p> <p data-bbox="147 837 389 857">Check Brake Fluid Level</p>                           | <p data-bbox="473 581 1079 605">* There is insufficient brake fluid in the brake fluid reservoir.</p> <div data-bbox="495 619 1652 837" data-label="Complex-Block"> <p data-bbox="513 629 1134 653"><b>▲ WARNING</b> Risk of an accident due to low brake fluid level</p> <p data-bbox="513 671 1511 695">If the brake fluid level is too low, the braking effect and the braking characteristics may be impaired.</p> <ul data-bbox="513 705 1585 826" style="list-style-type: none"> <li>► Pull over and stop the vehicle safely as soon as possible, paying attention to road and traffic conditions. Do not continue driving under any circumstances.</li> <li>► Consult a qualified specialist workshop.</li> <li>► Do not add brake fluid.</li> </ul> </div> |





| Display messages  | Possible causes/consequences and ► Solutions   |
|---|--|
|   | <ul style="list-style-type: none"> <li>► Stop the vehicle immediately in accordance with the traffic conditions. Do not continue driving under any circumstances.</li> <li>► Do not add brake fluid.</li> <li>► Consult a qualified specialist workshop.</li> </ul>  |
| <div data-bbox="205 388 362 471" data-label="Image"> </div> <p data-bbox="195 478 425 528">Check Brake Pads See Operator's Manual</p> | <p data-bbox="524 385 981 409">* The brakepads have reached the wear limit.</p> <div data-bbox="547 426 1696 581" data-label="Complex-Block" style="border: 1px solid gray; padding: 5px;"> <p data-bbox="565 437 1203 461"><b>▲ WARNING</b> Risk of accident due to restricted braking power</p> <p data-bbox="565 475 1452 499">When the brake pads have reached their wear limit, the braking power may be restricted.</p> <ul style="list-style-type: none"> <li>► Drive on carefully.</li> <li>► Have the brake system checked immediately at a qualified specialist workshop.</li> </ul> </div> <ul style="list-style-type: none"> <li>► Consult a qualified specialist workshop.</li> </ul> |

### Driving systems

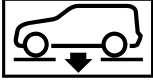
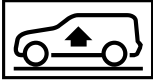
| Display messages   | Possible causes/consequences and ► Solutions  |
|--|---|
|  <p>ATTENTION ASSIST Inoperative</p>    | <ul style="list-style-type: none"> <li>* ATTENTION ASSIST is malfunctioning.                             <ul style="list-style-type: none"> <li>► Consult a qualified specialist workshop.</li> </ul> </li> </ul>   |
|  <p>ATTENTION ASSIST: Take a Break!</p> | <ul style="list-style-type: none"> <li>* ATTENTION ASSIST has detected fatigue or an increasing lack of concentration on the part of the driver (→ page 238).                             <ul style="list-style-type: none"> <li>► If necessary, take a break.</li> </ul> </li> </ul>   |
| <p>Active Parking Assist and PARKTRONIC Inoperative<br/>See Operator's Manual</p>  | <ul style="list-style-type: none"> <li>* Active Parking Assist and Parking Assist PARKTRONIC are malfunctioning.                             <ul style="list-style-type: none"> <li>► Stop the vehicle in accordance with the traffic conditions and restart the engine.</li> <li>► If the display message continues to be displayed, consult a qualified specialist workshop.</li> </ul> </li> </ul> |

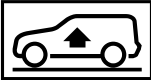
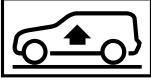
| Display messages  | Possible causes/consequences and ► Solutions   |
|---|--|
|  <p data-bbox="195 342 458 394">Malfunction Drive at Max.<br/>50 mph</p> | <p data-bbox="522 249 1696 298">* The AIR BODY CONTROL is functioning only to a limited extent. The vehicle's handling characteristics may be affected.</p> <ul style="list-style-type: none"> <li data-bbox="543 311 1474 337">► Drive in a manner appropriate for the current level, but do not exceed 50 mph (80 km/h).</li> <li data-bbox="543 342 975 368">► Consult a qualified specialist workshop.</li> </ul>              |
|  <p data-bbox="195 513 288 534">Lowering</p>                             | <p data-bbox="522 420 1132 441">* The vehicle level may be lowered for the following reasons:</p> <ul style="list-style-type: none"> <li data-bbox="550 451 1021 472">• You have selected a different drive program.</li> <li data-bbox="550 482 931 503">• You have exceeded the speed limit.</li> <li data-bbox="550 513 1160 544">• You have changed the vehicle level by pressing the button.</li> </ul>                       |
|  <p data-bbox="195 655 338 676">Vehicle Rising</p>                       | <p data-bbox="522 562 1095 583">* Your vehicle is adjusting to the level you have selected.</p>  |
| <p data-bbox="195 703 380 724">Drive More Slowly</p>  | <p data-bbox="522 703 1073 724">* You are driving too fast for the selected vehicle level.</p> <ul style="list-style-type: none"> <li data-bbox="543 734 1467 760">► To adjust the vehicle level, you must not drive at speeds greater than 37 mph (60 km/h).</li> <li data-bbox="543 770 1585 822">► To adjust the vehicle level during trailer operation, you must not drive at speeds greater than 19 mph (30 km/h).</li> </ul> |

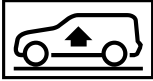
| Display messages  | Possible causes/consequences and ► Solutions  |
|---|---|
|  <p>Max. Speed 12 mph</p>            | <ul style="list-style-type: none"> <li>* You are driving too fast for the selected vehicle level.                             <ul style="list-style-type: none"> <li>► Do not exceed 12 mph (20 km/h).</li> </ul> </li> </ul>   |
|  <p>Stop Vehicle Vehicle Too Low</p> | <ul style="list-style-type: none"> <li>* You have pulled away despite the vehicle level being too low.                             <ul style="list-style-type: none"> <li>► Stop the vehicle in accordance with the traffic conditions. The vehicle will be raised to the selected vehicle level.</li> <li>► Wait until the display message disappears before pulling away.</li> </ul> </li> </ul> <p>If the display message does not disappear and a warning tone also sounds, AIR BODY CONTROL is malfunctioning:</p> <ul style="list-style-type: none"> <li>► Do not drive at speeds greater than 50 mph (80 km/h) and consult a qualified specialist workshop immediately.</li> </ul> <div style="border: 1px solid black; padding: 5px; margin-top: 10px;"> <p><b>!</b> <b>NOTE</b> The tires of the front axle or the front fenders could be damaged by large steering movements</p> <ul style="list-style-type: none"> <li>► Avoid large steering movements while driving and listen for scraping sounds.</li> <li>► If you hear scraping sounds, pull over and stop the vehicle safely, paying attention to road and traffic conditions, and set a higher vehicle level if possible.</li> </ul> </div> <ul style="list-style-type: none"> <li>► Set a higher vehicle level (→ page 216). Depending on the malfunction, the vehicle will be raised.</li> </ul> |

| Display messages  | Possible causes/consequences and ► Solutions   |
|---|--|
|  <p data-bbox="195 344 463 368">Vehicle Rising Please Wait</p> | <ul style="list-style-type: none"> <li>* The vehicle level is too low. The vehicle will be raised to the selected vehicle level.               <ul style="list-style-type: none"> <li>► Wait until the display message disappears before pulling away.</li> </ul> </li> </ul>  |
| <p data-bbox="195 391 463 469">Active Steering Assist Currently Unavailable See Operator's Manual</p>   | <ul style="list-style-type: none"> <li>* Active Steering Assist is temporarily unavailable. The ambient conditions are outside the system limits (→ page 207).               <ul style="list-style-type: none"> <li>► Drive on. As soon as the ambient conditions are within the system limits, the system will become available again.</li> <li>► If necessary, clean the windshield in the camera's field of vision.</li> <li>► Check the tire pressure if necessary.</li> </ul> </li> </ul> |
| <p data-bbox="195 596 463 645">Active Steering Assist Inoperative</p>   | <ul style="list-style-type: none"> <li>* Active Steering Assist is malfunctioning. Active Distance Assist DISTRONIC remains available.               <ul style="list-style-type: none"> <li>► Consult a qualified specialist workshop.</li> </ul> </li> </ul>  |
|    | <ul style="list-style-type: none"> <li>* Active Steering Assist has reached the system limits (→ page 207). You have not steered independently for a considerable period of time.               <ul style="list-style-type: none"> <li>► Take over the steering and drive on in accordance with the traffic conditions.</li> </ul> </li> </ul>   |
| <p data-bbox="195 780 463 803">Beginning Emergency Stop</p>   | <ul style="list-style-type: none"> <li>* Your hands are not on the steering wheel. Emergency stop is initiated (→ page 210).               <ul style="list-style-type: none"> <li>► Put your hands back on the steering wheel.</li> </ul> </li> </ul>  |

## 532 Display messages and warning/indicator lamps

| Display messages   | Possible causes/consequences and ► Solutions  |
|--|---|
|  | <p>You can cancel the deceleration at any time by performing one of the following actions:</p> <ul style="list-style-type: none"><li>• Steering</li><li>• Braking or accelerating</li><li>• Pressing a steering wheel button</li><li>• Operating Touch Control</li><li>• Deactivating Active Distance Assist DISTRONIC</li></ul>  |
| <a href="#">Active Steering Assist Currently Unavailable Due to Multiple Emergency Stops</a> | <p>* Active Steering Assist is temporarily unavailable due to multiple emergency stops.</p> <ul style="list-style-type: none"><li>► Take over the steering and stop in accordance with the traffic conditions.</li><li>► Switch the ignition off and switch it back on.<br/>Active Steering Assist is available once more.</li></ul>  |
| <a href="#">Active Lane Keeping Assist Currently Unavailable See Operator's Manual</a>       | <p>* Active Lane Keeping Assist is temporarily unavailable.<br/>The ambient conditions are outside the system limits (→ page 245).</p> <p><b>Vehicles with Active Steering Assist:</b> The camera view may be limited by the windshield.</p> <ul style="list-style-type: none"><li>► Drive on.<br/>As soon as the ambient conditions are within the system limits, the system will become available again.</li></ul> <p><b>Vehicles with Active Steering Assist:</b> If the display message does not disappear:</p> <ul style="list-style-type: none"><li>► Stop the vehicle in accordance with the traffic conditions.</li><li>► Clean the windshield.</li></ul> |



| Display messages  | Possible causes/consequences and ► Solutions  |
|---|---|
| Active Lane Keeping Assist Inoperative                                      | <ul style="list-style-type: none"> <li>* Active Lane Keeping Assist is malfunctioning.               <ul style="list-style-type: none"> <li>► Consult a qualified specialist workshop.</li> </ul> </li> </ul>   |
| Blind Spot Assist Currently Unavailable See Operator's Manual               | <ul style="list-style-type: none"> <li>* Blind Spot Assist is temporarily unavailable. The system limits have been reached (→ page 242).               <ul style="list-style-type: none"> <li>► Drive on. Once the cause of the problem is no longer present, the system will be available again.</li> <li>or</li> <li>► If the display message does not disappear, stop the vehicle in accordance with the traffic conditions and restart the engine.</li> <li>► If necessary, clean the rear bumper. If the bumper is especially dirty, the sensors in the bumper may be malfunctioning.</li> </ul> </li> </ul> |
| Blind Spot Assist Inoperative   | <ul style="list-style-type: none"> <li>* Blind Spot Assist is malfunctioning.               <ul style="list-style-type: none"> <li>► Consult a qualified specialist workshop.</li> </ul> </li> </ul>  |
| Blind Spot Assist Not Available When Towing a Trailer See Operator's Manual | <ul style="list-style-type: none"> <li>* When you establish the electrical connection to the trailer, Blind Spot Assist is unavailable.               <ul style="list-style-type: none"> <li>► Press the left-hand Touch Control and acknowledge the display message.</li> </ul> </li> </ul>  |
| Active Blind Spot Assist Currently Unavailable See Operator's Manual        | <ul style="list-style-type: none"> <li>* Active Blind Spot Assist is temporarily unavailable. The system limits have been reached (→ page 242).</li> </ul>  |





## 534 Display messages and warning/indicator lamps

| Display messages  | Possible causes/consequences and ► Solutions   |
|---|--|
|   | <ul style="list-style-type: none"><li>► Drive on.<br/>Once the cause of the problem is no longer present, the system will be available again.</li><li>or</li><li>► If the display message does not disappear, stop the vehicle in accordance with the traffic conditions and restart the engine.</li></ul> |
| Active Blind Spot Assist Inoperative  | <ul style="list-style-type: none"><li>* Active Blind Spot Assist is malfunctioning.</li><li>► Consult a qualified specialist workshop.</li></ul>   |
| Active Blind Spot Asst. Not Available When Towing a Trailer See Operator's Manual | <ul style="list-style-type: none"><li>* When you establish the electrical connection to the trailer, Active Blind Spot Assist is unavailable.</li><li>► Press the left-hand Touch Control and acknowledge the display message.</li></ul>   |
| Traffic Sign Assist Currently Unavailable See Operator's Manual                   | <ul style="list-style-type: none"><li>* Traffic Sign Assist is temporarily unavailable.</li><li>► Drive on.<br/>Once the cause of the problem is no longer present, the system will be available again.</li></ul>  |
| Traffic Sign Assist Inoperative   | <ul style="list-style-type: none"><li>* Traffic Sign Assist is malfunctioning.</li><li>► Stop the vehicle in accordance with the traffic conditions and restart the engine.</li><li>► If the display message continues to be displayed, consult a qualified specialist workshop.</li></ul>                 |



| Display messages  | Possible causes/consequences and ► Solutions  |
|---|---|
| <p>Traffic Sign Assist Camera View Restricted See Operator's Manual</p>   | <p>* The camera view is restricted. Possible causes:</p> <ul style="list-style-type: none"> <li>• Dirt on the windshield in the camera's field of vision</li> <li>• Heavy rain, snow or fog</li> </ul> <p>Driving systems and driving safety systems may be malfunctioning or temporarily unavailable. Once the cause of the problem is no longer present, the driving systems and driving safety systems will be available again.</p> <p>If the display message does not disappear:</p> <ul style="list-style-type: none"> <li>► Stop the vehicle in accordance with the traffic conditions.</li> <li>► Clean the windshield.</li> </ul> |
| <div style="border: 1px solid black; padding: 5px; text-align: center; width: 80px; margin: 0 auto;"> <p><b>HOLD</b></p> </div> <p>Off</p>  | <p>* The HOLD function is deactivated because the vehicle is slipping or a condition for activation is not fulfilled.</p> <ul style="list-style-type: none"> <li>► Reactivate the HOLD function later or check the activation conditions for the HOLD function (→ page 213).</li> </ul>   |
| <div style="border: 1px solid black; padding: 5px; text-align: center; width: 80px; margin: 0 auto;">  </div> <p>--- mph</p> | <p>* Active Distance Assist DISTRONIC cannot be activated as not all activation conditions are fulfilled.</p> <ul style="list-style-type: none"> <li>► Comply with the activation conditions of Active Distance Assist DISTRONIC (→ page 203).</li> </ul>   |

| Display messages   | Possible causes/consequences and ► Solutions  |
|--|---|
|  <p>Suspended</p> | <p>* If you depress the accelerator pedal beyond the Active Distance Assist DISTRONIC setting, the system will be put into passive mode (→ page 211).</p>   |
|  <p>Off</p>       | <p>* Active Distance Assist DISTRONIC was deactivated. If a warning tone also sounds, Active Distance Assist DISTRONIC has deactivated automatically (→ page 203).</p>  |
| <p>Active Distance Assist Currently Unavailable See Operator's Manual</p>                          | <p>* Active Distance Assist DISTRONIC is temporarily unavailable. The ambient conditions are outside the system limits (→ page 201).</p> <p>► Drive on.<br/>As soon as the ambient conditions are within the system limits, the system will become available again.</p> |
| <p>Active Distance Assist Inoperative</p>  | <p>* Active Distance Assist DISTRONIC is malfunctioning. Other driving systems and driving safety systems may also be malfunctioning.</p> <p>► Consult a qualified specialist workshop.</p>   |
| <p>Active Distance Assist Now Available</p>  | <p>* Active Distance Assist DISTRONIC is operational again and can be activated (→ page 203).</p>   |

| Display messages   | Possible causes/consequences and ► Solutions   |
|--|--|
|  <p>Inoperative</p>                               | <ul style="list-style-type: none"> <li>* The Downhill Speed Regulation is malfunctioning.                             <ul style="list-style-type: none"> <li>► Consult a qualified specialist workshop.</li> </ul> </li> </ul>   |
|  <p>Not in Curr. Drive Prog.</p>                  | <ul style="list-style-type: none"> <li>* The Downhill Speed Regulation is not available in the currently selected drive program.                             <ul style="list-style-type: none"> <li>► Change the drive program (→ page 165).</li> </ul> </li> </ul>                        |
|  <p>Max. Speed 25 mph</p>                         | <ul style="list-style-type: none"> <li>* The maximum speed of 25 mph (40 km/h) for the Downhill Speed Regulation has been exceeded.                             <ul style="list-style-type: none"> <li>► Drive more slowly.</li> </ul> </li> </ul>   |
|  <p>--- mph</p> <p>Cruise Control Inoperative</p> | <ul style="list-style-type: none"> <li>* Cruise control cannot be activated as not all activation conditions are fulfilled.                             <ul style="list-style-type: none"> <li>► Observe the activation conditions for cruise control (→ page 198).</li> </ul> </li> </ul> |
|  | <ul style="list-style-type: none"> <li>* Cruise control is malfunctioning.                             <ul style="list-style-type: none"> <li>► Consult a qualified specialist workshop.</li> </ul> </li> </ul>  |



## 538 Display messages and warning/indicator lamps

| Display messages   | Possible causes/consequences and ► Solutions  |
|--------------------|---|
| Cruise Control Off | * Cruise control has been deactivated.<br>If there is an additional warning tone, cruise control has been deactivated automatically (→ page 197). |

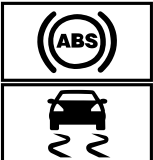
## Driving safety systems

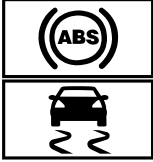
| Display messages   | Possible causes/consequences and ► Solutions   |
|--|--|
| <br>Currently Unavailable See Operator's Manual | * ABS and ESP® are temporarily unavailable.<br>Other driving systems and driving safety systems may also be temporarily unavailable.<br>The brake system will continue to operate normally. Braking distance may increase in an emergency braking situation.<br><br><b>▲ WARNING</b> Risk of skidding if ABS and ESP® are malfunctioning<br>If ABS and ESP® are malfunctioning, the wheels could lock when braking and ESP® cannot carry out vehicle stabilization.<br>The steering capability and braking characteristics are thus severely impaired. The braking distance in an emergency braking situation can increase. In addition, other driving safety systems are switched off.<br><ul style="list-style-type: none"><li>► Drive on carefully.</li><li>► Have ABS and ESP® checked immediately at a qualified specialist workshop.</li></ul> |

| Display messages  | Possible causes/consequences and ► Solutions   |
|---|--|
|   | <ul style="list-style-type: none"> <li>► Drive carefully on a suitable stretch of road, making slight steering movements at a speed above 19 mph (30 km/h).</li> <li>► If the display message does not disappear, consult a qualified specialist workshop immediately. Drive carefully.</li> </ul>   |
| <div style="text-align: center;">  </div> <p data-bbox="195 529 469 578">Inoperative See Operator's Manual</p> | <p data-bbox="528 353 888 379">* ABS and ESP® are malfunctioning.</p> <p data-bbox="543 389 1319 415">Other driving systems and driving safety systems may also be malfunctioning.</p> <p data-bbox="543 425 1689 472">The brake system will continue to operate normally. Braking distance may increase in an emergency braking situation.</p> <div style="border: 1px solid black; padding: 5px; margin: 10px 0;"> <p data-bbox="565 503 1240 529"><b>▲ WARNING</b> Risk of skidding if ABS and ESP® are malfunctioning</p> <p data-bbox="561 544 1641 596">If ABS and ESP® are malfunctioning, the wheels could lock when braking and ESP® cannot carry out vehicle stabilization.</p> <p data-bbox="561 607 1677 658">The steering capability and braking characteristics are thus severely impaired. The braking distance in an emergency braking situation can increase. In addition, other driving safety systems are switched off.</p> <ul style="list-style-type: none"> <li>► Drive on carefully.</li> <li>► Have ABS and ESP® checked immediately at a qualified specialist workshop.</li> </ul> </div> <ul style="list-style-type: none"> <li>► Drive on carefully.</li> <li>► Consult a qualified specialist workshop immediately.</li> </ul> |

| Display messages   | Possible causes/consequences and ► Solutions   |
|--|--|
|  <p data-bbox="144 342 408 391">Currently Unavailable See Operator's Manual</p> | <p data-bbox="476 249 1267 311">* ESP® is temporarily unavailable.<br/>Other driving systems and driving safety systems may also be malfunctioning.</p> <div data-bbox="495 329 1646 515" style="border: 1px solid gray; padding: 5px;"> <p data-bbox="513 339 1082 365">▲ <b>WARNING</b> Risk of skidding if ESP® is malfunctioning</p> <p data-bbox="513 381 1609 433">If ESP® is malfunctioning, ESP® cannot carry out vehicle stabilization. In addition, other driving safety systems are switched off.</p> <ul style="list-style-type: none"> <li data-bbox="513 446 728 467">► Drive on carefully.</li> <li data-bbox="513 480 1092 501">► Have ESP® checked at a qualified specialist workshop.</li> </ul> </div> <ul style="list-style-type: none"> <li data-bbox="495 532 1572 584">► Drive carefully on a suitable stretch of road, making slight steering movements at a speed above 19 mph (30 km/h).</li> <li data-bbox="495 594 1633 615">► If the display message does not disappear, consult a qualified specialist workshop immediately. Drive carefully.</li> </ul> |
|  <p data-bbox="144 731 417 780">Inoperative See Operator's Manual</p>           | <p data-bbox="476 638 1267 700">* ESP® is malfunctioning.<br/>Other driving systems and driving safety systems may also be malfunctioning.</p> <p data-bbox="495 710 1633 762">The brake system will continue to operate normally. Braking distance may increase in an emergency braking situation.</p>  |

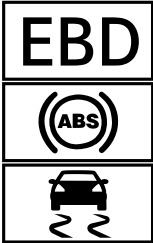
| Display messages   | Possible causes/consequences and ► Solutions  |
|--|---|
|  | <p><b>▲ WARNING</b> Risk of skidding if ESP® is malfunctioning</p> <p>If ESP® is malfunctioning, ESP® cannot carry out vehicle stabilization. In addition, other driving safety systems are switched off.</p> <ul style="list-style-type: none"> <li>► Drive on carefully.</li> <li>► Have ESP® checked at a qualified specialist workshop.</li> </ul> <p>► Drive on carefully.</p> <p>► Consult a qualified specialist workshop immediately.</p>   |
|  <p>Inoperative See Operator's Manual</p> | <p>* EBD, ABS and ESP® are malfunctioning.<br/>Other driving systems and driving safety systems may also be malfunctioning.</p> <p><b>▲ WARNING</b> Risk of skidding if EBD, ABS and ESP® are malfunctioning</p> <p>If EBD, ABS and ESP® are malfunctioning, the wheels can lock when braking and ESP® cannot carry out vehicle stabilization.</p> <p>The steering capability and braking characteristics are thus severely impaired. The braking distance in an emergency braking situation can increase. In addition, other driving safety systems are switched off.</p> <ul style="list-style-type: none"> <li>► Drive on carefully.</li> <li>► Have the brake system checked immediately at a qualified specialist workshop.</li> </ul> |

## 542 Display messages and warning/indicator lamps

| Display messages  | Possible causes/consequences and ► Solutions  |
|---|---|
| <a href="#">Active Brake Assist Functions Currently Limited See Operator's Manual</a> | <ul style="list-style-type: none"><li>► Drive on carefully.</li><li>► Consult a qualified specialist workshop immediately.</li></ul> <p>* <b>Vehicles with the Driving Assistance Package:</b> Active Brake Assist with cross-traffic function, Evasive Steering Assist or PRE-SAFE® PLUS are temporarily unavailable or only partially available.</p> <p><b>Vehicles without the Driving Assistance Package:</b> Active Brake Assist is temporarily unavailable or only partially available.</p> <p>The ambient conditions are outside the system limits (→ page 191).</p> <ul style="list-style-type: none"><li>► Drive on.<br/>As soon as the ambient conditions are within the system limits, the system will become available again.</li><li>► If the display message does not disappear, stop the vehicle in accordance with the traffic conditions and restart the engine.</li></ul> |
| <a href="#">Active Brake Assist Functions Limited See Operator's Manual</a>           | <p>* <b>Vehicles with Driving Assistance Package:</b> Active Brake Assist with cross-traffic function, Evasive Steering Assist or PRE-SAFE® PLUS is malfunctioning.</p> <p><b>Vehicles without Driving Assistance Package:</b> Active Brake Assist is malfunctioning.</p> <ul style="list-style-type: none"><li>► Consult a qualified specialist workshop.</li></ul>  |
| <a href="#">Radar Sensors Dirty See Operator's Manual</a>                             | <p>* The radar sensor system is malfunctioning. Possible causes:</p> <ul style="list-style-type: none"><li>• Dirt on the sensors</li><li>• Heavy rain or snow</li><li>• Extended country driving without other traffic, e.g. in the desert</li></ul>  |





| Display messages | Possible causes/consequences and ► Solutions   |
|------------------|--|
|                  | <p>Driving systems and driving safety systems may be malfunctioning or temporarily unavailable.</p> <p>Once the cause of the problem is no longer present, the driving systems and driving safety systems will be available again.</p> <p>If the display message does not disappear:</p> <ul style="list-style-type: none"> <li>► Pull over and stop the vehicle safely as soon as possible, paying attention to road and traffic conditions.</li> <li>► Clean all sensors (→ page 433).</li> <li>► Restart the engine.</li> </ul> |

### Mercedes me connect

| Display messages   | Possible causes/consequences and ► Solutions  |
|--|---|
| <p>Mercedes me connect<br/>Services Limited See Operator's Manual</p>                                | <p>* Service limited.</p> <p>At least one of the main functions of the Mercedes me connect system is malfunctioning.</p> <ul style="list-style-type: none"> <li>► Observe the notes on the diagnostics connection (→ page 26).</li> <li>► Consult a qualified specialist workshop.</li> </ul> |
|  <p>Inoperative</p> | <p>* At least one of the main functions of the Mercedes me connect system or of the SOS emergency call system is malfunctioning.</p> <ul style="list-style-type: none"> <li>► Consult a qualified specialist workshop.</li> </ul>   |

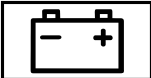

## Battery

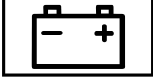

| Display messages  | Possible causes/consequences and ► Solutions   |
|---|--|
|  <p data-bbox="144 408 391 453">12 V Battery See Operator's Manual</p> | <ul style="list-style-type: none"> <li data-bbox="476 314 1055 337">* The engine is off and the battery charge level is too low.               <ul style="list-style-type: none"> <li data-bbox="495 348 1064 370">► Switch off electrical consumers that are not required.</li> </ul> </li> <li data-bbox="495 399 717 422">To charge the battery:               <ul style="list-style-type: none"> <li data-bbox="495 433 1276 455">► Leave the engine running for a few minutes, or drive an extended distance.</li> </ul> </li> <li data-bbox="476 466 1578 488">* If the message appears while the engine is running, this indicates an on-board electrical system malfunction.               <ul style="list-style-type: none"> <li data-bbox="495 499 894 522">► Visit a qualified specialist workshop.</li> </ul> </li> </ul>                  |
|  <p data-bbox="144 636 376 658">See Operator's Manual</p>              | <ul style="list-style-type: none"> <li data-bbox="476 542 824 565">* The battery is not being charged.               <div data-bbox="500 584 1646 705" style="border: 1px solid gray; padding: 5px; margin-top: 5px;"> <p data-bbox="513 594 1092 617"><b>!</b> <b>NOTE</b> Possible engine damage if you continue driving</p> <ul style="list-style-type: none"> <li data-bbox="513 636 1045 658">► Do not continue driving under any circumstances.</li> <li data-bbox="513 669 944 692">► Consult a qualified specialist workshop.</li> </ul> </div> <ul style="list-style-type: none"> <li data-bbox="495 721 1622 743">► Pull over and stop the vehicle safely and switch off the engine, paying attention to road and traffic conditions.</li> <li data-bbox="495 754 925 777">► Consult a qualified specialist workshop.</li> </ul> </li> </ul> |

| Display messages  | Possible causes/consequences and ► Solutions   |
|---|--|
|  <p data-bbox="195 344 445 391">Stop Vehicle See Operator's Manual</p> | <p data-bbox="528 249 1323 275">* The battery is no longer being charged and the battery charge level is too low.</p> <div data-bbox="565 296 1696 335" style="border: 1px solid black; padding: 5px;"> <p data-bbox="565 301 1142 327">! <b>NOTE</b> Possible engine damage if you continue driving</p> <ul data-bbox="565 342 1097 401" style="list-style-type: none"> <li data-bbox="565 342 1097 368">► Do not continue driving under any circumstances.</li> <li data-bbox="565 373 994 401">► Consult a qualified specialist workshop.</li> </ul> </div> <ul data-bbox="547 430 1683 550" style="list-style-type: none"> <li data-bbox="547 430 1683 482">► Pull over and stop the vehicle safely as soon as possible in accordance with the traffic conditions. Do not continue driving under any circumstances.</li> <li data-bbox="547 487 802 513">► Switch off the engine.</li> <li data-bbox="547 519 975 550">► Consult a qualified specialist workshop.</li> </ul> |
|  <p data-bbox="195 663 463 709">Stop Vehicle Leave Engine Running</p>  | <p data-bbox="528 567 894 593">* The battery charge level is too low.</p> <ul data-bbox="547 603 1683 754" style="list-style-type: none"> <li data-bbox="547 603 1683 655">► Pull over and stop the vehicle safely as soon as possible in accordance with the traffic conditions. Do not continue driving under any circumstances.</li> <li data-bbox="547 660 838 686">► Leave the engine running.</li> <li data-bbox="547 692 1203 717">► Wait until the display message disappears before pulling away.</li> <li data-bbox="547 728 1443 754">► <b>If the display message does not disappear:</b> consult a qualified specialist workshop.</li> </ul>   |

### Tire pressure monitor

| Display messages                                   | Possible causes/consequences and ► Solutions   |
|--|--|
| Tire Press. Monitor Currently Unavailable          | <p>* There is interference from a powerful radio signal source. As a result, no signals from the tire pressure sensors are being received. The tire pressure monitor is temporarily unavailable.</p> <ul style="list-style-type: none"> <li>► Drive on.<br/>The tire pressure monitor will restart automatically as soon as the cause has been rectified.</li> </ul>   |
| Tire Press. Monitor Inoperative                    | <p>* The tire pressure monitor is malfunctioning.</p> <div style="border: 1px solid gray; padding: 5px; margin: 5px 0;"> <p><b>▲ WARNING</b> There is a risk of an accident if the tire pressure monitoring system is malfunctioning</p> <p>If the tire pressure monitoring system is malfunctioning, it is not able to issue a warning if there is pressure loss in one or more of the tires.</p> <p>Underinflated tires may, for example, impair the driving, steering and braking characteristics.</p> <ul style="list-style-type: none"> <li>► Have the tire pressure monitoring system checked at a qualified specialist workshop.</li> </ul> </div> <ul style="list-style-type: none"> <li>► Consult a qualified specialist workshop.</li> </ul> |
| Tire Pressure Monitor Inoperative No Wheel Sensors | <p>* The wheels installed do not have suitable tire pressure sensors. The tire pressure monitor is deactivated.</p> <ul style="list-style-type: none"> <li>► Install wheels with suitable tire pressure sensors.</li> </ul>  |

| Display messages   | Possible causes/consequences and ► Solutions   |
|--|--|
|  <p data-bbox="195 342 445 368">Wheel Sensor(s) Missing</p> | <p data-bbox="524 249 1702 298">* There is no signal from the tire pressure sensor of one or more wheels. No pressure value is displayed for the affected tire.</p> <ul style="list-style-type: none"> <li data-bbox="543 311 1374 337">► Have the faulty tire pressure sensor replaced at a qualified specialist workshop.</li> </ul>   |
|  <p data-bbox="195 484 316 510">Check Tires</p>             | <p data-bbox="524 391 1504 417">* The tire pressure in one or more tires has dropped significantly. The wheel position is displayed.</p> <div data-bbox="547 433 1702 733" style="border: 1px solid gray; padding: 10px;"> <p data-bbox="565 443 1230 469"><b>⚠ WARNING</b> Risk of an accident due to insufficient tire pressure</p> <p data-bbox="565 484 1147 510">Tire pressures that are too low pose the following hazards:</p> <ul style="list-style-type: none"> <li data-bbox="565 521 1300 547">• The tires may burst, especially as the load and vehicle speed increase.</li> <li data-bbox="565 552 1471 578">• The tires may wear excessively and/or unevenly, which may greatly impair tire traction.</li> <li data-bbox="565 583 1443 609">• The driving characteristics, as well as steering and braking, may be greatly impaired.</li> </ul> <p data-bbox="565 624 981 650">You could then lose control of the vehicle.</p> <ul style="list-style-type: none"> <li data-bbox="565 660 1012 686">► Observe the recommended tire pressure.</li> <li data-bbox="565 692 966 717">► Adjust the tire pressure if necessary.</li> </ul> </div> <ul style="list-style-type: none"> <li data-bbox="543 749 1156 774">► Stop the vehicle in accordance with the traffic conditions.</li> <li data-bbox="543 780 1101 806">► Check the tire pressure (→ page 460) and the tires.</li> </ul> |

| Display messages  | Possible causes/consequences and ► Solutions  |
|---|---|
|  <p data-bbox="144 342 397 391">Please Correct Tire Pressure</p> | <p data-bbox="476 249 1596 301">* The tire pressure is too low in at least one of the tires, or the difference in tire pressure between the individual wheels is too great.</p> <ul style="list-style-type: none"> <li data-bbox="495 311 1018 335">► Check the tire pressure and add air, if necessary.</li> <li data-bbox="495 342 1347 366">► When the tire pressure is correct, restart the tire pressure monitor (→ page 465).</li> </ul>  |
|  <p data-bbox="144 511 397 535">Warning Tire Malfunction</p>     | <p data-bbox="476 418 1421 442">* The tire pressure in one or more tires has dropped suddenly. The wheel position is displayed.</p> <div data-bbox="495 459 1646 723" style="border: 1px solid gray; padding: 5px;"> <p data-bbox="513 470 1130 494"><b>▲ WARNING</b> Risk of an accident from driving with a flat tire</p> <p data-bbox="513 511 968 535">Flat tires are dangerous in the following ways:</p> <ul style="list-style-type: none"> <li data-bbox="519 545 940 569">• The tires can overheat and cause a fire.</li> <li data-bbox="519 579 1387 602">• The driving characteristics, as well as steering and braking, may be greatly impaired.</li> </ul> <p data-bbox="513 622 931 646">You could then lose control of the vehicle.</p> <ul style="list-style-type: none"> <li data-bbox="513 656 820 680">► Do not drive with a flat tire.</li> <li data-bbox="513 689 857 713">► Observe the notes on flat tires.</li> </ul> </div> <p data-bbox="495 742 829 766">Notes on flat tires (→ page 437).</p> <ul style="list-style-type: none"> <li data-bbox="495 777 1106 800">► Stop the vehicle in accordance with the traffic conditions.</li> <li data-bbox="495 810 691 833">► Check the tires.</li> </ul> |

| Display messages | Possible causes/consequences and ► Solutions  |
|------------------|---|
| Tires Overheated | <p>* At least one tire is overheating. The affected tires are displayed in red. At temperatures close to the limit value, the tires are displayed in yellow.</p> <p>► Drive more slowly.</p>  |
| Decrease Speed   | <p>* At least one tire is overheating. The affected tires are displayed in red. At temperatures close to the limit value, the tires are displayed in yellow.</p> <div data-bbox="550 420 1696 536" style="border: 1px solid gray; padding: 5px;"> <p><b>⚠ WARNING</b> Risk of an accident from driving with overheated tires</p> <p>Overheated tires may burst, particularly at high speeds.</p> <p>► Reduce speed so that the tires cool down.</p> </div> <p>► Reduce speed so that the tires cool down.</p> |



### Tire pressure loss warning system



| Display messages         | Possible causes/consequences and ► Solutions   |
|--------------------------|--|
| Check Tire Pressure Soon | <p>* Canada only:<br/>The tire pressure loss warning system has detected a significant loss of pressure.</p> |



| Display messages   | Possible causes/consequences and ► Solutions   |
|--|--|
|  | <p><b>▲ WARNING</b> Risk of an accident due to insufficient tire pressure</p> <p>Tire pressures that are too low pose the following hazards:</p> <ul style="list-style-type: none"> <li>• The tires may burst, especially as the load and vehicle speed increase.</li> <li>• The tires may wear excessively and/or unevenly, which may greatly impair tire traction.</li> <li>• The driving characteristics, as well as steering and braking, may be greatly impaired.</li> </ul> <p>You could then lose control of the vehicle.</p> <ul style="list-style-type: none"> <li>► Observe the recommended tire pressure.</li> <li>► Adjust the tire pressure if necessary.</li> </ul> <ul style="list-style-type: none"> <li>► Stop the vehicle in accordance with the traffic conditions.</li> <li>► Check the tire pressure (→ page 460) and the tires.</li> <li>► When the tire pressure is correct, restart the tire pressure loss warning system (→ page 465).</li> </ul> |
| <p>Check Tire Pressure Then Restart Run Flat Indicator</p> | <p>* Canada only:<br/>The tire pressure loss warning system generated a display message and has not been restarted since.</p> <ul style="list-style-type: none"> <li>► When the tire pressure is correct, restart the tire pressure loss warning system (→ page 465).</li> </ul>   |
| <p>Run Flat Indicator Inoperative</p>                      | <p>* Canada only:<br/>The tire pressure loss warning system is malfunctioning.</p> <ul style="list-style-type: none"> <li>► Consult a qualified specialist workshop.</li> </ul>  |



## Engine oil

| Display messages  | Possible causes/consequences and ► Solutions   |
|---|--|
|  <p data-bbox="195 410 450 456">Check Engine Oil At Next Refueling</p>   | <p data-bbox="524 317 1086 337">* The engine oil level has dropped to the minimum level.</p> <div data-bbox="565 358 1692 399" style="border: 1px solid black; padding: 5px;"> <p data-bbox="565 368 1271 389">! <b>NOTE</b> Engine damage caused by driving with insufficient engine oil</p> </div> <div data-bbox="565 410 1692 441" style="border: 1px solid black; padding: 5px;"> <p data-bbox="565 410 1068 430">► Avoid long journeys with insufficient engine oil.</p> </div> <p data-bbox="543 462 1045 482">► Check the engine oil level when next refueling.</p> <p data-bbox="543 503 842 524">Add engine oil (→ page 424).</p> <p data-bbox="543 539 888 560">Notes on engine oil (→ page 497).</p>                                   |
|  <p data-bbox="195 674 426 721">Check Engine Oil Level (Add 1 quart)</p> | <p data-bbox="524 581 962 601">* Display message only for certain engines:</p> <p data-bbox="543 612 1086 632">The engine oil level has dropped to the minimum level.</p> <div data-bbox="565 653 1692 695" style="border: 1px solid black; padding: 5px;"> <p data-bbox="565 664 1271 684">! <b>NOTE</b> Engine damage caused by driving with insufficient engine oil</p> </div> <div data-bbox="565 705 1692 736" style="border: 1px solid black; padding: 5px;"> <p data-bbox="565 705 1068 726">► Avoid long journeys with insufficient engine oil.</p> </div> <p data-bbox="543 757 1252 778">► When next refueling, add 1.1 US qt (1 l) of engine oil (→ page 424).</p> <p data-bbox="543 798 888 819">Notes on engine oil (→ page 497).</p> |

| Display messages   | Possible causes/consequences and ► Solutions   |
|--|--|
|  <p data-bbox="144 342 421 366">Engine Oil Reduce Oil Level</p>                           | <p data-bbox="476 249 912 308">* Display message only for certain engines:<br/>The engine oil level is too high.</p> <div data-bbox="500 325 1646 366" style="border: 1px solid gray; padding: 2px;"><p data-bbox="513 335 1179 360">! <b>NOTE</b> Engine damage caused by driving with excess engine oil</p></div> <div data-bbox="500 370 1646 412" style="border: 1px solid gray; padding: 2px;"><p data-bbox="513 377 975 401">► Avoid long journeys with excess engine oil.</p></div> <p data-bbox="495 428 1430 453">► Consult a qualified specialist workshop immediately and have the engine oil level reduced.</p>  |
|  <p data-bbox="144 563 408 612">Engine Oil Level Low Stop<br/>Vehicle Turn Engine Off</p> | <p data-bbox="476 470 912 529">* Display message only for certain engines:<br/>The engine oil level is too low.</p> <div data-bbox="500 545 1646 587" style="border: 1px solid gray; padding: 2px;"><p data-bbox="513 556 1221 581">! <b>NOTE</b> Engine damage caused by driving with insufficient engine oil</p></div> <div data-bbox="500 591 1646 632" style="border: 1px solid gray; padding: 2px;"><p data-bbox="513 597 1018 622">► Avoid long journeys with insufficient engine oil.</p></div> <p data-bbox="495 649 1618 698">► Stop the vehicle immediately in accordance with the traffic conditions. Do not continue driving under any circumstances.</p> <p data-bbox="495 708 750 733">► Switch off the engine.</p> <p data-bbox="495 743 994 768">► Add 1.1 US qt (1 l) of engine oil (→ page 424).</p> <p data-bbox="495 779 796 803">► Check the engine oil level.</p> <p data-bbox="495 820 842 845">Notes on engine oil (→ page 497).</p> |

| Display messages  | Possible causes/consequences and ► Solutions  |
|---|---|
|  <p data-bbox="195 342 445 394">Engine Oil Pressure Stop<br/>Switch Off Engine</p> | <p data-bbox="524 249 962 308">* Display message only for certain engines:<br/>The engine oil pressure is too low.</p> <div data-bbox="561 327 1696 368" style="border: 1px solid black; padding: 5px;"> <p data-bbox="569 337 1369 360"><b>!</b> <b>NOTE</b> Engine damage caused by driving with insufficient engine oil pressure</p> </div> <div data-bbox="561 373 1696 412" style="border: 1px solid black; padding: 5px;"> <p data-bbox="569 379 1097 401">► Avoid driving with insufficient engine oil pressure.</p> </div> <ul data-bbox="543 430 1670 515" style="list-style-type: none"> <li data-bbox="543 430 1670 477">► Stop the vehicle immediately in accordance with the traffic conditions. Do not continue driving under any circumstances.</li> <li data-bbox="543 487 975 515">► Consult a qualified specialist workshop.</li> </ul> |
|  <p data-bbox="195 624 467 676">Engine Oil Level Cannot Be<br/>Measured</p>        | <p data-bbox="524 531 1541 554">* The electrical connection to the oil level sensor has been interrupted or the oil level sensor is faulty.</p> <ul data-bbox="543 564 975 592" style="list-style-type: none"> <li data-bbox="543 564 975 592">► Consult a qualified specialist workshop.</li> </ul>  |

### Warning and indicator lamps

#### Overview of indicator and warning lamps

Some systems will perform a self-test when the ignition is switched on. Some indicator and warning lamps may briefly light up or flash. This

behavior is non-critical. These indicator and warning lamps indicate a malfunction only if they light up or flash after the engine has been started or during a journey.

## 554 Display messages and warning/indicator lamps

### Instrument Display (standard)

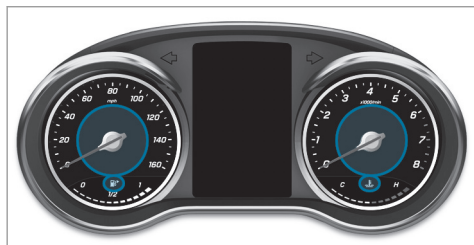



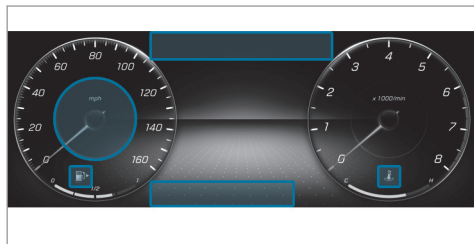











### Widescreen Cockpit Instrument Display



Depending on the display setting, the positions of the indicator lamps on the Instrument Display may differ from the example shown.

#### Indicator and warning lamps:

-  Low beam (→ page 130)
-  Parking lamps (→ page 130)
-  High beam (→ page 131)
-  Turn signal lights (→ page 131)
-  Rear fog lamp (→ page 130)
-  Restraint system (→ page 555)
-  Seat belt not fastened (→ page 555)
-  USA: brakes (red) (→ page 560)
-  Canada: brakes (red) (→ page 560)
-  Electric parking brake (yellow) (→ page 560)
-  USA: electric parking brake applied (red) (→ page 560)
-  Canada: electric parking brake applied (red) (→ page 560)
-  ABS malfunction (→ page 563)
-  ESP® (→ page 563)



ESP® OFF (→ page 563)



Distance warning (→ page 562)



Electric power steering malfunction (→ page 556)



AIR BODY CONTROL malfunction (→ page 562)



Check Engine (→ page 557)



Electrical malfunction (→ page 557)



Fuel reserve with fuel filler cap location indicator (→ page 557)





Coolant too hot/cold (→ page 557)



Tire pressure monitor (→ page 566)

## Occupant safety

| Warning/indicator lamp  | Possible causes/consequences and ► Solutions  |
|---|---|
|  <p data-bbox="194 383 452 429">Restraint system warning lamp</p>  | <p data-bbox="508 290 1219 315">The red restraint system warning lamp is lit while the engine is running.</p> <p data-bbox="508 326 1053 352">*The restraint system is malfunctioning (→ page 34).</p> <div data-bbox="526 367 1690 538" style="border: 1px solid gray; padding: 5px;"> <p data-bbox="545 378 1275 404"><b>▲ WARNING</b> Risk of injury due to malfunctions in the restraint system</p> <p data-bbox="545 419 1653 492">If the restraint system is malfunctioning, restraint system components may be triggered unintentionally or may not deploy as intended during an accident. This may affect the Emergency Tensioning Devices or airbags, for example.</p> <p data-bbox="545 502 1533 528">► Have the restraint system checked and repaired immediately at a qualified specialist workshop.</p> </div> <ul data-bbox="526 554 1062 647" style="list-style-type: none"> <li data-bbox="526 554 748 580">► Drive on carefully.</li> <li data-bbox="526 590 1044 616">► Note the messages on the multifunction display.</li> <li data-bbox="526 626 1062 652">► Visit a qualified specialist workshop immediately.</li> </ul> |
|  <p data-bbox="194 756 434 802">Seat belt warning lamp flashes</p> | <p data-bbox="508 668 1312 694">The red seat belt warning lamp flashes and an intermittent warning tone sounds.</p> <p data-bbox="508 704 1441 730">* The driver or front passenger has not fastened their seat belt while the vehicle is in motion.</p> <ul data-bbox="526 735 1081 828" style="list-style-type: none"> <li data-bbox="526 735 914 761">► Fasten your seat belt(→ page 38).</li> <li data-bbox="508 766 997 792">* There are objects on the front passenger seat.</li> <li data-bbox="526 802 1081 828">► Remove the objects from the front passenger seat.</li> </ul>   |

| Warning/indicator lamp  | Possible causes/consequences and ► Solutions  |
|---|---|
|  <p data-bbox="144 342 376 391">Seat belt warning lamp lights up</p> | <p data-bbox="452 249 1332 308">The red seat belt warning lamp will light up for six seconds once the engine has started. In addition, a warning tone may sound.</p> <p data-bbox="463 319 1400 342">*The seat belt warning lamp reminds the driver and front passenger to fasten their seat belts.</p> <ul data-bbox="476 353 864 377" style="list-style-type: none"><li data-bbox="476 353 864 377">► Fasten your seat belt (→ page 38).</li></ul> <p data-bbox="476 394 1452 418">If you have placed objects on the front passenger seat, the seat belt warning lamp may remain lit.</p> |

## Vehicle

| Warning/indicator lamp  | Possible causes/consequences and ► Solutions  |
|---|---|
|  <p data-bbox="144 653 399 702">Warning lamp for electric power steering</p> | <p data-bbox="452 560 1234 584">The red electric power steering warning lamp is lit while the engine is running.</p> <p data-bbox="463 594 1147 618">*The power-assisted steering or the steering itself is malfunctioning.</p> <div data-bbox="482 636 1646 816" style="border: 1px solid black; padding: 5px;"><p data-bbox="495 646 1138 670"><b>▲ WARNING</b> Risk of accident if steering capability is impaired</p><p data-bbox="495 687 1397 711">If the steering does not function as intended, the vehicle's operating safety is jeopardized.</p><ul data-bbox="495 722 1604 804" style="list-style-type: none"><li data-bbox="495 722 1604 770">► Pull over and stop the vehicle safely as soon as possible, paying attention to road and traffic conditions. Do not continue driving under any circumstances.</li><li data-bbox="495 781 931 804">► Consult a qualified specialist workshop.</li></ul></div> <ul data-bbox="476 832 994 856" style="list-style-type: none"><li data-bbox="476 832 994 856">► Note the messages on the multifunction display.</li></ul> |

## Engine

## Warning/indicator lamp



Coolant warning lamp

## Possible causes/consequences and ► Solutions

The red coolant warning lamp is lit while the engine is running.

\*Possible causes:

- The temperature sensor is malfunctioning
- Coolant level too low
- The air supply to the radiator is obstructed
- The radiator fan is faulty

If there is an additional warning tone, the coolant temperature has exceeded the maximum permissible temperature.



**▲ WARNING** Danger of burns when opening the hood

If you open the hood when the engine has overheated or during a fire in the engine compartment, you could come into contact with hot gases or other escaping operating fluids.



- Before opening the hood, allow the engine to cool down.
- In the event of a fire in the engine compartment, keep the hood closed and call the fire service.

- Stop the vehicle immediately in accordance with the traffic conditions and switch off the engine. Do not continue driving under any circumstances.
- Note the messages on the multifunction display.



If the coolant temperature display is at the lower end of the temperature scale:

| Warning/indicator lamp   | Possible causes/consequences and ► Solutions   |
|--|--|
|  | <ul style="list-style-type: none"> <li>► Consult a qualified specialist workshop.</li> <li>or</li> <li>► Exit the vehicle and keep a safe distance from it until the engine has cooled down.</li> <li>► Check the coolant level (→ page 426).</li> <li>► Make sure that the air supply to the radiator is not impaired.</li> <li>► Avoiding high loads on the engine, drive to the nearest qualified specialist workshop. In doing so, ensure that the coolant temperature display remains below the red area.</li> </ul>  |
|  <p data-bbox="144 581 402 629">Engine diagnosis warning lamp</p>       | <p data-bbox="454 487 1169 511">The yellow Check Engine warning lamp is lit while the engine is running.</p> <p data-bbox="467 522 1288 545">*A malfunction has occurred in the engine, the exhaust system or the fuel system.</p> <p data-bbox="476 556 1350 580">The emission limit values may be exceeded and the engine may be in emergency mode.</p> <p data-bbox="476 590 1609 639">In some states, legal requirements stipulate that you must immediately consult a qualified specialist workshop as soon as the yellow Check Engine warning lamp lights up.</p> <ul style="list-style-type: none"> <li>► Have the vehicle checked as soon as possible at a qualified specialist workshop.</li> </ul> |
|  <p data-bbox="144 785 426 833">Electrical malfunction warning lamp</p> | <p data-bbox="454 692 948 715">The red electrical malfunction warning lamp is lit.</p> <p data-bbox="463 726 861 750">* There is a malfunction in the electrics.</p> <ul style="list-style-type: none"> <li>► Observe the messages on the multifunction display.</li> </ul>  |



| Warning/indicator lamp   | Possible causes/consequences and ► Solutions   |
|--|--|
|  <p data-bbox="195 342 463 366">Fuel reserve warning lamp</p> | <p data-bbox="510 249 1105 273">The yellow fuel reserve warning lamp lights up while driving.</p> <p data-bbox="510 283 1683 335">*There has been pressure loss in the fuel system. The fuel filler cap is not closed correctly or the fuel system is leaking.</p> <ul data-bbox="528 346 802 369" style="list-style-type: none"><li data-bbox="528 346 802 369">► Close the fuel filler cap.</li></ul> <p data-bbox="528 397 1068 421">If the fuel filler cap has already been closed correctly:</p> <ul data-bbox="528 432 931 455" style="list-style-type: none"><li data-bbox="528 432 931 455">► Visit a qualified specialist workshop.</li></ul> |
|  <p data-bbox="195 565 463 589">Fuel reserve warning lamp</p> | <p data-bbox="510 472 1203 496">The yellow fuel reserve warning lamp is lit while the engine is running.</p> <p data-bbox="510 506 1045 530">* The fuel supply has dropped into the reserve range.</p> <ul data-bbox="528 540 635 564" style="list-style-type: none"><li data-bbox="528 540 635 564">► Refuel.</li></ul>   |

## Brakes

| Warning/indicator lamp  | Possible causes/consequences and ▶ Solutions  |
|---|---|
| <p data-bbox="155 294 310 373"></p> <p data-bbox="144 381 425 456">Red indicator lamp, electric parking brake applied (USA only)</p> <p data-bbox="155 464 310 543"></p> <p data-bbox="144 551 425 626">Red indicator lamp, electric parking brake applied (Canada only)</p> <p data-bbox="155 634 310 713"></p> <p data-bbox="144 721 425 796">Yellow electric parking brake indicator lamp is malfunctioning</p> | <p data-bbox="454 288 1639 336">The red electric parking brake indicator lamp flashes or is lit. The yellow indicator lamp is also lit if the electric parking brake malfunctions.</p> <p data-bbox="454 343 1031 373">* ▶ Observe the messages on the multifunction display.</p> |

## Warning/indicator lamp



Brake warning lamp (USA)



Brakes warning lamp (Canada)

## Possible causes/consequences and ► Solutions

The red brake system warning lamp is lit while the engine is running.

\*Possible causes are:

- The brake force boosting is malfunctioning and the braking characteristics may be affected.
- There is not enough brake fluid in the brake fluid reservoir.

**▲ WARNING** Risk of accident and injury if brake force boosting is malfunctioning

If brake force boosting is malfunctioning, increased brake pedal force may be necessary for braking. The braking characteristics may be impaired. The braking distance can increase in emergency braking situations.

- Stop in a safe location immediately. Do not continue driving.
- Consult a qualified specialist workshop.

**▲ WARNING** Risk of an accident due to low brake fluid level

If the brake fluid level is too low, the braking effect and the braking characteristics may be impaired.



- Pull over and stop the vehicle safely as soon as possible, paying attention to road and traffic conditions. Do not continue driving under any circumstances.
- Consult a qualified specialist workshop.
- Do not add brake fluid.

- Pull over and stop the vehicle safely as soon as possible, paying attention to road and traffic conditions. Do not continue driving under any circumstances.

## 562 Display messages and warning/indicator lamps



| Warning/indicator lamp | Possible causes/consequences and ► Solutions  |
|------------------------|---|
|                        | <ul style="list-style-type: none"><li>► Observe the messages on the multifunction display.</li><li>► Consult a qualified specialist workshop.</li></ul> |

### Driving systems

| Warning/indicator lamp  | Possible causes/consequences and ► Solutions   |
|---|--|
|  <p data-bbox="144 542 410 592">Warning lamp for distance warning function</p> | <p data-bbox="454 449 1153 474">The red distance warning lamp lights up while the vehicle is in motion.</p> <p data-bbox="462 482 1179 507">* The distance to the vehicle in front is too small for the speed selected.</p> <p data-bbox="476 518 1386 542">If there is an additional warning tone, you are approaching an obstacle at too high a speed.</p> <ul style="list-style-type: none"><li>► Be prepared to brake immediately.</li><li>► Increase the distance.</li></ul> <p data-bbox="476 627 938 652">Function of Active Brake Assist (→ page 191).</p> |
|  <p data-bbox="144 764 410 789">Suspension warning lamp</p>                    | <p data-bbox="454 673 964 698">The yellow AIR BODY CONTROL warning lamp is lit.</p> <p data-bbox="462 706 1031 731">* A malfunction has occurred in the AIR BODY CONTROL.</p> <ul style="list-style-type: none"><li>► Note the messages on the multifunction display.</li></ul>  |



## Driving safety systems

| Warning/indicator lamp  | Possible causes/consequences and ► Solutions   |
|---|--|
|  <p data-bbox="195 384 380 407">ABS warning lamp</p> | <p data-bbox="504 291 1129 313">The yellow ABS warning lamp is lit while the engine is running.</p> <p data-bbox="504 325 753 348">*ABS is malfunctioning.</p> <p data-bbox="504 359 1132 382">If there is an additional warning tone, EBD is malfunctioning.</p> <p data-bbox="504 393 1304 416">Other driving systems and driving safety systems may also be malfunctioning.</p> <div data-bbox="532 436 1696 648" style="border: 1px solid black; padding: 5px;"> <p data-bbox="541 446 1280 469"><b>⚠ WARNING</b> There is a risk of skidding if EBD or ABS is malfunctioning</p> <p data-bbox="541 484 1225 507">If EBD or ABS is malfunctioning, the wheels may lock when braking.</p> <p data-bbox="541 519 1665 570">The steering capability and braking characteristics are thus severely impaired. The braking distance in an emergency braking situation can increase. In addition, other driving safety systems are switched off.</p> <ul style="list-style-type: none"> <li data-bbox="541 582 763 605">► Drive on carefully.</li> <li data-bbox="541 616 1373 639">► Have the brake system checked immediately at a qualified specialist workshop.</li> </ul> </div> <ul style="list-style-type: none"> <li data-bbox="528 668 744 691">► Drive on carefully.</li> <li data-bbox="528 702 1045 725">► Note the messages on the multifunction display.</li> <li data-bbox="528 736 929 759">► Visit a qualified specialist workshop.</li> </ul> |

| Warning/indicator lamp   | Possible causes/consequences and ► Solutions   |
|--|--|
|  <p>ESP® warning lamp flashes</p>   | <p>The yellow ESP® warning lamp flashes while the vehicle is in motion.</p> <p>* At least one wheel and tire assembly has reached its grip limit (→ page 186).</p> <ul style="list-style-type: none"> <li>► Adapt your driving style to suit the road and weather conditions.</li> </ul>   |
|  <p>ESP® warning lamp lights up</p> | <p>The yellow ESP® warning lamp is lit while the engine is running.</p> <p>*ESP® is malfunctioning<br/>Other driving systems and driving safety systems may also malfunction.</p> <div style="border: 1px solid black; padding: 5px; margin: 10px 0;"> <p><b>⚠ WARNING</b> Risk of skidding if ESP® is malfunctioning</p> <p>If ESP® is malfunctioning, ESP® cannot carry out vehicle stabilization. In addition, other driving safety systems are switched off.</p> <ul style="list-style-type: none"> <li>► Drive on carefully.</li> <li>► Have ESP® checked at a qualified specialist workshop.</li> </ul> </div> <ul style="list-style-type: none"> <li>► Drive on carefully.</li> <li>► Observe the messages on the multifunction display.</li> <li>► Visit a qualified specialist workshop.</li> </ul> |

| Warning/indicator lamp   | Possible causes/consequences and ► Solutions  |
|--|---|
|  <p data-bbox="195 344 439 370">ESP® OFF warning lamp</p> | <p data-bbox="504 251 1184 277">The yellow ESP® OFF warning lamp is lit while the engine is running.</p> <p data-bbox="515 285 735 311">*ESP® is deactivated.</p> <div data-bbox="532 332 1696 609" style="border: 1px solid gray; padding: 5px;"><p data-bbox="541 342 1227 368"><b>▲ WARNING</b> Risk of skidding when driving with ESP® deactivated</p><p data-bbox="541 384 1652 436">If ESP® is deactivated, ESP® cannot carry out vehicle stabilization. The availability of further driving safety systems is also limited.</p><ul data-bbox="541 446 1166 508" style="list-style-type: none"><li data-bbox="541 446 765 472">▶ Drive on carefully.</li><li data-bbox="541 482 1166 508">▶ Only deactivate ESP® for as long as the situation requires.</li></ul><p data-bbox="541 534 1073 560">If ESP® cannot be activated, ESP® is malfunctioning.</p><ul data-bbox="541 570 1258 596" style="list-style-type: none"><li data-bbox="541 570 1258 596">▶ Have ESP® checked immediately at a qualified specialist workshop.</li></ul></div> <p data-bbox="528 627 1123 653">► Observe the notes on deactivating ESP® (→ page 186).</p> |

## Tire pressure monitor

| Warning/indicator lamp  | Possible causes/consequences and ► Solutions  |
|---|---|
|  <p data-bbox="144 384 395 456">Tire pressure monitoring system warning lamp flashes</p>   | <p data-bbox="454 291 1615 337">The yellow tire pressure monitoring system warning lamp (pressure loss/malfunction) flashes for approximately one minute and then remains lit.</p> <p data-bbox="467 350 966 373">*The tire pressure monitoring system is defective.</p> <div data-bbox="482 394 1646 570" style="border: 1px solid gray; padding: 5px;"> <p data-bbox="491 401 1502 425"><b>▲ WARNING</b> There is a risk of an accident if the tire pressure monitoring system is malfunctioning</p> <p data-bbox="491 441 1615 487">If the tire pressure monitoring system is malfunctioning, it is not able to issue a warning if there is pressure loss in one or more of the tires.</p> <p data-bbox="491 503 1424 527">Underinflated tires may, for example, impair the driving, steering and braking characteristics.</p> <p data-bbox="491 539 1378 563">► Have the tire pressure monitoring system checked at a qualified specialist workshop.</p> </div> <p data-bbox="476 589 879 613">► Visit a qualified specialist workshop.</p> |
|  <p data-bbox="144 726 421 798">Tire pressure monitoring system warning lamp lights up</p> | <p data-bbox="454 632 1363 656">The yellow tire pressure monitoring system warning lamp (pressure loss/malfunction) is lit.</p> <p data-bbox="467 669 1424 693">*The tire pressure monitoring system has detected tire pressure loss in at least one of the tires.</p> <div data-bbox="482 713 1646 850" style="border: 1px solid gray; padding: 5px;"> <p data-bbox="491 721 1166 744"><b>▲ WARNING</b> Risk of an accident due to insufficient tire pressure</p> <p data-bbox="491 760 1082 784">Tire pressures that are too low pose the following hazards:</p> <ul data-bbox="504 796 1402 850" style="list-style-type: none"> <li data-bbox="504 796 1234 820">• The tires may burst, especially as the load and vehicle speed increase.</li> <li data-bbox="504 832 1402 850">• The tires may wear excessively and/or unevenly, which may greatly impair tire traction.</li> </ul> </div>   |



| Warning/indicator lamp | Possible causes/consequences and ► Solutions  |
|------------------------|---|
|                        | <ul style="list-style-type: none"><li>• The driving characteristics, as well as steering and braking, may be greatly impaired.<br/>You could then lose control of the vehicle.</li><li>► Observe the recommended tire pressure.</li><li>► Adjust the tire pressure if necessary.</li></ul><br><ul style="list-style-type: none"><li>► Stop the vehicle, paying attention to road and traffic conditions.</li><li>► Check the tire pressure and the tires.</li></ul> |

**1, 2, 3 ...**

|   |     |
|---|-----|
| <b>4MATIC</b> .....                               | 172 |
| Function .....                                    | 172 |
| <b>12 V battery</b>                               |     |
| see Battery (vehicle)                             |     |
| <b>115 V socket</b>                               |     |
| see Socket (115 V)                                |     |
| <b>360° Camera</b> .....                          | 228 |
| Function .....                                    | 228 |
| Opening the camera cover (rear view camera) ..... | 232 |
| Selecting a view .....                            | 232 |

**A****A/C function**

|   |     |
|---|-----|
| Activating/deactivating (multimedia system) ..... | 147 |
| Switching on/off (control panel) .....            | 146 |
| <b>ABS (Anti-lock Braking System)</b> .....       | 185 |

**Acceleration**

  see Kickdown

**Accident and breakdown management**

|                           |     |
|---------------------------|-----|
| Mercedes me connect ..... | 389 |
|---------------------------|-----|

**Acoustic locking verification signal**

|                               |    |
|-------------------------------|----|
| Activating/deactivating ..... | 66 |
|-------------------------------|----|

**Activating/deactivating automatic volume adjustment**

|                                      |     |
|--------------------------------------|-----|
| Advanced sound system .....          | 418 |
| Burmester® surround sound system ... | 417 |

**Active Blind Spot Assist**

|                               |     |
|-------------------------------|-----|
| Activating/deactivating ..... | 242 |
| Brake application .....       | 244 |
| Function .....                | 242 |
| System limitations .....      | 242 |
| Trailer operation .....       | 244 |

**Active Brake Assist**

|                      |     |
|----------------------|-----|
| Function/notes ..... | 191 |
| Setting .....        | 197 |

**Active Distance Assist DISTRONIC**

|  |     |
|--|-----|
| Active Emergency Stop Assist .....       | 210 |
| Active Lane Change Assist .....          | 209 |
| Calling up a speed .....                 | 203 |
| Displays in the Instrument Display ..... | 211 |
| Function .....                           | 201 |

|                                    |     |
|------------------------------------|-----|
| Increasing/decreasing speed .....  | 203 |
| Requirements .....                 | 203 |
| Route-based speed adaptation ..... | 205 |
| Steering wheel buttons .....       | 203 |
| Storing a speed .....              | 203 |
| Switching off/deactivating .....   | 203 |
| Switching on/activating .....      | 203 |
| System limitations .....           | 201 |

**Active Emergency Stop Assist**

210

**Active Lane Change Assist**

209

|                               |     |
|-------------------------------|-----|
| Activating/deactivating ..... | 210 |
| Function .....                | 209 |

**Active Lane Keeping Assist**

245

|   |     |
|---|-----|
| Activating/deactivating .....           | 247 |
| Activating/deactivating the warning ... | 247 |
| Function .....                          | 245 |
| Setting the sensitivity .....           | 247 |
| System limits .....                     | 245 |
| Trailer operation .....                 | 245 |

**Active Parking Assist**

232

|                               |     |
|-------------------------------|-----|
| Cross Traffic Alert .....     | 237 |
| Drive Away Assist .....       | 237 |
| Exiting a parking space ..... | 235 |
| Function .....                | 232 |

- Maneuvering assistance ..... 238
- Parking ..... 234
- System limitations ..... 232
- Active Service System PLUS**  
see ASSYST PLUS
- Active Speed Limit Assist** ..... 204
  - Display ..... 204
  - Function ..... 204
- Active Steering Assist** ..... 207
  - Activating/deactivating ..... 209
  - Active Emergency Stop Assist ..... 210
  - Active Lane Change Assist ..... 209
  - Displays in the Instrument Display ..... 211
  - Function ..... 207
  - System limitations ..... 207
- Adaptive cruise control**  
see Active Distance Assist DISTRONIC
- Adaptive Highbeam Assist**
  - Function ..... 133
  - Switching on/off ..... 134
- Additional value range**
  - Setting display content ..... 255
- Additives** ..... 497
  - Engine oil ..... 497
  - Fuel ..... 497
- Additives (engine oil)**  
see Additives
- Additives (fuel)**  
see Fuel
- Address book**  
see Contacts
- Adjusting the balance/fader**
  - Advanced sound system ..... 419
  - Burmester® surround sound system .... 417
- Adjusting the bass, mid-range and treble**
  - Burmester® surround sound system .... 417
- Adjusting the mid-range, treble and bass**
  - Burmester® surround sound system .... 417
- Adjusting the sound focus**
  - Burmester® surround sound system .... 418
- Adjusting treble, mid-range and bass settings**
  - Advanced sound system ..... 418
  - Burmester® surround sound system .... 417
- ADS PLUS damping system**  
see AIR BODY CONTROL
- Advanced sound system**
  - Activating/deactivating automatic volume adjustment ..... 418
  - Adjusting the balance/fader ..... 419
  - Adjusting treble, mid-range and bass settings ..... 418
  - Calling up the sound menu ..... 418
  - Information ..... 418
- After-sales service center**  
see ASSYST PLUS
- Air bag**
  - Reduced protection ..... 42
- AIR BODY CONTROL** ..... 214
  - Setting ..... 216
  - Suspension ..... 214
- Air conditioning menu**
  - Calling up ..... 146
- Air conditioning system**  
see Climate control

- Air distribution**  
Setting ..... 145  
Setting (multimedia system) ..... 147
- Air freshener system**  
see Perfume atomizer
- Air inlet**  
see Air-water duct
- Air pressure**  
see Tire pressure
- Air suspension**  
see AIR BODY CONTROL
- Air vents** ..... 150  
Adjusting (front) ..... 150  
Adjusting (rear) ..... 151
- Air vents**  
see Air vents
- Air-recirculation mode** ..... 148
- Air-water duct** ..... 428  
Keeping free ..... 428
- Airbag** ..... 40  
Activation ..... 34  
Front airbag (driver, front passenger) .... 40  
Installation locations ..... 40  
Knee airbag ..... 40  
Overview ..... 40  
PASSENGER AIR BAG indicator lamp .... 45  
Protection ..... 41  
Side airbag ..... 40  
Window curtain airbag ..... 40
- Airflow**  
Setting ..... 145
- Alarm**  
see Panic alarm
- Alarm system**  
see ATA (anti-theft alarm system)
- All-wheel drive**  
see 4MATIC
- Alternative route**  
see Route
- Ambient lighting**  
Setting (multimedia system) ..... 135
- Android Auto** ..... 384  
Connecting a mobile phone ..... 385  
Control using the application buttons  
..... 386  
Ending ..... 386
- Information ..... 385  
Overview ..... 384  
Sound settings ..... 386  
Transferred vehicle data ..... 386
- Animals**  
Pets in the vehicle ..... 64
- Anti-lock braking system**  
see ABS (Anti-lock Braking System)
- Anti-skid chains**  
see Snow chains
- Anti-theft alarm system**  
see ATA (anti-theft alarm system)
- Anti-theft protection**  
Immobilizer ..... 90
- Anticipatory occupant protection**  
see PRE-SAFE® (anticipatory occupant protection)  
see PRE-SAFE® PLUS (anticipatory occupant protection plus)
- Apple CarPlay®** ..... 382  
Connecting an iPhone® ..... 383  
Control using the application buttons  
..... 384

- Ending ..... 384
- Notes ..... 383
- Overview ..... 382
- Sound settings ..... 384
- Transferred vehicle data ..... 386
- Ashtray**
  - Front center console ..... 123
  - Using ..... 123
- Assistance**
  - Menu (on-board computer) ..... 257
- Assistance systems**
  - see Driving safety system
- ASSYST PLUS** ..... 420
  - Battery disconnection periods ..... 421
  - Displaying the service due date ..... 420
  - Function/notes ..... 420
  - Regular maintenance work ..... 420
  - Special service requirements ..... 420
- ATA (anti-theft alarm system)** ..... 91
  - Activating/deactivating the interior motion sensor ..... 93
  - Arming/disarming the tow-away alarm ..... 92
  - Deactivating the alarm ..... 91
  - Function ..... 91
  - Function of the interior motion sensor .. 92
  - The tow-away alarm function ..... 92
- ATTENTION ASSIST** ..... 238, 240
  - Function ..... 238
  - Setting ..... 240
  - System limitations ..... 238
- Attention assistant**
  - see ATTENTION ASSIST
- Authorized Mercedes-Benz Center**
  - see Qualified specialist workshop
- Authorized workshop**
  - see Qualified specialist workshop
- Automatic distance control**
  - see Active Distance Assist DISTRONIC
- Automatic driving lights** ..... 131
- Automatic engine start (ECO start/stop function)** ..... 162
- Automatic engine stop (ECO start/stop function)** ..... 162
- Automatic front passenger front air-bag shutoff** ..... 43, 45
  - Function of the automatic front passenger front airbag shutoff ..... 43
  - PASSENGER AIR BAG indicator lamp .... 45
- Automatic front passenger front air-bag shutoff**
  - see Automatic front passenger front airbag shutoff
- Automatic mirror folding function**
  - Activating/deactivating ..... 143
- Automatic seat adjustment**
  - Setting ..... 100
- Automatic transmission**
  - DIRECT SELECT lever ..... 167
  - Drive program display ..... 166
  - Drive programs ..... 165
  - DYNAMIC SELECT switch ..... 165
  - Engaging drive position ..... 169
  - Engaging neutral ..... 168
  - Engaging park position ..... 169
  - Engaging reverse gear ..... 168
  - Kickdown ..... 171
  - Manual gearshifting ..... 169

- Steering wheel paddle shifters ..... 169
- Transmission position display ..... 167
- Transmission positions ..... 167
- Axle load**
- Towing a trailer ..... 504
- B**
- Bag hook** ..... 115
- Ball neck**
- Installing ..... 249
- BAS (Brake Assist System)** ..... 186
- Battery**
- Charging (Remote Online) ..... 154
- SmartKey ..... 67
- Battery**
- see Battery (vehicle)
- Battery (vehicle)** ..... 448
- Charging ..... 447
- Charging (Remote Online) ..... 154
- Notes ..... 443
- Notes (starting assistance and charging) ..... 445
- Replacing ..... 448
- Starting assistance ..... 447
- Belt**
- see Seat belt
- Blind Spot Assist** ..... 242
- Activating/deactivating ..... 245
- Function ..... 242
- System limitations ..... 242
- Blower**
- see Climate control
- Bluetooth®** ..... 319
- Activating/deactivating ..... 319
- Information ..... 319
- Brake Assist System**
- see BAS (Brake Assist System)
- Brake fluid**
- Notes ..... 498
- Brake force distribution**
- EBD (electronic brake force distribution) ..... 191
- Brakes**
- ABS (Anti-lock Braking System) ..... 185
- Active Brake Assist ..... 191
- BAS (Brake Assist System) ..... 186
- Driving tips ..... 157
- EBD (electronic brake force distribution) ..... 191
- HOLD function ..... 213
- Limited braking effect (salt-treated roads) ..... 157
- New/replaced brakepads/brake discs ..... 155
- Notes on breaking-in a new vehicle ..... 155
- Braking assistance**
- see BAS (Brake Assist System)
- Breakdown**
- Changing a wheel ..... 483
- Overview of the help functions ..... 18
- Roadside Assistance ..... 23
- Tow-starting ..... 454
- Towing away ..... 450
- Transporting the vehicle ..... 452
- Breakdown**
- see Flat tire
- Burmester® surround sound system** ..... 417
- Adjusting the balance/fader ..... 417
- Adjusting the sound focus ..... 418



















- Adjusting treble, mid-range and bass settings ..... 417
- Automatic volume adjustment ..... 417
- Calls up the sound menu ..... 417
- Information ..... 417
- Selecting the sound profile ..... 418
- Buttons**
  - Steering wheel ..... 253
- C**
- Call list**
  - Deleting ..... 378
  - Making a call ..... 377
  - Overview ..... 377
  - Selecting options ..... 377
  - Selecting options for suggestions ..... 378
- Calling up the sound menu**
  - Advanced sound system ..... 418
- Calls** ..... 372
  - Accepting ..... 372
  - Activating functions during a call ..... 373
  - Calls with several participants ..... 373
  - Declining ..... 372
  - Ending a call ..... 372
- Incoming call during an existing call .... 373
- Making ..... 372
- Mercedes me ..... 387
- Calls up the sound menu**
  - Burmester® surround sound system .... 417
- Camera**
  - see 360° Camera
  - see Rear view camera
- Car key**
  - see SmartKey
- Car wash**
  - see Care
- Car wash (care)** ..... 428
- Car-to-X-Communication**
  - Displaying hazard warnings ..... 354
  - Overview ..... 354
  - Sending hazard warnings ..... 355
- Care** ..... 435
  - Air-water duct ..... 428
  - Automatic car wash ..... 428
  - Carpet ..... 435
  - Decorative foil ..... 431
  - Display ..... 435
- Exterior lighting ..... 433
- Headliner ..... 435
- Matte finish ..... 430
- Paintwork ..... 430
- Plastic trim ..... 435
- Power washer ..... 428
- Real wood/trim elements ..... 435
- Rear view camera ..... 433
- Seat belt ..... 435
- Seat cover ..... 435
- Sensors ..... 433
- Tailpipes ..... 433
- Trailer hitch ..... 433
- Washing by hand ..... 429
- Wheels/rims ..... 433
- Windows ..... 433
- Wiper blades ..... 433
- Cargo compartment cover**
  - Extending/retracting ..... 112
  - Removing/installing ..... 113
- Cargo compartment floor**
  - Locking/unlocking ..... 120
  - Opening/closing ..... 119
- Cargo tie-down rings** ..... 115









































- Carpet (Care)** ..... 435
- Change of address** ..... 23
- Change of ownership** ..... 23
- Changing a wheel**
- Preparation ..... 483
  - Raising the vehicle ..... 484
- Changing a wheel**
- see Emergency spare wheel
- Changing gears** ..... 169
- Manually ..... 169
- Changing hub caps** ..... 483
- Character entry**
- On the touchpad ..... 311
- Charging**
- Battery (vehicle) ..... 447
  - USB port ..... 127
- Chassis level (AIR BODY CONTROL)**
- Setting ..... 216
- Child safety lock**
- Rear door ..... 62
  - Rear side windows ..... 63
- Child seat**
- Attaching (notes) ..... 54
  - Basic instructions ..... 49
  - Front-passenger seat (notes) ..... 60
  - LATCH-type (ISOFIX) (installing) ..... 56
  - Notes on risks and dangers ..... 50
  - Securing on the front passenger seat .... 61
  - Securing on the rear seat ..... 59
  - Top Tether ..... 58
- Children**
- Avoiding dangers in the vehicle ..... 50
  - Basic instructions ..... 49
  - Special seat belt retractor ..... 55
- Chock** ..... 482
- Storage location ..... 482
- Chock**
- see Chock
- Cigarette lighter**
- Front center console ..... 124
  - Rear passenger compartment ..... 124
- Cleaning**
- see Care
- Climate control** ..... 145
- Activating/deactivating ..... 146
  - Activating/deactivating the A/C function (control panel) ..... 146
  - Activating/deactivating the A/C function (multimedia system) ..... 147
  - Activating/deactivating the synchronization function (control panel) ..... 148
  - Activating/deactivating the synchronization function (multimedia system) ..... 148
  - Air distribution settings ..... 147
  - Air-recirculation mode ..... 148
  - Automatic control ..... 147
  - Calling up the air conditioning menu ... 146
  - Climate style function ..... 147
  - Control panel for 3-zone automatic climate control ..... 145
  - Control panel for dual-zone automatic climate control ..... 145
  - Defrosting the windshield ..... 145
  - Filling capacity for PAG oil ..... 501
  - Front air vents ..... 150
  - Inserting/removing the flaçon (fragrance system) ..... 149
  - Ionization ..... 149
  - Note ..... 145
  - Rear air vents ..... 151



- Rear operating unit ..... 145
- Refrigerant ..... 500
- Refrigerant filling capacity ..... 501
- Removing condensation from the windows ..... 148
- Residual heat ..... 148
- Setting (multimedia system) ..... 146
- Setting the air distribution ..... 145
- Setting the airflow ..... 145
- Setting the climate style ..... 147
- Setting the fragrance system ..... 149
- Setting the temperature ..... 145
- Switching the rear window defroster on/off ..... 145
- Ventilating the vehicle (convenience opening) ..... 81
- Climate style**
  - Function ..... 147
  - Setting ..... 147
- Coat hook** ..... 116
- Coat hook on the tailgate** ..... 116
- Cockpit** ..... 6
  - Overview ..... 6
- Coffee cup symbol**
  - see ATTENTION ASSIST
- Combination switch** ..... 131
- Compass** ..... 361
- Computer**
  - see On-board computer
- Connecting the parcel net** ..... 116
- Connection status**
  - Displaying ..... 395
  - Overview ..... 395
- Connectivity**
  - Switching transmission of the vehicle position on/off ..... 319
- Contacts** ..... 374
  - Calling up ..... 374
  - Deleting ..... 376
  - Deleting favorites ..... 377
  - Downloading (from mobile phone) ..... 374
  - Importing ..... 375
  - Importing (overview) ..... 375
  - Information ..... 374
  - Making a call ..... 375
  - Name format ..... 375
- Options ..... 376
- Saving as a favorite ..... 376
- Selecting options for suggestions ..... 376
- Storing ..... 375
- Convenience closing feature** ..... 81
- Convenience opening** ..... 81
- Coolant (engine)**
  - Check level ..... 426
  - Filling capacity ..... 500
  - Notes ..... 499
- Cooling**
  - see Climate control
- Copyrights**
  - License ..... 31
  - Trademarks ..... 32
- Cornering light function** ..... 133
- Cross Traffic Alert** ..... 237
- Crosswind Assist**
  - Function/notes ..... 190
- Cruise control** ..... 197
  - Buttons ..... 198
  - Calling up a speed ..... 198
  - Function ..... 197

- Requirements: ..... 198
- Selecting ..... 198
- Setting a speed ..... 198
- Storing a speed ..... 198
- Switching off ..... 198
- Switching on ..... 198
- System limitations ..... 197
- Cup holder**
  - Rear passenger compartment ..... 122
- Cup holder in the center console**
  - Installing/removing (automatic transmission) ..... 121
- Customer Assistance Center (CAC)** ..... 27
- Customer Relations Department** ..... 27
- D**
- Damage detection (parked vehicle)** ..... 182
- Dash cam**
  - Starting/ending a video recording ..... 364
- Dashboard**
  - see Cockpit
- Dashboard lighting**
  - see Instrument cluster lighting
- Dashcam**
  - Configuring the settings ..... 366
  - Deleting a video recording ..... 365
  - Notes ..... 364
  - Selecting a USB device ..... 364
- Data acquisition**
  - Vehicle ..... 28
- Data import/export** ..... 322
  - Function/notes ..... 322
  - Importing/exporting ..... 323
- Data storage**
  - Electronic control units ..... 28
  - Online services ..... 30
  - Vehicle ..... 28
- Date**
  - Setting the time and date automatically ..... 318
- Daytime running lamp mode**
  - see Daytime running lights
- Daytime running lights** ..... 134
  - Switching on/off ..... 134
- Deactivating the alarm (ATA)** ..... 91
- Dealership**
  - see Qualified specialist workshop
- Declaration of conformity**
  - Wireless vehicle components ..... 25
- Decorative foil (cleaning instructions)** .. 431
- Definitions (tires and loading)** ..... 476
- Designs**
  - Menu (on-board computer) ..... 255
- Destination** ..... 350
  - Editing intermediate destinations ..... 340
  - Editing the previous destinations ..... 350
  - External ..... 351
  - Quick-access to destination information ..... 347
  - Saving (current vehicle position) ..... 350
  - Saving as global favorite ..... 350
- Destination entry** ..... 328
  - Entering 3 word addresses ..... 333
  - Entering a POI or address ..... 328
  - Entering an intermediate destination .. 340
  - Entering geo-coordinates ..... 333
  - Notes ..... 328
  - Selecting a contact ..... 333
  - Selecting a POI ..... 331

- Selecting a received destination ..... 335
- Selecting from favorites ..... 334
- Selecting from the map ..... 334
- Selecting previous destinations ..... 331
- Detecting inattentiveness**  
see ATTENTION ASSIST
- Diagnostics connection** ..... 26
- Digital Operator's Manual** ..... 20
- Digital speedometer** ..... 258
- Dinghy towing**  
see Tow-bar system
- DIRECT SELECT lever** ..... 167
  - Engaging drive position ..... 169
  - Engaging neutral ..... 168
  - Engaging park position ..... 169
  - Engaging park position automatically .. 169
  - Engaging reverse gear ..... 168
  - Function ..... 167
- Display**  
Care ..... 435
- Display (multimedia system)** ..... 288
  - Home screen ..... 286
  - Operating ..... 288
- Setting acoustic operating feedback ... 289
- Settings ..... 317
- Display (on-board computer)**  
Displays on the multifunction display .. 256
- Display content**  
Setting the additional value range ..... 255
- Display message** ..... 505
  - Calling up (on-board computer) ..... 505
  - Notes ..... 505
- Display messages**
  -  --- mph ..... 537
  -  --- mph ..... 535
  -  12 V Battery See Operator's Manual ..... 544
  -  Active Headlamps Inoperative .... 512
  -  ATTENTION ASSIST Inoperative ..... 528
  -  ATTENTION ASSIST: Take a Break! ..... 528
  -  Automatic Headlamp Mode Inoperative ..... 512
-  Check Brake Fluid Level ..... 526
-  Check Brake Pads See Operator's Manual ..... 527
-  Check Coolant Level See Operator's Manual ..... 517
-  Check Engine Oil At Next Refueling ..... 551
-  Check Engine Oil Level (Add 1 quart) ..... 551
-  Check Left Low Beam (example) ..... 511
-  Check Tires ..... 547
-  Check Washer Fluid ..... 517
-  Coolant Too Hot Stop Vehicle Turn Engine Off ..... 518
-  Currently Unavailable See Operator's Manual ..... 538
-  Currently Unavailable See Operator's Manual ..... 540
-  Don't Forget Your Key ..... 511

-  Engine Oil Level Cannot Be Measured ..... 553
-  Engine Oil Level Low Stop Vehicle Turn Engine Off ..... 552
-  Engine Oil Pressure Stop Switch Off Engine ..... 553
-  Engine Oil Reduce Oil Level ..... 552
-  Front Left Malfunction Service Required (example) ..... 506
-  Fuel Level Low ..... 519
-  Gas Cap Loose ..... 519
-  Inoperative See Operator's Manual ..... 539
-  Inoperative See Operator's Manual ..... 540
-  EBD Inoperative See Operator's Manual ..... 541
-  Inoperative ..... 543
-  Inoperative ..... 537
-  Intell. Light System Inoperative ... 513
-  Key Not Detected (red display message) ..... 510
-  Key Not Detected (white display message) ..... 510
-  Left Side Curtain Airbag Malfunction Service Required (example) ... 507
-  Lowering ..... 529
-  Malfunction Drive at Max. 50 mph ..... 529
-  Malfunction See Operator's Manual ..... 512
-  Max. Speed 12 mph ..... 530
-  Max. Speed 25 mph ..... 537
-  Not in Curr. Drive Prog. .... 537
-  Obtain a New Key ..... 509
-  Off ..... 536
-  HOLD Off ..... 535
-  PARK Parking Brake See Operator's Manual ..... 522
-  Please Correct Tire Pressure ..... 548
-  PARK Please Release Parking Brake .... 525
-  Rear Left Backrest Not Latched (example) ..... 517
-  Replace Key Battery ..... 510
-  See Operator's Manual ..... 544
-  SRS Malfunction Service Required ..... 506
-  Steering Malfunction Increased Physical Effort See Operator's Manual ..... 515
-  Steering Malfunction Stop Immediately See Operator's Manual .... 515
-  Stop Vehicle Leave Engine Running ..... 545
-  Stop Vehicle See Operator's Manual ..... 545
-  Stop Vehicle Vehicle Too Low .... 530
-  Suspended ..... 536
-  Switch Off Lights ..... 513
-  Switch On Headlamps ..... 512

-  Turn On the Ignition to Release the Parking Brake ..... 526
-  Vehicle Ready to Drive Switch the Ignition Off Before Exiting ..... 514
-  Vehicle Rising Please Wait ..... 531
-  Vehicle Rising ..... 529
-  Warning Tire Malfunction ..... 548
-  Wheel Sensor(s) Missing ..... 547
- Active Blind Spot Assist Currently Unavailable See Operator's Manual ..... 533
- Active Blind Spot Assist Inoperative .... 534
- Active Blind Spot Asst. Not Available When Towing a Trailer See Operator's Manual ..... 534
- Active Brake Assist Functions Currently Limited See Operator's Manual ..... 542
- Active Brake Assist Functions Limited See Operator's Manual ..... 542
- Active Distance Assist Currently Unavailable See Operator's Manual ..... 536
- Active Distance Assist Inoperative ..... 536
- Active Distance Assist Now Available ..... 536
- Active Lane Keeping Assist Currently Unavailable See Operator's Manual ..... 532
- Active Lane Keeping Assist Inoperative ..... 533
- Active Parking Assist and PARKTRONIC Inoperative See Operator's Manual ..... 528
- Active Steering Assist Currently Unavailable Due to Multiple Emergency Stops ..... 532
- Active Steering Assist Currently Unavailable See Operator's Manual ..... 531
- Active Steering Assist Inoperative ..... 531
- Adaptive Highbeam Assist Camera View Restricted See Operator's Manual ..... 513
- Adaptive Highbeam Assist Currently Unavailable See Operator's Manual ..... 513
- Adaptive Highbeam Assist Inoperative ..... 513
- Apply Brake to Shift from 'P' ..... 519
- Apply Brake to Shift to 'R' ..... 520
- Auxiliary Battery Malfunction ..... 522
- Beginning Emergency Stop ..... 531
- Blind Spot Assist Currently Unavailable See Operator's Manual ..... 533
- Blind Spot Assist Inoperative ..... 533
- Blind Spot Assist Not Available When Towing a Trailer See Operator's Manual ..... 533
- Check Tire Pressure Soon ..... 549
- Check Tire Pressure Then Restart Run Flat Indicator ..... 550

- Cruise Control Inoperative ..... 537
- Cruise Control Off ..... 538
- Decrease Speed ..... 549
- Drive More Slowly ..... 529
- Driver's Door Open & Transmission  
Not in P Risk of Vehicle Rolling Away .. 520
- Front Passenger Airbag Disabled See  
Operator's Manual ..... 507
- Front Passenger Airbag Enabled See  
Operator's Manual ..... 508
- Hazard Warning Flashers Malfunc-  
tioning ..... 514
- Mercedes me connect Services Limi-  
ted See Operator's Manual ..... 543
- N Permanently Active Risk of Rolling  
Away ..... 520
- Only Shift to 'P' when Vehicle is Sta-  
tionary ..... 520
- Place the Key in the Marked Space  
See Operator's Manual ..... 511
- PRE-SAFE Inoperative See Opera-  
tor's Manual ..... 509
- Radar Sensors Dirty See Operator's  
Manual ..... 542
- Reversing Not Possible Service  
Required ..... 521
- Run Flat Indicator Inoperative ..... 550
- Service Required Do Not Shift Gears  
Visit Dealer ..... 521
- Stop Vehicle Leave Engine Running  
Wait Transmission Cooling ..... 521
- Tire Press. Monitor Currently  
Unavailable ..... 546
- Tire Press. Monitor Inoperative ..... 546
- Tire Pressure Monitor Inoperative No  
Wheel Sensors ..... 546
- Tires Overheated ..... 549
- To Deselect P or N, Depress Brake  
and Start Engine ..... 520
- To switch engine off, press and hold  
Start/Stop button for at least 3  
secs. or press 3 times. .... 519
- Traffic Sign Assist Camera View  
Restricted See Operator's Manual ..... 535
- Traffic Sign Assist Currently Unavail-  
able See Operator's Manual ..... 534
- Traffic Sign Assist Inoperative ..... 534
- Transmission Malfunction Stop ..... 521
- Display on the windshield**  
see Head-up Display
- Distance control**  
see Active Distance Assist DISTRONIC
- Distance recorder**  
see Trip distance
- DISTRONIC**  
see Active Distance Assist DISTRONIC
- Door**  
Child safety lock (rear door) ..... 62  
Locking (emergency key) ..... 73  
Opening (from the inside) ..... 70  
Unlocking (emergency key) ..... 73

- Unlocking (from the inside) ..... 70
- Door control panel** ..... 16
- DOT, Tire Identification Number (TIN)** ... 472
- Downhill driving assistance**  
see DSR
- Drawbar**  
see Tow-bar system
- Drinking and driving** ..... 157
- Drive Away Assist** ..... 237
- Drive position**  
Inserting ..... 169
- Drive program display** ..... 166
- Drive programs**  
see DYNAMIC SELECT
- Driver's seat**  
see Seat
- Driving lights**  
see Automatic driving lights
- Driving safety system** ..... 184  
ABS (Anti-lock Braking System) ..... 185  
Active Brake Assist ..... 191  
BAS (Brake Assist System) ..... 186
- EBD (electronic brake force distribution) ..... 191
- ESP® Crosswind Assist ..... 190
- ESP® trailer stabilization ..... 191
- Off-road ABS ..... 185
- Off-road ESP® ..... 189
- Overview ..... 184
- Radar and ultrasonic sensors ..... 184
- Responsibility ..... 184
- STEER CONTROL ..... 191
- Driving system**  
see 360° Camera  
see Active Blind Spot Assist  
see Active Distance Assist DISTRONIC  
see Active Emergency Stop Assist  
see Active Lane Change Assist  
see Active Lane Keeping Assist  
see Active Parking Assist  
see Active Speed Limit Assist  
see Active Steering Assist  
see AIR BODY CONTROL  
see ATTENTION ASSIST  
see Blind Spot Assist  
see Cruise control  
see Driving safety system
- see DSR  
see HOLD function  
see Parking Assist PARKTRONIC  
see Rear view camera  
see Traffic Sign Assist
- Driving tips**  
Drinking and driving ..... 157  
General driving tips ..... 157  
Notes on breaking-in a new vehicle ..... 155
- Drowsiness detection**  
see ATTENTION ASSIST
- DSR** ..... 199  
Activating/deactivating ..... 200  
Changing the target speed ..... 200  
Function ..... 199  
Notes ..... 200
- Dynamic handling control system**  
see ESP® (Electronic Stability Program)
- DYNAMIC SELECT** ..... 165  
Configuring drive program I ..... 166  
Displaying engine data ..... 167  
Displaying vehicle data ..... 167  
Drive program display ..... 166  
Drive programs ..... 165

- Function ..... 165  
 Operating (DYNAMIC SELECT switch) ..... 166  
 Selecting the drive program ..... 166
- E**
- Easy entry feature**  
 Function/notes ..... 104
- Easy exit feature**  
 Function/notes ..... 104
- EASY-PACK load-securing kit** ..... 118  
 Installing/removing the telescopic rod ..... 118  
 Notes ..... 118
- EBD (electronic brake force distribution)**  
 Function/notes ..... 191
- ECO display**  
 Function ..... 165  
 Resetting ..... 259
- ECO start/stop function** ..... 162  
 Automatic engine start ..... 162  
 Automatic engine stop ..... 162  
 Method of operation ..... 162
- Switching off/on ..... 164
- Electric parking brake** ..... 180  
 Applying automatically ..... 180  
 Applying or releasing manually ..... 182  
 Emergency braking ..... 182  
 Releasing automatically ..... 181
- Electronic Stability Program**  
 see ESP® (Electronic Stability Program)
- Emergency**  
 Overview of the help functions ..... 18  
 Reflective safety vest ..... 437
- Emergency braking** ..... 182
- Emergency braking**  
 see BAS (Brake Assist System)
- Emergency call system**  
 see Mercedes-Benz emergency call system
- Emergency engine start** ..... 454
- Emergency key**  
 Locking a door ..... 73  
 Unlocking a door ..... 73
- Emergency operation mode**  
 Starting the vehicle ..... 153
- Emergency spare wheel** ..... 488  
 Inflating ..... 489  
 Notes ..... 488  
 Removing ..... 489
- Emergency Tensioning Devices**  
 Activation ..... 34
- Engine**  
 ECO start/stop function ..... 162  
 Engine number ..... 494  
 Starting (emergency operation mode) ..... 153  
 Starting (Remote Online) ..... 155  
 Starting (start/stop button) ..... 153  
 Starting assistance ..... 447  
 Switching off (start/stop button) ..... 174
- Engine data**  
 Displaying ..... 167
- Engine number** ..... 494
- Engine oil** ..... 424  
 Additives ..... 497  
 Capacity ..... 498  
 Checking the oil level using the oil dipstick ..... 423



- Checking the oil level using the on-board computer ..... 424
  - MB-Freigabe or MB-Approval ..... 498
  - Quality ..... 498
  - Topping up ..... 424
  - Entering characters** ..... 310
    - Function/notes ..... 310
    - On the touchscreen (media display) ..... 314
    - Setting the keyboard ..... 317
  - ESC (Electronic Stability Control)**
    - see ESP® (Electronic Stability Program)
  - ESP®**
    - Crosswind Assist ..... 190
    - Off-road ..... 189
    - Trailer stabilization ..... 191
  - ESP® (Electronic Stability Program)** ..... 186
    - Activating/deactivating ..... 190
    - Function/notes ..... 186
  - Exterior lighting**
    - Care ..... 433
  - Exterior lighting**
    - see Lights
  - Exterior mirrors** ..... 140, 141
    - Anti-glare mode (automatic) ..... 141
    - Automatic mirror folding function ..... 143
    - Folding in/out ..... 140
    - Operating the memory function ..... 105
    - Parking position ..... 142
    - Setting ..... 140
  - Eyeglasses compartment** ..... 108
- F**
- Fatigue detection**
    - see ATTENTION ASSIST
  - Favorites**
    - Adding ..... 304
    - Adding a destination ..... 334
    - Calling up ..... 304
    - Deleting ..... 305
    - Home address ..... 334
    - Moving ..... 305
    - Overview ..... 304
    - Renaming ..... 305
    - Work address ..... 334
  - Flacon**
    - Inserting/removing ..... 149
  - Flat tire** ..... 437
    - Changing a wheel ..... 483
    - MOExtended tires ..... 438
    - Notes ..... 437
    - TIREFIT kit ..... 439
  - Flat towing**
    - see Tow-bar system
  - Floor mats** ..... 129
  - Foil covering**
    - Radar and ultrasonic sensors ..... 184
  - Fragrance**
    - see Perfume atomizer
  - Free software** ..... 31
  - Frequencies**
    - Two-way radio ..... 493
  - Frequency band**
    - Dialing (on-board computer) ..... 261
  - Front airbag (driver, front passenger)** ..... 40
  - Front passenger seat**
    - see Seat
  - Fuel** ..... 497
    - Additives ..... 497

- Fuel reserve ..... 497
- Refueling ..... 172
- Tank content ..... 497
- Fuel consumption**
- On-board computer ..... 258
- Fuel consumption indicator**
- Calling up ..... 167
- Function seat**
- see Door control panel
- Fuses** ..... 454
- Before replacing a fuse ..... 454
- Dashboard fuse box ..... 456
- Fuse assignment diagram ..... 454
- Fuse box in the cargo compartment .... 457
- Fuse box in the engine compartment .. 455
- Fuse box in the front-passenger foot-  
  well ..... 456
- Notes ..... 454
- Fuses**
- see Fuses
- G**
- Garage door opener**
- Clearing the memory ..... 179
- Opening or closing the door ..... 178
- Programming buttons ..... 176
- Radio equipment approval numbers .... 179
- Resolving problems ..... 178
- Synchronizing the rolling code ..... 177
- Gas station search**
- Starting automatic search ..... 342
- Switching automatic search on/off ..... 342
- Gearshift recommendation** ..... 171
- Genuine parts** ..... 21
- Glide mode** ..... 171
- Global search**
- Function ..... 308
- Overview ..... 307
- Glove box**
- Locking/unlocking ..... 108
- H**
- Handbrake**
- see Electric parking brake
- Handling characteristics (unusual)** ..... 458
- HANDS-FREE ACCESS** ..... 77
- Hazard warning lights** ..... 132
- Hazardous substances**
- Information ..... 24
- Head restraint**
- Front (adjusting mechanically) ..... 98
- Rear (installing/removing) ..... 99
- Rear passenger compartment  
  (adjuncting) ..... 99
- Head-up Display** ..... 263
- Adjusting display elements (on-board  
  computer) ..... 263
- Adjusting the brightness (on-board  
  computer) ..... 263
- Function ..... 263
- Menu (on-board computer) ..... 263
- Setting the position (on-board com-  
  puter) ..... 263
- Switching on/off ..... 264
- Headliner (care)** ..... 435
- Heating**
- see Climate control
- High beam**
- Switching on/off ..... 131

- High-beam flasher** ..... 131
  - High-beam headlamps**
    - Adaptive Highbeam Assist ..... 133
  - Hill start assist** ..... 213
  - HOLD function** ..... 213
    - Function/notes ..... 213
    - Switching on/off ..... 213
  - Home screen (media display)**
    - Overview ..... 286
  - Hood**
    - Opening/closing ..... 421
  - Hotspot**
    - Setting up (Wi-Fi) ..... 321
- I**
- Identification plate**
    - Engine ..... 494
    - Refrigerant ..... 500
    - Vehicle ..... 494
  - Ignition**
    - Switching on (Start/Stop button) ..... 152
  - Ignition key**
    - see SmartKey
  - Immobilizer** ..... 90
  - Indicator lamps**
    - see Warning/indicator lamps
  - Individual drive program**
    - Configuring ..... 166
    - Selecting ..... 166
  - Inside rearview mirror**
    - see Exterior mirrors
  - Inspection**
    - see ASSYST PLUS
  - Instrument cluster**
    - see Instrument Display
  - Instrument cluster lighting** ..... 257
  - Instrument Display** ..... 252
    - Adjusting the lighting ..... 257
    - Function/notes ..... 252
    - Instrument cluster ..... 10, 12
    - Setting the additional value range ..... 255
    - Warning/indicator lamps ..... 553
  - Intelligent Light System**
    - Adaptive Highbeam Assist ..... 133
    - Cornering light function ..... 133
  - Interior lighting** ..... 135
    - Ambient lighting ..... 135
    - Reading light ..... 135
    - Setting ..... 135
    - Switch-off delay time ..... 136
  - Interior motion sensor**
    - Activating/deactivating ..... 93
    - Function ..... 92
  - Intermediate destination**
    - Calculating a route with intermediate destinations ..... 341
    - Entering ..... 340
    - Modifying ..... 340
    - Starting an automatic gas station search ..... 342
    - Starting the automatic service station search ..... 342
  - Internet**
    - Calling up a web page ..... 395
    - Closing the browser ..... 398
    - Deleting a bookmark ..... 398
    - Deleting history ..... 398
    - Managing bookmarks ..... 398

**Internet connection**

|  |     |
|--|-----|
| Communication module function .....    | 394 |
| Connection status .....                | 395 |
| Displaying the connection status ..... | 395 |
| Establishing .....                     | 395 |
| Information .....                      | 394 |
| Restrictions .....                     | 394 |

**Ionization**

|   |     |
|---|-----|
| Activating/deactivating (multimedia system) ..... | 149 |
|---|-----|

**iPhone®**

|                        |
|------------------------|
| see Apple CarPlay®     |
| see Mercedes-Benz Link |

**J****Jack**

|                        |     |
|------------------------|-----|
| Storage location ..... | 482 |
|------------------------|-----|

**Jump-start connection** ..... 447

|                     |     |
|---------------------|-----|
| General notes ..... | 445 |
|---------------------|-----|

**K****KEYLESS-GO**

|                           |    |
|---------------------------|----|
| Locking the vehicle ..... | 70 |
| Problem .....             | 72 |

|                             |    |
|-----------------------------|----|
| Unlocking setting .....     | 66 |
| Unlocking the vehicle ..... | 70 |

**Kickdown** ..... 171

|             |     |
|-------------|-----|
| Using ..... | 171 |
|-------------|-----|

**Knee airbag** ..... 40**L****Labeling (tires)**

|                   |
|-------------------|
| see Tire labeling |
|-------------------|

**Lamp**

|                       |
|-----------------------|
| see Interior lighting |
|-----------------------|

**Lamps (Instrument Display)**

|                             |
|-----------------------------|
| see Warning/indicator lamps |
|-----------------------------|

**Lane detection (automatic)**

|                                |
|--------------------------------|
| see Active Lane Keeping Assist |
|--------------------------------|

**Lane Keeping Assist**

|                                |
|--------------------------------|
| see Active Lane Keeping Assist |
|--------------------------------|

**Language** ..... 322

|               |     |
|---------------|-----|
| Notes .....   | 322 |
| Setting ..... | 322 |

**LATCH-type (ISOFIX) child seat securing system**

|                  |    |
|------------------|----|
| Installing ..... | 56 |
|------------------|----|

**Level control system**

|                      |
|----------------------|
| see AIR BODY CONTROL |
|----------------------|

**Light switch**

|                |     |
|----------------|-----|
| Overview ..... | 130 |
|----------------|-----|

**Lighting**

|                       |
|-----------------------|
| see Interior lighting |
| see Lights            |

**Lights** ..... 130

|   |     |
|---|-----|
| Adaptive Highbeam Assist .....                            | 133 |
| Adjusting the instrument lighting .....                   | 257 |
| Automatic driving lights .....                            | 131 |
| Combination switch .....                                  | 131 |
| Cornering light function .....                            | 133 |
| Hazard warning lights .....                               | 132 |
| High beam .....   | 131 |
| High-beam flasher .....                                   | 131 |
| Light switch .....  | 130 |
| Low-beam headlamps .....                                  | 130 |
| Parking lights .....                                      | 130 |
| Rear fog lamp .....                                       | 130 |
| Responsibility for lighting systems .....                 | 130 |
| Setting the exterior lighting switch-off delay time ..... | 134 |
| Standing lights .....                                     | 130 |

- Switching the surround lighting
    - on/off ..... 135
    - Turn signals ..... 131
  - Limited Warranty**
    - Vehicle ..... 28
  - Limiting the opening angle (tailgate)** ..... 79
  - Live Traffic Information**
    - Displaying the traffic map ..... 352
    - Displaying traffic incidents ..... 353
    - Provider information ..... 352
    - Showing local area messages ..... 354
    - Switching the traffic information display on ..... 353
  - Load index (tires)** ..... 474
  - Load-bearing capacity (tires)** ..... 474
  - Loading** ..... 115
    - Bag hook ..... 115
    - Cargo tie-down rings ..... 115
    - Coat hook ..... 116
    - Definitions ..... 476
    - Notes ..... 106
    - Roof carrier ..... 121
    - Stowage space underneath the cargo compartment floor ..... 119
  - Loading**
    - see EASY-PACK load-securing kit
  - Loading guidelines** ..... 106
  - Loading information table** ..... 467
  - Loads**
    - Securing ..... 106
  - Locking/unlocking**
    - Activating/deactivating the automatic locking feature ..... 72
    - Emergency key ..... 73
    - KEYLESS-GO ..... 70
    - Opening the tailgate ..... 74
    - Unlocking and opening doors from the inside ..... 70
  - Low-beam headlamps**
    - Switching on/off ..... 130
  - Lowering the vehicle**
    - Rear of the vehicle ..... 218
  - Lubricant additives**
    - see Additives
  - Luggage**
    - Parcel net ..... 116
    - Securing ..... 106
  - Lumbar support**
    - see Lumbar support (4-way)
  - Lumbar support (4-way)** ..... 97
- M**
- Maintenance**
    - Menu (on-board computer) ..... 257
    - Vehicle ..... 23
  - Maintenance**
    - see ASSYST PLUS
  - Malfunction**
    - Parking Assist PARKTRONIC ..... 221
    - Restraint system ..... 34
  - Malfunction message**
    - see Display message
  - Map** ..... 352, 355
    - Avoiding an area ..... 359
    - Avoiding an area (overview) ..... 359
    - Changing an area ..... 359
    - Deleting an area ..... 360
    - Displaying the compass ..... 361
    - Displaying the map version ..... 358
    - Displaying the next intersecting street ..... 358

- Displaying the range ..... 361
- Displaying the satellite map ..... 361
- Displaying the traffic map ..... 352
- Displaying weather information ..... 362
- Map data ..... 360
- Moving ..... 356
- Selecting POI symbols ..... 357
- Selecting text information ..... 358
- Selecting the map orientation ..... 356
- Setting the map scale ..... 355
- Setting the map scale automatically .... 361
- Showing in the multifunction display  
of the instrument cluster ..... 362
- Switching freeway information  
on/off ..... 358
- Updating ..... 360
- Message program**  
Resetting the settings ..... 101
- Message programs**  
Selecting the front seats ..... 101
- Message settings**  
Resetting ..... 101
- Matte finish (cleaning instructions)** ..... 430
- Maximum load rating** ..... 473
- Maximum permissible load**  
Calculation example ..... 469  
Determining ..... 468
- Maximum tire pressure** ..... 473
- MBUX Interior Assistant (multimedia system)** ..... 291  
Notes ..... 291  
Operating a function with the favorites pose ..... 294  
Operating functions through proximity of the hand ..... 293  
Overview ..... 291  
Selecting settings ..... 296  
Switching the reading light for the driver and front passenger on/off ..... 295  
Switching the search light for the driver on/off ..... 295
- Mechanical key**  
Inserting/removing ..... 67  
Unlocking the tailgate ..... 79
- Media**  
Menu (on-board computer) ..... 261
- Media display**  
Notes ..... 285
- Media mode**  
Adding a favorite song ..... 407  
Connecting Bluetooth® audio equipment ..... 405  
Connecting USB devices ..... 405  
Controlling media playback ..... 406  
Copyright and trademarks ..... 402  
Notes about the search function in categories ..... 407  
Overview of the media menu ..... 404  
Playing back similar music tracks ..... 407  
Removing a favorite song ..... 407  
Starting a search in categories ..... 407  
Starting media playback ..... 406  
Supported format and data storage media ..... 401  
Surprise mix ..... 407  
Using the keyword search ..... 408
- Media playback**  
Operating (on-board computer) ..... 261
- Media source**  
Selecting (on-board computer) ..... 261
- Memory function**  
Operating ..... 105

- Outside mirror – Calling up stored settings ..... 105
- Outside mirror – Storing settings ..... 105
- Seat – Calling up stored settings ..... 105
- Seat – Storing settings ..... 105
- Steering wheel – Calling up saved settings ..... 105
- Steering wheel – Saving settings ..... 105
- Menu (on-board computer)**
  - Assistance ..... 257
  - Designs ..... 255
  - Head-up Display ..... 263
  - Maintenance ..... 257
  - Media ..... 261
  - Navigation ..... 259
  - Overview ..... 253
  - Radio ..... 261
  - Telephone ..... 262
  - Trip ..... 258
- Mercedes me app**
  - Calling up services ..... 390
  - Calling up your user account ..... 390
  - Deleting the connection to the user account ..... 391
  - Information ..... 390
- Mercedes me calls**
  - Arranging a service appointment ..... 388
  - Calling the Mercedes-Benz Customer Center ..... 387
  - Information ..... 387
  - Making a call via the overhead control panel ..... 387
  - Transferred data ..... 388
- Mercedes me connect**
  - Accident and breakdown management ..... 389
  - Information ..... 389
  - Transferred data ..... 390
- Mercedes-AMG vehicles**
  - Notes ..... 152
- Mercedes-Benz emergency call system**
  - Automatic emergency call ..... 392
  - Information ..... 391
  - Information on data transfer ..... 393
  - Manual emergency call ..... 393
  - Overview ..... 391
- Mercedes-Benz Link**
  - Connecting ..... 381
- Ending ..... 382
- Note ..... 381
- Overview ..... 380
- Sound settings ..... 382
- Message (multifunction display)**
  - see Display message
- Message memory** ..... 505
- Messages**
  - Calling a message sender ..... 380
  - Composing ..... 379
  - Configuring the displayed text messages ..... 378
  - Deleting ..... 380
  - Forwarding ..... 380
  - Overview ..... 378
  - Reading ..... 379
  - Replying ..... 379
  - Sending ..... 379
  - Using a number/URL ..... 380
  - Using templates ..... 379
  - Voice commands (Voice Control System) ..... 280
- Mirrors**
  - see Exterior mirrors

**Mobile phone**

- Damage detection (parked vehicle) ..... 182
- Wireless charging ..... 128

**Mobile phone**

- see Android Auto
- see Apple CarPlay®
- see Mercedes-Benz Link
- see Second telephone
- see Telephone

**Mobile phone voice recognition**

- Starting ..... 372
- Stopping ..... 372

**Model series**

- see Vehicle identification plate

**MOExtended tires** ..... 438**Multifunction display**

- Overview of displays ..... 256

**Multifunction steering wheel**

- Overview of buttons ..... 253

**Multifunction steering wheel**

- see Steering wheel

**Multimedia system**

- Activating/deactivating DSR ..... 200

## Activating/deactivating standby

- mode ..... 183
- Adjusting the volume ..... 309
- Central control elements ..... 287
- Configuring display settings ..... 317
- Configuring drive program I ..... 166
- Favorites ..... 304
- Main functions ..... 296
- MBUX Interior Assistant (notes) ..... 291
- Overview ..... 284
- Restoring the factory settings ..... 326
- Standby mode function ..... 183
- Switching the sound on/off ..... 309

**Multimedia system**

- see Display (multimedia system)
- see Entering characters
- see MBUX Interior Assistant (multimedia system)
- see Notifications Center
- see Profile
- see Suggestions
- see Themes
- see Touch Control
- see Touchpad

**N****Navigation**

- Menu (on-board computer) ..... 259
- Overview ..... 327
- Showing/hiding the menu ..... 326
- Switching on ..... 326
- Updating the map data ..... 360
- Voice commands (Voice Control System) ..... 271

**Navigation**

- see Destination
- see Destination entry
- see Map
- see Parking service
- see Route
- see Route guidance
- see Traffic information

**Navigation announcements**

- Activating/deactivating ..... 348
- Adjusting the volume ..... 348
- Repeating ..... 349
- Switching audio fadeout on/off ..... 348

**Navigation messages**

- On-board computer ..... 259



- Near Field Communication (NFC)**
    - General information ..... 371
  - Neutral**
    - Inserting ..... 168
  - Non-operational time**
    - Activating/deactivating standby mode ..... 183
    - Standby mode function ..... 183
  - Notes** ..... 156
    - Optimized acceleration ..... 156
  - Notes on breaking-in a new vehicle** ..... 155
  - Notifications Center** ..... 305
    - Calling up a notification ..... 306
    - Editing a notification ..... 307
    - Global search (overview) ..... 307
    - Notification types ..... 305
    - Overview ..... 305
    - Selecting actions for a notification ..... 307
    - Using the global search ..... 308
- O**
- Occupant safety** ..... 64
    - Pets in the vehicle ..... 64
  - Occupant safety**
    - see Airbag
    - see Automatic front passenger front airbag shutoff
    - see PRE-SAFE® (anticipatory occupant protection)
    - see PRE-SAFE® PLUS (anticipatory occupant protection plus)
    - see Restraint system
    - see Seat belt
  - Odometer**
    - see Total distance
  - Off-road driving** ..... 160
  - Off-road driving**
    - see Off-road driving
  - Off-road ESP®**
    - Function/notes ..... 189
  - Oil**
    - see Engine oil
  - On-board computer** ..... 253
    - Assistance menu ..... 257
    - Displaying the service due date ..... 420
    - Head-up Display menu ..... 263
  - Media menu ..... 261
  - Menu designs ..... 255
  - Menu overview ..... 253
  - Multifunction display ..... 256
  - Navigation system menu ..... 259
  - Operating ..... 253
  - Radio menu ..... 261
  - Service menu ..... 257
  - Telephone menu ..... 262
  - Trip menu ..... 258
  - On-board diagnostics interface**
    - see Diagnostics connection
  - Online services**
    - Data storage ..... 30
  - Open-source software** ..... 31
  - Opening the tailgate using your foot**
    - see HANDS-FREE ACCESS
  - Operating fluids**
    - Additives (fuel) ..... 497
    - Brake fluid ..... 498
    - Coolant (engine) ..... 499
    - Engine oil ..... 497
    - Notes ..... 496
    - Refrigerant (air conditioning system) ... 500

- Windshield washer fluid ..... 500
- Operating safety**  
 Declaration of conformity (wireless vehicle components) ..... 25  
 Information ..... 24
- Operating system**  
 see On-board computer
- Operator's Manual**  
 Vehicle equipment ..... 22
- Operator's Manual (digital)** ..... 20
- Optimized acceleration** ..... 156  
 Activating ..... 156
- Overhead control panel**  
 Overview ..... 14
- P**
- Paint code** ..... 494
- Paintwork (cleaning instructions)** ..... 430
- Panic alarm** ..... 66  
 Activating/deactivating ..... 66
- Panoramic roof**  
 Adjusting the roller sunblind ..... 90  
 Operating the roller sunblind ..... 88
- Panoramic sliding sunroof**  
 see Sliding sunroof
- Park position**  
 Inserting ..... 169  
 Selecting automatically ..... 169
- Parking**  
 see Electric parking brake
- Parking aid**  
 see Parking Assist PARKTRONIC
- Parking Assist PARKTRONIC** ..... 220  
 Activating ..... 223, 224  
 Adjusting warning tones ..... 225  
 Function ..... 220  
 Problems ..... 221  
 Side impact protection ..... 222  
 Switching off ..... 223, 224  
 System limitations ..... 220
- Parking assistance systems**  
 see Active Parking Assist
- Parking brake**  
 see Electric parking brake
- Parking for an extended period** ..... 183
- Parking lights** ..... 130
- Parking options**  
 see Parking service
- Parking position**  
 Exterior mirrors ..... 142  
 Storing the position of the front-passenger outside mirror using reverse gear ..... 143
- Parking service** ..... 363  
 Notes ..... 363  
 Selecting parking options ..... 363  
 Showing a parking option on the map ..... 364
- PARKTRONIC**  
 Malfunction ..... 221
- Partitioning net**  
 Attaching ..... 113
- PASSENGER AIR BAG status display**  
 see Automatic front passenger front airbag shutoff
- Payload**  
 Calculation example ..... 469  
 Determining the maximum ..... 468

- Perfume**  
see Perfume atomizer
- Perfume atomizer** ..... 149  
Inserting/removing the flacon ..... 149  
Setting ..... 149
- Perfume vial**  
see Perfume atomizer
- Permitted towing methods** ..... 449
- Pets in the vehicle** ..... 64
- Phone book**  
see Contacts
- PIN protection**  
Activating/deactivating ..... 323
- Plastic trim (Care)** ..... 435
- POI**  
Quick access ..... 347  
Selecting ..... 331
- POI symbols**  
Selecting ..... 357
- Power supply**  
Switching on (Start/Stop button) ..... 152
- Power washer (care)** ..... 428
- Power windows**  
see Side windows
- PRE-SAFE® (anticipatory occupant protection)** ..... 47  
Function ..... 47  
PRE-SAFE® Sound ..... 47  
Reversing measures ..... 48
- PRE-SAFE® PLUS (anticipatory occupant protection plus)** ..... 48  
Function ..... 48  
Reversing measures ..... 48
- Preventative occupant protection system**  
see PRE-SAFE® (anticipatory occupant protection)
- Previous destinations**  
Selecting ..... 331
- Profile** ..... 297  
Creating a new profile ..... 298  
Maximum number of profiles ..... 297  
Notes ..... 297  
Overview ..... 297  
Selecting a profile ..... 299  
Selecting profile options ..... 298
- Showing the profile selection when entering ..... 299  
Synchronizing ..... 299
- Programs**  
see DYNAMIC SELECT
- Protecting the environment**  
Notes ..... 21
- Protection against collision**  
see Drive Away Assist
- Protection against theft**  
see ATA (anti-theft alarm system)
- Pulling away**  
see Notes
- Q**
- QR code**  
Rescue card ..... 28
- Qualified specialist workshop** ..... 26
- R**
- Radar and ultrasonic sensors**  
Damage ..... 184

**Radio**

|  |     |
|--|-----|
| Activating .....                                 | 408 |
| Activating/deactivating radio text .....         | 411 |
| Calling up the station list .....                | 410 |
| Deleting stations .....                          | 411 |
| Direct frequency entry .....                     | 410 |
| Displaying information .....                     | 411 |
| Displaying radio text .....                      | 411 |
| Editing station presets .....                    | 411 |
| Menu (on-board computer) .....                   | 261 |
| Moving stations .....                            | 411 |
| Overview .....                                   | 409 |
| Searching for stations .....                     | 410 |
| Setting a channel .....                          | 410 |
| Setting the waveband .....                       | 410 |
| Showing accident reports .....                   | 411 |
| Storing radio stations .....                     | 410 |
| Switching the HD Radio function<br>on/off .....  | 410 |
| Voice commands (Voice Control Sys-<br>tem) ..... | 276 |
| <b>Radio stations</b>                            |     |
| Dialing (on-board computer) .....                | 261 |
| <b>Rain closing function</b>                     |     |
| Sliding sunroof .....                            | 86  |

**Raising the vehicle**

|                           |     |
|---------------------------|-----|
| Rear of the vehicle ..... | 218 |
|---------------------------|-----|

**Range**

|                  |     |
|------------------|-----|
| Displaying ..... | 258 |
|------------------|-----|

**Reading light**

|                                    |     |
|------------------------------------|-----|
| Switching on/off using poses ..... | 295 |
|------------------------------------|-----|

**Reading light**

see Interior lighting

|                               |     |
|-------------------------------|-----|
| <b>Real wood (Care)</b> ..... | 435 |
|-------------------------------|-----|

|  |    |
|--|----|
| <b>Rear door (child safety lock)</b> ..... | 62 |
|--|----|

**Rear fog lamp**

|                        |     |
|------------------------|-----|
| Switching on/off ..... | 131 |
|------------------------|-----|

**Rear of the vehicle**

|                |     |
|----------------|-----|
| Lowering ..... | 218 |
|----------------|-----|

|               |     |
|---------------|-----|
| Raising ..... | 218 |
|---------------|-----|

**Rear seat**

see Seat

|                               |     |
|-------------------------------|-----|
| <b>Rear view camera</b> ..... | 225 |
|-------------------------------|-----|

|            |     |
|------------|-----|
| Care ..... | 433 |
|------------|-----|

|                |     |
|----------------|-----|
| Function ..... | 225 |
|----------------|-----|

|                                |  |
|--------------------------------|--|
| Opening the camera cover (360° |  |
|--------------------------------|--|

|               |     |
|---------------|-----|
| Camera) ..... | 232 |
|---------------|-----|

**Rear window**

|                                |     |
|--------------------------------|-----|
| Changing the wiper blade ..... | 139 |
|--------------------------------|-----|

|                                    |     |
|------------------------------------|-----|
| <b>Rear window defroster</b> ..... | 145 |
|------------------------------------|-----|

**Rear window wipers**

|                               |     |
|-------------------------------|-----|
| Activating/deactivating ..... | 137 |
|-------------------------------|-----|

|                                     |     |
|-------------------------------------|-----|
| <b>Reflective safety vest</b> ..... | 437 |
|-------------------------------------|-----|

**Refrigerant (air conditioning system)**

|             |     |
|-------------|-----|
| Notes ..... | 500 |
|-------------|-----|

**Refueling**

|                             |     |
|-----------------------------|-----|
| Refueling the vehicle ..... | 172 |
|-----------------------------|-----|

**Remote Online**

|                            |     |
|----------------------------|-----|
| Charging the battery ..... | 154 |
|----------------------------|-----|

|                                      |  |
|--------------------------------------|--|
| Cooling or heating the vehicle inte- |  |
|--------------------------------------|--|

|            |     |
|------------|-----|
| rior ..... | 154 |
|------------|-----|

|                            |     |
|----------------------------|-----|
| Starting the vehicle ..... | 155 |
|----------------------------|-----|

|                                       |    |
|---------------------------------------|----|
| <b>Reporting safety defects</b> ..... | 27 |
|---------------------------------------|----|

|                          |    |
|--------------------------|----|
| <b>Rescue card</b> ..... | 28 |
|--------------------------|----|

**Reserve**

|            |     |
|------------|-----|
| Fuel ..... | 497 |
|------------|-----|

|   |     |
|---|-----|
| <b>Reset function (multimedia system)</b> ..... | 326 |
|---|-----|

|                            |     |
|----------------------------|-----|
| <b>Residual heat</b> ..... | 148 |
|----------------------------|-----|

- Restoring (factory settings)**  
 see Reset function (multimedia system)
- Restraint system** ..... 33  
 Basic instructions for children ..... 49  
 Function in an accident ..... 34  
 Functionality ..... 34  
 Malfunction ..... 34  
 Protection ..... 33  
 Reduced protection ..... 33  
 Self-test ..... 34  
 Warning lamp ..... 34
- Reverse gear**  
 Inserting ..... 168
- Rims (Care)** ..... 433
- Roadside Assistance (breakdown)** ..... 23
- Roll away protection**  
 see HOLD function
- Roller sunblind** ..... 88  
 Panoramic roof ..... 88  
 Side windows ..... 88
- Roof carrier**  
 Attaching ..... 121  
 Loading ..... 121
- Roof load** ..... 502
- Route** ..... 335, 341  
 Accepting a detour recommendation  
 after a prompt ..... 337  
 Activating a commuter route ..... 342  
 Alternative route (quick-access) ..... 347  
 Calculating ..... 335  
 Displaying destination information ..... 340  
 Displaying the route list ..... 341  
 Editing a stored route ..... 344  
 External ..... 351  
 Planning ..... 340  
 Recording a route ..... 343  
 Saving a recorded route ..... 344  
 Selecting a type ..... 337  
 Selecting an alternative route ..... 341  
 Selecting notifications ..... 339  
 Selecting options ..... 338  
 Showing a stored route on the map .... 343  
 Starting a saved route ..... 343  
 Starting the automatic service station search ..... 342  
 Switching the automatic gas station search on/off ..... 342  
 With intermediate destinations ..... 341
- Route guidance** ..... 344  
 Canceling ..... 349  
 Changing direction ..... 345  
 Destination reached ..... 348  
 Freeway information ..... 347  
 From an off-road location ..... 349  
 Lane recommendations ..... 346  
 Notes ..... 344  
 Off-road ..... 350  
 To an off-road destination ..... 349
- Route-based speed adaptation**  
 Displays in the Instrument Display ..... 211  
 Function ..... 205
- Route-based speed adjustment**  
 Setting ..... 206
- Run-flat characteristics**  
 MOExtended tires ..... 438
- S**
- Safety systems**  
 see Driving safety system
- Satellite map** ..... 361
- Satellite radio**  
 Activating/deactivating TuneStart ..... 416

- Adding a channel to Smart Favorites ... 415
- Deleting a channel ..... 414
- Displaying EPG information ..... 414
- Displaying service information ..... 416
- Information ..... 411
- Information about Smart Favorites and TuneStart ..... 415
- Logging in ..... 412
- Moving a channel ..... 414
- Music and sport alerts function ..... 414
- Overview ..... 413
- Pause and playback function ..... 416
- Restrictions ..... 411
- Selecting a category ..... 413
- Selecting a channel ..... 414
- Setting music and sport alerts ..... 414
- Setting the parental control ..... 414
- Storing a channel ..... 414
- Switching on ..... 412
- Search light**
  - Switching on/off using poses ..... 295
- Seat** ..... 94, 95, 109
  - 4-way lumbar support ..... 97
  - Adjusting (electrically) ..... 97
  - Adjusting (mechanically and electrically) ..... 95
  - Adjusting the seat backrest angle (rear passenger compartment) ..... 112
  - Automatic seat adjustment ..... 100
  - Backrest (rear) locking ..... 111
  - Configuring the settings ..... 99
  - Correct driver's seat position ..... 94
  - Folding the backrest (rear passenger compartment) back ..... 110
  - Folding the backrest (rear) forwards .... 109
  - Operating the memory function ..... 105
  - Resetting the settings ..... 101
  - Setting options ..... 16
- Seat belt** ..... 35
  - Care ..... 435
  - Center rear seat (releasing) ..... 38
  - Protection ..... 35
- Seat belt adjustment**
  - Activating/deactivating ..... 39
  - Function ..... 39
- Seat belt warning**
  - see Seat belts
- Seat belts** ..... 39
  - Activating/deactivating seat belt adjustment ..... 39
  - Adjusting the height ..... 38
  - Fastening ..... 38
  - Reduced protection ..... 37
  - Releasing ..... 39
  - Seat belt adjustment (function) ..... 39
  - Warning lamp ..... 39
- Seat cover (Care)** ..... 435
- Seat heating**
  - Activating/deactivating ..... 101
- Seat ventilation**
  - Activating/deactivating ..... 102
- Second telephone** ..... 370
  - Connecting ..... 370
  - Features ..... 370
- Selecting a gear**
  - see Changing gears
- Selecting the sound profile**
  - Burmester® surround sound system .... 418
- Selector lever**
  - see DIRECT SELECT lever

- Self-test**
  - Automatic front passenger front air-bag shutoff ..... 45
- Sensors (Care)** ..... 433
- Service center**
  - see Qualified specialist workshop
- Service interval display**
  - see ASSYST PLUS
- Service station search**
  - Starting automatic search ..... 342
- Setting a speed**
  - see Cruise control
- Setting the date format** ..... 318
- Setting the distance unit** ..... 322
- Setting the map scale**
  - see Map
- Shift paddles**
  - see Steering wheel paddle shifters
- Shifting gears**
  - Gearshift recommendation ..... 171
- Short messages**
  - see Messages
- Side airbag** ..... 40
- Side impact protection** ..... 222
- Side windows** ..... 79
  - Child safety lock in the rear passenger compartment ..... 63
  - Closing ..... 79
  - Closing using the SmartKey ..... 81
  - Convenience closing feature ..... 81
  - Convenience opening ..... 81
  - Opening ..... 79
  - Opening with the SmartKey ..... 81
  - Problem ..... 82
  - Roller sunblind ..... 88
- Size designation (tires)** ..... 474
- Sliding sunroof** ..... 83
  - Automatic functions ..... 86
  - Closing ..... 83
  - Closing using the SmartKey ..... 81
  - Opening ..... 83
  - Opening with the SmartKey ..... 81
  - Problem ..... 86
  - Rain closing function ..... 86
- SmartKey** ..... 65
  - Acoustic locking verification signal ..... 66
- Battery** ..... 67
  - Energy consumption ..... 66
  - Features ..... 65
  - Key ring attachment ..... 67
  - Mechanical key ..... 67
  - Overview ..... 65
  - Panic alarm ..... 66
  - Problem ..... 69
  - Unlocking setting ..... 66
- SmartKey functions**
  - Deactivating ..... 66
- Smartphone**
  - see Android Auto
  - see Apple CarPlay®
  - see Mercedes-Benz Link
  - see Telephone
- Snow chains** ..... 459
- Socket (12 V)**
  - Cargo compartment ..... 126
  - Front passenger footwell ..... 125
  - Rear passenger compartment ..... 124
- Socket (115 V)** ..... 125
  - Rear passenger compartment ..... 125

- Software update** ..... 324  
  Important system updates ..... 325  
  Information ..... 324  
  Performing ..... 325
- Sound**  
  PRE-SAFE® Sound ..... 47  
  Wheels and tires ..... 458
- Sound**  
  see Burmester® surround sound system  
  see Sound settings
- Sound settings** ..... 416  
  Adjusting the balance/fader ..... 417  
  Adjusting treble, mid-range and bass  
  settings ..... 416  
  Automatic volume adjustment ..... 416  
  Calls up the sound menu ..... 416  
  Information ..... 416
- Spare wheel**  
  see Emergency spare wheel
- Special seat belt retractor** ..... 55
- Specialist workshop** ..... 26
- Speech dialog system**  
  see Voice Control System
- Speed index (tires)** ..... 474
- Speedometer**  
  Digital ..... 258
- Standby mode**  
  Activating/deactivating ..... 183  
  Function ..... 183
- Standing lights** ..... 130
- Start-off assist**  
  see Optimized acceleration
- Start/Stop button**  
  Parking the vehicle ..... 174  
  Starting the vehicle ..... 153  
  Switching on the power supply or  
  ignition ..... 152
- Start/stop function**  
  see ECO start/stop function
- Starting assistance**  
  see Jump-start connection
- Starting the engine**  
  see Vehicle
- Starting-off aid**  
  see Hill start assist
- Station**  
  Deleting ..... 411  
  Direct frequency entry ..... 410  
  Moving ..... 411  
  Searching ..... 410  
  Setting ..... 410  
  Storing ..... 410
- Station list**  
  Calling up ..... 410
- Station presets**  
  Modifying ..... 411
- STEER CONTROL**  
  Function/notes ..... 191
- Steering wheel** ..... 253  
  Adjusting (electrically) ..... 103  
  Buttons ..... 253  
  Operating the memory function ..... 105  
  Steering wheel heater ..... 103
- Steering wheel heater**  
  Switching on/off ..... 103
- Steering wheel paddle shifters** ..... 169
- Stowage areas**  
  see Loading



- see Stowage compartment
- Stowage compartment** ..... 108
- Armrest ..... 108
  - Center console ..... 108
  - Door ..... 108
  - Eyeglasses compartment ..... 108
  - Glove box ..... 108
  - Rear armrest ..... 108
- Stowage compartments**
- see Loading
  - see Stowage compartment
- Stowage space underneath the cargo compartment floor** ..... 119
- Suggestions** ..... 302
- Calling up ..... 302
  - Configuring ..... 303
  - Deleting ..... 303
  - Overview ..... 302
  - Renaming ..... 303
- Sun visor**
- Operating ..... 143
- Surround lighting**
- Switching on/off ..... 135
- Surround View**
- see 360° Camera
- Suspension**
- Adjusting the chassis level (AIR BODY CONTROL) ..... 216
- Suspension**
- see AIR BODY CONTROL
- Switch-off delay time**
- Exterior ..... 134
  - Interior ..... 136
- Synchronization function**
- Activating/deactivating (multimedia system) ..... 148
  - Switching on/off (control panel) ..... 148
- System settings**
- Activating/deactivating PIN protection ..... 323
  - Reset function (multimedia system) ... 326
  - Setting the distance unit ..... 322
  - Setting the time and date automatically ..... 318
  - Setting the time zone ..... 318
  - Setting the time/date format ..... 318
  - Switching transmission of the vehicle position on/off ..... 319
- System settings**
- see Bluetooth®
  - see Data import/export
  - see Language
  - see Software update
  - see Wi-Fi
- T**
- Tailgate** ..... 74
- Closing ..... 75
  - HANDS-FREE ACCESS ..... 77
  - Limiting the opening angle ..... 79
  - Opening ..... 74
  - Opening dimensions ..... 501
  - Unlocking (mechanical key) ..... 79
- Tailpipes (Care)** ..... 433
- Tank content**
- Fuel ..... 497
  - Reserve (fuel) ..... 497
- Technical data**
- Axle load (trailer operation) ..... 504
  - Information ..... 492

- Notes (trailer hitch) ..... 503  
 Tongue weight ..... 504  
 Towing capacity (trailer operation) ..... 504  
 Vehicle identification plate ..... 494
- Telephone** ..... 262, 368
- Activating functions during a call ..... 373
  - Calls with several participants ..... 373
  - Changing a function ..... 370
  - Connecting a mobile phone (Pass-key) ..... 369
  - Connecting a mobile phone (Secure Simple Pairing) ..... 369
  - Disconnecting a mobile phone ..... 371
  - Importing contacts ..... 375
  - Importing contacts (overview) ..... 375
  - Incoming call during an existing call .... 373
  - Information ..... 369
  - Interchanging mobile phones ..... 370
  - Menu (on-board computer) ..... 262
  - Mobile phone voice recognition ..... 372
  - Notes ..... 366
  - Operating modes ..... 369
  - Reception and transmission volume .... 372
  - Replacing mobile phones ..... 371
  - Setting the ringtone ..... 372
  - Telephone menu overview ..... 368
  - Telephone operation ..... 372
  - Voice commands (Voice Control System) ..... 274
  - Wireless charging (mobile phone) ..... 128
- Telephony number**  
 Dialing (on-board computer) ..... 262
- Telephony operating modes**  
 Bluetooth® Telephony ..... 369
- Telephony operating modes**  
 see Second telephone
- Temperature** ..... 145
- Temperature grade** ..... 471
- Text messages**  
 Voice commands (Voice Control System) ..... 280
- Text messages**  
 see Messages
- Themes** ..... 300
- Calling up ..... 300
  - Deleting ..... 302
  - Fastening ..... 300
  - Modifying ..... 301
- Moving ..... 302  
 Overview ..... 300
- Through-loading feature**  
 see Seat
- Time**  
 Manual time setting ..... 318  
 Setting the time and date automatically ..... 318  
 Setting the time zone ..... 318  
 Setting the time/date format ..... 318
- TIN (Tire Identification Number)** ..... 472
- Tire and Loading Information placard** ... 467
- Tire characteristics** ..... 474
- Tire inflation compressor**  
 see TIREFIT kit
- Tire information table** ..... 467
- Tire labeling** ..... 471
- Characteristics ..... 474
  - DOT, Tire Identification Number (TIN) .. 472
  - Load index ..... 474
  - Load-bearing capacity ..... 474
  - Maximum tire load ..... 473
  - Maximum tire pressure ..... 473

- Overview ..... 471
- Speed rating ..... 474
- Temperature grade ..... 471
- Tire Quality Grading ..... 471
- Tire size designation ..... 474
- Traction grade ..... 471
- Tread wear grade ..... 471
- Tire load (maximum)** ..... 473
- Tire pressure** ..... 461, 462
  - Checking (manually) ..... 462
  - Checking (tire pressure monitoring system) ..... 464
  - Maximum ..... 473
  - Notes ..... 460
  - Restarting the tire pressure loss warning system ..... 466
  - Restarting the tire pressure monitoring system ..... 465
  - Tire pressure loss warning system (function) ..... 465
  - Tire pressure monitoring system (function) ..... 463
  - Tire pressure table ..... 461
  - TIREFIT kit ..... 439
- Tire pressure loss warning system**
  - Function ..... 465
  - Restarting ..... 466
- Tire pressure monitor** ..... 465
  - Function ..... 463
  - Restarting ..... 465
- Tire pressure monitoring system**
  - Checking the tire pressure ..... 464
  - Checking the tire temperature ..... 464
- Tire pressure table** ..... 461
- Tire Quality Grading** ..... 471
- Tire temperature**
  - Checking (tire pressure monitoring system) ..... 464
  - Tire pressure monitoring system (function) ..... 463
- Tire tread** ..... 458
- Tire-change tool kit**
  - Overview ..... 482
- TIREFIT kit** ..... 439
  - Storage location ..... 439
  - Using ..... 439
- Tires**
  - Changing hub caps ..... 483
  - Characteristics ..... 474
  - Checking ..... 458
  - Checking the tire pressure (manually) ..... 462
  - Checking the tire pressure (tire pressure monitoring system) ..... 464
  - Definitions ..... 476
  - DOT, Tire Identification Number (TIN) .. 472
  - Flat tire ..... 437
  - Installing ..... 486
  - Load index ..... 474
  - Load-bearing capacity ..... 474
  - Maximum tire load ..... 473
  - Maximum tire pressure ..... 473
  - MOExtended tires ..... 438
  - Noise ..... 458
  - Notes on installing ..... 479
  - Overview of tire labeling ..... 471
  - Removing ..... 486
  - Replacing ..... 479, 483
  - Restarting the tire pressure loss warning system ..... 466
  - Restarting the tire pressure monitoring system ..... 465

- Rotating ..... 481
- Selection ..... 479
- Snow chains ..... 459
- Speed rating ..... 474
- Storing ..... 482
- Temperature grade ..... 471
- Tire and Loading Information placard .. 467
- Tire pressure (notes) ..... 460
- Tire pressure loss warning system  
(function) ..... 465
- Tire pressure monitoring system  
(function) ..... 463
- Tire pressure table ..... 461
- Tire Quality Grading ..... 471
- Tire size designation ..... 474
- TIREFIT kit ..... 439
- Traction grade ..... 471
- Tread wear grade ..... 471
- Unusual handling characteristics ..... 458
- Tongue weight** ..... 504
- Tool**  
  see Vehicle tool kit
- Top Tether** ..... 58
- Total distance** ..... 258  
  Displaying ..... 258
- Touch Control** ..... 287  
  On-board computer ..... 253  
  Operating ..... 287  
  Setting acoustic operating feedback ... 288  
  Setting the sensitivity ..... 288
- Touchpad** ..... 289  
  Activating/deactivating haptic oper-  
  ating feedback ..... 290  
  Operating ..... 289  
  Reading the handwriting recognition  
  aloud ..... 290  
  Selecting a station and track ..... 291  
  Setting acoustic operating feedback ... 290  
  Setting the sensitivity ..... 290
- Touchscreen (media display)**  
  Entering characters ..... 314  
  Operating ..... 288  
  Setting acoustic operating feedback ... 289
- Tow-away alarm**  
  Activating/deactivating ..... 92  
  Function ..... 92
- Tow-bar system** ..... 251
- Tow-starting** ..... 454
- Towing a trailer**  
  Notes ..... 247
- Towing away** ..... 450
- Towing eye**  
  Installing ..... 454  
  Storage location ..... 453
- Towing methods** ..... 449
- Traction grade** ..... 471
- Traffic information** ..... 351  
  Car-to-X-Communication ..... 354  
  Displaying the traffic map ..... 352  
  Displaying traffic incidents ..... 353  
  Live Traffic Information ..... 352  
  Overview ..... 351  
  Switching on the display ..... 353
- Traffic map**  
  see Map
- Traffic Sign Assist** ..... 240  
  Function/notes ..... 240  
  Setting ..... 241  
  System limitations ..... 240

- Trailer hitch**  
 Attaching the ball neck ..... 249  
 Care ..... 433  
 Coupling up/uncoupling a trailer ..... 249
- Trailer operation**  
 Active Blind Spot Assist ..... 244  
 Active Lane Keeping Assist ..... 245  
 Attaching the ball neck ..... 249  
 Coupling up/uncoupling a trailer ..... 249
- Trailer stabilization**  
 Function/notes ..... 191
- Trailer tow hitch**  
 Axle load ..... 504  
 General notes ..... 503  
 Notes ..... 247  
 Tongue weight ..... 504  
 Towing capacity ..... 504
- Transferred vehicle data**  
 Android Auto ..... 386  
 Apple CarPlay® ..... 386
- Transmission position display** ..... 167
- Transporting**  
 Vehicle ..... 452
- Tread wear grade** ..... 471
- Trim element (Care)** ..... 435
- Trip**  
 Menu (on-board computer) ..... 258
- Trip computer**  
 Displaying ..... 258  
 Resetting ..... 259
- Trip distance** ..... 258  
 Displaying ..... 258  
 Resetting ..... 259
- Trip odometer**  
 see Trip distance
- Trunk lid**  
 see Tailgate
- TuneIn**  
 Calling up ..... 398  
 Calling up the station list (category last selected) ..... 401  
 Deleting stations ..... 401  
 Logging out ..... 401  
 Overview ..... 400  
 Registering ..... 401  
 Saving stations ..... 401
- Selecting and connecting to a station ..... 400  
 Selecting stream ..... 401  
 Setting options ..... 401  
 Terms of use ..... 401
- TuneMix**  
 Creating a list ..... 415
- Turn signal indicator**  
 see Turn signals
- Turn signals** ..... 131  
 Switching on/off ..... 131
- Two-way radios**  
 Frequencies ..... 493  
 Notes on installation ..... 492  
 Transmission output (maximum) ..... 493
- U**
- Units of measurement**  
 Setting ..... 322
- Unlocking setting** ..... 66
- USB port** ..... 127
- User profile**  
 see Profile

**Using the telephone**

see Calls

**V**

- Vehicle** ..... 153
  - Activating/deactivating standby mode ..... 183
  - Correct use ..... 27
  - Damage detection (parking) ..... 182
  - Data acquisition ..... 28
  - Data storage ..... 28
  - Diagnostics connection ..... 26
  - Equipment ..... 22
  - Limited Warranty ..... 28
  - Locking (automatically) ..... 72
  - Locking (from the inside) ..... 70
  - Locking (KEYLESS-GO) ..... 70
  - Locking/unlocking (emergency key) ..... 73
  - Lowering ..... 487
  - Maintenance ..... 23
  - Parking for an extended period ..... 183
  - Problem notification ..... 27
  - QR code rescue card ..... 28
  - Qualified specialist workshop ..... 26
  - Raising ..... 484
  - Standby mode function ..... 183
  - Starting (emergency operation mode) ..... 153
  - Starting (Remote Online) ..... 155
  - Starting (start/stop button) ..... 153
  - Switching off (start/stop button) ..... 174
  - Towing ..... 251
  - Unlocking (from the inside) ..... 70
  - Unlocking (KEYLESS-GO) ..... 70
  - Ventilating (convenience opening) ..... 81
  - Voice commands (Voice Control System) ..... 281
- Vehicle data**
  - Angle of approach/departure ..... 502
  - Displaying (DYNAMIC SELECT) ..... 167
  - Fording depth ..... 502
  - Maximum gradient-climbing capability ..... 502
  - Roof load ..... 502
  - Transferring to Android Auto ..... 386
  - Transferring to Apple CarPlay® ..... 386
  - Turning radius ..... 501
  - Vehicle height ..... 501
  - Vehicle length ..... 501
  - Vehicle width ..... 501
- Wheelbase ..... 501
- Vehicle data storage**
  - Event data recorders ..... 30
  - MBUX multimedia system/Mercedes me connect ..... 30
- Vehicle dimensions** ..... 501
- Vehicle electronics**
  - Notes ..... 492
  - Two-way radios ..... 492
- Vehicle identification number**  
see VIN
- Vehicle identification plate** ..... 494
  - Paint code ..... 494
  - VIN ..... 494
- Vehicle interior**
  - Cooling or heating (Remote Online) ..... 154
- Vehicle key**  
see SmartKey
- Vehicle maintenance**  
see ASSYST PLUS
- Vehicle operation**
  - Outside the USA or Canada ..... 23

|  |     |
|--|-----|
| <b>Vehicle position</b>                      |     |
| Switching transmission on/off .....          | 319 |
| <b>Vehicle tool kit</b> .....                | 439 |
| TIREFIT kit .....                            | 439 |
| Towing eye .....                             | 453 |
| <b>Ventilating</b>                           |     |
| Convenience opening .....                    | 81  |
| <b>Ventilation</b>                           |     |
| see Climate control                          |     |
| <b>Vents</b>                                 |     |
| see Air vents                                |     |
| <b>VIN</b> .....                             | 494 |
| Identification plate .....                   | 494 |
| Seat .....                                   | 494 |
| Windshield .....                             | 494 |
| <b>Vision</b>                                |     |
| Removing condensation from the windows ..... | 148 |
| <b>Voice Control System</b> .....            | 266 |
| Audible help functions .....                 | 268 |
| Improving speech quality .....               | 269 |
| Language setting .....                       | 267 |
| Media player voice commands .....            | 277 |

|  |     |
|--|-----|
| Message voice commands .....                   | 280 |
| Multifunction steering wheel (operating) ..... | 266 |
| Navigation voice commands .....                | 271 |
| Notes on the voice commands .....              | 269 |
| Online voice control .....                     | 269 |
| Operable functions .....                       | 267 |
| Operating safety .....                         | 265 |
| Radio voice commands .....                     | 276 |
| Setting (multimedia system) .....              | 267 |
| Switch voice commands .....                    | 269 |
| Telephone voice controls .....                 | 274 |
| Text message voice commands .....              | 280 |
| Vehicle voice commands .....                   | 281 |
| Voice prompting .....                          | 266 |

**Voice control system**

see Voice Control System















**W****Warning lamps**







see Warning/indicator lamps

**Warning system**

see ATA (anti-theft alarm system)

**Warning/indicator lamp**

|  |     |
|--|-----|
|  ABS warning lamp .....   | 563 |
|  Brake warning lamp (USA) .....                                       | 561 |
|  Brakes warning lamp (Canada) ...                                     | 561 |
|  Coolant warning lamp .....   | 557 |
|  Electrical malfunction warning lamp .....                            | 558 |
|  Engine diagnosis warning lamp ..                                     | 558 |
|  ESP® OFF warning lamp .....  | 565 |
|  ESP® warning lamp flashes .....                                      | 564 |
|  ESP® warning lamp lights up .....                                    | 564 |
|  Fuel reserve warning lamp .....                                      | 559 |
|  Red indicator lamp, electric parking brake applied (Canada only) ... | 560 |
|  Red indicator lamp, electric parking brake applied (USA only) .....  | 560 |
|  Restraint system warning lamp ..                                     | 555 |
|  Seat belt warning lamp flashes ..                                    | 555 |
|  Seat belt warning lamp lights up .....                               | 556 |

-  Suspension warning lamp ..... 562
-  Tire pressure monitoring system warning lamp flashes ..... 566
-  Tire pressure monitoring system warning lamp lights up ..... 566
-  Warning lamp for distance warning function ..... 562
-  Warning lamp for electric power steering ..... 556
-  Yellow electric parking brake indicator lamp is malfunctioning ..... 560
- Warning/indicator lamps** ..... 553
  - Overview ..... 553
  - PASSENGER AIR BAG ..... 45
- Warranty** ..... 28
- Washer fluid**
  - see Windshield washer fluid
- Washing by hand (care)** ..... 429
- Water tank**
  - see Air-water duct
- Weather information** ..... 362
- Web browser**
  - Calling up a web page ..... 395
  - Calling up options ..... 397
  - Calling up the settings ..... 398
  - Deleting a bookmark ..... 398
  - Deleting Internet history ..... 398
  - Ending ..... 398
  - Managing bookmarks ..... 398
  - Overview ..... 397
- Website**
  - Calling up ..... 395
- Wheel change**
  - Lowering the vehicle ..... 487
  - Mounting a new wheel ..... 486
  - Removing a wheel ..... 486
  - Removing/installing hub caps ..... 483
- Wheel rotation** ..... 481
- Wheels**
  - Care ..... 433
  - Changing hub caps ..... 483
  - Checking ..... 458
  - Checking the tire pressure (manually) ..... 462
  - Checking the tire pressure (tire pressure monitoring system) ..... 464
  - Definitions ..... 476
  - DOT, Tire Identification Number (TIN) .. 472
  - Flat tire ..... 437
  - Installing ..... 486
  - Load index ..... 474
  - Load-bearing capacity ..... 474
  - Maximum tire load ..... 473
  - Maximum tire pressure ..... 473
  - MOExtended tires ..... 438
  - Noise ..... 458
  - Notes on installing ..... 479
  - Overview of tire labeling ..... 471
  - Removing ..... 486
  - Replacing ..... 479, 483
  - Restarting the tire pressure loss warning system ..... 466
  - Restarting the tire pressure monitoring system ..... 465
  - Rotating ..... 481
  - Selection ..... 479
  - Snow chains ..... 459
  - Speed rating ..... 474
  - Storing ..... 482
  - Temperature grade ..... 471



- Tire and Loading Information placard .. 467  
Tire characteristics ..... 474  
Tire pressure (notes) ..... 460  
Tire pressure loss warning system  
(function) ..... 465  
Tire pressure monitoring system  
(function) ..... 463  
Tire pressure table ..... 461  
Tire Quality Grading ..... 471  
Tire size designation ..... 474  
TIREFIT kit ..... 439  
Traction grade ..... 471  
Tread wear grade ..... 471  
Unusual handling characteristics ..... 458
- Wi-Fi** ..... 319  
  Overview ..... 319  
  Setting ..... 320  
  Setting up a hotspot ..... 321
- Window curtain airbag** ..... 40
- Windows**  
  see Side windows
- Windows (Care)** ..... 433
- Windshield** ..... 138, 145  
  Defrosting ..... 145  
  Replacing the wiper blades ..... 138
- Windshield**  
  see Windshield
- Windshield washer fluid** ..... 500  
  Notes ..... 500
- Windshield washer system**  
  Topping up ..... 427
- Windshield wipers**  
  Activating/deactivating ..... 137  
  Replacing the wiper blades ..... 138
- Winter operation**  
  Snow chains ..... 459
- Wiper blades**  
  Care ..... 433  
  Replacing ..... 138
- Wireless charging**  
  Function/notes ..... 127  
  Mobile phone ..... 128
- Wireless vehicle components**  
  Declaration of conformity ..... 25
- Workshop**  
  see Qualified specialist workshop

