



# E-Class

Sedan and Wagon  
Operator's Manual



Mercedes-Benz

## Symbols

Registered trademarks:

- BabySmart™ is a registered trademark of the Siemens Automotive Corp.
- Bluetooth® is a registered trademark of the Bluetooth SIG Inc.
- DTS is a registered trademark of DTS, Inc.
- Dolby and MLP are registered trademarks of Dolby Laboratories.
- ESP® and PRE-SAFE® are registered trademarks of Daimler AG.
- HomeLink® is a registered trademark of Prince, a Johnson Controls Company.
- iPod® and iTunes® are registered trademarks of Apple Inc., registered in the USA and in other countries.
- Logic 7® is a registered trademark of Harman International Industries, Incorporated.
- Microsoft® is a registered trademark of the Microsoft Corporation in the USA and in other countries.
- SIRIUS and associated brands are registered trademarks of SIRIUS XM Radio Inc.
- HD Radio and associated brands are registered trademarks of the iBiquity Digital Corporation.
- Windows Media® is a registered trademark of the Microsoft Corporation in the USA and in other countries.
- Gracenote® is a registered trademark of Gracenote, Inc.
- ZagatSurvey® and associated brands are registered trademarks of Zagat.

In this Operator's Manual, you will find the following symbols:





### WARNING

Warning notes draw your attention to hazards that endanger your health or life, or the health or life of others.

 These warning notes draw your attention to hazards that could cause damage to your vehicle.

 This symbol indicates useful instructions or further information that could be helpful to you.

 This symbol designates an instruction you must follow.

 Several consecutive symbols indicate an instruction with several steps.

 Page This symbol tells you where you can find further information on a topic.

 This symbol indicates a warning or an instruction that is continued on the next page.

**Display** This font indicates a display message in the multifunction display/COMAND display.

Parts of the software in the vehicle are subject to copyright according to © 2005 The FreeType Project  
<http://www.freetype.org>. All rights reserved.

## **Welcome to the world of Mercedes-Benz**

Before you drive off, please familiarize yourself with your vehicle and read this manual, especially the safety and warning notes. This will help you to obtain the maximum pleasure from your vehicle and avoid endangering yourself and others.

The equipment or model designation of your vehicle may differ according to:

- model
- order
- country variant
- availability

Mercedes-Benz is constantly updating its vehicles to the state of the art.

Mercedes-Benz therefore reserves the right to introduce changes in the following areas:

- design
- equipment
- technical features

Therefore, you cannot base any claims on the illustrations or text content in this Operator's Manual.

The following are integral components of the vehicle:

- Operator's Manual
- Service Booklet
- Equipment-dependent supplements

Keep these documents in the vehicle at all times. When you sell the vehicle, always pass the documents on to the new owner.

The technical documentation team at Daimler AG wishes you safe and pleasant motoring.

Mercedes-Benz USA, LLC

Mercedes-Benz Canada, Inc.

A Daimler Company





<b>Index</b> .....	<b>4</b>	<b>At a glance</b> .....	<b>27</b>
<b>Introduction</b> .....	<b>22</b>	<b>Safety</b> .....	<b>37</b>
		<b>Opening/closing</b> .....	<b>73</b>
		<b>Seats, steering wheel and mirrors</b> ....	<b>97</b>
		<b>Lights and windshield wipers</b> .....	<b>113</b>
		<b>Climate control</b> .....	<b>129</b>
		<b>Driving and parking</b> .....	<b>143</b>
		<b>On-board computer and displays</b> ....	<b>213</b>
		<b>Stowing and features</b> .....	<b>273</b>
		<b>Maintenance and care</b> .....	<b>307</b>
		<b>Breakdown assistance</b> .....	<b>321</b>
		<b>Wheels and tires</b> .....	<b>345</b>
		<b>Technical data</b> .....	<b>379</b>

- 1, 2, 3 ...
- 115 V socket** ..... 295
- 12 V socket**  
see Sockets
- 4ETS**  
see ETS/4ETS (Electronic  
Traction System)
- 4MATIC (permanent four-wheel  
drive)** ..... 192
- 4MATIC off-road system** ..... 192
- A**
- ABS (Anti-lock Braking System)**  
Display message ..... 235  
Function/notes ..... 64  
Important safety notes ..... 64  
Warning lamp ..... 264
- Activating/deactivating cooling  
with air dehumidification** ..... 134
- Active Blind Spot Assist**  
Activating/deactivating (on-  
board computer) ..... 225  
Function/information ..... 207
- Active Driving Assistance package** . 206
- Active Lane Keeping Assist**  
Activating/deactivating (on-  
board computer) ..... 225  
Display message ..... 250  
Function/information ..... 210
- Active Light System**  
Display message ..... 244
- Active multicontour seat** ..... 102
- Active service system PLUS**  
see ASSYST PLUS service interval  
display
- ADAPTIVE BRAKE** ..... 69
- Adaptive Highbeam Assist**  
Display message ..... 245  
Function/notes ..... 118  
Switching on/off (on-board  
computer) ..... 227
- Additives (engine oil)** ..... 388
- Air bags**  
Display message ..... 241  
Front air bag (driver, front  
passenger) ..... 41
- Important safety notes ..... 40
- Knee bag ..... 42
- PASSENGER AIRBAG OFF**  
indicator lamp ..... 44
- Pelvis air bag ..... 43
- Safety guidelines ..... 39
- Side impact air bag ..... 42
- Window curtain air bag ..... 44
- Air-conditioning system**  
see Climate control
- Air filter (display message)** ..... 248
- AIRMATIC**  
Display message ..... 249  
Function/notes ..... 189
- Air pressure**  
see Tire pressure
- Air vents**  
Glove box ..... 141  
Important safety notes ..... 140  
Rear ..... 141  
Setting ..... 140  
Setting the center air vents ..... 141  
Setting the side air vents ..... 141
- Alarm system**  
see ATA (Anti-Theft Alarm system)
- Alertness Assistant**  
see ATTENTION ASSIST
- Ambient lighting (on-board  
computer)** ..... 227
- AMG adaptive sport suspension  
system** ..... 190
- AMG menu (on-board computer)** ..... 230
- Anti-lock Braking System**  
see ABS (Anti-lock Braking System)
- Anti-Theft Alarm system**  
see ATA (Anti-Theft Alarm system)
- Anti-theft system**  
ATA (Anti-Theft Alarm system) ..... 72
- Ashtray** ..... 292
- Assistance menu (on-board  
computer)** ..... 224
- ASSYST PLUS**  
see ASSYST PLUS service interval  
display

- ATA (Anti-Theft Alarm system)**  
 Activating/deactivating ..... 72  
 Function ..... 72  
 Switching off the alarm ..... 72
- ATTENTION ASSIST**  
 Activating/deactivating ..... 225  
 Display message ..... 249  
 Function/notes ..... 199
- Audio menu (on-board computer) ....** 221
- Audio system**  
 see separate operating instructions
- Authorized Mercedes-Benz Center**  
 see Qualified specialist workshop
- AUTO lights**  
 Display message ..... 245  
 see Lights
- Automatic engine start (ECO start/  
 stop function) .....** 149
- Automatic engine switch-off (ECO  
 start/stop function) .....** 149
- Automatic headlamp mode .....** 116
- Automatic transmission**  
 Automatic drive program ..... 157  
 Changing gear ..... 155  
 DIRECT SELECT lever ..... 153  
 Display message ..... 257  
 Driving tips ..... 155  
 Emergency running mode ..... 160  
 Kickdown ..... 156  
 Manual drive program ..... 158  
 Program selector button ..... 156  
 Pulling away ..... 147  
 Selector lever ..... 152  
 Shift ranges ..... 157  
 Starting the engine ..... 147  
 Steering wheel paddle shifters ..... 157  
 Transmission position display ..... 153  
 Transmission positions ..... 155
- Automatic transmission  
 emergency mode .....** 160
- B**
- Back support**  
 see Lumbar support
- Bag hook .....** 282
- BAS (Brake Assist System) .....** 64
- Basic settings**  
 see Settings
- BAS PLUS (Brake Assist System  
 PLUS) .....** 64
- Battery (SmartKey)**  
 Checking ..... 78  
 Important safety notes ..... 78  
 Replacing ..... 78
- Battery (vehicle)**  
 Charging ..... 337  
 Display message ..... 247  
 Important safety notes ..... 335  
 Jump starting ..... 338
- Belt**  
 see Seat belts
- Blind Spot Assist**  
 Activating/deactivating ..... 225  
 Notes/function ..... 203  
 see Active Blind Spot Assist
- BlueTEC (DEF) .....** 387
- Bottle holder .....** 290
- Brake Assist System**  
 see BAS (Brake Assist System)
- Brake fluid**  
 Display message ..... 237  
 Notes ..... 388
- Brake fluid level .....** 312
- Brake lamps**  
 Display message ..... 243
- Brakes**  
 ABS ..... 64  
 BAS ..... 64  
 BAS PLUS ..... 64  
 Brake fluid (notes) ..... 388  
 Display message ..... 235  
 Driving tips ..... 171  
 High-performance brake system .... 173  
 Important safety notes ..... 171  
 Maintenance ..... 172  
 Parking brake ..... 169  
 Warning lamp ..... 263
- Breakdown**  
 see Flat tire  
 see Towing away/tow-starting
- Bulbs**  
 see Changing bulbs

## C

**California**

Important notice for retail customers and lessees ..... 23

**Calling up a malfunction**

see Display messages

**Capacities**

see Technical data

**Car**

see Vehicle

**Care**

Carpets ..... 320  
 Car wash ..... 314  
 Display ..... 318  
 Exterior lights ..... 317  
 Gear or selector lever ..... 319  
 Matte finish ..... 316  
 Night View Assist Plus ..... 318  
 Notes ..... 313  
 Paint ..... 316  
 Plastic trim ..... 319  
 Power washer ..... 315  
 Rear view camera ..... 318  
 Roof lining ..... 320  
 Seat belt ..... 320  
 Seat cover ..... 320  
 Sensors ..... 317  
 Steering wheel ..... 319  
 Tail pipes ..... 318  
 Trim pieces ..... 319  
 Washing by hand ..... 315  
 Wheels ..... 315  
 Windows ..... 317  
 Wiper blades ..... 317  
 Wooden trim ..... 319

**Cargo compartment cover** ..... 282

**Cargo compartment enlargement** ... 280

**Cargo compartment floor** ..... 286

**Cargo net** ..... 284

Attaching ..... 284

**Cargo tie down rings** ..... 281

**Car wash (care)** ..... 314

**CD player/CD changer (on-board computer)** ..... 222

**Cell phone**

see Mobile phone

**Center console**

Lower section ..... 33

Lower section (AMG vehicles) ..... 34

Upper section ..... 32

**Central locking**

Automatic locking (on-board computer) ..... 228

Locking/unlocking (SmartKey) ..... 74

**Changing bulbs**

High-beam headlamps ..... 123

Important safety notes ..... 121

Infrared lamp ..... 123

Low-beam headlamps ..... 122

Overview of bulb types ..... 122

Parking lamps ..... 123

Standing lamps (front) ..... 123

Turn signals (front) ..... 124

**Child-proof locks**

Important safety notes ..... 61

Rear doors ..... 61

**Children**

In the vehicle ..... 56

Restraint systems ..... 56

**Child seat**

LATCH-type (ISOFIX) child seat

anchors ..... 59

Special seat belt retractor ..... 59

Top Tether ..... 60

**Cigarette lighter** ..... 293

**Climate control**

Automatic climate control (3-zone) ..... 133

Controlling automatically ..... 135

Cooling with air dehumidification . . 134

Defrosting the windows ..... 138

Defrosting the windshield ..... 138

Dual-zone automatic climate control ..... 131

Important safety notes ..... 130

Indicator lamp ..... 135

Maximum cooling ..... 138

Notes on using automatic climate control ..... 132, 134

Overview of systems ..... 130

Problems with cooling with air dehumidification ..... 135

Problem with the rear window defroster ..... 139

- Rear control panel ..... 133
  - Refrigerant ..... 388
  - Setting the air distribution ..... 137
  - Setting the airflow ..... 137
  - Setting the air vents ..... 140
  - Setting the climate mode ..... 136
  - Setting the temperature ..... 136
  - Switching air-recirculation mode  
on/off ..... 139
  - Switching on/off ..... 134
  - Switching residual heat on/off ..... 140
  - Switching the rear window  
heating on/off ..... 139
  - Switching the ZONE function on/  
off ..... 137
  - Coat hooks** ..... 284
  - Cockpit**  
Overview ..... 28  
see Instrument cluster
  - Collapsible spare wheel**  
Inflating ..... 332  
see Emergency spare wheel
  - COMAND**  
see separate operating instructions
  - Combination switch** ..... 117
  - Combined cargo cover and net** ..... 283
  - Compass**  
Calibrating ..... 306  
Calling up ..... 305  
Setting ..... 305
  - Consumption statistics (on-board  
computer)** ..... 219
  - Convenience closing feature** ..... 91
  - Convenience opening feature** ..... 91
  - Coolant (engine)**  
Checking the level ..... 311  
Display message ..... 245  
Notes ..... 389  
Temperature (on-board computer) . 230  
Temperature gauge ..... 214  
Warning lamp ..... 268
  - Cooling**  
see Climate control
  - Cornering light function**  
Display message ..... 242  
Function/notes ..... 118
  - Crash-responsive emergency  
lighting** ..... 121
  - Cruise control**  
Cruise control lever ..... 176  
Deactivating ..... 177  
Display message ..... 254  
Driving system ..... 175  
Function/notes ..... 175  
Important safety notes ..... 175  
LIM indicator lamp ..... 176  
Setting a speed ..... 176  
Storing and maintaining current  
speed ..... 176
  - Cup holder**  
Center console ..... 289  
Important safety notes ..... 289  
Rear compartment ..... 290
  - Customer Assistance Center (CAC)** ... 25
  - Customer Relations Department** ..... 25
- D**
- Dashboard**  
see Cockpit
  - Data**  
see Technical data
  - Daytime running lamp mode**  
see Daytime running lamps
  - Daytime running lamps**  
Display message ..... 244  
Switching on/off (on-board  
computer) ..... 227  
Switching on/off (switch) ..... 115
  - DEF**  
Adding ..... 165  
Display message ..... 248
  - Delayed switch-off**  
Exterior lighting (on-board  
computer) ..... 227  
Interior lighting ..... 228
  - Diesel particle filter** ..... 171
  - Digital speedometer** ..... 219
  - DIRECT SELECT lever**  
see Automatic transmission
  - Display (cleaning instructions)** ..... 318
  - Display messages**  
Calling up (on-board computer) ..... 234  
Driving systems ..... 249  
Engine ..... 245  
General notes ..... 234

- Hiding (on-board computer) ..... 234
- KEYLESS-GO ..... 259
- Lights ..... 242
- Safety systems ..... 235
- Service interval display ..... 312
- SmartKey ..... 259
- Tires ..... 254
- Vehicle ..... 257
- Distance display (on-board computer)** ..... 224
- Distance recorder** ..... 219
  - see Odometer
  - see Trip odometer
- Distance warning (warning lamp)** .... 270
- DISTRONIC PLUS**
  - Deactivating ..... 184
  - Display message ..... 252
  - Displays in the multifunction display ..... 183
  - Driving tips ..... 185
  - Function/notes ..... 177
  - Important safety notes ..... 177
  - Setting the specified minimum distance ..... 183
  - Warning lamp ..... 270
- Doors**
  - Automatic locking (on-board computer) ..... 228
  - Automatic locking (switch) ..... 83
  - Central locking/unlocking (SmartKey) ..... 74
  - Control panel ..... 36
  - Display message ..... 258
  - Emergency locking ..... 84
  - Emergency unlocking ..... 83
  - Important safety notes ..... 82
  - Opening (from inside) ..... 82
- Drinking and driving** ..... 170
- Drinks holder**
  - see Cup holder
- Drive program**
  - Automatic ..... 157
  - Display ..... 153
  - Display (DIRECT SELECT lever) ..... 153
  - Manual ..... 158
  - SETUP (on-board computer) ..... 230
- Drive program selector** ..... 156
- Driver's door**
  - see Doors
- Driver's seat**
  - see Seats
- Driving abroad**
  - Mercedes-Benz Service ..... 313
  - Symmetrical low beam ..... 114
- Driving on flooded roads** ..... 173
- Driving safety systems**
  - ABS (Anti-lock Braking System) ..... 64
  - ADAPTIVE BRAKE ..... 69
  - BAS (Brake Assist System) ..... 64
  - BAS PLUS (Brake Assist System PLUS) ..... 64
  - Electronic brake force distribution ... 69
  - ESP® (Electronic Stability Program) ..... 66
  - ETS/4ETS (Electronic Traction System) ..... 66
  - Important safety information ..... 63
  - Overview ..... 63
  - PRE-SAFE® Brake ..... 69
- Driving systems**
  - Active Blind Spot Assist ..... 207
  - Active Driving Assistance package ..... 206
  - Active Lane Keeping Assist ..... 210
  - AIRMATIC ..... 189
  - AMG adaptive sport suspension system ..... 190
  - ATTENTION ASSIST ..... 199
  - Blind Spot Assist ..... 203
  - Cruise control ..... 175
  - Display message ..... 249
  - DISTRONIC PLUS ..... 177
  - HOLD function ..... 187
  - Lane Keeping Assist ..... 205
  - Lane Tracking package ..... 203
  - Night View Assist Plus ..... 200
  - Parking Guidance ..... 195
  - PARKTRONIC ..... 192
  - RACE START (AMG vehicles) ..... 188
  - Rear view camera ..... 198
- Driving tips**
  - AMG ceramic brakes ..... 173
  - Automatic transmission ..... 155
  - Brakes ..... 171

- Break-in period ..... 144
  - DISTRONIC PLUS ..... 185
  - Downhill gradient ..... 171
  - Drinking and driving ..... 170
  - Driving abroad ..... 114
  - Driving on flooded roads ..... 173
  - Driving on wet roads ..... 173
  - Exhaust check ..... 170
  - Fuel ..... 170
  - General ..... 169
  - Hydroplaning ..... 173
  - Icy road surfaces ..... 175
  - Limited braking efficiency on salted roads ..... 171
  - Pedals ..... 170
  - Snow chains ..... 174, 349
  - Symmetrical low beam ..... 114
  - Wet road surface ..... 171
  - DVD audio (on-board computer)** ..... 222
  - DVD-Video (on-board computer)** ..... 222
- E**
- EASY-ENTRY feature**
    - Activating/deactivating ..... 229
    - Function/notes ..... 108
  - EASY-EXIT feature**
    - Crash-responsive ..... 108
    - Function/notes ..... 108
    - Switching on/off ..... 229
  - EASY-PACK cargo compartment management system** ..... 284
  - EASY-PACK folding luggage-compartment floor** ..... 286
  - EASY-PACK load-securing kit** ..... 284
  - EASY-PACK rear sill protector** ..... 287
  - EBD (electronic brake force distribution)**
    - Display message ..... 236
    - Function/notes ..... 69
  - ECO start/stop function**
    - Deactivating/activating ..... 150
    - General information ..... 148
  - Electrical fuses**
    - see Fuses
  - Electronic brake force distribution**
    - see EBD (Electronic Brake force Distribution)
  - Electronic Stability Program**
    - see ESP® (Electronic Stability Program)
  - Electronic Traction System**
    - see ETS/4ETS (Electronic Traction System)
  - Emergency release**
    - Driver's door ..... 83
    - Fuel filler flap ..... 163
    - Trunk ..... 89
    - Vehicle ..... 83
  - Emergency spare wheel**
    - Storage location ..... 324
    - Stowing ..... 325
  - Emergency Tensioning Devices**
    - Function ..... 56
    - Safety guidelines ..... 39
  - Emergency unlocking**
    - Tailgate ..... 89
  - Emissions purification**
    - Service and warranty information .... 22
  - Engine**
    - Check Engine warning lamp ..... 267
    - Display message ..... 245
    - ECO start/stop function ..... 148
    - Emergency starting ..... 342
    - Engine number ..... 382
    - Irregular running ..... 151
    - Starting problems ..... 151
    - Starting the engine with the SmartKey ..... 147
    - Starting with KEYLESS-GO ..... 147
    - Switching off ..... 168
  - Engine electronics**
    - Problem (malfunction) ..... 151
  - Engine oil**
    - Adding ..... 310
    - Additives ..... 388
    - Checking the oil level ..... 309
    - Checking the oil level using the dipstick ..... 309
    - Display message ..... 247
    - Filling capacity ..... 384
    - Notes about oil grades ..... 387
    - Notes on oil level/consumption .... 309
    - Temperature (on-board computer) . 230
    - Viscosity ..... 388

- ESP® (Electronic Stability Program)**
- AMG menu (on-board computer) ... 230
  - Deactivating/activating (AMG vehicles) ..... 67
  - Deactivating/activating (except AMG vehicles) ..... 224
  - Deactivating/activating (notes; except AMG vehicles) ..... 66
  - Display message ..... 235
  - ETS/4ETS ..... 66
  - Function/notes ..... 66
  - Important safety information ..... 66
  - Warning lamp ..... 264
- ETS/4ETS (Electronic Traction System)** ..... 66
- Exhaust check** ..... 170
- Exhaust tail pipe (cleaning instructions)** ..... 318
- Exterior lighting**  
see Lights
- Exterior mirrors**
- Adjusting ..... 109
  - Dipping (automatic) ..... 110
  - Folding in/out (automatically) ..... 110
  - Folding in/out (electrically) ..... 109
  - Folding in when locking (on-board computer) ..... 230
  - Out of position (troubleshooting) ... 110
  - Setting ..... 110
  - Storing settings (memory function) ..... 111
  - Storing the parking position ..... 110
- Eyeglasses compartment** ..... 275
- F**
- Filler cap**  
see Fuel filler flap
- First-aid kit** ..... 322
- Flat tire**
- Changing a wheel/mounting the spare wheel ..... 329
  - MOExtended run-flat system ..... 334
  - Preparing the vehicle ..... 325
  - Raising the vehicle ..... 330
  - TIREFIT kit ..... 326
- Floormat** ..... 306
- Folding bench seat (cargo compartment)** ..... 103
- Front fog lamps** ..... 116
- Display message ..... 243
  - Switching on/off ..... 116
- Front windshield**  
see Windshield
- Fuel**
- Additives ..... 386
  - Consumption statistics ..... 219
  - Displaying the current consumption ..... 219
  - Displaying the range ..... 219
  - Driving tips ..... 170
  - Fuel gauge ..... 29
  - Important safety notes ..... 385
  - Premium-grade unleaded gasoline . 385
  - Problem (malfunction) ..... 164
  - Refueling ..... 160
  - Specifications ..... 385
  - Tank content/reserve fuel ..... 384
- Fuel filler flap**
- Emergency release ..... 163
  - Opening/closing ..... 162
- Fuel filter (display message)** ..... 248
- Fuel level**
- Calling up the range (on-board computer) ..... 219
- Fuel tank**
- Capacity ..... 384
  - Problem (malfunction) ..... 164
- Fuse allocation chart (vehicle tool kit)** ..... 322
- Fuses**
- Allocation chart ..... 343
  - Before changing ..... 343
  - Fuse box in the cargo compartment ..... 344
  - Fuse box in the engine compartment ..... 343
  - Fuse box in the trunk ..... 343
  - Important safety notes ..... 342
- G**
- Garage door opener**
- Clearing the memory ..... 305
  - Notes ..... 302



Opening/closing the garage door ..	304
Programming (button in the rear-view mirror) .....	302
<b>Gasoline</b> .....	161
<b>Gear indicator (on-board computer)</b> .....	230
<b>Gear or selector lever (cleaning guidelines)</b> .....	319
<b>Genuine Mercedes-Benz parts</b> .....	380
<b>Glove box</b> .....	274

## H

<b>Handbrake</b>	see Parking brake
<b>Hazard warning lamps</b> .....	118
<b>Headlamp cleaning system</b>	
Notes .....	389
<b>Headlamps</b>	
Adding fluid to cleaning system .....	311
Cleaning system (function) .....	117
Fogging up .....	120
see Automatic headlamp mode	
<b>Head restraints</b>	
Adjusting .....	100
Adjusting (angle) .....	100
Adjusting (electrically) .....	101
Adjusting (rear) .....	101
Installing/removing (rear) .....	102
Luxury .....	101
see NECK-PRO head restraints	
<b>Heating</b>	see Climate control
<b>High-beam headlamps</b>	
Changing bulbs .....	123
Display message .....	243
Switching Adaptive Highbeam Assist on/off .....	118
Switching on/off .....	117
<b>Hill start assist</b> .....	148
<b>HOLD function</b>	
Display message .....	250
Function/notes .....	187
<b>Hood</b>	
Closing .....	309
Display message .....	258
Opening .....	308
<b>Hydroplaning</b> .....	173

## I

<b>Ignition lock</b>	see Key positions
<b>Immobilizer</b> .....	71
<b>Indicator lamps</b>	see Warning and indicator lamps
<b>Indicators</b>	see Turn signals
<b>Infrared lamps (changing bulbs)</b> .....	123
<b>Insect protection on the radiator</b> ....	309
<b>Instrument cluster</b>	
Overview .....	29
Settings .....	226
Warning and indicator lamps .....	30
<b>Instrument cluster lighting</b> .....	29
<b>Instrument lighting</b>	see Instrument cluster lighting
<b>Interior lighting</b>	
Automatic control .....	120
Delayed switch-off (on-board computer) .....	228
Emergency lighting .....	121
Manual control .....	121
Overview .....	120
Reading lamp .....	120
Setting the brightness of the ambient lighting (on-board computer) .....	227
see Interior lighting	

## J

<b>Jack</b>	
Storage location .....	322
Using .....	330
<b>Jump starting (engine)</b> .....	338

## K

<b>Key</b>	see SmartKey
<b>KEYLESS-GO</b>	
Convenience closing feature .....	92
Display message .....	259
Locking .....	75
Start/Stop button .....	145
Starting the engine .....	147
Unlocking .....	75

**Key positions**

KEYLESS-GO .....	145
SmartKey .....	145

**Kickdown**

Driving tips .....	156
Manual drive program .....	159

<b>Knee bag</b> .....	42
-----------------------	----

**L****Lamps**

see Warning and indicator lamps

**Lane-change assistant**

see Blind Spot Assist

**Lane detection (automatic)**

see Lane Keeping Assist

**Lane Keeping Assist**

Activating/deactivating .....	225
Display message .....	250
Function/information .....	205

<b>Lane Tracking package</b> .....	203
------------------------------------	-----

<b>Lap time (RACETIMER)</b> .....	231
-----------------------------------	-----

**LATCH-type (ISOFIX) child seat**

<b>anchors</b> .....	59
----------------------	----

<b>License plate lamp (display message)</b> .....	243
---	-----

**Lighting**

see Lights

**Lights**

Activating/deactivating the interior lighting delayed switch-off ..	228
Automatic headlamp mode .....	116
Cornering light function .....	118
Display message .....	242
Driving abroad .....	114
Fog lamps .....	116
Hazard warning lamps .....	118
High beam flasher .....	117
High-beam headlamps .....	117
Light switch .....	114
Low-beam headlamps .....	115
Parking lamps .....	114
Rear fog lamp .....	116
Setting the brightness of the ambient lighting (on-board computer) .....	227
Switching Adaptive Highbeam Assist on/off .....	227

Switching the daytime running lamps on/off (on-board computer) .....	227
--	-----

Switching the daytime running lamps on/off (switch) .....	115
---	-----

Switching the exterior lighting delayed switch-off on/off (on-board computer) .....	227
---	-----

Switching the surround lighting on/off (on-board computer) .....	227
--	-----

Turn signals .....	117
--------------------	-----

see Changing bulbs

see Interior lighting

<b>Light sensor (display message)</b> .....	245
---	-----

**LIM indicator lamp**

Cruise control .....	176
DISTRONIC PLUS .....	180

<b>Loading guidelines</b> .....	274
---------------------------------	-----

**Locking**

see Central locking

**Locking (doors)**

Automatic .....	83
Emergency locking .....	84
From inside (central locking button) .....	82

**Locking centrally**

see Central locking

<b>Locking verification signal (on-board computer)</b> .....	228
--	-----

**Low-beam headlamps**

Changing bulbs .....	122
Display message .....	242
Setting for driving abroad (symmetrical) .....	114
Switching on/off .....	115

<b>Luggage holder (EASY-PACK load-securing kit)</b> .....	285
---	-----

**Lumbar support**

Adjusting the 4-way lumbar support .....	103
--	-----

<b>Luxury head restraints</b> .....	101
-------------------------------------	-----

**M**

<b>M+S tires</b> .....	174, 348
------------------------	----------

**Maintenance**

see ASSYST PLUS service interval display

- Malfunction message**  
see Display messages
- Malfunctions relevant to safety**  
Reporting ..... 25
- Massage function (PULSE)** ..... 103
- Matte finish (cleaning instructions)** ..... 316
- mbrace**  
Call priority ..... 300  
Display message ..... 237  
Downloading destinations (COMAND) ..... 300  
Emergency call ..... 297  
Important safety notes ..... 296  
Locating a stolen vehicle ..... 301  
MB info call button ..... 299  
Remote vehicle locking ..... 301  
Roadside Assistance button ..... 298  
Search & Send ..... 300  
Self-test ..... 296  
System ..... 296  
Vehicle remote unlocking ..... 300
- Mechanical key**  
Function/notes ..... 77  
Locking vehicle ..... 84  
Unlocking the driver's door ..... 83
- Memory card (audio)** ..... 222
- Memory function** ..... 111
- Message memory (on-board computer)** ..... 234
- Messages**  
see Display messages
- Mirrors**  
see Exterior mirrors  
see Rear-view mirror  
see Vanity mirror
- Mobile phone**  
Menu (on-board computer) ..... 222
- Modifying the programming (SmartKey)** ..... 77
- MOExtended run-flat system** ..... 334
- MP3**  
Operating ..... 222  
see separate operating instructions
- Multifunction display**  
Function/notes ..... 216  
Permanent display ..... 226
- Multifunction steering wheel**  
Operating the on-board computer . 215  
Overview ..... 31

## N

### Navigation

- Menu (on-board computer) ..... 220  
On-board computer ..... 220  
see separate operating instructions

### NECK-PRO head restraints

- Operation ..... 50  
Resetting after being triggered ..... 51

### Night View Assist Plus

- Activating/deactivating ..... 201  
Cleaning ..... 318  
Function/notes ..... 200  
Problem (malfunction) ..... 203

### Notes on breaking-in a new

- vehicle ..... 144

## O

### Occupant Classification System (OCS)

- Faults ..... 49  
Operation ..... 44  
System self-test ..... 47

### Occupant safety

- Children in the vehicle ..... 56  
System overview ..... 38

### Octane number (fuel)

- ..... 385

### Odometer

- see Trip odometer

### Oil

- see Engine oil

### On-board computer

- AMG menu ..... 230  
Assistance menu ..... 224  
Audio menu ..... 221  
Convenience submenu ..... 229  
Displaying a service message ..... 313  
Display messages ..... 234  
DISTRONIC PLUS ..... 183  
Factory settings submenu ..... 230  
Important safety notes ..... 214  
Instrument cluster submenu ..... 226  
Lighting submenu ..... 227

- Menu overview ..... 218
  - Message memory ..... 234
  - Navigation menu ..... 220
  - Operating video DVD ..... 222
  - Operation ..... 215
  - RACETIMER ..... 231
  - Service menu ..... 226
  - Settings menu ..... 226
  - Standard display ..... 219
  - Telephone menu ..... 222
  - Trip menu ..... 219
  - Vehicle submenu ..... 228
  - Operating system**  
see On-board computer
  - Outside temperature display** ..... 215
  - Overhead control panel** ..... 35
  - Override feature**  
Rear side windows ..... 62
- P**
- Paint code number** ..... 381
  - Paintwork (cleaning instructions)** ... 316
  - Panic alarm** ..... 62
  - Panorama roof with power tilt/  
sliding panel**  
Opening/closing ..... 94  
Opening/closing the roller  
sunblind ..... 95  
Problem (malfunction) ..... 96  
Resetting ..... 95
  - Panorama sliding sunroof**  
Important safety notes ..... 93
  - Parcel net** ..... 277
  - Parking** ..... 167  
Important safety notes ..... 167  
Parking brake ..... 169  
Position of exterior mirror, front-  
passenger side ..... 110  
Rear view camera ..... 198  
see PARKTRONIC
  - Parking aid**  
Parking Guidance ..... 195  
see Exterior mirrors  
see PARKTRONIC
  - Parking brake**  
Display message ..... 237  
Notes/function ..... 169
  - Parking Guidance**  
Display message ..... 251  
Important safety notes ..... 195
  - Parking lamps (changing bulbs)** ..... 123
  - PARKTRONIC**  
Deactivating/activating ..... 194  
Driving system ..... 192  
Function/notes ..... 192  
Problem (malfunction) ..... 195  
Range of the sensors ..... 193  
Warning display ..... 193
  - PASSENGER AIRBAG OFF indicator  
lamp** ..... 44
  - Pedals** ..... 170
  - Permanent four-wheel drive**  
see 4MATIC (permanent four-  
wheel drive)
  - Plastic hooks** ..... 281
  - Plastic trim (cleaning instructions)** . 319
  - Power washers** ..... 315
  - Power windows**  
see Side windows
  - PRE-SAFE® (Preventive occupant  
safety system)**  
Display message ..... 237  
Operation ..... 50
  - PRE-SAFE® Brake (vehicles with  
DISTRONIC PLUS)**  
Display message ..... 238  
Function/notes ..... 69  
Switching on/off ..... 225  
Warning lamp ..... 270
  - Preventive occupant safety  
system**  
see PRE-SAFE® (Preventive  
occupant safety system)
  - Product information** ..... 22
  - Program selector button** ..... 156
  - Pulling away**  
Automatic transmission ..... 147
- Q**
- Qualified specialist workshop** ..... 25

## R

- RACE START (AMG vehicles)** ..... 188
- RACETIMER (on-board computer)** .... 231
- Radar sensor system**
  - Activating/deactivating ..... 229
  - Display message ..... 250
- Radiator cover** ..... 309
- Radio**
  - Selecting a station ..... 221
  - see separate operating instructions
- Reading lamp** ..... 120
- Rear axle level control (AMG adaptive sport suspension system)** ..... 191
- Rear compartment**
  - Setting the airflow ..... 137
  - Setting the air vents ..... 141
  - Setting the temperature ..... 136
- Rear fog lamp**
  - Display message ..... 244
  - Switching on/off ..... 116
- Rear seat**
  - Display message ..... 258
  - Folding the backrest forwards/back ..... 279
- Rear sill protector** ..... 287
- Rear view camera**
  - Cleaning instructions ..... 318
  - Function/notes ..... 198
- Rear-view mirror**
  - Anti-glare (manual) ..... 109
  - Dipping (automatic) ..... 110
- Rear window blind** ..... 292
- Rear window defroster**
  - Problem (malfunction) ..... 139
- Rear window heating**
  - Switching on/off ..... 139
- Rear window wiper**
  - Replacing the wiper blade ..... 126
  - Switching on/off ..... 125
- Refueling**
  - Fuel gauge ..... 29
  - Important safety notes ..... 160
  - Refueling process ..... 162
  - see Fuel
- Remote control**
  - Garage door opener ..... 302
- Reporting**
  - Malfunctions relevant to safety ..... 25
- Reserve (fuel tank)**
  - see Fuel
- Reserve fuel**
  - Display message ..... 248
  - Warning lamp ..... 267
  - see Fuel
- Residual heat (climate control)** ..... 140
- Restraint system**
  - see SRS (Supplemental Restraint System)
- Retaining hook** ..... 282
- Reverse gear**
  - Engaging (automatic transmission) ..... 152
- Reversing lamps (display message)** ..... 244
- Roadside Assistance (breakdown)** .... 23
- Roller blind**
  - see Roller sunblind
- Roller sunblind**
  - Panorama roof with power tilt/sliding panel ..... 95
  - Rear side windows ..... 291
  - Rear window ..... 292
- Roof carrier** ..... 288
- Roof lining and carpets (cleaning guidelines)** ..... 320
- Roof load (maximum)** ..... 390
- Route**
  - see Route guidance (navigation)
- Route guidance (navigation)** ..... 220

## S

- Safety**
  - Children in the vehicle ..... 56
  - Child restraint systems ..... 56
  - Occupant Classification System (OCS) ..... 44
  - Overview of occupant safety systems ..... 38
- Safety systems**
  - see Driving safety systems

- Seat belts**
- Adjusting the driver's and front-passenger seat belt ..... 54
  - Adjusting the height ..... 54
  - Belt force limiters ..... 56
  - center rear-compartment seat ..... 55
  - Cleaning ..... 320
  - Correct usage ..... 52
  - Emergency Tensioning Devices ..... 56
  - Fastening ..... 53
  - Important safety guidelines ..... 51
  - Releasing ..... 55
  - Safety guidelines ..... 39
  - Special seat belt retractor ..... 59
  - Switching belt adjustment on/off (on-board computer) ..... 229
  - Warning lamp ..... 261
  - Warning lamp (function) ..... 55
- Seats**
- Active multicontour seat ..... 102
  - Adjusting (electrically) ..... 100
  - Adjusting the 4-way lumbar support ..... 103
  - Adjusting the head restraint ..... 100
  - Cleaning the cover ..... 320
  - Correct driver's seat position ..... 98
  - Folding the backrest (rear compartment) forwards/back ..... 280
  - Important safety notes ..... 99
  - Seat heating problem ..... 106
  - Seat ventilation problem ..... 106
  - Storing settings (memory function) ..... 111
  - Switching seat heating on/off ..... 105
  - Switching seat ventilation on/off .. 106
- Sensors (cleaning instructions)** ..... 317
- Service**
- see ASSYST PLUS service interval display
- Service interval display**
- Displaying service messages ..... 313
  - Hiding service messages ..... 313
  - Notes ..... 313
  - Service messages ..... 312
- Service menu (on-board computer)** . 226
- Service products**
- Brake fluid ..... 388
  - Capacities ..... 384
  - Coolant (engine) ..... 389
  - DEF special additives ..... 387
  - Engine oil ..... 387
  - Fuel ..... 385
  - Important safety notes ..... 382
  - Refrigerant (air-conditioning system) ..... 388
  - Washer fluid ..... 389
- Settings**
- Factory (on-board computer) ..... 230
  - On-board computer ..... 226
- Setting the air distribution** ..... 137
- Setting the airflow** ..... 137
- SETUP (on-board computer)** ..... 230
- Side impact air bag** ..... 42
- Side marker lamp (display message)** ..... 244
- Side windows**
- Convenience closing feature ..... 91
  - Convenience opening feature ..... 91
  - Important safety information ..... 90
  - Opening/closing ..... 90
  - Problem (malfunction) ..... 92
  - Resetting ..... 92
- Skibag** ..... 277
- Sliding sunroof**
- Important safety notes ..... 93
  - Opening/closing ..... 94
  - Problem (malfunction) ..... 96
  - Resetting ..... 94
  - see Panorama roof with power tilt/sliding panel
- SmartKey**
- Changing the battery ..... 78
  - Changing the programming ..... 77
  - Checking the battery ..... 78
  - Convenience closing feature ..... 91
  - Convenience opening feature ..... 91
  - Display message ..... 259
  - Door central locking/unlocking ..... 74
  - Important safety notes ..... 74
  - Loss ..... 80
  - Mechanical key ..... 77
  - Positions (ignition lock) ..... 145
  - Problem (malfunction) ..... 80
  - Starting the engine ..... 147
- Snow chains** ..... 174, 349

- Sockets**
  - Center console ..... 294
  - Luggage compartment ..... 295
  - Points to observe before use ..... 294
  - Rear compartment ..... 294
- Spare wheel**
  - Notes/data ..... 373
  - Storage location ..... 324
  - Stowing ..... 325
  - see Emergency spare wheel
- Specialist workshop** ..... 25
- Speed, controlling**
  - see Cruise control
- Speedometer**
  - Digital ..... 219
  - In the Instrument cluster ..... 29
  - Segments ..... 215
  - Selecting the unit of measurement ..... 226
  - see Instrument cluster
- SPORT handling mode**
  - Activating/deactivating (AMG vehicles) ..... 67
  - Warning lamp ..... 265
- SRS (Supplemental Restraint System)**
  - Display message ..... 238
  - Introduction ..... 38
  - Warning lamp ..... 266
  - Warning lamp (function) ..... 38
- Standing lamps**
  - Changing bulbs ..... 123
  - Display message ..... 244
  - Switching on/off ..... 114
- Starting (engine)** ..... 146
- Station**
  - see Radio
- Steering (display message)** ..... 259
- Steering wheel**
  - Adjusting (electrically) ..... 107
  - Button overview ..... 31
  - Buttons (on-board computer) ..... 215
  - Important safety notes ..... 107
  - Paddle shifters ..... 157
  - Steering wheel heating ..... 107
  - Storing settings (memory function) ..... 111
- Steering wheel (cleaning instructions)** ..... 319
- Steering wheel heating**
  - Problem (malfunction) ..... 107
  - Switching on/off ..... 107
- Steering wheel paddle shifters** ..... 157
- Stopwatch (RACETIMER)** ..... 231
- Stowage compartments**
  - Armrest (under) ..... 275
  - Cup holders ..... 289
  - Eyeglasses compartment ..... 275
  - Glove box ..... 274
  - Important safety information ..... 274
  - Parcel net ..... 277
  - Rear ..... 276
- Stowage space**
  - Center console ..... 275
- Stowage well beneath the trunk floor** ..... 286
- Summer opening**
  - see Convenience opening feature
- Summer tires** ..... 348
- Sun visor** ..... 290
- Supplemental Restraint System**
  - see SRS (Supplemental Restraint System)
- Surround lighting (on-board computer)** ..... 227
- Suspension tuning**
  - AIRMATIC ..... 190
  - AMG adaptive sport suspension system ..... 191
  - SETUP (on-board computer) ..... 230
- Switching air-recirculation mode on/off** ..... 139
- Switching off the alarm (ATA)** ..... 72

## T

- Tachometer** ..... 215
- Tailgate**
  - Display message ..... 258
  - Emergency unlocking ..... 89
  - Important safety notes ..... 84
  - Limiting the opening angle ..... 88
  - Opening/closing ..... 85

- Opening/closing (automatically from inside) ..... 87
- Opening/closing (automatically from outside) ..... 86
- Tail lamps**
  - Display message ..... 243
- Tank**
  - see Fuel tank
- Tank content**
  - Fuel gauge ..... 29
- Technical data**
  - Notes ..... 380
  - Tires/wheels ..... 371
  - Vehicle data ..... 390
- TELEAID**
  - Call priority ..... 300
  - Display message ..... 237
  - Downloading destinations (COMAND) ..... 300
  - Emergency call ..... 297
  - Important safety notes ..... 296
  - Locating a stolen vehicle ..... 301
  - MB info call button ..... 299
  - Remote vehicle locking ..... 301
  - Roadside Assistance button ..... 298
  - Search & Send ..... 300
  - Self-test ..... 296
  - System ..... 296
  - Vehicle remote unlocking ..... 300
- Telephone**
  - Accepting a call ..... 223
  - Display message ..... 259
  - Menu (on-board computer) ..... 222
  - Number from the phone book ..... 223
  - Redialing ..... 223
  - Rejecting/ending a call ..... 223
- Telescopic rod (EASY-PACK load-securing kit) ..... 286**
- Temperature**
  - Coolant ..... 214
  - Coolant (on-board computer) ..... 230
  - Engine oil (on-board computer) ..... 230
  - Outside temperature ..... 215
  - Setting (climate control) ..... 136
- Theft deterrent locking system**
  - Immobilizer ..... 71
- Through-loading ..... 278**
- Through-loading feature ..... 279**
- Tilt/sliding sunroof**
  - see Sliding sunroof
- Timing (RACETIMER) ..... 231**
- Tiredness assistant**
  - see ATTENTION ASSIST
- TIREFIT kit ..... 326**
- Tire pressure**
  - Calling up (on-board computer) ..... 355
  - Checking manually ..... 353
  - Display message ..... 254
  - Maximum ..... 352
  - Notes ..... 351
  - Not reached (TIREFIT) ..... 327
  - Pressure loss warning ..... 353
  - Reached (TIREFIT) ..... 328
  - Recommended ..... 349
- Tire pressure monitoring system**
  - Function/notes ..... 355
  - Restarting ..... 357
  - Warning lamp ..... 271
- Tires**
  - Aspect ratio (definition) ..... 369
  - Average weight of the vehicle occupants (definition) ..... 368
  - Bar (definition) ..... 367
  - Characteristics ..... 367
  - Checking ..... 347
  - Definition of terms ..... 367
  - Direction of rotation ..... 371
  - Display message ..... 254
  - Distribution of the vehicle occupants (definition) ..... 370
  - DOT, Tire Identification Number (TIN) ..... 366
  - DOT (Department of Transportation) (definition) ..... 367
  - GAWR (Gross Axle Weight Rating) (definition) ..... 368
  - GVW (Gross Vehicle Weight) (definition) ..... 368
  - GVWR (Gross Vehicle Weight Rating) (definition) ..... 368
  - Important safety notes ..... 346
  - Increased vehicle weight due to optional equipment (definition) ..... 368
  - Kilopascal (kPa) (definition) ..... 369
  - Labeling (overview) ..... 363
  - Load bearing index (definition) ..... 370



- Load index ..... 366
  - Load index (definition) ..... 369
  - Maximum loaded vehicle weight (definition) ..... 368
  - Maximum load on a tire (definition) ..... 369
  - Maximum permissible tire pressure (definition) ..... 369
  - Maximum tire load ..... 361
  - Maximum tire load (definition) ..... 369
  - Optional equipment weight (definition) ..... 369
  - PSI (pounds per square inch) (definition) ..... 369
  - Replacing ..... 370
  - Service life ..... 347
  - Sidewall (definition) ..... 369
  - Speed rating (definition) ..... 368
  - Storing ..... 371
  - Structure and characteristics (definition) ..... 367
  - Temperature ..... 363
  - TIN (Tire Identification Number) (definition) ..... 370
  - Tire bead (definition) ..... 369
  - Tire pressure (definition) ..... 369
  - Tire pressures (recommended) ..... 368
  - Tire size (data) ..... 371
  - Tire size designation, load-bearing capacity, speed rating ..... 364
  - Tire tread ..... 347
  - Tire tread (definition) ..... 369
  - Total load limit (definition) ..... 370
  - Traction ..... 362
  - Traction (definition) ..... 370
  - Tread wear ..... 362
  - Uniform Tire Quality Grading Standards ..... 362
  - Uniform Tire Quality Grading Standards (definition) ..... 368
  - Unladen weight (definition) ..... 369
  - Wear indicator (definition) ..... 370
  - Wheel rim (definition) ..... 368
  - see Flat tire
  - Top Tether** ..... 60
  - Towing**
    - Important safety guidelines ..... 340
    - Installing the towing eye ..... 340
    - Removing the towing eye ..... 341
    - With the rear axle raised ..... 341
  - Towing away**
    - With both axles on the ground ..... 341
  - Tow-starting**
    - Emergency engine starting ..... 342
    - Important safety notes ..... 340
  - Transmission**
    - see Automatic transmission
  - Transporting the vehicle** ..... 342
  - Trim pieces (cleaning instructions)** . 319
  - Trip computer (on-board computer)** ..... 219
  - Trip meter**
    - see Trip odometer
  - Trip odometer**
    - Calling up ..... 219
    - Resetting (on-board computer) ..... 220
  - Trunk**
    - Emergency release ..... 89
    - Important safety guidelines ..... 84
    - Locking separately ..... 88
    - Opening/closing (automatically from inside) ..... 87
    - Opening/closing (automatically from outside) ..... 86
  - Trunk lid**
    - Display message ..... 258
    - Opening/closing ..... 84
  - Turn signals**
    - Changing bulbs (front) ..... 124
    - Display message ..... 242
    - Switching on/off ..... 117
  - Type identification plate**
    - see Vehicle identification plate
- U
- Unlocking**
    - Emergency unlocking ..... 83
    - From inside the vehicle (central unlocking button) ..... 82

## V

**Vanity mirror (in sun visor)** ..... 291

**Vehicle**

Correct use ..... 25  
 Data acquisition ..... 26  
 Display message ..... 257  
 Equipment ..... 22  
 Individual settings ..... 226  
 Limited Warranty ..... 26  
 Loading ..... 358  
 Locking (in an emergency) ..... 84  
 Locking (SmartKey) ..... 75  
 Lowering ..... 333  
 Maintenance ..... 23  
 Parking for a long period ..... 169  
 Pulling away ..... 147  
 Raising ..... 330  
 Reporting problems ..... 25  
 Towing away ..... 340  
 Transporting ..... 342  
 Unlocking (in an emergency) ..... 83  
 Unlocking (SmartKey) ..... 75  
 Vehicle data ..... 390

**Vehicle battery**

see Battery (vehicle)

**Vehicle data** ..... 390

see Technical data

**Vehicle dimensions** ..... 390

**Vehicle emergency locking** ..... 84

**Vehicle identification number**

see VIN

**Vehicle identification plate** ..... 381

**Vehicle level**

AIRMATIC ..... 189

**Vehicle level (display message)** ..... 249

**Vehicle tool kit** ..... 322

**Video (DVD)** ..... 222

**VIN** ..... 381

## W

**Warning and indicator lamps**

ABS ..... 264  
 Brakes ..... 263  
 Check Engine ..... 267  
 Coolant ..... 268  
 Cruise control ..... 176

Distance warning ..... 270

DISTRONIC PLUS ..... 270

ESP® ..... 264

ESP® OFF ..... 265

Fuel tank ..... 267

LIM (DISTRONIC PLUS) ..... 180

Overview ..... 30

**PASSENGER AIRBAG OFF**

indicator lamp ..... 44

Reserve fuel ..... 267

Seat belt ..... 261

SPORT handling mode ..... 265

SRS ..... 266

Tire pressure monitor ..... 271

**Warranty** ..... 381

**Washer fluid**

Display message ..... 259

see Windshield washer system

**Wheel bolt tightening torque** ..... 333

**Wheel check** ..... 329

**Wheels**

Changing a wheel ..... 329

Checking ..... 347

Cleaning ..... 315

Important safety notes ..... 346

Interchanging/changing ..... 370

Mounting a wheel ..... 332

Removing a wheel ..... 331

Storing ..... 371

Tightening torque ..... 333

Wheel size/tire size ..... 371

**Window curtain air bag**

Display message ..... 239

Operation ..... 44

**Windows**

Cleaning ..... 317

see Side windows

**Windshield**

Defrosting ..... 138

**Windshield washer system** ..... 311

Notes ..... 389

**Windshield wipers**

Problem (malfunction) ..... 126

Rear window wiper ..... 125

Replacing the wiper blades ..... 125

Switching on/off ..... 124

**Winter driving**

- Important safety notes ..... 348
- Slippery road surfaces ..... 175
- Snow chains ..... 174, 349

**Winter operation**

- Radiator cover ..... 309

**Winter tires**

- M+S tires ..... 174, 348

**Wiper blades**

- Cleaning ..... 317
- Important safety notes ..... 125
- Replacing (rear window) ..... 126
- Replacing (windshield) ..... 125

**Wooden trim (cleaning**

- instructions) ..... 319

## Product information

Mercedes-Benz recommends that you use genuine Mercedes-Benz parts, conversion parts and accessories that have been approved for the type of vehicle.

Mercedes-Benz tests genuine parts as well as conversion parts and accessories which have been specifically approved for your vehicle for their reliability, safety and suitability. Despite ongoing market research, Mercedes-Benz is unable to assess other parts. Therefore, Mercedes-Benz accepts no responsibility for the use of such parts in Mercedes-Benz vehicles, even if they have been independently or officially approved. The use of non-approved parts could affect your vehicle's operating safety. Mercedes-Benz therefore recommends that you use genuine Mercedes-Benz parts, conversion parts and accessories that have been approved for the type of vehicle. Genuine Mercedes-Benz parts, approved conversion parts and accessories are available from any authorized Mercedes-Benz Center. Here, you will receive advice about permissible technical modifications, and the parts will be professionally installed.

## Operator's Manual

### Notes on the Operator's Manual

This Operator's Manual contains a great deal of helpful information. We urge you to read it carefully and familiarize yourself with the vehicle before driving.

For your own safety and longer service life of the vehicle, we urge you to follow the instructions and warnings contained in this Operator's Manual. Ignoring them could result in damage to the vehicle or personal injury to you or others. Vehicle damage caused by failure to follow instructions is not covered by the Mercedes-Benz Limited Warranty.

## Vehicle equipment

This Operator's Manual describes all models and all standard and optional equipment of your vehicle available at the time of publication of the Operator's Manual. Country-specific differences are possible. Please note that your vehicle may not be equipped with all features described. This also applies to safety-related systems and functions. The equipment in your vehicle may therefore differ from that shown in the descriptions and illustrations. All the systems found in your vehicle are listed in the original purchase agreement of your vehicle. Should you have any questions concerning equipment and operation, please consult an authorized Mercedes-Benz Center.

The Operating Instructions and the Maintenance Booklet are important documents and should be kept in the vehicle.

## Service and vehicle operation

### Service and literature

Your vehicle is covered under the terms of the warranties printed in the Service and Warranty Information booklet. Your authorized Mercedes-Benz Center will exchange or repair any defective parts originally installed in the vehicle in accordance with the terms of the following warranties:

- New Vehicle Limited Warranty
- Emission Systems Warranty
- Emission Performance Warranty
- California, Connecticut, Maine, Massachusetts, New York, Pennsylvania, Rhode Island and Vermont Emission Control Systems Warranty
- State Warranty Enforcement Laws (Lemon Laws)

## Information for customers in California

Under California law you may be entitled to a replacement of your vehicle or a refund of the purchase price or lease price, if after a reasonable number of repair attempts Mercedes-Benz USA, LLC and/or its authorized repair or service facilities fail to fix one or more substantial defects or malfunctions in the vehicle that are covered by its express warranty. During the period of 18 months from original delivery of the vehicle or the accumulation of 18 000 miles (approximately 29 000 km) on the odometer of the vehicle, whichever occurs first, a reasonable number of repair attempts is presumed for a retail buyer or lessee if one or more of the following occurs:

- (1) the same substantial defect or malfunction results in a condition that is likely to cause death or serious bodily injury if the vehicle is driven, that defect or malfunction has been subject to repair two or more times, and you have directly notified Mercedes-Benz USA, LLC in writing of the need for its repair.
- (2) the same substantial defect or malfunction of a less serious nature than category (1) has been subject to repair four or more times and you have directly notified Mercedes-Benz in writing of the need for its repair.
- (3) the vehicle is out of service by reason of repair of the same or different substantial defects or malfunctions for a cumulative total of more than 30 calendar days.

Please send your written notice to:  
 Mercedes-Benz USA, LLC  
 Customer Assistance Center  
 One Mercedes Drive  
 Montvale, NJ 07645-0350

## Maintenance

The Service and Warranty Booklet describes all the necessary maintenance work which should be done at regular intervals.

Always have the Service and Warranty Booklet with you when you bring the vehicle to an authorized Mercedes-Benz Center. The service advisor will record every service for you in the Service and Warranty Booklet.

## Roadside Assistance

The Mercedes-Benz Roadside Assistance Program offers technical help in the event of a breakdown. Calls to the toll-free Roadside Assistance Hotline are answered by our agents 24 hours a day, 365 days a year.

**1-800-FOR-MERCEdes(1-800-367-6372) (USA)**

**1-800-387-0100 (Canada)**

For additional information, refer to the Mercedes-Benz Roadside Assistance Program brochure (USA) or the "Roadside Assistance" section in the Service and Warranty booklet (Canada). You will find both in your vehicle literature portfolio.

## Change of address or change of ownership

In the event of a change of address, please send us the "Change of Address Notice" found in the Service and Warranty Information Booklet, or simply call the Mercedes-Benz Customer Assistance Center (in the USA) at the hotline number 1-800-FOR-MERCEdes(1-800-367-6372) or Customer Service Center (in Canada) at 1-800-387-0100. This will assist us in contacting you in a timely manner should the need arise.

If you sell your Mercedes, please leave the entire literature in the vehicle so that it is available to the next owner.

If you bought this vehicle used, be sure to send in the "Notice of Purchase of Used Car" found in the Service and Warranty Information Booklet, or call the Mercedes-Benz Customer Assistance Center (in the USA) at 1-800-FOR-MERCEdes(1-800-367-6372) or Customer Service (in Canada) at 1-800-387-0100.

### Vehicle operation outside the USA and Canada

If you plan to operate your vehicle in foreign countries, please be aware that:

- service facilities or replacement parts may not be readily available.
- unleaded fuel for vehicles with a catalytic converter may not be available. Leaded fuel may cause damage to the catalytic converter.
- the fuel may have a considerably lower octane rating. Unsuitable fuel can cause engine damage.

Some Mercedes-Benz models are available for delivery in Europe through our European Delivery Program. For details, consult an authorized Mercedes-Benz Center or write to one of the following addresses.

#### In the USA

Mercedes-Benz USA, LLC  
European Delivery Department  
One Mercedes Drive  
Montvale, NJ 07645-0350

#### In Canada

Mercedes-Benz Canada, Inc.  
European Delivery Department  
98 Vanderhoof Avenue  
Toronto, Ontario M4G 4C9

## Operating safety

### Safety notes

#### WARNING

Work improperly carried out on electronic components and associated software could cause them to cease functioning. Because the vehicle's electronic components are interconnected, any modifications made may produce an undesired effect on other systems. Electronic malfunctions could seriously impair the operating safety of your vehicle.

Contact an authorized Mercedes-Benz Center for repairs or modifications to electronic components.

Other improper work or modifications on the vehicle could also have a negative impact on the operating safety of the vehicle.

Some safety systems only function when the engine is running. You should therefore never turn off the engine while driving.

#### WARNING

Heavy blows against the vehicle underbody or tires/wheels may cause serious damage and impair the operating safety of your vehicle. Such blows can be caused, for example, by running over an obstacle, road debris or a pothole.

If you feel a sudden significant vibration or ride disturbance, or you suspect that damage to your vehicle has occurred:

- turn on your hazard warning flashers.
- slow down carefully.
- drive with caution to an area which is a safe distance from the road.

Inspect the vehicle underbody and tires/wheels for possible damage. If the vehicle appears unsafe, have it towed to the nearest authorized Mercedes-Benz Center or other qualified maintenance or repair facility for further inspection or repairs.

### Qualified specialist workshop

An authorized Mercedes-Benz Center is a qualified specialist workshop. It has the necessary specialist knowledge, tools and qualifications to correctly carry out the work required on your vehicle. This is especially the case for work relevant to safety.

Observe the notes in the service booklet.

Always have the following work carried out at an authorized Mercedes-Benz Center:

- work relevant to safety
- service and maintenance work
- repair work
- alterations, installation work and modifications
- work on electronic components

### Proper use

#### **WARNING**

There are various warning stickers affixed to your vehicle. Their purpose is to alert you and others to various dangers. Therefore, do not remove any warning stickers unless the sticker clearly states that you may do so.

If you remove any warning stickers, you or others could fail to recognize certain dangers and be injured.

The proper use of the vehicle requires that you familiarize yourself with the following information and rules:

- safety notes in this Operator's Manual
- technical data in this Operator's Manual
- traffic rules and regulations
- laws and safety standards pertaining to motor vehicles

### Problems with your vehicle

If you should experience a problem with your vehicle, particularly one that you believe may affect its safe operation, we urge you to

contact an authorized Mercedes-Benz Center immediately to have the problem diagnosed and rectified. If the problem is not resolved to your satisfaction, please discuss the problem again with a Mercedes-Benz Center or contact us at one of the following addresses.

### In the USA

Customer Assistance Center  
Mercedes-Benz USA, LLC  
One Mercedes Drive  
Montvale, NJ 07645-0350

### In Canada

Customer Relations Department  
Mercedes-Benz Canada, Inc.  
98 Vanderhoof Avenue  
Toronto, Ontario M4G 4C9

### Reporting malfunctions relevant to safety

For the USA only:

The following text is reproduced as required of all manufacturers according to Title 49, Code of U.S. Federal Regulations, Part 575 pursuant to the National Traffic and Motor Vehicle Safety Act of 1966.

### Reporting safety defects

If you believe that your vehicle has a defect which could cause a crash or could cause injury or death, you should immediately inform the National Highway Traffic Safety Administration (NHTSA) in addition to notifying Mercedes-Benz USA, LLC.

If NHTSA receives similar complaints, it may open an investigation, and if it finds that a safety defect exists in a group of vehicles, it may order a recall and remedy campaign. However, NHTSA cannot become involved in individual problems between you, your dealer, or Mercedes-Benz USA, LLC.

To contact NHTSA, you may call the Vehicle Safety Hotline toll-free at 1-888-327-4236 (TTY: 1-800-424-9153); go to: <http://www.safercar.gov>; or write to: Administrator, NHTSA Headquarters, 1200 New Jersey Avenue, SE, West Building, Washington, DC 20590.

You can also obtain additional information about vehicle safety from:

<http://www.safercar.gov>.

- for use in arbitration of disputes that involve Daimler AG, its affiliates or its sales and service organizations
- as otherwise required or permitted by law.

Please observe the mbrace<sup>1</sup> purchase agreement for further details on the recording and transfer of data by this system.

### Limited Warranty

**!** Follow the instructions in this manual about the proper operation of your vehicle as well as about possible vehicle damage. Damage to your vehicle that arises from culpable contraventions against these instructions are not covered either by Mercedes-Benz Limited Warranty or by the New or Used-Vehicle Warranty of Daimler AG.

### Data stored in the vehicle

#### Information about electronic data acquisition in the vehicle

(Including notice pursuant to California Code § 9951)

Your vehicle records electronic data. If your vehicle is equipped with mbrace<sup>1</sup>, data is transmitted in the event of an accident.

This information helps, for example, to test vehicle systems after an accident and to continually improve vehicle safety.

Daimler AG can access this data and submit it:

- for safety research or vehicle diagnosis purposes
- with the consent of the vehicle owner
- on the instruction of prosecuting authorities

<sup>1</sup> The system is called TELE AID in Canada.



Cockpit .....	28
Instrument cluster .....	29
Multifunction steering wheel .....	31
Center console .....	32
Overhead control panel .....	35
Door control panel .....	36

## Cockpit

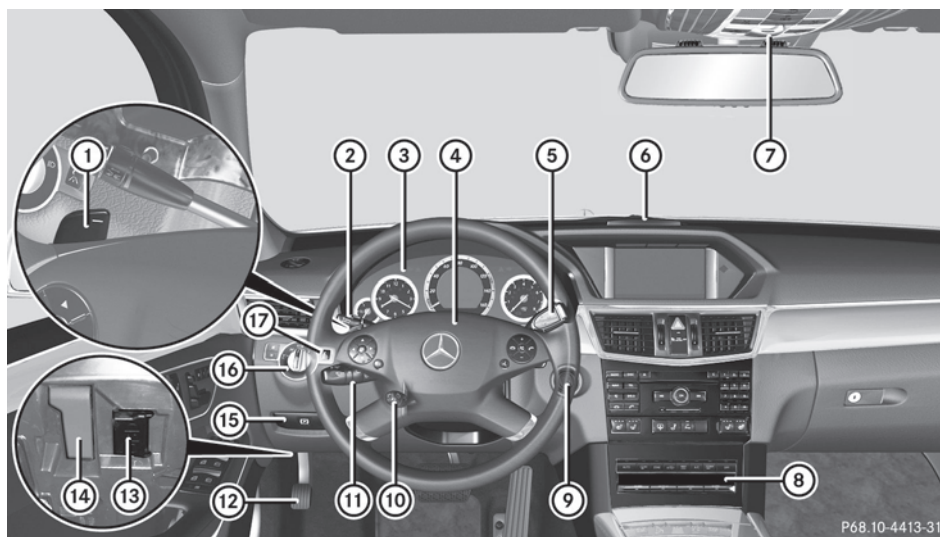

P68.10-4413-31

	Function	Page
①	Steering wheel paddle shifters	157
②	Cruise control lever	176
③	Instrument cluster	29
④	Horn	
⑤	DIRECT SELECT lever	153
⑥	PARKTRONIC warning display	192
⑦	Overhead control panel	35
⑧	Climate control systems	130
⑨	Ignition lock Start/Stop button	145 145

	Function	Page
⑩	Adjusts the steering wheel electrically Steering wheel heating	107 107
⑪	Combination switch	117
⑫	Parking brake	169
⑬	On-board diagnostics socket	
⑭	Opens the hood	308
⑮	Releases the parking brake	169
⑯	Light switch	114
⑰	Night View Assist Plus	200

## Instrument cluster

## Displays and controls

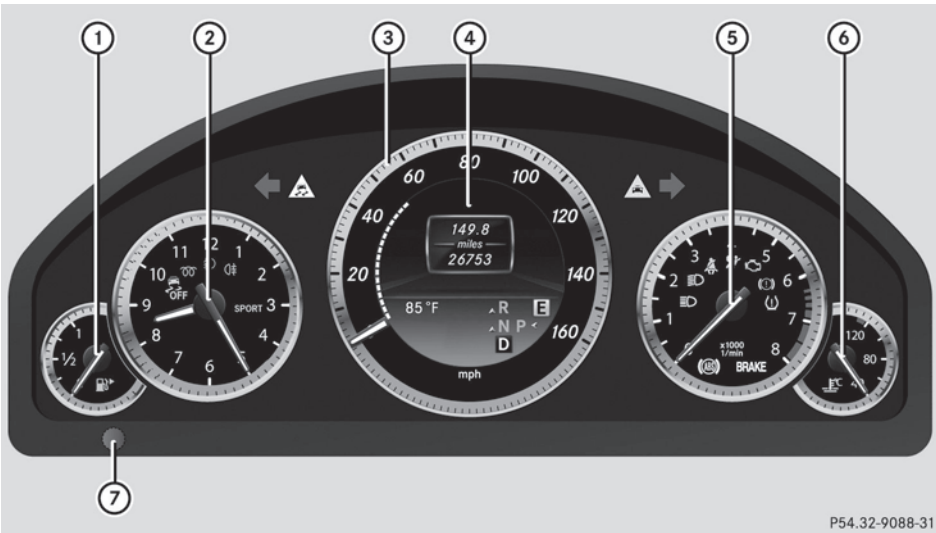

P54.32-9088-31

	Function	Page
①	Fuel gauge	
②	Clock	
③	Speedometer with segments	215
④	Multifunction display	216
⑤	Tachometer	215

	Function	Page
⑥	Coolant temperature	214
⑦	Instrument cluster lighting brightness control: turn clockwise or counter-clockwise	

## Warning and indicator lamps

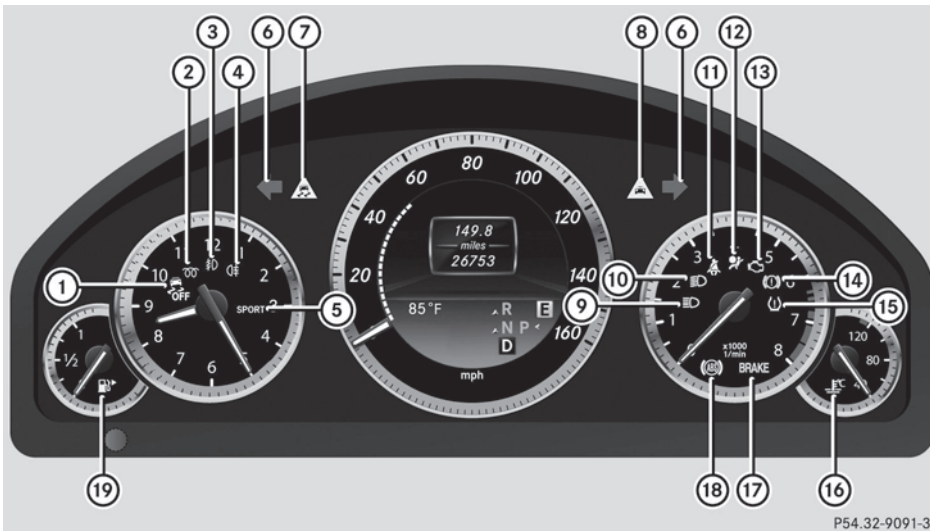

P54.32-9091-31

	Function	Page
①	ESP® OFF	264
②	Diesel engine: preglow	147
③	Front fog lamps	116
④	Rear fog lamp	116
⑤	SPORT handling mode in AMG vehicles	265
⑥	Turn signal	117
⑦	ESP®	264
⑧	Distance warning	270
⑨	High-beam headlamps	117
⑩	Low-beam headlamps	115





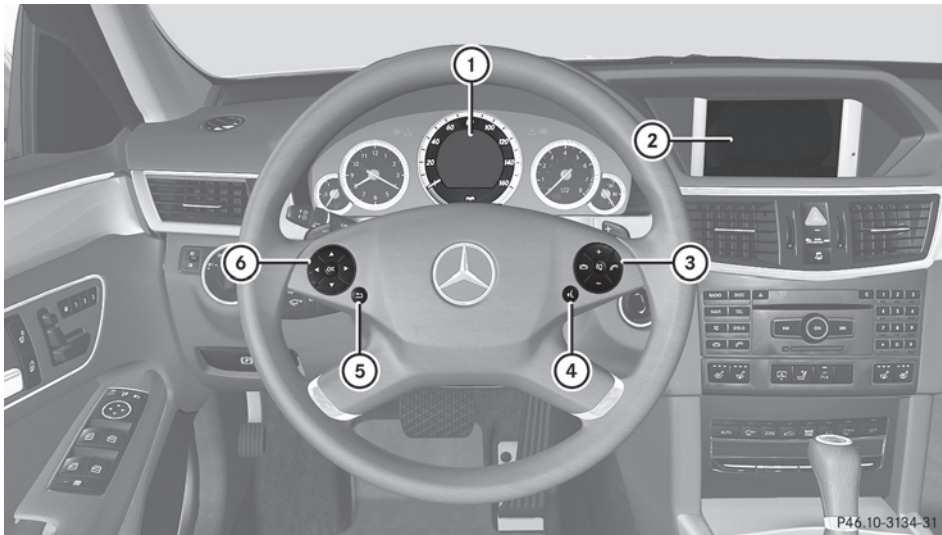

	Function	Page
⑪	Seat belt	261
⑫	SRS	266
⑬	Check engine	267
⑭	Brakes (Canada only)	263
⑮	Tire pressure monitor	271
⑯	Coolant	268
⑰	Brakes (USA only)	263
⑱	ABS	264
⑲	Reserve fuel	267







Multifunction steering wheel



At a glance

P46.10-3134-31

	Function	Page
①	Multifunction display	216
②	COMAND; see the separate operating instructions	
③	 Rejects or ends a call Exits phone book/redial memory  Makes or accepts a call Switches to the redial memory   Adjusts the volume  Mute	222
④	 Switches on the Voice Control System; see the separate operating instructions	



	Function	Page
⑤	 Back or deactivates the Voice Control System	
⑥	  Selects a menu   Selects the submenu or scrolls through lists  Confirms selections and hides display messages	218  218



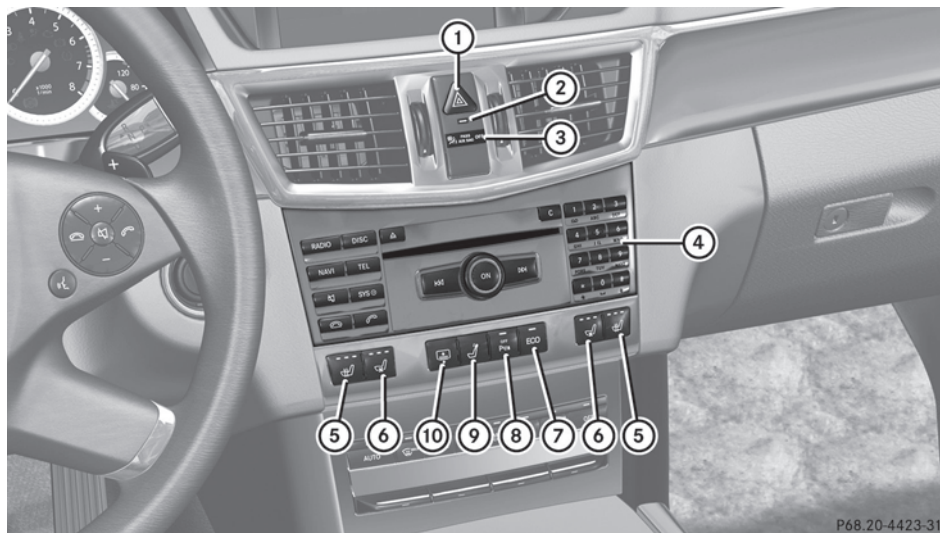

## Center console

## Center console, upper section



P68.20-4423-31



	Function	Page
①	 Hazard warning lamps	118
②	ATA indicator lamp	72
③	 <small>PASC AIR BAG OFF</small> Indicator lamp	44
④	Audio system/COMAND; see separate operating instructions	
⑤	 Seat heating	105

	Function	Page
⑥	 Seat ventilation	106
⑦	<b>ECO</b> ECO start/stop function (AMG vehicles)	148
⑧	 <small>OFF</small> PARKTRONIC	192
⑨	 Retracts the rear seat head restraints	101
⑩	 Sedan: rear window roller sunblind	292

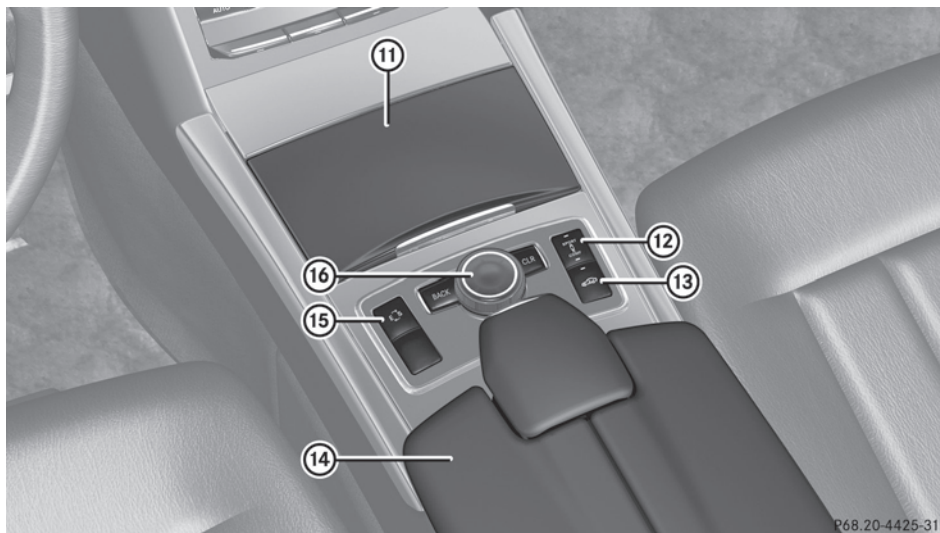
## Center console, lower section



P68.20-4425-31

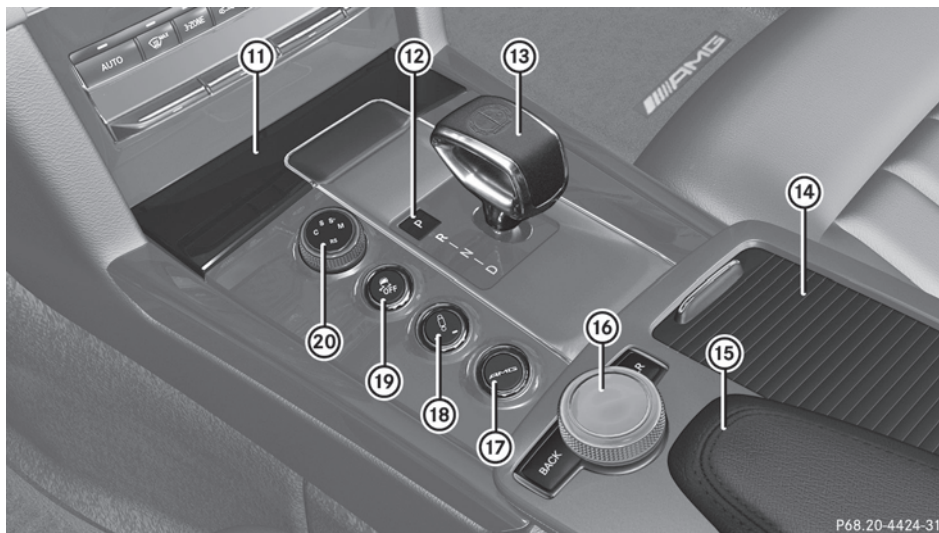

	Function	Page		Function	Page
⑪	Stowage compartment Ashtray Cigarette lighter Cup holder	274 292 293 289	⑬	 Sets the vehicle level	189
⑫	 Sets the suspension tuning	190	⑭	Stowage compartment	274
			⑮	 Selects the drive program	156
			⑯	Audio/COMAND controller	

## Center console, lower section - AMG vehicles



P68.20-4424-31

	Function	Page
⑪	Ashtray Cigarette lighter	292 293
⑫	Engages parking position <b>P</b>	168
⑬	Selector lever	152
⑭	Cup holder	289
⑮	Stowage compartment	274
⑯	Audio/COMAND controller	

	Function	Page
⑰	 Calls up/saves the suspension tuning	191
⑱	 Sets the suspension tuning	191
⑲	 ESP®	67
⑳	Drive program selector	156



## Overhead control panel

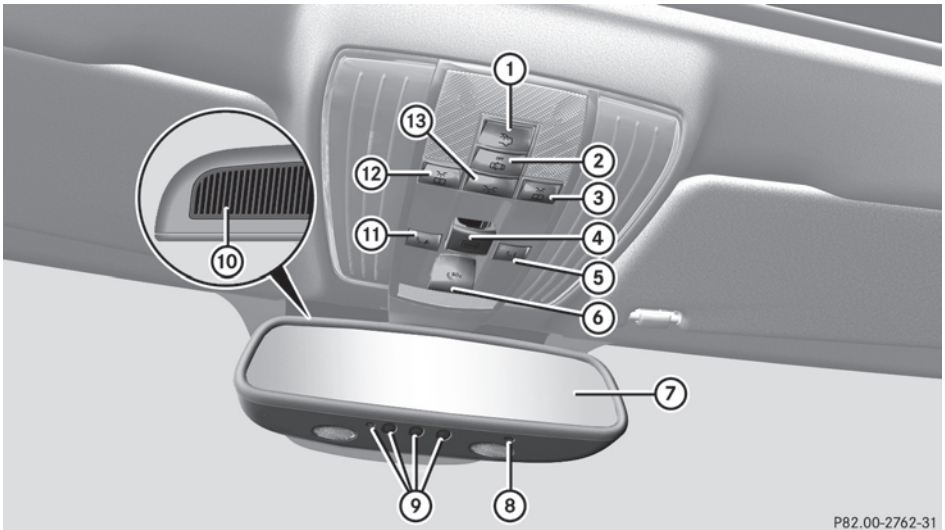

P82.00-2762-31







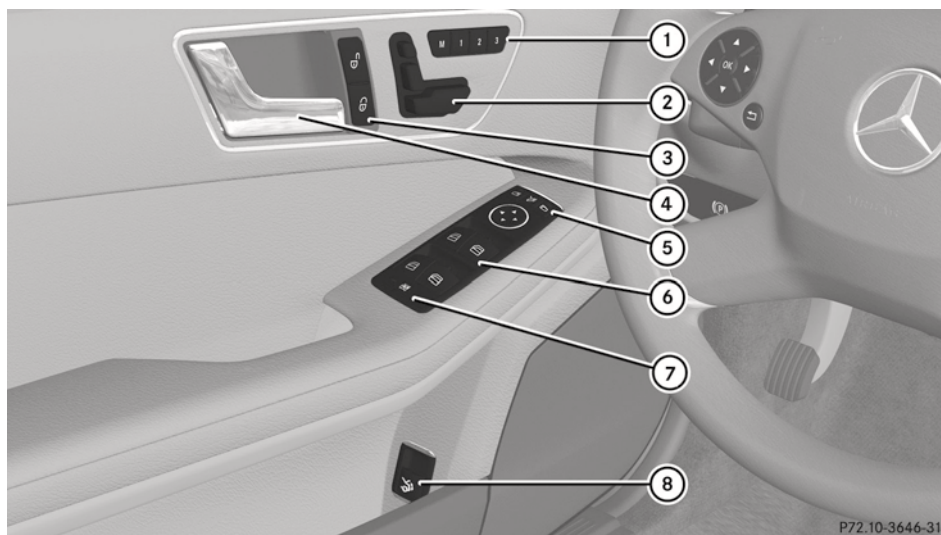



	Function	Page		Function	Page
①	Switches the rear interior lighting on/off	121	⑦	Rear-view mirror	110
②	Switches the automatic interior lighting control on/off	120	⑧	Integrated electronic compass	305
③	Switches the right-hand reading lamp on/off	120	⑨	Buttons for the garage door opener	302
④	Opens/closes the sliding sunroof Opens/closes the panorama roof with power tilt/sliding panel and roller sunblinds	94 94	⑩	Microphone for mbrace (emergency call system), telephone and the Voice Control System <sup>2</sup>	
⑤	Button for MB Info call (mbrace system)	299	⑪	Roadside Assistance button (mbrace system)	298
⑥	SOS button (mbrace system)	297	⑫	Switches the left-hand reading lamp on/off	120
			⑬	Switches the front interior lighting on/off	121

<sup>2</sup> Observe the additional operating instructions.

## Door control panel



P72.10-3646-31

	Function	Page
①	 <b>M 1 2 3</b> Stores settings for the seat, exterior mirrors and steering wheel	111
②	Adjusts the seat electrically	100
③	  Unlocks/locks the vehicle	82
④	Opens the door	82
⑤	    Adjusts and folds the exterior mirrors in/out electrically	109
⑥	 Opens/closes the side windows	90
⑦	 Activates/deactivates the override feature for the side windows in the rear compartment	62
⑧	 Opens/closes the trunk lid/tailgate	87

Useful information .....	38
Occupant safety .....	38
Children in the vehicle .....	56
Panic alarm .....	62
Driving safety systems .....	63
Theft deterrent locking systems .....	71

## Useful information

- i** This Operator's Manual describes all models and all standard and optional equipment of your vehicle available at the time of publication of the Operator's Manual. Country-specific differences are possible. Please note that your vehicle may not be equipped with all features described. This also applies to safety-related systems and functions.
- i** Please read the information on qualified specialist workshops (▷ page 25).

## Occupant safety

### Overview of occupant safety

In this section, you will learn the most important facts about the restraint system components of the vehicle.

The restraint system consists of:

- seat belts
- child restraint systems
- LATCH-type (ISOFIX) child seat anchors

Additional protection is provided by:

- SRS (Supplemental Restraint System)
- NECK-PRO head restraints
- PRE-SAFE®
- Air bag system components with:
  - PASSENGER AIR BAG OFF indicator lamp
  - front-passenger seat with Occupant Classification System (OCS)

The different air bag systems work independently of each other. The protective functions of the system work in conjunction with each other. Not all air bags are deployed in an accident.

### WARNING

Modifications to or work improperly conducted on restraint system components or their wiring, as well as tampering with interconnected electronic systems, can lead

to the restraint systems no longer functioning as intended.

Air bags or Emergency Tensioning Devices (ETDs), for example, could deploy inadvertently or fail to deploy in accidents although the deceleration threshold for air bag deployment is exceeded. Therefore, never modify the restraint systems. Do not tamper with electronic components or their software.

- i** See "Children in the vehicle" (▷ page 56) for more information on infants and children traveling with you in the vehicle and restraints for infants and children.

## SRS (Supplemental Restraint System)

### Introduction

SRS consists of:

- the  SRS warning lamp
- air bags
- air bag control unit (with crash sensors)
- Emergency Tensioning Devices
- belt force limiters

SRS reduces the risk of occupants coming into contact with the vehicle's interior in the event of an accident. It can also reduce the effect of the forces to which occupants are subjected during an accident.

### SRS warning lamp

SRS functions are checked regularly when you switch on the ignition and when the engine is running. Therefore, malfunctions can be detected in good time.

The  SRS warning lamp in the instrument cluster lights up when the ignition is switched on. It goes out no later than a few seconds after the engine is started.

The SRS components are in operational readiness when the  SRS warning lamp is not lit while the engine is running .

**⚠ WARNING**

The SRS self-check has detected a malfunction if the  SRS warning lamp:

- does not come on at all
- fails to go out approximately 4 seconds after the engine was started
- comes on after the engine was started or while driving

For your safety, Mercedes-Benz strongly recommends that you have the system checked as soon as possible at an authorized Mercedes-Benz Center. Otherwise the SRS may not be activated when it is needed in an accident, which could result in serious or fatal injury. The SRS might also deploy unexpectedly and unnecessarily which could also result in injury.

In addition, improper work on the SRS creates a risk of rendering the SRS inoperative or causing unintended air bag deployment. Work on the SRS must therefore only be performed by qualified technicians. Contact an authorized Mercedes-Benz Center.

If it is necessary to modify an air bag system to accommodate a person with disabilities, contact an authorized Mercedes-Benz Center for details. USA only: Call our Customer Assistance Center at 1-800-FOR-MERCEdes (1-800-367-6372) for details.

### Safety guidelines for seat belts, Emergency Tensioning Devices (ETDs) and air bags

**⚠ WARNING**

- Damaged seat belts or seat belts that have been subjected to stress in an accident must be replaced. Their anchoring points must also be checked. Only use seat belts installed or supplied by an authorized Mercedes-Benz Center.
- Air bags and pyrotechnic Emergency Tensioning Devices (ETDs) contain perchlorate material, which may require special handling and regard for the

environment. Check your national disposal guidelines. California residents, see [www.dtsc.ca.gov/HazardousWaste/Perchlorate/index.cfm](http://www.dtsc.ca.gov/HazardousWaste/Perchlorate/index.cfm).

- Air bags and ETDs are designed to function on a one-time-only basis. An air bag or ETD that has deployed must be replaced. PRE-SAFE® has electrically operated reversible belt tensioners in addition to the pyrotechnic ETDs.
- Do not pass seat belts over sharp edges. They could tear.
- Do not make any modification that could change the effectiveness of the seat belts.
- Do not bleach or dye seat belts as this may severely weaken them. In a crash they may not be able to provide adequate protection.
- No modifications of any kind may be made to any components or wiring of the SRS.
- Do not change or remove any component or part of the SRS.
- Do not install additional trim material, seat covers, badges, etc. to the:
  - padded steering wheel boss
  - knee bag covers
  - front-passenger air bag cover
  - outer side of front seat bolsters
  - side trim next to the rear seat backrest
  - roof lining trim
- Do not install additional electrical/electronic equipment on or near SRS components and wiring.
- Keep area between air bags and occupants free of objects (e.g. packages, purses, umbrellas, etc.).
- Do not hang items such as coat hangers from the coat hooks or handles over the door. These items may be thrown around in the vehicle and cause head and other injuries when the window curtain air bag is deployed.
- Air bag system components will be hot after an air bag has inflated. Do not touch them.

- Never place your feet on the instrument panel, dashboard, or on the seat. Always keep both feet on the floor in front of the seat.
- Improper repair work on the SRS creates a risk of rendering the SRS inoperative or causing unintended air bag deployment. Work on the SRS must therefore only be performed by qualified technicians. Contact an authorized Mercedes-Benz Center.
- For your protection and the protection of others, when scrapping the air bag unit or ETD, our safety instructions must be followed. These instructions are available from any authorized Mercedes-Benz Center.
- Given the considerable deployment speed, required inflation volume, and the material of the air bags, there is the possibility of abrasions or other, potentially more serious injuries resulting from air bag deployment.

If you sell your vehicle, Mercedes-Benz strongly recommends that you inform the subsequent owner that the vehicle is equipped with SRS. Also, refer them to the applicable section in the Operator's Manual.

## Air bags

### Important safety notes

#### WARNING

Air bags are designed to reduce the incidence of injuries and fatalities in certain situations:

- frontal impacts (driver's and front-passenger front air bags and driver's knee bag)
- side impacts (side impact air bags, window curtain air bags and pelvis air bags)
- rollover (window curtain air bags)

However, no system available today can completely eliminate injuries and fatalities.

When the air bags are deployed, a small amount of powder is released. The powder generally does not constitute a health hazard and does not indicate that there is a fire in the vehicle. In order to prevent potential breathing difficulties, you should leave the vehicle as soon as it is safe to do so. If you have any breathing difficulty but cannot get out of the vehicle after the air bag inflates, then get fresh air by opening a window or door.

#### WARNING

To reduce the risk of injuries during front air bag inflation, the driver and front-passenger must always be seated correctly and have their seat belts fastened accordingly.

For maximum protection in the event of a collision, you must always be in the normal seat position with your back against the backrest. Fasten your seat belt and make sure that it is correctly positioned on your body.

Since the air bag inflates with considerable speed and force, a proper seating position and correct positioning of the hands on the steering wheel will help to keep you at a safe distance from the air bag. Occupants who are not wearing their seat belt, are not seated properly or are too close to the air bag can be seriously injured or killed by an air bag as it inflates with great force instantaneously:

- Sit with the seat belt properly fastened in a position that is as upright as possible with your back against the seat backrest.
- Move the driver's seat as far back as possible, still permitting proper operation of vehicle controls. The distance from the center of the driver's chest to the center of the air bag cover on the steering wheel must be at least 10 inches (25 cm) or more. You should be able to accomplish this by adjusting the seat and steering wheel. If you have any difficulties, please contact an authorized Mercedes-Benz Center.
- Do not lean your head or chest close to the steering wheel or dashboard.

- Only hold the steering wheel by the rim. Placing hands and arms inside the rim can increase the risk and potential severity of hand/arm injury when the driver front air bag inflates.
- Adjust the front-passenger seat as far back as possible from the dashboard when the seat is occupied.
- Occupants, especially children, should never place their bodies or lean their heads in the area of the door where the side impact air bag inflates. This could result in serious injuries or death should the side impact air bag be deployed. Always sit as upright as possible, wear the seat belt properly and use an appropriately sized child restraint, infant restraint or booster seat recommended for the size and weight of the child.

Failure to follow these instructions can result in severe injuries to you or other occupants.

If you sell your vehicle, it is important that you make the buyer aware of this safety information. Be sure to give the buyer this Operator's Manual.

### **WARNING**

Accident research shows that the safest place for children in an automobile is in a rear seat.

A side impact air bag related injury may occur if occupants, especially children, are not properly seated or restrained when next to a side impact air bag which needs to deploy rapidly in a side impact in order to do its job.

To help avoid the possibility of injury, please follow these guidelines:

- (1) Always sit as upright as possible and use the seat belts properly. Make sure that children 12 years old and under use an appropriately sized child restraint, infant restraint, or booster seat recommended for the size and weight of the child.
- (2) Always wear seat belts properly.

The air bags are only deployed if the air bag control unit detects the need for deployment. Only in the event of such a situation will they provide their supplemental protection.

The driver and passenger should always wear their seat belts. Otherwise, it is not possible for the air bags to provide their supplemental protection.

In the event of other types of impacts and impacts below air bag deployment thresholds, the air bags will not deploy. The driver and passengers will then be protected to the extent possible by a properly fastened seat belt. A properly fastened seat belt is also needed to provide the best possible protection in a rollover.

Air bags provide additional protection; they are not, however, a substitute for seat belts. All vehicle occupants must fasten their seat belts regardless of whether your vehicle is equipped with air bags or not.

It is important for your safety and that of your passenger to have deployed air bags replaced and to have any malfunctioning air bags repaired. This will help to make sure the air bags continue to perform their protective function for the vehicle occupants in the event of a crash.

### **Front air bags**

The front air bags increase protection for the driver's and front-passenger's head and chest.

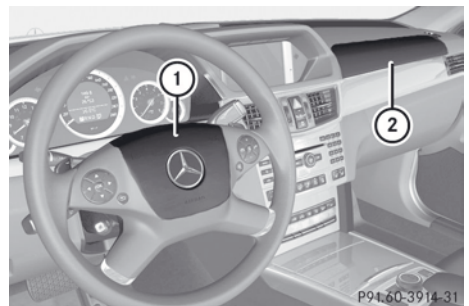

Driver's air bag ① deploys in front of the steering wheel; front-passenger front air

P94.60-3914-31



bag ② deploys in front of and above the glove box.

They are deployed:

- in the event of certain frontal impacts
- if the system determines that air bag deployment can offer additional protection to that provided by the seat belt
- if the seat belt is fastened
- independently of other air bags in the vehicle

If the vehicle overturns, the front air bags are generally not deployed unless the system detects high vehicle deceleration in a longitudinal direction.

Your vehicle has adaptive, two-stage front air bags. In the event of a collision, the air bag control unit evaluates the vehicle deceleration. In the first deployment stage, the front air bag is filled with enough propellant gas to reduce the risk of injuries. The front air bag is fully deployed if a second deployment threshold is exceeded within a few milliseconds.

The deployment of the front-passenger front air bag is also influenced by the weight category of the front passenger, which is determined by the Occupant Classification System (OCS) (▷ page 44).

The lighter the passenger side occupant, the higher the vehicle deceleration rate required (predicted at the start of the impact) for second stage inflation of the front-passenger front air bag. In the second stage, the front air bags are inflated with the maximum amount of propellant gas available.

The front air bags are not deployed in situations where a low impact severity is predicted. You will then be protected by the fastened seat belt.

The front-passenger front air bag will only deploy if:

- the system, based on the OCS weight sensor readings, detects that the front-passenger seat is occupied.
- the  indicator lamp in the center console is not lit, (▷ page 44).
- the air bag control unit predicts a high impact severity.

### Driver's knee bag



Driver's knee bag ① provides additional protection for the driver against:

- knee injuries
- thigh injuries
- lower leg injuries

Driver's knee bag ① deploys below the steering wheel. During a frontal impact, if the system determines that air bag deployment can offer additional protection to that provided by the seat belt, driver's knee bag ① is deployed along with the driver's air bag. The driver's knee bag ① operates best in conjunction with a properly positioned and fastened seat belt.

### Side impact air bags

#### WARNING

The pressure sensors for side impact air bag control are located in the doors. Do not modify any components of the doors or door trim panels including, for example, the addition of door speakers.



Improper repair work on the doors or the modification or addition of components to the doors create a risk of rendering the side impact air bags inoperative or causing unintended air bag deployment. Work on the doors must therefore only be performed by qualified technicians. Contact an authorized Mercedes-Benz Center.

### **WARNING**

Only use seat covers which have been tested and approved by Mercedes-Benz for your vehicle model. Using seat covers or other seat coverings can cause a malfunction of the side impact air bags and/or the pelvis air bags. Contact an authorized Mercedes-Benz Center for availability.

When deployed, the side impact air bags offer additional protection for the thorax of the vehicle occupants on the side of the vehicle on which the impact occurs. However, they do not protect the:

- head
- neck
- arms

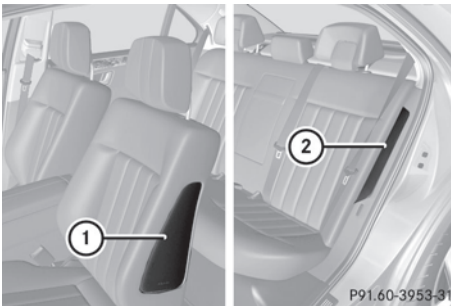

Example: Sedan

Front side impact air bags ① and rear side impact air bags ② deploy next to the outer seat cushions.

The side impact air bags are deployed:

- on the side on which an impact occurs
- at the start of an accident with a high rate of lateral vehicle deceleration or acceleration, e.g. in a side impact
- independently of seat belt use
- independently of the front air bags
- independently of the ETDs

If the vehicle overturns, the side impact air bags are generally not deployed. They are deployed if the system detects high vehicle deceleration or acceleration in a lateral direction and determines that side impact air bag deployment can offer additional protection to that provided by the seat belt. Side impact air bags will not deploy in side impacts which do not exceed the system's preset deployment thresholds for lateral acceleration/deceleration. You will then be protected by the fastened seat belt.

If the OCS detects that the front-passenger seat is not occupied and the front-passenger seat belt is not fastened (the belt tongue is not engaged in the seat belt buckle), the side impact air bag on the front-passenger side will not deploy. The side impact air bag on the front-passenger side will deploy if the front-passenger seat belt is fastened, regardless of whether the front-passenger seat is occupied or not.

### **Pelvis air bags**

#### **WARNING**

Only use seat covers which have been tested and approved by Mercedes-Benz for your vehicle model. Using seat covers or other seat coverings can cause a malfunction of the side impact air bags and/or the pelvis air bags. Contact an authorized Mercedes-Benz Center for availability.

Pelvis air bag deployment enhances the level of protection of the vehicle occupants on the side of the vehicle on which the impact occurs.



Pelvis air bags ① deploy next to and below the outer seat cushions. They are deployed:

- on the side on which an impact occurs
- at the start of an accident with a high rate of lateral vehicle deceleration or acceleration, e.g. in a side impact
- independently of seat belt use
- independently of the front air bags
- independently of the ETDs

The pelvis air bags are generally not deployed if the vehicle overturns, unless the system detects high vehicle deceleration or acceleration in a lateral direction and determines that they can offer additional protection to that provided by the seat belt.

Pelvis air bags ① will not deploy in side impacts which do not exceed the system's preset deployment thresholds for lateral acceleration/deceleration. You will then be protected by the fastened seat belt.

Vehicles with OCS (USA only): if the OCS detects that the front-passenger seat is not occupied and the front-passenger seat belt is not fastened (the belt tongue is not engaged in the seat belt buckle), the pelvis air bag on the front-passenger side will not deploy. The pelvis air bag on the front-passenger side will deploy if the front-passenger seat belt is fastened, regardless of whether the front-passenger seat is occupied or not.

### Window curtain air bags

The window curtain air bags enhance the level of protection for the head, but not chest or

arms, of the vehicle occupants on the side of the vehicle on which the impact occurs.

The window curtain air bags are integrated into the side of the roof frame and deploy in the area from the A-pillar to the C-pillar.

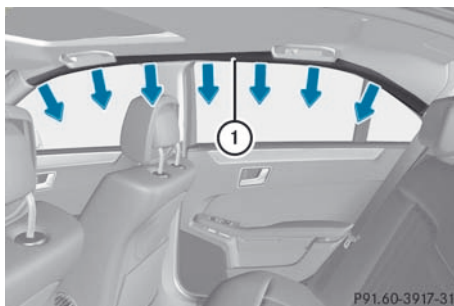

Example: Sedan

Window curtain air bags ① are deployed:



- on the side on which an impact occurs
- at the start of an accident with a high rate of lateral vehicle deceleration or acceleration, e.g. in a side impact
- regardless of whether the front-passenger seat is occupied
- independently of seat belt use
- if the vehicle overturns and the system determines that window curtain air bag deployment can offer additional protection to that provided by the seat belt
- independently of the front air bags

Window curtain air bags ① will not deploy in impacts with deceleration rates which do not exceed the system's preset deployment thresholds for vehicle deceleration or acceleration. You will then be protected by the fastened seat belt.

### Occupant Classification System (OCS)

#### How the occupant classification system works

The Occupant Classification System (OCS) categorizes the occupant on the front-

passenger seat by means of a weight sensor. The front-passenger front air bag is deactivated automatically for certain weight categories. The  indicator lamp shows you the current status. If the  indicator lamp is illuminated, the front-passenger front air bag is deactivated. The system does not deactivate:

- the side impact air bag
- the pelvis air bag
- the window curtain air bag
- the Emergency Tensioning Devices

To be classified correctly, the front passenger must sit:



- with the seat belt fastened correctly
- in a position that is as upright as possible with their back against the seat backrest
- with their feet on the floor

If the front-passenger's weight is transferred to another object in the vehicle (e.g. by leaning on armrests), OCS may not be able to approximate the occupant's weight category. If the front-passenger seat, the seat cover or the seat cushion are damaged, have the necessary repair work carried out at an authorized Mercedes-Benz Center.







For safety reasons, Mercedes-Benz recommends that you only use seat accessories which have been approved by Mercedes-Benz.



Both the driver and the passenger should always use the  indicator lamp as an indication of whether or not the passenger is properly positioned.

### WARNING

If the  indicator lamp illuminates when an adult or someone larger than a small individual is in the front passenger seat, have the front passenger reposition himself or herself in the seat until the  indicator lamp goes out.

In the event of a collision, the air bag control unit will not allow front passenger front air bag deployment when the OCS has classified the

front passenger seat occupant as weighing as much as or less than a typical 12-month-old child in a standard child restraint or if the front passenger seat is classified as being empty. When the OCS senses that the front passenger seat occupant is classified as being up to or less than the weight of a typical 12-month-old child in a standard child restraint, the  indicator lamp will illuminate when the engine is started and remain illuminated. This indicates that the front passenger front air bag is deactivated. When the OCS senses that the front passenger seat is classified as being empty, the  indicator lamp will illuminate when the engine is started and remain illuminated. This indicates that the front passenger front air bag is deactivated. When the OCS senses that the front passenger seat occupant is classified as being heavier than the weight of a typical 12-month-old child seated in a standard child restraint or as being a small individual (such as a young teenager or a small adult), the  indicator lamp will illuminate for approximately 6 seconds when the engine is started. Depending on occupant weight sensor readings from the seat, it will then remain illuminated or go out. With the  indicator lamp illuminated, the front passenger front air bag is deactivated. With the  indicator lamp out, the front passenger front air bag is activated. When the OCS senses that the front passenger seat occupant is classified as an adult or someone larger than a small individual, the  indicator lamp will illuminate for approximately six seconds when the engine is started and then go out. This indicates that the front passenger front air bag is activated. If the  indicator lamp is illuminated, the front passenger front air bag is deactivated and will not be deployed.

If the   indicator lamp is not illuminated, the front passenger front air bag is activated and will be deployed

- in the event of certain frontal impacts
- if the impact exceeds a predetermined triggering threshold
- independent of the side impact air bag or pelvis air bag

If the front passenger front air bag is deployed, the rate of inflation will be influenced by

- the rate of vehicle deceleration as assessed by the air bag control unit
- the front passenger's weight category as identified by the OCS

For further information, see "Air bag display messages" (> page 241).

### WARNING











According to accident statistics, children are safer when properly restrained on the rear seats than on the front-passenger seat. Thus, we strongly recommend that children be placed in the rear seats whenever possible. Regardless of seating position, children 12 years old and under must be seated and properly secured in an appropriate infant restraint, toddler restraint, or booster seat recommended for the size and weight of the child.

The infant or child restraint must be properly secured with the vehicle's seat belt, the seat belt and Top Tether strap, or lower anchors and Top Tether strap, fully in accordance with the child seat manufacturer's instructions.

Occupants, especially children, should always sit as upright as possible, wear the seat belt properly and use an appropriately sized infant restraint, toddler restraint, or booster seat recommended for the size and weight of the child.

Children can be killed or seriously injured by an inflating air bag. Note the following important information when circumstances require you to place a child in the front-passenger seat:

- Your vehicle is equipped with air bag technology designed to deactivate the front-passenger front air bag in your vehicle when the system senses the weight of a typical 12-month-old child or less along with the weight of a standard appropriate child restraint on the front-passenger seat.
- A child in a rear-facing child restraint on the front-passenger seat will be seriously injured or even killed if the front-passenger front air bag inflates in a collision which could occur under some circumstances, even with the air bag technology installed in your vehicle. The only means to eliminate this risk completely is never to place a child in a rear-facing child restraint in the front-passenger seat. We therefore strongly recommend that you always place a child in a rear-facing child restraint on the rear seat.

- If you install a rear-facing child restraint on the front-passenger seat, make sure the   indicator lamp is illuminated, indicating that the front-passenger front air bag is deactivated. Should the   indicator lamp not illuminate or go out while the restraint is installed, please check installation. Periodically check the   indicator lamp while driving to make sure that the   indicator lamp is illuminated. If the   indicator lamp goes out or remains out, do not transport a child on the front-passenger seat until the system has been repaired.

A child in a rear-facing child restraint on the front-passenger seat will be seriously injured or even killed if the front-passenger front air bag inflates.

- If you place a child in a forward-facing child restraint on the front-passenger seat:
  - move the seat as far back as possible
  - use the proper child restraint recommended for the age, size and weight of the child
  - secure child restraint with the vehicle's seat belt according to the child seat manufacturer's instructions
- For children larger than the typical 12-month-old child, the front-passenger front air bag may or may not be activated.

If the driver's air bag deploys, this does not mean that the front-passenger front air bag also has to deploy.

The OCS may have detected that the seat:

- was empty or occupied by a person with a weight of up to or less than that of a typical 12-month-old child seated in a standard child restraint
- was occupied by a small individual, such as a young teenager or a small adult
- was occupied by a child in a child restraint system, whose weight is greater than that of a typical 12-month-old child.



These are examples of when the OCS deactivates the front-passenger front air bag. Deactivation takes place although the collision fulfills the criteria for deploying the driver's air bag.



If the SmartKey has been removed from the ignition lock or is in position 0, indicator lamp

 ① does not light up.

## WARNING



If the red  SRS warning lamp in the instrument cluster and the   indicator lamp light up simultaneously, the OCS is malfunctioning. The front passenger front air bag will be deactivated in this case. Have the system checked by qualified technicians as soon as possible. Contact an authorized Mercedes-Benz Center.

Only have the seat repaired or replaced at an authorized Mercedes-Benz Center.



In order to ensure proper operation of the air bag system and OCS:



- Sit with the seat belt properly fastened in a position that is as upright as possible with your back against the seat backrest.
- When seated, a passenger should not position him/herself in such a way as to cause the passenger's weight to be lifted from the seat cushion as this may result in the OCS being unable to correctly approximate the passenger's weight category.
- Read and observe all warnings in this chapter.

## System self-test

The   indicator lamp illuminates when you:

- turn the SmartKey to position 1 or 2 in the ignition lock
- on vehicles with KEYLESS-GO, press the Start/Stop button once or twice

If an adult occupant is properly sitting on the passenger seat and the OCS classifies the occupant as an adult, the   indicator lamp illuminates and goes out again after approximately 6 seconds.

If the seat is not occupied and the OCS classifies the front passenger seat as being unoccupied, the   indicator lamp will illuminate and not go out.

 **WARNING**

If the  indicator lamp does not illuminate, the system is not functioning. You must contact an authorized Mercedes-Benz Center before seating any child on the front passenger seat.

For more information, see "Problems with the Occupant Classification System" (▷ page 49).

 **WARNING**

Never place anything between seat cushion and child seat (e.g. a pillow), since it reduces the effectiveness of the OCS. The underside and rear side child restraint system must be placed entirely on the seat cushion and the backrest of the front-passenger seat backrest.

If necessary, adjust the tilt of the passenger seat backrest.

An incorrectly mounted child seat could cause injuries to the child in case of an accident, instead of increasing protection for the child.



Follow the manufacturer's instructions for installation of child restraint systems.

## Problems with the occupant classification system

Problem	Possible causes/consequences and ► Solutions
<p>The  indicator lamp illuminates and remains illuminated. The person on the front-passenger seat:</p> <ul style="list-style-type: none"> <li>• has the weight of a typical adult</li> <li>• has been determined by the system not to be a child.</li> </ul>	<p>The OCS is malfunctioning.</p> <ul style="list-style-type: none"> <li>► Have the OCS checked as soon as possible at an authorized Mercedes-Benz Center.</li> <li>► Observe the additional display messages in the multifunction display (► page 241).</li> </ul>

### WARNING

If the  indicator lamp illuminates and remains illuminated when the weight of a typical adult or someone larger than a small individual has been detected on the passenger seat, do not allow any occupant to use the passenger seat until the system has been repaired.

Problem	Possible causes/consequences and ► Solutions
<p>The  indicator lamp does not illuminate and/or does not remain illuminated. The front-passenger seat is:</p> <ul style="list-style-type: none"> <li>• unoccupied</li> <li>• occupied with a weight up to or less than a typical 12-month-old child in a standard child restraint system</li> </ul>	<p>The OCS is malfunctioning.</p> <ul style="list-style-type: none"> <li>► Make sure there is nothing between the seat cushion and the child seat.</li> <li>► Check the installation of the child restraint system.</li> <li>► Make sure that no objects are applying additional weight onto the seat.</li> <li>► If the  indicator lamp does not illuminate, have the OCS checked as soon as possible at an authorized Mercedes-Benz Center. Do not transport a child on the front-passenger seat as long as the OCS is not functioning.</li> <li>► Observe the additional display messages in the multifunction display (► page 241).</li> </ul>

### WARNING

If the  indicator lamp does not illuminate or remains out with the weight of a typical 12-month-old child in a standard child restraint or less, or is unoccupied, on the front-passenger seat, do not transport a child on the front-passenger seat until the system has been repaired.



## PRE-SAFE® (preventative occupant protection)

### WARNING

The PRE-SAFE® system reduces the impact of an accident on vehicle occupants, as long as their seat belts have been fastened correctly. Although your vehicle is equipped with a PRE-SAFE® system, the possibility of injury in the event of an accident cannot be ruled out. You should therefore always drive carefully and adapt your driving style to the prevailing road, weather and traffic conditions.

PRE-SAFE® takes preemptive measures to protect occupants in certain hazardous situations.

PRE-SAFE® intervenes:

- in emergency braking situations, e.g. if BAS is activated or, in vehicles with DISTRONIC PLUS, BAS PLUS intervenes powerfully
- if the radar sensor system detects an imminent danger of collision in certain situations (on vehicles with DISTRONIC PLUS)
- in critical driving situations, e.g. when physical limits are exceeded and the vehicle understeers or oversteers severely

PRE-SAFE® takes the following measures depending on the hazardous situation detected:

- the front seat belts are pre-tensioned.
- it adjusts the front-passenger seat if it is in an unfavorable position.
- the air pressure in the side bolsters of the seat cushion and seat backrest of the front active multicontour seats is increased.
- if the vehicle skids, the sliding sunroof/panorama roof with power tilt/sliding panel and the side windows are closed so that only a small gap remains.

If the hazardous situation passes without resulting in an accident, PRE-SAFE® slackens the belt pretensioning. The air pressure in the side bolsters on the active multicontour seat

is reduced again. All settings made by PRE-SAFE® can then be reversed.

If the seat belts are not released:

- ▶ Move the backrest or seat back slightly, but only when the vehicle is stationary. The belt pretensioning is reduced and the locking mechanism is released.

### WARNING

Make sure that nobody can become trapped as you adjust the seat.

- ❗ Make sure that there are no objects in the footwell or behind the seats when resetting the seats. There is a risk that the seats and/or the objects could be damaged.

More information about seat-belt adjustment, a convenience function integrated into PRE-SAFE®, can be found in the "Seat-belt adjustment" section (▷ page 54).

## NECK-PRO head restraints

The NECK-PRO head restraints increase protection to the driver's and front passenger's head and neck. To this end, the NECK-PRO head restraints on the driver's and front-passenger seats are moved forwards and upwards in the event of a rear-end collision of a certain severity. This provides better head support.

### WARNING

Do not secure any objects (e.g. coat hangers) on the NECK-PRO head restraints. Otherwise, the NECK-PRO head restraints may not function properly, or in the event of a rear-end collision may not be able to offer the level of protection they are designed to provide.

### WARNING

Seat or head restraint covers can cause a malfunction when the NECK-PRO head restraints are activated or when the side impact air bags or pelvis air bags are



deployed, or they can prevent this completely. The NECK-PRO head restraints or side impact air bags/pelvis air bags can therefore not provide the intended protection. Do not use any seat or head restraint covers.

If the NECK-PRO head restraints have been triggered in an accident, reset the NECK-PRO head restraints on the driver's and front-passenger seat (▷ page 51). Otherwise, the additional protection will not be available in the event of another rear-end collision. You can recognize when NECK-PRO head restraints have been triggered by the fact that they have moved forwards and can no longer be adjusted.

#### WARNING

For your protection, drive only with properly positioned head restraints.

Adjust the head restraint so that it is as close to the head as possible and the center of the head restraint supports the back of the head at eye level. This will reduce the potential for injury to the head and neck in the event of an accident or similar situation.

### Resetting triggered NECK-PRO head restraints

#### WARNING

For safety reasons, have the NECK-PRO head restraints checked at an authorized Mercedes-Benz Center after a rear-end collision.

#### WARNING

When pushing back the NECK-PRO head restraint cushion, make sure your fingers do not become caught between the head restraint cushion and the cover. Failure to observe this could result in injuries.

-  1 Resetting the NECK-PRO head restraints requires a lot of strength. If you have difficulty resetting the NECK-PRO head restraints, have this work carried out at a

qualified specialist workshop, e.g. an authorized Mercedes-Benz Center.

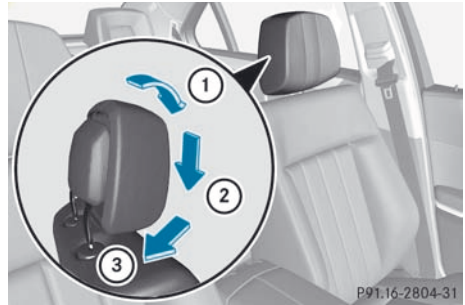

Example: Sedan

- ▶ Tilt the top of the NECK-PRO head restraint cushion forwards in the direction of arrow ①.
- ▶ Push the NECK-PRO head restraint cushion down in the direction of arrow ② as far as it will go.
- ▶ Firmly push the NECK-PRO head restraint cushion back in the direction of arrow ③ until the cushion engages.
- ▶ Repeat this procedure for the second NECK-PRO head restraint.

### Seat belts

#### Important safety notes

The use of seat belts and infant and child restraint systems is required by law in all 50 states, the District of Columbia, the U.S. territories and all Canadian provinces.

Even where this is not the case, all vehicle occupants should have their seat belts fastened when the vehicle is in motion.

-  For further information on infants and children traveling in the vehicle and on infant and child restraint systems, see "Children in the vehicle" (▷ page 56).

#### WARNING

Always fasten your seat belt before driving off. Always make sure all of your passengers are

properly restrained. You and your passengers should always wear seat belts.

Failure to wear and properly fasten and position your seat belt greatly increases your risk of injuries and their likely severity in an accident.

If you are ever in an accident, your injuries can be considerably more severe without your seat belt properly buckled. Without your seat belt buckled, you are much more likely to hit the interior of the vehicle or be ejected from it. You can be seriously injured or killed.

In the same crash, the possibility of injury or death is lessened if you are properly wearing your seat belt. The air bags can only protect as intended if the occupants are properly wearing their seat belts.

#### WARNING

Never ride in a moving vehicle with the seat backrest in an excessively reclined position as this can be dangerous. You could slide under the seat belt in a collision. If you slide under it, the seat belt would apply force at the abdomen or neck. That could cause serious or even fatal injuries. The seat backrest and seat belt provide the best restraint when the wearer is in a position that is as upright as possible and the seat belt is properly positioned on the body.

#### WARNING

Never let more people ride in the vehicle than there are seat belts available. Make sure everyone riding in the vehicle is correctly restrained with a separate seat belt. Never use a seat belt for more than one person at a time.

#### WARNING

Damaged seat belts or seat belts that have been subjected to stress in an accident must be replaced and their anchoring points must also be checked.

Only use seat belts which have been approved by Mercedes-Benz.

Do not make any modifications to the seat belts. This can lead to unintended activation of the ETDs or to their failure to activate when necessary.

Do not bleach or dye seat belts as this may severely weaken them. In a crash they may not be able to provide adequate protection.

Have all work carried out only by qualified technicians. Contact an authorized Mercedes-Benz Center.

### Correct use of the seat belts

#### WARNING

##### USE SEAT BELTS PROPERLY

- Seat belts can only work when used properly. Never wear seat belts in any other way than as described in this section, as that could result in serious injuries in the event of an accident.
- Each occupant should wear their seat belt at all times, because seat belts help reduce the likelihood of and potential severity of injuries in accidents, including rollovers. The integrated restraint system includes SRS (driver front air bag, driver's side knee bag, front-passenger front air bag, side impact air bags, pelvis air bags, window curtain air bags for the side windows), Emergency Tensioning Devices, seat belt force limiters, and front seat knee bolsters. The system is designed to enhance the protection offered to properly belted occupants in certain frontal (front air bags, driver's side knee bag and ETDs) and side (side impact air bags, window curtain air bags, and ETDs) impacts which exceed preset deployment thresholds and in certain rollovers (window curtain air bags and ETDs).
- Never wear the shoulder belt under your arm, across your neck or off your shoulder. In a frontal crash, your body would move too far forward. That would increase the chance of head and neck injuries. The seat belt would also apply too much force to the

ribs or abdomen, which could severely injure internal organs such as your liver or spleen.

Adjust the seat belt so that the shoulder section is located as close as possible to the middle of the shoulder. It should not touch the neck. Never pass the shoulder portion of the seat belt under your arm. For this purpose, you can adjust the height of the seat belt outlet.

- Position the lap belt as low as possible on your hips and not across the abdomen. If the lap belt is positioned across your abdomen, it could cause serious injuries in a crash.
- Never wear seat belts over rigid or breakable objects in or on your clothing, such as eyeglasses, pens, keys etc., as these might cause injuries.
- Make sure the seat belt is always fitted snugly. Take special care of this when wearing loose clothing.
- Never use a seat belt for more than one person at a time. Do not fasten a seat belt around a person and another person or other objects at the same time.
- Seat belts should not be worn twisted. In a crash, you would not have the full width of the seat belt to distribute impact forces. The twisted seat belt against your body could cause injuries.
- Pregnant women should also always use a lap-shoulder belt. The lap belt portion should be positioned as low as possible on the hips to avoid any possible pressure on the abdomen.
- Place the seat backrest in a position that is as upright as possible.
- Check your seat belt during travel to make sure it is properly positioned.
- Never place your feet on the instrument panel, dashboard, or on the seat. Always

keep both feet on the floor in front of the seat.

- When using a seat belt to secure infant restraints, toddler restraints, or children in booster seats, always follow the child seat manufacturer's instructions.

#### **WARNING**

Do not pass seat belts over sharp edges. They could tear.

Do not allow the seat belt to get caught in the door or in the seat adjustment mechanism. This could damage the seat belt.

Never attempt to make modifications to seat belts. This could impair the effectiveness of the seat belts.

### Fastening seat belts

#### **WARNING**

According to accident statistics, children are safer when properly restrained on the rear seats than on the front-passenger seat. Thus, we strongly recommend that children be placed in the rear seat whenever possible. Regardless of seating position, children 12 years old and under must be seated and properly secured in an appropriately sized child restraint system or booster seat recommended for the size and weight of the child. For additional information, see the "Children in the vehicle" section.

A child's risk of serious or fatal injuries is significantly increased if the child restraints are not properly secured in the vehicle and/or the child is not properly secured in the child restraint.

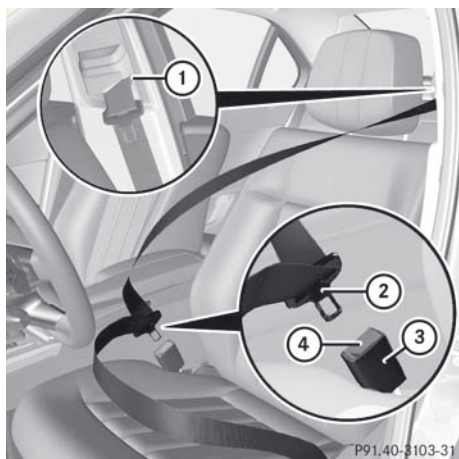

Example: Sedan

- ▶ Adjust the seat and move the backrest to an almost vertical position (▷ page 98).
- ▶ Pull the seat belt smoothly through belt sash guide ①.
- ▶ Without twisting it, guide the shoulder section of the seat belt across the middle of your shoulder and the lap section across your hips.
- ▶ Engage belt tongue ② in buckle ③.  
Seat-belt adjustment: if necessary, the driver's and front-passenger seat belts automatically adjust to the upper body (▷ page 54).
- ▶ If necessary, adjust the seat belt to the appropriate height (▷ page 54).
- ▶ If necessary, pull upwards on the shoulder section of the seat belt to tighten the belt across your body.

All seat belts except the driver's seat belt are equipped with a special seat belt retractor to securely fasten child restraint systems in the vehicle. For further information on special seat belt retractors, see (▷ page 59).

For more information about releasing the seat belt with release button ④, see "Releasing seat belts" (▷ page 55).

## Seat belt adjustment

The seat-belt adjustment function adjusts the driver's and front-passenger seat belt to the upper body of the occupants.

The belt strap is tightened slightly when:

- you engage the belt tongue in the belt buckle and you then turn the SmartKey to position **2** in the ignition lock.
- the SmartKey is in position **2** in the ignition lock and you then engage the belt tongue in the buckle.

The seat-belt adjustment will apply a retraction force if any slack is detected between the occupant and the seat belt. Do not hold on to the seat belt tightly while it is adjusting. You can switch the seat-belt adjustment on and off in the on-board computer (▷ page 229).

The seat-belt adjustment is an integral part of the PRE-SAFE® convenience function. More information about PRE-SAFE® can be found in the "PRE-SAFE® (preventative occupant protection)" section (▷ page 50).

## Belt height adjustment

You can adjust the seat belt height on the driver's seat and the front-passenger seat.

**Wagon:** you can also adjust the belt height on the outer rear seats.

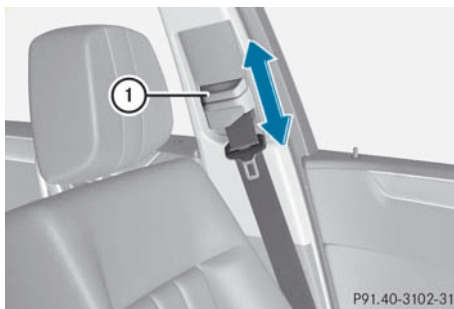

Adjust the height so that the upper part of the seat belt is routed across the center of your shoulder.

- ▶ **To raise:** slide the belt sash guide upwards. The belt sash guide engages in various positions.
- ▶ **To lower:** press and hold belt sash guide release ①.
- ▶ Slide the belt sash guide downwards.
- ▶ Release belt sash guide release ① and make sure that the belt sash guide has engaged.

### Using the rear center seat belt

If the left-hand rear seat backrest is folded down and back up again, the rear center seat belt may lock. The seat belt can then not be pulled out.

- ▶ **To release the rear center seat belt:** pull out the seat belt by the belt outlet on the backrest approximately 1 in (25 mm) and release it again.  
The seat belt is retracted and released.

### Releasing seat belts

- ▶ Press release button ④ (> page 53) and guide belt tongue ② back towards belt sash guide ①.
- ! Make sure that the seat belt is fully rolled up. Otherwise, the seat belt or belt tongue will be trapped in the door or in the seat mechanism. This could damage the door, the door trim panel and the seat belt. Damaged seat belts can no longer fulfill their protective function and must be replaced. Consult an authorized Mercedes-Benz Center.

### Belt warning for the driver and front passenger

Regardless of whether the driver and front passenger have fastened their seat belts already, the  seat belt warning lamp lights up for 6 seconds after every engine start. It then goes out if the driver and the

front passenger have fastened their seat belts.

If the driver's seat belt is not fastened after the engine is started, an additional warning tone will sound. The warning tone goes out after approximately six seconds or once the driver's seat belt is fastened.

If the driver or front passenger have not fastened their seat belt after 6 seconds and the doors are closed, the  seat belt warning lamp lights up.

- until the driver or the front passenger have fastened their seat belts
- if a vehicle speed of 15 mph(25 km/h) is exceeded once, a warning tone with increasing intensity sounds additionally for a maximum of 60 seconds or until the driver or front passenger have fastened their seat belts.

If the driver or front passenger undo their seat belts during the journey, the  seat belt warning lamp lights up and the warning tone sounds again.

The warning tone ceases even if the driver or front passenger have still not fastened their seat belt after 60 seconds. The  seat belt warning lamp stops flashing but continues to be lit.

Once the vehicle is stationary, the warning tone is reactivated and the  seat belt warning lamp starts to flash again if the vehicle speed exceeds 15 mph(25 km/h) once.

The  seat belt warning lamp only goes out if:

- both the driver and the front passenger have fastened their seat belts.
- or
- the vehicle is stationary and a door is open.

- i For more information on the  seat belt warning lamp, see "Warning and indicator lamps in the instrument cluster, seat belt" (> page 261).

## Emergency Tensioning Devices, belt force limiters

The front seat belts and the outer seat belts in the rear are equipped with ETDs and seat belt force limiters.

The ETDs tighten the seat belts in an accident, pulling them close against the body.

The ETDs do not correct incorrect seat positions or incorrectly fastened seat belts.

The ETDs do not pull vehicle occupants back towards the backrest.

Seat belt force limiters, when triggered, help to reduce the peak force exerted by the seat belt on the vehicle occupant.

The seat belt force limiters for the front seats are synchronized with the front air bags. These take on a part of the deceleration force. Thus, the force exerted on the occupant is distributed over a greater area.

The ETDs can only be activated when:

- the ignition is switched on.
- the restraint systems are operational; see "SRS warning lamp" (▷ page 38).
- the belt tongue is engaged in the buckle on each of the lap-shoulder belts in the front.
- the front-passenger seat is occupied and the belt tongue is engaged in the buckle on the front-passenger side.

The ETDs on the outside seats in the rear compartment are triggered independently of the lock status of the seat belts.

The ETDs are triggered depending on the type and severity of an accident:

- if, in the event of a head-on or rear-end collision, the vehicle decelerates or accelerates rapidly in a longitudinal direction during the initial stages of the impact
- if, in the event of a side impact, on the side opposite the impact the vehicle

decelerates or accelerates rapidly in a lateral direction

- if, in certain situations where the vehicle overturns, the system determines that it can provide additional protection

If the air bags are deployed, you will hear a bang, and a small amount of powder may also be released. Only in rare cases will the bang affect your hearing. The powder that is released generally does not constitute a health hazard. The  SRS warning lamp lights up.

### WARNING

Pyrotechnic Emergency Tensioning Devices that have been deployed must be renewed.

For your safety, when disposing of Emergency Tensioning Devices, always observe the safety instructions. These are available from any authorized Mercedes-Benz Center.

The PRE-SAFE® system has electrically operated reversible pre-tensioners that do not require replacement after activation.

- ❗ If the front-passenger seat is not occupied, do not engage the seat belt tongue in the buckle on the front-passenger seat. Otherwise, the Emergency Tensioning Device could be triggered in the event of an accident.

## Children in the vehicle

### Child restraint systems

#### Important safety notes

We recommend that all infants and children be properly secured in an infant or child restraint system at all times while the vehicle is in motion.

The use of seat belts and infant and child restraint systems is required by law in all 50 states, the District of Columbia, the U.S. territories and all Canadian provinces.

Infants and children must always be seated in an appropriate infant or child restraint system



recommended for the size and weight of the child. The infant or child restraint system must be properly secured in accordance with the manufacturer's instructions. All infant or child restraint systems must meet U.S. Federal Motor Vehicle Safety Standards 213 and 225 and Canadian Motor Vehicle Safety Standards 213 and 210.2.

An information label on the child restraint system indicates whether it meets these standards. This information is also provided in the installation instructions supplied with the child restraint system.

Always read and follow the manufacturer's instructions when using an infant or child restraint system or booster seat.

Observe all warning signs in the vehicle interior and on the infant or child restraint.







### WARNING

According to accident statistics, children are safer when properly restrained in the rear seating positions than in the front seating position. Thus, we strongly recommend that children be placed in the rear seats whenever possible. Regardless of seating position, children 12 years old and under must be seated and properly secured in an appropriate infant restraint, toddler restraint, or booster seat recommended for the size and weight of the child.

The infant or child restraint must be properly secured with the vehicle's seat belt, the seat belt and top tether strap, or lower anchors and top tether strap, fully in accordance with the child seat manufacturer's instructions.

Occupants, especially children, should always sit as upright as possible, wear the seat belt properly and use an appropriately sized infant restraint, toddler restraint, or booster seat recommended for the size and weight of the child.

Children can be killed or seriously injured by an inflating air bag. Note the following important information when circumstances require you to place a child in the front passenger seat:

- Your vehicle is equipped with air bag technology designed to deactivate the front passenger front air bag in your vehicle when the system senses the weight of a typical 12-month-old child or less along with the weight of a standard appropriate child restraint on the front passenger seat.
- For children larger than the typical 12-month-old child, the front passenger front air bag may or may not be activated. Always make sure the  PASSENGER AIR BAG OFF indicator lamp is illuminated, indicating that the front passenger front air bag is deactivated.
- A child in a rear-facing child restraint on the front passenger seat will be seriously injured or even killed if the front passenger front air bag inflates in a collision which could occur under some circumstances, even with the air bag technology installed in your vehicle. The only means to completely eliminate this risk is to never place a child in a rear-facing child restraint in the front seat. We therefore strongly recommend that you always place a child in a rear-facing child restraint in a backseat.
- If you must install a rear-facing child restraint on the front passenger seat because circumstances require you to do so, make sure the  PASSENGER AIR BAG OFF indicator lamp is illuminated, indicating that the front passenger front air bag is deactivated. Should the  PASSENGER AIR BAG OFF indicator lamp not illuminate or go out while the restraint is installed, please check installation. Periodically check the  PASSENGER AIR BAG OFF indicator lamp while driving to make sure the  PASSENGER AIR BAG OFF indicator lamp is illuminated. If the  PASSENGER AIR BAG OFF indicator lamp goes out or remains out, do not transport a child on the front passenger seat until the system has been repaired.

A child in a rear-facing child restraint on the front passenger seat will be seriously injured or even killed if the front passenger front air bag inflates.

- If you have to place a child in a forward-facing child restraint on the front passenger seat, move the seat as far back as possible, use the proper child restraint recommended for the age, size and weight of the child, and secure child restraint with the vehicle's seat belt according to the child seat manufacturer's instructions.

### WARNING

Infants and small children should never share a seat belt with another occupant. During an accident, they could be crushed between the occupant and seat belt.

A child's risk of serious or fatal injuries is significantly increased if the child restraints are not properly secured in the vehicle and/or the child is not properly secured in the child restraint.

Children too big for a toddler restraint must ride in seats using regular seat belts. Position the shoulder belt across the chest and shoulder, not face or neck. A booster seat may be necessary to achieve proper seat belt positioning for children over 41 lb (18 kg) until they reach a height where a lap/shoulder belt fits properly without a booster.

When the child restraint is not in use, remove it from the vehicle or secure it with the seat belt to prevent the child restraint from becoming a projectile in the event of an accident.

If an infant or child is traveling in the vehicle:

- ▶ Secure the infant or child with an appropriate infant or child restraint recommended for the child's age and weight.
- ▶ Make sure that the infant or child is properly secured at all times while the vehicle is in motion.

### WARNING

When leaving the vehicle, always remove the SmartKey from the ignition lock. Always take the SmartKey with you and lock the vehicle. Do not leave children unattended in the vehicle, even if they are secured in a child restraint system, or with access to an unlocked vehicle. A child's unsupervised access to a vehicle could result in an accident and/or serious personal injury. The children could:

- injure themselves on parts of the vehicle
- be seriously or fatally injured through excessive exposure to extreme heat or cold
- injure themselves or cause an accident with vehicle equipment that can be operated even if the SmartKey is removed from the ignition lock or removed from the vehicle, such as seat adjustment, steering wheel adjustment, or the memory function

If children open a door, they could injure other persons or get out of the vehicle and injure themselves or be injured by following traffic.

Do not expose the child restraint system to direct sunlight. The child restraint system's metal parts, for example, could become very hot, and the child could be burned on these parts.

### WARNING

Do not carry heavy or hard objects in the passenger compartment, or trunk (sedan), or cargo compartment (wagon) unless they are firmly secured in place.

Unsecured or improperly positioned cargo increases a child's risk of injury in the event of

- strong braking maneuvers
- sudden changes of direction
- an accident



## Special seat belt retractor

All seat belts except the driver's seat belt are equipped with a special seat belt retractor. When activated, the special seat belt retractor ensures the seat belt will not slacken once the child restraint system has been secured.

Installing a child restraint system:

- ▶ Always comply with the manufacturer's installation instructions.
- ▶ Pull the seat belt smoothly from the inertia reel.
- ▶ Engage the seat belt tongue in the belt buckle.

Activating the special seat belt retractor:

- ▶ Pull the seat belt out fully and let the inertia reel retract it again. While the seat belt is retracting, you should hear a ratcheting sound. The special seat belt retractor is enabled.
- ▶ Push down on the child restraint system to take up any slack.

Removing a child restraint system/  
deactivating the special seat belt retractor:

- ▶ Always comply with the manufacturer's installation instructions.
- ▶ Press the seat belt release button and guide the belt tongue to the belt outlet. The special seat belt retractor is deactivated.

### **WARNING**

Never release the seat belt buckle while the vehicle is in motion, since the special seat belt retractor will be deactivated.

## LATCH-type (ISOFIX) child seat anchors in the rear

### **WARNING**

Children that are too large for a child restraint must travel in seats using normal seat belts. Position shoulder belt across the chest and shoulder, not face or neck.

In order to attain the correct seating position for children weighing over 41 lb (18 kg), it may be necessary to use a booster seat until they reach a height where a normal lap/shoulder seat belt lies properly across their bodies without the need for a booster seat.

Install the child restraint system according to the manufacturer's instructions.

The child restraint system must be installed firmly on both brackets.

An incorrectly installed child restraint system can come loose in the event of an accident, causing the child to be severely or fatally injured.

Child restraint systems/child restraint retaining brackets that are damaged or have suffered damage due to an impact must be replaced.

LATCH-type (ISOFIX) is a standardized securing system for specially designed child restraint systems on the rear seats. Securing rings for two LATCH-type (ISOFIX) child restraint systems are installed on the left and right of the rear seats.

Secure non LATCH-type (ISOFIX) child restraint systems using the vehicle's seat belt system. Always install child restraint systems according to the manufacturer's instructions.

 When installing the child restraint system, make sure that the seat belt for the center seat does not get trapped. Otherwise, the seat belt could be damaged.



P91.12-3450-31

When installing the LATCH-type (ISOFIX) child restraint system, fold protective caps ② of securing rings ① inwards.

- ▶ Install the LATCH-type (ISOFIX) child restraint system. Comply with the manufacturer's instructions when doing so.

## Top Tether

### Important safety information

#### WARNING

Observe "Important safety notes" (▷ page 56).

#### WARNING

Always lock the rear seat backrests in their upright position when the rear seats are occupied by passengers. Lock the rear seat backrests in their upright position before installing the Top Tether straps or when the cargo compartment is not in use. Make sure that rear seat backrests are secured properly by pushing and pulling on the seat backrests. If the seat backrest is not locked properly, the seat backrest could fold forward. The child restraint system is no longer supported properly or held in position and can no longer fulfill its function. This could cause serious or even fatal injuries.

Top Tether facilitates an additional attachment point between the LATCH-type (ISOFIX) child seat mount child restraint system and the rear bench seat. This can further reduce the risk of injury.

### Sedan

The Top Tether anchorages are located in the rear compartment behind the head restraints.

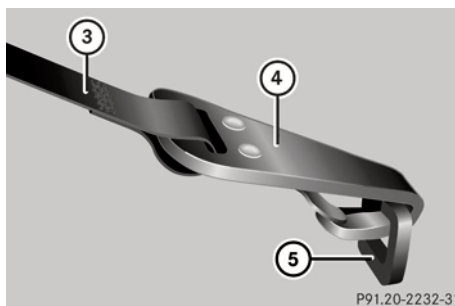
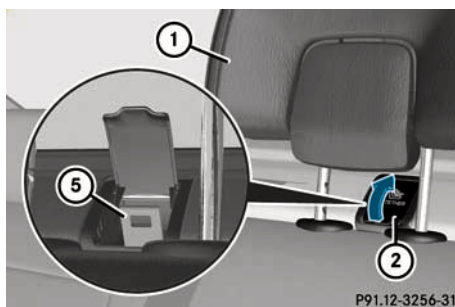

- ▶ Move head restraint ① upwards.
- ▶ Fold up cover ② of Top Tether anchorage ⑤.
- ▶ Route Top Tether belt ③ under head restraint ① between both head restraint bars.
- ▶ Hook Top Tether hook ④ into Top Tether anchorage ⑤.
- ▶ Make sure that Top Tether belt ③ is not twisted.
- ▶ Fold down cover ② of Top Tether anchorage ⑤.
- ▶ Move head restraint ① back down again slightly if necessary (▷ page 101). Make sure that the routing of Top Tether belt ③ is not impaired.
- ▶ Install the LATCH-type (ISOFIX) child restraint system with Top Tether. Comply with the manufacturer's installation instructions when doing so. Make sure that Top Tether belt ③ sits taut.

## Wagon

The Top Tether anchorages are attached to the rear of the rear seat backrests.

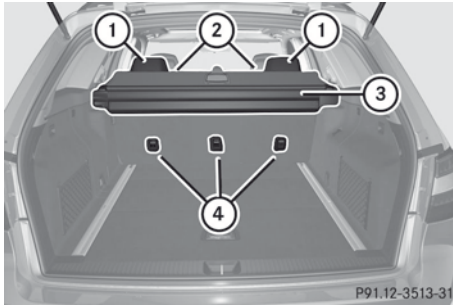

P91.12-3513-31

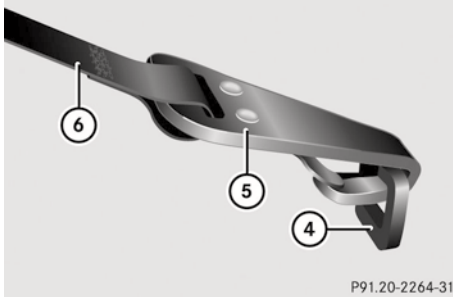

P91.20-2264-31

- ▶ Move head restraint ① upwards.
- ▶ Remove combined cargo cover and net ③ (▷ page 282).
- ▶ Route Top Tether belt ⑥ under head restraint ① between both head restraint bars.
- ▶ Hook Top Tether hook ⑤ into Top Tether anchorage ④ on the back of rear seat backrest ②.
- ▶ Make sure that Top Tether belt ⑥ is not twisted.
- ▶ Move head restraint ① back down again slightly if necessary (▷ page 101). Make sure that the routing of Top Tether belt ⑥ is not impaired.
- ▶ Install the LATCH-type (ISOFIX) child restraint system with Top Tether. Comply with the manufacturer's installation

instructions when doing so. Make sure that Top Tether belt ⑥ sits taut.

- ▶ Install combined cargo cover and net ③ (▷ page 282).

## Child-proof locks

### Important safety notes

#### ⚠ WARNING

When leaving the vehicle, always remove the SmartKey from the ignition lock. Always take the SmartKey with you and lock the vehicle. Do not leave children unattended in the vehicle, even if they are secured in a child restraint system, or with access to an unlocked vehicle. A child's unsupervised access to a vehicle could result in an accident and/or serious personal injury. The children could:

- injure themselves on parts of the vehicle
- be seriously or fatally injured through excessive exposure to extreme heat or cold
- injure themselves or cause an accident with vehicle equipment that can be operated even if the SmartKey is removed from the ignition lock or removed from the vehicle, such as seat adjustment, steering wheel adjustment, or the memory function

If children open a door, they could injure other persons or get out of the vehicle and injure themselves or be injured by following traffic. Do not expose the child restraint system to direct sunlight. The child restraint system's metal parts, for example, could become very hot, and the child could be burned on these parts.

### Child-proof locks for the rear doors

#### ⚠ WARNING

Children could open a rear door from inside the vehicle. This could result in serious injuries or an accident. Therefore, when

children ride in the rear always secure the rear doors with the child-proof locks.

You secure each door individually with the child-proof locks on the rear doors. A door secured with a child-proof lock cannot be opened from inside the vehicle. When the vehicle is unlocked, the door can be opened from the outside.

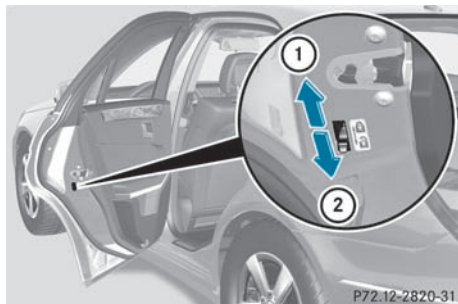

Example: Sedan

- ▶ **To activate:** press the child-proof lock lever up in the direction of arrow ①.
- ▶ Make sure that the child-proof locks are working properly.
- ▶ **To deactivate:** press the child-proof lock lever down in the direction of arrow ②.

### Override feature for the rear side windows

#### **WARNING**

When children ride on the vehicle's rear seats, activate the override switch. Otherwise, the children could be injured, e.g. by trapping themselves in the rear side window.

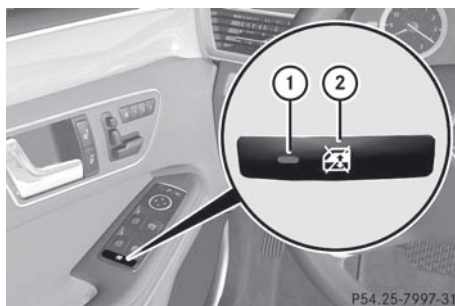

- ▶ **To activate/deactivate:** press button ②. If indicator lamp ① is lit, operation of the rear side windows is deactivated. Operation is only possible using the switches in the driver's door. If indicator lamp ① is off, operation is possible using the switches in the rear compartment.

### Panic alarm



- ▶ **To activate:** press **PANIC** button ① for at least one second. An alarm sounds and the exterior lighting flashes.
  - ▶ **To deactivate:** press **PANIC** button ① again.
- or
- ▶ Insert the SmartKey into the ignition lock.
- or
- ▶ Press the KEYLESS-GO Start/Stop button. The KEYLESS-GO key must be in the vehicle.

**i** USA only:

This device complies with Part 15 of the FCC Rules. Operation is subject to the following two conditions:

1. This device may not cause harmful interference, and
2. this device must accept any interference received, including interference that may cause undesired operation.

Any unauthorized modification to this device could void the user's authority to operate the equipment.

The product label with FCC ID and IC certification number can be found in the battery case of the SmartKey.

**i** Canada only:

This device complies with RSS-Gen of Industry Canada. Operation is subject to the following two conditions:

1. This device may not cause interference, and
2. this device must accept any interference received, including interference that may cause undesired operation.

Any unauthorized modification to this device could void the user's authority to operate the equipment.

The product label with FCC ID and IC certification number can be found in the battery case of the SmartKey.

## Driving safety systems

### Driving safety systems overview

In this section, you will find information about the following driving safety systems:

- ABS (**A**nti-**l**ock **B**raking **S**ystem)
- BAS (**B**rake **A**ssist **S**ystem)
- BAS PLUS (**B**rake **A**ssist **S**ystem Plus\*)
- ESP® (**E**lectronic **S**tability **P**rogram)
- EBD (**E**lectronic **B**rake force **D**istribution)
- ADAPTIVE BRAKE
- PRE-SAFE® Brake

### Important safety notes

#### WARNING

The following factors increase the risk of accidents:

- Excessive speed, especially in turns
- Wet and slippery road surfaces
- Following another vehicle too closely

The driving safety systems described in this section cannot reduce these risks or prevent the natural laws of physics from acting on the vehicle. They cannot increase braking or steering efficiency beyond that afforded by the condition of the vehicle brakes and tires or the traction afforded.

Only a safe, attentive, and skillful driver can prevent accidents.

The capabilities of a vehicle equipped with the driving safety systems described in this section must never be exploited in a reckless or dangerous manner which could jeopardize the user's safety or the safety of others.

Always adjust your driving style to the prevailing road and weather conditions and keep a safe distance to other road users and objects on the street.

If a driving system malfunctions, other driving safety systems may also switch off. Observe indicator and warning lamps that may come on as well as messages in the multifunction display that may appear.

- i** Please note that the driving safety systems described only work as effectively as possible when there is adequate contact between the tires and the road surface. Pay particular attention to the information regarding tires, recommended minimum tire tread depths etc. in the "Wheels and tires" section (▷ page 346).

In wintry driving conditions, always use winter tires (M+S tires) and if necessary, snow chains. Only in this way will the driving safety systems described in this section work as effectively as possible.

## ABS (Anti-lock Braking System)

### Important safety notes

- i** Observe the "Important safety notes" section (▷ page 63).

ABS regulates brake pressure in such a way that the wheels do not lock when you brake. This allows you to continue steering the vehicle when braking.

ABS works from a speed of about 5 mph (8 km/h) upwards, regardless of road-surface conditions. ABS works on slippery surfaces, even when you only brake gently.

#### WARNING

If the ABS malfunctions, other driving systems such as the BAS or the ESP® are also switched off. Observe indicator and warning lamps that may come on as well as messages in the multifunction display that may appear.

If the ABS malfunctions, the wheels may lock during hard braking, reducing the steering capability and extending the braking distance.

The  warning lamp in the instrument cluster lights up when the ignition is switched on. It goes out when the engine is running.

### Braking

If ABS intervenes when braking, you will feel a pulsing in the brake pedal.

- ▶ **If ABS intervenes:** continue to depress the brake pedal with force until the braking situation is over.
- ▶ **To make a full brake application:** depress the brake pedal with full force.

The pulsating brake pedal can be an indication of hazardous road conditions, and functions as a reminder to take extra care while driving.

#### WARNING

Do not pump the brake pedal. Use firm, steady brake pedal pressure instead. Pumping the brake pedal defeats the purpose of the ABS

and significantly reduces braking effectiveness.

## BAS (Brake Assist System)

- i** Observe the "Important safety notes" section (▷ page 63).

BAS operates in emergency braking situations. If you depress the brake pedal quickly, BAS automatically boosts the braking force, thus shortening the stopping distance.

- ▶ Keep the brake pedal firmly depressed until the emergency braking situation is over. ABS prevents the wheels from locking.

The brakes will function as usual once you release the brake pedal. BAS is deactivated.

#### WARNING

If the BAS malfunctions, the brake system still functions, but without the additional brake boost available that the BAS would normally provide in an emergency braking maneuver. Therefore, the braking distance may increase.

## BAS PLUS (Brake Assist System Plus)

BAS PLUS is only available in vehicles equipped with DISTRONIC PLUS.

- i** Observe the "Important safety notes" section (▷ page 63).

At speeds above approximately 4 mph (7 km/h), BAS PLUS assists you when braking in hazardous situations and uses the radar sensor system to evaluate the traffic conditions.

- i** This device has been approved by the FCC as a "Vehicular Radar System". The radar sensor system is intended for use in an automotive radar system only. Removing, altering or tampering with the device will void any warranties, and is not permitted by the FCC. Do not tamper with, alter, or use in any non-approved way.



Any unauthorized modification to this device could void the user's authority to operate the equipment.

With the help of the radar sensor system, BAS PLUS can detect obstacles that are in the path of your vehicle for an extended period of time.

At speeds up to approximately 40 mph (70 km/h), BAS PLUS can also detect stationary obstacles, for example stopped or parked vehicles.

Should you approach an obstacle and BAS PLUS has detected a risk of collision, BAS PLUS calculates the braking force necessary to avoid a rear-end collision.

- **At speeds up to approximately 20 mph(30 km/h):** should you apply the brakes forcefully, BAS PLUS will automatically increase the braking force to a level suitable for the traffic conditions.
- **At speeds up to approximately 20 mph(30 km/h):** should you apply the brakes, BAS PLUS is activated. Braking is performed as late as possible.

If BAS PLUS demands particularly high braking force, preventative passenger protection measures (PRE-SAFE®) are activated simultaneously.

- ▶ Keep the brake pedal depressed until the emergency braking situation is over. ABS prevents the wheels from locking.

The brakes will work normally again if:

- you release the brake pedal.
- there is no longer any danger of a rear-end collision.
- no obstacle is detected in front of your vehicle.

BAS PLUS is then deactivated.

For BAS PLUS to assist you when driving, the radar sensor system must be switched on and operational, see "Radar sensor system" in the index.

#### WARNING

BAS PLUS cannot always clearly identify objects and complex traffic situations. BAS PLUS cannot intervene in these cases.

There is a risk of an accident. Always pay careful attention to the traffic situation and be ready to brake.

In particular, the detection of obstacles can be impaired if there is:

- dirt on the sensors or anything else covering the sensors
- snow or heavy rain
- interference by other radar sources
- the possibility of strong radar reflections, for example in parking garages
- a narrow vehicle traveling in front, e.g. a motorbike
- a vehicle traveling in front on a different line

#### WARNING

BAS PLUS does not react:

- to people or animals
- to oncoming vehicles
- to crossing traffic
- in curves

As a result, BAS PLUS cannot intervene in critical situations. There is a risk of an accident. Always pay careful attention to the traffic situation and be ready to brake.

Following damage to the front end of the vehicle, have the configuration and operation of the radar sensors checked at a qualified specialist workshop. This also applies to collisions at low speeds where there is no visible damage to the front of the vehicle.

If BAS PLUS is not available due to a malfunction in the radar sensor system, the brake system remains available with full brake boosting effect and BAS.

## ESP® (Electronic Stability Program)

### Important safety notes

- i** See the "Important safety notes" section (▷ page 63).

If ESP® detects that the vehicle is deviating from the direction desired by the driver, one or more wheels are braked to stabilize the vehicle. If necessary, the engine output is also modified to keep the vehicle on the desired course within physical limits. ESP® assists the driver when pulling away on wet or slippery roads. ESP® can also stabilize the vehicle during braking.

If ESP® intervenes, the  ESP® warning lamp flashes in the instrument cluster.

#### WARNING

Under no circumstances should you deactivate ESP® when the  ESP® warning lamp in the instrument cluster flashes. Proceed as follows:

- when driving off, apply as little throttle as possible.
- while driving, ease up on the accelerator pedal.
- adapt your speed to suit the prevailing road and weather conditions.

Failure to observe these guidelines could cause the vehicle to skid. ESP® cannot prevent accidents resulting from excessive speed.

- !** Vehicles without 4MATIC: switch the ignition off when:
- the parking brake is being tested using a dynamometer
  - the vehicle is being towed with the front/rear axle raised

Application of the brakes by ESP® may otherwise destroy the brake system.

- !** Vehicles with 4MATIC: switch off the ignition when the parking brake is being tested on a brake dynamometer.

Application of the brakes by ESP® may otherwise destroy the brake system.

- i** Only use wheels with the recommended tire sizes. Only then will ESP® function properly.

## ETS/4ETS (Electronic Traction System)

#### WARNING

Observe "Important safety notes" (▷ page 63).

Traction control is part of ESP®.

Traction control brakes the drive wheels individually if they spin. This enables you to pull away and accelerate on slippery surfaces, for example if the road surface is slippery on one side. On vehicles with 4MATIC, more drive torque is also transferred to the wheel or wheels with traction.

Traction control remains active if you deactivate ESP®.

### Deactivating/activating ESP® (except AMG vehicles)

#### WARNING

ESP® should not be deactivated during normal driving other than in the circumstances described below. Disabling the system will reduce vehicle stability in driving maneuvers.

Do not deactivate ESP® when the emergency or spare wheel is mounted.

ESP® is activated automatically when the engine is started.

It may be best to deactivate ESP® in the following situations:

- when using snow chains
- in deep snow
- on sand or gravel

#### WARNING

Switch on ESP® immediately if one of the previously stated conditions is no longer met.



Otherwise, ESP® cannot stabilize the vehicle if it begins to lurch or when a wheel spins.

If you deactivate ESP®:

- ESP® no longer improves driving stability.
- the engine's torque is no longer limited and the drive wheels can spin. The spinning of the wheels results in a cutting action, which provides better grip.
- traction control is still activated.
- ESP® still provides support when you brake.



If ESP® is deactivated and one or more wheels start to spin, the  ESP® warning lamp in the instrument cluster flashes. In such situations, ESP® will not stabilize the vehicle.

► **To deactivate:** (▷ page 224).

The  ESP® OFF warning lamp in the instrument cluster lights up.

#### **WARNING**

When the  ESP® OFF warning lamp is lit, ESP® is deactivated.

If the  ESP® warning lamp and the  ESP® OFF warning lamp remain lit, ESP® is not available due to a malfunction.

When ESP® is deactivated or not operational, vehicle stability in standard driving maneuvers is reduced.

Adapt your speed and driving to the prevailing road conditions and to the non-operating status of the ESP®.

**!** Avoid spinning the driven wheels for an extended period with ESP® deactivated. You could otherwise damage the drivetrain.

► **To activate:** (▷ page 224).

The  ESP® OFF warning lamp in the instrument cluster goes out.

## Deactivating/activating ESP® (AMG vehicles)

### Activating/deactivating SPORT handling mode

#### **WARNING**

The SPORT handling mode should not be switched on during normal driving.

Switching on the SPORT handling mode will result in the following:

- no restriction to the engine torque
- system supported traction control is limited

The SPORT handling mode is designed for driving on closed tracks when the vehicle's own natural oversteer and understeer characteristics are desired and requires a highly skilled and experienced driver able to handle these critical driving situations.

You could lose control of your vehicle and cause an accident.

Please be aware of these limits when you switch on the SPORT handling mode.

Do not switch on the SPORT handling when a spare wheel is mounted.

ESP® is activated automatically when the engine is started.

It may be best to activate SPORT handling mode in the following situations:

- when using snow chains
- in deep snow
- on sand or gravel

#### **WARNING**

Switch off the SPORT handling mode and switch on the ESP® immediately if the aforementioned circumstances do not apply anymore. Otherwise the SPORT handling mode will only stabilize the vehicle to a limited extent when it is starting to skid or a wheel is spinning.

When SPORT handling mode is activated:

- ESP® only improves driving stability to a limited degree.
- the engine's torque is restricted only to a limited degree and the drive wheels can spin. The spinning of the wheels results in a cutting action, which provides better grip.
- traction control is still activated.
- ESP® still provides support when you brake firmly.

If SPORT handling mode is activated and one or more wheels start to spin, the  ESP® warning lamp in the instrument cluster flashes. ESP® only stabilizes the vehicle to a limited degree.



► **To activate:** briefly press button ①.

The  SPORT handling mode warning lamp in the instrument cluster lights up. The **SPORT handling mode** message appears in the multifunction display.

► **To deactivate:** briefly press button ①.

The  SPORT handling mode warning lamp in the instrument cluster goes out.

### Activating/deactivating ESP®

#### WARNING

The ESP® should not be switched off during normal driving.

Disabling of the system will result in the following:

- no restriction to engine torque
- loss of system-supported traction control

"ESP® OFF" is designed for driving on closed tracks when the vehicle's natural oversteer and understeer characteristics are desired and requires a highly skilled and experienced driver able to handle these critical driving situations.

You could lose control of your vehicle and cause an accident.

Please be aware of these limits when you switch off the ESP®.

Do not switch off the ESP® when a spare wheel is mounted.

ESP® is activated automatically when the engine is started.

It may be best to deactivate ESP® in the following situations:

- when using snow chains
- in deep snow
- on sand or gravel

#### WARNING

Switch on ESP® immediately if one of the previously stated conditions is no longer met. Otherwise, ESP® cannot stabilize the vehicle if it begins to lurch or when a wheel spins.



If you deactivate ESP®:

- ESP® no longer improves driving stability.
- the engine's torque is no longer limited and the drive wheels are able to spin. The spinning of the wheels results in a cutting action, which provides better grip.
- traction control is still activated.
- PRE-SAFE® is no longer available, nor is it activated if you brake firmly and ESP® intervenes.
- PRE-SAFE® Brake is no longer available, nor is it activated if you brake firmly and ESP® intervenes.
- ESP® still provides support when you brake firmly.

If ESP® is deactivated and one or more wheels start to spin, the  ESP® warning lamp in

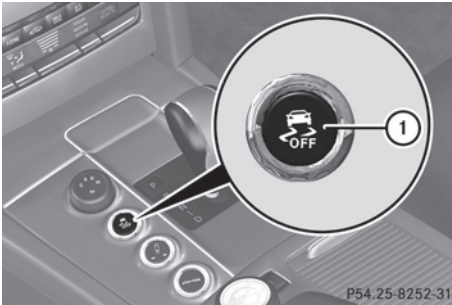

the instrument cluster does not flash. In such situations, ESP® will not stabilize the vehicle.



- ▶ **To deactivate:** press button ① until the  ESP® OFF warning lamp lights up in the instrument cluster. The  OFF message appears in the multifunction display.



#### WARNING

When the  ESP® OFF warning lamp is lit, ESP® is deactivated.

If the  ESP® warning lamp and the  ESP® OFF warning lamp remain lit, ESP® is not available due to a malfunction.

When ESP® is deactivated or not operational, vehicle stability in standard driving maneuvers is reduced.

Adapt your speed and driving to the prevailing road conditions and to the non-operating status of the ESP®.

- ! Avoid spinning the driven wheels for an extended period with ESP® deactivated. You could otherwise damage the drivetrain.
- ▶ **To activate:** briefly press button ①. The  ESP® OFF warning lamp in the instrument cluster goes out. The  ON message appears in the multifunction display.

### EBD (electronic brake force distribution)

- i Observe the "Important safety notes" section (▷ page 63).

EBD monitors and controls the brake pressure on the rear wheels to improve driving stability while braking.

#### WARNING

If EBD has malfunctioned, the braking system remains available with full brake boosting effect. However, the rear wheels can still lock, e.g. under full braking. This could cause you to lose control of your vehicle and cause an accident. You should therefore adapt your driving style to the different handling characteristics.

### ADAPTIVE BRAKE

ADAPTIVE BRAKE enhances braking safety and offers increased braking comfort. In addition to the braking function, ADAPTIVE BRAKE also has the HOLD function (▷ page 187) and hill start assist (▷ page 148). For further information, see Driving tips (▷ page 171).

### PRE-SAFE® Brake

PRE-SAFE® Brake is only available in vehicles with DISTRONIC PLUS.

- i Observe the "Important safety notes" section (▷ page 63).

PRE-SAFE® Brake can help you to minimize the risk of a frontal collision with a vehicle ahead or reduce the effects of such a collision. If PRE-SAFE® Brake has detected a risk of collision, you will be warned visually and acoustically as well as by automatic braking. PRE-SAFE® Brake cannot prevent a collision without your intervention.

At speeds above approximately 4 mph (7 km/h), this function warns you

when you are rapidly approaching the vehicle in front. An intermittent warning tone will then sound and the  distance warning lamp in the instrument cluster will light up.

► Brake immediately in order to increase the distance from the vehicle in front.

or

► Take evasive action provided it is safe to do so.

If the driver and front passenger have their seat belt fastened, PRE-SAFE® Brake can also brake the vehicle automatically at speeds from approximately 4 mph (7 km/h) to approximately 124 mph (200 km/h).

Due to the nature of the system, particularly complicated driving conditions may cause unnecessary warnings or the unnecessary intervention of PRE-SAFE® Brake. To stop the braking action, you can either depress the accelerator pedal further, activate kickdown or release the brake pedal.

The braking action of PRE-SAFE® Brake is ended automatically if:

- you maneuver to avoid the obstacle.
- there is no longer any danger of a rear-end collision.
- there is no longer an obstacle detected in front of your vehicle.

**i** USA only: this device has been approved by the FCC as a "Vehicular Radar System". The radar sensor system is intended for use in an automotive radar system only.

Removing, altering or tampering with the device will void any warranties, and is not permitted by the FCC. Do not tamper with, alter, or use in any non-approved way.

Any unauthorized modification to this device could void the user's authority to operate the equipment.

**i** Canada only: this device complies with RSS-210 of Industry Canada. Operation is subject to the following two conditions:

1. This device may not cause interference, and

2. this device must accept any interference received, including interference that may cause undesired operation of the device.

Removal, tampering, or altering of the device will void any warranties, and is not permitted. Do not tamper with, alter, or use in any non-approved way.

Any unauthorized modification to this device could void the user's authority to operate the equipment.

With the help of the radar sensor system, PRE-SAFE® Brake can detect obstacles that are in front of your vehicle for an extended period of time.

At speeds up to approximately 40 mph (70 km/h), PRE-SAFE® Brake can also react to stationary obstacles, for example stopped or parked vehicles.

If you approach an obstacle and PRE-SAFE® Brake detects a risk of collision, the system will initially alert you both visually and acoustically. If you do not brake or take evasive action, the system will warn you by automatically braking the vehicle gently. If there is an increased risk of collision, preventative passenger protection measures (PRE-SAFE®) are activated (▷ page 50). If the risk of collision remains at speeds of over 20 mph (30 km/h) and you do not brake, take evasive action or accelerate significantly, the vehicle may perform automatic braking up to emergency braking. Automatic emergency braking is not performed until immediately prior to an accident that can no longer be avoided.

#### WARNING

Even if PRE-SAFE® Brake slows the vehicle before an imminent rear-end collision, the system cannot avert a collision without the intervention of the driver. There is a risk of an accident. Brake according to the situation or take evasive action. Delayed intervention by the driver can lead to an accident.

**⚠ WARNING**

PRE-SAFE® Brake cannot always detect complex traffic situations properly.

In these cases, PRE-SAFE(R) Brake may:

- give an unnecessary warning and then brake the vehicle
- neither give a warning nor intervene

There is a risk of an accident. Always pay particular attention to the traffic situation and be ready to brake, especially if PRE-SAFE(R) Brake warns you. Terminate the intervention in a non-critical driving situation.

In particular, the detection of obstacles can be impaired if there is:

- dirt on the sensors or anything else covering the sensors
- snow or heavy rain
- interference by other radar sources
- the possibility of strong radar reflections, for example in parking garages
- a narrow vehicle traveling in front, e.g. a motorbike
- a vehicle traveling in front on a different line



**⚠ WARNING**

PRE-SAFE® Brake does not react:

- to people or animals
- to oncoming vehicles
- to crossing traffic
- in curves

As a result, PRE-SAFE® Brake cannot intervene in critical situations. There is a risk of an accident. Always pay careful attention to the traffic situation and be ready to brake.

In order to maintain the appropriate distance to the vehicle in front and thus prevent a collision, you must apply the brakes yourself.

- ▶ **To activate/deactivate:** activate or deactivate PRE-SAFE® Brake in the on-board computer (▷ page 225). The  symbol appears in the multifunction display as long as the HOLD function is not activated (▷ page 187). On vehicles with Parking Guidance, the  symbol is displayed when transmission position **P** is selected or if you drive faster than 22 mph (35 km/h).

For PRE-SAFE® Brake to assist you when driving, the radar sensor system must be switched on (▷ page 229) and operational.

Following damage to the front end of the vehicle, have the configuration and operation of the radar sensors checked at a qualified specialist workshop. This also applies to collisions at low speeds where there is no visible damage to the front of the vehicle.

**Theft deterrent locking systems****Immobilizer**

The immobilizer prevents your vehicle from being started without the correct SmartKey.

When leaving the vehicle, always take the SmartKey with you and lock the vehicle. The engine can be started by anyone with a valid SmartKey that is left inside the vehicle.

- ▶ **To activate with the SmartKey:** remove the SmartKey from the ignition lock.
- ▶ **To activate with KEYLESS-GO:** switch the ignition off and open the driver's door.
- ▶ **To deactivate:** switch on the ignition.

**i** The immobilizer is always deactivated when you start the engine.

In the event that the engine cannot be started when the starter battery is fully charged, the immobilizer may be faulty. Contact an authorized Mercedes-Benz Center or call 1-800-FOR-MERCEdes (in USA) or 1-800-387-0100 (in Canada).

**ATA (Anti-Theft Alarm system)**

A visual and audible alarm is triggered if the alarm system is armed and you open:

- a door
- the vehicle with the mechanical key
- the trunk lid/tailgate
- the hood

The alarm is not switched off, even if you close the open door that has triggered it, for example.



- i** If the alarm stays on for more than 30 seconds, the emergency call system mbrace (USA only) or TELE AID (Canada only) initiates a call to the Customer Assistance Center automatically. The emergency call system initiates the call provided that:
- you have subscribed to the mbrace/TELE AID service.
  - the mbrace/TELE AID service has been activated properly.
  - the required mobile phone, power supply and GPS are available.



- ▶ **To arm:** lock the vehicle with the SmartKey or KEYLESS-GO. Indicator lamp ① flashes. The alarm system is armed after approximately 15 seconds.
- ▶ **To deactivate:** unlock the vehicle with the SmartKey or KEYLESS-GO.

- ▶ **To stop the alarm using the SmartKey:** insert the SmartKey into the ignition lock. The alarm is switched off.

or

- ▶ Press the  or  button on the SmartKey. The alarm is switched off.

- ▶ **To stop the alarm using KEYLESS-GO:** grasp the outside door handle. The SmartKey must be outside the vehicle. The alarm is switched off.

or

- ▶ Press the Start/Stop button on the dashboard. The SmartKey must be inside the vehicle. The alarm is switched off.

Useful information .....	74
SmartKey .....	74
Doors .....	82
Trunk/cargo compartment .....	84
Side windows .....	90
Sliding sunroof .....	93



## Useful information

- i** This Operator's Manual describes all models and all standard and optional equipment of your vehicle available at the time of publication of the Operator's Manual. Country-specific differences are possible. Please note that your vehicle may not be equipped with all features described. This also applies to safety-related systems and functions.
- i** Please read the information on qualified specialist workshops (▷ page 25).

## SmartKey

### Important safety notes

#### WARNING

When leaving the vehicle, always remove the SmartKey from the ignition lock. Always take the SmartKey with you and lock the vehicle. Do not leave children unsupervised in the vehicle, even if they are secured in a child restraint system, and do not give them access to an unlocked vehicle. A child's unsupervised access to a vehicle could result in an accident and/or serious personal injury. They could:

- injure themselves on vehicle parts
- be seriously or fatally injured by extreme heat or cold
- injure themselves or have an accident with vehicle equipment that may still be in operation even after the SmartKey has been removed from the ignition, such as the seat adjustment, steering wheel adjustment or memory function.

If children open a door, they could cause severe or even fatal injury to other persons; if they get out of the vehicle, they could injure themselves when doing so or be seriously or even fatally injured by any passing traffic.

Do not expose the child restraint system to direct sunlight. The child restraint system's metal parts, for example, could become very

hot, and a child could be burned on these parts.

#### WARNING

If a key ring is too heavy or too large, the weight acting on the key could cause it to turn in the ignition lock or catch on the steering wheel. This could cause the engine to be switched off suddenly. You could lose control of the vehicle and cause an accident. Do not attach any heavy or large key rings to the key that is inserted in the ignition.

### General notes

If you cannot lock or unlock the vehicle with the SmartKey, either the battery in the SmartKey is discharged, the SmartKey is faulty or the starter battery is discharged.

- ▶ Check the battery in the SmartKey and replace it if necessary (▷ page 78).
- ▶ Unlock the driver's door using the mechanical key (▷ page 83).
- ▶ Lock the vehicle using the mechanical key (▷ page 84).
- ▶ Have the starter battery and the battery contacts checked at a qualified specialist workshop.

If the SmartKey is faulty, contact Roadside Assistance or a qualified specialist workshop.

### SmartKey functions

#### General notes

- i** USA only:

This device complies with Part 15 of the FCC Rules. Operation is subject to the following two conditions:

1. This device may not cause harmful interference, and
2. this device must accept any interference received, including interference that may cause undesired operation.



Any unauthorized modification to this device could void the user's authority to operate the equipment.

The Product label with FCC ID and IC certification number can be found in the battery case of the SmartKey.

**i** Canada only:

This device complies with RSS-210 of Industry Canada. Operation is subject to the following two conditions:

1. This device may not cause interference, and
2. this device must accept any interference received, including interference that may cause undesired operation of the device.

Any unauthorized modification to this device could void the user's authority to operate the equipment.

The Product label with FCC ID and IC certification number can be found in the battery case of the SmartKey.



### Locking and unlocking centrally

The SmartKey centrally locks/unlocks:

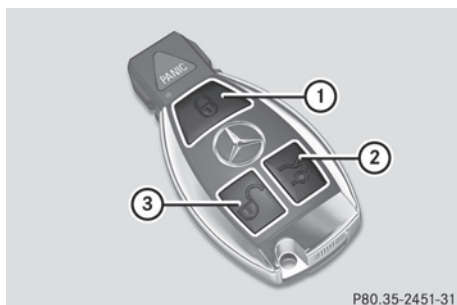
- the doors
- the trunk lid/tailgate
- the fuel filler flap



P80.35-2451-31

- ①  Locks the vehicle
- ②  Unlocks the trunk lid/tailgate
- ③  Unlocks the vehicle

When unlocking, the turn signals flash once. When locking, they flash three times.

When it is dark, the surround lighting also comes on if it is activated in the on-board computer (▷ page 227).

If you activate the acoustic locking confirmation function, you will hear the following, depending on the date of production of the vehicle:

- an acoustic signal when locking or
- one acoustic signal when unlocking and three when locking.

The audible signal can be activated and deactivated using the on-board computer (▷ page 228).

► **To unlock centrally:** press the  button.

If you do not open the vehicle within approximately 40 seconds of unlocking:

- the vehicle is locked again.
- the theft deterrent locking system is armed again.

► **To lock centrally:** press the  button.

### KEYLESS-GO

#### General notes

**i** USA only:

This device complies with Part 15 of the FCC Rules. Operation is subject to the following two conditions:

1. This device may not cause harmful interference, and
2. this device must accept any interference received, including interference that may cause undesired operation.

Any unauthorized modification to this device could void the user's authority to operate the equipment.

The Product label with FCC ID and IC certification number can be found in the battery case of the SmartKey.

**i** Canada only:

This device complies with RSS-210 of Industry Canada. Operation is subject to the following two conditions:

1. This device may not cause harmful interference, and
2. this device must accept any interference received, including interference that may cause undesired operation.

Any unauthorized modification to this device could void the user's authority to operate the equipment.

The Product label with FCC ID and IC certification number can be found in the battery case of the SmartKey.

### Important notes on the use of KEYLESS-GO

- The KEYLESS-GO key can be used like a conventional key.
- You can combine KEYLESS-GO functions with those of a conventional key, e.g. unlock with KEYLESS-GO and lock with the  button.
- Always carry your KEYLESS-GO key on your person.
- Do not keep the KEYLESS-GO key together with:
  - electronic devices, e.g. a mobile phone or another key
  - metallic objects, e.g. coins or metal foil.

This can affect the functionality of KEYLESS-GO.

- When locking and unlocking using KEYLESS-GO, the distance between the SmartKey and the corresponding door handle must not exceed 3 ft (1 m).
- If the vehicle is parked for more than 72 hours, the KEYLESS-GO function is deactivated. Pull the outer door handle and switch on the ignition to reactivate the KEYLESS-GO function.
- If the KEYLESS-GO key is removed from the vehicle, it is possible that the system may not recognize the SmartKey. The vehicle

can then not be locked or started using KEYLESS-GO.

- If the KEYLESS-GO key has been removed from the vehicle, e.g. if a passenger leaves the vehicle with a KEYLESS-GO key:
  - if the start/stop button is pressed or if an attempt is made to lock the vehicle with the locking button on the outer door handle, the **Key Not Detected** message appears in the multifunction display
  - when the engine is running, the red **Key Not Detected** message appears in the multifunction display as you pull away. Find the KEYLESS-GO key and change its position in the vehicle. Carry the KEYLESS-GO key in your shirt pocket, for example.
- If you have started the engine with the Start/Stop button, you can switch it off again by:
  - pressing the Start/Stop button again
  - inserting the KEYLESS-GO key into the ignition lock if the vehicle is stationary and the automatic transmission is in park position **P**.
- You could unlock the vehicle by mistake if the distance between the KEYLESS-GO key and the vehicle is less than 3 ft (1 m) and:
  - an exterior door handle is hit by a water jet
  - or
  - you clean an exterior door handle.
- Bear in mind that the engine can be started by any of the vehicle occupants if there is a KEYLESS-GO key in the vehicle.

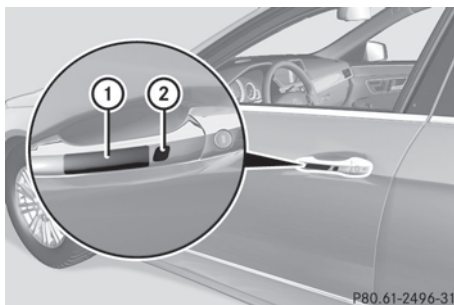





- ▶ **To unlock the vehicle:** touch the inner surface of the door handle.
- ▶ **To lock the vehicle:** touch sensor surface ①.
- ▶ **Convenience closing feature:** touch recessed sensor surface ② for an extended period (▷ page 92).



If you pull on the handle of the trunk lid/tailgate, only the trunk/cargo compartment of the vehicle is unlocked.

### Changing the settings of the locking system

You can change the setting of the locking system in such a way that only the driver's door and the fuel filler flap are unlocked. This is useful if you frequently travel on your own.

- ▶ **To change the setting:** press and hold down the  and  buttons simultaneously for approximately six seconds until the battery check lamp (▷ page 78) flashes twice.
- i** If the setting of the locking system is changed within the signal range of the vehicle, pressing the  or  button locks or unlocks the vehicle.



The SmartKey now functions as follows:

- ▶ **To unlock the driver's door:** press the  button once.
- ▶ **To unlock centrally:** press the  button twice.
- ▶ **To lock centrally:** press the  button.

The KEYLESS-GO function is changed as follows:

- ▶ **To unlock the driver's door:** touch the inner surface of the door handle on the driver's door.
- ▶ **To unlock centrally:** touch the inner surface of the door handle on the front-passenger door or the rear door.
- ▶ **To lock centrally:** touch the outer sensor surface on one of the door handles.

### Restoring the factory settings

- ▶ Press the  and  buttons simultaneously for approximately six seconds until the battery check lamp flashes twice.



### Mechanical key

#### General notes

If the vehicle can no longer be locked or unlocked with the SmartKey, use the mechanical key.

If you use the mechanical key to unlock and open the driver's door or the trunk lid/tailgate, the anti-theft alarm system will be triggered (▷ page 72).

There are several ways to turn off the alarm:

- ▶ **To turn the alarm off with the SmartKey:** press the  or  button on the SmartKey.

or

- ▶ Insert the SmartKey into the ignition lock.

or

- ▶ **To deactivate the alarm with KEYLESS-GO:** press the Start/Stop button in the ignition lock. The SmartKey must be in the vehicle.

or

- ▶ Lock or unlock the vehicle using KEYLESS-GO. The SmartKey must be outside the vehicle.

If you unlock the vehicle using the mechanical key, the fuel filler flap will not be unlocked automatically.

- ▶ **To unlock the fuel filler flap:** insert the SmartKey in the ignition lock.

## Removing the mechanical key



- ▶ Push release catch ① in the direction of the arrow and at the same time, remove mechanical key ② from the SmartKey.

## SmartKey battery

### Important safety notes

Have the batteries changed at a qualified specialist workshop.

#### WARNING



Batteries contain toxic substances. Swallowing batteries can lead to serious health issues or death. Keep batteries out of the reach of children. Seek medical attention immediately if a battery is swallowed.

#### WARNING

The SmartKey batteries contain perchlorate material, which may require special handling and regard for the environment. Observe government disposal guidelines. California residents, see [www.dtsc.ca.gov/HazardousWaste/Perchlorate/index.cfm](http://www.dtsc.ca.gov/HazardousWaste/Perchlorate/index.cfm).



## Checking the battery



- ▶ Press the  or  button. The battery is working properly if battery check lamp ① lights up briefly

If battery check lamp ① does not light up briefly during the test, the battery is discharged.

- ▶ Changing the battery (▷ page 78)

- i** You can obtain the battery at a qualified specialist workshop.
- i** If the SmartKey battery is checked within the signal reception range of the vehicle, pressing the  or  button locks or unlocks the vehicle.

## Changing the battery

You require a CR 2025 3 V cell battery.

- ▶ Take the mechanical key out of the SmartKey (▷ page 77).

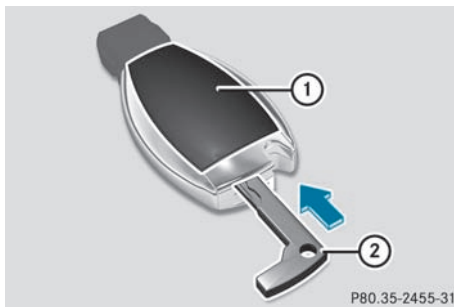

- ▶ Press mechanical key ② into the opening in the SmartKey in the direction of the





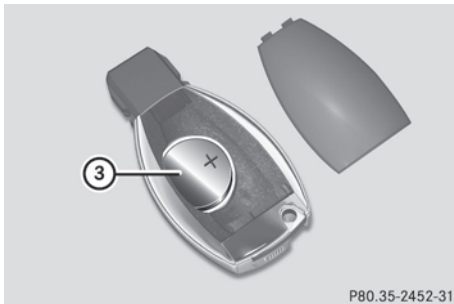

arrow until battery tray cover ① opens.  
When doing so, do not hold cover ① shut.

- ▶ Remove battery tray cover ①.



- ▶ Repeatedly tap the SmartKey against your palm until battery ③ falls out.
- ▶ Insert the new battery with the positive terminal facing upwards. Use a lint-free cloth to do so.
- ▶ Make sure that the surface of the battery is free from lint, grease and all other forms of contamination.
- ▶ Insert the front tabs of battery tray cover ① and then press to close it.
- ▶ Insert the mechanical key into the SmartKey.
- ▶ Check the function of all SmartKey buttons on the vehicle.

## Problems with the SmartKey

Problem	Possible causes/consequences and ► Solutions
<p>You cannot lock or unlock the vehicle using the SmartKey.</p>	<p>The SmartKey battery is discharged or nearly discharged.</p> <ul style="list-style-type: none"> <li>► Try again to lock/unlock the vehicle using the remote control function of the SmartKey. Point the tip of the SmartKey at the driver's door handle from close range and press the  /  button.</li> </ul> <p>If this does not work:</p> <ul style="list-style-type: none"> <li>► Check the SmartKey battery (▷ page 78) and replace it if necessary (▷ page 78).</li> <li>► Lock (▷ page 83) or unlock (▷ page 84) the vehicle using the mechanical key.</li> </ul> <p>The SmartKey is faulty.</p> <ul style="list-style-type: none"> <li>► Lock (▷ page 83) or unlock (▷ page 84) the vehicle using the mechanical key.</li> <li>► Have the SmartKey checked at a qualified specialist workshop.</li> </ul>
<p>You can no longer lock or unlock the vehicle using KEYLESS-GO.</p>	<p>KEYLESS-GO is in standby mode because the vehicle has not been unlocked for an extended period.</p> <ul style="list-style-type: none"> <li>► Pull the door handle and then turn the SmartKey to position <b>2</b> in the ignition lock.</li> </ul> <p>There is interference from a powerful source of radio waves.</p> <ul style="list-style-type: none"> <li>► Lock/unlock the vehicle using the remote control function of the SmartKey. Point the tip of the SmartKey at the driver's door handle from close range and press the  /  button.</li> </ul> <p>There is a malfunction with KEYLESS-GO.</p> <ul style="list-style-type: none"> <li>► Lock/unlock the vehicle using the remote control function of the SmartKey. Point the tip of the SmartKey at the driver's door handle from close range and press the  /  button.</li> <li>► Have KEYLESS-GO checked at a qualified specialist workshop.</li> </ul> <p>If this does not work:</p> <ul style="list-style-type: none"> <li>► Check the SmartKey battery (▷ page 78) and replace it if necessary (▷ page 78).</li> <li>► Lock (▷ page 83) or unlock (▷ page 84) the vehicle using the mechanical key.</li> </ul>
<p>You have lost a SmartKey.</p>	<ul style="list-style-type: none"> <li>► Have the SmartKey deactivated at a qualified specialist workshop.</li> <li>► Report the loss immediately to the vehicle insurers.</li> <li>► If necessary, have the locks changed as well.</li> </ul>

Problem	Possible causes/consequences and ► Solutions
You have lost the mechanical key.	<ul style="list-style-type: none"> <li>► Report the loss immediately to the vehicle insurers.</li> <li>► If necessary, have the locks changed as well.</li> </ul>
The engine cannot be started using the SmartKey.	<p>The on-board voltage is too low.</p> <ul style="list-style-type: none"> <li>► Switch off non-essential consumers, e.g. seat heating or interior lighting, and try to start the engine again.</li> </ul> <p>If this does not work:</p> <ul style="list-style-type: none"> <li>► Check the starter battery and charge it if necessary (▷ page 335).</li> </ul> <p>or</p> <ul style="list-style-type: none"> <li>► Jump-start the vehicle (▷ page 338).</li> </ul> <p>or</p> <ul style="list-style-type: none"> <li>► Consult a qualified specialist workshop.</li> </ul>
The engine cannot be started using the SmartKey.	<p>The steering lock is mechanically blocked<sup>3</sup>.</p> <ul style="list-style-type: none"> <li>► Remove the SmartKey and reinsert it into the ignition lock. While doing this, turn the steering wheel in both directions.</li> </ul>
The engine cannot be started using KEYLESS-GO. The SmartKey is in the vehicle.	<p>A door is open. Therefore, the SmartKey cannot be detected as easily.</p> <ul style="list-style-type: none"> <li>► Close the door and try to start the vehicle again.</li> </ul>
	<p>There is interference from a powerful source of radio waves.</p> <ul style="list-style-type: none"> <li>► Start your vehicle with the SmartKey in the ignition lock.</li> </ul>

<sup>3</sup> Not on vehicles with DIRECT SELECT lever.

## Doors

## Important safety notes

**⚠ WARNING**

When leaving the vehicle, always remove the SmartKey from the ignition lock. Always take the SmartKey with you and lock the vehicle. Do not leave children unsupervised in the vehicle, even if they are secured in a child restraint system, and do not give them access to an unlocked vehicle. A child's unsupervised access to a vehicle could result in an accident and/or serious personal injury. They could:

- injure themselves on vehicle parts
- be seriously or fatally injured by extreme heat or cold
- injure themselves or have an accident with vehicle equipment that may still be in operation even after the SmartKey has been removed from the ignition, such as the seat adjustment, steering wheel adjustment or memory function.

If children open a door, they could cause severe or even fatal injury to other persons; if they get out of the vehicle, they could injure themselves when doing so or be seriously or even fatally injured by any passing traffic.

Do not expose the child restraint system to direct sunlight. The child restraint system's metal parts, for example, could become very hot, and a child could be burned on these parts.

**⚠ WARNING**

Do not carry heavy or hard objects in the passenger compartment or trunk/cargo compartment unless they are firmly secured in place.

Unsecured or improperly positioned cargo increases a child's risk of injury in the event of

- strong braking maneuvers
- sudden changes of direction
- an accident

**Unlocking and opening doors from the inside**

You can open a door from inside the vehicle even if it has been locked. You can only open the rear doors from inside the vehicle if they are not secured by the child-proof locks (▷ page 61).

Only open the door when the traffic situation permits.

If the vehicle was previously locked with the SmartKey or with KEYLESS-GO, opening the vehicle from the inside will activate the anti-theft alarm system. Switch off the alarm (▷ page 72).

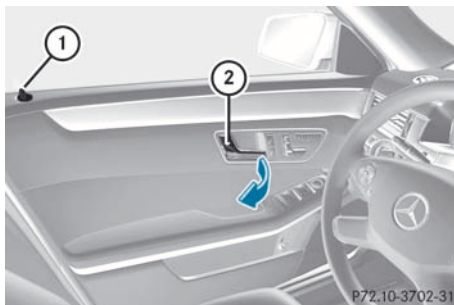

- ▶ Pull door handle ②.

If the door is locked, locking knob ① pops up. The door is unlocked and can be opened.

**Centrally locking and unlocking the vehicle from the inside**

You can centrally lock or unlock the vehicle from the inside.

The central locking/unlocking button does not lock or unlock the fuel filler flap.

- i** You cannot unlock the vehicle centrally from the inside if the vehicle has been locked with the SmartKey or KEYLESS-GO.



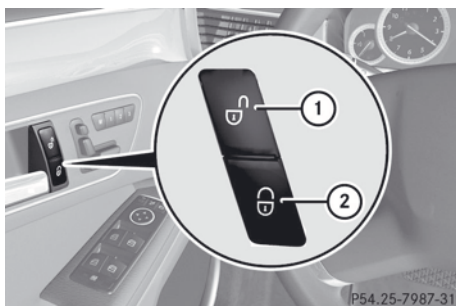

► **To unlock:** press button ①.

► **To lock:** press button ②.

If all the doors are closed, the vehicle locks.

You can open a front door from inside the vehicle even if it has been locked. Only open the door when the traffic situation permits.

If the vehicle has been locked with the central locking button:

- and the SmartKey is set to its factory setting, the entire vehicle is unlocked if a front door is opened from the inside
- and the SmartKey is set to an individual setting, only the front door that is opened from inside the vehicle is unlocked.

If the vehicle has been locked centrally with the SmartKey or with KEYLESS-GO, it is not unlocked when the release button for the central locking is used.

### Automatic locking feature

The vehicle locks automatically when the ignition is switched on and the wheels of the vehicle are turning at a speed of more than 9 mph (15 km/h).

You could therefore be locked out when:

- the vehicle is being pushed.
- the vehicle is being towed.
- the vehicle is being tested on a dynamometer.

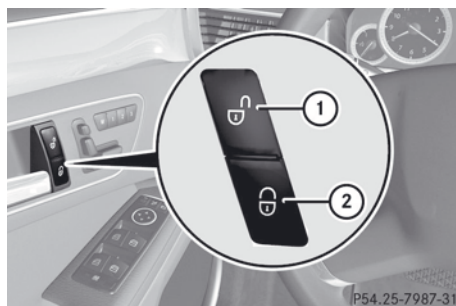

► **To deactivate:** press and hold button ① for about five seconds until a tone sounds.

► **To activate:** press and hold button ② for about five seconds until a tone sounds.

**i** If you press one of the two buttons and do not hear a tone, the relevant setting has already been selected.

You can also switch the automatic locking function on and off using the on-board computer (▷ page 228).

### Unlocking the driver's door (mechanical key)

If the vehicle can no longer be unlocked with the SmartKey, use the mechanical key.

If you use the mechanical key to unlock and open the driver's door, the anti-theft alarm system will be triggered (▷ page 72).

► Take the mechanical key out of the SmartKey (▷ page 77).

► Insert the mechanical key into the lock of the driver's door as far as it will go.

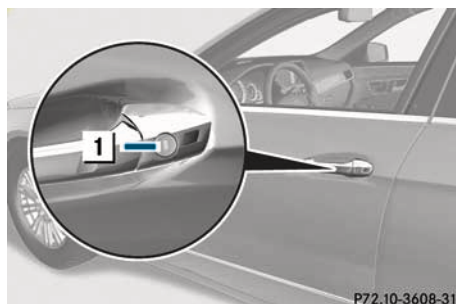

- ▶ Turn the mechanical key counterclockwise to position **1**.  
The door is unlocked.
- ▶ Turn the mechanical key back and remove it.
- ▶ Insert the mechanical key into the SmartKey.

### Locking the vehicle (mechanical key)

If the vehicle can no longer be locked with the SmartKey, use the mechanical key.

- ▶ Open the driver's door.
- ▶ Close the front-passenger door, the rear doors and the trunk lid/tailgate.
- ▶ Press the locking button (▷ page 82).
- ▶ Check whether the locking knobs on the front-passenger door and the rear doors are still visible. Press down the locking knobs by hand, if necessary.
- ▶ Close the driver's door.
- ▶ Take the mechanical key out of the SmartKey (▷ page 77).
- ▶ Insert the mechanical key into the lock of the driver's door as far as it will go.

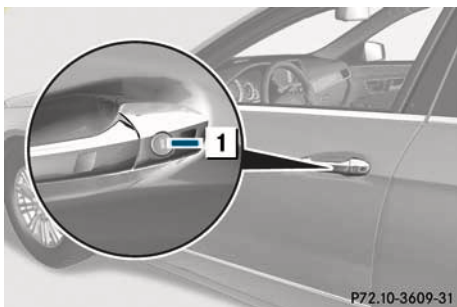

- ▶ Turn the mechanical key clockwise as far as it will go to position **1**.
- ▶ Turn the mechanical key back and remove it.
- ▶ Make sure that the doors and the trunk lid/tailgate are locked.
- ▶ Insert the mechanical key into the SmartKey.

- i** If you lock the vehicle as described above, the fuel filler flap is not locked. The anti-theft alarm system is not armed.

### Trunk/cargo compartment

#### Important safety notes

Do not leave the SmartKey in the trunk/cargo compartment. You could otherwise lock yourself out.

#### **⚠ WARNING**

When leaving the vehicle, always remove the SmartKey from the ignition lock. Always take the SmartKey with you and lock the vehicle. Do not leave children unsupervised in the vehicle, even if they are secured in a child restraint system, and do not give them access to an unlocked vehicle. A child's unsupervised access to a vehicle could result in an accident and/or serious personal injury. They could:

- injure themselves on vehicle parts
- be seriously or fatally injured by extreme heat or cold
- injure themselves or have an accident with vehicle equipment that may still be in operation even after the SmartKey has been removed from the ignition, such as the seat adjustment, steering wheel adjustment or memory function.

If children open a door, they could cause severe or even fatal injury to other persons; if they get out of the vehicle, they could injure themselves when doing so or be seriously or even fatally injured by any passing traffic.

Do not expose the child restraint system to direct sunlight. The child restraint system's metal parts, for example, could become very hot, and a child could be burned on these parts.

#### **⚠ WARNING**

Do not carry heavy or hard objects in the passenger compartment or trunk/cargo

compartment unless they are firmly secured in place.

Unsecured or improperly positioned cargo increases a child's risk of injury in the event of

- strong braking maneuvers
- sudden changes of direction
- an accident

### **WARNING**

Ensure that the trunk/tailgate is closed when the engine is running and the vehicle is in motion. Among other dangers, deadly carbon monoxide (CO) may enter the vehicle interior and cause unconsciousness and even death.

- ! The trunk lid/tailgate swings upwards and to the rear when opened. Therefore, make sure that there is sufficient clearance above and behind the trunk lid/tailgate.

**Sedan:** to open the trunk lid completely, a minimum clearance of 5.78 ft (1.76 m) above the ground is necessary.

**Wagon:** to open the tailgate completely, a minimum clearance of 6.36 ft (1.94 m) above the ground is necessary.

**Sedan without trunk lid remote closing feature:** the trunk lid can be:

- opened and closed manually from outside
- opened automatically from outside
- opened automatically from inside
- locked separately
- opened with the emergency release button
- unlocked with the mechanical key

**Sedan with trunk lid remote closing feature:** the trunk lid can be:

- opened and closed manually from outside
- opened and closed automatically from outside
- opened and closed automatically from inside
- locked separately

- opened with the emergency release button
- unlocked with the mechanical key

**Wagon:** you can:

- open and close the tailgate manually from outside
- open the tailgate manually from inside (Wagon with a folding bench seat)
- open and close the tailgate automatically from outside
- open and close the tailgate automatically from inside
- limit the opening angle of the tailgate
- unlock the tailgate using the mechanical key.

## Opening and closing manually

### Opening

- ▶ Press the  button on the SmartKey.

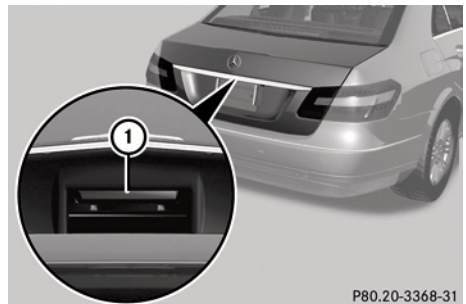

P80.20-3368-31

Handle (example: Sedan)

- ▶ Sedan: pull handle ①.
- ▶ Raise the trunk lid.

**Wagon:** if you pull handle ① and keep it in this position, you can open the tailgate manually. If you release the handle, the tailgate opens automatically.

### Closing

#### **WARNING**

To prevent possible personal injury, always keep hands and fingers away from the trunk/

cargo compartment opening when closing the trunk lid/tailgate. Be especially careful when small children are around.



Recess (example: Sedan)

- ▶ Pull the trunk lid/tailgate down using recess ①.
- ▶ **Wagon:** push the tailgate closed from outside the vehicle.
- ▶ If necessary, lock the vehicle with the  button on the SmartKey (▶ page 74) or with KEYLESS-GO (▶ page 75).
- ▶ **i** If a KEYLESS-GO key is detected in the trunk/cargo compartment, the trunk lid/tailgate will not lock.  
Sedan: the trunk lid then opens again.

### Opening the tailgate from inside the vehicle (Wagon with a folding bench seat)

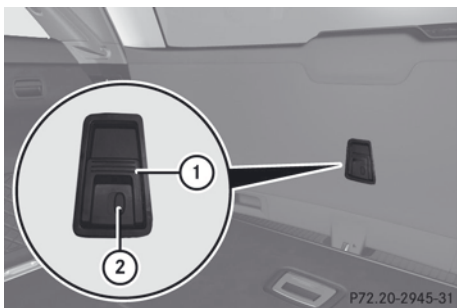

Inside of tailgate

- ▶ **To unlock the tailgate:** slide locking catch ② to the right.
- ▶ **To open:** pull the top of handle ①.
- ▶ Swing the tailgate upwards.
- ▶ **To lock the tailgate:** slide locking catch ② to the left.

### Opening/closing automatically from outside

#### Important safety notes

#### WARNING

Ensure that the trunk lid/tailgate is closed when the engine is running and the vehicle is in motion. Among other dangers, deadly carbon monoxide (CO) may enter the vehicle interior and cause unconsciousness and even death.

- ▶ **!** The trunk lid/tailgate swings upwards and to the rear when opened. Therefore, make sure that there is sufficient clearance above and behind the trunk lid/tailgate.

**Sedan:** to open the trunk lid completely, a minimum clearance of 5.78 ft (1.76 m) above the ground is necessary.

**Wagon:** to open the tailgate completely, a minimum clearance of 6.36 ft (1.94 m) above the ground is necessary.

#### Opening

You can open the trunk lid/tailgate automatically using the SmartKey or the handle in the trunk lid/tailgate.

- ▶ Press and hold the  button on the SmartKey until the trunk lid/tailgate opens.

or

- ▶ When the trunk lid/tailgate is unlocked, pull the trunk lid/tailgate handle and let it go again immediately.

## Closing

### WARNING

Monitor the closing procedure carefully to make sure no one is in danger of being injured. To prevent possible personal injury, always keep hands and fingers away from the trunk opening when closing the trunk lid. Be especially careful when small children are around. To stop the closing procedure, do one of the following:

- Press button  on the SmartKey.
- Press the remote trunk opening/closing switch (on the driver's door).
- Press the trunk closing switch.
- Press the KEYLESS-GO locking/closing switch.
- Pull the trunk lid handle.

Even with the SmartKey removed from the starter switch or the SmartKey with KEYLESS-GO removed from the vehicle, the remote trunk opening/closing switch can be operated. Therefore, do not leave children unattended in the vehicle, or with access to an unlocked vehicle. A child's unsupervised access to a vehicle could result in an accident and/or serious personal injury.

**Sedan:** you can close the trunk lid automatically using the closing button<sup>4</sup> or the locking button<sup>5</sup>.

**Wagon:** you can close the tailgate automatically using either the closing button or the locking button<sup>6</sup>.

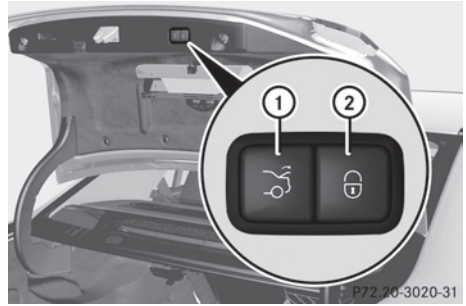

Closing button and locking button (example: Sedan)

- ▶ **To close:** press closing button ① in the trunk lid/tailgate.
- ▶ **To close and lock simultaneously:** Press closing button ② in the trunk lid/tailgate.

**i** If you leave a KEYLESS-GO key in the trunk/cargo compartment, the trunk lid/tailgate will not lock.

### Opening/closing automatically from inside

#### WARNING

Keep an eye on the area at the rear end of the vehicle when operating the trunk lid/tailgate with the remote operating switch on the door. Monitor the entire closing procedure to ensure that there is no risk of injury to anyone near the vehicle.

Release the switch on the door to interrupt the closing procedure.

The remote operating switch can also be used if the SmartKey has been removed from the starter switch or the KEYLESS-GO key has been removed from the vehicle. Never leave children with no adult supervision in the vehicle or with access to an unlocked vehicle. If unsupervised children have access to a

<sup>4</sup> For vehicles with the trunk lid remote closing feature only.

<sup>5</sup> For vehicles with the trunk lid remote closing feature and KEYLESS-GO only.

<sup>6</sup> For vehicles with KEYLESS-GO only.

vehicle, it could lead to an accident and/or serious injury.

### WARNING

Ensure that the trunk lid/tailgate is closed when the engine is running and the vehicle is in motion. Among other dangers, deadly carbon monoxide (CO) may enter the vehicle interior and cause unconsciousness and even death.

You can open and close the trunk lid/tailgate from the driver's seat when the vehicle is stationary and unlocked.



- ▶ **To open:** pull remote operating switch for trunk lid/tailgate ① until the trunk lid/tailgate opens.
- ▶ **To close (Sedan):** press remote operating switch for trunk lid ① until the trunk lid is closed.
- ▶ **To close (Wagon):** turn the SmartKey to position **1** or **2** in the ignition lock.
- ▶ Press remote operating switch for tailgate ① until the tailgate is closed.

### Limiting the opening angle of the tailgate (Wagon)

#### Important safety notes

You can limit the opening angle of the tailgate. This is possible in the top half of its opening range, up to approximately 8 in (20 cm) before the stop.

**!** Make sure there is sufficient clearance to open the tailgate fully when setting the opening angle. The tailgate could otherwise be damaged. Ideally, set the opening angle outside.

#### Activating

- ▶ **To open the tailgate:** pull the handle on the tailgate.
- ▶ **To stop the opening procedure at the desired position:** press the closing button (▷ page 86) in the tailgate or pull the handle on the outside of the tailgate again.
- ▶ **To store the position:** press and hold the closing button in the tailgate until you hear a short tone. The opening angle limiter is activated. The tailgate will now stop in the stored position when opening.

#### Deactivating

- ▶ Press and hold the closing button (▷ page 86) in the tailgate until you hear two short tones.

#### Locking the trunk separately (Sedan)

You can lock the trunk separately. If you then unlock the vehicle centrally, the trunk remains locked and cannot be opened.

- ▶ Close the trunk lid.
- ▶ Take the mechanical key out of the SmartKey (▷ page 77).

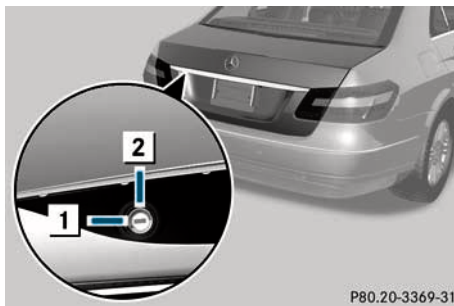

P54.25-7985-31

P80.20-3369-31



- ▶ Insert the mechanical key into the trunk lid lock as far as the stop.
- ▶ Turn the mechanical key clockwise from position **1** to position **2**.
- ▶ Remove the mechanical key.
- ▶ Insert the mechanical key into the SmartKey.

### Unlocking the trunk (Sedan)

- ⚠ The trunk lid swings upwards when opened. Therefore, make sure that there is sufficient clearance above the trunk lid.

If the trunk cannot be unlocked with the SmartKey or KEYLESS-GO, use the mechanical key.

If you use the mechanical key to unlock and open the trunk lid, the anti-theft alarm system will be triggered (▷ page 72).

- ▶ Take the mechanical key out of the SmartKey (▷ page 77).
- ▶ Insert the mechanical key into the trunk lid lock as far as the stop.

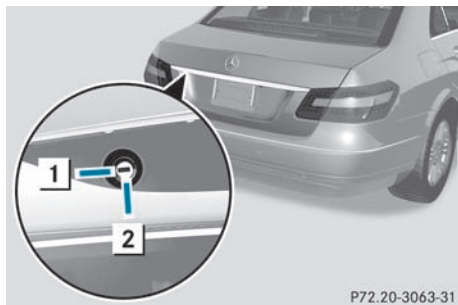

- ▶ Turn the mechanical key counter-clockwise from position **1** as far as it will go to position **2**.  
The trunk is unlocked.
- ▶ Turn the mechanical key back to position **1** and remove it.
- ▶ Insert the mechanical key into the SmartKey.

### Trunk emergency release (Sedan)

You can open the trunk lid from inside the vehicle with the emergency release button.



- ▶ Briefly press emergency release button **1**.  
The trunk lid unlocks and opens.

The trunk lid can be unlocked and opened with the trunk lid emergency release when the vehicle is stationary or while driving.

Trunk lid emergency release light:

- emergency release button **1** flashes for 30 minutes after the trunk lid is opened.
- emergency release button **1** flashes for 60 minutes after the trunk lid is closed.

The trunk lid emergency release does not open the trunk lid if the battery is disconnected or discharged.

### Tailgate emergency release (Wagon)

If the tailgate can no longer be opened from outside the vehicle, use the emergency release on inside of the tailgate.

On vehicles with a folding bench seat you can open the tailgate from inside the vehicle using the handle.

- ▶ Take the mechanical key out of the SmartKey (▷ page 77).

To open the tailgate completely, a minimum clearance of 6.36 ft (1.94 m) above the ground is necessary.

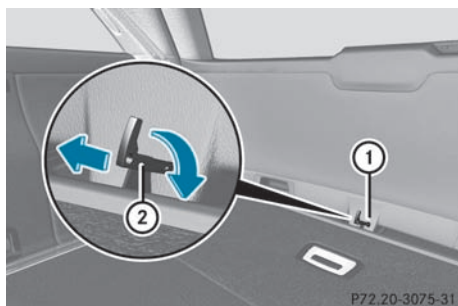

P72.20-3075-31

**!** The tailgate swings upwards and to the rear when opened. Therefore, make sure that there is sufficient clearance above and behind the tailgate.

- ▶ Insert mechanical key ② into opening in trim ①.
- ▶ Turn mechanical key ② 90° clockwise.
- ▶ Push mechanical key ② in the direction of the arrow and open the tailgate.

## Side windows

### Important safety notes

#### WARNING

When opening or closing the door windows, make sure that there is no danger of anyone being harmed by the opening/closing procedure.

The door windows are equipped with automatic operation and the anti-entrapment feature. If in automatic mode a door window encounters an obstruction that blocks its path, the anti-entrapment feature will stop the door window and open it slightly.

The door windows operate differently when the switch is pulled. See the "Problems with door windows" section for details.

The closing of the door windows can be immediately halted by releasing the switch or, if the switch was pulled past the resistance point and released, by either pressing or pulling the respective switch.

If a door window encounters an obstruction that blocks its path in a circumstance where you are closing the windows by pressing and holding the  button on the SmartKey or by pressing and holding the lock button (vehicles with KEYLESS-GO) on an outside door handle, the anti-entrapment feature will not operate.

Activate the override switch when children are riding in the back seats of the vehicle. The children may otherwise injure themselves, e.g. by becoming trapped in the door window opening.

#### WARNING

Do not keep any part of your body up against the window pane when opening a window. The downward motion of the pane may pull that part of your body down between the window pane and the door frame and trap it there. If there is a risk of entrapment, release the switch and pull it to close the window.

### Opening and closing the side windows

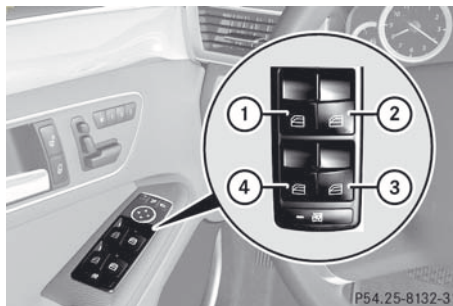

P54.25-8132-31

- ① Front left
- ② Front right
- ③ Rear right
- ④ Rear left

The switches for all side windows are located on the driver's door. There is also a switch on each door for the corresponding side window.



The switches on the driver's door take precedence.



- i** The side windows cannot be operated from the rear when the override feature for the side windows is activated (▷ page 62).
- ▶ Turn the SmartKey to position **1** or **2** in the ignition lock.
- ▶ **To open:** press the corresponding switch.
- ▶ **To close:** pull the corresponding switch.
- i** If you press the switch beyond the point of resistance, an automatic opening/closing process is started in the corresponding direction. You can stop automatic operation by operating the switch again.
- i** You can continue to operate the side windows after you switch off the engine or remove the SmartKey. This function is available for up to five minutes or until the driver's or front-passenger door is opened.

### Convenience opening feature

You can ventilate the vehicle before you start driving. To do this, the key is used to carry out the following functions simultaneously:

- unlock the vehicle
- open the side windows
- open the sliding sunroof or the panorama roof with power tilt/sliding panel and the roller sunblinds
- switch on the seat ventilation for the driver's seat
- i** The convenience opening feature can only be operated using the SmartKey. The SmartKey must be close to the driver's door handle.
- ▶ Point the tip of the SmartKey at the driver's door handle.
- ▶ Press and hold the  button until the side windows and the sliding sunroof or the panorama roof with power tilt/sliding panel are in the desired position.

If the roller sunblinds of the panorama roof with power tilt/sliding panel are closed, the roller sunblinds are opened first.

- ▶ Press and hold the  button again until the panorama roof with power tilt/sliding panel is in the desired position.
- ▶ **To interrupt convenience opening:** release the  button.

### Convenience closing

#### General notes

When you lock the vehicle, you can simultaneously:



- close the side windows
- close the sliding sunroof or the panorama roof with power tilt/sliding panel

On vehicles with a panorama roof with power tilt/sliding panel, you can then close the roller sunblinds.

#### WARNING

When closing the door windows and the sliding sunroof or panorama roof with power tilt/sliding panel, make sure that there is no danger of anyone being harmed by the closing procedure.

If potential danger exists, proceed as follows:

- Release the  button to stop the closing procedure. To open, press and hold the  button. To continue the closing procedure after making sure that there is no danger of anyone being harmed by the closing procedure, press and hold the  button.



Vehicles with KEYLESS-GO:

- Release the sensor surface on the outside door handle to stop the closing procedure.
- Immediately pull on the same outside door handle and hold firmly. The door windows and the sliding sunroof or panorama roof with power tilt/sliding panel will open for as long as the door handle is held but the door is not opened.

## Using the SmartKey

- ▶ **i** The SmartKey must be close to the driver's door handle.
- ▶ Point the tip of the SmartKey at the driver's door handle.
- ▶ Press and hold the  button until the side windows and the sliding sunroof or the panorama roof with power tilt/sliding panel are fully closed.
- ▶ Make sure that all the side windows and the sliding sunroof or panorama roof with power tilt/sliding panel are closed.

On vehicles with a panorama roof with power tilt/sliding panel:

- ▶ Press and hold the  button again until the roller sunblinds of the panorama roof with power tilt/sliding panel close.
- ▶ **To interrupt convenience closing:** release the  button.

## Using KEYLESS-GO

The KEYLESS-GO key must be outside the vehicle. All the doors must be closed.

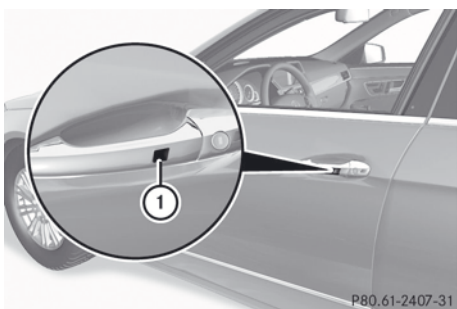

- ▶ Touch recessed sensor surface ① on the door handle until the side windows and the sliding sunroof or the panorama roof with power tilt/sliding panel are fully closed.
- ▶ **i** Make sure you only touch recessed sensor surface ①.
- ▶ Make sure that all the side windows and the sliding sunroof or panorama roof with power tilt/sliding panel are closed.

On vehicles with a panorama roof with power tilt/sliding panel:

- ▶ Touch recessed sensor surface ① on the door handle again until the roller sunblinds of the panorama roof with power tilt/sliding panel close.
- ▶ **To interrupt convenience closing:** release recessed sensor surface ① on the door handle.

## Resetting the side windows

You must reset each side window if a side window can no longer be closed fully.

- ▶ Close all the doors.
- ▶ Turn the SmartKey to position **1** or **2** in the ignition lock.
- ▶ Pull the corresponding switch on the door control panel until the side window is completely closed. (▷ page 90)
- ▶ Hold the switch for an additional second.

If the side window opens again slightly:

- ▶ Immediately pull the corresponding switch on the door control panel until the side window is completely closed (▷ page 90).
- ▶ Hold the switch for an additional second.
- ▶ If the corresponding side window remains closed after the button has been released, the side window has been reset correctly. If this is not the case, repeat the steps above again.

## Problems with the side windows

**Problem: a side window cannot be closed because it is blocked by objects, e.g. leaves in the window guide.**

- ▶ Remove the objects.
- ▶ Close the side window.

**Problem: a side window cannot be closed and you cannot see the cause.**

**⚠ WARNING**

Closing the side windows with increased force or without the anti-entrapment feature could lead to serious or even fatal injury. Make sure that nobody can become trapped when closing the side windows.

If a side window is obstructed during closing and reopens again slightly:

- ▶ Immediately after the window blocks, pull the corresponding switch again until the side window has closed.  
The side window is closed with increased force.

If a side window is obstructed again during closing and reopens again slightly:

- ▶ Immediately after the window blocks, pull the corresponding switch again until the side window has closed.  
The side window is closed without the anti-entrapment feature.

**⚠ WARNING**

Pulling and holding the switch to close the door window immediately after it had been blocked two times will cause the door window to close without the anti-entrapment feature for as long as you hold the switch.

**Sliding sunroof****Important safety notes**

Your vehicle may be equipped with a sliding sunroof or a panorama roof with power tilt/sliding panel. In the following section, the term "sliding sunroof" refers to both types of sliding sunroof.

**⚠ WARNING**

When opening or closing the sliding sunroof, make sure that there is no danger of anyone being harmed by the opening/closing procedure.

The sliding sunroof is equipped with automatic operation and the anti-entrapment

feature. If the movement of the sliding sunroof is blocked during the closing procedure, the sliding sunroof will stop and open slightly.

The sliding sunroof operates differently when the sliding sunroof switch is pressed and held. See the "Problems with the sliding sunroof" section for more details.

The opening/closing procedure of the sliding sunroof can be immediately halted by releasing the sliding sunroof switch or, if the sliding sunroof switch was moved past the resistance point and released, by moving the sliding sunroof switch in any direction.

**⚠ WARNING**

The sliding sunroof is made out of glass. In the event of an accident, the glass may shatter. This may result in an opening in the roof.

In a vehicle rollover, occupants not wearing their seat belts or not wearing them properly may be thrown out of the opening. Such an opening also presents a potential for injury for occupants wearing their seat belts properly, as entire body parts or portions of them may protrude from the passenger compartment.

- ❗ Only open the sliding sunroof if it is free of snow and ice. Otherwise, malfunctions may occur.

Do not allow anything to protrude from the sliding sunroof. Otherwise, the seals could be damaged.

- ❗ The weather can change abruptly. It could start to rain or snow. Make sure that the sliding sunroof is closed when you leave the vehicle. The vehicle electronics can be damaged if water enters the vehicle interior.

- ⓘ Resonance noises can occur in addition to the usual airflow noises when the sliding sunroof is open. They are caused by minor pressure fluctuations in the vehicle interior. Change the position of the sliding sunroof or open a side window slightly to reduce or eliminate these noises.



## Operating the sliding sunroof

### Opening and closing

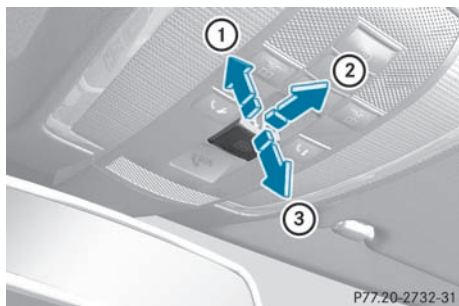
- i** You can continue to operate the sliding sunroof after switching off the engine or removing the SmartKey from the ignition lock. This function is available for up to five minutes or until the driver's or front-passenger door is opened.



Overhead control panel

- ① To raise
  - ② To open
  - ③ To close/lower
- ▶ Turn the SmartKey to position **1** or **2** in the ignition lock.
  - ▶ Press or pull the  switch in the corresponding direction.
  - i** If you press the  switch beyond the point of resistance, an automatic opening/closing process is started in the corresponding direction. You can stop automatic operation by operating the switch again.

When opening and raising the roof, automatic operation is only available if the sliding sunroof is in the closed position.

The sun protection cover automatically opens along with the sliding sunroof. You can open or close the sun protection cover manually when the sliding sunroof is raised or closed.

### Resetting

Reset the sliding sunroof if it does not move smoothly.

- ▶ Turn the SmartKey to position **2** in the ignition lock.
  - ▶ Raise the sliding sunroof fully at the rear (▷ page 94).
  - ▶ Keep the  switch pressed for another second.
  - ▶ Make sure that the sliding sunroof can be fully opened and closed again (▷ page 94).
  - ▶ If this is not the case, repeat the steps above again.
- !** If the sliding sunroof still cannot be opened or closed fully after resetting, contact a qualified specialist workshop.

## Operating the panorama roof with power tilt/sliding panel

### Opening and closing

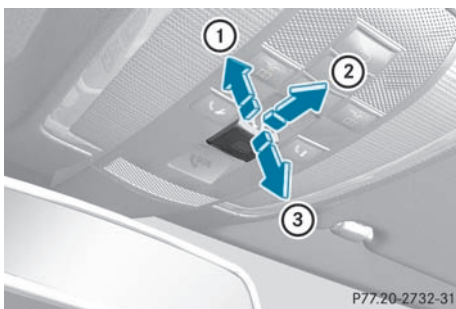

Overhead control panel

- ① To raise
- ② To open
- ③ To close/lower

The panorama roof with power tilt/sliding panel can only be operated when the roller sunblind is open.

- ▶ Turn the SmartKey to position **1** or **2** in the ignition lock.
- ▶ Push or pull the  switch in the corresponding direction.

- i** If you press the  switch beyond the point of resistance, an automatic opening/closing process is started in the corresponding direction. You can stop automatic operation by operating the switch again.

### Operating the sunblinds for the panorama roof with power tilt/sliding panel

#### General notes

The roller sunblinds shield the vehicle interior from sunlight. The two roller sunblinds can only be opened and closed together when the panorama roof with power tilt/sliding panel is closed.

#### WARNING

When opening or closing the roller sunblinds, make sure that no one can be injured.

The roller sunblinds have automatic operation and an anti-entrapment feature. If the roller sunblinds are blocked during the closing procedure, the anti-entrapment feature stops the roller sunblinds and they open again slightly.

The opening and closing of the roller sunblinds can be terminated immediately by releasing the button. In automatic operation, press the button briefly in any direction to stop the roller sunblinds.

#### Opening and closing

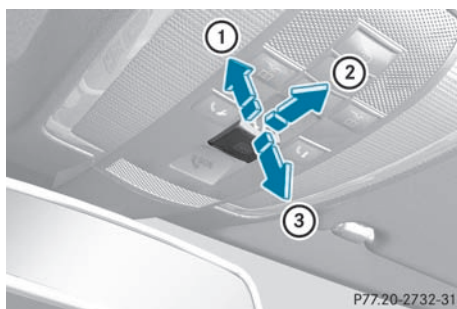

Overhead control panel

- ① To open
- ② To open
- ③ To close

► Turn the SmartKey to position **1** or **2** in the ignition lock.

► Press or pull the  switch in the corresponding direction.

- i** If you press the  switch beyond the point of resistance, an automatic opening/closing process is started in the corresponding direction. You can stop automatic operation by operating the switch again.



#### Resetting the panorama roof with power tilt/sliding panel and the roller sunblinds

Reset the panorama roof with power tilt/sliding panel and the roller sunblinds if the panorama roof with power tilt/sliding panel or the roller sunblinds do not move smoothly.

► Turn the SmartKey to position **1** or **2** in the ignition lock.

► Pull the  switch repeatedly to the point of resistance in the direction of arrow **③** until the panorama roof with power tilt/sliding panel is fully closed.

► Keep the  switch pulled for an additional second.

- ▶ Pull the  switch repeatedly to the point of resistance in the direction of arrow ③ until the roller sunblinds are fully closed.
  - ▶ Keep the  switch pulled for an additional second.
  - ▶ Make sure that the panorama roof with power tilt/sliding panel (▷ page 94) and the roller sunblinds (▷ page 95) can be fully opened again.
  - ▶ If this is not the case, repeat the steps above again.
- !** If the panorama roof with power tilt/sliding panel and the roller sunblind cannot be fully opened or closed after resetting, contact a qualified specialist workshop.

### Problems with the sliding sunroof

Your vehicle may be equipped with a sliding sunroof or a panorama roof with power tilt/sliding panel. In the following section, the term "sliding sunroof" refers to both types of sliding sunroof.

**Problem: the sunroof cannot be closed and you cannot see the cause.**

#### WARNING

You could be severely or even fatally injured when closing the sliding sunroof with increased closing force or if the anti-entrapment feature is deactivated. Make sure that nobody can become trapped when closing the sliding sunroof.

If the sliding sunroof is obstructed during closing and reopens again slightly:

- ▶ Immediately after the sliding sunroof blocks, pull the  switch in the overhead control panel down to the point of resistance and hold it until the sliding sunroof is closed.  
The sliding sunroof is closed with increased force.

If the sliding sunroof is obstructed again during closing and reopens again slightly:

- ▶ Immediately after the sliding sunroof blocks, pull the  switch in the overhead control panel down to the point of resistance and hold it until the sliding sunroof is closed.  
The sliding sunroof is closed without the anti-entrapment feature.

#### WARNING

Pressing and holding the sliding sunroof switch to close the sliding sunroof immediately after it had been blocked two times will cause the sliding sunroof to close without the anti-entrapment feature for as long as you hold the switch.

- !** If the sliding sunroof still cannot be opened or closed as a result of a malfunction, contact a qualified specialist workshop.

Useful information .....	98
Correct driver's seat position .....	98
Seats .....	99
Steering wheel .....	107
Mirrors .....	109
Memory function .....	111



## Useful information

**i** This Operator's Manual describes all models and all standard and optional equipment of your vehicle available at the time of publication of the Operator's Manual. Country-specific differences are possible. Please note that your vehicle may not be equipped with all features described. This also applies to safety-related systems and functions.

**i** Please read the information on qualified specialist workshops (▷ page 25).

## Correct driver's seat position



Observe the safety guidelines on seat adjustment (▷ page 99).

► Check whether you have adjusted seat ③ properly.

Electrical seat adjustment (▷ page 100)

When adjusting the seat, make sure:

- you are as far away from the driver's air bag as possible.
- you are sitting in a normal upright position.

- you can fasten the seat belt properly.
- you have moved the backrest to an almost vertical position.
- you have set the seat cushion angle so that your thighs are gently supported.
- you can depress the pedals properly.

► Check whether the head restraint is adjusted properly (▷ page 100).

When doing so, make sure that you have adjusted the head restraint so that the back of your head is supported at eye level by the center of the head restraint.

Observe the safety guidelines on steering wheel adjustment (▷ page 107).

► Check whether steering wheel ① is adjusted properly.

Adjusting the steering wheel electrically (▷ page 107)

When adjusting the steering wheel, make sure:

- you can hold the steering wheel with your arms slightly bent.
- you can move your legs freely.
- you can see all the displays in the instrument cluster clearly.

Observe the safety guidelines for seat belts (▷ page 51).

► Check whether you have fastened seat belt ② properly (▷ page 53).

The seat belt should:

- fit snugly across your body
- be routed across the middle of your shoulder
- be routed in your pelvic area across the hip joints

► Before starting off, adjust the rear-view mirror and the exterior mirrors (▷ page 109) in such a way that you have a good view of road and traffic conditions.

► **Vehicles with a memory function:** save the seat, steering wheel and exterior mirror settings (▷ page 111).



## Seats

### Important safety notes

#### WARNING

In order to avoid possible loss of vehicle control, all seat, head restraint, steering wheel and rear view mirror adjustments, as well as fastening of seat belts, must be done before setting the vehicle in motion.

#### WARNING

Do not adjust the driver's seat while driving. Adjusting the seat while driving could cause the driver to lose control of the vehicle.

Never travel in a moving vehicle with the seat backrest in an excessively reclined position as this can be dangerous. You could slide under the seat belt in a collision. If you slide under it, the seat belt would apply force at the abdomen or neck. This could cause serious or fatal injuries. The seat backrest and seat belts provide the best restraint when the wearer is in a position that is as upright as possible and seat belts are properly positioned on the body.

#### WARNING

Your seat belt must be adjusted so that you can correctly fasten your seat belt.

Observe the following points:

- adjust the seat backrest until your arms are slightly angled when holding the steering wheel.
- adjust the seat to a comfortable seating position that still allows you to reach the accelerator/brake pedal safely. The position should be as far back as possible with the driver still able to operate the controls properly.
- adjust the head restraint so that it is as close to the head as possible and the center

of the head restraint supports the back of the head at eye level.

- never place hands under the seat or near any moving parts while a seat is being adjusted.

Failure to do so could result in an accident and/or serious personal injury.

#### WARNING

The electrically adjustable seats can be operated at any time. Therefore, do not leave children unattended in the vehicle, or with access to an unlocked vehicle. A child's unsupervised access to a vehicle could result in an accident and/or serious personal injury.

#### WARNING

According to accident statistics, children are safer when properly restrained in the rear seating positions than in the front seating position. Thus, we strongly recommend that children be placed in the rear seats whenever possible. Regardless of seating position, children 12 years old and under must be seated and properly secured in an appropriately sized infant restraint, toddler restraint, or booster seat recommended for the size and weight of the child. For additional information, see "Children in the vehicle".

A child's risk of serious or fatal injuries is significantly increased if the child restraints are not properly secured in the vehicle and/or the child is not properly secured in the child restraint.

#### WARNING

For your protection, drive only with properly positioned head restraints.

Adjust the head restraint so that it is as close to the head as possible and the center of the head restraint supports the back of the head at eye level. This will reduce the potential for injury to the head and neck in the event of an accident or similar situation.

Do not drive the vehicle without the seat head restraints. Head restraints are intended to help reduce injuries during an accident.

**!** To avoid damage to the seats and the seat heating, observe the following information:

- keep liquids from spilling on the seats. If liquid is spilled on the seats, dry them as soon as possible.
- if the seat covers are damp or wet, do not switch on the seat heating. The seat heating should also not be used to dry the seats.
- clean the seat covers as recommended; see the "Interior care" section.
- do not transport heavy loads on the seats. Do not place sharp objects on the seat cushions, e.g. knives, nails or tools. The seats should only be occupied by passengers, if possible.
- when the seat heating is in operation, do not cover the seats with insulating materials, e.g. blankets, coats, bags, seat covers, child seats or booster seats.

**!** When you move the seats, make sure that there are no objects in the footwell or behind the seats. Otherwise, you could damage the seats and the objects.

**i** The head restraints in the front seats are equipped with the NECK-PRO system (▷ page 50). For this reason, it is not possible to remove the head restraints from the front seats.

Vehicles without the through-loading feature: the head restraints cannot be removed from the rear compartment seats. Please contact an authorized Mercedes-Benz Center for more information.

**i** Other topics:

- Through-loading feature in the rear bench seat (Sedan) (▷ page 279)
- EASY-PACK through-loading feature in the rear bench seat (Wagon) (▷ page 280)

## Adjusting the seats

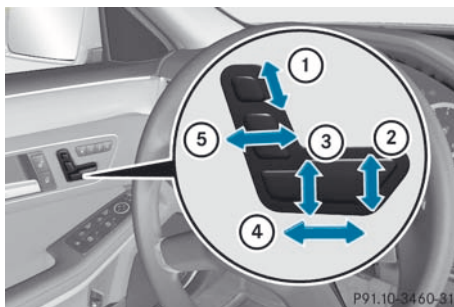

- ① Head restraint height
- ② Seat cushion angle
- ③ Seat height
- ④ Seat fore-and-aft adjustment
- ⑤ Backrest angle

**i** If PRE-SAFE® has been activated, the front-passenger seat is moved to a better position if it was previously set unfavorably.

**i** You can store the seat settings using the memory function (▷ page 111).

**i** Vehicles with the through-loading feature: if you fold down a rear seat backrest, the respective front seat is moved forwards slightly in order to avoid contact.

## Adjusting the head restraints

### Adjusting the angle of the head restraints



Example: Sedan

- ▶ Push or pull the lower edge of the head restraint in the direction of the arrow.

### Adjusting the head restraint height electrically

- ▶ **To adjust the head restraint height:** slide the switch for head restraint adjustment (▶ page 100) up or down in the direction of the arrow.

### Adjusting luxury head restraints

#### ⚠ WARNING

When folding back the side cushions, never reach between the side cushion and the mounting post. You could otherwise be trapped.

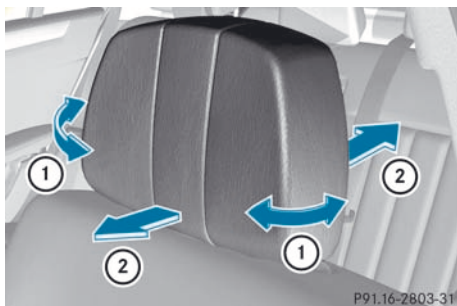

- ▶ **To adjust the side bolsters of the head restraint:** push or pull right and/or left-hand side bolster ① into the desired position.
- ▶ **To adjust the angle of the head restraint:** push or pull the head restraint in the direction of arrow ②.

### Rear seat head restraints

#### ⚠ WARNING

For safety reasons, always drive with the rear head restraints in the upright position when the rear seats are occupied.

Keep the area around head restraints clear of articles (e.g. clothing) to not obstruct the folding operation of the head restraints.

#### ⚠ WARNING

For your protection, drive only with properly positioned head restraints.

Adjust the head restraint in such a way that it is as close to the head as possible and the center of the head restraint supports the back of the head at eye level. This will reduce the potential for injury to the head and neck in the event of an accident or similar situation.

With a rear seat occupied, make sure to move the respective head restraint up from the lowest non-use position and have the occupant adjust the head restraint properly.

Do not drive the vehicle without the seat head restraints installed when the rear seats are occupied. Head restraints are intended to help reduce injuries during an accident.

#### ⚠ WARNING

Make sure the rear seat head restraints engage when placing them upright manually. Otherwise their protective function cannot be ensured.

The back of the head will not be supported in the event of a collision. That could cause serious or even fatal injuries. Rear seat occupants can be seriously injured or killed.

### Lowering the rear seat head restraints from the front



- ▶ Make sure that the SmartKey is in position 2 in the ignition lock.
- ▶ Press button ①.

### Adjusting the rear seat head restraint height

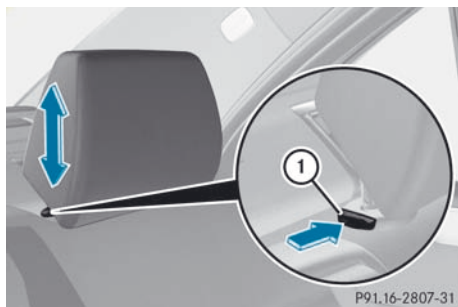

Example: Sedan

- ▶ **To raise:** pull the head restraint up to the desired position.
- ▶ **To lower:** press release catch ① and push the head restraint down until it is in the desired position.

**i** If you pull the head restraint forward slightly, the effort required to adjust it is reduced.

### Removing and installing rear head restraints<sup>7</sup>

#### **⚠ WARNING**

Occupants should only travel sitting on seats which have the head restraints installed. In the event of an accident, this reduces the risk of injury for passengers seated in the rear compartment.

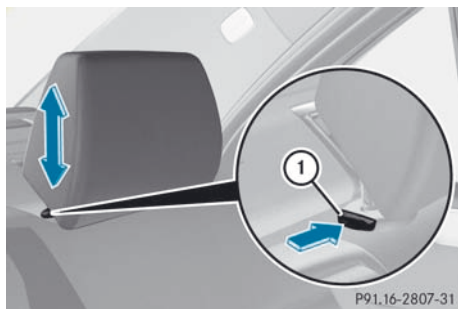

Example: Sedan

- ▶ Release the rear seat backrest and fold it slightly forwards (▷ page 279).
- ▶ **To remove:** pull the head restraint up to the stop.
- ▶ Press release catch ① and pull the head restraint out of the guides.
- ▶ **To re-install:** insert the head restraint so that the notches on the bar are on the left when viewed in the direction of travel.
- ▶ Push the head restraint down until you hear it engage in position.
- ▶ Fold back the rear seat backrest until it engages.

### Adjusting the active multicontour seat

The active multicontour seat on the driver's side automatically adapts the sides of the backrest to your current driving style. You can adjust the contour of the seats individually so as to provide optimum support for your back and sides.

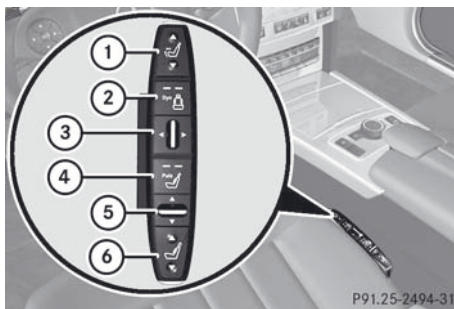

- ① To adjust the seat cushion length
- ② To switch the dynamic function on or off
- ③ To adjust the side bolsters of the seat backrest
- ④ To switch the massage function on or off
- ⑤ To adjust the contour of the backrest to increase/decrease support
- ⑥ To adjust the height/depth of the backrest contour

<sup>7</sup> Only for vehicles with through-loading facility.

## Dynamic function

The dynamic function adjusts the air cushions in the side bolsters of the seat backrests to ensure ideal lateral support at all times.

You can choose between two different levels.

Level 1 (one indicator lamp)	Standard setting: slightly increased lateral support and slow build-up of air pressure in the side bolsters of the seat backrest.
Level 2 (two indicator lamps)	Sport setting: increased lateral support and fast build-up of pressure in the side bolsters of the seat backrest.

- ▶ **To switch on:** press button ② once or twice until the desired level is set. One or two indicator lamps in button ② light up.
- ▶ **To switch off:** press button ② repeatedly until all indicator lamps in button ② go out.

## Massage function (PULSE)

The massage function helps you to prevent muscle tension on long journeys. You can choose between two levels.

- ▶ **To switch on:** press button ④ once or twice until the desired level is set. One or two indicator lamps in button ④ light up. The air cushions in the lumbar region vibrate for approximately 20 minutes.

### Adjusting the four-way lumbar support

You can adjust the contour of the front seat backrests individually to provide optimum support for your back.

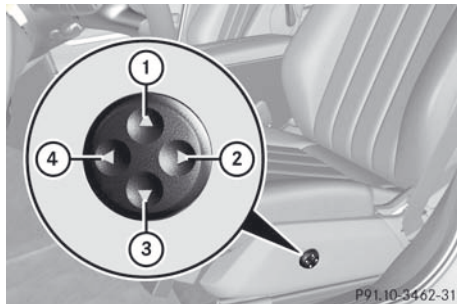

- ① To raise the backrest contour
- ② To soften the backrest contour
- ③ To lower the backrest contour
- ④ To harden the backrest contour

### Folding bench seat in the cargo compartment (Wagon)

#### Important safety notes

The folding bench seat in the cargo compartment is only approved for people with a height no greater than 4.6 ft (1.40 m) and max. 110 lb (50 kg) body weight.

The maximum permissible weight available for passengers may be reduced by extensive optional extras and the vehicle load. Observe the maximum gross vehicle weight and the gross axle weight rating, which can be found on the vehicle identification plate (▷ page 381).

The combined cargo cover and net must be installed if you are using the folding bench seat (▷ page 283).

#### **⚠ WARNING**

The rear seat backrests must be locked in the upright position if you are using the folding bench seat in the cargo compartment.

Do not pull away unless the head restraint in the folding bench seat is installed correctly. Make sure that the center of the head restraint supports the seat occupant's head at about eye level. This can reduce the risk of injury to a child in the event of an accident.

Ensure that the seat belt is routed correctly across the body and the seat belt buckle is engaged.

Never leave children unsupervised in the vehicle. This applies even if they are secured in a child restraint system.

Secure children as recommended; see the "Children in the vehicle" section.

#### WARNING

Only replace damaged covers with genuine covers.

Make sure that items of luggage and other objects in the cargo compartment are well secured.

Otherwise, the load could cause injury in the event of sharp braking, a sudden change in direction or an accident.

### Folding out the folding bench seat

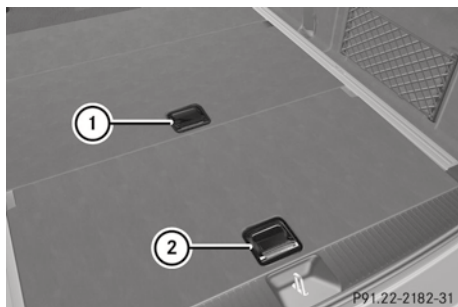

- ▶ Make sure that the backrests of the rear bench seat are locked in the upright position.
- ▶ Move the handle for the combined cargo cover and net upwards (▶ page 283).
- ▶ Pull release handle ① and fold the backrest of the folding bench seat upwards.

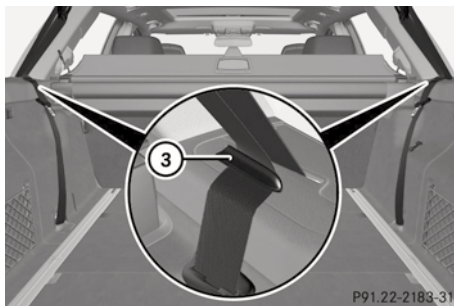

- ▶ Hook the seat belts into retainers ③.
- ▶ Pull release handle ② and fold the folding bench seat cushion into the sitting position.
- ▶ Push down the seat cushion until the backrest engages fully.
- ▶ Fold the head restraints upwards.

### installing and removing the seat cushion

You must remove the seat cushion if you wish to lift the trunk floor, e.g. if the vehicle has a flat tire.

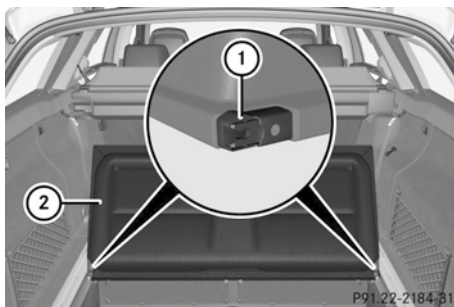

- ▶ **To remove:** fold seat cushion ② upwards and remove it from seat cushion guides ①.



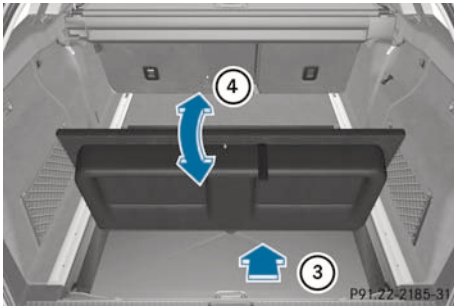

- ▶ **To install:** guide seat cushion ② into seat cushion guides ① at a slight angle from the rear ③.
- ▶ Fold seat cushion ② back into its original position ④ until it engages.

### Folding back the folding bench seat

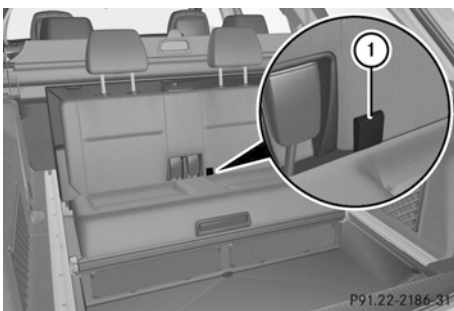

- ▶ Pull the seat cushion upwards by tab ① and fold it back into its original position until it engages.

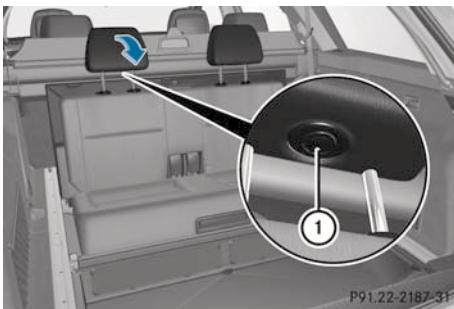

- ▶ Press release button ① and fold the head restraints down.

! In order to avoid causing damage, push the head restraints completely into their guides and click the seat belt buckles into their guides.

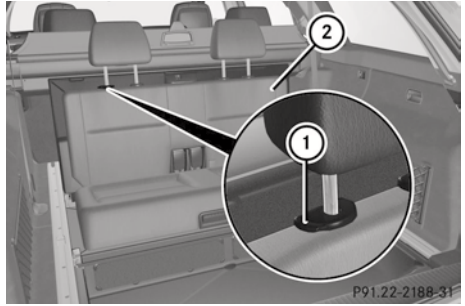

- ▶ Press release catch ① and push the head restraints in fully.
- ▶ Fold backrest ② of the folding bench seat into its original position until it engages.

### Switching the seat heating on/off

#### Switching on/off

The three red indicator lamps in the button indicate the heating level you have selected.

i If the battery voltage is too low, the seat heating may switch off.



Driver's and front-passenger seat

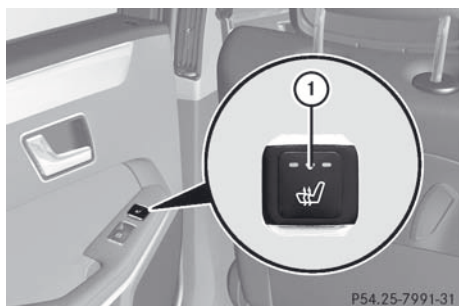

P54.25-7991-31

### Rear seats<sup>8</sup>

The system automatically switches down from level **3** to level **2** after about eight minutes (driver's seat and front-passenger seat) or five minutes (rear seats).

The system automatically switches down from level **2** to level **1** after approximately ten minutes.

The system automatically switches off approximately 20 minutes after it is set to level **1**.

- ▶ Make sure that the SmartKey is in position **2** in the ignition lock.
- ▶ **To switch on:** press button ① repeatedly until the desired heating level is set.
- ▶ **To switch off:** press button ① repeatedly until all the indicator lamps go out.

### Problems with the seat heating

The seat heating has switched off prematurely or cannot be switched on. The vehicle's electrical system voltage is too low because too many electrical consumers are switched on.

- ▶ Switch off electrical consumers which you do not need, such as the rear window defroster or interior lighting.

### Switching the seat ventilation on/off

#### Switching on/off

The three blue indicator lamps in the buttons indicate the ventilation level you have selected.

- ① If the battery voltage is too low, the seat ventilation may switch off.

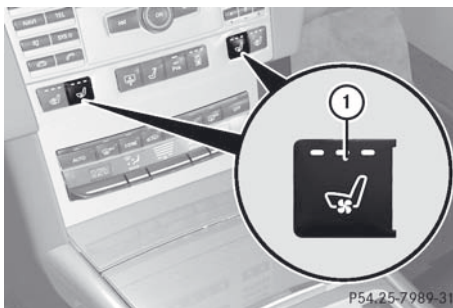

P54.25-7989-31

- ▶ Make sure that the SmartKey is in position **2** in the ignition lock.
- ▶ **To switch on:** press button ① repeatedly until the desired ventilation level is set.
- ① You can open the side windows and the sliding sunroof using the "Convenience opening" feature (▶ page 91). The seat ventilation of the driver's seat automatically switches to the highest level.
- ▶ **To switch off:** press button ① repeatedly until all the indicator lamps go out.

### Problems with the seat ventilation

The seat ventilation has switched off prematurely or cannot be switched on. The vehicle's electrical system voltage is too low because too many electrical consumers are switched on.

- ▶ Switch off electrical consumers which you do not need, such as the rear window defroster or interior lighting.

<sup>8</sup> For Canada only.



## Steering wheel

### Important safety notes

#### WARNING

Do not adjust the steering wheel while driving. Adjusting the steering wheel while driving could cause the driver to lose control of the vehicle.

The electrical steering wheel adjustment feature can be operated at any time. Therefore, do not leave children unattended in the vehicle, or with access to an unlocked vehicle. A child's unsupervised access to a vehicle could result in an accident and/or serious personal injury.

### Adjusting the steering wheel

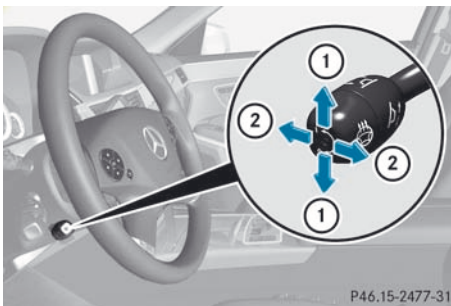

- ① To adjust the steering wheel height
- ② To adjust the steering wheel position (fore-and-aft adjustment)

#### Other topics:

- EASY-ENTRY/EXIT feature (▷ page 108)
- storing settings (▷ page 111)

## Steering wheel heating

### Switching on/off

The steering-wheel heating heats the leather areas of the steering wheel.

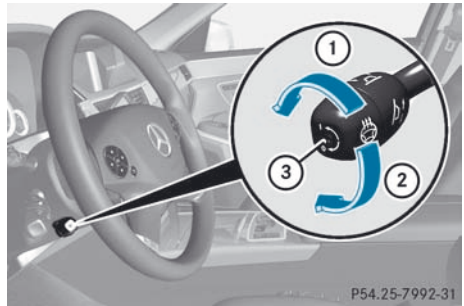

- ▶ Make sure that the SmartKey is in position **2** in the ignition lock.
- ▶ **To switch on/off:** turn the lever in the direction of arrow **1** or **2**. Indicator lamp **3** lights up or goes out.

 The steering wheel heating may switch off temporarily if:

- the temperature of the vehicle interior is above 86 °F (30 °C).
- the temperature of the steering wheel is above 95 °F (35 °C).

Indicator lamp **3** remains on.

Vehicles without KEYLESS-GO: when you remove the SmartKey from the ignition lock, the steering wheel heating is deactivated.

Vehicles with KEYLESS-GO: when you switch off the ignition and open the driver's door, the steering wheel heating is deactivated.

### Problems with the steering wheel heating

If steering wheel heating indicator lamp **3** is flashing, the steering wheel heating has switched off automatically. The vehicle's electrical system voltage is too low because too many electrical consumers are switched on.

- ▶ Switch off electrical consumers which you do not need, such as the rear window defroster or interior lighting. Once the battery is sufficiently charged, the steering wheel heating will switch back on automatically.

## EASY-ENTRY/EXIT system

### Important safety notes

The EASY-ENTRY/EXIT feature makes getting in and out of your vehicle easier.

You can activate and deactivate the EASY-ENTRY/EXIT feature in the on-board computer (▷ page 229).

#### WARNING

You must make sure no one can become trapped or injured by the moving steering wheel when the easy-entry/exit feature is activated.

To stop steering wheel movement, move steering wheel adjustment stalk or press the memory position switch.

Do not leave children unattended in the vehicle, or with access to an unlocked vehicle. Children could open the driver's door and unintentionally activate the easy-entry/exit feature, which could result in an accident and/or serious personal injury.

#### WARNING

Let the system complete the adjustment procedure before setting the vehicle in motion. All steering wheel adjustment must be completed before setting the vehicle in motion. Driving off with the steering wheel still adjusting could cause the driver to lose control of the vehicle.

### Position of the steering wheel when the EASY-ENTRY/EXIT feature is active

The steering wheel swings upwards when you:

- remove the SmartKey from the ignition lock
- open the driver's door and KEYLESS-GO is in position **1**
- open the driver's door and the SmartKey is in position **0** or **1** in the ignition lock

 The steering wheel only moves upwards if it has not already reached the upper end stop.

### Position of the steering wheel for driving

The steering wheel is moved to the last selected position when:

- the driver's door is closed.
  - you insert the SmartKey into the ignition lock.
- or
- you press the Start/Stop button once on vehicles with KEYLESS-GO.

When you close the driver's door with the ignition switched on, the steering wheel is also automatically moved to the previously set position.

The last position of the steering wheel is stored after each manual setting or when you store the setting with the memory function (▷ page 111).

### Crash-responsive EASY-EXIT feature

If the crash-responsive EASY-EXIT feature is triggered in an accident, the steering column will move upwards when the driver's door is opened. This occurs irrespective of the position of the SmartKey in the ignition lock. This makes it easier to exit the vehicle and rescue the occupants.

The crash-responsive EASY-EXIT feature is only operational if the EASY-EXIT/ENTRY feature is activated in the on-board computer.

**Mirrors**

**Rear-view mirror**

**Rear-view mirror (manual anti-glare)**

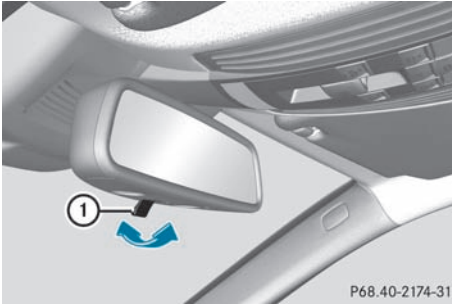

- ▶ **anti-glare mode:** flick anti-glare switch ① forwards or back.

**Exterior mirrors**

**Adjusting the exterior mirrors**

**⚠ WARNING**

Exercise care when using the passenger-side exterior rear view mirror. The mirror surface is convex (outwardly curved surface for a wider field of view). Objects in mirror are closer than they appear. Check your interior rear view mirror and glance over your shoulder before changing lanes.

The exterior mirrors are automatically heated if the rear window defroster is switched on and the outside temperature is low.

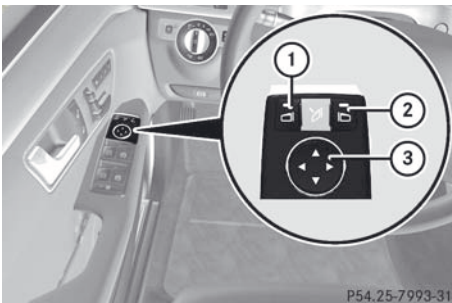

- ▶ Make sure that the SmartKey is in position 1 or 2 in the ignition lock.
- ▶ Press button ① for the left-hand exterior mirror or button ② for the right-hand exterior mirror.  
The indicator lamp in the corresponding button lights up in red.  
The indicator lamp goes out again after some time. You can adjust the selected mirror using adjustment button ③ as long as the indicator lamp is lit.
- ▶ Press adjustment button ③ up, down, to the right or to the left until the exterior mirror is set to a position that provides you with a good overview of traffic conditions.

**Folding the exterior mirrors in or out electrically**

This function is only available in vehicles for Canada.



- ▶ Make sure that the SmartKey is in position 1 or 2 in the ignition lock.
- ▶ Briefly press button ①.  
Both exterior mirrors fold in or out.
- i** Make sure that the exterior mirrors are always folded out fully while the vehicle is in motion, as they may otherwise vibrate.
- i** If you are driving faster than 9 mph (15 km/h), you can no longer fold in the exterior mirrors.

### Setting the exterior mirrors

This function is only available in vehicles for Canada.

If the battery has been disconnected or completely discharged, the exterior mirrors must be reset. The exterior mirrors will otherwise not fold in when you select the "Fold in mirrors when locking" function in the on-board computer (▷ page 230).

- ▶ Make sure that the SmartKey is in position **1** in the ignition lock.
- ▶ Briefly press button .

### Folding the exterior mirrors in or out automatically

This function is only available in vehicles for Canada.

If the "Fold in mirrors when locking" function is activated in the on-board computer (▷ page 230):

- the exterior mirrors fold in automatically as soon as you lock the vehicle from the outside.
- the exterior mirrors fold out again automatically as soon as you unlock the vehicle and then open the driver's or front-passenger door.

-  The mirrors do not fold out if they have been folded in manually.

### Exterior mirror out of position

If an exterior mirror has been pushed out of position, proceed as follows:

- ▶ **Vehicles without electrically folding exterior mirrors:** move the exterior mirror into the correct position manually.
- ▶ **Vehicles with electronically folding mirrors<sup>9</sup>:** press the mirror-folding button

(▷ page 109) repeatedly until you hear the mirror engage in position.

The mirror housing is engaged again and you can adjust the exterior mirrors as usual (▷ page 109).

### Automatic anti-glare mirrors

#### WARNING

If incident light from headlamps is prevented from striking the sensor in the rear-view mirror, for instance, by luggage piled too high in the vehicle, the mirror's automatic anti-glare function will not operate.

Incident light could then blind you. This may distract you from the traffic conditions and, as a result, you may cause an accident.

The rear-view mirror and the exterior mirror on the driver's side automatically go into anti-glare mode if the ignition is switched on and incident light from headlamps strikes the sensor in the rear-view mirror.

The mirrors do not go into anti-glare mode if reverse gear is engaged or the interior lighting is switched on.

### Parking position for the exterior mirror on the front-passenger side

#### Setting and storing the parking position

You can position the front-passenger side exterior mirror in such a way that you can see the rear wheel on that side as soon as you engage reverse gear. You can store this position.

<sup>9</sup> Canada only

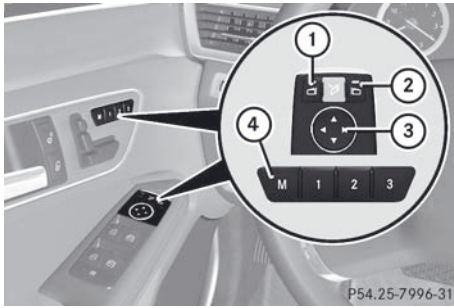

- ▶ Make sure that the vehicle is stationary and that the SmartKey is in position **2** in the ignition lock.
  - ▶ Press button **②** for the exterior mirror on the front-passenger side.
  - ▶ Engage reverse gear.  
The exterior mirror on the front-passenger side moves to the preset parking position.
  - ▶ Use adjustment button **③** to adjust the exterior mirror to a position that allows you to see the rear wheel and the curb.  
The parking position is stored.
- i** If you shift the transmission to another position, the exterior mirror on the front-passenger side returns to the driving position.
- i** You can also store the parking position using memory button **M** **④**.
- ▶ Make sure that the SmartKey is in position **2** in the ignition lock.
  - ▶ With the exterior mirror on the front-passenger side activated, use adjustment button **③** to adjust the exterior mirror to a position which allows you to see the rear wheel and the curb.
  - ▶ Press memory button **M** **④** and one of the arrows on adjustment button **③** within three seconds.  
The parking position is stored if the exterior mirror does not move.
- If the mirror moves out of position, repeat the steps.

## Calling up a stored parking position setting

- ▶ Turn the SmartKey to position **2** in the ignition lock.
  - ▶ Adjust the exterior mirror on the front-passenger side with the corresponding button (▷ page 109).
  - ▶ Engage reverse gear.  
The exterior mirror on the front-passenger side moves to the stored parking position.
- The exterior mirror on the front-passenger side moves back to its original position:
- as soon as you exceed a speed of 6 mph (10 km/h)
  - about ten seconds after you have disengaged reverse gear
  - if you press button **①** for the exterior mirror on the driver's side

## Memory function

### Storing settings

With the memory function, you can store up to three different settings, e.g. for three different people.

The following settings are stored as a single memory preset:

- position of the seat, backrest and head restraint
- active multicontour seat: dynamic function level
- driver's side: steering wheel position
- driver's side: position of the exterior mirrors on the driver's and front-passenger sides

### **⚠ WARNING**

Do not activate the memory function while driving. Activating the memory function while driving could cause the driver to lose control of the vehicle.

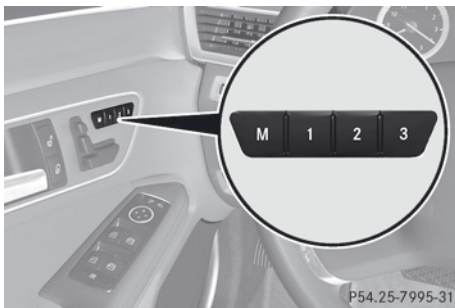

P54.25-7995-31

- ▶ Adjust the seat (▷ page 100).
- ▶ On the driver's side, adjust the steering wheel (▷ page 107) and the exterior mirrors (▷ page 109).
- ▶ Press memory button **M** and one of the storage position buttons **1**, **2** or **3** within three seconds.  
The settings are stored in the selected preset position. A tone sounds when the settings have been completed.

### Calling up a stored setting

- ▶ Press and hold the relevant storage position button **1**, **2** or **3** until the seat, steering wheel and exterior mirrors are in the stored position.
- i** The setting procedure is interrupted as soon as you release the storage position button.

Useful information .....	114
Exterior lighting .....	114
Interior lighting .....	120
Replacing bulbs .....	121
Windshield wipers .....	124



## Useful information

**i** This Operator's Manual describes all models and all standard and optional equipment of your vehicle available at the time of publication of the Operator's Manual. Country-specific differences are possible. Please note that your vehicle may not be equipped with all features described. This also applies to safety-related systems and functions.

**i** Please read the information on qualified specialist workshops (▷ page 25).

## Exterior lighting

## Important safety notes

For reasons of safety, Mercedes-Benz recommends that you drive with the lights switched on even during the daytime. In some countries, operation of the headlamps varies due to legal requirements and self-imposed obligations.

## Information about driving abroad

**Converting to symmetrical low beam when driving abroad:** switch the headlamps to symmetrical low beam in countries in which traffic drives on the opposite side of the road to the country where the vehicle is registered. This prevents glare to oncoming traffic. Symmetrical lights do not illuminate as large an area of the edge of the road.

Have the headlamps converted at a qualified specialist workshop, e.g. an authorized Mercedes-Benz Center, as close to the border as possible before driving in these countries.

**Converting to asymmetrical low beam after returning:** have the headlamps converted back to asymmetrical low beam at a qualified specialist workshop, e.g. an authorized Mercedes-Benz Center, as soon as possible after crossing the border again.

<sup>10</sup> Only vehicles with front fog lamps have the fog lamps function.

## Light switch

## Operation

Depending on the date of manufacture of your vehicle, the **A** or **AUTO** symbol for the automatic headlamp mode/daytime running lamps is located on the light switch.

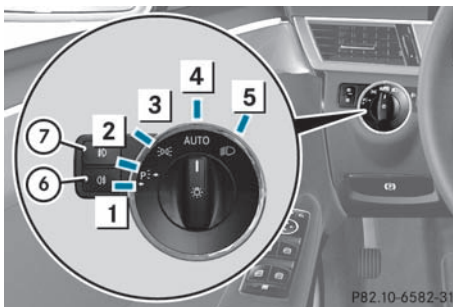

Illustration: light switch with the **AUTO** symbol for the automatic headlamp mode/daytime running lamps

- 1 Left-hand standing lamps
- 2 Right-hand standing lamps
- 3 Parking lamps, license plate and instrument cluster lighting
- 4 **AUTO** Automatic headlamp mode/daytime running lamps
- 5 Low-beam/high-beam headlamps
- 6 Rear fog lamp
- 7 Front fog lamps<sup>10</sup>



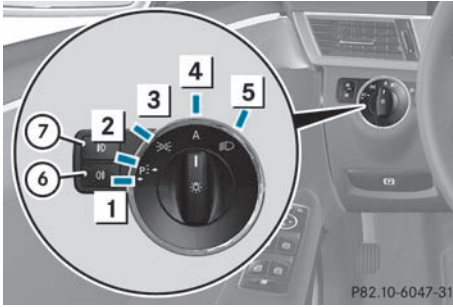

Illustration: light switch with the **A** symbol for the automatic headlamp mode/daytime running lamps

- 1 Left-hand standing lamps
- 2 Right-hand standing lamps
- 3 Parking lamps, license plate and instrument cluster lighting
- 4 **A** Automatic headlamp mode/daytime running lamps
- 5 Low-beam/high-beam headlamps
- 6 Rear fog lamp
- 7 Front fog lamps<sup>10</sup>

The turn signals, high-beam headlamps and the high-beam flasher are operated using the combination switch (> page 117).

**!** Switch off the parking lamps and standing lamps when you leave the vehicle. This prevents the battery from discharging.

The exterior lighting (except the parking/standing lamps) switches off automatically if you:

- remove the SmartKey from the ignition lock
- open the driver's door with the SmartKey in position **0**

If you hear a warning tone when you leave the vehicle, the lights may still be switched on.

- ▶ Turn the light switch to **A** or **AUTO**.

## Low-beam headlamps

- ▶ **To switch on the low-beam headlamps:** turn the SmartKey in the ignition lock to position **2** or start the engine.
- ▶ Turn the light switch to . The indicator lamp in the instrument cluster lights up.

## Daytime running lamps

### Daytime running lamps in Canada

The daytime running lamps function is required by law in Canada. It cannot therefore be deactivated.

- ▶ Turn the light switch to **A** or **AUTO**.  
With the engine running: depending on the ambient light, the daytime running lamps or the low-beam headlamps are switched on. When the low-beam headlamps are switched on, the indicator lamp in the instrument cluster lights up.

When the engine is running and the vehicle is stationary: if you move the selector lever from a drive position to **P**, the daytime running lamps/low-beam headlamps go out after three minutes.

When the engine is running, the vehicle is stationary and in high ambient light brightness: if you turn the light switch to , the daytime running lamps and the parking lamps are switched on.

If the engine is running and you turn the light switch to , the manual settings take precedence over the daytime running lamps.



### Daytime running lamps in the USA



In the USA, the daytime running lamps are deactivated upon delivery from the factory.

- ▶ **To activate the daytime running lamps:** activate the daytime running lamps



<sup>10</sup> Only vehicles with front fog lamps have the fog lamps function.

function in the on-board computer (▷ page 227).



- ▶ Turn the light switch to  or . With the engine running: depending on the ambient light, the daytime running lamps or the low-beam headlamps are switched on. When the low-beam headlamps are switched on, the  indicator lamp in the instrument cluster lights up.

If the engine is running and you turn the light switch to  or , the manual settings take precedence over the daytime running lamps.

### Automatic headlamp mode

- ▶ **To switch on automatic headlamp mode:** turn the light switch to  or . SmartKey in position **1** in the ignition lock: the parking lamps are switched on or off automatically depending on the brightness of the ambient light. With the engine running: depending on the brightness of the ambient light, the daytime running lamps<sup>11</sup> or the low-beam headlamps are switched on or off automatically. When the low-beam headlamps are switched on, the  indicator lamp in the instrument cluster lights up.

#### **WARNING**

If the light switch is set to  or , the low-beam headlamps will not come on automatically if it is foggy. This could endanger you and others. Therefore, turn the light switch to  in fog.







The automatic headlamp feature is only an aid. The driver is responsible for the vehicle's lighting at all times.

### Front fog lamps





Only vehicles with front fog lamps have the fog lamps function.

#### **WARNING**





If you suspect that driving conditions will be foggy, turn the light switch to  before you start your journey. Otherwise, your vehicle may not be visible and you could endanger yourself and others.

- ▶ **To switch on the front fog lamps:** turn the SmartKey in the ignition lock to position **2** or start the engine.
  - ▶ Turn the light switch to  or  or .
  - ▶ Press the  button. The green  indicator lamp in the instrument cluster lights up.
  - ▶ **To switch off the front fog lamps:** press the  button. The green  indicator lamp in the instrument cluster goes out.
- i** If you switch the engine off (SmartKey in position **1** in the ignition lock) and then restart it, the previous fog lamp settings are restored.

### Rear fog lamp

- ▶ **To switch on the rear fog lamp:** turn the SmartKey in the ignition lock to position **2** or start the engine.
- ▶ Turn the light switch to  or  or . If the light switch is set to  or , the rear fog lamp only lights up if the low-beam headlamps are on.

<sup>11</sup> Only if daytime running lamps have been activated via the on-board computer.

- ▶ Press the  button.  
The yellow  indicator lamp in the instrument cluster lights up.
  - ▶ **To switch off the rear fog lamp:** press the  button.  
The yellow  indicator lamp in the instrument cluster goes out.
- i** If you switch the engine off (SmartKey in position **1** in the ignition lock) and then restart it, the previous rear fog lamp settings are restored.

### Headlamp cleaning system

The headlamps are cleaned automatically if the "Wipe with washer fluid" function is operated ten times while the lights are on and the engine is running (▷ page 124).

### Combination switch

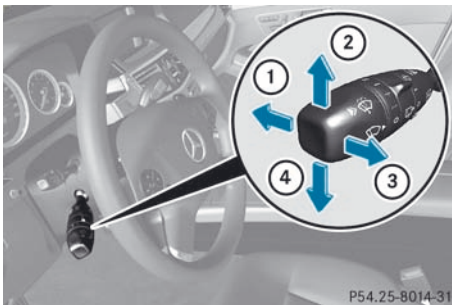

#### Turn signals



- ① High-beam headlamps
- ② Right turn signal
- ③ High-beam flasher
- ④ Left turn signal

- ▶ **To indicate briefly:** press the combination switch briefly to the pressure point in the direction of arrow ② or ④.  
The corresponding turn signal flashes three times.
- ▶ **To indicate:** press the combination switch beyond the pressure point in the direction of arrow ② or ④.

### High-beam headlamps

- ▶ **To switch on the high-beam headlamps:** turn the SmartKey in the ignition lock to position **2** or start the engine.
- ▶ Turn the light switch to  or **AUTO**.
- ▶ Press the combination switch beyond the pressure point in the direction of arrow ①.  
In the **AUTO** position, the high-beam headlamps are only switched on when it is dark and the engine is running.  
The  indicator lamp in the instrument cluster lights up when the high-beam headlamps are switched on.
- ▶ **To switch off the high-beam headlamps:** move the combination switch back to its normal position.  
The  indicator lamp in the instrument cluster goes out.

### High-beam flasher

- ▶ **To switch on:** turn the SmartKey in the ignition lock to position **1** or **2** or start the engine.
- ▶ Pull the combination switch in the direction of arrow ③.

### Hazard warning lamps



P54.25-7988-31

The hazard warning lamps automatically switch on if:

- an air bag is deployed.
- the vehicle is slowed down severely from a speed of over 45 mph (70 km/h) and comes to a halt.

► **To switch on the hazard warning lamps:** press button ①.

All turn signals flash. If you now switch on a turn signal using the combination switch, only the turn signal lamp on the corresponding side of the vehicle will flash.

► **To switch off the hazard warning lamps:** press button ①.

The hazard warning lamps are deactivated automatically if the vehicle returns to a speed of over 6 mph (10 km/h) after a full application of the brakes.

- ① The hazard warning lamps still operate if the ignition is switched off.

### Cornering light function



P82.10-5401-31

The cornering light function improves the illumination of the road over a wide angle in the direction you are turning, enabling better visibility in tight bends, for example. It can only be activated when the low-beam headlamps are switched on.

**Active:** if you are driving at speeds below 25 mph (40 km/h) and switch on the turn signals or turn the steering wheel.

**Not active:** if you are driving at speeds above 25 mph (40 km/h) or switch off the turn signal or turn the steering wheel to the straight-ahead position.

The cornering light function may remain lit for a short time, but is automatically switched off after no more than three minutes.

### Adaptive Highbeam Assist

You can use this function to set the headlamps to change between low beam and high beam automatically. The system recognizes vehicles with their lights on, either approaching from the opposite direction or traveling in front of your vehicle, and consequently switches the headlamps from high beam to low beam.

The system automatically adapts the low-beam headlamp range depending on the distance to the other vehicle. Once the system no longer detects any other vehicles, it reactivates the high-beam headlamps.

The system's optical sensor is located behind the windshield near the overhead control panel.

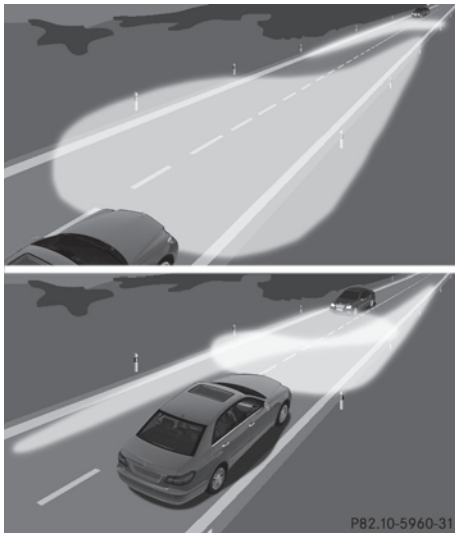

- ▶ **To activate:** activate the Adaptive Highbeam Assist function using the on-board computer (▷ page 227).
- ▶ Turn the light switch to **A** or **AUTO**.
- ▶ Press the combination switch beyond the pressure point in the direction of arrow ① (▷ page 117).

If it is dark and the light sensor activates the low-beam headlamps, the  indicator lamp in the instrument cluster lights up.

If you drive faster than approximately 28 mph (45 km/h):



the headlamp range is set automatically depending on the distance between the vehicle and other road users.

If you drive faster than approximately 35 mph (55 km/h) and no other road users are identified:

the high-beam headlamps are switched on automatically. The  indicator lamp in the instrument cluster also lights up.

When you drive slower than approximately 30 mph (45 km/h) or if other road users

are identified or if the roads are sufficiently illuminated:

the high-beam headlamps are switched off automatically. The  indicator lamp in the instrument cluster goes out. The  indicator lamp in the instrument cluster stays on.

- ▶ **To deactivate:** move the combination switch back to its normal position.

The  indicator lamp in the instrument cluster goes out.

#### **WARNING**

The Adaptive Highbeam Assist is only an aid intended to support you while driving. The driver is and remains responsible for proper vehicle lighting in accordance with the prevailing light, sight and traffic conditions. The system may be impaired or unavailable when

- visibility is poor, e.g. due to snow, rain, fog, or heavy spray
- the optical sensor area of the windshield is dirty, fogged up, or covered by a sticker for example

The system cannot recognize the following road users:

- Road users without a lighting system of their own, e.g. pedestrians
- Road users with dim lighting of their own, e.g. cyclists
- Road users whose lighting is obstructed, e.g. road users behind a guardrail
- In some seldom cases, even road users with a lighting system of their own may be recognized too late or not at all.

The automatic high-beam headlamps will then not be deactivated or it will be activated in spite of preceding or oncoming road users.

This could endanger you and/or others and cause an accident. Always pay close attention to the traffic situation and switch off the high beam manually if necessary.

### Headlamps fogged up on the inside

The headlamps may fog up on the inside if there is high atmospheric humidity.

- ▶ Drive with the headlamps switched on. The level of moisture diminishes, depending on the length of the journey and the weather conditions (humidity and temperature).

If the level of moisture does not diminish:

- ▶ Have the headlamps checked at a qualified specialist workshop.

## Interior lighting

### Overview of interior lighting

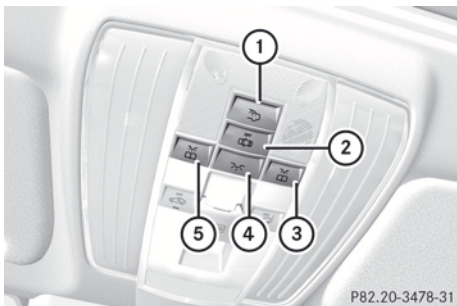

Front overhead control panel

- ① Switches the rear interior lighting on/off
- ② Switches the automatic interior lighting control on/off
- ③ Switches the right-hand front reading lamp on/off
- ④ Switches the front interior lighting on/off
- ⑤ Switches the left-hand front reading lamp on/off

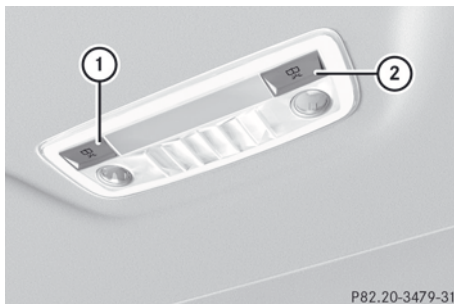

Rear-compartment overhead control panel

- ① Switches the right-hand reading lamp on/off
- ② Switches the left-hand reading lamp on/off

### Interior lighting control

#### Important notes

In order to prevent the vehicle's battery from discharging, the interior lighting functions are automatically deactivated after some time except for when the SmartKey is in position **2** in the ignition lock.

The color and brightness of the ambient lighting may be set using the on-board computer (▷ page 227).

#### Automatic interior lighting control

- ▶ **To switch on/off:** press the button. When the automatic interior lighting control is activated, the button is flush with the overhead control panel.



The interior lighting automatically switches on if you:

- unlock the vehicle
- open a door
- remove the SmartKey from the ignition lock

The interior light is activated for a short while when the SmartKey is removed from the ignition lock. You can activate this delayed switch-off using the on-board computer (▷ page 228).



## Manual interior lighting control

- ▶ **To switch the front interior lighting on/off:** press the  button.
- ▶ **To switch the rear interior lighting on/off:** press the  button.
- ▶ **To switch the reading lamps on/off:** press the  button.

## Crash-responsive emergency lighting

The interior lighting is activated automatically if the vehicle is involved in an accident.

- ▶ **To switch off the crash-responsive emergency lighting:** press the hazard warning lamp button.

or

- ▶ Lock and then unlock the vehicle using the SmartKey.

## Replacing bulbs

### Important safety notes

#### Xenon bulbs

If your vehicle is equipped with Xenon bulbs, you can recognize this by the following: the cone of light from the Xenon bulbs moves from the top to the bottom and back again when you start the engine. For this to be observed, the lights must be switched on before starting the engine.

#### DANGER

Xenon bulbs carry a high voltage. You could get an electric shock and be seriously or even fatally injured if you touch the electric contacts on Xenon bulbs. Therefore, never remove the cover from Xenon bulbs.

Do not change Xenon bulbs yourself, but have them replaced at a qualified specialist workshop which has the necessary specialist knowledge and tools to carry out the work required.

Mercedes-Benz recommends that you use an authorized Mercedes-Benz Center for this purpose. In particular, work relevant to safety or on safety-related systems must be carried out at a qualified specialist workshop.

Bulbs and lamps are an important aspect of vehicle safety. You must therefore make sure that these function correctly at all times. Have the headlamp setting checked regularly.

#### Other bulbs

There are bulbs other than the Xenon bulbs that you cannot replace. Replace only the bulbs listed (▷ page 122). Have the bulbs that you cannot replace yourself changed at a qualified specialist workshop.

Mercedes-Benz recommends that you use an authorized Mercedes-Benz Center for this purpose. In particular, work relevant to safety or on safety-related systems must be carried out at a qualified specialist workshop.

If you require assistance changing bulbs, consult a qualified specialist workshop.

Do not touch the glass tube of new bulbs with your bare hands. Even minor contamination can burn into the glass surface and reduce the service life of the bulbs. Always use a lint-free cloth or only touch the base of the bulb when installing.

Only use bulbs of the correct type.

If the new bulb still does not light up, consult a qualified specialist workshop.

Bulbs and lamps are an important aspect of vehicle safety. You must therefore make sure that these function correctly at all times. Have the headlamp setting checked regularly.

#### WARNING

Bulbs and lamps can be very hot. You should therefore allow them to cool down before you change them. Otherwise, you could be burned if you touch them.

Keep bulbs out of the reach of children. Otherwise, they could damage the bulbs, for example, and injure themselves.



Never use a bulb which has been dropped. Such a bulb may break or even explode and injure you.

Halogen bulbs are pressurized and can explode when you change them, particularly if they are very hot. You should therefore wear eye protection and gloves when you are changing them.

### Overview: changing bulbs/bulb types

You can change the following bulbs. The bulb type can be found in the legend.

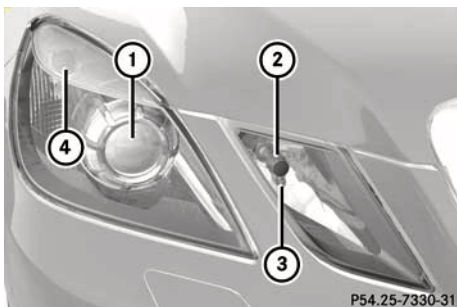

Halogen headlamps

- ① Low-beam headlamps<sup>12</sup>: H7 55 W
- ② High-beam headlamp: H7 55 W
- ③ Parking lamp/standing lamp: W 5 W
- ④ Turn signal lamp: 3457A

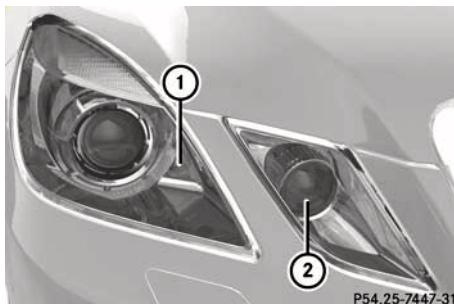

Bi-Xenon headlamps

- ① Cornering lamp: H7 55 W
- ② Infrared light (Night View Assist Plus): H11 55 W

### Changing the front bulbs

#### Low-beam headlamps (halogen headlamps)

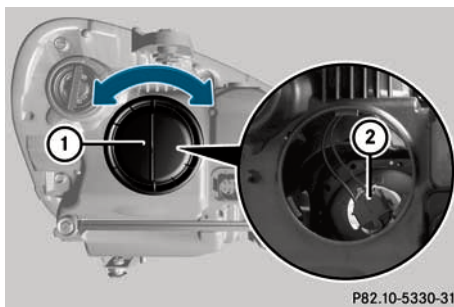

Due to their location, have the bulbs in the left-hand headlamp changed at a qualified specialist workshop, e.g. an authorized Mercedes-Benz Center.

- ▶ Switch off the lights.
- ▶ Open the hood.
- ▶ Turn housing cover ① counter-clockwise and pull it out.
- ▶ Turn bulb holder ② counter-clockwise and pull it out.
- ▶ Take the bulb out of bulb holder ②.
- ▶ Insert the new bulb into bulb holder ②.

<sup>12</sup> Due to their location, have the bulbs in the left-hand headlamp changed at a qualified specialist workshop, e.g. an authorized Mercedes-Benz Center.

- ▶ Insert bulb holder ② into the lamp and turn it clockwise.
- ▶ Align housing cover ① and turn it clockwise until it engages.

### High-beam headlamps (halogen headlamps)/cornering lamps (Bi-Xenon headlamps)

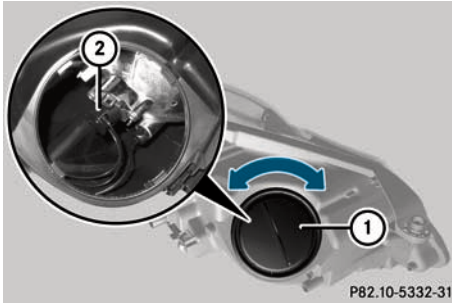

- ▶ Switch off the lights.
- ▶ Open the hood.
- ▶ Turn housing cover ① counter-clockwise and pull it out.
- ▶ Turn bulb holder ② counter-clockwise and pull it out.
- ▶ Take the bulb out of bulb holder ②.
- ▶ Insert the new bulb into bulb holder ②.
- ▶ Insert bulb holder ② into the lamp and turn it clockwise.
- ▶ Align housing cover ① and turn it clockwise until it engages.

### Parking lamps/standing lamps (halogen headlamps)

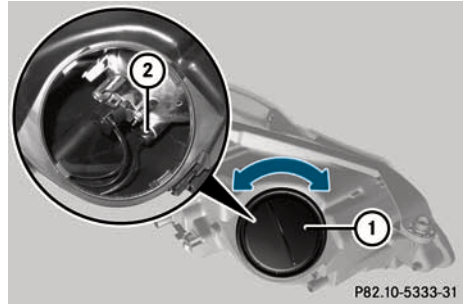

- ▶ Switch off the lights.
- ▶ Open the hood.
- ▶ Turn housing cover ① counter-clockwise and pull it out.
- ▶ Pull out bulb holder ②.
- ▶ Take the bulb out of bulb holder ②.
- ▶ Insert the new bulb into bulb holder ②.
- ▶ Insert bulb holder ②.
- ▶ Align housing cover ① and turn it clockwise until it engages.

### Infrared light (Night View Assist Plus)

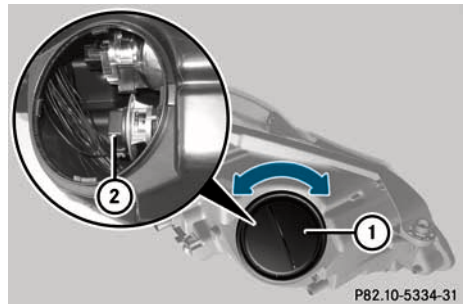

- ▶ Switch off the lights.
- ▶ Open the hood.
- ▶ Turn housing cover ① counter-clockwise and pull it out.
- ▶ Turn bulb ② counter-clockwise and pull it out.

- ▶ Insert new bulb ② and turn it clockwise.
- ▶ Align housing cover ① and turn it clockwise until it engages.

### Turn signal lamp (halogen headlamps)

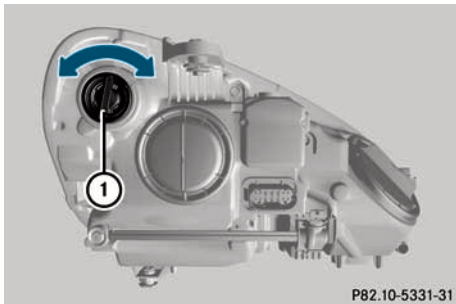

Due to their location, have the bulbs in the left-hand headlamp changed at a qualified specialist workshop, e.g. an authorized Mercedes-Benz Center.

- ▶ Switch off the lights.
- ▶ Open the hood.
- ▶ Turn bulb holder ① counter-clockwise and pull it out.
- ▶ Turn the bulb counter-clockwise, applying slight pressure, and remove it from bulb holder ①.
- ▶ Insert the new bulb into bulb holder ① and turn it clockwise.
- ▶ Insert bulb holder ① into the lamp and turn it clockwise.

### Windshield wipers

#### Switching the windshield wipers on/off

#### WARNING

Wiper blades are components that are subject to wear and tear. Replace the wiper blades twice a year, preferably in the spring and fall. Otherwise the windows will not be wiped



properly. As a result, you may not be able to observe surrounding traffic conditions and could cause an accident.

**!** Do not operate the windshield wipers when the windshield is dry, as this could damage the wiper blades. Moreover, dust that has collected on the windshield can scratch the glass if wiping takes place when the windshield is dry.

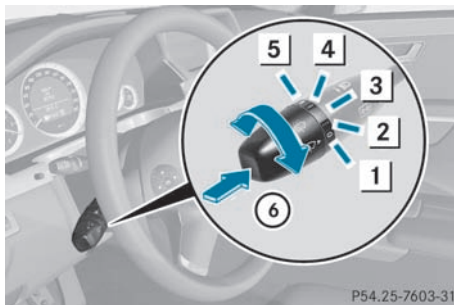
**!** If the windshield wipers leave smears on the windshield after the vehicle has been washed in an automatic car wash, wax or other residues may be the reason for this. Clean the windshield using washer fluid after washing the vehicle in an automatic car wash.



Combination switch

- ①  0 Windshield wipers off
- ②  ... Intermittent wipe, low<sup>13</sup>
- ③  .... Intermittent wipe, high<sup>14</sup>
- ④  — Continuous wipe, slow
- ⑤  = Continuous wipe, fast
- ⑥   Single wipe/   To wipe the windshield using washer fluid

- ▶ Switch on the ignition.
- ▶ Turn the combination switch to the corresponding position.

**!** Intermittent wiping with rain sensor: due to optical influences and the windshield becoming dirty in dry weather conditions,

<sup>13</sup> Rain sensor set to low sensitivity.

<sup>14</sup> Rain sensor set to high sensitivity.

the windshield wipers may be activated inadvertently. This could then damage the windshield wiper blades or scratch the windshield.

For this reason, you should always switch off the windshield wipers in dry weather.

In the **[...]** or **[....]** position, the appropriate wiping frequency is set automatically according to the intensity of the rain. In the **[....]** position, the rain sensor is more sensitive than in the **[...]** position, causing the windshield wipers to wipe more frequently.

### Switching the rear window wiper on/off

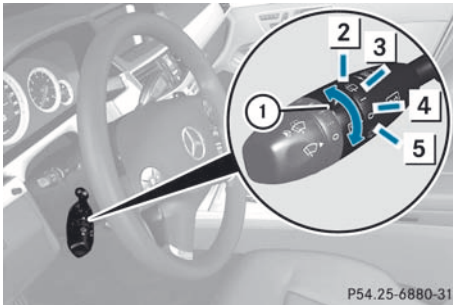

Combination switch

- ① Switch
- ② To wipe with washer fluid
- ③ To switch on intermittent wiping
- ④ **0** To switch off intermittent wiping
- ⑤ To wipe with washer fluid

- ▶ Turn the SmartKey to position **1** or **2** in the ignition lock.
- ▶ Turn switch ① on the combination switch to the corresponding position. When the rear window wiper is switched on, the icon appears in the instrument cluster.

### Replacing the wiper blades

#### Important safety notes

##### WARNING

For safety reasons, switch off the windshield wipers and remove the key from the ignition lock before changing the wiper blades (vehicles with KEYLESS-GO: make sure that the on-board electronics are in state **0**). Otherwise, the wiper motor could be switched on suddenly and cause injury.

- ❗ To avoid damaging the wiper blades, make sure that you touch only the wiper arm of the wiper.
- ❗ Never open the hood if a windshield wiper arm has been folded away from the windshield.

Never fold a windshield wiper arm without a wiper blade back onto the windshield/rear window.

Hold the windshield wiper arm firmly when you change the wiper blade. If you release the windshield wiper arm without a wiper blade and it falls onto the windshield, the windshield may be damaged by the force of the impact.

Mercedes-Benz recommends that you have the wiper blades replaced by a qualified specialist workshop, e.g. at an authorized Mercedes-Benz Center.

### Replacing the windshield wiper blades

#### Removing the wiper blades

- ▶ Remove the SmartKey from the ignition lock or turn it to position **0** (KEYLESS-GO).
- ▶ Fold the wiper arm away from the windshield until it engages.
- ▶ Set the wiper blade at right angles to the wiper arm.

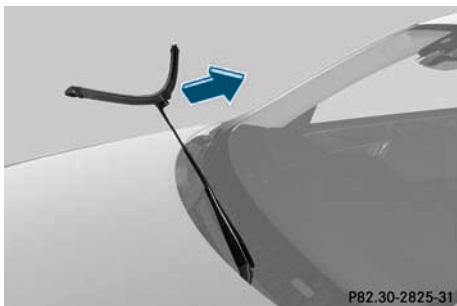

- ▶ Remove the wiper blade from the retaining pin on the wiper arm in the direction of the arrow.

### Installing the wiper blades

- ▶ Push the new wiper blade onto the retaining pin on the wiper arm in the opposite direction to the arrow. Make sure that the wiper blade slides fully onto the retaining pin on the wiper arm.
- ▶ Turn the wiper blade parallel to the wiper arm.
- ▶ Fold the wiper arm back onto the windshield.

### Replacing the rear window wiper blade

#### Removing the wiper blade

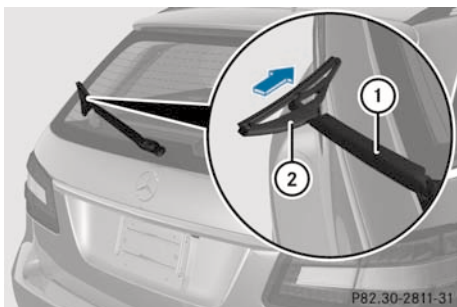

- ▶ Remove the SmartKey from the ignition lock.
- ▶ Fold wiper arm ① away from the rear window until it engages.
- ▶ Position wiper blade ② at a right angle to wiper arm ①.

- ▶ Hold wiper arm ① and press wiper blade ② in the direction of the arrow until it releases.
- ▶ Remove wiper blade ②.

#### Installing the wiper blade

- ▶ Place new wiper blade ② onto wiper arm ①.
- ▶ Hold wiper arm ① and press wiper blade ② in the opposite direction to the arrow until it engages.
- ▶ Make sure that wiper blade ② is seated correctly.
- ▶ Position wiper blade ② parallel to wiper arm ①.
- ▶ Fold wiper arm ① back onto the rear window.

### Problems with the windshield wipers

#### The windshield wipers are obstructed

Leaves or snow, for example, may be obstructing the windshield wiper movement. The wiper motor has been deactivated.

- ▶ For safety reasons, you should remove the SmartKey from the ignition lock.

or

- ▶ Switch off the engine using the Start/Stop button and open the driver's door.
- ▶ Remove the cause of the obstruction.
- ▶ Switch the windshield wipers back on.

#### The windshield wipers are inoperative

The windshield wiper drive is malfunctioning.

- ▶ Select another wiper speed on the combination switch.
- ▶ Have the windshield wipers checked at a qualified specialist workshop.

### **The spray nozzles are misaligned**

---

The windshield washer fluid from the spray nozzles no longer hits the center of the windshield. The spray nozzles are misaligned.

- ▶ Have the spray nozzles adjusted at a qualified specialist workshop.





Useful information .....	130
Overview of climate control systems .....	130
Operating the climate control system .....	134
Setting the air vents .....	140

### Useful information

- i** This Operator's Manual describes all models and all standard and optional equipment of your vehicle available at the time of publication of the Operator's Manual. Country-specific differences are possible. Please note that your vehicle may not be equipped with all features described. This also applies to safety-related systems and functions.
- i** Please read the information on qualified specialist workshops (▷ page 25).

### Overview of climate control systems

#### Important safety notes

##### WARNING

Severe conditions (e.g. strong air pollution) may require replacement of the filter before its scheduled replacement interval. A clogged filter will reduce the air volume to the interior and the windows could fog up, impairing visibility and endangering you and others. Have a blocked filter replaced at a Mercedes-Benz Center as soon as possible.

##### WARNING

Follow the recommended settings for heating and cooling given on the following pages. Otherwise, the windows could fog up, impairing visibility and endangering you and others.

The automatic climate control adjusts the temperature and the humidity of the vehicle interior and filters undesired substances from the air.

The automatic climate control is only operational when the engine is running.<sup>15</sup> Optimum operation is only achieved if you drive with the side windows and sliding

sunroof/panorama roof with power tilt/sliding panel closed.

- i** Ventilate the vehicle for a brief period during warm weather, e.g. using the convenience opening feature (▷ page 91). This will speed up the cooling process and the desired vehicle interior temperature will be reached more quickly.
- i** The integrated filter can filter out most particles of dust and completely filters out pollen. A clogged filter reduces the amount of air supplied to the vehicle interior. For this reason, you should always observe the interval for replacing the filter, which is specified in the Service Booklet. As it depends on environmental conditions, e.g. heavy air pollution, the interval may be shorter than stated in the Service Booklet.
- i** It is possible that the residual heat function may be activated automatically an hour after the SmartKey is removed. The vehicle is then ventilated for 30 minutes to dry the air-conditioning system.

<sup>15</sup> Automatic climate control: the residual heat function can only be activated/deactivated when the ignition is switched off.

## Control panel for dual-zone automatic climate control

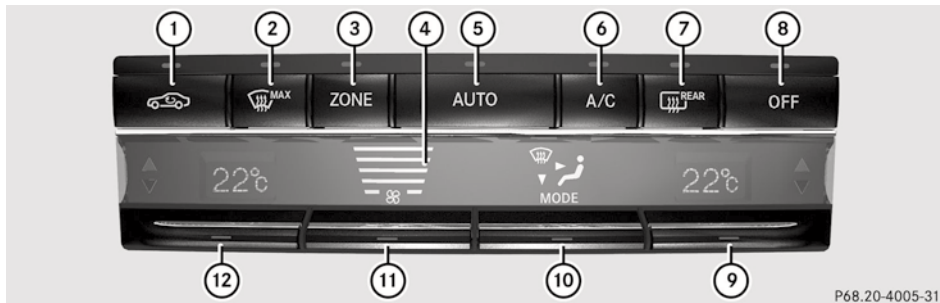

P68.20-4005-31

Canada only

- ① To activate/deactivate air-recirculation mode (▷ page 139)
- ② To defrost the windshield (▷ page 138)
- ③ To switch the ZONE function on/off (▷ page 137)
- ④ Display
- ⑤ To set climate control to automatic (▷ page 135)
- ⑥ To activate/deactivate cooling with air dehumidification (▷ page 134)
- ⑦ To switch the rear window defroster on/off (▷ page 139)
- ⑧ To switch climate control on/off (▷ page 134)
- ⑨ To set the temperature, right (▷ page 136)
- ⑩ To set the air distribution (▷ page 137)
- ⑪ To set the airflow (▷ page 137)
- ⑫ To set the temperature, left (▷ page 136)

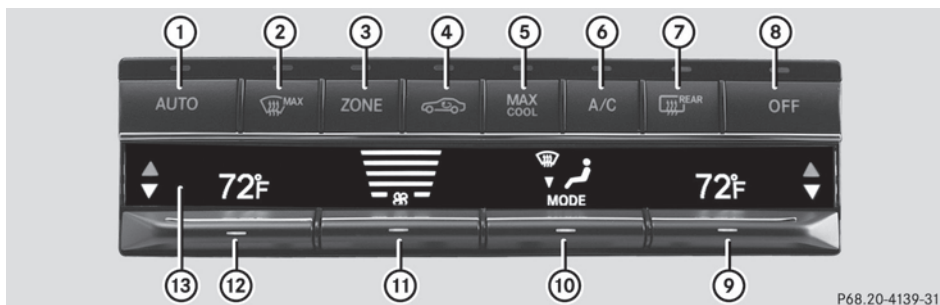

P68.20-4139-31

USA only

- ① To set climate control to automatic (▷ page 135)
- ② To defrost the windshield (▷ page 138)
- ③ To switch the ZONE function on/off (▷ page 137)
- ④ To activate/deactivate air-recirculation mode (▷ page 139)
- ⑤ To switch maximum cooling MAX COOL on/off (▷ page 138)
- ⑥ To activate/deactivate cooling with air dehumidification (▷ page 134)

- ⑦ To switch the rear window defroster on/off (▷ page 139)
- ⑧ To switch climate control on/off (▷ page 134)
- ⑨ To set the temperature, right (▷ page 136)
- ⑩ To set the air distribution (▷ page 137)
- ⑪ To set the airflow (▷ page 137)
- ⑫ To set the temperature, left (▷ page 136)
- ⑬ Display

### Notes on using dual-zone automatic climate control

The following contains notes and recommendations on optimum use of dual-zone automatic climate control.

- Activate climate control using the **AUTO** and **A/C** buttons. The indicator lamps above the **AUTO** and **A/C** buttons light up.
- Set the temperature to 72 °F (22 °C).
- Only use the "defrosting" function briefly until the windshield is clear again.
- Only use "air-recirculation" mode briefly, e.g. if there are unpleasant outside odors or when in a tunnel. The windows could otherwise fog up as, in air-recirculation mode, no fresh air is drawn into the vehicle.
- Use the ZONE function to adopt the temperature settings on the driver's side for the front-passenger side as well. The indicator lamp above the **ZONE** button goes out.

## Control panel for 3-zone automatic climate control

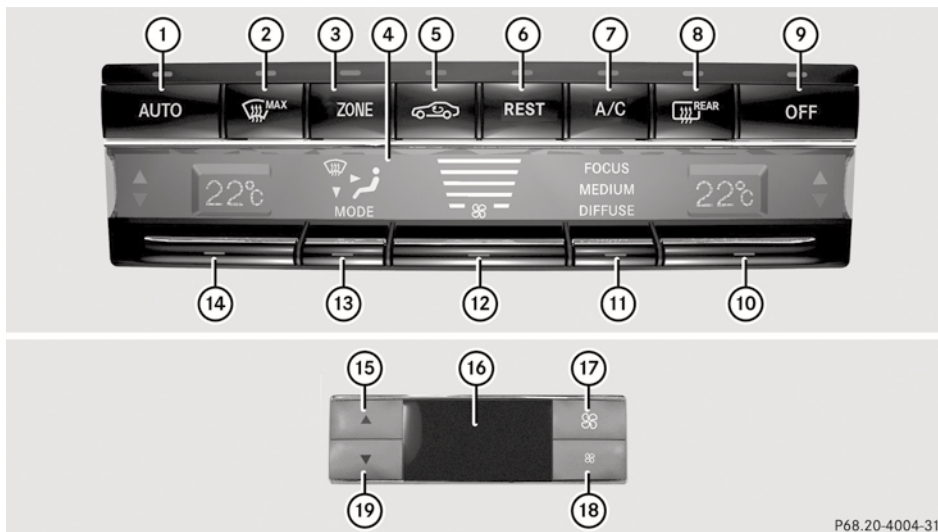

P68.20-4004-31

Canada only

**Front control panel**

- ① To set climate control to automatic (▷ page 135)
- ② To defrost the windshield (▷ page 138)
- ③ To switch the ZONE function on/off (▷ page 137)
- ④ Display
- ⑤ To activate/deactivate air-recirculation mode (▷ page 139)
- ⑥ To activate/deactivate the residual heat function (▷ page 140)
- ⑦ To activate/deactivate cooling with air dehumidification (▷ page 134)
- ⑧ To switch the rear window defroster on/off (▷ page 139)
- ⑨ To switch climate control on/off (▷ page 134)
- ⑩ To set the temperature, right (▷ page 136)
- ⑪ To set climate control to automatic (FOCUS/MEDIUM/DIFFUSE) (▷ page 135)
- ⑫ To set the airflow (▷ page 137)
- ⑬ To set the air distribution (▷ page 137)
- ⑭ To set the temperature, left (▷ page 136)

**Rear control panel**

- ⑮ To increase the temperature (▷ page 136)
- ⑯ Display
- ⑰ To increase the airflow (▷ page 137)

- ⑱ To reduce the airflow (▷ page 137)
- ⑲ To reduce the temperature (▷ page 136)

### Notes on using 3-zone automatic climate control

The following contains instructions and recommendations to enable you to get the most out of your automatic climate control.

- Activate climate control using the **AUTO** and **A/C** buttons. The indicator lamps above the **AUTO** and **A/C** buttons light up. You can also set the airflow and air distribution of the automatic climate control to one of three levels (FOCUS/MEDIUM/DIFFUSE). You can set the desired level using button ⑪. The MEDIUM level is recommended.
- Set the temperature to 72 °F (22 °C).
- Only use the "defrosting" function briefly until the windshield is clear again.
- Only use "air-recirculation" mode briefly, e.g. if there are unpleasant outside odors or when in a tunnel. The windows could otherwise fog up as, in air-recirculation mode, no fresh air is drawn into the vehicle.
- Use the ZONE function to adopt the temperature settings on the driver's side for the front-passenger side and the rear compartment as well. The indicator lamp above the **ZONE** button goes out.
- Use the residual heat function if you want to heat or ventilate the vehicle interior when the ignition is switched off. The "residual heat" function can only be activated or deactivated with the ignition switched off.

### Operating the climate control system

#### Activating/deactivating climate control

#### Important information

##### WARNING

When the climate control system is deactivated, the outside air supply and circulation are also deactivated. Only choose this setting for a short time. Otherwise the windows could fog up, impairing visibility and endangering you and others.

- ① Switch on climate control primarily using the **AUTO** button (▷ page 135).

#### Activating/deactivating

- ▶ Turn the SmartKey to position **2** in the ignition lock.
- ▶ **To switch on:** press the **AUTO** button. The indicator lamp above the **AUTO** button lights up. Airflow and air distribution are set to automatic mode.

or

- ▶ Press the **OFF** button. The indicator lamp above the **OFF** button goes out. The previously selected settings come into effect again.
- ▶ **To switch off:** press the **OFF** button. The indicator lamp above the **OFF** button lights up.

#### Activating/deactivating cooling with the air dehumidification function

#### Important information

The cooling with air dehumidification function is only available when the engine is running. The air inside the vehicle is cooled and

dehumidified according to the temperature selected.





### WARNING

If you switch off the cooling function, the vehicle will not be cooled when weather conditions are warm. The windows can fog up more quickly. Window fogging may impair visibility and endanger you and others.

Condensation may drip from the underside of the vehicle when it is in cooling mode. This is normal and not a sign that there is a malfunction.

- i** The cooling with air dehumidification function uses refrigerant R134a. This coolant does not contain chlorofluorocarbons, and therefore does not damage the ozone layer.

### Activating/deactivating

- ▶ **To activate:** press the  button. The indicator lamp above the  button lights up.
- ▶ **To switch off:** press the  button. The indicator lamp above the  button goes out. The cooling with air dehumidification function has a delayed switch-off feature.

### Problems with the cooling with air dehumidification function

When you press the  button, the indicator lamp in the button flashes three times or remains off. You can no longer switch on the cooling with air dehumidification function.

- ▶ Consult a qualified specialist workshop.

### Setting climate control to automatic



### WARNING

If you switch off the cooling function, the vehicle will not be cooled when weather



conditions are warm. The windows can fog up more quickly. Window fogging may impair visibility and endanger you and others.

In automatic mode, the set temperature is maintained automatically at a constant level. The system automatically regulates the temperature of the dispensed air, the airflow and the air distribution.



Automatic mode will achieve optimal operation if cooling with air dehumidification is also activated. If desired, cooling with air dehumidification can be deactivated.

- ▶ Turn the SmartKey to position **2** in the ignition lock.
- ▶ Set the desired temperature.
- ▶ **To activate:** press the  button. The indicator lamp above the  button lights up. Automatic air distribution and airflow are activated.

- i** 3-zone automatic climate control: when automatic mode is activated, you can select a climate mode setting (> page 136).

- ▶ **To deactivate:** press the air distribution button.
  - Dual-zone automatic climate control: press button  (> page 131).
  - 3-zone automatic climate control: press button  (> page 133).
- The indicator lamp above the  button goes out.

or

- ▶ Press the airflow button.
  - Dual-zone automatic climate control: press button  (> page 131).
  - 3-zone automatic climate control: press button  (> page 133).
- The indicator lamp above the  button goes out.



### Adjusting the climate mode settings (AIR FLOW)

This function is only available with 3-zone automatic climate control.

The climate mode settings are especially effective at high temperatures.

You can select the following climate mode settings in automatic mode:

- FOCUS** high airflow that is set slightly cooler
- MEDIUM** medium airflow, standard setting
- DIFFUSE** low airflow that is set slightly warmer and with less draft

- ▶ Turn the SmartKey to position **2** in the ignition lock.
- ▶ Press the **AUTO** button.
- ▶ Press button **(11)** up or down and select the desired level (▷ page 133)

### Setting the temperature

#### 2-zone automatic climate control

Different temperatures can be set for the driver's and front-passenger sides.

- ▶ Turn the SmartKey to position **2** in the ignition lock.
- ▶ **To increase/reduce:** press button **(9)** or **(12)** up or down (▷ page 131).

Only change the temperature setting in small increments. Start at 72 °F (22 °C).

#### 3-zone automatic climate control

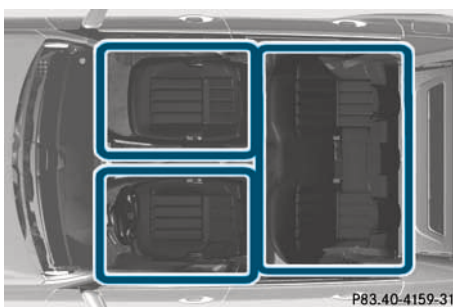

Automatic climate control climate zones

You can select different temperature settings for the driver's and front-passenger sides as well as for the rear compartment.

- ▶ Turn the SmartKey to position **2** in the ignition lock.
- ▶ **To increase/reduce the temperature in the front compartment:** press button **(10)** or **(14)** up or down (▷ page 133).

Only change the temperature setting in small increments. Start at 72 °F (22 °C).

- ▶ **To increase/reduce the temperature in the rear compartment using the front control panel:** press the **ZONE** button. The indicator lamp above the **ZONE** button goes out.
- ▶ Press button **(10)** or **(14)** up or down (▷ page 133).







Only change the temperature setting in small increments. Start at 72 °F (22 °C).

- ▶ **To increase/reduce the temperature in the rear compartment using the rear control panel:** press button **(15)** or **(19)** (▷ page 133).

Only change the temperature setting in small increments. Start at 72 °F (22 °C).

## Setting the air distribution

### Air distribution settings

-  Directs air through the defroster vents
-  Directs air through the center and side air vents
-  Directs the airflow through the footwell air vents
-  Directs the airflow through the center, side and footwell air vents<sup>16</sup>
-  Directs the airflow through the defroster, center and side air vents<sup>17</sup>.
-  Directs air through the defroster and footwell vents

**i** Regardless of the air distribution setting, airflow is always directed through the side air vents.. The side air vents can only be closed when the controls on the side air vents are turned downwards.

### Dual-zone automatic climate control

- ▶ Turn the SmartKey to position **2** in the ignition lock.
- ▶ Press switch **(10)** up or down repeatedly until the desired symbol appears in the display (▶ page 131).

### 3-zone automatic climate control

- ▶ Turn the SmartKey to position **2** in the ignition lock.
- ▶ Press switch **(13)** up or down repeatedly until the desired symbol appears in the display (▶ page 133).

## Setting the airflow

### Dual-zone automatic climate control

- ▶ Turn the SmartKey to position **2** in the ignition lock.
- ▶ **To increase/reduce:** press button **(11)** up or down (▶ page 131).

### 3-zone automatic climate control

- ▶ Turn the SmartKey to position **2** in the ignition lock.
- ▶ **To increase/reduce front-compartment airflow:** press button **(12)** up or down (▶ page 133).
- ▶ **To increase/reduce the rear airflow:** press button **(17)** or **(18)** (▶ page 133).

## Switching the ZONE function on/off

- ▶ **To switch on:** press the **[ZONE]** button. The indicator lamp above the **[ZONE]** button lights up.

Dual-zone automatic climate control: the temperature setting for the driver's side is not adopted for the front-passenger side.

3-zone automatic climate control: the temperature setting for the driver's side is not adopted for the front-passenger side and the rear compartment.

When the buttons for temperature, airflow or air distribution are activated, the temperature setting for the driver's side is not adopted for the other climate control zones.

- ▶ **To switch off:** press the **[ZONE]** button. The indicator lamp above the **[ZONE]** button goes out.

Dual-zone automatic climate control: the temperature setting for the driver's side is adopted for the front-passenger side.

3-zone automatic climate control: the temperature setting for the driver's side is

<sup>16</sup> USA only.

<sup>17</sup> Coupe: Canada only.



adopted for the front-passenger side and the rear compartment.

### Defrosting the windshield

You can use this function to defrost the windshield or to defrost the inside of the windshield and the side windows.



**i** You should only select the defrosting function until the windshield is clear again.

► Turn the SmartKey to position **2** in the ignition lock.



► **To activate:** press the  button. The indicator lamp above the  button lights up.

The climate control system switches to the following functions:



- cooling with air dehumidification on
- high airflow<sup>18</sup>
- high temperature<sup>18</sup>
- air distribution to the windshield and front side windows
- air-recirculation mode off



► **To switch off:** press the  button. The indicator lamp above the  button goes out. The previously selected settings come into effect again. The cooling with air dehumidification function remains on. Air-recirculation mode remains deactivated.

or

► Press the  button. The indicator lamp above the  button goes out. Airflow and air distribution are set to automatic mode.

or

► **Automatic climate control:** press temperature button  or  up or down (▷ page 131).

**Automatic climate control:** press temperature button  or  up or down (▷ page 133).

or

► **Dual-zone automatic climate control:** press switch  up or down (▷ page 131).

**3-zone automatic climate control:** press button  up or down (▷ page 133).

### MAX COOL maximum cooling

The MAX COOL function is only available in vehicles for the USA.

MAX COOL is only operational when the engine is running.

When you activate MAX COOL, climate control switches to the following functions:



- maximum cooling
- maximum airflow
- air-recirculation mode on

► **To activate:** press the  button. The indicator lamp above the button lights up.

► **To deactivate:** press the  button again. The indicator lamp goes out. The previously selected settings come into effect again.

### Defrosting the windows

#### Windows fogged up on the inside



- Activate the cooling with air dehumidification function .
- Activate automatic mode .
- If the windows continue to fog up, activate the defrosting function (▷ page 138).



**i** You should only select this setting until the windshield is clear again.

#### Windows fogged up on the outside

- Switch on the windshield wipers.
- **Automatic climate control:** press switch  up or down (▷ page 131) until the

<sup>18</sup> Depending on the outside temperature.

 or  symbol appears in the display.

- ▶ **Automatic climate control:** press button  up or down (▷ page 133) until the  or  symbol appears in the display.

- ❗ You should only select this setting until the windshield is clear again.

## Rear window defroster



### Activating/deactivating

#### WARNING

Any accumulation of snow and ice should be removed from the rear window before driving. Visibility could otherwise be impaired, endangering you and others.

The rear window defroster has a high current draw. You should therefore switch it off as soon as the window is clear as it only switches off automatically after several minutes.

If the battery voltage is too low, the rear window defroster may switch off.

- ▶ Turn the SmartKey to position **2** in the ignition lock.
- ▶ Press the  button.  
The indicator lamp above the  button lights up or goes out.

### Problems with the rear window defroster

The rear window defroster has deactivated itself prematurely or cannot be activated.

- ▶ Switch off any consumers that are not required, e.g. reading lamps or interior lighting.  
When the battery is sufficiently charged, the rear window defroster is activated again automatically.





### Activating/deactivating air-recirculation mode

You can deactivate the flow of fresh air if unpleasant odors are entering the vehicle from outside. The air already inside the vehicle will then be recirculated.

The operation of air-recirculation mode is the same for all control panels.

#### WARNING

Fogged windows impair visibility, endangering you and others. If the windows begin to fog on the inside, switching off the air recirculation mode immediately should clear interior window fogging. If interior window fogging persists, make sure the air conditioning is activated, or press the  button.

- ▶ Turn the SmartKey to position **2** in the ignition lock.
- ▶ **To activate:** press the  button.  
The indicator lamp above the  button lights up.
- ❗ In the event of high pollution levels<sup>19</sup> or at high outside temperatures, air-recirculation mode is automatically activated. When air-recirculation mode is activated automatically, the indicator lamp above the  button does not light up. Outside air is added after about 30 minutes.
- ▶ **To switch off:** press the  button.  
The indicator lamp above the  button goes out.

<sup>19</sup> Automatic climate control only.

- i** Air-recirculation mode deactivates automatically:
  - after approximately five minutes if outside temperatures are less than about 41 °F (5 °C)
  - after approximately five minutes if cooling with air dehumidification is deactivated
  - after approximately 30 minutes if outside temperatures are over about 41 °F (5 °C)

### Activating/deactivating the residual heat function

The residual heat function is only available in vehicles for Canada with automatic climate control.

It is possible to make use of the residual heat of the engine to continue heating the stationary vehicle for up to 30 minutes after the engine has been switched off. The heating time depends on the temperature that has been set.

- i** The blower will run at a low speed regardless of the airflow setting.
  - i** If you activate the residual heat function at high temperatures, only the ventilation will be activated. The blower runs at medium speed.
  - i** It is possible that the residual heat function may be activated automatically an hour after the SmartKey is removed. The vehicle is then ventilated for 30 minutes to dry the air-conditioning system.
- Turn the SmartKey to position **0** in the ignition lock or remove it.
- **To activate:** press the **REST** button. The indicator lamp above the **REST** button lights up.
- **To switch off:** press the **REST** button. The indicator lamp above the **REST** button goes out.

- i** Residual heat is deactivated automatically:
  - after about 30 minutes
  - when the ignition is switched on
  - if the battery voltage drops
  - if the coolant temperature is too low

### Setting the air vents

#### Important safety notes

##### WARNING

When operating the climate control, the air that enters the passenger compartment through the air vents can be very hot or very cold (depending on the set temperature). This could cause burns or frostbite to unprotected skin in the immediate area of the air vents.

Always keep sufficient distance between unprotected parts of the body and the air vents. If necessary, use the air distribution adjustment to direct the air to air vents in the vehicle interior that are not in the immediate area of unprotected skin.

In order to ensure the direct flow of fresh air through the air vents into the vehicle interior, please observe the following notes:

- keep the air inlet between the windshield and the hood free of blockages, such as ice, snow or leaves.
- never cover the air vents or air intake grille in the vehicle interior.
- i** For virtually draft-free ventilation, adjust the sliders of the air vents to the center position.

### Setting the center air vents

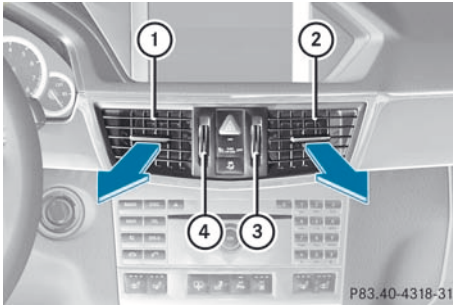

- ① Center air vent, left
- ② Center air vent, right
- ③ Center vent thumbwheel, right
- ④ Center vent thumbwheel, left

► **To open/close:** turn thumbwheels ③ and ④ up or down.

### Setting the side air vents

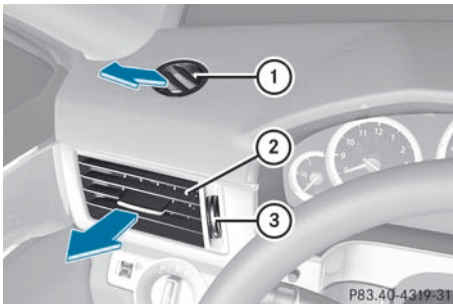

► **To open/close:** turn thumbwheel ③ up or down.

- ❶ Side window defroster vent ① is never completely shut, even if side air vent ② is shut.

### Setting the glove box air vent

When automatic climate control is activated, the glove box can be ventilated, for instance to cool its contents. The level of airflow

depends on the airflow and air distribution settings.

❗ Close the air vent when heating the vehicle.

At high outside temperatures, open the air vent and activate the "cooling with air dehumidification" function. Otherwise, temperature-sensitive items stored in the glove box could be damaged.

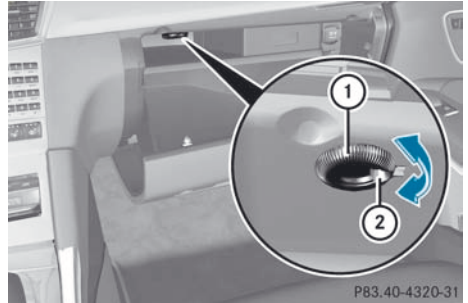

- ① Air vent thumbwheel
- ② Air vent

► **To open/close:** turn thumbwheel ① clockwise or counter-clockwise.

### Setting the rear-compartment air vents

#### Setting the center vents in the rear compartment

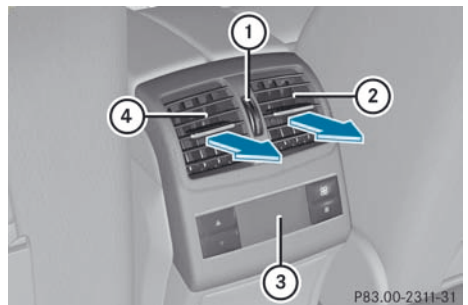

- ① Rear-compartment air vent thumbwheel
- ② Rear-compartment air vent, right

- ③ Rear control panel for automatic climate control<sup>20</sup>
- ④ Rear-compartment air vent, left
- **To open/close:** turn thumbwheel ① up or down.

### Setting the B-pillar air vents

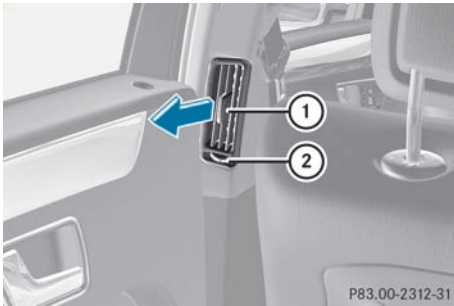

- ① B-pillar air vent
- ② Thumbwheel for B-pillar air vent
- **To open/close:** turn thumbwheel ② to the left or right.

<sup>20</sup> Canada only.



Useful information .....	144
Breaking-in notes .....	144
Driving .....	144
Automatic transmission .....	152
Refueling .....	160
Parking .....	167
Driving tips .....	169
Driving systems .....	175

### Useful information

- i** This Operator's Manual describes all models and all standard and optional equipment of your vehicle available at the time of publication of the Operator's Manual. Country-specific differences are possible. Please note that your vehicle may not be equipped with all features described. This also applies to safety-related systems and functions.
- i** Please read the information on qualified specialist workshops (▷ page 25).

### Breaking-in notes

#### The first 1000 miles (1500 km)

The more you look after the engine when it is new, the more satisfied you will be with its performance in the future.

- Drive at varying vehicle speeds and engine speeds for the first 1000 miles (1500 km) for this reason.
- Avoid overstraining the vehicle during this period, e.g. driving at full throttle.
- Change gear in good time, at the latest when the tachometer needle is  $\frac{2}{3}$  of the way to the red area in the tachometer display.
- If possible, do not depress the accelerator pedal past the point of resistance (kickdown).
- Only select shift ranges **3**, **2** or **1** when driving slowly, e.g. in mountainous terrain.

After 1000 miles (1500 km), you can increase the engine speed gradually and bring the vehicle up to full speed.

Additional breaking-in notes for AMG vehicles:

- do not drive faster than 85 mph (140 km/h) in the first 1000 miles (1500 km).
- only allow the engine to reach a maximum engine speed of 4500 rpm briefly.
- change gear in good time.
- i** You should also observe these notes on running in if the engine or parts of the drive train on your vehicle have been replaced.
- i** Always observe the respective speed restrictions.

#### AMG vehicles with rear axle locking differential

Your vehicle is equipped with a self-locking differential on the rear axle. For better protection of the differential on the rear axle, carry out an oil change after a breaking-in phase of 2000 miles (3000 km). This oil change extends the service life of the differential. Have the oil change carried out at a qualified specialist workshop. Mercedes-Benz recommends that you use an authorized Mercedes-Benz Center for this purpose.

### Driving

#### Important safety notes

##### WARNING

Make sure absolutely no objects are obstructing the pedals' range of movement. Keep the driver's footwell clear of all obstacles. If there are any floor mats or carpets in the footwell, make sure the pedals still have sufficient clearance.

During sudden driving or braking maneuvers the objects could get caught between the pedals. You could then no longer brake or accelerate. This could lead to accidents and injury.

**⚠ WARNING**

On slippery road surfaces, never downshift in order to obtain braking action. This could result in drive wheel slip and reduced vehicle control. Your vehicle's ABS will not prevent this type of loss of control.

**⚠ WARNING**

It is dangerous to shift the automatic transmission out of parking position **P** or neutral position **N** if the engine speed is higher than idle speed. If your foot is not firmly on the brake pedal, the vehicle could accelerate quickly forward or in reverse. You could lose control of the vehicle and hit someone or something. Only shift into gear when the engine is idling normally and when your right foot is firmly on the brake pedal.

- !** Warm up the engine quickly. Do not use the engine's full performance until it has reached operating temperature.

Only shift the automatic transmission to the desired drive position when the vehicle is stationary.

Where possible, avoid spinning the drive wheels when pulling away on slippery roads. You could otherwise damage the drive train.

- !** AMG vehicles: at low engine oil temperatures (below 68 °F (+20 °C), the maximum engine speed is restricted in order to protect the engine. To protect the engine and maintain smooth engine operation, avoid driving at full throttle when the engine is cold.

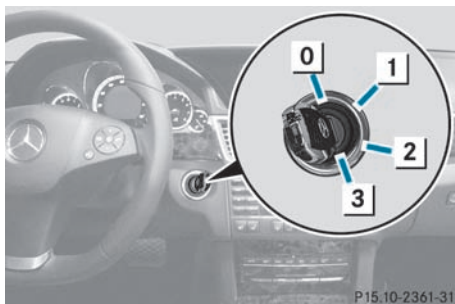
**SmartKey positions****SmartKey**

- 0** To remove the SmartKey (shift the transmission to position **P**)
- 1** Power supply for some consumers, such as the windshield wipers
- 2** Ignition (power supply for all consumers and drive position)
- 3** To start the engine

If the SmartKey is in position **0** in the ignition lock for an extended period of time, it can no longer be turned in the ignition lock. The steering is then locked. To unlock, remove the SmartKey and reinsert it into the ignition lock. The steering is locked when you remove the SmartKey from the ignition lock.

- i** The SmartKey can be turned in the ignition lock even if it is not the correct SmartKey for the vehicle. The ignition is not switched on. The engine cannot be started.

**KEYLESS-GO****General information**

Vehicles with KEYLESS-GO are equipped with a SmartKey featuring an integrated KEYLESS-GO function and a detachable Start/Stop button.

The Start/Stop button must be inserted into the ignition lock and the SmartKey must be in the vehicle.

Pressing the Start/Stop button several times in succession corresponds to the different

SmartKey positions in the ignition lock. This is only the case if you are not depressing the brake pedal.

If you depress the brake pedal and press the Start/Stop button, the engine starts immediately.

The Start/Stop button can be removed from the ignition lock. Then, you can insert the SmartKey into the ignition lock.

- i** You do not have to remove the Start/Stop button from the ignition lock when you leave the vehicle. However, you should always take the SmartKey with you when leaving the vehicle. The vehicle can be started with the Start/Stop button and the electrical equipment can be operated while the SmartKey is in the vehicle.

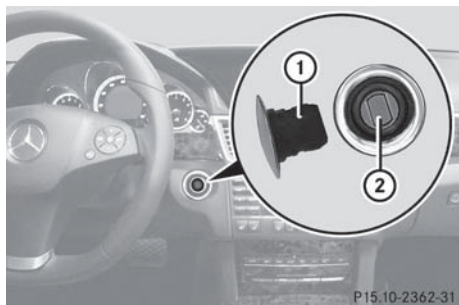

- ① Start/Stop button
- ② Ignition lock

▶ Insert Start/Stop button ① into ignition lock ②.

- i** When you insert Start/Stop button ① into ignition lock ②, the system requires a detection time of approximately two seconds before you can use Start/Stop button ①.

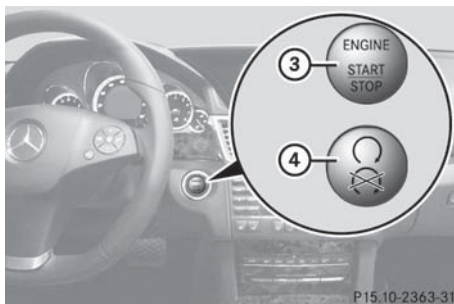

Start/Stop button

- ③ USA only
- ④ Canada only

- ▶ Position 0: if Start/Stop button ① has not yet been pressed, this corresponds to the SmartKey being removed from the ignition.
- ▶ Position 1: press Start/Stop button ①. You can now activate the windshield wipers, for example.

- i** If you then open the driver's door when in this position, the power supply is deactivated.
- ▶ Position 2 (ignition): press Start/Stop button ① twice.

- i** If you press Start/Stop button ① once when in this position and the driver's door is open, the power supply is deactivated again.

As soon as the ignition is switched on, all the indicator lamps in the instrument cluster light up. If an indicator lamp does not go out after the engine is started or if it lights up while the vehicle is in motion, see (▷ page 263).

## Starting the engine

### Important safety notes

#### WARNING

Inhalation of exhaust gas is hazardous to your health. All exhaust gas contains carbon monoxide (CO), and inhaling it can cause unconsciousness and possible death.

Do not run the engine in confined areas (such as a garage) which are not properly ventilated. If you think that exhaust gas fumes are entering the vehicle while driving, have the cause determined and corrected immediately. If you must drive under these conditions, drive only with at least one window fully open at all times.

**!** Do not depress the accelerator pedal when starting the engine.

**i** **Vehicles with a gasoline engine:** the catalytic converter is preheated for up to 30 seconds after a cold start. The sound of the engine may change during this time.

### Automatic transmission

▶ Shift the transmission to position **P**. The transmission position display in the multifunction display shows **P**.

**i** You can also start the engine when the transmission is in position **N**.

### Starting procedure with the SmartKey

**i** To start the engine using the SmartKey instead of KEYLESS-GO, pull the Start/Stop button out of the ignition lock.

▶ **To start a gasoline engine:** turn the SmartKey to position **3** in the ignition lock (▷ page 145) and release it as soon as the engine is running.

▶ **To start a diesel engine:** turn the SmartKey to position **2** in the ignition lock (▷ page 145).

The  preglow indicator lamp in the instrument cluster lights up.

▶ When the  preglow indicator lamp goes out, turn the SmartKey to position **3** (▷ page 145) and release it as soon as the engine is running.

**i** You can start the engine without preglow if the engine is warm.

### Using KEYLESS-GO to start the engine

#### WARNING

As long as the SmartKey is in your vehicle, the vehicle can be started. Therefore, never leave children unattended in the vehicle, as they could otherwise accidentally start the engine. When leaving the vehicle, always take the SmartKey with you and lock the vehicle. Do not leave children unattended in the vehicle, or with access to an unlocked vehicle. A child's unsupervised access to a vehicle could result in an accident and/or serious personal injury.

**i** The Start/Stop button can be used to start the vehicle manually without inserting the SmartKey into the ignition lock. The Start/Stop button must be inserted into the ignition lock and the SmartKey must be in the vehicle. This mode for starting the engine operates independently of the ECO start/stop automatic engine start function.

▶ Depress the brake pedal and keep it depressed.

▶ **To start a gasoline engine:** press the Start/Stop button (▷ page 145) once. The engine starts.

▶ **To start a diesel engine:** press the Start/Stop button (▷ page 145) once. Preglow is activated and the engine starts.

**i** If the engine is warm, the preglow time is shortened.

### Pulling away

### Automatic transmission

#### WARNING

It is dangerous to shift the automatic transmission out of parking position **P** or neutral position **N** if the engine speed is higher than idle speed. If your foot is not firmly on the brake pedal, the vehicle could accelerate quickly forward or in reverse. You could lose control of the vehicle and hit

someone or something. Only shift into gear when the engine is idling normally and when your right foot is firmly on the brake pedal.

**i** It is only possible to shift the transmission from position **P** to the desired position if you depress the brake pedal. Only then is the parking lock released. If you do not depress the brake pedal, you can move the DIRECT SELECT lever but the parking lock remains engaged.

- ▶ Depress the brake pedal and keep it depressed.
- ▶ Shift the transmission to position **D** or **R**.
- ▶ Release the parking brake (▷ page 169).
- ▶ Release the brake pedal.
- ▶ Carefully depress the accelerator pedal.

**!** If a warning tone sounds and the **Release Park. Brake** message appears in the multifunction display, the parking brake is still applied. Release the parking brake.

**i** The vehicle locks centrally once you have pulled away. The locking knobs in the doors drop down.

You can open the doors from the inside at any time.

You can also deactivate the automatic locking feature (▷ page 228).

**i** Upshifts take place at higher engine speeds after a cold start. This helps the catalytic converter to reach its operating temperature more quickly.

### Hill start assist

Hill start assist helps you when pulling away forwards or in reverse on an uphill gradient. It holds the vehicle for a short time after you have removed your foot from the brake pedal. This gives you enough time to move your foot from the brake pedal to the accelerator pedal and depress it before the vehicle begins to roll.

### WARNING

Never leave the vehicle when it is held by hill start assist. After approximately one second, hill start assist will no longer brake your vehicle and it could roll away.

- ▶ Take your foot off the brake pedal.
- i** Once you have taken your foot off the brake pedal, the vehicle is held for around one second.
- ▶ Pull away.

Hill start assist will not function if:

- you are pulling away on a level road or a downhill gradient.
- the transmission is in position **N**.
- the parking brake is applied.
- ESP<sup>®</sup> is malfunctioning.

### ECO start/stop function

#### General information

The ECO start/stop function is only available for the E 63 AMG.

The ECO start/stop function is only available in drive program **C**.

The ECO start/stop function switches the engine off automatically when the vehicle stops moving.

The engine starts automatically when the driver wants to pull away again. The ECO start/stop function thereby helps you to reduce the fuel consumption and emissions of your vehicle.

The ECO start/stop function is activated each time the engine is switched on. If all the requirements are fulfilled for automatic engine switch-off (▷ page 149), the green **ECO** symbol is shown in the multifunction display and **Stop/Start active** appears. If not all of the requirements are fulfilled, the **ECO** symbol is shown in yellow and **Stop/Start inactive** appears.

If the ECO start/stop function is deactivated (▷ page 150), the **[ECO]** symbol is not shown.

### **WARNING**

If the engine is switched off and the ECO symbol is shown in green in the multifunction display, the engine has been switched off automatically. All of the vehicle's systems remain active. If you open the door, unfasten your seat belt or remove your foot from the brake pedal, the engine will automatically start. The vehicle may begin moving. You could suffer serious or even fatal injury or cause an accident resulting in injury or death. Never leave the vehicle while the ECO symbol in the multifunction display is shown in green or yellow. Always secure the vehicle against rolling away before leaving it.

**!** Always switch the ignition off and take the key with you when leaving the vehicle.

### **Automatic engine switch-off**

The ECO start/stop function switches the engine off automatically if the vehicle is braked to a standstill and the brake remains depressed with the transmission in position **D** or **N**.

**i** You can still activate the HOLD function when the vehicle is stationary, even if the engine has been switched off automatically. It is then not necessary to continue applying the brakes during the automatic stop phase. When you depress the accelerator pedal, the engine starts automatically and the braking effect of the HOLD function is deactivated. Depress the accelerator pedal carefully, as the engine must be started first.

The engine is only switched off if:

- the outside temperature is within the range which is suitable for the system.
- the engine is at normal operating temperature.
- the set temperature for the vehicle interior has been reached.

- the battery is sufficiently charged.
  - the system detects that the windshield is not fogged up when the air-conditioning system is switched on.
  - the hood is closed.
  - no engine-relevant diagnostics are active.
  - the vehicle is not being steered.
  - the front door is closed and the seat belt is fastened.
- i** During automatic engine switch-off, the climate control system only operates at a reduced capacity. If you require full climate control capacity, the ECO start/stop function can be deactivated by pressing the ECO button (▷ page 150).

### **Automatic engine start**

The engine is started automatically if you:

- release the brake pedal when HOLD is not activated and the transmission is in position **D** or **N**
- shift the transmission to position **R**
- depress the accelerator pedal
- have switched off the ECO start/stop function by pressing the ECO button
- switch to drive program **S**, **S+** or **M**
- unfasten your seat belt or open the driver's door

The engine is also started automatically if:

- the vehicle starts to roll.
- the brake system requires this.
- the system detects moisture on the windshield when the air-conditioning system is switched on.
- the charge level of the battery is too low.
- the driver's seat belt is removed or the driver's door is opened.



## Deactivating/activating the ECO start/stop function



Example: ECO button

- i** If indicator lamp ② is off, the ECO start/stop function has been deactivated manually or as the result of a malfunction. The engine will then not be switched off automatically when the vehicle stops.
- i** Every time you start the engine, the ECO start/stop function is switched on and the automatic transmission shifts to automatic drive program **C**.

### Deactivating

- ▶ In drive program **C**, press button ①.

or

- ▶ Switch to drive program **S**, **S+** or **M** (▷ page 156). Indicator lamp ② on button ① and the **ECO** symbol in the multifunction display go out.

The **Stop/Start active** or **Stop/Start inactive** message disappears in the AMG menu in the multifunction display.

### Activating

- ▶ Press button ①. Indicator lamp ② lights up. If drive program **S**, **S+** or **M** is selected, the automatic transmission switches to drive program **C**.

If all conditions for automatic engine switch-off (▷ page 149) are fulfilled, the **ECO** symbol is shown in green in the

multifunction display. In addition, the **Stop/Start active** display message is shown in the AMG display in the multifunction display.

If not all conditions for automatic engine switch-off are fulfilled, (▷ page 149) the **Stop/Start inactive** display message and the **ECO** symbol are shown in yellow in the AMG menu in the multifunction display. If this is the case, the ECO start/stop function is not available.

Problems with the engine	
Problem	Possible causes/consequences and ► Solutions
The engine does not start. The starter motor can be heard.	<ul style="list-style-type: none"> <li>• There is a malfunction in the engine electronics.</li> <li>• There is a malfunction in the fuel supply.</li> </ul> <p>► Before attempting to start the engine again, turn the SmartKey in the ignition back to position <b>0</b> or press the Start/Stop button repeatedly until all indicator lamps in the instrument cluster go out.</p> <p>► Try to start the engine again (▷ page 146). Avoid excessively long and frequent attempts to start the engine as these will drain the battery.</p> <p>If the engine does not start after several attempts:</p> <p>► Consult a qualified specialist workshop, e.g. an authorized Mercedes-Benz Center.</p>
The engine does not start. You cannot hear the starter motor.	<p>The on-board voltage is too low because the battery is too weak or discharged.</p> <p>► Jump-start the vehicle (▷ page 338).</p> <p>If the engine does not start despite attempts to jump-start it:</p> <p>► Consult a qualified specialist workshop, e.g. an authorized Mercedes-Benz Center.</p> <p>The starter motor was exposed to a thermal load that was too high.</p> <p>► Allow the starter motor to cool down for approximately two minutes.</p> <p>► Try to start the engine again.</p> <p>If the engine still does not start:</p> <p>► Consult a qualified specialist workshop, e.g. an authorized Mercedes-Benz Center.</p>

Problem	Possible causes/consequences and ► Solutions
Vehicles with a gasoline engine: The engine is not running smoothly and is misfiring.	There is a malfunction in the engine electronics or a mechanical component of the engine management system. ► Only depress the accelerator pedal slightly. ► Have the cause rectified immediately at a qualified specialist workshop, e.g. an authorized Mercedes-Benz Center. Otherwise, non-combusted fuel may get into the catalytic converter and damage it.
The coolant temperature gauge shows a value above 248 °F (120 °C).	The coolant level is too low. The coolant is too hot and the engine is no longer being cooled sufficiently. ► Stop as soon as possible and allow the engine and the coolant to cool down. ► Check the coolant level (► page 311). Observe the warning notes as you do so and add coolant if necessary.

## Automatic transmission

### Important safety notes

#### WARNING

It is dangerous to shift the automatic transmission out of parking position **P** or neutral position **N** if the engine speed is higher than idle speed. If your foot is not firmly on the brake pedal, the vehicle could accelerate quickly forward or in reverse. You could lose control of the vehicle and hit someone or something. Only shift into gear when the engine is idling normally and when your right foot is firmly on the brake pedal.

#### WARNING

Keep in mind that turning off the engine alone only will shift the automatic transmission into neutral position **N** automatically.

Always shift the automatic transmission into park position **P** before turning off the engine. Otherwise the vehicle could roll away which could result in an accident and/or serious personal injury.

## Selector lever

### Overview of transmission positions

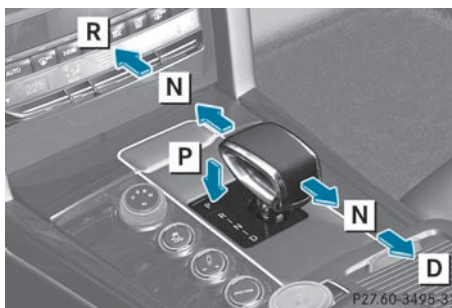

Selector lever in AMG vehicles with P button

P Park position with parking lock

R Reverse gear

N Neutral

D Drive

## Transmission position and drive program display

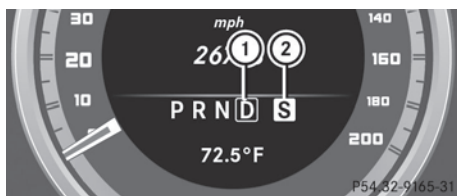

- ① Transmission position display
- ② Drive program display

The indicators light up when the SmartKey is inserted into the ignition lock. The indicators go out when the SmartKey is removed from the ignition lock.

**AMG vehicles:** the current position of the selector lever is shown by the indicators next to the selector lever.

- ! If the transmission position display in the multifunction display is not working, you should pull away carefully to check whether the desired transmission position is engaged. Ideally, you should select transmission position **D** and drive program **E**. Do not restrict the shift range.

## DIRECT SELECT lever

### Overview of transmission positions

The DIRECT SELECT lever is on the right of the steering column.

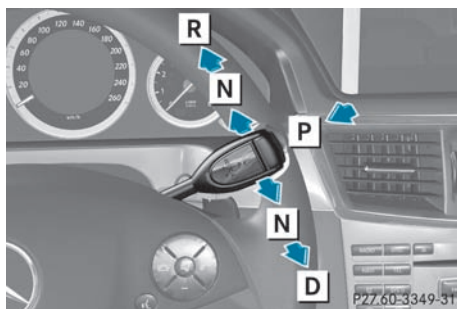

- P Park position with parking lock
- R Reverse gear

- N Neutral
- D Drive

- i The DIRECT SELECT lever always returns to its original position. The current transmission position **P**, **R**, **N** or **D** appears in the transmission position display (> page 153) in the multifunction display.

## Transmission position and drive program display

The current transmission position and drive program appear in the multifunction display.

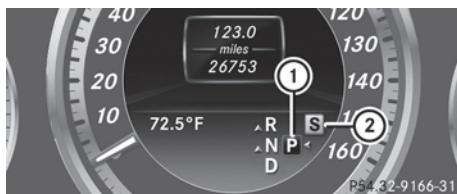

- ① Transmission position display
- ② Drive program display

- i The arrows in the transmission position display show how and into which transmission positions you can change using the DIRECT SELECT lever.

- ! If the transmission position display in the multifunction display is not working, you should pull away carefully to check whether the desired transmission position is engaged. Ideally, you should select transmission position **D** and drive program **E** or **S**. Do not restrict the shift range.

## Engaging park position P

- Push the DIRECT SELECT lever in the direction of arrow **P**.

- i The automatic transmission shifts automatically into park position **P** if you open the driver's door when the vehicle is stationary or driving at very low speed, and the transmission is in position **D** or **R**. This function depends on the date of manufacture of your vehicle.

**!** If the engine speed is too high or the vehicle is moving, do not shift the automatic transmission directly from **D** to **R**, from **R** to **D** or directly to **P**. The automatic transmission could otherwise be damaged.

**HOLD function or DISTRONIC PLUS:** the automatic transmission automatically switches to transmission position **P** if the vehicle is braked by the HOLD function or DISTRONIC PLUS. In addition, at least one of the following conditions must be fulfilled:

- the engine is switched off.
- the driver's door is open and the seat belt is not in the buckle.

### Engaging parking position P in AMG vehicles



- ▶ If the vehicle is stationary, press **P** button ①.

### Engaging reverse gear R

**!** Only shift the automatic transmission to **R** when the vehicle is stationary.

- ▶ When the vehicle is stationary, depress the brake pedal.
- ▶ Push the DIRECT SELECT lever up past the first point of resistance.

### Shifting to neutral N

- ▶ When the vehicle is stationary, depress the brake pedal.
- ▶ Push the DIRECT SELECT lever up or down to the first point of resistance.

If the engine has been switched off, the automatic transmission automatically switches to **N**.

### Remaining in neutral N

If the automatic transmission is to remain in neutral **N**, e.g. for washing the vehicle in car washes with a towing device, please observe the following instructions:

#### **WARNING**

When leaving the SmartKey in the starter switch, do not leave children unattended in the vehicle. It is possible for children to switch on the ignition which could result in unsupervised use of vehicle equipment. Unsupervised use of vehicle equipment could result in an accident and/or serious personal injury.

### Using the SmartKey:

- make sure that the ignition is switched on.
- when the vehicle is stationary, depress the brake pedal and keep it depressed.
- shift to neutral **N**.
- release the brake pedal.
- if applied, release the parking brake.
- switch off the ignition and leave the SmartKey in the ignition lock.

### Using KEYLESS-GO:

- make sure that the ignition is switched on.
- when the vehicle is stationary, depress the brake pedal and keep it depressed.
- engage park position **P**.
- release the brake pedal.
- remove the Start/Stop button from the ignition lock.
- insert the SmartKey into the ignition lock.
- switch on the ignition.

- depress the brake pedal and keep it depressed.
- shift to neutral **N**.
- release the brake pedal.
- if applied, release the parking brake.
- switch off the ignition and leave the SmartKey in the ignition lock.

### Shifting to transmission position **D**

- ▶ When the vehicle is stationary, depress the brake pedal.
- ▶ Push the DIRECT SELECT lever down past the first point of resistance.

### Transmission positions

**P**

#### Park position

Do not shift the transmission into position **P** (▷ page 167) unless the vehicle is stationary. The parking lock should not be used as a brake when parking. In addition to engaging the parking lock, you must always apply the parking brake to secure the vehicle.

The SmartKey can only be removed if the transmission is in position **P**. If the SmartKey is removed from the ignition lock, the selector lever is locked.

If the vehicle electronics are malfunctioning, the transmission may be locked in position **P**.

Have the vehicle electronics checked at a qualified specialist workshop, e.g. an authorized Mercedes-Benz Center, immediately.

**R**

#### Reverse gear

Only shift the transmission to **R** when the vehicle is stationary.

**N**

#### Neutral

Do not shift the transmission to **N** while driving. The transmission could otherwise be damaged.

No power is transmitted from the engine to the drive wheels.

Releasing the brakes will allow you to move the vehicle freely, e.g. to push it or tow it.

If ESP<sup>®</sup> is deactivated or faulty: only shift the transmission to position **N** if the vehicle is in danger of skidding, e.g. on icy roads.

**!** Rolling in neutral **N** can damage the drive train.

**D**

#### Drive

The automatic transmission changes gear automatically. All forward gears are available.

### Changing gear

The automatic transmission shifts to the individual gears automatically when it is in transmission position **D**. This automatic gearshifting behavior is determined by:

- a shift range restriction, if selected
- the selected drive program
  - E/S** or **M** (AMG vehicles) (▷ page 156)
- the position of the accelerator pedal
- the road speed

### Driving tips

#### AMG vehicles

When shifting down, the double-clutch function is active regardless of the currently selected drive program. The double-clutch function reduces load change reactions and is conducive to a sporty driving style. The sound generated by the double-clutch

function depends on the drive program selected.

### Kickdown

Use kickdown for maximum acceleration.

► **Vehicles for USA except AMG vehicles:** fully depress the accelerator pedal. The transmission shifts to a lower gear depending on the engine speed.

► **Vehicles for Canada except AMG vehicles:** depress the accelerator pedal beyond the pressure point. The transmission shifts to a lower gear depending on the engine speed.

### Rocking the vehicle free

Rocking the vehicle free by shifting back and forth between transmission positions **D** and **R** can help to free a vehicle that has become stuck in mud or snow. The engine management system of the vehicle limits shifting back and forth between transmission positions **D** and **R** to a maximum speed of 5 mph (9 km/h). To shift back and forth between transmission positions **D** and **R**, move the selector lever up and down beyond the pressure point.

### Working on the vehicle

**⚠ WARNING**  
When working on the vehicle, engage the parking brake and shift the automatic transmission into park position **P**. Otherwise the vehicle could roll away which could result in an accident and/or serious personal injury.

### Program selector button

#### General information

The program selector button allows you to choose between different driving characteristics.

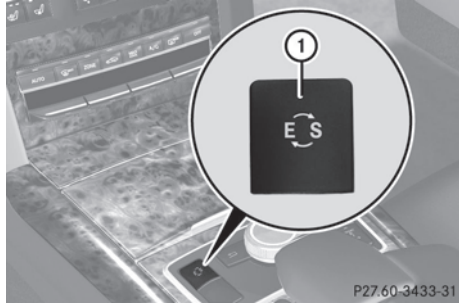

Program selector button on all models except AMG vehicles

<b>E</b> Economy	Comfortable, economical driving
<b>S</b> Sport	Sporty driving style

- i** For further information on the automatic drive program, see (▷ page 157).
- Press program selector button **1** repeatedly until the letter for the desired gearshift program appears in the multifunction display.
- i** The automatic transmission shifts to automatic drive program **E** each time the engine is started.

### AMG vehicles

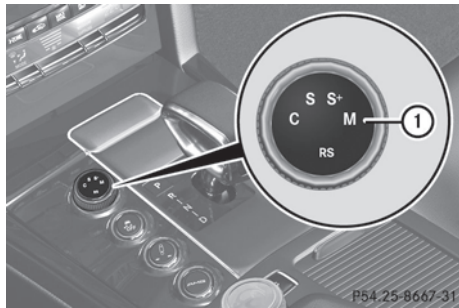

Drive program selector with manual drive program

<b>C</b> Controlled Efficiency	Comfortable, economical driving
<b>S</b> Sport	Sporty driving style



<b>S+</b> SportPlus	Extremely sporty driving style
<b>M</b> Manual	Manual gearshifting
<b>RS RACE START</b>	Optimal vehicle acceleration from a standstill

**i** For further information on the automatic drive program, see (▷ page 157).

Only change from automatic drive program **C**, **S** or **S+** to manual drive program **M** when the vehicle is stationary.

▶ Turn drive program selector ① until the desired drive program appears in the multifunction display in the speedometer. The drive program indicator on drive program selector ① lights up in red.

**i** The automatic transmission shifts to automatic drive program **C** each time the engine is started.

**i** **RS** cannot be selected during normal driving. For further information on RACE START, see (▷ page 188).

### Steering wheel paddle shifters

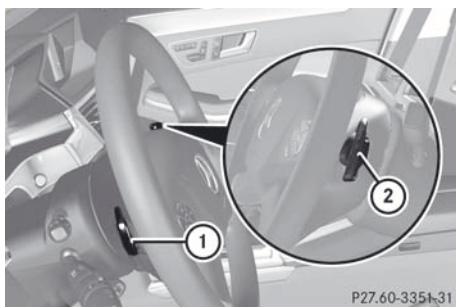

- ① Left-hand steering wheel paddle shifter
- ② Right-hand steering wheel paddle shifter

You can restrict or derestrict the shift range by using the steering wheel paddle shifters. You can change gear yourself by using the

steering wheel paddle shifters in the manual drive program.

In the automatic drive program, you can restrict or derestrict the shift range by using the steering wheel paddle shifters (▷ page 157).

**i** You can only change gear with the steering wheel paddle shifters when the transmission is in position **D**.

### Automatic drive program

Drive program **E** (drive program **C** on AMG vehicles) is characterized by the following:

- the vehicle pulling away more gently in forward and reverse gears, unless the accelerator pedal is depressed fully
- increased sensitivity. This improves driving stability on slippery road surfaces, for example
- the automatic transmission shifting up sooner. This results in the vehicle being driven at lower engine speeds and the wheels being less likely to spin

Drive program **S** (drive programs **S** and **S+** on AMG vehicles) is characterized by the following:

- sporty engine and automatic transmission settings
- the vehicle pulling away in first gear
- the automatic transmission shifting up later
- the fuel consumption possibly being higher as a result of the later automatic transmission shift points

### Shift ranges

#### Introduction

When the automatic transmission is in position **D**, it is possible to restrict or derestrict the shift range (▷ page 157).

The shift range selected is shown in the multifunction display. The automatic

transmission shifts only as far as the selected gear.

### Shift range

<b>3</b>	You can use the engine's braking effect.
<b>2</b>	To use the braking effect of the engine on downhill gradients and for driving: <ul style="list-style-type: none"> <li>• on steep mountain roads</li> <li>• in mountainous terrain</li> <li>• in arduous conditions</li> </ul>
<b>1</b>	To use the braking effect of the engine on extremely steep downhill gradients and on long downhill stretches

### Restricting the shift range

- ▶ Pull the left-hand steering wheel paddle shifter.  
The automatic transmission shifts down one gear and restricts the shift range to the relevant gear.
- i** If the engine exceeds the maximum engine speed when shifting down, the automatic transmission protects against engine damage by not shifting down.
- i** If the maximum engine speed for the shift range is reached and you continue to accelerate, the automatic transmission shifts up in order to prevent the engine from overrevving, even if the shift range is restricted.

### Derestricting the shift range

- ▶ Pull the right-hand steering wheel paddle shifter.  
The shift range is derestricted.

### Clearing the shift range restriction

- ▶ Pull and hold the right-hand steering wheel paddle shifter until **D** is shown again in the multifunction display.  
The automatic transmission shifts from the current shift range directly to **D**.

### Selecting the ideal shift range

- ▶ Pull the left-hand steering wheel paddle shifter and hold it in position.  
The automatic transmission shifts to the gear which allows optimum acceleration and deceleration. To do this, the automatic transmission shifts down one or more gears.

### Manual drive program

#### Switching on the manual drive program

The manual drive program is only available for AMG vehicles.

Manual drive program **M** is different from drive programs **S** and **S+** with regard to spontaneity, responsiveness and smoothness of gear changes.

Manual drive program **M** can be selected using the drive program selector. In manual drive program **M**, you can change gear yourself using the steering wheel paddle shifters if the transmission is in position **D**. The gear currently selected and engaged is shown in the multifunction display.

- ▶ Turn the drive program selector (▷ page 156) until **M** appears in the multifunction display.  
The indicator **M** on the drive program selector lights up in red.

### Upshifting

- !** In manual drive program **M**, the automatic transmission does not shift up automatically even when the engine limiting speed for the current gear is

reached. When the engine limiting speed is reached, the fuel supply is cut to prevent the engine from overrevving. Always make sure that the engine speed does not reach the red area of the tachometer. There is otherwise a risk of engine damage.

- Pull the right-hand steering wheel paddle shifter (▷ page 157).

The automatic transmission shifts up to the next gear.

Before the engine speed reaches the red area, an upshift indicator appears in the multifunction display.

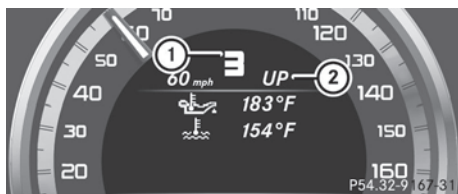

- ① Gear indicator
- ② Upshift indicator

### Downshifting

- Pull the left-hand steering wheel paddle shifter (▷ page 157).

The automatic transmission shifts down to the next gear.

- ⓘ If you brake the vehicle or stop without shifting down, the automatic transmission will shift down to a gear that will allow the vehicle to accelerate or pull away again.

### Kickdown

- ⓘ Kickdown is not possible in manual drive program **M**.

### Switching off the manual drive program

- Turn the drive program selector (▷ page 156) until **C**, **S** or **S+** appears in the multifunction display.

## Problems with the transmission

Problem	Possible causes/consequences and ► Solutions
The transmission has problems shifting gear.	The transmission is losing oil. ► Have the transmission checked at a qualified specialist workshop, e.g. an authorized Mercedes-Benz Center, immediately.
The acceleration ability is deteriorating. The transmission no longer changes gear.	The transmission is in emergency mode. It is only possible to shift into <b>second</b> gear and reverse gear. ► Stop the vehicle. ► Shift the transmission to position <b>P</b> . ► Switch off the engine. ► Wait at least 10 seconds before restarting the engine. ► Shift the transmission to position <b>D</b> or <b>R</b> . If <b>D</b> is selected, the transmission shifts into <b>second</b> gear; if <b>R</b> is selected, the transmission shifts into reverse gear. ► Have the transmission checked at a qualified specialist workshop, e.g. an authorized Mercedes-Benz Center, immediately.

## Transfer case

This section is only valid for vehicles with 4-wheel drive (4MATIC). Power is always transmitted to both axles.

! Performance tests may only be carried out on a 2-axle dynamometer. The brake system or transfer case could otherwise be damaged. Contact a qualified specialist workshop for a performance test. Mercedes-Benz recommends that you use an authorized Mercedes-Benz Center for this purpose.

! To prevent ESP® from intervening, the ignition must be switched off (SmartKey or the Start/Stop button in position **0** or **1**) if:

- the parking brake is being tested on a brake dynamometer.
- the vehicle is being towed with only one axle raised (not permitted for vehicles with 4MATIC).

The brake system could otherwise be damaged.

## Refueling

## Important safety notes

 **WARNING**

Gasoline and diesel fuels are highly flammable and poisonous. They burn violently and can cause serious injury.

Never allow sparks, flames or smoking materials near gasoline or diesel fuel!

Turn off the engine before refueling.

Whenever you are around gasoline or diesel fuel, avoid inhaling fumes and any skin or clothing contact. Extinguish all smoking materials.

Direct skin contact with fuels and the inhalation of fuel vapors are damaging your health.

**⚠ WARNING**

Overfilling of the fuel tank may create pressure in the system which could cause a gas discharge. This could cause the gasoline to spray back out when removing the fuel pump nozzle, which could cause personal injury.

**⚠ WARNING**

Do not fill diesel tanks with gasoline. Do not mix diesel fuel with gasoline. Otherwise the fuel system and engine could be damaged. In addition, the vehicle could catch fire.

- !** Do not use gasoline to refuel vehicles with a diesel engine. Do not use diesel to refuel vehicles with a gasoline engine. Even a small quantity of the wrong fuel will damage the fuel system and engine.
- !** Do not switch on the ignition if you accidentally refuel with the wrong fuel. Otherwise, the fuel will enter the fuel lines. Notify a qualified specialist workshop and have the fuel tank and fuel lines drained completely.

**Gasoline****Fuel grade**

- !** You should only refuel with unleaded premium-grade gasoline as this avoids damaging the catalytic converter. If engine running problems are apparent, have the cause checked immediately and repaired. Excess unburned fuel can otherwise enter the catalytic converter, leading to overheating and possibly causing a fire.
- !** Use a filter when refueling from a fuel can. Otherwise, the fuel lines and/or injection system could be blocked by particles from the fuel can.
- i** Only refuel with premium-grade unleaded gasoline with a specified minimum octane

number of 91 (average value of 96 RON/86 MON).

You will usually find information about the fuel grade on the pump. If you cannot find the label on the pump, ask the staff for assistance.

You can find more information under "Fuel" (> page 385), or by contacting an authorized Mercedes-Benz Service Center or visiting <http://www.mbusa.com> (USA only).

**Diesel****Fuel grade**

- !** Only refuel with ULTRA-LOW SULFUR DIESEL FUEL (ULSD, 15 ppm SULFUR MAXIMUM). Using other diesel fuels could result in increased wear and damage to the engine and/or exhaust system. Never refuel with marine diesel or heating oil. Do not mix these fuels with diesel fuels and do not use any special additives, as this may result in damage.
- !** Use a filter when adding fuel from a fuel can. Otherwise, the fuel lines and/or the fuel injection system could be blocked by particles from the fuel can.
- i** Usually, you will find information about the fuel grade on the pump. If you cannot find the label on the gasoline pump, ask the gas station staff. You can find more information under "Fuel" (> page 385), or by contacting an authorized Mercedes-Benz Service Center or visiting <http://www.mbusa.com> (USA only).

**Low outside temperatures**

- !** Do not use gasoline to refuel vehicles with a diesel engine. Never mix diesel with gasoline or kerosene, as this may result in damage to the engine or fuel system.

Diesel fuel with improved cold flow properties is available during the winter months. Further information on fuel properties can be obtained from oil companies, e.g. at gas stations.

## Refueling

### Fuel filler flap

The fuel filler flap is unlocked or locked automatically when you open or close the vehicle with the SmartKey or using KEYLESS-GO.

The position of the fuel filler cap is displayed in the instrument cluster . The arrow next to the filling pump indicates the side of the vehicle.

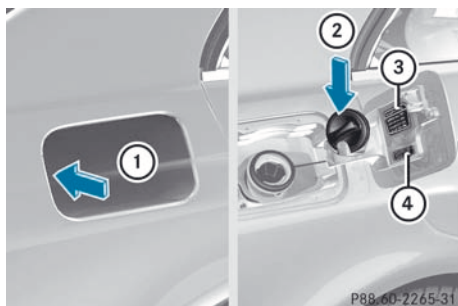

Example: Sedan

- ① To open the fuel filler flap
- ② To insert the fuel filler cap
- ③ Tire pressure table
- ④ Fuel type

### Opening

- ▶ Switch off the engine.
- ▶ Remove the SmartKey from the ignition lock.  
KEYLESS-GO: open the driver's door. This switches the ignition to position **0**, which corresponds to having removed the

SmartKey. The driver's door can be closed again.

- ▶ Press the fuel filler flap in the direction of arrow ①.  
The fuel filler flap opens slightly.
- ▶ Open the fuel filler flap.
- ▶ Turn the fuel filler cap counter-clockwise and remove it.
- ▶ **Sedan:** insert the fuel filler cap into the bracket on the inside of fuel filler flap ②.



or

- ▶ **Wagon:** insert the fuel filler cap into the recesses in the fuel filler flap hinge arm horizontally from above.
- ▶ Completely insert the pump nozzle into the filler neck and refuel.
- ▶ Only fill the tank until the pump nozzle switches off.

❗ Overfilling the fuel tank could damage the fuel system.

### Closing

- ▶ Replace the fuel filler cap and turn it clockwise. The fuel filler cap audibly engages.
- ▶ Press the fuel filler flap closed until it engages audibly.

**i** If you drive with the fuel filler cap open, reserve fuel warning lamp  flashes. In addition, the  Check Engine warning lamp may light up. A message appears in the multifunction display (▷ page 248).

For further information on warning and indicator lamps in the instrument cluster, see (▷ page 267).

**i** Close the fuel filler flap before locking the vehicle. A locking pin otherwise prevents the fuel filler flap from closing after the vehicle has been locked.

### Fuel filler flap emergency release

#### WARNING

Avoid contact with the vehicle walls as they may contain sharp edges. Otherwise, you could injure yourself while releasing the fuel filler flap.

The emergency release is located in the trunk/cargo compartment behind the side trim on the right-hand side, when viewed in the direction of travel.

- ▶ Open the trunk lid/tailgate.
- ▶ **Sedan:** slide down the parcel net.
- ▶ Open the side trim.
- ▶ Remove the first-aid kit (▷ page 322).

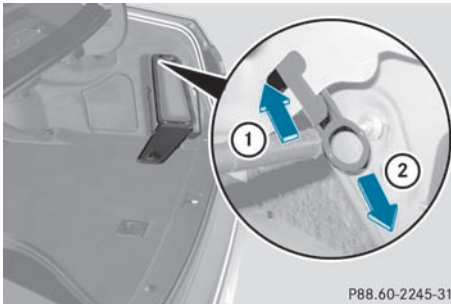

- ▶ Detach the emergency release from retainer ①.
- ▶ Pull the emergency release in the direction of arrow ②.  
The fuel filler flap is unlocked.
- ▶ Open the fuel filler flap.
- ▶ **Wagon:** remove the first-aid kit from the parcel net (▷ page 322).  
Depending on the vehicle's equipment, the first-aid kit is in the parcel net or behind the side trim panel.  
Open the side trim.
- ▶ Fold down the side trim.
- ▶

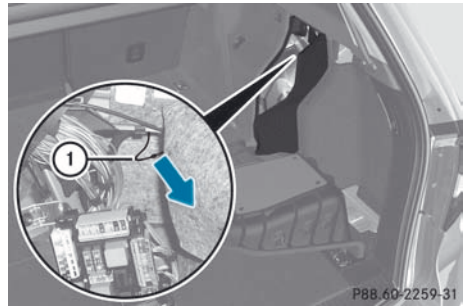

- ▶ Pull the emergency release in the direction of arrow ①.  
The fuel filler flap is unlocked.
- ▶ Open the fuel filler flap.



## Problems with fuel and the fuel tank

## Problem

## Possible causes/consequences and ► Solutions

Fuel is leaking from the vehicle.

 **Risk of explosion or fire**

The fuel line or the fuel tank is defective.

- Turn the SmartKey to position **0**(▷ page 145) in the ignition lock immediately and remove it.
- Do not restart the engine under any circumstances.
- Consult a qualified specialist workshop.

The fuel filler flap cannot be opened.

The fuel filler flap is not unlocked.

or

The SmartKey battery is discharged.

- Unlock the vehicle using the mechanical key (▷ page 77).
- Open the trunk lid or the tailgate.
- Manually unlock the fuel filler flap using the emergency release (▷ page 163).

Problem	Possible causes/consequences and ► Solutions
	<p>The fuel filler flap is unlocked, but the opening mechanism is jammed.</p> <ul style="list-style-type: none"> <li>► Consult a qualified specialist workshop.</li> </ul>
<p>The engine will not start.</p>	<p>The fuel tank of a vehicle with a diesel engine has been run completely dry.</p> <ul style="list-style-type: none"> <li>► Refuel the vehicle with at least 5.3 US qt (5 liters) of diesel.</li> <li>► Turn the ignition on for at least 10 seconds (► page 145).</li> <li>► Start the engine continuously for up to 10 seconds until it runs smoothly.</li> </ul> <p>or</p> <ul style="list-style-type: none"> <li>► Start the engine via the touch-start function. To do this, turn the SmartKey to position <b>3</b> (► page 145) in the ignition lock and then release it immediately.</li> </ul> <p>If the engine does not start:</p> <ul style="list-style-type: none"> <li>► Turn the ignition on again for approximately 10 seconds (► page 145).</li> <li>► Start the engine again continuously for up to 10 seconds until it runs smoothly.</li> </ul> <p>or</p> <ul style="list-style-type: none"> <li>► Start the engine again via the touch-start function.</li> </ul> <p>If the engine does not start after three attempts:</p> <ul style="list-style-type: none"> <li>► Consult a qualified specialist workshop.</li> </ul>

## DEF

### Important notes on use

To function properly, BlueTEC exhaust gas aftertreatment must be operated with the reducing agent DEF. Adding DEF is one of the tasks performed during maintenance. Under normal operating conditions, a tank of DEF lasts until the next service due date.

When the DEF supply has almost run out, the **Check Additive See Operator's Manual** message is shown in the multifunction display.

When the DEF supply sinks to a minimum level, the **Remaining Starts: 16** message is shown in the multifunction display.

When the **Remaining Starts: 16** message is shown in the multifunction display, you can start the engine 16 more times. If DEF is not added, it is then not possible to start the engine again. Fill the DEF tank with about 1 gal (3.8 l) DEF or have the DEF tank refilled at a qualified specialist workshop.

Use the special DEF refill bottle when filling between maintenance intervals. Contact an authorized Mercedes-Benz Center with any questions or, if necessary, contact Roadside Assistance (► page 23).

Further information about BlueTEC exhaust gas aftertreatment and DEF is available at any authorized Mercedes-Benz Center.

## Adding DEF

### WARNING

Make sure

- DEF does not come into contact with skin, eyes, or clothing
- to keep DEF out of the reach of children

If you and/or others have come into contact with DEF:

- If DEF has gotten into contact with eyes, flush with plenty of water immediately and seek medical help.
- Clean affected skin immediately with plenty of water.
- If DEF was swallowed, rinse mouth immediately with plenty of water and drink plenty of water. Consult a physician.

### WARNING

If you open the DEF tank cap at high temperatures, ammonia vapors can be released.

Ammonia vapors have a pungent odor and are particularly irritating to:

- skin
- mucous membranes
- eyes

You may experience a burning sensation in your eyes, nose and throat, as well as coughing and watering of the eyes.

Do not inhale any ammonia vapors that may be released. Only refill the DEF tank in well ventilated areas.

- ❗ Only use DEF that complies with ISO 22241. Do not add any special additives to DEF and do not thin DEF with water. This could destroy the BlueTEC exhaust gas aftertreatment.

If the outside temperature is lower than -11 °C, damage may occur when topping up. If DEF is frozen and there is an active warning indicator, topping up may not be possible. Park the vehicle in a warmer place, e.g. in a garage, until DEF has become fluid again.

Filling is then possible again. Alternatively, have the DEF tank refilled at a qualified specialist workshop.

- ❗ Rinse surfaces that have come into contact with DEF immediately with water or remove DEF using a damp cloth and cold water. If the DEF has already crystallized, use a sponge and cold water to clean it. DEF residues crystallize after time and contaminate the affected surfaces.

- ❗ DEF is not a fuel additive and must not be added to the fuel tank. If DEF is added to the fuel tank, this can lead to engine damage.

- i If you are adding between maintenance intervals, add approximately 1 gallon (3.8 l) of DEF to the DEF tank. One gallon (3.8 l) of DEF is approximately 2 DEF refill bottles. Then, have the DEF supply checked and filled completely if necessary. For this purpose, Mercedes-Benz recommends a qualified specialist workshop.

Further information on DEF (▷ page 387). The DEF filler neck is under the trunk floor.

- ▶ Switch off the ignition.
- ▶ Open the trunk.
- ▶ Lift up the trunk floor (▷ page 286).

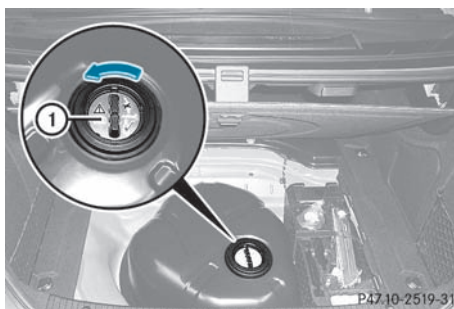

- ▶ Turn DEF cap ① counter-clockwise and remove it.

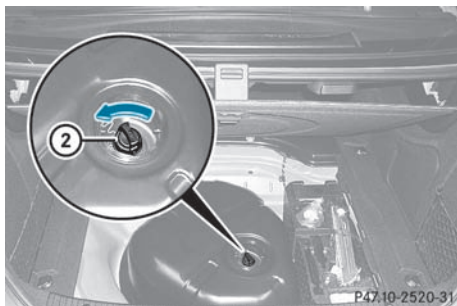

- ▶ Turn DEF filler cap ② counter-clockwise and open it. Filler cap ② is secured with a plastic strap.

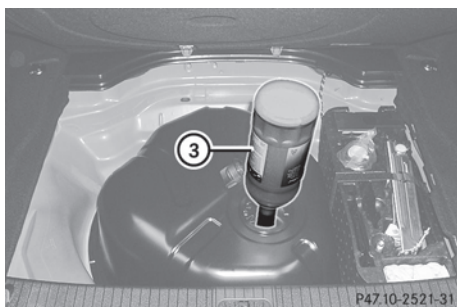

- ▶ Unscrew the covering cap from DEF refill bottle ③.
- ▶ Place DEF refill bottle ③ on the filler neck as shown and screw on clockwise hand-tight.
- ▶ Press DEF refill bottle ③ down. The DEF tank is filled. This may take up to one minute.
- ▶ If the DEF refill bottle is no longer pressed down, the filling process stops and the partially emptied bottle can be removed.
- ▶ Release DEF refill bottle ③.
- ▶ Turn DEF refill bottle ③ counter-clockwise and remove it.
- ▶ Place DEF filler cap ② on the filler neck and turn it clockwise.

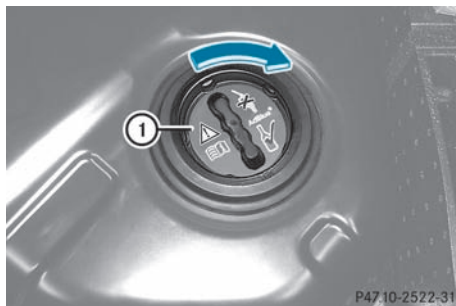

- ▶ Insert DEF cap ① as shown and turn it clockwise as far as it will go.
- ▶ Fold the trunk floor down.
- ▶ Close the trunk lid.
- ▶ Drive at a speed above 10 mph (16 km/h). The **Check Additive See Operator's Manual** message goes out after approximately one minute.

- ▶ If the **Check Additive See Operator's Manual** message remains shown in the multifunction display, add an additional bottle of DEF.
- ▶ Then, have the DEF supply checked at a qualified specialist workshop and completely refilled if necessary.

## Parking

### Important safety notes

#### ⚠ WARNING

Do not park this vehicle in areas where combustible materials can come into contact with the hot exhaust system. Do not park the vehicle on dry grassland or harvested grain fields. Combustible materials, such as grass, hay or leaves could be ignited by the hot exhaust system and cause a vehicle fire.

Unintended vehicle movement can cause serious personal injury or damage to the vehicle or the vehicle drivetrain. To reduce such risks, always do the following before turning off the engine and leaving the vehicle:

- keep your right foot on the brake pedal.
- engage the parking brake.
- shift the automatic transmission to park position **P**.
- slowly release the brake pedal.
- when parked on an incline, always turn the front wheels towards the road curb.
- turn the SmartKey in the ignition lock to position **0** and remove the SmartKey from the ignition lock, or press the KEYLESS-GO Start/Stop button.
- take the SmartKey with you and lock the vehicle when leaving.

## Switching off the engine

### Important safety notes

#### WARNING

Do not turn off the engine before the vehicle has come to a complete stop. With the engine not running, there is no power assistance for the brake and steering systems. In this case, it is important to keep in mind that a considerably higher degree of effort is necessary to brake and steer the vehicle.

#### WARNING

Keep in mind that turning off the engine alone only will shift the automatic transmission into neutral position **N** automatically.

Always shift the automatic transmission into park position **P** before turning off the engine. Otherwise the vehicle could roll away which could result in an accident and/or serious personal injury.

## Vehicles with manual transmission

- ▶ Shift to either first gear or reverse gear **R**.
- ▶ Turn the SmartKey to position **0** in the ignition lock and remove it.  
The immobilizer is activated.
- ▶ Apply the parking brake firmly.

## Vehicles with automatic transmission

- ▶ Shift the transmission to position **P**.

### Using the SmartKey

- ▶ Turn the SmartKey to position **0** in the ignition lock and remove it.  
The immobilizer is activated.
- ▶ Apply the parking brake firmly.

-  If you turn off the engine with the SmartKey and then remove it from the ignition lock or open a front door, the automatic transmission shifts to **P** automatically.

### Using KEYLESS-GO

- ▶ Press the Start/Stop button (▷ page 145).  
The engine stops and all the indicator lamps in the instrument cluster go out.
- ▶ Apply the parking brake firmly.

-  If you use the Start/Stop button to switch off the engine, the automatic transmission shifts to **N** automatically. If you then open the driver's or front-passenger door, the automatic transmission shifts to **P**.

-  In an emergency, the engine can be turned off while the vehicle is in motion by pressing and holding the Start/Stop button for three seconds.

If you have started the engine with the Start/Stop button and it cannot be switched off as described:

- ▶ remove the Start/Stop button from the ignition lock.
- ▶ insert the SmartKey into the ignition lock.  
The engine switches off. The ignition is in position **0**.

## Parking brake



### WARNING

Engaging the parking brake while the vehicle is in motion can cause the rear wheels to lock up. You could lose control of the vehicle and cause an accident. In addition, the vehicle's brake lights do not light up when the parking brake is engaged.

### WARNING

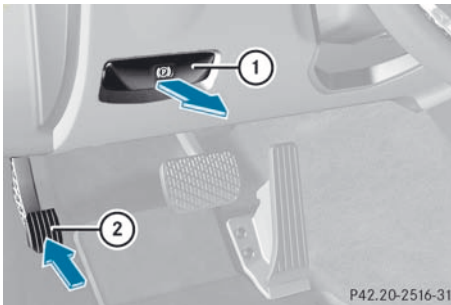
When leaving the vehicle, always remove the SmartKey from the starter switch, take it with you, and lock the vehicle. Do not leave children unattended in the vehicle, or with access to an unlocked vehicle. Children could release the parking brake and/or shift the automatic transmission out of park position **P**, either of which could result in an accident and/or serious personal injury.



- ▶ **To apply:** depress parking brake ② firmly. When the engine is running, the **BRAKE** (USA only) or  (Canada only) indicator lamp lights up in the instrument cluster.
- ▶ **To release:** depress the brake pedal and keep it depressed.
- ▶ Pull release handle ①.  
When the ignition is switched on or the engine is running, the **BRAKE** (USA only) or  (Canada only) indicator lamp goes out in the instrument cluster.

## Parking the vehicle for a long period

If you leave the vehicle parked for longer than four weeks, the battery may be damaged by exhaustive discharge.

- ▶ Connect a trickle charger.
- ▶  You can obtain information about trickle chargers from a qualified specialist workshop, e.g. an authorized Mercedes-Benz Center.

If you leave the vehicle parked for longer than six weeks, the vehicle may suffer damage as a result of lack of use.

- ▶ Visit a qualified specialist workshop and seek advice.

## Driving tips

### General driving tips

## Important safety notes

### WARNING

Always remember that you must concentrate primarily on driving the vehicle. The driver's concentration must always be directed primarily at road traffic. For your own safety and that of others, we recommend that you stop the vehicle at a safe place and in accordance with the traffic conditions before making or accepting a phone call.

Comply with all legal requirements if you use the telephone while driving. Use the hands-free system and only use the telephone when road, weather and traffic conditions permit. In some jurisdictions, it is forbidden for drivers to use mobile phones while driving.

Only operate the audio system or COMAND (Cockpit Management and Data System) in compliance with all legal requirements and when the road, weather and traffic conditions permit. You may otherwise not be able to observe the traffic conditions, endangering yourself and others.

Remember that your vehicle covers a distance of 44 feet (approximately 14 m) a second

when it is traveling at only 30 mph (approximately 50 km/h).

### Drive sensibly – save fuel

Observe the following tips to save fuel:

- ▶ The tires should always be inflated to the recommended tire pressure.
- ▶ Remove unnecessary loads.
- ▶ Remove roof racks when they are not needed.
- ▶ Warm up the engine at low engine speeds.
- ▶ Avoid frequent acceleration or braking.
- ▶ Have all maintenance work carried out as indicated by the service intervals in the Service Booklet or by the service interval display.

Fuel consumption also increases when driving in cold weather, in stop-and-go traffic and in mountainous terrain.

### Drinking and driving

#### WARNING

Drinking and driving and/or taking drugs and driving are very dangerous combinations. Even a small amount of alcohol or drugs can affect your reflexes, perceptions and judgment.

The possibility of a serious or even fatal accident are greatly increased when you drink or take drugs and drive.

Do not drink or take drugs and drive or allow anyone to drive who has been drinking or taking drugs.

### Pedals

#### WARNING

Make sure absolutely no objects are obstructing the pedals' range of movement. Keep the driver's footwell clear of all obstacles. If there are any floor mats or carpets in the footwell, make sure that the pedals still have sufficient clearance.

During sudden driving or braking maneuvers, the objects could get caught between the pedals. You could then no longer brake or accelerate. This could lead to accidents and injury.

### Rolling with the engine switched off

#### WARNING

There is no power assistance for the steering and the brake when the engine is not running. Steering and braking requires significantly more effort and you could lose control of the vehicle and cause an accident as a result. Do not turn off the engine while the vehicle is in motion.

### Exhaust check

#### WARNING

Inhalation of exhaust gas is hazardous to your health. All exhaust gas contains carbon monoxide (CO), and inhaling it can cause unconsciousness and possible death.

Do not run the engine in confined areas (such as a garage) which are not properly ventilated. If you think that exhaust gas fumes are entering the vehicle while driving, have the cause determined and corrected immediately. If you must drive under these conditions, drive only with at least one window fully open at all times.

Certain engine systems are designed to keep the level of poisonous components in exhaust fumes within legal limits.

These systems only work at peak efficiency when they are maintained exactly in accordance with the manufacturer's specifications. For this reason, all work on the engine must be carried out only by qualified and authorized Mercedes-Benz technicians. The engine settings must not be changed in any circumstances. Furthermore, all specific service work must be carried out at regular intervals and in accordance with the



Mercedes-Benz service requirements. Details can be found in the Service Booklet.

## Engine oil

### ! Vehicles with a diesel particle filter:

If the vehicle is mostly driven for short distances, it is possible that malfunctions may occur during the automatic cleaning of the diesel particle filter. This can lead to engine damage. Therefore, if you frequently drive short distances, make sure to drive on highways or inter-urban roads for 20 minutes at least every 310 miles (500 km).

## Brakes

### Important safety notes

#### WARNING

On slippery road surfaces, never downshift in order to obtain braking action. This could result in drive wheel slip and reduced vehicle control. Your vehicle's ABS will not prevent this type of loss of control.

#### WARNING

Make sure that you do not endanger other road users when you apply the brakes.

### Downhill gradients

! On long and steep gradients, you must reduce the load on the brakes by shifting early to a lower gear. This allows you to take advantage of the engine braking effect and helps avoid overheating and excessive wear of the brakes.

When you take advantage of the engine braking effect, a drive wheel may not turn for some time, e.g. on a slippery road surface. This could cause damage to the drive train. This type of damage is not covered by the Mercedes-Benz warranty.

### Heavy and light loads

#### WARNING

Depressing the brake pedal constantly results in excessive and premature wear to the brake pads.

It may also cause the brakes to overheat, seriously impairing their effectiveness. It may then not be possible to stop the vehicle in sufficient time to avoid an accident.

If the brakes have been subjected to a heavy load, do not stop the vehicle immediately, but drive on for a short while. This allows the airflow to cool the brakes more quickly.

### Wet roads

#### WARNING

After driving in heavy rain for some time without applying the brakes or through water deep enough to wet brake components, the first braking action may be somewhat reduced. You have to depress the brake pedal more firmly. Maintain a safe distance from vehicles in front.

After driving on a wet road or having the vehicle washed, brake firmly while paying attention to the traffic conditions. This will warm up the brake discs, thereby drying them more quickly and protecting them against corrosion.

### Limited braking performance on salt treated roads

#### WARNING

The layer of salt on the brake discs and the brake pads/linings may cause a delay in the braking effect, resulting in a significantly longer braking distance, which could lead to an accident.

To avoid this danger, you should:

- occasionally brake carefully, without putting other road users at risk, when you are driving on salted roads. This helps to

remove any salt that may have started to build up on the brake discs and the brake pads/linings.

- maintain a greater distance to the vehicle ahead and drive with particular care.
- carefully apply the brakes at the end of a trip and immediately after commencing a new trip, so that salt residues are removed from the brake discs.

### Servicing the brakes

**!** If the red brake warning lamp lights up in the instrument cluster and you hear a warning tone while the engine is running, the brake fluid level may be too low. Observe additional warning messages in the multifunction display.

The brake fluid level may be too low due to brake pad wear or leaking brake lines.

Have the brake system checked immediately. This work should be carried out at an authorized Mercedes-Benz Center.

All checks and maintenance work on the brake system must be carried out at a qualified specialist workshop. This work should be carried out at an authorized Mercedes-Benz Center.

Have the brake pads replaced and the brake fluid renewed at a qualified specialist workshop, e.g. an authorized Mercedes-Benz Center.

#### WARNING

If brake pads or brake fluid other than those recommended are used, the braking properties of the vehicle can be degraded to an extent that safe braking is substantially impaired. This could result in an accident.

**!** **Vehicles with 4MATIC:** function or performance tests may only be carried out on a 2-axle dynamometer. If you are planning to have the vehicle tested on such a dynamometer, contact an authorized Mercedes-Benz Center to obtain further

information first. Otherwise, you could damage the drive train or the brake system.

**!** **Vehicles with 4MATIC:** as the ESP<sup>®</sup> system operates automatically, the engine and the ignition must be switched off (SmartKey in position **0** or **1** in the ignition lock or Start/Stop button in position **0** or **1**) while the parking brake is being tested on a brake dynamometer.

Braking maneuvers triggered automatically by ESP<sup>®</sup> may seriously damage the brake system.

**!** **Vehicles with 4MATIC:** as the ESP<sup>®</sup> system operates automatically, the engine and the ignition system must be switched off (SmartKey in position **0** or **1** in the ignition lock or Start/Stop button in position **0** or **1**) when:

- testing the parking brake on a brake dynamometer.
- you intend to have the vehicle towed with one of the axles raised.

Braking maneuvers triggered automatically by ESP<sup>®</sup> may seriously damage the brake system.

If your brake system is subject only to moderate loads, you should test the functionality of your brakes at regular intervals by pressing firmly on the brake pedal at high speeds. This improves the grip of the brake pads.

#### WARNING

Make sure that you do not endanger other road users when you apply the brakes.

You can find a description of Brake Assist (BAS) on (> page 64) or of BAS PLUS on (> page 64).

## AMG high-performance and ceramic brakes

### WARNING

New vehicle brake pads and discs, and replacement brake pads and discs may take several hundred miles of driving until they provide optimum braking efficiency. Until that time, you may need to use increased brake pedal pressure while braking. Please be aware of this and adjust your driving and braking accordingly during this break-in period.

Excessive high-demand braking will cause correspondingly high brake wear. Please be attentive to the brake warning lamp in the instrument cluster and brake condition messages in the multifunction display. Especially for high performance driving, it is important to maintain and have the brake system checked regularly.

The AMG brake systems are designed for heavy loads. This may lead to noise when braking. This will depend on:

- speed
- braking force
- environmental conditions, such as temperature and humidity

The wear of individual components of the brake system, such as the brake pads/linings or brake discs, depends on the individual driving style and operating conditions.

For this reason, it is impossible to state a mileage that will be valid under all circumstances. An aggressive driving style will lead to high wear. You can obtain further information about this from your authorized Mercedes-Benz Center.

## Driving on wet roads

### Hydroplaning

If water has accumulated to a certain depth on the road surface, there is a danger of hydroplaning occurring, even if:

- you drive at low speeds.
- the tires have adequate tread depth.

For this reason, in the event of heavy rain or in conditions in which hydroplaning can occur you must drive in the following manner:

- reduce your speed
- avoid ruts
- brake carefully

### Driving on flooded roads

 Do not drive through flooded areas. Check the depth of any water before driving through it. Drive slowly through standing water. Otherwise, water may enter the vehicle interior or the engine compartment. This can damage the electronic components in the engine or the automatic transmission. Water can also be drawn in by the engine's air suction nozzles and this can cause engine damage.

## Winter driving

### Important safety notes

#### WARNING

If the vehicle becomes trapped in snow, ensure that snow is kept away from the exhaust pipe and from around the vehicle as long as the engine is running. Otherwise, poisonous carbon monoxide (CO) may enter the vehicle, resulting in loss of consciousness and even death.

To assure sufficient fresh air ventilation, open a window slightly on the side of the vehicle not facing the wind.

At the onset of winter, have your vehicle winterproofed at a qualified specialist

workshop, e.g. at an authorized Mercedes-Benz Center.

- i** Vehicles with a diesel engine: do not cover the radiator, e.g. with a protective cover. The measuring function of the Onboard Diagnosis System may otherwise provide inaccurate values. Some of these values are required by law and must therefore always be accurate.

### Winter tires

At temperatures below 45 °F(+7 °C), use winter tires or all-season tires. Both types of tire are identified by the M+S marking.

Only winter tires bearing the  snowflake symbol in addition to the M+S marking provide the best possible grip in wintry road conditions. Only these tires will allow driving safety systems such as ABS and ESP® to function optimally in winter, as these tires have been designed specifically for driving on snow.

Use M+S tires of the same make and tread on all wheels to maintain safe handling characteristics.

#### WARNING

M+S tires with a tread depth of less than  $\frac{1}{6}$  inch (4 mm) must be replaced immediately. They are no longer suitable for use in winter.

Always observe the maximum permissible speed specified for the M+S tires you have mounted.

Once you have mounted the winter tires:

- ▶ Check the tire pressures (▷ page 353).
- ▶ Restart the tire pressure monitor (▷ page 355).

#### WARNING

If you use your spare wheel when M+S tires are mounted on the other wheels, be aware that the difference in tire characteristics impairs cornering ability and reduces driving stability. Adapt your driving style accordingly.

Have the spare wheel replaced by a normal wheel with an M+S tire at the nearest Mercedes-Benz Center.

### Snow chains

For safety reasons, Mercedes-Benz recommends that you only use snow chains which have been specially approved for your vehicle by Mercedes-Benz, or are of a corresponding standard of quality.

- !** On vehicles with AIRMATIC, you must drive at raised vehicle level if snow chains have been mounted. The vehicle may otherwise be damaged.

- !** There is not enough space for snow chains on some wheel sizes. Observe the information under "Tires and wheels" in the "Technical Data" section to avoid damage to the vehicle or the wheels.

- Only use snow chains when driving on roads completely covered by snow. Do not exceed the maximum permissible speed of 30 mph (50 km/h). Remove the snow chains as soon as possible when you are no longer driving on snow-covered roads.
- Local regulations may restrict the use of snow chains. Applicable regulations must be observed if you wish to mount snow chains.
- Snow chains must not be mounted on emergency spare wheels.

If you intend to mount snow chains, please bear the following points in mind:

- you may not attach snow chains to all wheel-tire combinations; see the information under "Wheel and tire combinations" in the "Wheels and tires" section.
- mount snow chains only in pairs and only to the rear wheels. Observe the manufacturer's installation instructions.

- !** If snow chains are mounted on the front wheels, the snow chains could grind against the bodywork or components of the

chassis. This could result in damage to the vehicle or the tires.

**!** **Vehicles with steel wheels:** if you wish to mount snow chains on steel wheels, make sure that you remove the respective wheels' hubcaps first. The hubcaps may otherwise be damaged.

**i** You may wish to deactivate ESP® (▷ page 66) when pulling away with snow chains mounted. This way you can allow the wheels to spin in a controlled manner, achieving an increased driving force (cutting action).

### Slippery road surfaces

#### WARNING

The outside temperature indicator is not designed to serve as an ice-warning device and is therefore unsuitable for that purpose. Indicated temperatures just above the freezing point do not guarantee that the road surface is free of ice. The road may still be icy, especially in wooded areas or on bridges.

#### WARNING

On slippery road surfaces, never downshift in order to obtain braking action. This could result in drive wheel slip and reduced vehicle control. Your vehicle's ABS will not prevent this type of loss of control.

Drive particularly carefully on slippery road surfaces. Avoid sudden acceleration, steering and braking maneuvers. Do not use cruise control or DISTRONIC PLUS.

If the vehicle threatens to skid or cannot be stopped when moving at low speed:

► Shift the transmission to position **N**.

**i** For more information on driving with snow chains, see (▷ page 174).

#### WARNING

Make sure that you do not endanger other road users when you apply the brakes.

## Driving systems

### Cruise control

#### Important safety notes

Cruise control maintains a constant road speed for you. It brakes automatically in order to avoid exceeding the set speed. On long and steep downhill gradients, especially if the vehicle is laden, you must select shift range **1**, **2** or **3** in good time. By doing so, you will make use of the braking effect of the engine, which relieves the load on the brake system and prevents the brakes from overheating and wearing too quickly.

Use cruise control only if road and traffic conditions make it appropriate to maintain a steady speed for a prolonged period. You can set any road speed above 20 mph (30 km/h).

#### WARNING

The cruise control is a convenience system designed to assist the driver during vehicle operation. The driver is and must always remain responsible for the vehicle's speed and for safe brake operation.

Only use the cruise control if the road, traffic, and weather conditions make it advisable to travel at a constant speed.

- The use of the cruise control can be dangerous on winding roads or in heavy traffic because conditions do not allow safe driving at a constant speed.
- The use of the cruise control can be dangerous on slippery roads. Rapid changes in tire traction can result in wheel spin and loss of control.
- Deactivate the cruise control when driving in fog.

The "Resume" function should only be operated if the driver is fully aware of the previously set speed and wishes to resume this particular preset speed.

**⚠ WARNING**

The cruise control brakes automatically so that the set speed is not exceeded.

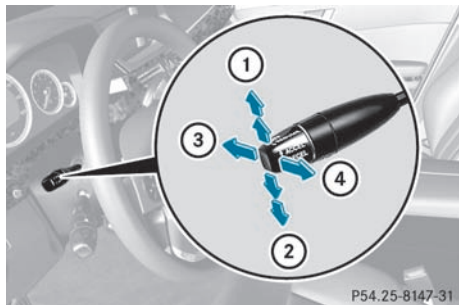
**Cruise control lever**

P54.25-8147-31

- ① To switch on or to increase the speed
- ② To switch on or to reduce the speed
- ③ To deactivate cruise control
- ④ To switch on with the current speed or with the last stored speed

When you activate cruise control, the stored speed is shown in the multifunction display for five seconds. In the multifunction display, the segments between the stored speed and the maximum speed light up.

**Storing and maintaining the current speed**

You can store the current speed if you are driving faster than 20 mph (30 km/h).

- ▶ Accelerate the vehicle to the desired speed.
- ▶ Briefly press the cruise control lever up ① or down ②.
- ▶ Remove your foot from the accelerator pedal. Cruise control is activated. The vehicle automatically maintains the speed.

**i** Cruise control may be unable to maintain the stored speed on uphill gradients. The stored speed is resumed when the gradient evens out. Cruise control maintains the

stored speed on downhill gradients by automatically applying the brakes.

**Storing the current speed or calling up the last stored speed****⚠ WARNING**

The set speed stored in memory should only be set again if prevailing road conditions and legal speed limits permit. Possible acceleration or deceleration differences arising from returning to the preset speed could cause an accident and/or serious injury to you and others.

- ▶ Briefly pull the cruise control lever towards you ④.
- ▶ Remove your foot from the accelerator pedal. The first time cruise control is activated, it stores the current speed or regulates the speed of the vehicle to the previously stored speed.

**Setting a speed****⚠ WARNING**

Keep in mind that it may take a brief moment until the vehicle has made the necessary adjustments.

Increase or decrease the set vehicle speed to a value that the prevailing road conditions and legal speed limits permit. Otherwise, sudden and unexpected acceleration or deceleration of the vehicle could cause an accident and/or serious injury to you and others.

- ▶ Press the cruise control lever up ① for a higher speed or down ② for a lower speed.
- ▶ Keep the cruise control lever pressed until the desired speed is reached.
- ▶ Release the cruise control lever. The new speed is stored.

**i** Cruise control is not deactivated if you depress the accelerator pedal. For example, if you accelerate briefly to

overtake, cruise control adjusts the vehicle's speed to the last speed stored after you have finished overtaking.

### Making adjustments in 1 mph (Canada: 1 km/h) increments

- ▶ Briefly press the cruise control lever to the pressure point, up ① for a higher speed or down ② for a lower speed.  
The last speed stored is increased or reduced.

### Making adjustments in 5 mph (Canada: 10 km/h) increments

- ▶ Briefly press the cruise control lever beyond the pressure point, up ① for a higher speed or down ② for a lower speed.  
The last speed stored is increased or reduced.

### Deactivating cruise control

There are several ways to deactivate cruise control:

- ▶ Briefly press the cruise control lever forwards ③.

or

- ▶ Brake.

Cruise control is automatically deactivated if:

- you depress the parking brake.
- you are driving below 20 mph (30 km/h).
- ESP® intervenes or you deactivate ESP®.
- you shift the transmission to position **N** while driving.

If cruise control is deactivated, you will hear a warning tone. You will see the **Cruise Control Off** message in the multifunction display for approximately five seconds.

- ① The last speed stored is cleared when you switch off the engine.

## DISTRONIC PLUS

### Important safety notes

DISTRONIC PLUS regulates the speed and automatically helps you maintain the distance to the vehicle detected in front. It brakes automatically in order to avoid exceeding the set speed.

On long and steep downhill gradients, especially if the vehicle is laden, you must select shift range **1**, **2** or **3** in good time. By doing so, you will make use of the braking effect of the engine, which relieves the load on the brake system and prevents the brakes from overheating and wearing too quickly.

If a slower-moving vehicle is detected in front, DISTRONIC PLUS causes your vehicle to brake and maintain a preset distance to the vehicle in front.

#### WARNING

The DISTRONIC PLUS requires familiarity with its operational characteristics. We strongly recommend that you review the following information carefully before operating the system.

#### WARNING

The DISTRONIC PLUS is a convenience system. Its speed adjustment reduction capability is intended to make cruise control more effective and usable when traffic speeds vary. It is not however, intended to, nor does it, replace the need for extreme care.

The responsibility for the vehicle's speed, distance to the preceding vehicle and, most importantly, brake operation to ensure a safe stopping distance, always remains with the driver.

The DISTRONIC PLUS cannot take street and traffic conditions into account.

Complex driving situations are not always fully recognized by the DISTRONIC PLUS. This could result in wrong or missing distance warnings.



If you want DISTRONIC PLUS to assist you, the radar sensor system must be activated (▷ page 229) and operational.

If there is no vehicle driving in front of you, DISTRONIC PLUS functions like cruise control at a speed range between 20 mph (Canada: 30 km/h) and 120 mph (Canada: 200 km/h). If a vehicle is driving in front of you, it functions at a speed range between 0 mph (0 km/h) and 120 mph (Canada: 200 km/h).

Do not use DISTRONIC PLUS while driving on roads with steep gradients.

As DISTRONIC PLUS transmits radar waves, it can resemble the radar detectors of the responsible authorities. You can refer to the applicable section in the Operator's Manual if there are any questions concerning this.

**i** USA only:

This device has been approved by the FCC as a "Vehicular Radar System". The radar sensor is intended for use in an automotive radar system only. Removal, tampering, or altering of the device will void any warranties, and is not permitted by the FCC. Do not tamper with, alter, or use in any non-approved way.

Any unauthorized modification to this device could void the user's authority to operate the equipment.

**⚠ WARNING**

The DISTRONIC PLUS adaptive cruise control is not a substitute for active driving involvement. It does not react to pedestrians or on stationary objects, nor does it recognize or predict the curvature and lane layout or the movement of preceding vehicles. The DISTRONIC PLUS can only apply a maximum of 40% of the vehicle's braking power.

The DISTRONIC PLUS may not detect narrow vehicles possibly driving in front of you, such as motorcycles and vehicles driving in an offset formation.

It is the driver's responsibility at all times to be attentive to the road, weather and traffic

conditions. Additionally, the driver must provide the steering, braking and other driving inputs necessary to remain in control of the vehicle.

High-frequency sources such as toll stations, speed measuring systems etc. can cause the DISTRONIC PLUS system to temporarily cease functioning.

**⚠ WARNING**

The DISTRONIC PLUS cannot take road and traffic conditions into account. Only use the DISTRONIC PLUS if the road, weather and traffic conditions make it advisable to travel at a constant speed.

**⚠ WARNING**

Use of the DISTRONIC PLUS can be dangerous on slippery roads. Rapid changes in tire traction can result in wheel spin and loss of control.

The DISTRONIC PLUS does not function in adverse sight and distance conditions. Do not use the DISTRONIC PLUS during conditions of fog, heavy rain, snow or sleet.

**⚠ WARNING**

The DISTRONIC PLUS cannot take weather conditions into account. Switch off the DISTRONIC PLUS or do not switch it on if:

- roads are slippery or covered with snow or ice. The wheels could lose traction while braking or accelerating, and the vehicle could skid.
- the DISTRONIC PLUS system sensor covers are dirty or visibility is diminished due to snow, rain or fog, for example. The distance control system functionality could be impaired.

Always pay attention to surrounding traffic conditions even while the DISTRONIC PLUS is switched on. Otherwise, you may not be able to recognize dangerous situations until it is too late. This could cause an accident in which you and/or others could be injured.

**⚠ WARNING**

The "Resume" function should only be operated if the driver is fully aware of the previously set speed and wishes to resume this particular preset speed.

**⚠ WARNING**

Your undivided attention to street and traffic conditions is necessary at all times whether DISTRONIC PLUS is active or not.

The use of DISTRONIC PLUS can be dangerous on winding roads or in heavy traffic because conditions do not allow safe driving at a constant speed.

DISTRONIC PLUS does not react to stationary objects on the road (for example, a vehicle stopped in traffic or an abandoned vehicle). DISTRONIC PLUS likewise does not react to oncoming vehicles.

Deactivate DISTRONIC PLUS:

- when changing to the right lane, if the vehicles in the left lane are driving slower
- when driving into a filter lane or an expressway exit
- in complex driving situations, for example in construction sites on an expressway

In these situations DISTRONIC PLUS will maintain the set speed if it is not deactivated.

DISTRONIC PLUS is intended only for maintaining a set speed and a set distance from the objects moving in front of the vehicle.

**⚠ WARNING**

An intermittent warning sounds and the distance warning lamp  in the instrument cluster is illuminated if the DISTRONIC PLUS system calculates that the distance to the vehicle ahead and your vehicle's current speed indicate that the DISTRONIC PLUS will not be capable of slowing the vehicle sufficiently to maintain the preset following distance, which creates a danger of a collision.

Immediately brake the vehicle to increase your distance to the preceding vehicle. The warning sound is intended as a final caution in which you should intercede with your own braking inputs to avoid a potentially dangerous situation. Do not wait for the operation of the warning signal to intercede with your own braking. This will result in potentially dangerous emergency braking which will not always result in an impact being avoided.

Tailgating increases the risk of an accident.

**⚠ WARNING**

DISTRONIC PLUS brakes your vehicle with a maximum deceleration of  $13 \text{ ft/s}^2$  ( $4 \text{ m/s}^2$ ). This is equivalent to approximately 40 % of your vehicle's maximum possible deceleration.

You need to brake yourself to prevent a collision. DISTRONIC PLUS brakes the vehicle to restore the set distance from the vehicle ahead or the set speed.

**⚠ WARNING**

If you do not receive visual or acoustic warning signals during a critical traffic situation, DISTRONIC PLUS has either not recognized the collision risk, has been deactivated or is malfunctioning.

Remember, whether or not DISTRONIC PLUS is operating, it is ultimately always the drivers responsibility to apply the brakes in order to control the vehicle and avoid a collision.

### Cruise control lever

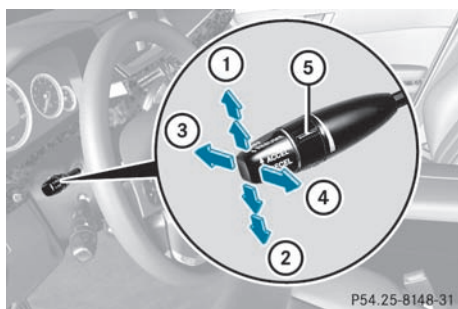

P54.25-8148-31

- ① To store the current speed or a higher speed
- ② To store the current speed or a lower speed
- ③ To deactivate DISTRONIC PLUS
- ④ To store the current speed or to call up the last stored speed
- ⑤ To set the specified minimum distance

### Switching on DISTRONIC PLUS, storing the current speed and maintaining it

#### Important safety notes

##### **WARNING**

The vehicle can be braked when DISTRONIC PLUS is activated. For this reason, deactivate DISTRONIC PLUS if the vehicle is to be set in motion by other means (e.g. in a car wash or by towing).

In order to activate DISTRONIC PLUS, the following conditions must be fulfilled:

- the engine must be started. It may take up to two minutes after pulling away before DISTRONIC PLUS is operational.
- the parking brake must not be applied.
- ESP® must be activated but not intervening.
- the transmission must be in position **D**.
- the hood must be closed.
- the driver's door must be closed when you shift from **P** to **D** or your seat belt must be fastened.

- the front-passenger door and rear doors must be closed.
- the vehicle must not skid.

#### Activating while driving

When driving at speeds below 20 mph (30 km/h), you can only activate DISTRONIC PLUS if the vehicle in front has been detected and is shown in the multifunction display. If the vehicle in front is no longer detected and shown, DISTRONIC PLUS is deactivated and a warning tone sounds.

- ▶ Briefly pull the cruise control lever towards you ④, or briefly press up ① or down ②. DISTRONIC PLUS is selected.
- ▶ Keep the cruise control lever pressed up ① or down ② until the desired speed is set.
- ▶ Remove your foot from the accelerator pedal.  
Your vehicle adapts its speed to that of the vehicle in front, but only up to the desired stored speed.

- i** If you do not fully release the accelerator pedal, the **DISTRONIC PLUS Override** message is shown in the multifunction display. The set distance to a slower-moving vehicle in front will then not be maintained. You will be driving at the speed you determine by the position of the accelerator pedal.

#### Activating when driving towards a stationary vehicle

If the vehicle in front of you is stationary, you can only activate DISTRONIC PLUS once your vehicle is stationary as well.

- ▶ Briefly pull the cruise control lever towards you ④, or briefly press up ① or down ②. DISTRONIC PLUS is selected.
- i** DISTRONIC PLUS can only be activated at under 20 mph (30 km/h) if a vehicle in front has been detected. Therefore, the DISTRONIC PLUS distance display in the

instrument cluster should be activated (▷ page 224).

- ▶ Keep the cruise control lever pressed up ① or down ② until the desired speed is set.
- ① You can use the cruise control lever to set the stored speed and the control on the cruise control lever to set the specified minimum distance (▷ page 183).

### Pulling away

- ▶ **If the vehicle in front pulls away:** remove your foot from the brake pedal.
  - ▶ Briefly pull the cruise control lever towards you ④.
- or
- ▶ Accelerate briefly.  
Your vehicle pulls away and adapts its speed to that of the vehicle in front.

### Driving

If there is no vehicle in front, DISTRONIC PLUS operates in the same way as cruise control.

If a slower-moving vehicle is detected in front, DISTRONIC causes your vehicle to brake. This maintains the preset distance to the vehicle in front.

If DISTRONIC PLUS detects a faster-moving vehicle in front, it increases the driving speed of your vehicle, but only up to the desired speed you have stored.

#### WARNING

If you depress the brake, DISTRONIC PLUS is deactivated unless your vehicle is stationary. DISTRONIC PLUS then no longer brakes your vehicle. In such cases, control the distance from vehicles travelling in front with the brake alone. You could otherwise cause an accident and thereby injure yourself and others. The driver remains fully responsible for the vehicle's distance from other vehicles, the speed being driven and for braking in good time.

### Changing lanes

If you wish to change to the passing lane (in left-hand-drive vehicles, the passing lane is the left-hand lane), DISTRONIC PLUS supports you if:

- you are driving faster than 40 mph (60 km/h).
- DISTRONIC PLUS is maintaining the distance to a vehicle in front.
- you switch on the appropriate turn signals.
- DISTRONIC PLUS does not detect a danger of collision.

If these conditions are met, your vehicle is accelerated. Acceleration will be interrupted if changing lanes takes too long or if the distance between your vehicle and the vehicle in front becomes too small.

#### WARNING

DISTRONIC PLUS and Active Blind Spot Assist are only aids designed to assist driving.

They do not relieve you of the responsibility of paying attention. The driver remains fully responsible for the vehicle's distance from other vehicles, the vehicle's speed and for braking in good time. Always pay attention to traffic conditions and your surroundings. Otherwise, you may fail to recognize dangers in time, cause an accident and injure yourself and others.

### Stopping

#### WARNING

Never get out of the vehicle when DISTRONIC PLUS is activated.

DISTRONIC PLUS must also never be operated, activated or deactivated by a passenger or from outside the vehicle.

DISTRONIC PLUS does not replace the parking brake and must not be used for parking.

The DISTRONIC PLUS braking effect is canceled and the vehicle can start moving if:

- DISTRONIC PLUS is deactivated using the cruise control lever.
- you accelerate.
- there is a malfunction in the system or an interruption in the power supply, e.g. battery failure.
- the electrical system in the engine compartment, the battery or the fuses are tampered with.
- the battery is disconnected.

If you wish to leave the vehicle or park it, deactivate DISTRONIC PLUS and secure the vehicle against rolling away.

If DISTRONIC PLUS detects that the vehicle in front is stopping, it brakes your vehicle until it is stationary.

Once your vehicle is stationary, it remains stationary and you do not need to depress the brake.

- i** Depending on the specified minimum distance, your vehicle will come to a standstill at a sufficient distance behind the vehicle in front. The specified minimum distance is set using the control on the cruise control lever.

When DISTRONIC PLUS is activated, the transmission is shifted automatically to position **P** if:

- the driver's door is open and the driver's seat belt is unfastened.
- the engine is switched off.
- the hood is opened.
- a system malfunction occurs.
- the power supply is not sufficient.

### Setting a speed

#### WARNING

Keep in mind that it may take a brief moment until the vehicle has made the necessary adjustments.

Increase or decrease the set vehicle speed to a value that the prevailing road conditions and legal speed limits permit. Otherwise, sudden and unexpected acceleration or deceleration of the vehicle could cause an accident and/or serious injury to you and others.

- ▶ Press the cruise control lever up **①** for a higher speed or down **②** for a lower speed.
- ▶ Keep the cruise control lever pressed until the desired speed is reached.
- ▶ Release the cruise control lever. The new speed is stored. DISTRONIC PLUS is activated and adjusts the vehicle's speed to the new speed stored.

### Making adjustments in 1 mph (Canada: 1 km/h) increments

- ▶ Briefly press the cruise control lever to the pressure point, up **①** for a higher speed or down **②** for a lower speed. The last speed stored is increased or reduced.

### Making adjustments in 5 mph (Canada: 10 km/h) increments

- ▶ Briefly press the cruise control lever beyond the pressure point, up **①** for a higher speed or down **②** for a lower speed. The last speed stored is increased or reduced.

### Storing the current speed or calling up a stored speed

#### WARNING

The set speed stored in memory should only be set again if prevailing road conditions and legal speed limits permit. Possible acceleration or deceleration differences arising from returning to the preset speed could cause an accident and/or serious injury to you and others.

- ▶ Briefly pull the cruise control lever towards you ④.
- ▶ Remove your foot from the accelerator pedal. DISTRONIC PLUS is activated. The first time it is activated, the current speed is stored. Otherwise, it sets the vehicle cruise speed to the previously stored value.

### Sets the specified minimum distance

You can set the specified minimum distance for DISTRONIC PLUS by varying the time span between one and two seconds. With this function, you can set the minimum distance that DISTRONIC PLUS keeps to the vehicle in front, dependent on vehicle speed. You can see this distance in the multifunction display (▷ page 183).

#### WARNING

It is up to the driver to exercise discretion to select the appropriate setting given road conditions, traffic, driver's preferred driving style and applicable laws and driving recommendations for safe following distance.

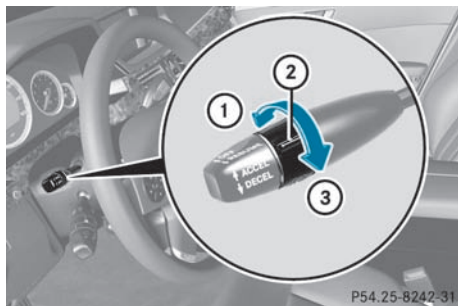

- ▶ **To increase:** turn control ② in direction ③.
- DISTRONIC PLUS then maintains a greater distance between your vehicle and the vehicle in front.
- ▶ **To decrease:** turn control ② in direction ①.
- DISTRONIC PLUS then maintains a shorter distance between your vehicle and the vehicle in front.

- ❗ Make sure that you maintain a sufficient and safe distance from the vehicle in front. Adjust the distance to the vehicle in front if necessary.

### DISTRONIC PLUS displays in the speedometer



When DISTRONIC PLUS is activated, one or two segments ② in the set speed range light up.

- ❗ For design reasons, the speed displayed in the speedometer may differ slightly from the speed set for DISTRONIC PLUS.

If DISTRONIC PLUS detects a vehicle in front, segments ② between speed of the vehicle in front ① and stored speed ③ light up.

### DISTRONIC PLUS displays in the multifunction display

#### General notes

You can select the distance display in the Assistance menu (▷ page 224) of the on-board computer.



### Display when DISTRONIC PLUS is deactivated

- ▶ Select the **Distance Display** function using the on-board computer (▶ page 224).

When DISTRONIC PLUS is deactivated, you will see the following in the multifunction display:



- ① Symbol for activated PRE-SAFE® Brake
- ② Vehicle in front, if detected
- ③ Distance indicator, current distance to the vehicle in front
- ④ Specified minimum distance to the vehicle in front; adjustable
- ⑤ Own vehicle

### Display when DISTRONIC PLUS is activated

- ▶ Select the **Distance Display** function using the on-board computer (▶ page 224).

You will see the stored speed for about five seconds when you activate DISTRONIC PLUS. After this time, you will see the following in the multifunction display while DISTRONIC PLUS is activated:



- ① DISTRONIC PLUS activated
- ② Own vehicle
- ③ Specified minimum distance to the vehicle in front; adjustable
- ④ Vehicle in front, if detected

### Deactivating DISTRONIC PLUS

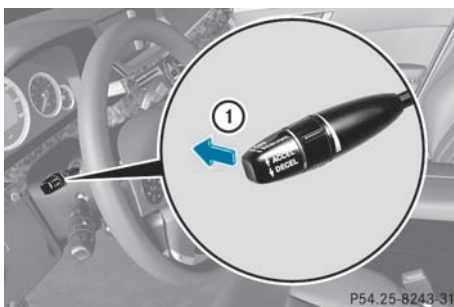

There are several ways to deactivate DISTRONIC PLUS:

- ▶ Briefly press the cruise control lever forwards ①.

or

- ▶ Brake, unless the vehicle is stationary.

When you deactivate DISTRONIC PLUS, the **DISTRONIC PLUS Off** message is shown in the multifunction display for approximately five seconds.

- i** The last speed stored remains stored until you switch off the engine.
- i** DISTRONIC PLUS is not deactivated if you depress the accelerator pedal. If you accelerate to overtake, DISTRONIC PLUS adjusts the vehicle's speed to the last



speed stored after you have finished overtaking.

DISTRONIC PLUS is automatically deactivated if:

- you apply the parking brake.
- you are driving slower than 15 mph (25 km/h) and there is no vehicle in front, or if the vehicle in front is no longer detected.
- ESP® intervenes or you deactivate ESP®.
- the transmission is in the **P**, **R** or **N** position.
- you switch off the radar sensor system (▷ page 229).
- you pull the cruise control lever towards you in order to pull away and the front-passenger door or one of the rear doors is open.
- the vehicle has skidded.

If DISTRONIC PLUS is deactivated, you will hear a warning tone. The **DISTRONIC PLUS Off** message is shown in the multifunction display for approximately five seconds.

#### **WARNING**

The DISTRONIC PLUS switches off and releases the brakes when the vehicle decelerates below the minimum speed of 20 mph (30 km/h) by operation of the system unless the DISTRONIC PLUS detects a vehicle directly ahead of you. At that time the driver must apply the brakes in order to reduce vehicle speed further or bring it to a stop.

### Tips for driving with DISTRONIC PLUS

#### Important safety notes

The following contains descriptions of certain road and traffic conditions in which you must be particularly attentive. In such situations, brake if necessary. DISTRONIC PLUS is then deactivated.

#### **WARNING**

The DISTRONIC PLUS works to maintain the speed selected by the driver unless a moving obstacle proceeding directly ahead of it in the

same travel direction is detected (e.g. following another vehicle ahead of you at your set distance).

This means that:

- Your vehicle can pass another vehicle after you have changed lanes.
- While in a sharp turn or if the preceding vehicle is in a sharp turn, the DISTRONIC PLUS could lose sight of the preceding vehicle. Your vehicle could then accelerate to the previously selected speed.

The DISTRONIC PLUS regulates only the distance between your vehicle and those directly ahead of it. It may not register stationary objects in the road, e.g.:

- a stopped vehicle in a traffic jam
- a disabled vehicle
- an oncoming vehicle

The driver must always be alert, observe all traffic and intercede as required by means of steering or braking the vehicle.

#### **WARNING**

The DISTRONIC PLUS should not be used in snowy or icy road conditions.

### Cornering, going into and coming out of a bend

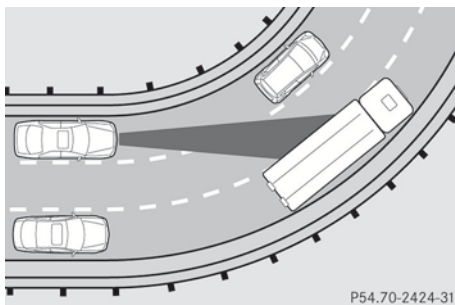

P54.70-2424-31

The ability of DISTRONIC PLUS to detect vehicles when cornering is limited. Your vehicle may brake unexpectedly or late.

### Vehicles traveling on a different line

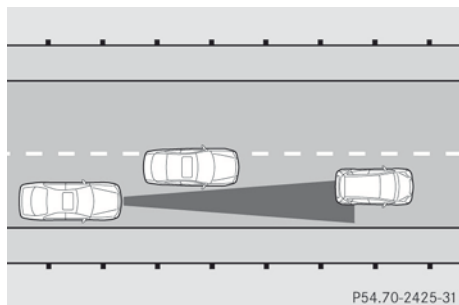

DISTRONIC PLUS may not detect vehicles traveling on a different line. The distance to the vehicle in front will be too short.

### Other vehicles changing lane

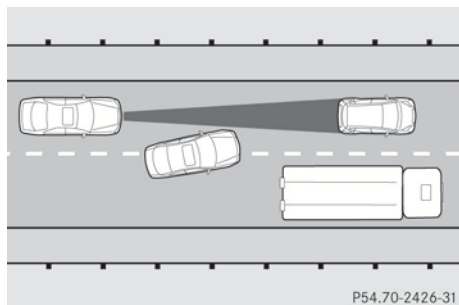

DISTRONIC PLUS has not detected the vehicle cutting in yet. The distance to this vehicle will be too short.

### Narrow vehicles

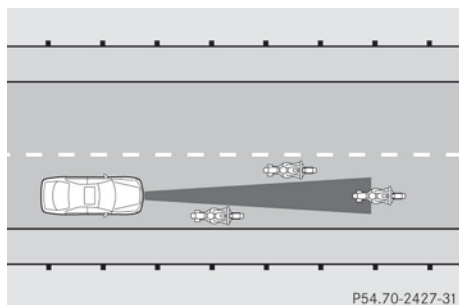

DISTRONIC PLUS has not yet detected the vehicle in front on the edge of the road,

because of its narrow width. The distance to the vehicle in front will be too short.

### Obstructions and stationary vehicles

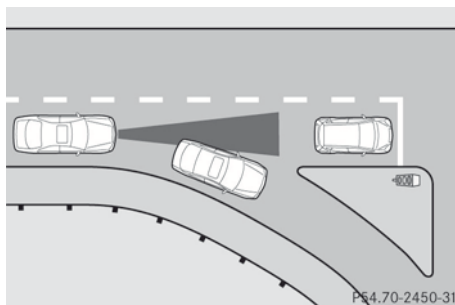

DISTRONIC PLUS does not brake for obstacles or stationary vehicles. If, for example, the detected vehicle turns a corner and reveals an obstacle or stationary vehicle, DISTRONIC PLUS will not brake for these.

### Crossing vehicles

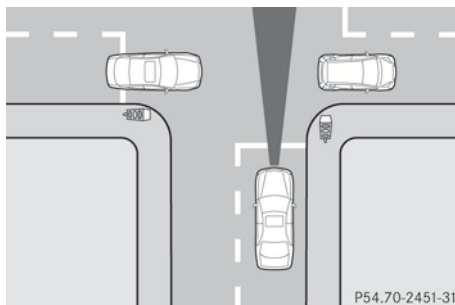

DISTRONIC PLUS may mistakenly detect vehicles that are crossing your lane. Activating DISTRONIC PLUS at traffic lights with crossing traffic, for example, could cause your vehicle to pull away unintentionally.

## HOLD function

### General notes

The HOLD function can assist the driver in the following situations:

- when pulling away, especially on steep slopes
- when maneuvering on steep slopes
- when waiting in traffic

The vehicle is kept stationary without the driver having to depress the brake pedal.

The braking effect is canceled and the HOLD function deactivated when you depress the accelerator pedal to pull away.

### Activation conditions

You can activate the HOLD function if:

- the vehicle is stationary.
- the engine is running.
- the driver's door is closed or your seat belt is fastened.
- the parking brake is not applied.
- the hood is closed.
- the transmission is in position **D**, **R** or **N**.
- DISTRONIC PLUS is deactivated.

### Activating the HOLD function

- ▶ Make sure that the activation conditions are met.
- ▶ Depress the brake pedal.



- ▶ Quickly depress the brake pedal further until **HOLD** display ① appears in the multifunction display. The HOLD function is activated. You can release the brake pedal.

- ① If depressing the brake pedal the first time does not activate the HOLD function, wait briefly and then try again.

### ⚠ WARNING

The vehicle's brakes are applied when the HOLD function is activated. For this reason, deactivate the HOLD function if the vehicle is to be set in motion by other means (e.g. in a car wash or by towing).

### Deactivating the HOLD function

The HOLD function is deactivated automatically if:

- you accelerate and the transmission is in position **D** or **R**.
- you shift the transmission to position **P**.
- you apply the brakes again with a certain amount of pressure until **HOLD** disappears from the multifunction display.
- you activate DISTRONIC PLUS.

### ⚠ WARNING

Never get out of the vehicle when the HOLD function is activated.

The HOLD function must never be operated or deactivated by a passenger or from outside the vehicle.

The HOLD function does not replace the parking brake and must not be used for parking.

The braking effect of the HOLD function is canceled and the vehicle could roll away if:

- the HOLD function is deactivated by depressing the accelerator pedal or the brake pedal.
- there is a malfunction in the system or an interruption in the power supply, e.g. battery failure.
- the electrical system in the engine compartment, the battery or the fuses are tampered with.
- the battery is disconnected.

If you leave the vehicle or park it, deactivate the HOLD function and secure the vehicle against rolling away.

When the HOLD function is activated, the transmission is shifted automatically to position **P** if:

- the driver's door is open and the driver's seat belt is unfastened.
- the engine is switched off.
- the hood is opened.
- a system malfunction occurs.
- the power supply is not sufficient.

**i** If the engine has been switched off, it cannot be started again until the HOLD function has been deactivated.

If there is a malfunction in the system or power supply while the HOLD function is activated, the **Brake immediately** message is shown in the multifunction display. Immediately depress the brake firmly until the warning message in the multifunction display goes out.

## RACE START

### Important safety notes

**i** RACE START is only available in AMG vehicles.

RACE START enables optimal acceleration from a standing start. The precondition for this is a suitable high-grip road surface.

### **⚠** WARNING

RACE START is only available when SPORT handling mode is activated. SPORT handling mode only stabilizes the vehicle to a limited extent in the event of swerving or wheelspin. RACE START should only be used on specially designated roads. Always adapt your speed and driving style to the prevailing road and weather conditions.

### Conditions for activation

RACE START can be activated when:

- the doors are closed.
- the engine is running and it has reached an operating temperature of approximately 176 °F (80 °C). This is the case when the engine oil temperature in the multifunction display stops flashing.
- SPORT handling mode is activated. (▷ page 67)
- the steering wheel is in the straight-ahead position.
- the vehicle is stationary and the brake pedal is depressed (left foot).
- the transmission is in position **D**.

### Activating RACE START

- ▶ Depress the brake pedal with your left foot, and keep it depressed.
- ▶ Turn the drive program selector clockwise (▷ page 156) until the **RS** lamp lights up. The multifunction display shows the **RACE START Confirm: Paddle UP Cancel: Paddle DOWN** message.

**i** If the conditions for activation are no longer fulfilled, RACE START is canceled. The multifunction display shows the **RACE START canceled** message.

- ▶ To cancel: pull the left steering wheel shift paddle (▷ page 157).

or

- ▶ To confirm: pull the right steering wheel shift paddle (▷ page 157). The multifunction display shows the **RACE START available Depress accelerator** message.

**i** If you do not depress the accelerator pedal fully within two seconds, RACE START is canceled. The multifunction display shows the **RACE START not possible See Operator's Manual** message.

- ▶ Depress the accelerator pedal fully. The engine speed increases to approximately 4000 rpm.

The multifunction display shows the **RACE START Release brake to start** message.

- ⓘ If you do not release the brake pedal within seven seconds, RACE START is canceled. The multifunction display shows the **RACE START canceled** message.
- ▶ Take your foot off the brake, but keep the accelerator pedal depressed. The vehicle pulls away at maximum acceleration. The multifunction display shows the **RACE START active** message.

RACE START is deactivated when a speed of approximately 30 mph (Canada: 50 km/h) is reached. Drive program **S+** is activated. SPORT handling mode remains activated. RACE START is deactivated immediately if you release the accelerator pedal during RACE START or if any of the activation conditions are no longer fulfilled. The multifunction display shows the **RACE START not possible See Operator's Manual** message.

- ⓘ If RACE START is used repeatedly within a short period of time, it is only available again after the vehicle has been driven a certain distance.

## AIRMATIC

### Vehicle level

#### Important safety notes

Your vehicle regulates its height automatically. All-round self-leveling ensures the best possible suspension and constant ground clearance, even with a laden vehicle. When you drive fast, the vehicle is lowered automatically to improve driving safety and to reduce fuel consumption.

The following vehicle levels are possible:

- normal
- raised: the vehicle is raised by about 0.80 in (20 mm) when compared with the normal level
- lowered: the vehicle is lowered by about 0.40 in (10 mm) when compared with the normal level

The "Normal" and "Raised" vehicle levels can be set manually.

The "Lowered" vehicle level is set automatically:

- at speeds above 70 mph (113 km/h)
- if you have selected "Sports tuning" (▷ page 190)

#### Setting the vehicle level

Select the "Normal" setting for normal road surfaces and "Raised" for driving with snow chains or on particularly poor road surfaces. Your selection remains stored even if you remove the SmartKey from the ignition lock.

#### WARNING

To help avoid personal injury, keep hands and feet away from wheel housing area, and stay away from under the vehicle when lowering the vehicle chassis.

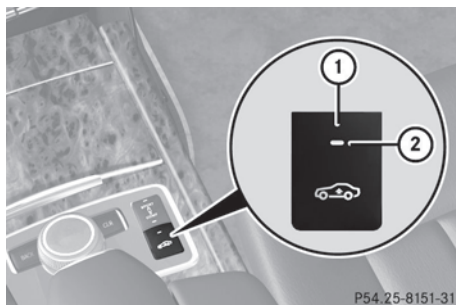

P54.25-8151-31

#### Setting raised level

- ▶ Start the engine.

If indicator lamp ② is not lit:

- ▶ Press button ①.  
Indicator lamp ② lights up. The vehicle height is adjusted to raised level.  
The **Vehicle rising** message appears in the display.

The "Raised level" setting is canceled if you:

- drive at speeds above approximately 75 mph (120 km/h)
- drive about 3 minutes at speeds above 50 mph (80 km/h)

The "Raised level" remains active when you are not driving within these speed ranges.

### Setting the normal level

- ▶ Start the engine.

If indicator lamp ② is lit:

- ▶ Press button ①.  
Indicator lamp ② goes out. The vehicle is adjusted to normal level.

## Suspension tuning

### General notes

The electronically controlled damping system works continuously. This improves driving safety and ride comfort.

The damping is tuned individually to each wheel and depends on:

- your driving style, e.g. sporty
- the road surface condition, e.g. bumps
- your individual selection, i.e. sports or comfort

Your selection remains stored even if you remove the SmartKey from the ignition lock.

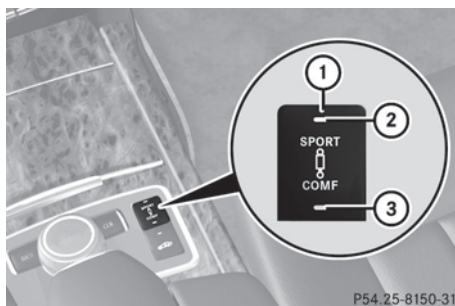

### Sports tuning

The firmer suspension tuning in Sport mode ensures even better contact with the road. Select this mode when employing a sporty driving style, e.g. on winding country roads.

- ▶ Press button ①.  
Indicator lamp ② lights up. Sports suspension tuning is selected.  
The **AIRMATIC SPORT** message appears in the multifunction display.

### Comfort tuning

In Comfort mode, the driving characteristics of your vehicle are more comfortable. Select this mode if you prefer a more comfortable driving style, but also when driving fast on straight roads, e.g. highways.

- ▶ Press button ①.  
Indicator lamp ③ lights up. Comfort tuning is selected.  
The **AIRMATIC COMFORT** message appears in the multifunction display.

## AMG adaptive sport suspension system

### General notes

- ❗ AMG adaptive sport suspension system is available for the E 63 AMG model.

## Rear axle level control

The vehicle automatically sets the vehicle level at the rear axle. Rear axle level control ensures the best possible suspension and that the ground clearance remains constant even when the vehicle is loaded. This improves driving safety and fuel consumption.

## Suspension tuning

### General notes

The electronically controlled damping system works continuously. This improves driving safety and ride comfort.

The damping is tuned individually to each wheel and depends on:

- your driving style, e.g. sporty
- the road surface condition, e.g. bumps
- your individual selection of Sport, Sport + or Comfort

If you select Sport or Sport + mode and restart the engine, the suspension setting reverts to Comfort mode.

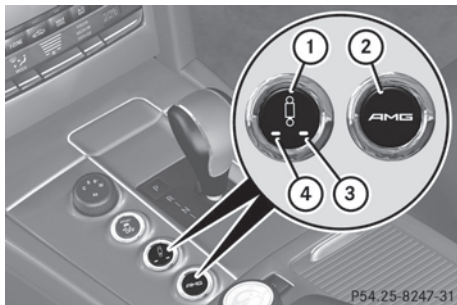

### Sport mode

The firmer suspension tuning in Sport mode ensures even better contact with the road. Select this mode when employing a sporty driving style, e.g. on winding country roads.

- ▶ Press button ① once.  
Indicator lamp ④ lights up. You have selected Sport mode.

The **AMG Suspension System SPORT** message appears in the multifunction display.

### Sport + mode

The very firm setting of the suspension tuning in Sport + mode ensures the best possible contact with the road. Select this mode only when driving on race circuits.

If indicator lamps ③ and ④ are off:

- ▶ Press button ① twice.  
Indicator lamps ③ and ④ light up. You have selected Sport + mode.  
The **AMG Suspension System SPORT +** message appears in the multifunction display.

If indicator lamp ④ lights up:

- ▶ Press button ① once.  
The second indicator lamp ③ lights up. You have selected Sport + mode.  
The **AMG Suspension System SPORT +** message appears in the multifunction display.

### Comfort mode

In Comfort mode, the driving characteristics of your vehicle are more comfortable. Select this mode if you prefer a more comfortable driving style, but also when driving fast on straight roads, e.g. highways.

- ▶ Press button ① repeatedly until indicator lamps ③ and ④ go out.  
You have selected Comfort mode.  
The **AMG Suspension System COMFORT** message appears in the multifunction display.

### Storing and calling up settings

Once the suspension tuning and drive program have been selected, you can store and call up your settings using AMG button ②.

- ▶ **To store:** press AMG button ② until you hear a tone.



- ▶ **To call up:** press AMG button ②.  
The stored suspension tuning and drive program are selected.
- ▶ **To display:** briefly press AMG button ②.  
Your selection appears in the multifunction display.

#### 4MATIC (permanent four-wheel drive)

4MATIC ensures that all four wheels are permanently driven. Together with ESP®, it improves the traction of your vehicle whenever a drive wheel spins due to insufficient grip.

#### ⚠ WARNING

If a drive wheel is spinning due to insufficient traction:

- While driving off, apply as little throttle as possible.
- While driving, ease up on the accelerator pedal.
- Adapt your speed and driving style to the prevailing road conditions.

Failure to observe these guidelines could cause the vehicle to skid.

The 4MATIC cannot prevent accidents resulting from excessive speed.

- ❗ Never tow the vehicle with one axle raised. This may damage the transfer case. Damage of this sort is not covered by the Mercedes-Benz Limited Warranty. All wheels must remain either on the ground or be fully raised. Observe the instructions for towing the vehicle with all wheels in full contact with the ground.

- ⓘ In wintry driving conditions, the maximum effect of 4MATIC can only be achieved if you use winter tires (M+S tires), with snow chains if necessary.

## PARKTRONIC

### Important safety notes

#### ⚠ WARNING

The PARKTRONIC is a supplemental system. It is not intended to, nor does it replace, the need for extreme care. The responsibility during parking and other critical maneuvers always remains with the driver.

#### ⚠ WARNING

Make sure no persons or animals are in or near the area in which you are parking/maneuvering. Otherwise, they could be injured.

PARKTRONIC is an electronic parking aid with ultrasonic sensors. It indicates visually and audibly the distance between your vehicle and an object.

PARKTRONIC is activated automatically when you:

- switch on the ignition
- shift the transmission to position **D**, **R** or **N**
- release the parking brake

PARKTRONIC is deactivated at speeds above 11 mph (18 km/h). It is reactivated at lower speeds.

PARKTRONIC monitors the area around your vehicle using six sensors in the front bumper and four sensors in the rear bumper.

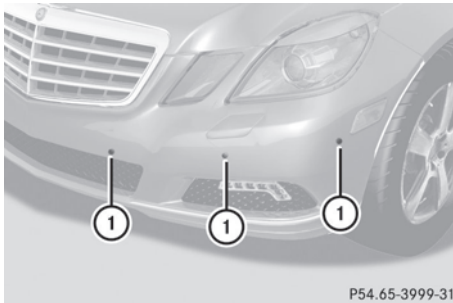

P54.65-3999-31

- ① Sensors in the front bumper, left-hand side (example)

## Range of the sensors

### General notes

The sensors must be free of dirt, ice and slush; otherwise they may not function correctly. Clean the sensors regularly, taking care not to scratch or damage them (▷ page 317).

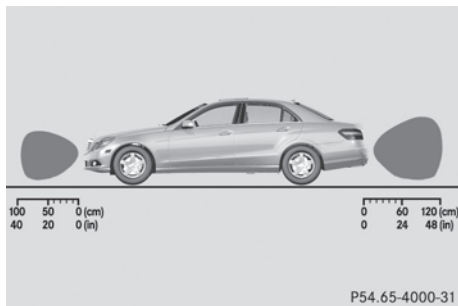

Side view, Sedan (example)

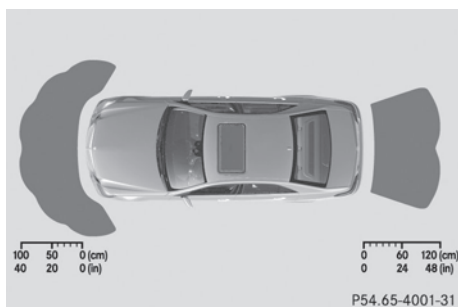

Top view, Sedan (example)

### Front sensors

Center	Approximately 40 in (approximately 100 cm)
Corners	Approximately 24 in (approximately 60 cm)

### Rear sensors

Center	Approximately 48 in (approximately 120 cm)
Corners	Approximately 32 in (approximately 80 cm)

**!** When parking, pay particular attention to objects above or below the sensors, such as flower pots or trailer drawbars. PARKTRONIC does not detect such objects when they are in the immediate vicinity of the vehicle. You could damage the vehicle or the objects.

The sensors may not detect snow and other objects that absorb ultrasonic waves.

Ultrasonic sources such as an automatic car wash, the compressed-air brakes on a truck or a pneumatic drill could cause PARKTRONIC to malfunction.

PARKTRONIC may not function correctly on uneven terrain.

### Minimum distance

Center	Approximately 8 in (approximately 20 cm)
Corners	Approximately 6 in (approximately 15 cm)

If there is an obstacle within this range, the relevant warning displays light up and a warning tone sounds. If the distance falls below the minimum, the distance may no longer be shown.

### Warning displays

The warning displays show the distance between the sensors and the obstacle. The warning display for the front area is located on the dashboard above the center air vents. The warning display for the rear area is located on the headliner in the rear compartment.

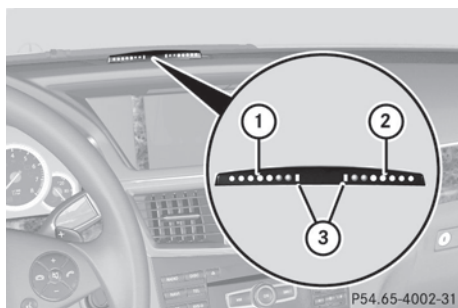

Warning display for the front area

- ① Segments on the left-hand side of the vehicle
- ② Segments on the right-hand side of the vehicle
- ③ Segments showing operational readiness

The warning display for each side of the vehicle is divided into five yellow and two red segments. PARKTRONIC is operational if yellow segments showing operational readiness ③ light up.

The selected transmission position determines which warning display is active when the engine is running.

Transmission position	Warning display
D	Front area activated
R or N	Rear and front areas activated
P	No areas activated

One or more segments light up as the vehicle approaches an obstacle, depending on the vehicle's distance from the obstacle.

From the:

- sixth segment onwards, you will hear an intermittent warning tone for approximately two seconds.
- seventh segment onwards, you will hear a warning tone for approximately two seconds. This indicates that you have now reached the minimum distance.

## Deactivating/activating PARKTRONIC

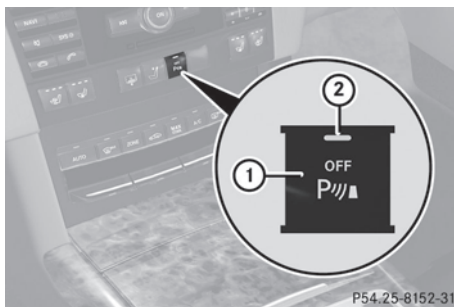

- ① To deactivate/activate PARKTRONIC
- ② Indicator lamp

If indicator lamp ② lights up, PARKTRONIC is deactivated.

- ⓘ PARKTRONIC is automatically activated when you turn the SmartKey to position 2 in the ignition lock.

## Problems with PARKTRONIC

Problem	Possible causes/consequences and ► Solutions
Only the red segments in the PARKTRONIC warning displays are lit. You also hear a warning tone for approximately two seconds. PARKTRONIC is deactivated after approximately 20 seconds, and the indicator lamp in the PARKTRONIC button lights up.	<p>PARKTRONIC has malfunctioned and has switched off.</p> <p>► If problems persist, have PARKTRONIC checked at a qualified specialist workshop.</p>
Only the red segments in the PARKTRONIC warning displays are lit. PARKTRONIC is deactivated after approximately 20 seconds.	<p>The PARKTRONIC sensors are dirty or there is interference.</p> <p>► Clean the PARKTRONIC sensors (▷ page 317).</p> <p>► Switch the ignition back on.</p>
	<p>The problem may be caused by an external source of radio or ultrasound waves.</p> <p>► See if PARKTRONIC functions in a different location.</p>

## Parking Guidance

### Important safety notes

Parking Guidance is an electronic parking aid with ultrasound. Ultrasound is used to measure the road on both sides of the vehicle. A suitable parking space is indicated by the parking symbol. You receive steering instructions when parking. You may also use PARKTRONIC (▷ page 192).

#### WARNING

Parking Guidance is merely an aid and may display parking spaces that are not suitable for parking, for example:

- no-parking areas
- parking spaces with unsuitable surfaces (road surface)

- driveways
- entrances and exits

Parking Guidance detects and measures potential parking spaces while driving past. Changes to the parking space after this point are not taken into account, for example if the vehicle in front of or behind the parking space changes position or objects in the parking space are moved.

Even when using Parking Guidance, you are still responsible for driving carefully. If you rely on Parking Guidance alone, you could cause an accident and injure yourself and others.

Safety always remains your responsibility and you must continue paying careful attention to your immediate surroundings when parking and maneuvering.

**⚠ WARNING**

Objects located above the height range of Parking Guidance will not be detected when the parking space is measured. These objects are not taken into account when the parking procedure is calculated, e.g. overhanging loads, tail sections or loading ramps of goods vehicles. Under some circumstances, Parking Guidance might therefore issue steering instructions too soon. This may lead to a collision. For this reason, you should avoid using Parking Guidance in such situations.

**⚠ WARNING**

Make sure that no persons or animals are in the maneuvering range. Otherwise, they could be injured.

- ❗ Pay particular attention to low objects or objects with flat surfaces, such as trailer drawbars, posts, cross beams and curbs. These types of objects cannot be detected by Parking Guidance and may damage the vehicle.

When PARKTRONIC is deactivated, Parking Guidance is also unavailable.

Use Parking Guidance for parking spaces:

- that are parallel to the direction of travel
- that are on straight roads, not bends
- that are on the same level as the road, i.e. not on the pavement, for example. Parking Guidance may not detect flat curbs

Parking tips:

- on narrow roads, drive past the parking space as close as possible.
- parking spaces that are littered, overgrown or partially occupied by trailer drawbars might be identified incorrectly or not at all.
- snowfall or heavy rain may lead to a parking space being measured inaccurately.
- pay attention to the PARKTRONIC (▷ page 193) warning messages during the parking procedure.

- when transporting a load which protrudes from your vehicle, you must not use Parking Guidance.
- never use Parking Guidance with snow chains or an emergency spare wheel installed.
- make sure that the tire pressures are always correct. This has a direct effect on the steering instructions.
- the way your vehicle is positioned in the parking space after parking is dependent on various factors. These include the position and shape of the vehicles parked in front and behind it and the conditions of the location. In some cases, Parking Guidance may guide you too far or not far enough into a parking space. In some cases, it may also lead you across or onto the curb. If necessary, cancel the parking procedure with Parking Guidance.

- ❗ If unavoidable, you should drive over obstacles such as curbs slowly and not at a sharp angle. Otherwise, you may damage the wheels or tires.

### Detecting a parking space

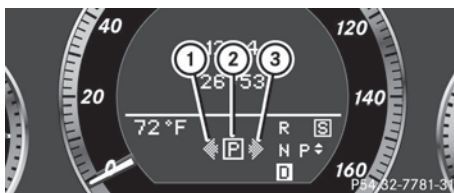

Example

- ① Detected parking space on the left
- ② Parking symbol
- ③ Detected parking space on the right

Parking Guidance is automatically activated when you drive forwards. The system is operational at speeds of up to approximately 22 mph (35 km/h). While in operation, the system independently locates and measures parking spaces on both sides of the vehicle. When driving at speeds below 19 mph

(30 km/h), you will see parking symbol ② as a status indicator in the instrument cluster. When a parking space has been detected, an arrow towards the right ③ or the left ① also appears. Parking Guidance only displays parking spaces on the front-passenger side as standard. Parking spaces on the driver's side are displayed as soon as the turn signal on the driver's side is activated. To park on the driver's side, you must leave the driver's side turn signal switched on until you have engaged reverse gear.

Parking Guidance will only detect parking spaces:

- that are parallel to the direction of travel
- that are at least 5 ft (1.5 m) wide
- that are at least 4.3 ft (1.3 m) longer than your vehicle

A parking space is displayed while you are driving past it, and until you are approximately 50 ft (15 m) away from it.

## Parking

### WARNING

The Parking Guidance is only an aid and may not detect all obstacles. The Parking Guidance does not relieve you of the responsibility to pay attention. You are always responsible for safety and must continue to pay attention to your immediate surroundings when parking and maneuvering. Otherwise, you could endanger yourself and others.

- ▶ Stop the vehicle when the parking space symbol shows the desired parking space in the instrument cluster.
- ▶ Shift the transmission to position **R**. The following message appears in the multifunction display: **Check vehicle surroundings Confirm with OK**.
- ▶ Press the **[OK]** button on the multifunction steering wheel to confirm. The multifunction display switches to Parking Guidance.

Depending on your distance from the parking space, the **Please drive backwards** message appears in the multifunction display.

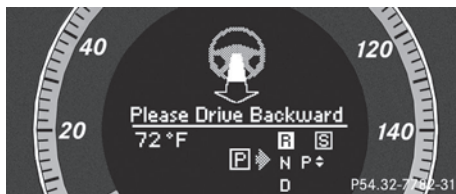

- ▶ If necessary, reverse towards the parking space. This is indicated by an arrow pointing backwards. Continue backing up until you hear a tone. Stop – the parking position has been reached. The arrow is white.

The **Please steer to the right** or **Please steer to the left** message appears in the multifunction display.



- ▶ While the vehicle is stationary, turn the steering wheel in the specified direction until the arrow is white and a warning tone sounds.
- ▶ **To reverse into the parking space:** maintain the steering wheel angle and reverse carefully.
- ▶ Stop as soon as you hear a warning tone. The vehicle has reached the position in which you need to countersteer. The **Please steer to the left** or **Please steer to the right** message appears in the multifunction display.
- ▶ **Countersteering:** while the vehicle is stationary, turn the steering wheel in the specified direction until the arrow is white and a warning tone sounds.

- ▶ **To reverse into the parking space:** maintain the steering wheel angle and reverse carefully.
- ▶ Stop as soon as you hear a warning tone, at the latest when PARKTRONIC sounds the continuous warning tone. The **Parking Guidance finished** message appears in the multifunction display and a warning tone sounds. You may be asked to steer in a different direction and then change gear. In this case, further displays in the multifunction display will direct you to the final position.
- ▶ Maneuver if necessary.
- ▶ Always observe the warning messages displayed by PARKTRONIC (▷ page 193).

### Canceling Parking Guidance

- ▶ Press the PARKTRONIC button on the center console (▷ page 194). Parking Guidance is canceled immediately and PARKTRONIC is deactivated.

Parking Guidance is canceled automatically if it is no longer possible to guide you into the parking space, or if a malfunction occurs.

The parking space symbol goes out and a warning tone sounds. The **Parking Guidance Canceled** message appears in the multifunction display.

### Rear view camera

#### Important safety notes

The rear view camera is an optical parking aid. It shows the area behind your vehicle in the COMAND display.

#### WARNING

Make sure that no persons or animals are in the maneuvering range. Otherwise, they could be injured.

The rear view camera is located in the handle strip of the trunk lid/tailgate.

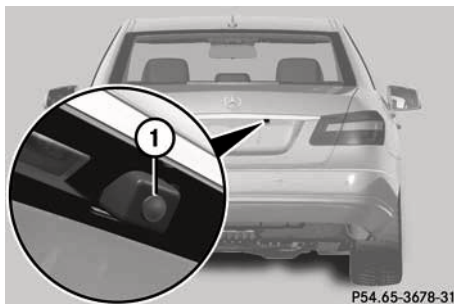

P54.65-3678-31

Example: Sedan

- ① Rear view camera

### View through the camera

The area behind the vehicle is displayed in a mirror-inverted manner, as in the rear-view mirror.

#### WARNING

The rear view camera is only an aid and the obstacle display may:

- show a distorted perspective
- be inaccurate
- not show obstacles at all

The rear view camera does not mean that you are no longer responsible for driving carefully. Be careful and be particularly alert. The rear view camera may not show objects that are:

- very close to the rear bumper
- underneath the rear bumper
- above the trunk handle/tailgate handle

Safety always remains your responsibility, and you must continue paying careful attention to your immediate surroundings when parking and maneuvering. This includes the area behind, in front of and beside the vehicle. You could otherwise endanger yourself or others.

#### WARNING

The rear view camera will not function or will not fully function if:



- the trunk lid/the tailgate is open
- it is raining or snowing strongly or if it is foggy
- it is night or if you are parking/maneuvering your vehicle in a very dark area
- a very bright white light is affecting the camera
- the immediate vicinity is illuminated with fluorescent light (the display of the COMAND system can flicker)
- temperature changes abruptly, for example if you drive out of the cold into a heated garage (condensation on the lens)
- the camera lens is dirty or covered
- the rear of your vehicle is damaged

In this case, have the position and the setting of the camera checked at a specialist workshop. Mercedes-Benz recommends that you consult a Mercedes-Benz Center for this purpose.

Do not use the rear view camera in these situations. You could otherwise injure yourself and other people and/or cause damage - including damage to your vehicle - while parking/maneuvering.

### Activating the rear view camera

- ▶ Make sure that the SmartKey is in position **2** in the ignition lock.
- ▶ Make sure that the "rear view camera" function is selected in COMAND (see the separate operating instructions for COMAND).
- ▶ Engage reverse gear.  
The area behind the vehicle is shown in the COMAND display.

### ATTENTION ASSIST

#### Important safety notes

ATTENTION ASSIST helps you during long, monotonous journeys such as on freeways

and interstate highways. It is active in the range between 50 mph (80 km/h) and 112 mph (180 km/h).

If ATTENTION ASSIST detects typical indicators of fatigue or increasing lapses in concentration on the part of the driver, it suggests you take a break.

#### WARNING

ATTENTION ASSIST is only an aid and may detect your tiredness or lapses in concentration too late or not at all. It is not a substitute for a well-rested and attentive driver.

Fatigue may cause you to recognize hazardous situations too late, misjudge a situation or react more slowly. For this reason, make sure you feel rested before you begin driving and during your journey. Make sure that you take regular breaks in time, particularly on long journeys. Otherwise, you may fail to recognize dangers in time, cause an accident and injure yourself and others.

ATTENTION ASSIST assesses your level of fatigue or lapses in concentration by taking the following criteria into account:

- your personal driving style, e.g. steering characteristics
- driving conditions, e.g. time, driving time

The functionality of ATTENTION ASSIST is restricted and warnings may be delayed or not occur at all:

- if the road condition is poor, e.g. if the surface is uneven or if there are potholes
- if there is a strong side wind
- if you have adopted a sporty driving style with high cornering speeds or high rates of acceleration
- if you predominantly drive at speeds under 50 mph (80 km/h) or over 112 mph (180 km/h)
- if you are currently using COMAND or making a telephone call with it

- if the time has been set incorrectly
- in active driving situations, such as when you change lanes or change your speed

### Warning and display messages in the multifunction display

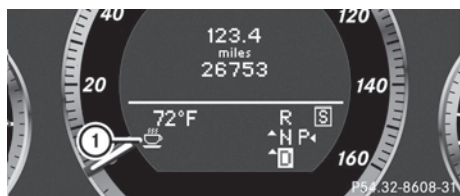

- ▶ Activate ATTENTION ASSIST using the on-board computer (▶ page 225). Symbol ① appears in the multifunction display.

If ATTENTION ASSIST is active, you will be warned no sooner than 20 minutes after your journey has begun. You will then hear an intermittent warning tone twice, and the **Attention Assist: Time for a rest?** message appears in the multifunction display.

- ▶ If necessary, take a break.
- ▶ Press **OK** to confirm the message.

On long journeys, take regular breaks in good time to allow yourself to rest properly. If you do not take a break and ATTENTION ASSIST still detects typical indicators of fatigue or increasing lapses in concentration, you will be warned again after 15 minutes at the earliest. ATTENTION ASSIST is reset when you continue your journey and starts assessing your tiredness again if:

- you switch off the engine.
- you take off your seat belt and open the driver's door, e.g. for a change of drivers or to take a break.

### Night View Assist Plus

#### Important safety notes

In addition to the illumination provided by the normal headlamps, Night View Assist Plus uses infrared light to illuminate the road. The Night View Assist Plus camera picks up the infrared light and displays a grayscale image in the COMAND display. The image displayed in COMAND corresponds to a road lit up by high-beam headlamps. This enables you to see the road's course and any obstacles in good time. If pedestrian recognition is activated, pedestrians recognized by the system are highlighted in the Night View Assist Plus display.

#### WARNING

Night View Assist Plus is only an aid designed to assist driving. It is not a substitute for attentive driving. Do not rely solely on the Night View Assist Plus display. Continue to look through the windshield. You are responsible for safety and must drive in accordance with traffic conditions. You could otherwise put yourself and others in danger. The system may be impaired or unavailable if:

- there is poor visibility, e.g. due to snow, rain, fog or heavy spray.
- the windshield is dirty, fogged up or covered, for instance by a sticker, in the vicinity of the camera.
- you are driving on bends, uphill gradients or downhill gradients.

Light from the headlamps of oncoming vehicles does not affect the Night View Assist Plus display in the multifunction display. This is also the case if you cannot switch on the high-beam headlamps due to oncoming traffic.

#### WARNING

The Night View Assist Plus cannot record objects immediately in front of or next to the vehicle. When maneuvering, continue to look through the windshield. Make sure no

persons or animals are in the area in which you are maneuvering. You could otherwise injure them.

- ① Infrared light is not visible to the human eye and therefore does not glare. Night View Assist Plus can therefore remain switched on even if there is oncoming traffic.

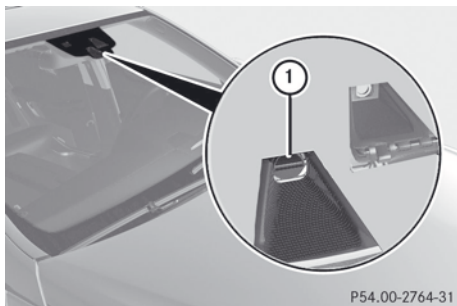

P54.00-2764-31

- ① Night View Assist Plus camera

### Switching on Night View Assist Plus

Depending on your vehicle's date of manufacture, the **A** or **AUTO** symbol for the "Automatic driving lights/daytime running lamps" position is located on the light switch.



P54.25-8134-31

You can only activate Night View Assist Plus if:

- the SmartKey is in position **2** in the ignition lock.
- it is dark.

- the light switch is set to either **A**, **AUTO** or .
- reverse gear has not been engaged.

- ▶ Make sure that COMAND is switched on.
- ▶ Press button ①.

The Night View Assist Plus display appears in the COMAND display.

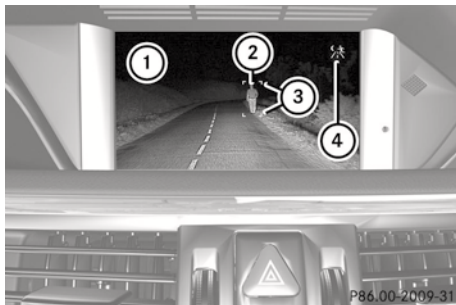

- ① Night View Assist Plus display
- ② Pedestrian recognized
- ③ Framing
- ④ Symbol for active pedestrian recognition

You can read about how to adjust the brightness of the COMAND display in the COMAND operating instructions.

- ① The infrared lamps switch on automatically from a speed of about 6 mph (10 km/h). This means that you do not have the full visual range while the vehicle is stationary and cannot check whether Night View Assist Plus is working.

### Pedestrian recognition

#### WARNING

Pedestrian recognition may be impaired or inoperative if:

- pedestrians are partially or entirely obscured by objects, e.g. parked vehicles.
- the silhouette of the pedestrian in the Night View Assist Plus display is incomplete or interrupted, e.g. by powerful light reflections.

- pedestrians do not contrast with the surroundings.
- pedestrians are not standing upright, for example, if they are sitting, crouching or lying down.

**i** Animals are not recognized by pedestrian recognition.

Night View Assist Plus is able to recognize pedestrians by typical characteristics, e.g. a silhouette in the shape of a person.

Pedestrian recognition is then switched on automatically if:

- Night View Assist Plus is activated.
- you are driving faster than 6 mph (10 km/h).
- the surroundings are dark, e.g. when driving outside built-up areas without street lighting.

If pedestrian recognition is active, symbol **④** appears. If pedestrians are recognized, they are framed **③** and thereby highlighted. If the pedestrian recognition system has brought a pedestrian to your attention, look through the windshield to evaluate the situation. The actual distance to objects and pedestrians cannot be gauged accurately by looking at a screen.

It may be the case that objects are highlighted as well as pedestrians.

### Fogged up or dirty windshield

If the windshield in front of the camera is fogged up or dirty on the inside or outside, the Night View Assist Plus display is affected.

#### **WARNING**

Please do not forget that your primary responsibility is to drive the vehicle. A driver's attention to the road must always be his/her primary focus when driving. For your safety and the safety of others, stop before trying to remove window fogging or cleaning the windshield in front of the Night View Assist Plus camera.

Bear in mind that at a speed of just 30 mph (approximately 50 km/h), your vehicle is covering a distance of 44 feet (approximately 14 m) every second.

- ▶ **To defrost:** check the automatic air conditioning settings (▷ page 138) and fold down the camera cover (▷ page 318).
- ▶ **To defrost the inside of the windshield:** fold down the camera cover (▷ page 318) and clean the windshield (▷ page 317).

## Problems with Night View Assist Plus

Problem	Possible causes/consequences and ► Solutions
The picture quality of Night View Assist Plus has deteriorated.	The windshield wipers are smearing the windshield. ► Replace the wiper blades (▷ page 125).
	The windshield is smeared after the vehicle has been cleaned in a car wash. ► Clean the windshield (▷ page 317).
	There is windshield chip damage in the camera's field of vision. ► Replace the windshield.
	The windshield is fogged up on the inside. ► Defrost the windshield (▷ page 138).
	The windshield is iced up. ► De-ice the windshield (▷ page 138).
	There is dirt on the inside of the windshield. ► Clean the inside of the windshield (▷ page 317).

### Lane Tracking package

#### General notes

The Lane Tracking package consists of Blind Spot Assist (▷ page 203) and Lane Keeping Assist (▷ page 205).

#### Blind Spot Assist

##### Important safety notes

Blind Spot Assist uses a radar sensor system to monitor the areas on both sides of your vehicle. It supports you from speeds of approximately 20 mph (30 km/h). A warning display in the exterior mirrors draws your attention to vehicles detected in the monitored area. If you then switch on the corresponding turn signal to change lane, you will also receive an optical and audible collision warning. Blind Spot Assist uses sensors in the rear bumper for monitoring purposes.

#### WARNING

Blind Spot Assist is only an aid designed to assist driving. It may fail to detect some vehicles and is no substitute for attentive driving.

Blind Spot Assist cannot detect road and traffic conditions. It may fail to detect narrow vehicles, such as motorcycles or bicycles, or may only detect them too late.

Monitoring may be affected by dirty sensors, strong spray or poor visibility caused by snow, rain or mist, for example. In this case, vehicles are detected late or not at all.

Always pay attention to traffic conditions and your surroundings. Otherwise, you may fail to recognize dangers in time, cause an accident and injure yourself and others.

#### USA only:

This device has been approved by the FCC as a “Vehicular Radar System”. The radar sensor is intended for use in an automotive radar system only. Removal, tampering, or

altering of the device will void any warranties, and is not permitted by the FCC. Do not tamper with, alter, or use in any non-approved way.

Any unauthorized modification to this device could void the user's authority to operate the equipment.

For Blind Spot Assist to assist you when driving, the radar sensor system must be activated (▶ page 229) and operational.

### Monitoring range of the sensors

Blind Spot Assist monitors the area shown in the figure up to 10 ft (3 m) behind and immediately adjacent to your vehicle.

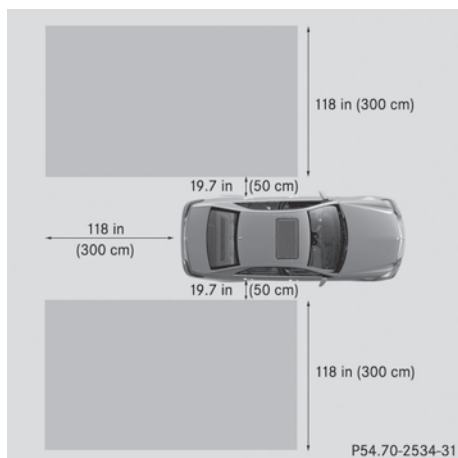

Example: Sedan

### WARNING

Blind Spot Assist monitors certain areas in the immediate vicinity of your vehicle. Vehicles that approach and drive past at high speeds are not detected. There is no display and no warning.

If the lanes are very wide, it may not be possible to monitor the complete width of the neighboring lane. For this reason, vehicles in the next lane may not be detected, especially if they are driving in a staggered formation. This may be the case if vehicles are driving at that edge of their lane which is furthest away from your vehicle.

Always pay attention to traffic conditions and your surroundings. Otherwise, you may fail to recognize dangers in time, cause an accident and injure yourself and others.

If the lanes are narrow, vehicles driving in the lane beyond the lane next to your vehicle may be indicated, especially if the vehicles are not driving in the middle of their lane. This may be the case if the vehicles are driving on the inner side of their lane.

Due to the nature of the system:

- warnings may be issued in error when driving close to crash barriers or similar solid lane borders.
- warnings may be interrupted when driving alongside long vehicles, such as trucks, for a prolonged time.

The two sensors for Blind Spot Assist are integrated into the sides of the rear bumper. Make sure that the bumper is free from dirt, ice or slush around the sensors. The rear sensors must not be covered, for example by bicycle racks or overhanging loads. Following a severe impact or in the event of damage to the bumpers, have the function of the radar sensors checked at a qualified specialist workshop, e.g. an authorized Mercedes-Benz Center. Blind Spot Assist may otherwise not work properly.

### Indicator and warning display

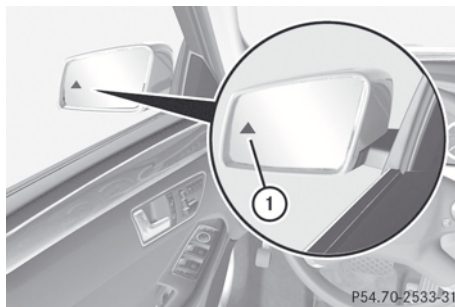

① Yellow indicator lamp/red warning lamp

When Blind Spot Assist is activated, indicator lamp ① lights up yellow in the exterior mirrors up to a vehicle speed of 20 mph

(30 km/h). When the vehicle speed exceeds 20 mph (30 km/h), the indicator lamp goes out and Blind Spot Assist is ready for use.

When your speed exceeds approximately 20 mph (30 km/h), warning lamp ① lights up red on the corresponding side whenever a vehicle is detected in the blind spot monitoring range. This warning is always given when a vehicle enters the blind spot monitoring range from behind or from the side. When you are passing another vehicle, the warning is emitted only if the difference in speed is less than 7 mph (12 km/h).

The yellow indicator lamp goes out if reverse gear is engaged. In this event, Blind Spot Assist is no longer active.

The brightness of the indicator/warning lamps is adjusted automatically according to the ambient light.

#### WARNING

Blind Spot Assist is not active at speeds under approximately 20 mph (30 km/h). The indicator lamps in the exterior mirrors are yellow. Vehicles in the monitoring range are then not indicated.

Always pay attention to traffic conditions and your surroundings. Otherwise, you may fail to recognize dangers in time, cause an accident and injure yourself and others.

#### Collision warning

If a vehicle is detected in the monitoring range of Blind Spot Assist and you switch on the turn signal, a double warning tone sounds. Red warning lamp ① flashes. If the turn signal remains on, detected vehicles are indicated by the flashing of red warning lamp ①. There are no further warning tones.

#### Switching on Blind Spot Assist

- ▶ Make sure that the radar sensor system (▷ page 229) and Blind Spot Assist

(▷ page 225) are activated in the on-board computer.

- ▶ Turn the SmartKey to position **2** in the ignition lock.  
Warning lamps ① light up red in the exterior mirrors for approximately 1.5 seconds and then turn yellow.

#### Lane Keeping Assist

##### Important safety notes

Lane Keeping Assist monitors the area in front of your vehicle by means of a camera at the top of the windshield. Lane Keeping Assist detects lane markings on the road and warns you before you leave your lane unintentionally.

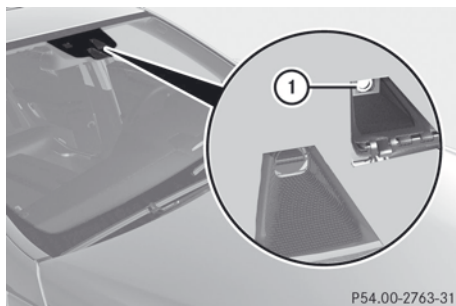

- ① Lane Keeping Assist camera

If you have chosen the **Display Unit Speed-/Odometer** (▷ page 226) function in the on-board computer and select **km** as the unit of measurement, Active Lane Keeping Assist is active from speeds of 60 km/h. If the **miles** display unit is selected, the assistance range begins at 40 mph.

#### WARNING

Lane Keeping Assist does not keep your vehicle in its lane. It is only an aid and may detect the lane markings on the road incorrectly or not at all.



The system may be impaired or may not function if:

- there is poor visibility, e.g. due to insufficient illumination of the road, or due to snow, rain, fog or spray.
- there is glare, e.g. from oncoming traffic, the sun, or reflection from other vehicles.
- the windshield is dirty, fogged up or covered, for instance by a sticker, in the vicinity of the camera.
- several or no lane markings for a single lane are present.
- the lane markings are worn away, dark or covered up, e.g. by dirt or snow.
- the distance to the vehicle in front is too small and the lane markings thus cannot be detected.
- the lane markings on the road are unclear, e.g. near roadworks.
- the lane markings change quickly, e.g. lanes branch off, cross one another or merge.
- the road is narrow and winding.

Lane Keeping Assist cannot detect road and traffic conditions. It is not a substitute for attentive driving. You are responsible for the vehicle's speed, braking in good time, and steering correctly. Always adapt your driving style to suit the prevailing road and weather conditions. Always pay attention to traffic conditions and your surroundings. Otherwise, you may fail to recognize dangers in time, cause an accident and injure yourself and others.

A warning can be given when a front wheel passes over a lane marking. It will warn you by means of intermittent vibration in the steering wheel for up to 1.5 seconds.

In order that you are warned only when necessary and in good time if you cross the lane marking, the system recognizes certain conditions and warns you accordingly.

The warning vibration occurs earlier if:

- you approach the outer lane marking on a bend.
- the road has very wide lanes, e.g. a freeway.
- the system recognizes solid lane markings.

The warning vibration occurs later if:

- the road has narrow lanes.
- you cut the corner on a bend.

No warning vibration occurs if:

- you clearly and actively steer, brake or accelerate.
- you cut the corner on a sharp bend.
- a driving safety system intervenes, e.g. ABS, BAS or ESP®.
- you switch on the turn signals. In this event, the warnings are suppressed for a certain period of time.

### Switching on Lane Keeping Assist



- ▶ Activate Lane Keeping Assist using the on-board computer (▷ page 225). Symbol ① appears in the multifunction display.

If your speed exceeds 40 mph (60 km/h) and lane markings are detected, symbol ① is highlighted. Lane Keeping Assist is ready for use.

### Active Driving Assistance package

#### General notes

The Active Driving Assistance package consists of DISTRONIC PLUS (▷ page 177), Active Blind Spot Assist (▷ page 207) and Active Lane Keeping Assist (▷ page 210).

## Active Blind Spot Assist

### Important safety notes

Active Blind Spot Assist uses a radar sensor system to monitor the side areas of your vehicle which are in back of the driver. A warning display in the exterior mirrors draws your attention to vehicles detected in the monitored area. If you then switch on the corresponding turn signal to change lane, you will also receive an optical and audible collision warning. If a risk of lateral collision is detected, corrective braking may help you avoid a collision. To support the course-correcting brake application, Active Blind Spot Assist also uses the forward-facing radar sensor system. Active Blind Spot Assist supports you from speeds of approximately 20 mph (30 km/h).

#### WARNING

Active Blind Spot Assist is only an aid, and may detect vehicles/obstacles incorrectly or not at all.

The system may be impaired or may not function if:

- there is poor visibility, e.g. due to snow, rain, fog or spray.
- the rear and/or front sensors are dirty.

Active Blind Spot Assist may not detect narrow vehicles, such as motorcycles or bicycles, or may only detect them too late. It cannot detect vehicles that are overtaken at a small distance and then enter the blind spot area.

Active Blind Spot Assist cannot detect road and traffic conditions. It is not a substitute for attentive driving. You are responsible for the vehicle's speed, braking in good time, and steering correctly. Always adapt your driving style to suit the prevailing road and weather conditions. Always pay attention to traffic conditions and your surroundings. Otherwise, you may fail to recognize dangers in time, cause an accident and injure yourself and others.

#### USA only:

This device has been approved by the FCC as a "Vehicular Radar System". The radar sensor is intended for use in an automotive radar system only. Removal, tampering, or altering of the device will void any warranties, and is not permitted by the FCC. Do not tamper with, alter, or use in any non-approved way.

Any unauthorized modification to this device could void the user's authority to operate the equipment.

For Active Blind Spot Assist to assist you when driving, the radar sensor system must be activated (▷ page 229) and operational.

### Monitoring area

Active Blind Spot Assist monitors the area shown in the figure up to 10 ft (3 m) behind and immediately adjacent to your vehicle. For this purpose, Active Blind Spot Assist uses radar sensors in the rear bumper.

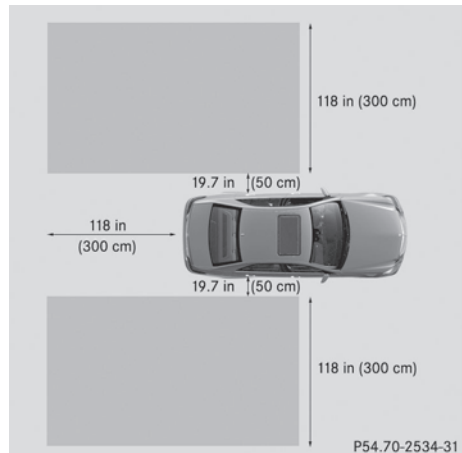

Example: Sedan

#### WARNING

Active Blind Spot Assist monitors certain areas in the immediate vicinity of your vehicle. Vehicles that approach and drive past at high speeds are not detected. No visual nor audible warnings are emitted and the system

does not brake the vehicle to correct your course.

If the lanes are very wide, it may not be possible to monitor the complete width of the neighboring lane. For this reason, vehicles in the next lane may not be detected, especially if they are driving in a staggered formation.

This may be the case if vehicles are driving at that edge of their lane which is furthest away from your vehicle.

Always pay attention to traffic conditions and your surroundings. Otherwise, you may fail to recognize dangers in time, cause an accident and injure yourself and others.

If the lanes are narrow, vehicles driving in the lane beyond the lane next to your vehicle may be indicated, especially if the vehicles are not driving in the middle of their lane. This may be the case if there are vehicles driving at the inner edge of their lanes.

Due to the nature of the system:

- warnings may be issued in error when driving close to crash barriers or similar solid lane borders.
- warnings may be interrupted when driving alongside long vehicles, such as trucks, for a prolonged time.

Two Active Blind Spot Assist radar sensors are integrated into the front and rear bumpers respectively. An additional radar sensor is located behind the cover in the radiator grill. Make sure that the sensor areas on the bumpers and the sensor cover in the radiator grill are free of dirt, ice and slush. The rear sensors must not be covered, for example by cycle racks or overhanging cargo. Following a severe impact or in the event of damage to the bumpers, have the function of the radar sensors checked at a qualified specialist workshop. Blind Spot Assist may otherwise not work properly.

## Indicator and warning display

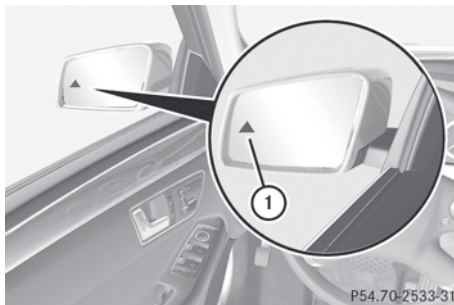

① Yellow indicator lamp/red warning lamp

When Active Blind Spot Assist is activated, indicator lamp ① lights up yellow in the exterior mirrors up to a vehicle speed of 20 mph (30 km/h). When the vehicle speed exceeds 20 mph (30 km/h), the indicator lamp goes out and Active Blind Spot Assist is ready for use.

When your speed exceeds approximately 20 mph (30 km/h), warning lamp ① lights up red on the corresponding side whenever a vehicle is detected in the blind spot monitoring range. This warning is always given when a vehicle enters the blind spot monitoring range from behind or from the side. When you are passing another vehicle, the warning is emitted only if the difference in speed is less than 7 mph (12 km/h).

The yellow indicator lamp goes out if reverse gear is engaged. In this event, Active Blind Spot Assist is no longer active.

The brightness of the indicator/warning lamps is adjusted automatically according to the ambient light.

### WARNING

Active Blind Spot Assist is not active at speeds lower than 20 mph (30 km/h). The indicator lamps in the exterior mirrors are yellow. Vehicles in the monitoring range are then not indicated.

Always pay attention to traffic conditions and your surroundings. Otherwise, you may fail to

recognize dangers in time, cause an accident and injure yourself and others.

### Visual and audible collision warnings

If you switch on the appropriate turn signals and a vehicle is detected in the side monitoring range, you will receive a visual and acoustic collision warning. You will hear a double warning tone and red warning lamp ① flashes. If the turn signal remains on, vehicles detected are indicated by the flashing of red warning lamp ①. There are no further warning tones.

### Course-correcting brake application

If Active Blind Spot Assist detects a risk of a lateral collision in the monitoring range, a course-correcting brake application is carried out. This is meant to assist you in avoiding a collision.

The course-correcting brake application is available in the range between 20 mph (30 km/h) and 120 mph (200 km/h).

If a course-correcting brake application occurs, red warning lamp ① flashes in the exterior mirror and the following is shown in the multifunction display, for example:

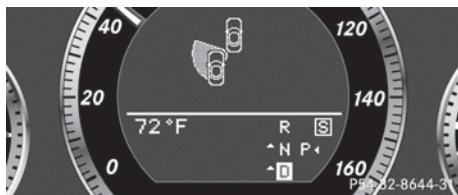

### ⚠ WARNING

Active Blind Spot Assist is only an aid designed to assist driving. It is not a substitute for attentive driving. In some cases, the course-correcting brake application is not sufficient to avoid a collision. In such a case, you must steer, brake or accelerate.

In very rare cases, the system may erroneously detect a danger of collision in the area of crash barriers or similar lane borders and apply the brakes. Active Blind Spot Assist does not detect all traffic situations and road

users. Always make sure that there is sufficient distance on the side for other traffic or obstacles. An inappropriate brake application may be interrupted at any time if you steer slightly in the opposite direction or accelerate.

You are responsible for driving at appropriate speeds, braking in good time, and steering correctly. Always adapt your driving style to suit the prevailing road and weather conditions. Always pay attention to traffic conditions and your surroundings. Otherwise, you may fail to recognize dangers in time, cause an accident and injure yourself and others.

There will be either no or only a weak course-correcting brake application if:

- there are vehicles or obstacles, e.g. crash barriers, located on both sides of your vehicle.
- a vehicle approaches you too closely at the side.
- you have adopted a sporty driving style with high cornering speeds.
- you clearly brake or accelerate.
- a driving safety system intervenes, e.g. ESP® or PRE-SAFE® Brake.
- ESP® is switched off.
- a loss of tire pressure or a defective tire is detected.

### Switching on Active Blind Spot Assist

- ▶ Make sure that the radar sensor system (▷ page 229) and Active Blind Spot Assist (▷ page 225) are activated in the on-board computer.
- ▶ Turn the SmartKey to position **2** in the ignition lock.  
Warning lamps ① light up red in the exterior mirrors for approximately 1.5 seconds and then turn yellow.

## Active Lane Keeping Assist

### Important safety notes

Active Lane Keeping Assist monitors the area in front of your vehicle by means of a camera at the top of the windshield. Active Lane Keeping Assist detects lane markings on the road and warns you before you leave your lane unintentionally. If you do not react to the warning, a lane-correcting application of the brakes can bring the vehicle back into the original lane.

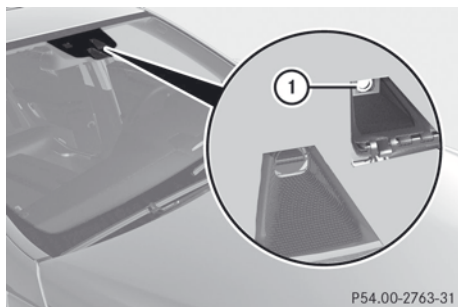

P54.00-2763-31

#### ① Active Lane Keeping Assist camera

If you have selected the **Display Unit Speed-/Odometer** (▷ page 226) function in the on-board computer and select **km** as the unit of measurement, Active Lane Keeping Assist is active from speeds of 60 km/h. If the **miles** display unit is selected, the assistance range begins at 40 mph.

### **⚠ WARNING**

Active Lane Keeping Assist does not keep your vehicle in its lane. It is only an aid and may detect the lane markings on the road incorrectly or not at all.

The system may be impaired or may not function if:

- several or no lane markings for a single lane are present.
- there is poor visibility, e.g. due to insufficient illumination of the road, or due to snow, rain, fog or spray.
- there is glare, e.g. from oncoming traffic, the sun, or reflection from other vehicles.

- the windshield is dirty, fogged up or covered, for instance by a sticker, in the vicinity of the camera.
- the lane markings are worn away, dark or covered up, e.g. by dirt or snow.
- the distance to the vehicle in front is too small and the lane markings thus cannot be detected.
- the lane markings on the road are unclear, e.g. near roadworks.
- the lane markings change quickly, e.g. lanes branch off, cross one another or merge.
- the road is narrow and winding.

Active Lane Keeping Assist cannot detect road and traffic conditions. It is not a substitute for attentive driving. You are responsible for the vehicle's speed, braking in good time, and steering correctly. Always adapt your driving style to suit the prevailing road and weather conditions. Always pay attention to traffic conditions and your surroundings. Otherwise, you may fail to recognize dangers in time, cause an accident and injure yourself and others.

### Warning vibration in the steering wheel

A warning can be given when a front wheel passes over a lane marking. You will be warned by means of intermittent vibration in the steering wheel for up to 1.5 seconds.

In order that you are warned only when necessary and in good time if you cross the lane marking, the system recognizes certain conditions and warns you accordingly.

The warning vibration occurs earlier if:

- you approach the outer lane marking on a bend.
- the road has very wide lanes, e.g. a freeway.
- the system recognizes solid lane markings.

The warning vibration occurs later if:

- the road has narrow lanes.
- you cut the corner on a bend.

No warning vibration occurs if:

- you clearly and actively steer, brake or accelerate.
- you cut the corner on a sharp bend.
- a driving safety system intervenes, e.g. ABS, BAS or ESP®.
- you switch on the turn signals. In this event, the warnings are suppressed for a certain period of time.

### Lane-correcting brake application

If you leave your lane under certain circumstances the vehicle will brake briefly on one side. This is meant to assist you in bringing the vehicle back to the original lane.

This function is available in the range between 40 mph and 120 mph (60 km/h to 200 km/h).

A lane-correcting brake application can only be made after driving over a solid, recognizable lane marking. Before this, a warning must be given by means of intermittent vibration in the steering wheel. In addition, a lane with lane markings on both sides must be recognized. The brake application also slightly reduces vehicle speed.

If a lane-correcting brake application occurs, the following, for example, appears in the multifunction display:



- A further lane-correcting brake application can only occur after your vehicle has returned to the original lane.

### WARNING

Active Lane Keeping Assist does not keep your vehicle in its lane. It is only an aid designed to assist driving. It is not a substitute for attentive driving. In some cases, the lane-

correcting brake application is not sufficient to bring your vehicle back to the original lane. In such cases, you must steer the vehicle yourself to ensure that it does not leave the lane.

Active Lane Keeping Assist does not detect road and traffic conditions. Always make sure that there is sufficient distance to the side for other traffic or obstacles. In rare cases, unclear markings or particular structures on the roadway can be recognized as solid lane markings. An inappropriate brake application, e.g. after intentionally driving over a solid lane marking, may be interrupted at any time by steering slightly in the opposite direction.

Active Lane Keeping Assist cannot take weather conditions into account.

You are responsible for the driving at appropriate speeds, braking in good time, and steering correctly. Always adapt your driving style to suit the prevailing road and weather conditions. Always pay attention to traffic conditions and your surroundings. Otherwise, you may fail to recognize dangers in time, cause an accident and injure yourself and others.

No lane-correcting brake application occurs if:

- you clearly and actively steer, brake or accelerate.
- you cut the corner on a sharp bend.
- you switch on the turn signals.
- a driving safety system intervenes, e.g. ESP®, PRE-SAFE® Brake or Active Blind Spot Assist.
- you have adopted a sporty driving style with high cornering speeds or high rates of acceleration.
- ESP® is switched off.
- the transmission is not in position **D**.
- a loss of tire pressure or a defective tire has been detected and displayed.

Active Lane Keeping Assist does not detect traffic situations or road users. An inappropriate brake application may be interrupted at any time if you:

- steer slightly in the opposite direction.
- use a turn signal.
- clearly brake or accelerate.

A lane-correcting brake application is interrupted automatically if:

- a driving safety system intervenes, e.g. ESP®, PRE-SAFE® Brake or Active Blind Spot Assist.
- lane markings can no longer be recognized.

### Switching on Active Lane Keeping Assist

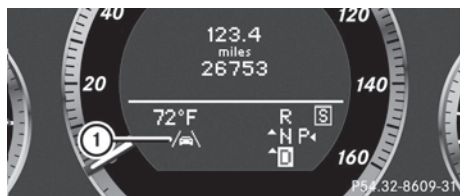

- Switch on Active Lane Keeping Assist using the on-board computer (▷ page 225). Symbol ① appears in the multifunction display.

If your speed exceeds 40 mph (60 km/h) and lane markings are detected, symbol ① is highlighted. Active Lane Keeping Assist is ready for use.



Useful information .....	214
Important safety notes .....	214
Displays and operation .....	214
Menus and submenus .....	218
Display messages .....	234
Warning and indicator lamps in the instrument cluster .....	261

### Useful information

- i** This Operator's Manual describes all models and all standard and optional equipment of your vehicle available at the time of publication of the Operator's Manual. Country-specific differences are possible. Please note that your vehicle may not be equipped with all features described. This also applies to safety-related systems and functions.
- i** Please read the information on qualified specialist workshops (▷ page 25).

### Important safety notes

You will find an illustration of the instrument cluster in the "At a glance" section (▷ page 29).

#### WARNING

A driver's attention to the road and traffic conditions must always be his/her primary focus when driving.

For your safety and the safety of others, selecting features through the multifunction steering wheel should only be done by the driver when traffic and road conditions permit it to be done safely.

Bear in mind that at a speed of just 30 mph (approximately 50 km/h), your vehicle is covering a distance of 44 feet (approximately 14 m) every second.

#### WARNING

No messages will be displayed if either the instrument cluster or the multifunction display is inoperative.

As a result, you will not be able to see information about your driving conditions, such as

- speed
- outside temperature
- warning/indicator lamps

- malfunction/warning messages
- failure of any systems

Driving characteristics may be impaired.

If you must continue to drive, do so with added caution. Contact an authorized Mercedes-Benz Center as soon as possible.

#### WARNING

Malfunction and warning messages are only indicated for certain systems and are intentionally not very detailed. The malfunction and warning messages are simply a reminder with respect to the operation of certain systems. They do not replace the owner's and/or driver's responsibility to maintain the vehicle's operating safety. Have all required maintenance and safety checks performed on the vehicle. Bring the vehicle to an authorized Mercedes-Benz Center to address the malfunction and warning messages.

### Displays and operation

#### Coolant temperature display

#### WARNING

Driving when your engine is overheated can cause some fluids which may have leaked into the engine compartment to catch fire. You could be seriously burned.

Steam from an overheated engine can cause serious burns which can occur just by opening the engine hood. Stay away from the engine if you see or hear steam coming from it.

Stop the vehicle in a safe location away from other traffic. Turn off the engine, get out of the vehicle and do not stand near the vehicle until the engine has cooled down.

The coolant temperature gauge is in the instrument cluster on the right-hand side.

Under normal operating conditions and with the specified coolant level, the coolant temperature may rise to 248 °F (120 °C).

**!** If the coolant temperature is too high a display message is shown.

If the coolant temperature rises above 248 °F(120 °C), do not drive any further as this could damage the engine.

### Tachometer

The red band in the tachometer indicates the engine's overrevving range.

**!** Do not drive in the overrevving range, as this could damage the engine.

The fuel supply is interrupted to protect the engine when the red band is reached.

### Outside temperature display

The outside temperature display is in the multifunction display (▷ page 216).

#### **⚠ WARNING**

The outside temperature indicator is not designed to serve as an ice-warning device and is therefore unsuitable for that purpose. Indicated temperatures just above the freezing point do not guarantee that the road surface is free of ice. The road may still be icy, especially in wooded areas or on bridges.

Changes in the outside temperature are displayed after a short delay.

### Speedometer with segments

The segments in the speedometer indicate which speed range is available.

Cruise control (▷ page 175) activated:

The segments light up from the stored speed to the maximum speed.

DISTRONIC PLUS (▷ page 177) activated:

One or two segments in the set speed range light up.

DISTRONIC PLUS detects a vehicle in front:

The segments between the speed of the vehicle in front and the stored speed light up.

### Operating the on-board computer

#### Overview





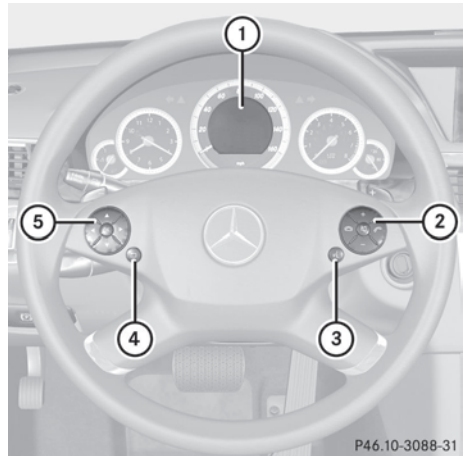

The on-board computer is activated as soon as you turn the SmartKey to position **1** in the ignition lock.

You can control the multifunction display and the settings in the on-board computer using the buttons on the multifunction steering wheel.







- ① Multifunction display
- ② Right control panel
- ③ To switch on the Voice Control System; see the separate operating instructions
- ④ Back button
- ⑤ Left control panel

## Left control panel



	<ul style="list-style-type: none"> <li>• Calls up the menu and menu bar</li> </ul>
	
	<b>Press briefly:</b>
	<ul style="list-style-type: none"> <li>• Scrolls through lists</li> <li>• Selects a submenu or function</li> <li>• In the <b>Audio</b> menu: selects a stored station, an audio track or a video scene</li> <li>• In the <b>Tel</b> (telephone) menu: switches to the phone book and selects a name or telephone number</li> </ul>
	<b>Press and hold:</b>
	<ul style="list-style-type: none"> <li>• In the <b>Audio</b> menu: selects the previous/next station or selects an audio track or a video scene using rapid scrolling</li> <li>• In the <b>Tel</b> (telephone) menu: starts rapid scrolling through the phone book</li> </ul>
	<ul style="list-style-type: none"> <li>• Confirms a selection/display message</li> <li>• In the <b>Tel</b> (telephone) menu: switches to the telephone book and starts dialing the selected number</li> <li>• In the <b>Audio</b> menu: stops the station search function at the desired station</li> </ul>

## Right control panel

	<ul style="list-style-type: none"> <li>• Rejects or ends a call</li> <li>• Exits phone book/redial memory</li> </ul>
	<ul style="list-style-type: none"> <li>• Makes or accepts a call</li> <li>• Switches to the redial memory</li> </ul>

	<ul style="list-style-type: none"> <li>• Adjusts the volume</li> </ul>
	
	<ul style="list-style-type: none"> <li>• Mute</li> </ul>

## Back button



	<b>Press briefly:</b> <ul style="list-style-type: none"> <li>• Back</li> <li>• Switches off the Voice Control System</li> <li>• Hides display messages or calls up the last <b>Trip</b> menu function used</li> <li>• Exits the telephone book/redial memory</li> </ul>
	<b>Press and hold:</b> <ul style="list-style-type: none"> <li>• Calls up the standard display in the <b>Trip</b> menu</li> </ul>

## Multifunction display

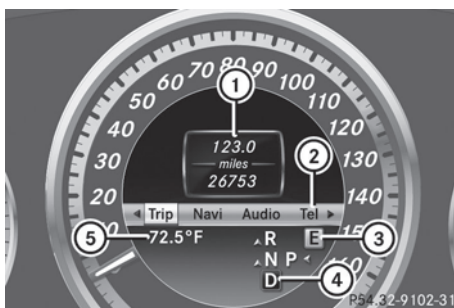





Values and settings as well as display messages are shown in the multifunction display.



- ① Description field
- ② Menu bar
- ③ Drive program
- ④ Transmission position
- ⑤ Outside temperature or speed  
(▷ page 226)

- **To show menu bar ②:** press the  or  button on the steering wheel.

The following messages may appear in the multifunction display:

-  Parking Guidance (▷ page 195)
-  Rear window wiper (▷ page 125)
-  Adaptive Highbeam Assist (▷ page 118)
-  ATTENTION ASSIST (▷ page 199)
-  Lane Keeping Assist (▷ page 205) or Active Lane Keeping Assist (▷ page 210)
- HOLD** HOLD function (▷ page 187)
-  PRE-SAFE® Brake (▷ page 69)

## Menus and submenus

## Menu overview

The number of menus shown depends on the optional equipment in the vehicle.

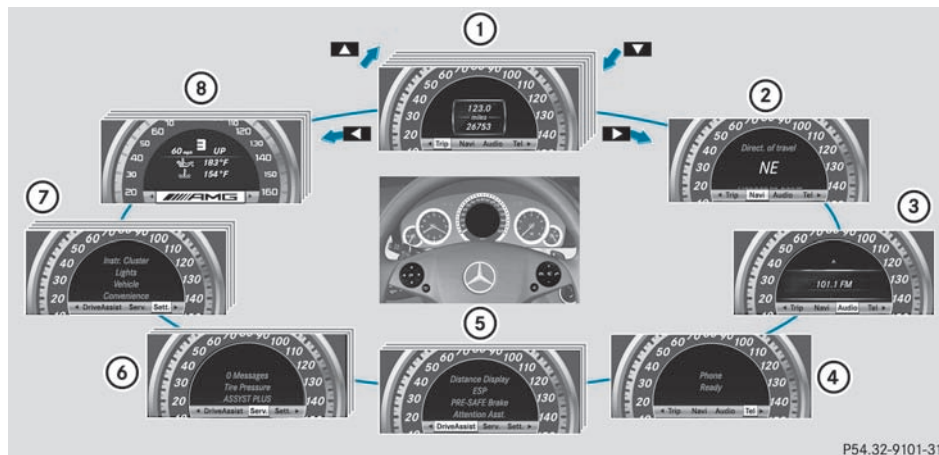

P54.32-9101-31

	Function
①	<a href="#">Trip</a> menu (▷ page 219)
②	<a href="#">Navi</a> menu (navigation instructions) (▷ page 220)
③	<a href="#">Audio</a> menu (▷ page 221)
④	<a href="#">Tel</a> menu (telephone) (▷ page 222)
⑤	<a href="#">DriveAssist.</a> menu (assistance) (▷ page 224)
⑥	<a href="#">Serv.</a> menu (▷ page 226) <ul style="list-style-type: none"> <li>• calls up display messages (▷ page 234)</li> <li>• tire pressure loss warning system (Canada only) (▷ page 353)</li> <li>• tire pressure monitor (▷ page 355)</li> <li>• ASSYST PLUS service interval display (▷ page 312)</li> </ul>
⑦	<a href="#">Sett.</a> menu (▷ page 226)
⑧	<a href="#">AMG</a> menu in AMG vehicles (▷ page 230)

**Trip menu**

**Standard display**

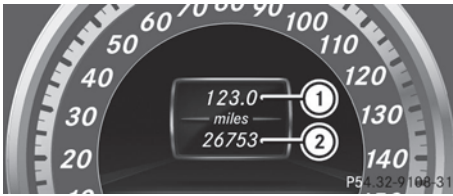

- ▶ Press and hold the button on the steering wheel until the **Trip** menu with odometer ① and trip odometer ② is shown.

**Trip computer "From start" or "From reset"**

The values in the **From Start** submenu are calculated from the start of a journey, while the values in the **From Reset** submenu are calculated from the last time the submenu was reset (▶ page 220).

- ▶ Press the or button on the steering wheel to select the **Trip** menu.
- ▶ Press the or button to select **From Start** or **From Reset**.

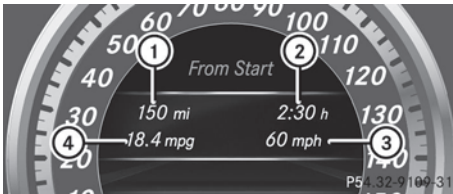

Trip computer "From start" (example)

- ① Distance
- ② Time
- ③ Average speed
- ④ Average fuel consumption

The **From Start** trip computer is reset automatically if:

- the ignition has been switched off for more than four hours.
- 999 hours have been exceeded.
- 9,999 miles have been exceeded.

When 9,999 hours or 99,999 miles have been exceeded, the trip computer is automatically reset **From Reset**.

**Displaying the range and current fuel consumption**

- ▶ Press the or button on the steering wheel to select the **Trip** menu.
- ▶ Press the or button to select current fuel consumption<sup>21</sup> and approximate range.

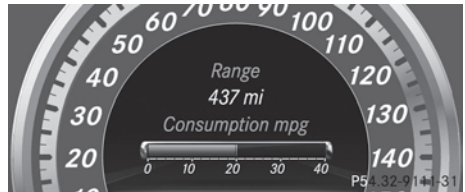

The approximate range that can be covered depends on the fuel level and your current driving style. If there is only a small amount of fuel left in the fuel tank, the display shows a vehicle being refueled instead of the range.

**Digital speedometer**

- ▶ Press the or button on the steering wheel to select the **Trip** menu.
- ▶ Press or to select the digital speedometer.

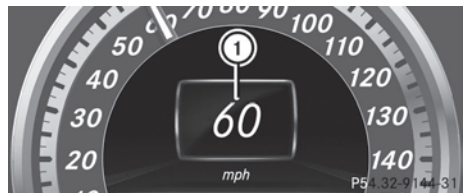





- ① Digital speedometer

<sup>21</sup> Not AMG vehicles.





## Resetting values

You can reset the values of the following functions:

- Trip odometer
- Trip computer "From start"
- Trip computer "From reset"
- ▶ Press the  or  button on the steering wheel to select the **Trip** menu.
- ▶ Press the  or  button to select the function that you wish to reset.
- ▶ Press .





Resetting the trip computer "From start" (example)

- ▶ Press  to select **Yes** and press  to confirm.

## Navigation system menu

### Displaying navigation instructions

In the **Navi** menu, the multifunction display shows navigation instructions. For more information, see the separate operating instructions.

- ▶ Switch on COMAND (see the separate operating instructions).
- ▶ Press the  or  button on the steering wheel to select the **Navi** menu.

## Route guidance inactive

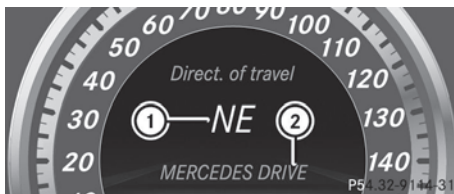

- ① Direction of travel
- ② Current road

## Route guidance active

### No change of direction announced

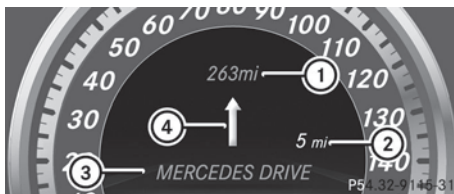

- ① Distance to the destination
- ② Distance to the next change of direction
- ③ Current road
- ④ Symbol for "follow the road's course"

### Change of direction announced without a lane recommendation

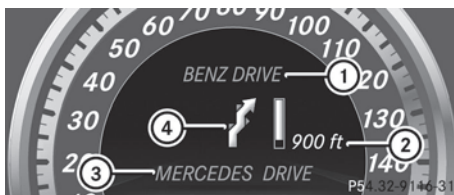

- ① Road into which the change of direction leads
- ② Distance to change of direction and visual distance display
- ③ Current road
- ④ Symbol for change of direction

When a change of direction has been announced, you will see visual distance display ② next to the symbol for change of

direction ④. This decreases in size as you approach the announced change of direction.

### Change of direction announced with a lane recommendation

Lane recommendations are only displayed if the relevant data is available on the digital map.

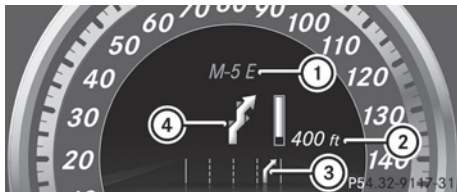

- ① Road into which the change of direction leads
- ② Distance to change of direction and visual distance display
- ③ Lane recommendation
- ④ Symbol for change of direction

On multi-lane roads, lane recommendation ③ may be shown for the next change of direction. Lanes may be added during a change of direction.



Lane recommendation display (example)

- ① Uninterrupted lane
- ② New lane during a change of direction

### Other status indicators of the navigation system

- : you have reached the destination or an intermediate destination.
- **New Route...** or **Calculating Route:** a new route is being calculated.

- **Off Map** or **Off Mapped Road:** the vehicle position is outside the area of the digital map (off-map position).
- **No Route:** no route could be calculated to the selected destination.

### Audio menu

#### Selecting a radio station

- **SIRIUS XM** satellite radio acts like a normal radio.
- For more information on satellite radio operation, see the separate operating instructions.

You can only change the waveband and store new stations using COMAND.

- ▶ Switch on COMAND and select Radio (see the separate operating instructions).
- ▶ Press the or button on the steering wheel to select the **Audio** menu.



- ① Waveband
- ② Station<sup>22</sup>

- ▶ **To select a stored station:** briefly press the or button.
- ▶ **To select a station from the station list:** press and briefly hold the or button.
- ▶ **To select a station using station search<sup>23</sup>:** press and briefly hold the or button.

<sup>22</sup> If the station has been stored, the memory position will also be displayed.

<sup>23</sup> Only if no station list is received.

## Operating audio player or audio media

Audio data from various audio devices or media can be played, depending on the equipment installed in the vehicle.

- ▶ Switch on COMAND and select the audio device or medium (see the separate operating instructions).
- ▶ Press the ◀ or ▶ button on the steering wheel to select the **Audio** menu.



CD changer display (example)

- ① Current track

- ▶ **To select the next/previous track:** briefly press the ▲ or ▼ button.
- ▶ **To select a track from the track list (rapid scrolling):** press and hold the ▲ or ▼ button until the desired track has been reached.

If you press and hold the ▲ or ▼ button, the rapid scrolling speed is increased. Not all audio devices or media support this function.

If track information is stored on the audio device or medium, the multifunction display will show the number and name of the track. The current track does not appear in audio AUX mode (**A**uxiliary audio mode: external audio source connected).

## Operating video DVD

- ▶ Switch on COMAND and select video DVD (see the separate operating instructions).
- ▶ Press the ◀ or ▶ button on the steering wheel to select the **Audio** menu.



DVD changer display (example)

- ① Current scene

- ▶ **To select the next or previous scene:** briefly press the ▲ or ▼ button.
- ▶ **To select a scene from the scene list (rapid scrolling):** press and hold the ▲ or ▼ button until the desired scene has been reached.

## Telephone menu

### Introduction

You can establish a Bluetooth® connection to COMAND (see the separate operating instructions).

### ⚠ WARNING

A driver's attention to the road must always be his/her primary focus when driving. For your safety and the safety of others, we recommend that you pull over to a safe location and stop before placing or taking a telephone call. If you choose to use the telephone while driving, please use the hands-free device and only use the telephone when weather, road and traffic conditions permit. Some jurisdictions prohibit the driver from using a mobile phone while driving a vehicle. Bear in mind that at a speed of just 30 mph (approximately 50 km/h), your vehicle is covering a distance of 44 feet (approximately 14 m) every second.

- ▶ Switch on the mobile phone and COMAND (see the separate operating instructions).
- ▶ Press the ◀ or ▶ button on the steering wheel to select the **Te1** menu.

You will see one of the following display messages in the multifunction display:

- **Telephone Ready** or the name of the network provider: the mobile phone has found a network and is ready to receive.
- **Phone No Service**: no network is available, or the mobile phone is searching for a network.

### Accepting a call

If someone calls you when you are in the **Te1** menu, a display message appears in the multifunction display, for example:

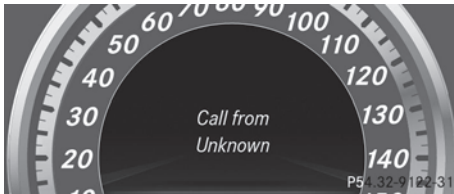

- ▶ Press the  button on the steering wheel to accept an incoming call.

If you are not in the **Te1** menu, you can still accept a call.



### Rejects or ends a call

- ▶ Press the  button on the steering wheel.

If you are not in the **Te1** menu, you can still reject or end a call.



### Dialing a number from the phone book

If your mobile phone is able to receive calls, you can search for and dial a number from the phone book in COMAND at any time.



- ▶ Copy the telephone book of the mobile phone into the audio system or to COMAND (see the separate operating instructions). Copy the telephone book of the mobile phone to COMAND (see the separate operating instructions).
- ▶ Press the  or  button on the steering wheel to select the **Te1** menu.

- ▶ Press the ,  or  button to call up the phone book.



- ▶ Press the  or  button to select the desired name.

To start scrolling rapidly, press and hold the  or  button for longer than one second. After a short time, the rapid scroll speeds up.



Rapid scrolling stops when you release the button or reach the end of the list.

- ▶ **If only one telephone number is stored for a name:** press the  or  button to start dialing.



or

- ▶ **If there is more than one number for a particular name:** press the  or  button to display the numbers.

- ▶ Press the  or  button to select the number you want to dial.



- ▶ Press the  or  button to start dialing.

or

- ▶ **If you do not want to make a call:** press the  or  button.



### Redialing

The on-board computer saves the last names or numbers dialed in the redial memory.



- ▶ Press the  or  button on the steering wheel to select the **Te1** menu.

- ▶ Press the  button to switch to the redial memory.

- ▶ Press the  or  button to select the desired name or number.

- ▶ Press the  or  button to start dialing.

or

- ▶ **If you do not want to make a call:** press the  or  button.

## Assistance menu

### Introduction



In the **DriveAssist** menu you can:

- show the distance display
- activate/deactivate ESP®
- activate/deactivate PRE-SAFE® Brake
- activate/deactivate ATTENTION ASSIST
- activate/deactivate Blind Spot Assist or Active Blind Spot Assist
- activate/deactivate Lane Keeping Assist or Active Lane Keeping Assist

### Showing the distance display

This function is only available with DISTRONIC PLUS.

- ▶ Press the or button on the steering wheel to select the **DriveAssist** menu.
- ▶ Press the or button to select **Distance Display**.
- ▶ Press .

The DISTRONIC PLUS distance display (> page 183) appears in the multifunction display.

## Deactivating/activating ESP®

### WARNING

Never switch off the ESP when you see the ESP warning lamp flashing in the instrument cluster. In this case proceed as follows:

- When driving off, apply as little throttle as possible.
- While driving, ease up on the accelerator pedal.
- Adapt your speed and driving style to the prevailing road conditions.

Failure to observe these guidelines could cause the vehicle to skid. The ESP cannot prevent accidents resulting from excessive speed.

Activating/deactivating ESP® on AMG vehicles (> page 67).

For further information about ESP®, see (> page 66).

- ▶ Start the engine.
- ▶ Press or on the steering wheel to select the **DriveAssist** menu.
- ▶ Press the or button to select **ESP**.
- ▶ Press the button.
- ▶ **To deactivate:** press again. The warning lamp in the instrument cluster comes on.



### WARNING

When the ESP OFF warning lamp lights up, ESP is switched off.

When the ESP warning lamp and the ESP OFF warning lamp are on continuously, ESP is not operational due to a malfunction.







When ESP is switched off or not operational, the vehicle's stability during standard driving maneuvers is reduced.

Adapt your driving style to suit the prevailing road conditions/weather conditions and to the non-operating status of ESP.



- ▶ **To activate:** press  again.  
The  warning lamp in the instrument cluster goes out.

### Activating/deactivating PRE-SAFE® Brake







PRE-SAFE® Brake is only available in vehicles with DISTRONIC PLUS.

- ▶ Press the  or  button on the steering wheel to select the **DriveAssist** menu.
- ▶ Press  or  to select **PRE-SAFE Brake**.
- ▶ Press .  
The current selection is displayed.
- ▶ **To activate/deactivate:** press  again.

When PRE-SAFE® Brake (▷ page 69) is activated, the multifunction display shows the  symbol as long as the HOLD function is not activated (▷ page 187).

**Vehicles with Parking Guidance:** if PARKTRONIC is activated and you are driving at a speed under 22 mph (35 km/h) the  symbol for Parking Guidance is displayed instead of the  symbol.







### Activating/deactivating ATTENTION ASSIST

- ▶ Press the  or  button on the steering wheel to select the **DriveAssist** menu.
- ▶ Press the  or  button to select **Attention Asst..**
- ▶ Press .  
The current selection is displayed.
- ▶ **To activate/deactivate:** press  again.

When ATTENTION ASSIST (▷ page 199) is activated, the  symbol appears in the multifunction display when the ignition is on.







### Activating/deactivating Blind Spot Assist

You can use the **Blind Spot Asst.** function to activate or deactivate Blind Spot Assist (▷ page 203) or Active Blind Spot Assist (▷ page 207).

- ▶ Press  or  on the steering wheel to select the **DriveAssist** menu.
- ▶ Press  or  to select **Blind Spot Asst..**
- ▶ Press .  
If the function is activated, the monitored areas are shown in red in the multifunction display.
- ▶ **To activate/deactivate:** press  again.

### Activating/deactivating Lane Keeping Assist

You can use the **Lane Keep. Asst.** function to activate/deactivate Lane Keeping Assist (▷ page 205) or Active Lane Keeping Assist (▷ page 210).

- ▶ Press the  or  button on the steering wheel to select the **DriveAssist** menu.
- ▶ Press the  or  button to select **Lane Keep. Asst..**
- ▶ Press .  
If the function is activated, the road markings are shown in red in the multifunction display.
- ▶ **To activate/deactivate:** press  again.

If Lane Keeping Assist or Active Lane keeping Assist is activated, the multifunction display shows the  symbol when the ignition is switched on.

## Service menu



In the **Serv.** menu you can:

- call up display messages (▷ page 234)
- restart the tire pressure loss warning system (Canada only) (▷ page 353)
- check the tire pressure electronically (▷ page 355)
- call up the service due date (▷ page 312)

## Settings menu

### Introduction



The **Sett.** menu can be used for:

- changing the instrument cluster settings
- changing the light settings
- changing the vehicle settings
- changing the convenience settings
- restoring the factory settings

### Instrument cluster

#### Selecting the unit of measurement for distance

The **Display Unit Speed-/Odometer:** function allows you to choose whether certain displays appear in kilometers or miles.

The selected unit of measurement for distance applies to:

- the digital speedometer in the **Trip** menu
  - the odometer and the trip odometer
  - the trip computer
  - the current consumption and the range
  - the navigation instruction in the **Navi** menu
  - DISTRONIC PLUS
  - ASSYST PLUS service interval display
- ▶ Press the or button on the steering wheel to select the **Settings** menu.
- ▶ Press the or button to select the **Instr. cluster** submenu.
- ▶ Press the button to confirm.
- ▶ Press the or button to select the **Display Unit Speed-/Odometer** function.
- You will see the selected setting: **km** or **miles**.
- ▶ Press the button to save the setting.

#### Selecting the permanent display function

The **Permanent Display:** function allows you to choose whether the multifunction display always shows the outside temperature or the speed in km/h (USA) or mph (Canada).

- ▶ Press the or button on the steering wheel to select the **Settings** menu.
- ▶ Press the or button to select the **Instr. cluster** submenu.
- ▶ Press the button to confirm.
- ▶ Press the or button to select the **Permanent display** function.
- You will see the selected setting **Outside Temperature** or **Speedometer [km/h]:**.
- ▶ Press the button to save the setting.









## Lights

### Switching the daytime running lamps on/off







This function is not available in Canada.

If you have activated the **Day Lights** function and the light switch is in the **A** or **AUTO** position, the daytime running lamps are switched on automatically during the day when the engine is running.









In the dark, the following also light up:

- the low-beam headlights
  - the parking lamps
  - the tail lamps
  - the license plate lamp
  - the side marker lamps
- ▶ Press the  or  button on the steering wheel to select the **Sett.** menu.
- ▶ Press the  or  button to select the **Lights** submenu.
- ▶ Press the **OK** button to confirm.
- ▶ Press the  or  button to select the **Day Lights** function.
- If the **Daytime Running Lights**: function has been switched on, the cone of light and the  symbol in the multifunction display are shown in red.
- ▶ Press the **OK** button to save the setting.

### Switching Adaptive Highbeam Assist on/off

- ▶ Press the  or  button on the steering wheel to select the **Sett.** menu.
- ▶ Press the  or  button to select the **Lights** submenu.
- ▶ Press the **OK** button to confirm.
- ▶ Press  or  to select the **Adapt. Highbeam** function.
- If the **Adapt. Highbeam** function has been switched on, the cone of light and the  symbol in the multifunction display are shown in red.
- ▶ Press the **OK** button to save the setting.

### Setting the brightness of the ambient lighting

- ▶ Press the  or  button on the steering wheel to select the **Settings** menu.
- ▶ Press the  or  button to select the **Lights** submenu.
- ▶ Press the **OK** button to confirm.
- ▶ Press the  or  button to select **Amb. Light +/-**.
- ▶ Press the **OK** button to confirm.
- ▶ Press the  or  button to adjust the brightness to any level from **Off** to **Level 5** (bright).
- ▶ Press the **OK** or  button to save the setting.









### Activating/deactivating surround lighting and exterior lighting delayed switch-off

If you have activated the **Surround Lighting** function and the light switch is in the **A** or **AUTO** position, the following functions are active when it is dark:

- **Surround lighting:** the exterior lighting remains lit for 40 seconds after unlocking with the key. The exterior lighting switches off when you open the driver's door.
- **Exterior lighting delayed switch-off:** the exterior lighting remains lit for 60 seconds after the engine has been switched off. If you close all the doors, the exterior lighting goes off after 15 seconds.

If you activate the **Surround Lighting** function, the following light up depending on the vehicle's equipment:

- the parking lamps
- the fog lamps
- the daytime running lamps
- the side marker lamps
- the surround lighting in the exterior mirrors

- ▶ Press the  or  button on the steering wheel to select the **Sett.** menu.
- ▶ Press the  or  button to select the **Lights** submenu.
- ▶ Press the  button to confirm.
- ▶ Press the  or  button to select the **Surround Lighting** function.  
When the **Surround Lighting** function is activated, the light cone and the area around the vehicle are displayed in red in the multifunction display.
- ▶ Press the  button to save the setting.









Deactivating delayed switch-off of the exterior lighting temporarily:

- ▶ Before leaving the vehicle, turn the SmartKey to position **0** in the ignition lock.
- ▶ Turn the SmartKey to position **2** in the ignition lock and back to position **0**.  
The exterior lighting delayed switch-off is deactivated.

Delayed switch-off of the exterior lighting is reactivated the next time you start the engine.

### Activating/deactivating the interior lighting delayed switch-off

If you activate the **Light. delay** function, the interior lighting remains on for 20 seconds after you remove the SmartKey from the ignition lock.









- ▶ Press the  or  button on the steering wheel to select the **Settings** menu.
- ▶ Press the  or  button to select the **Lights** submenu.
- ▶ Press the  button to confirm.
- ▶ Press the  or  button to select the **Light. Delay** function.  
When the **Light. Delay** function is activated, the vehicle interior is displayed in red in the multifunction display.
- ▶ Press the  button to save the setting.

## Vehicle

### Activating/deactivating the automatic door locking feature









If you select the **Auto. Door Locks** function, the vehicle is centrally locked above a speed of around 9 mph (15 km/h).

**i** For further information on the automatic locking feature, see (▷ page 83).

- ▶ Press the  or  button on the steering wheel to select the **Settings** menu.
- ▶ Press the  or  button to select the **Vehicle** submenu.
- ▶ Press the  button to confirm.
- ▶ Press the  or  button to select the **Auto. Door Locks** function.  
When the **Auto. Door Locks** function is activated, the vehicle doors are displayed in red in the multifunction display.
- ▶ Press the  button to save the setting.

### Activating/deactivating the acoustic locking verification signal

If you activate the **Acoustic Lock** function, an audible signal sounds depending on the vehicle's date of manufacture:

- when locking  
or
- once when unlocking and three times when locking
- ▶ Press the  or  button on the steering wheel to select the **Settings** menu.
- ▶ Press the  or  button to select the **Vehicle** submenu.
- ▶ Press the  button to confirm.
- ▶ Press the  or  button to select the **Acoustic Lock** function.  
If the **Acoustic Lock** function is activated, the  symbol in the multifunction display lights up red.
- ▶ Press the  button to save the setting.

## Activating/deactivating the radar sensor system

The following systems are switched off when the radar sensor system is deactivated:

- DISTRONIC PLUS (▷ page 177)
- BAS PLUS (▷ page 64)
- PRE-SAFE® Brake (▷ page 69)
- Blind Spot Assist (▷ page 203)
- Active Blind Spot Assist (▷ page 207)

**i** USA only: This device has been approved by the FCC as a "Vehicular Radar System". The radar sensor is intended for use in an automotive radar system only. Removal, tampering, or altering of the device will void any warranties, and is not permitted by the FCC. Do not tamper with, alter, or use in any non-approved way.









Any unauthorized modification to this device could void the user's authority to operate the equipment.

**i** Canada only:

This device complies with RSS-210 of Industry Canada. Operation is subject to the following two conditions:

1. This device may not cause harmful interference, and
2. this device must accept any interference received, including interference that may cause undesired operation.

Any unauthorized modification to this device could void the user's authority to operate the equipment.

- ▶ Press the  or  button on the steering wheel to select the **Settings** menu.
- ▶ Press the  or  button to select the **Vehicle** submenu.
- ▶ Press the  button to confirm.
- ▶ Press the  or  button to select **Radar Sensor (See Oper. Manual):**. You will see the selected setting: **Enabled** or **Disabled**.
- ▶ Press the  button to save the setting.

## Convenience

### Activating/deactivating the EASY-ENTRY/EXIT feature









You can use the **Easy Entry/Exit:** function to activate or deactivate the EASY ENTRY/EXIT feature (▷ page 108).

#### **WARNING**

You must make sure no one can become trapped or injured by the moving steering wheel when the easy-entry/exit feature is activated.





To stop steering wheel movement, move steering wheel adjustment lever or press one of the memory position buttons.



Do not leave children unattended in the vehicle, or with access to an unlocked vehicle. Children could open the driver's door and unintentionally activate the easy-entry/exit feature, which could result in an accident and/or serious personal injury.

- ▶ Press the  or  button on the steering wheel to select the **Sett.** menu.
- ▶ Press the  or  button to select the **Convenience** submenu.
- ▶ Press the  button to confirm.
- ▶ Press the  or  button to select the **Easy Entry/Exit** function. If the **Easy Entry/Exit** function is activated, the vehicle steering wheel is displayed in red in the multifunction display.
- ▶ Press the  button to save the setting.

### Switching the belt adjustment on/off

For further information on belt adjustment (▷ page 54).

- ▶ Press the  or  button on the steering wheel to select the **Settings** menu.
- ▶ Press the  or  button to select the **Convenience** submenu.
- ▶ Press the  button to confirm.









- ▶ Press the  or  button to select the **Belt Adjustment** function. When the **Belt Adjustment** function is activated, the vehicle seat belt is displayed in red in the multifunction display.
- ▶ Press the  button to save the setting.

### Switching the Fold in mirrors when locking function on/off

This function is only available in Canada.





If you switch on the **Auto. Mirror Folding** function, the exterior mirrors fold in when you lock the vehicle. If you unlock the vehicle and then open the driver's or front-passenger door, the exterior mirrors fold out again.





If you have switched the function on and you fold the exterior mirrors in using the button on the door (> page 109), they will not fold out automatically. The exterior mirrors can then only be folded out using the button on the door.

- ▶ Press the  or  button on the steering wheel to select the **Sett.** menu.
- ▶ Press the  or  button to select the **Convenience** submenu.
- ▶ Press the  button to confirm.
- ▶ Press the  or  to select the **Auto. Mirror Folding** function. If the **Auto. Mirror Folding** function is activated, the vehicle's exterior mirror is displayed in red in the multifunction display.
- ▶ Press the  button to save the setting.

### Resetting to factory settings

For safety reasons, the **Day Lights** function in the **Lights** submenu is only reset when the vehicle is stationary.

- ▶ Press the  or  button on the steering wheel to select the **Settings** menu.
- ▶ Press the  or  button to select the **Factory Setting** submenu.

- ▶ Press the  button to confirm. The **Reset All Settings?** message appears.
- ▶ Press the  or  button to select **No** or **Yes**.
- ▶ Press the  button to confirm the selection. If you select **Yes**, the multifunction display shows a confirmation message.

### AMG menu in AMG vehicles

#### AMG displays

- ▶ Press  or  on the steering wheel to select the **AMG** menu.

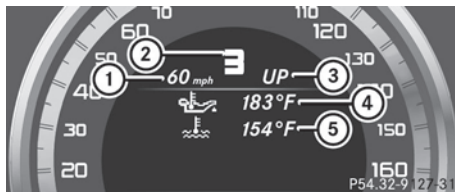

- ① Digital speedometer
- ② Gear indicator
- ③ Upshift indicator
- ④ Engine oil temperature
- ⑤ Coolant temperature

Upshift indicator **UP** ③ indicates that the engine has reached the overrevving range when in the manual gearshift program. Upshift indicator **UP** ③ fades out other messages until you have shifted up.

When the engine oil temperature is below 80 °C, the oil temperature is shown in blue. Avoid driving at full engine output during this time.

### SETUP

SETUP shows the drive program, the ESP® (Electronic Stability Program) mode and the SPORT handling mode.

- ▶ Press or on the steering wheel to select the **AMG** menu.
- ▶ Press the button repeatedly until **SETUP** is displayed.

or

- ▶ Briefly press the AMG button on the center console.

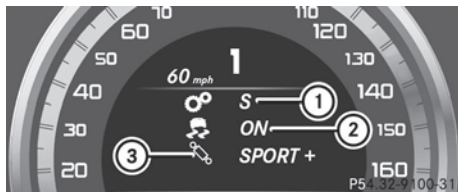

- ① Drive program (**C/S/S+/M**)
- ② ESP® mode (**ON/OFF**) or SPORT handling mode (**SPORT**)
- ③ Suspension tuning (**COMFORT/SPORT/SPORT+**)

## RACETIMER

### Displaying and starting RACETIMER

#### **WARNING**

The RACETIMER feature is only for use on roads and in conditions where high speed driving is permitted. Racing on public roads is prohibited under all circumstances. The driver is and must always remain responsible for following posted speed limits.

You can use the RACETIMER to store lap times.

- ▶ Press or on the steering wheel to select the **AMG** menu.
- ▶ Press the button repeatedly until the RACETIMER is shown.

- ① If RACETIMER is selected, the menu bar cannot be called up with the and buttons.

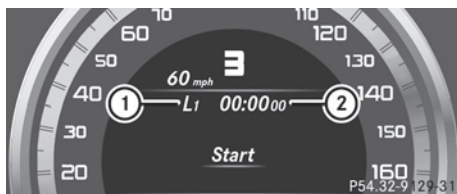

- ① Lap
- ② RACETIMER

You can start the RACETIMER when the engine is running or if the SmartKey is in position **2** in the ignition lock.

- ▶ **To start:** press the button to start the RACETIMER.

### Displaying the intermediate time



- ▶ Press or to select **Interm. Time**.
- ▶ Press the button to confirm. The intermediate time is displayed for five seconds.

### Starting a new lap

It is possible to store a maximum of sixteen laps.

- ▶ Press to confirm **New Lap**.

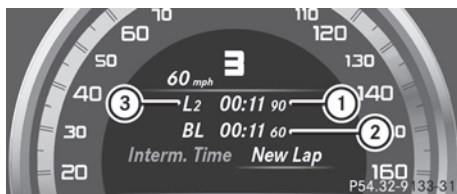

- ① RACETIMER
- ② Fastest lap time (best lap)
- ③ Lap

### Stopping the RACETIMER

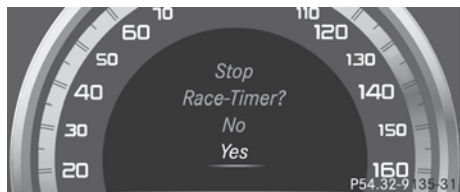

- ▶ Press the  button on the steering wheel.



- ▶ Press  to confirm **YES**.

The RACETIMER interrupts timing when you stop the vehicle and turn the SmartKey to position **1** in the ignition lock. When you turn the SmartKey to position **2** or **3** and then press the  to confirm **Start**, timing is continued.

### Resetting the current lap

- ▶ Stop the RACETIMER.
- ▶ Press  or  to select **Reset Lap**.
- ▶ Press  to reset the lap time to "0".



### Deleting all laps

If you switch off the engine, the RACETIMER is reset to "0" after 30 seconds. All laps are deleted.

You cannot delete individual stored laps. If you have stopped 16 laps, the current lap does not have to be reset.



- ▶ Reset the current lap.
- ▶ Press  to confirm **Reset**. **Reset Race Timer?** appears in the multifunction display.



- ▶ Press the  button to select **Yes** and press the  button to confirm. All laps are deleted.

### Overall evaluation

This function is shown if you have stored at least one lap and stopped the RACETIMER.

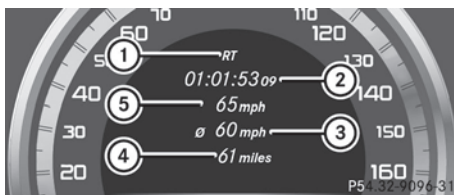

- ▶ Press  or  on the steering wheel to select the **AMG** menu.
- ▶ Press the  button repeatedly until the overall evaluation is shown.



- ① RACETIMER overall evaluation
- ② Total time driven
- ③ Average speed
- ④ Distance covered
- ⑤ Top speed

### Lap evaluation

This function is only available if you have stored at least two laps and have stopped the RACETIMER.

- ▶ Press  or  on the steering wheel to select the **AMG** menu.
- ▶ Press the  button repeatedly until the lap evaluation is shown. Each lap is shown in a separate submenu. The fastest lap is indicated by flashing symbol ①.

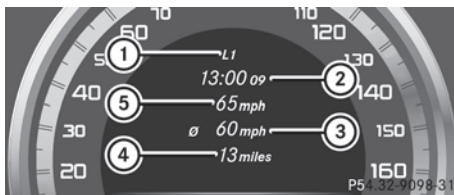

- ① Lap
- ② Lap time
- ③ Average lap speed

- ④ Lap length
- ⑤ Top speed during lap
- ▶ Press the  or  button to select a different lap evaluation.



## Display messages

### General notes

#### WARNING

All categories of messages contain important information which should be taken note of and, where a malfunction is indicated, addressed as soon as possible at an authorized Mercedes-Benz Center.

Failure to repair the condition noted may cause damage not covered by the Mercedes-Benz Limited Warranty, or result in property damage or personal injury.

Display messages appear in the multifunction display.

Display messages with graphic displays may be shown in simplified form in the Operator's Manual and may differ from the messages shown in the multifunction display.



Please respond in accordance with the display messages and follow the additional notes in this Operator's Manual.

Certain display messages are accompanied by an audible warning tone or a continuous tone.

When you stop and park the vehicle, please observe the notes on the HOLD function (▷ page 187) and parking (▷ page 167).

### Hiding display messages

You can hide some display messages with a low priority.







- ▶ Press the  or  button on the steering wheel to hide the display message.  
The display message is cleared.

Display messages with a high priority are shown in red.

You cannot hide display messages of the highest priority. The multifunction display shows these messages continuously until the causes for the messages have been remedied.

### Message memory

The on-board computer saves certain display messages. You can call up the display messages in the **message memory**.

- ▶ Press the  or  button on the steering wheel to select the **Serv.** menu.  
If there are display messages, the multifunction display shows, for example, **2 Messages**.
- ▶ Press the  or  button to select the entry, e.g. **2 Messages**.
- ▶ Confirm with .
- ▶ Press the  or  button to scroll through the display messages.

When the ignition is switched off, all display messages are deleted apart from some high-priority display messages. Once the causes of the high-priority display messages have been rectified, the corresponding display messages are also deleted.

## Safety systems

## Display messages





Currently  
Unavailable See  
Operator's Manual

## Possible causes/consequences and ► Solutions

 **Risk of accident**

ABS, ESP<sup>®</sup>, BAS, PRE-SAFE<sup>®</sup>, the HOLD function and hill start assist are temporarily unavailable.

BAS PLUS and PRE-SAFE<sup>®</sup> Brake may also have failed.

In addition, the ,  and  warning lamps light up in the instrument cluster.

For example, the on-board voltage may be insufficient.

ATTENTION ASSIST is deactivated.

The brake system continues to function normally, but without the functions listed above. The wheels could therefore lock if you brake hard, for example.

► Drive on carefully.

If the display message disappears, the functions mentioned above are available again.

If the display message continues to be displayed:

► Drive on carefully.

► Visit a qualified specialist workshop.







Inoperative See  
Operator's Manual

 **Risk of accident**

ABS, ESP<sup>®</sup>, BAS, PRE-SAFE<sup>®</sup>, the HOLD function and hill start assist are unavailable due to a malfunction.

BAS PLUS and PRE-SAFE<sup>®</sup> Brake may also have failed.









The **BRAKE** (USA only)/ , ,  and  warning lamps in the instrument cluster also light up.







The brake system continues to function normally, but without the functions listed above. The wheels could therefore lock if you brake hard, for example.

ATTENTION ASSIST is deactivated.

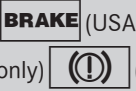
► Drive on carefully.

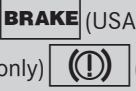
► Visit a qualified specialist workshop immediately.



Display messages	Possible causes/consequences and ► Solutions
 <p data-bbox="79 225 295 284">Inoperative See Operator's Manual</p>	<p data-bbox="348 177 566 209"><b>⚠ Risk of accident</b></p> <p data-bbox="337 220 1003 277">ESP®, BAS, PRE-SAFE®, the HOLD function and hill start assist are unavailable due to a malfunction.</p> <p data-bbox="337 288 897 316">BAS PLUS and PRE-SAFE® Brake may also have failed.</p> <p data-bbox="337 323 960 381">In addition, the  and  warning lamps light up in the instrument cluster.</p> <p data-bbox="337 389 695 416">ATTENTION ASSIST is deactivated.</p> <p data-bbox="337 424 1003 481">The brake system continues to function normally, but without the functions listed above.</p> <ul data-bbox="337 489 736 555" style="list-style-type: none"> <li>► Drive on carefully.</li> <li>► Visit a qualified specialist workshop.</li> </ul>
  <p data-bbox="79 681 295 740">Inoperative See Operator's Manual</p>	<p data-bbox="348 580 566 612"><b>⚠ Risk of accident</b></p> <p data-bbox="337 624 1003 715">EBD (electronic brake force distribution), ABS, ESP®, BAS, PRE-SAFE®, the HOLD function and hill start assist are unavailable due to a malfunction.</p> <p data-bbox="337 722 897 750">BAS PLUS and PRE-SAFE® Brake may also have failed.</p> <p data-bbox="337 758 986 815">In addition, the ,  and  warning lamps light up in the instrument cluster and a warning tone sounds.</p> <p data-bbox="337 823 695 850">ATTENTION ASSIST is deactivated.</p> <p data-bbox="337 858 1003 949">The brake system continues to function normally, but without the functions listed above. The wheels could therefore lock if you brake hard, for example.</p> <ul data-bbox="337 957 866 1023" style="list-style-type: none"> <li>► Drive on carefully.</li> <li>► Visit a qualified specialist workshop immediately.</li> </ul>
 <p data-bbox="79 1099 273 1158">Check Brake Pad Wear</p>	<p data-bbox="337 1046 889 1074">The brake pads/linings have reached their wear limit.</p> <ul data-bbox="337 1082 736 1114" style="list-style-type: none"> <li>► Visit a qualified specialist workshop.</li> </ul>





Display messages	Possible causes/consequences and ► Solutions
 <p><b>BRAKE</b> (USA only)  (Canada only) Release Parking Brake</p>	<p>You are driving with the parking brake applied. A warning tone also sounds.</p> <ul style="list-style-type: none"> <li>► Release the parking brake.</li> </ul>
 <p><b>BRAKE</b> (USA only)  (Canada only) Check Brake Fluid Level</p>	<p> <b>Risk of accident</b></p> <p>There is not enough brake fluid in the brake fluid reservoir. Additionally, the red <b>BRAKE</b> (USA only) /  (Canada only) warning lamp lights up in the instrument cluster and a warning tone sounds.</p> <ul style="list-style-type: none"> <li>► Pull over and stop the vehicle safely as soon as possible, paying attention to road and traffic conditions. Do not continue driving under any circumstances.</li> <li>► Engage the parking brake.</li> <li>► Consult a qualified specialist workshop.</li> <li>► Do not add brake fluid. This will not rectify the malfunction.</li> </ul>













 **WARNING**

Driving with the message **Check Brake Fluid Level** displayed can result in an accident. Have your brake system checked immediately.

Do not add brake fluid before checking the brake system. Overfilling the brake fluid reservoir can result in spilling brake fluid on hot engine parts and the brake fluid catching fire. You can be seriously burned.

Display messages	Possible causes/consequences and ► Solutions
 <p><b>SOS</b> Tele Aid Inoperative</p>	<p>USA only: one or more of the main functions in the mbrace system are malfunctioning.</p> <p>Canada only: one or more of the main functions of the TELEAID system are malfunctioning.</p> <ul style="list-style-type: none"> <li>► USA only: have the mbrace system checked at a qualified specialist workshop.</li> <li>► Canada only: have the TELEAID system checked at a qualified specialist workshop.</li> </ul>
<p>PRE-SAFE Inoperative See Operator's Manual</p>	<p> <b>Risk of injury</b></p> <p>Important functions of PRE-SAFE® have failed. All other occupant safety systems, e.g. air bags, remain available.</p> <ul style="list-style-type: none"> <li>► Visit a qualified specialist workshop immediately.</li> </ul>

Display messages	Possible causes/consequences and ► Solutions
<p>PRE-SAFE Function Currently Limited See Oper. Manual</p>	<p> <b>Risk of accident</b></p> <p>PRE-SAFE® Brake is temporarily inoperative if:</p> <ul style="list-style-type: none"> <li>• the DISTRONIC PLUS cover in the radiator grill is dirty.</li> <li>• the sensors in the bumpers are dirty.</li> <li>• its function is impaired due to heavy rain or snow.</li> <li>• the radar sensor system is temporarily inoperative, e.g. due to electromagnetic radiation emitted by nearby TV or radio stations or other sources of electromagnetic radiation.</li> <li>• you switch off ESP® (AMG vehicles only).</li> <li>• the system is outside the operating temperature range.</li> <li>• the on-board voltage is too low.</li> </ul> <p>PRE-SAFE® Brake is operational again and the display message disappears if:</p> <ul style="list-style-type: none"> <li>• the dirt (e.g. slush) drops away while the vehicle is in motion.</li> <li>• the system detects that the sensors are fully available again.</li> <li>• you switch ESP® on again (AMG vehicles only).</li> <li>• the system is within the operating temperature range.</li> </ul> <p>If the display message continues to be displayed:</p> <ul style="list-style-type: none"> <li>► Clean the DISTRONIC PLUS cover in the radiator grill (&gt; page 317).</li> <li>► Clean the bumpers (&gt; page 317).</li> <li>► Restart the engine.</li> <li>► Wait until the battery is sufficiently charged.</li> </ul>
<p>PRE-SAFE Functions Limited See Operator's Manual</p>	<p> <b>Risk of accident</b></p> <p>PRE-SAFE® Brake is defective. BAS PLUS or the distance warning signal may also have failed.</p> <ul style="list-style-type: none"> <li>► Visit a qualified specialist workshop.</li> </ul>
<p> SRS Malfunction Service Required</p>	<p> <b>Risk of injury</b></p> <p>There is a malfunction in the SRS (Supplemental Restraint System). The  warning lamp also lights up in the instrument cluster.</p> <ul style="list-style-type: none"> <li>► Visit a qualified specialist workshop.</li> </ul>

Display messages	Possible causes/consequences and ► Solutions
 <p>Front Left Malfunction Service Required or Front Right Malfunction Service Required</p>	<p> <b>Risk of injury</b></p> <p>SRS has malfunctioned at the front on the left or right. The  warning lamp also lights up in the instrument cluster.</p> <p>► Visit a qualified specialist workshop.</p>
 <p>Rear Left Malfunction Service Required or Rear Right Malfunction Service Required</p>	<p> <b>Risk of injury</b></p> <p>SRS has malfunctioned at the rear on the left or right. The  warning lamp also lights up in the instrument cluster.</p> <p>► Visit a qualified specialist workshop.</p>
 <p>Rear Center SRS Malfunction Service Required</p>	<p> <b>Risk of injury</b></p> <p>SRS has malfunctioned at the rear center. The  warning lamp also lights up in the instrument cluster.</p> <p>► Visit a qualified specialist workshop.</p>
 <p>Left Side Curtain Airbag Malfunction Service Required or Right Side Curtain Airbag Malfunction Service Required</p>	<p> <b>Risk of injury</b></p> <p>There is a malfunction in the left-hand and/or right-hand window curtain air bag. The  warning lamp also lights up in the instrument cluster.</p> <p>► Visit a qualified specialist workshop.</p>

 **WARNING**

In the event a malfunction of the SRS is indicated as outlined above, the SRS may not be operational.

For your safety, we strongly recommend that you contact an authorized Mercedes-Benz Center immediately to have the system checked. Otherwise the SRS may not be activated when needed in an accident, which could result in serious or fatal injury, or it might deploy unexpectedly and unnecessarily which could also result in injury.

## Display messages

Front Passenger  
Airbag Enabled  
See Operator's  
Manual

## Possible causes/consequences and ► Solutions

The front-passenger air bag is enabled during the journey, even though:

- a child, a small adult or an object weighing less than the system's weight threshold is located on the front-passenger seat.
- the front-passenger seat is unoccupied.

The system may detect objects or forces applying additional weight on the seat.

- Pull over and stop the vehicle safely as soon as possible, paying attention to road and traffic conditions.
- Engage the parking brake.
- Switch off the ignition.
- Open the front-passenger door.
- Remove the child and the child restraint system from the front-passenger seat.
- If necessary, secure the child in a child restraint system on a suitable rear seat.
- Make sure that there are no objects on the seat adding to the weight.

The system may otherwise detect the additional weight and interpret the seat occupant's weight as greater than it actually is.

- Keep the seat unoccupied, close the front-passenger door and switch on the ignition.

Observe the  **PASSE AIR BAG OFF** (> page 44) indicator lamp and the multifunction display and check the following:

Seat unoccupied and ignition switched on:

- the  **PASSE AIR BAG OFF** indicator lamp must light up and remain lit. When the indicator lamp is on, OCS (> page 44) has deactivated the front-passenger air bag.
- the [Front Passenger Airbag Enabled See Operator's Manual](#) or [Front Passenger Airbag Disabl'd See Operator's Manual](#) display messages must not appear in the multifunction display. Wait for a period of at least 60 seconds until the necessary system checks have been completed and to make sure that the display messages do not appear in the multifunction display.



If these conditions are fulfilled, the front-passenger seat can be occupied again. Whether the  **PASSE AIR BAG OFF** indicator lamp remains lit or goes out depends on how OCS classifies the occupant.







If the conditions are not fulfilled, the system is not operating correctly.



Display messages	Possible causes/consequences and ► Solutions
	► Visit a qualified specialist workshop immediately.

### WARNING

If the   indicator lamp remains off even after performing the above corrective steps, do not have any children 12 years old and under and other small individuals use the front-passenger seat until the system has been repaired.





Display messages	Possible causes/consequences and ► Solutions
<p>Front Passenger Airbag Disabl'd See Operator's Manual</p>	<p>The front-passenger air bag is deactivated during the journey even though an adult or a person larger than a certain size is occupying the front-passenger seat. If additional forces are applied to the seat, the system may interpret the occupant's weight as lower than it actually is.</p> <ul style="list-style-type: none"> <li>► Pull over and stop the vehicle safely as soon as possible, paying attention to road and traffic conditions.</li> <li>► Engage the parking brake.</li> <li>► Switch off the ignition.</li> <li>► Have the occupant get out of the vehicle.</li> <li>► Keep the seat unoccupied, close the front-passenger door and switch on the ignition.</li> </ul> <p>Observe the   (► page 44) indicator lamp and the multifunction display and check the following: Seat unoccupied and ignition switched on:</p> <ul style="list-style-type: none"> <li>• the   indicator lamp must light up and remain lit. When the indicator lamp is on, OCS (► page 44) has deactivated the front-passenger air bag.</li> <li>• the <a href="#">Front Passenger Airbag Enabled See Operator's Manual</a> or <a href="#">Front Passenger Airbag Disabled See Operator's Manual</a> display messages must not appear in the multifunction display. Wait for a period of at least 60 seconds until the necessary system checks have been completed and to make sure that the display messages do not appear in the multifunction display.</li> </ul> <p>If these conditions are fulfilled, the front-passenger seat can be occupied again. Whether the   indicator lamp remains lit or goes out depends on how OCS classifies the occupant.</p> <p>If the conditions are not fulfilled, the system is not operating correctly.</p> <ul style="list-style-type: none"> <li>► Visit a qualified specialist workshop immediately.</li> </ul>







 **WARNING**







If the  indicator lamp remains lit with an adult occupant on the front-passenger seat even after performing the above corrective steps, do not have any passenger use the front-passenger seat until the system has been repaired.



**Lights**
 Display messages about LEDs:

This display message will only appear if all LEDs have failed.

Display messages	Possible causes/consequences and ► Solutions
 Check Left Cornering Light or Check Right Cornering Light	<p>The left or right-hand cornering light is defective.</p> <ul style="list-style-type: none"> <li>► Check whether you are permitted to change the bulb yourself (▷ page 121).</li> </ul> <p>or</p> <ul style="list-style-type: none"> <li>► Visit a qualified specialist workshop.</li> </ul>
 Check Left Low Beam or Check Right Low Beam	<p>The left or right-hand low-beam headlamp is defective.</p> <ul style="list-style-type: none"> <li>► Check whether you are permitted to change the bulb yourself (▷ page 121).</li> </ul> <p>or</p> <ul style="list-style-type: none"> <li>► Visit a qualified specialist workshop.</li> </ul>
 Check Rear Left Turn Signal or Check Rear Right Turn Signal	<p>The rear left-hand or rear right-hand turn signal is defective.</p> <ul style="list-style-type: none"> <li>► Check whether you are permitted to change the bulb yourself (▷ page 121).</li> </ul> <p>or</p> <ul style="list-style-type: none"> <li>► Visit a qualified specialist workshop.</li> </ul>
 Check Front Left Turn Signal or Check Front Right Turn Signal	<p>The front left-hand or front right-hand turn signal is defective.</p> <ul style="list-style-type: none"> <li>► Check whether you are permitted to change the bulb yourself (▷ page 121).</li> </ul> <p>or</p> <ul style="list-style-type: none"> <li>► Visit a qualified specialist workshop.</li> </ul>

Display messages	Possible causes/consequences and ► Solutions
 <p>Check Left Mirror Turn Signal or Check Right Mirror Turn Signal</p>	<p>The turn signal in the left-hand or right-hand exterior mirror is defective.</p> <ul style="list-style-type: none"> <li>► Check whether you are permitted to change the bulb yourself (▷ page 121).</li> </ul> <p>or</p> <ul style="list-style-type: none"> <li>► Visit a qualified specialist workshop.</li> </ul>
 <p>Check Center Brake Lamp</p>	<p>The high-mounted brake lamp is faulty.</p> <ul style="list-style-type: none"> <li>► Check whether you are permitted to change the bulb yourself (▷ page 121).</li> </ul> <p>or</p> <ul style="list-style-type: none"> <li>► Visit a qualified specialist workshop.</li> </ul>
 <p>Check Left Tail and Brake Lamps or Check Right Tail and Brake Lamps</p>	<p>The left or right-hand tail lamp/brake lamp is defective.</p> <ul style="list-style-type: none"> <li>► Check whether you are permitted to change the bulb yourself (▷ page 121).</li> </ul> <p>or</p> <ul style="list-style-type: none"> <li>► Visit a qualified specialist workshop.</li> </ul>
 <p>Check Left High Beam or Check Right High Beam</p>	<p>The left or right-hand high beam is defective.</p> <ul style="list-style-type: none"> <li>► Check whether you are permitted to change the bulb yourself (▷ page 121).</li> </ul> <p>or</p> <ul style="list-style-type: none"> <li>► Visit a qualified specialist workshop.</li> </ul>
 <p>Check Left License Plate Lamp or Check Right License Plate Lamp</p>	<p>The left or right-hand license plate lamp is defective.</p> <ul style="list-style-type: none"> <li>► Check whether you are permitted to change the bulb yourself (▷ page 121).</li> </ul> <p>or</p> <ul style="list-style-type: none"> <li>► Visit a qualified specialist workshop.</li> </ul>
 <p>Check Left Fog Lamp or Check Right Fog Lamp</p>	<p>The left-hand or right-hand front fog lamp is defective.</p> <ul style="list-style-type: none"> <li>► Check whether you are permitted to change the bulb yourself (▷ page 121).</li> </ul> <p>or</p> <ul style="list-style-type: none"> <li>► Visit a qualified specialist workshop.</li> </ul>

Display messages	Possible causes/consequences and ► Solutions
 <p>Rear Fog Lamp</p>	<p>The rear fog lamp is defective.</p> <ul style="list-style-type: none"> <li>► Check whether you are permitted to change the bulb yourself (▷ page 121).</li> </ul> <p>or</p> <ul style="list-style-type: none"> <li>► Visit a qualified specialist workshop.</li> </ul>
 <p>Check Front Left Parking Lamp or Check Front Right Parking Lamp</p>	<p>The front left or front right parking or standing lamp is defective.</p> <ul style="list-style-type: none"> <li>► Check whether you are permitted to change the bulb yourself (▷ page 121).</li> </ul> <p>or</p> <ul style="list-style-type: none"> <li>► Visit a qualified specialist workshop.</li> </ul>
 <p>Check Left Reverse Lamp or Check Right Reverse Lamp</p>	<p>The left or right-hand backup lamp is defective.</p> <ul style="list-style-type: none"> <li>► Check whether you are permitted to change the bulb yourself (▷ page 121).</li> </ul> <p>or</p> <ul style="list-style-type: none"> <li>► Visit a qualified specialist workshop.</li> </ul>
 <p>Check Front Left Sidemarker Lamp or Check Front Right Sidemarker Lamp</p>	<p>The left or right front side marker lamp is defective.</p> <ul style="list-style-type: none"> <li>► Check whether you are permitted to change the bulb yourself (▷ page 121).</li> </ul> <p>or</p> <ul style="list-style-type: none"> <li>► Visit a qualified specialist workshop.</li> </ul>
 <p>Check Rear Left Sidemarker Lamp or Check Rear Right Sidemarker Lamp</p>	<p>The rear left or right side marker lamp is defective.</p> <ul style="list-style-type: none"> <li>► Check whether you are permitted to change the bulb yourself (▷ page 121).</li> </ul> <p>or</p> <ul style="list-style-type: none"> <li>► Visit a qualified specialist workshop.</li> </ul>
 <p>Check Left Daytime Running Light or Check Right Daytime Running Light</p>	<p>The left or right-hand daytime running lamp is defective.</p> <ul style="list-style-type: none"> <li>► Check whether you are permitted to change the bulb yourself (▷ page 121).</li> </ul> <p>or</p> <ul style="list-style-type: none"> <li>► Visit a qualified specialist workshop.</li> </ul>
 <p>Active Headlamps Inoperative</p>	<p>The active light function is defective.</p> <ul style="list-style-type: none"> <li>► Visit a qualified specialist workshop.</li> </ul>

Display messages	Possible causes/consequences and ► Solutions
 <p>Malfunction See Operator's Manual</p>	<p>The exterior lighting is defective.</p> <p>► Visit a qualified specialist workshop.</p>
 <p>AUTO Lamp Function Inoperative</p>	<p>The light sensor is defective.</p> <p>► Visit a qualified specialist workshop.</p>
 <p>Switch Off Lights</p>	<p>The lights are still switched on when you leave the vehicle. A warning tone also sounds.</p> <p>► Turn the light switch to <b>A</b> or <b>AUTO</b>.</p>
<p>Adaptive Highbeam Assist Inoperative</p>	<p>Adaptive Highbeam Assist is defective.</p> <p>► Visit a qualified specialist workshop.</p>
<p>Adaptive Highbeam Assist Currently Unavailable See Operator's Manual</p>	<p>Adaptive Highbeam Assist is deactivated and temporarily inoperative, if:</p> <ul style="list-style-type: none"> <li>• the windshield is dirty in the camera's field of vision.</li> <li>• visibility is impaired due to heavy rain, snow or fog.</li> </ul> <p>► Clean the windshield.</p> <p>Adaptive Highbeam Assist is available again, if:</p> <ul style="list-style-type: none"> <li>• the dirt (e.g. slush) drops away while the vehicle is in motion.</li> <li>• the system recognizes that the camera is fully operational again.</li> </ul> <p>The display message <b>Adaptive Highbeam Assist Now Available</b> is shown.</p>

## Engine

Display messages	Possible causes/consequences and ► Solutions
 <p>Check Coolant Level See Operator's Manual</p>	<p>The coolant level is too low.</p> <p>► Add coolant, observing the warning notes when doing so (► page 311).</p> <p>► If coolant needs to be added more often than usual, have the engine coolant system checked at a qualified specialist workshop.</p>

### WARNING

Do not spill antifreeze on hot engine parts. Antifreeze contains ethylene glycol which may burn if it comes into contact with hot engine parts. You could be seriously burned.

**!** The coolant level is too low. Avoid making long journeys with too little coolant in the cooling system. The engine will otherwise be damaged.

The display messages and the corresponding symbol that indicate that the coolant level is too low must not be ignored.

Display messages	Possible causes/consequences and ► Solutions
 <p data-bbox="78 359 302 446">Coolant Level Low Stop Vehicle Turn Engine Off</p>	<p data-bbox="336 311 560 335">The coolant is too hot.</p> <ul style="list-style-type: none"> <li data-bbox="336 343 1002 406">▶ Pull over and stop the vehicle safely and switch off the engine, paying attention to road and traffic conditions.</li> <li data-bbox="336 406 1002 470">▶ Make sure that the air supply to the engine radiator is not blocked, e.g. by snow, slush or ice.</li> <li data-bbox="336 470 1002 534">▶ Wait until the display message disappears before restarting the engine. Otherwise, there is a risk of engine damage.</li> <li data-bbox="336 534 1002 566">▶ Pay attention to the coolant temperature display.</li> <li data-bbox="336 566 1002 630">▶ If the temperature increases again, visit a qualified specialist workshop immediately.</li> </ul> <p data-bbox="336 654 649 678">The poly-V-belt may have torn.</p> <ul style="list-style-type: none"> <li data-bbox="336 694 1002 758">▶ Pull over and stop the vehicle safely and switch off the engine, paying attention to road and traffic conditions.</li> <li data-bbox="336 758 1002 790">▶ Open the hood.</li> <li data-bbox="336 790 1002 821">▶ Check whether the poly-V-belt is torn.</li> </ul> <p data-bbox="336 829 604 853"><b>If the poly-V-belt is torn:</b></p> <ul style="list-style-type: none"> <li data-bbox="336 869 1002 901"><b>!</b> Do not continue driving. The engine could otherwise overheat.</li> <li data-bbox="336 917 1002 949">▶ Consult a qualified specialist workshop.</li> </ul> <p data-bbox="336 957 705 981"><b>If the poly-V-belt is not damaged:</b></p> <ul style="list-style-type: none"> <li data-bbox="336 997 1002 1061">▶ Wait until the display message disappears before restarting the engine. Otherwise, there is a risk of engine damage.</li> <li data-bbox="336 1061 1002 1093">▶ Pay attention to the coolant temperature display.</li> <li data-bbox="336 1093 1002 1125">▶ Visit a qualified specialist workshop.</li> </ul>



### **WARNING**

Driving when your engine is overheated can cause some fluids which may have leaked into the engine compartment to catch fire. You could be seriously burned.

Steam from an overheated engine can cause serious burns which can occur just by opening the engine hood. Stay away from the engine if you see or hear steam coming from it.

Stop the vehicle in a safe location away from other traffic. Turn off the engine, get out of the vehicle and do not stand near the vehicle until the engine has cooled down.

**!** If the coolant temperature exceeds 248 °F (120 °C) do not continue driving. The engine will otherwise be damaged.









Display messages	Possible causes/consequences and ► Solutions
	<p>The engine fan is defective.</p> <ul style="list-style-type: none"> <li>► At coolant temperatures under 248 °F (120 °C), drive to the next qualified specialist workshop.</li> <li>► Avoid subjecting the engine to heavy loads, e.g. driving in mountainous terrain, and stop-and-go traffic.</li> </ul>
	<p>The battery is not being charged.</p> <p>Possible causes are:</p> <ul style="list-style-type: none"> <li>• a defective alternator</li> <li>• a torn poly-V-belt</li> <li>• a malfunction in the electronics</li> </ul> <ul style="list-style-type: none"> <li>► Pull over and stop the vehicle safely and switch off the engine, paying attention to road and traffic conditions.</li> <li>► Open the hood.</li> <li>► Check whether the poly-V-belt is torn.</li> </ul> <p><b>If the poly-V-belt is torn:</b></p> <ul style="list-style-type: none"> <li>! Do not continue driving. The engine could otherwise overheat.</li> <li>► Consult a qualified specialist workshop.</li> </ul> <p><b>If the poly-V-belt is not damaged:</b></p> <ul style="list-style-type: none"> <li>► Visit a qualified specialist workshop.</li> </ul>
 <p>Check Engine Oil At Next Refueling</p>	<p>The engine oil level has dropped to the minimum level. A warning tone also sounds.</p> <ul style="list-style-type: none"> <li>► Check the engine oil level at the latest when next refueling (▷ page 309).</li> <li>► If necessary, add engine oil (▷ page 310).</li> <li>► If engine oil needs to be added more often than usual, have the engine checked at a qualified specialist workshop.</li> </ul>





Information on approved engine oils can be obtained from any qualified specialist workshop or on the Internet at <http://www.mbusa.com> (USA only).



**!** The oil level is too low. Avoid long journeys with too little engine oil. There is a risk of engine damage.



The display messages and the corresponding symbol that indicate that the oil level is too low must not be ignored.



Display messages	Possible causes/consequences and ► Solutions
 <p>Fuel Level Low</p>	<p>The fuel level has dropped into the reserve range.</p> <ul style="list-style-type: none"> <li>► Refuel at the nearest gas station.</li> </ul>
	<p>There is only a very small amount of fuel in the fuel tank.</p> <ul style="list-style-type: none"> <li>► Refuel at the nearest gas station without fail.</li> </ul>
 <p>Gas Cap Loose</p>	<p>The fuel system pressure is too low. The fuel filler cap is not closed correctly or the fuel system is leaking.</p> <ul style="list-style-type: none"> <li>► Check that the fuel filler cap is correctly closed.</li> </ul> <p><b>If the fuel filler cap is not correctly closed:</b></p> <ul style="list-style-type: none"> <li>► Close the fuel filler cap.</li> </ul> <p><b>If the fuel filler cap is correctly closed:</b></p> <ul style="list-style-type: none"> <li>► Visit a qualified specialist workshop.</li> </ul>
 <p>Ultra Low-sulfur Diesel Fuel Only</p>	<p>Vehicles with a diesel engine: the fuel level has fallen below the reserve range.</p> <ul style="list-style-type: none"> <li>► Refuel at the nearest gas station.</li> <li>► Only use commercially available vehicular ULTRA-LOW SULFUR HIGHWAY DIESEL FUEL (ULSD, 15 ppm SULFUR MAXIMUM).</li> </ul>
 <p>Replace Air Filter</p>	<p>Vehicles with a diesel engine: the engine air filter is dirty and must be replaced.</p> <ul style="list-style-type: none"> <li>► Visit a qualified specialist workshop.</li> </ul>
 <p>Check Fuel Filter</p>	<p>Vehicles with a diesel engine: there is water in the fuel filter. The water must be drained off.</p> <ul style="list-style-type: none"> <li>► Visit a qualified specialist workshop.</li> </ul>
 <p>Check Additive See Operator's Manual</p>	<p>The DEF tank is empty.</p> <ul style="list-style-type: none"> <li>► Have the DEF tank filled as soon as possible at a qualified specialist workshop (► page 165).</li> </ul>
 <p>Remaining Starts: 16</p>	<p>The DEF level has fallen to a minimum.</p> <ul style="list-style-type: none"> <li>► Have the DEF tank filled immediately at a qualified specialist workshop. (► page 165)</li> </ul>

Driving systems	
Display messages	Possible causes/consequences and ► Solutions
 Attention Assist: Pause!	<p>Based on specific criteria, ATTENTION ASSIST has determined that the driver is tired or paying less attention. A warning tone also sounds.</p> <ul style="list-style-type: none"> <li>► If necessary, take a break.</li> </ul> <p>During long journeys, take regular breaks in good time so you get enough rest.</p>
 Attention Assist Inoperative	<p>ATTENTION ASSIST has failed.</p> <ul style="list-style-type: none"> <li>► Visit a qualified specialist workshop.</li> </ul>
 Vehicle Rising	<p>Your vehicle is adjusting to the level you have selected.</p>
 Vehicle Rising Please Wait	<p>The vehicle level is too low when the vehicle is stationary. A warning tone also sounds.</p> <ul style="list-style-type: none"> <li>► Do not pull away. The vehicle level is set when the display message disappears.</li> </ul>
 Pull Over Car Too Low	<p>You have pulled away while the vehicle level is still too low. AIRMATIC sets the vehicle to the selected level after a short period.</p> <ul style="list-style-type: none"> <li>► Pull over and stop the vehicle safely as soon as possible, paying attention to road and traffic conditions.</li> <li>► Apply the parking brake.</li> <li>► Wait until the display message disappears before pulling away.</li> </ul> <p><b>⚠ Risk of accident</b></p> <p>AIRMATIC is defective. A warning tone also sounds.</p> <ul style="list-style-type: none"> <li>► Do not drive faster than 50 mph (80 km/h).</li> <li>► Make only slight steering movements. Otherwise, the front fender or the tires could be damaged if the steering movement is too large.</li> <li>► Listen for scraping sounds.</li> <li>► Pull over and stop the vehicle safely, paying attention to road and traffic conditions, and select a higher vehicle level. Depending on the malfunction, it may be possible to raise the vehicle.</li> <li>► Visit a qualified specialist workshop.</li> </ul>

Display messages	Possible causes/consequences and ► Solutions
 <p>Malfunction</p>	<p> <b>Risk of accident</b></p> <p>The AIRMATIC function is restricted. The vehicle's handling characteristics may be affected.</p> <ul style="list-style-type: none"> <li>► Do not drive faster than 50 mph (80 km/h).</li> <li>► Visit a qualified specialist workshop.</li> </ul>
<p>HOLD Off</p>	<p>The HOLD function is deactivated. The vehicle is skidding. A warning tone also sounds.</p> <ul style="list-style-type: none"> <li>► Reactivate the HOLD function later (► page 187).</li> </ul> <p>The HOLD function is deactivated. When the brake pedal is firmly depressed, an activation condition is not fulfilled. A warning tone also sounds.</p> <ul style="list-style-type: none"> <li>► Check the activation conditions for the HOLD function (► page 187).</li> </ul>
<p>Radar Sensors Deactivated See Operator's Manual</p>	<p>The radar sensor system is deactivated.</p> <ul style="list-style-type: none"> <li>► Switch on the radar sensor system (► page 229).</li> </ul>
<p>Lane Keeping Assist Currently Unavailable. See Operator's Manual or Lane Keeping Assist Currently Unavailable. See Operator's Manual</p>	<p>Lane Keeping Assist or Active Lane Keeping Assist is deactivated and temporarily inoperative if:</p> <ul style="list-style-type: none"> <li>• the windshield is dirty in the camera's field of vision.</li> <li>• visibility is impaired due to heavy rain, snow or fog.</li> <li>• there are no lane markings for a longer period.</li> <li>• the lane markings are worn, dark or covered, for example by dirt or snow.</li> </ul> <p>Lane Keeping Assist or Active Lane Keeping Assist is operational again and the display message disappears if:</p> <ul style="list-style-type: none"> <li>• the dirt (e.g. slush) drops away while the vehicle is in motion.</li> <li>• the system recognizes that the camera is fully operational again.</li> </ul> <p>If the display message continues to be displayed:</p> <ul style="list-style-type: none"> <li>► Clean the windshield.</li> </ul>
<p>Lane Keeping Assist Inoperative or Active Lane Keeping Assist Inoperative</p>	<p>Lane Keeping Assist or Active Lane Keeping Assist is defective.</p> <ul style="list-style-type: none"> <li>► Visit a qualified specialist workshop.</li> </ul>

Display messages	Possible causes/consequences and ► Solutions
<p>Blind Spot Assist Currently Unavailable See Operator's Manual or Active Blind Spot Assist Currently Unavailable See Operator's Manual</p>	<p>Blind Spot Assist or Active Blind Spot Assist is temporarily inoperative if:</p> <ul style="list-style-type: none"> <li>• the sensors are dirty.</li> <li>• its function is impaired due to heavy rain or snow.</li> <li>• the radar sensor system is outside the operating temperature range.</li> <li>• the radar sensor system is temporarily inoperative, e.g. due to electromagnetic radiation emitted by nearby TV or radio stations or other sources of electromagnetic radiation.</li> </ul> <p>The yellow  indicator lamps also light up in the exterior mirrors.</p> <p>Blind Spot Assist or Active Blind Spot Assist is operational again and the display message disappears if:</p> <ul style="list-style-type: none"> <li>• the dirt (e.g. slush) drops away while the vehicle is in motion.</li> <li>• the system detects that the sensors are fully available again.</li> <li>• the radar sensor system is back within the operating temperature range.</li> </ul> <p>If the display message continues to be displayed:</p> <ul style="list-style-type: none"> <li>► Clean the sensors (▷ page 317).</li> <li>► Restart the engine.</li> </ul>
<p>Blind Spot Assist Inoperative or Active Blind Spot Assist Inoperative</p>	<p>Blind Spot Assist or Active Blind Spot Assist is defective.</p> <p>The yellow  indicator lamps also light up in the exterior mirrors.</p> <ul style="list-style-type: none"> <li>► Visit a qualified specialist workshop.</li> </ul>
<p>Parking Guidance Inoperative</p>	<p>Parking Guidance is malfunctioning (▷ page 195).</p> <ul style="list-style-type: none"> <li>► Restart the engine.</li> </ul> <p>If the display message continues to be displayed:</p> <ul style="list-style-type: none"> <li>► Visit a qualified specialist workshop.</li> </ul>

Display messages	Possible causes/consequences and ► Solutions
<b>Parking Guidance Canceled</b>	<p>Parking Guidance has been deactivated because:</p> <ul style="list-style-type: none"> <li>• the vehicle is skidding.</li> <li>• the sensors are dirty.</li> <li>• a malfunction has occurred.</li> </ul> <p>A warning tone also sounds.</p> <p>► Reactivate Parking Guidance later (▷ page 195).</p> <p>If the parking space symbol is not displayed in the multifunction display when you are driving at a speed of less than 19 mph (30 km/h):</p> <ul style="list-style-type: none"> <li>► Clean the sensors (▷ page 317).</li> <li>► Restart the engine.</li> </ul> <p>If the parking space symbol is still not displayed in the multifunction display when you are driving at a speed of less than 19 mph (30 km/h):</p> <ul style="list-style-type: none"> <li>► Visit a qualified specialist workshop.</li> </ul> <p>Parking Guidance has been deactivated because you are no longer following the recommended path.</p> <ul style="list-style-type: none"> <li>► Park again and, while doing so, observe the display messages in the multifunction display.</li> </ul>
<b>Parking Guidance Finished</b>	<p>The vehicle is parked. A warning tone also sounds.</p> <p>The display message disappears automatically.</p>
<b>DISTRONIC PLUS Off</b>	<p>DISTRONIC PLUS has been deactivated (▷ page 177). If it was deactivated automatically, a warning tone also sounds.</p>
<b>DISTRONIC PLUS Now Available</b>	<p>DISTRONIC PLUS is operational again after having been temporarily unavailable. You can now reactivate DISTRONIC PLUS (▷ page 177).</p>

Display messages	Possible causes/consequences and ► Solutions
<p><b>DISTRONIC PLUS</b> Currently Unavailable See Operator's Manual</p>	<p>DISTRONIC PLUS is deactivated and is temporarily inoperative if:</p> <ul style="list-style-type: none"> <li>• the DISTRONIC PLUS cover in the radiator grill is dirty.</li> <li>• its function is impaired due to heavy rain or snow.</li> <li>• the sensors in the bumpers are dirty.</li> <li>• the radar sensor system is temporarily inoperative, e.g. due to electromagnetic radiation emitted by nearby TV or radio stations or other sources of electromagnetic radiation.</li> <li>• the system is outside the operating temperature range.</li> <li>• the on-board voltage is too low.</li> </ul> <p>A warning tone also sounds.</p> <p>DISTRONIC PLUS is operational again and the display message disappears if:</p> <ul style="list-style-type: none"> <li>• the dirt (e.g. slush) drops away while the vehicle is in motion.</li> <li>• the system detects that the sensors are fully available again.</li> <li>• the system is within the operating temperature range.</li> </ul> <p>If the display message continues to be displayed:</p> <ul style="list-style-type: none"> <li>► Clean the DISTRONIC PLUS cover in the radiator grill (▷ page 317).</li> <li>► Clean the bumpers (▷ page 317).</li> <li>► Restart the engine.</li> </ul>
<p><b>DISTRONIC PLUS</b> Inoperative</p>	<p>DISTRONIC PLUS is defective. BAS PLUS (Brake Assist PLUS) and PRE-SAFE® Brake may be inoperative as well.</p> <p>A warning tone also sounds.</p> <ul style="list-style-type: none"> <li>► Visit a qualified specialist workshop.</li> </ul>
<p><b>DISTRONIC PLUS</b> Override</p>	<p>You have depressed the accelerator pedal. DISTRONIC PLUS is no longer controlling the speed of the vehicle.</p> <ul style="list-style-type: none"> <li>► Take your foot off the accelerator pedal.</li> </ul>
<p><b>DISTRONIC PLUS</b> --- mph</p>	<p>An activation condition for DISTRONIC PLUS is not fulfilled.</p> <ul style="list-style-type: none"> <li>► Check the activation conditions for DISTRONIC PLUS (▷ page 177).</li> </ul>

Display messages	Possible causes/consequences and ► Solutions
Cruise Control Inoperative	Cruise control is defective. A warning tone also sounds. ► Visit a qualified specialist workshop.
Cruise Control --- mph	A condition for activating cruise control has not been fulfilled. You attempted to save a speed of less than 20 mph (30 km/h). ► If the situation allows, drive faster than 20 mph (30 km/h) and save the speed. ► Check the activation conditions for cruise control (► page 175).

## Tires

### WARNING

Do not drive with a flat tire. A flat tire affects the ability to steer or brake the vehicle. You may lose control of the vehicle. Continued driving with a flat tire will cause excessive heat build-up and possibly a fire.

### WARNING





Follow recommended tire inflation pressures.



Do not underinflate tires. Underinflated tires wear excessively and/or unevenly, adversely affect handling and fuel economy, and are more likely to fail from being overheated.

Do not overinflate tires. Overinflated tires can adversely affect handling and ride comfort, wear unevenly, increase stopping distance, and result in sudden deflation (blowout) because they are more likely to become punctured or damaged by road debris, potholes etc.









Display messages	Possible causes/consequences and ► Solutions
<p>Check Tire Pressure Soon</p>	<p> <b>Risk of accident</b></p> <p>The tire pressure loss warning system has detected a significant loss in pressure.</p> <p>A warning tone also sounds.</p> <ul style="list-style-type: none"> <li>► Stop the vehicle without making any sudden steering or braking maneuvers. Pay attention to the traffic conditions as you do so.</li> <li>► Check the tires and, if necessary, change the wheel (▷ page 370).</li> <li>► Check the tire pressures and, if necessary, set to the correct tire pressure.</li> <li>► Restart the tire pressure loss warning system when the tire pressure is correct (▷ page 353).</li> </ul>
<p>Check Tire Pressure Then Restart Run Flat Indicator</p>	<p>The tire pressure loss warning system generated a display message and has not been restarted since.</p> <ul style="list-style-type: none"> <li>► Set the correct tire pressure in all four tires.</li> <li>► Restart the tire pressure loss warning system (▷ page 353).</li> </ul>
<p>Run Flat Indicator Inoperative</p>	<p>The tire pressure loss warning system is defective.</p> <ul style="list-style-type: none"> <li>► Visit a qualified specialist workshop.</li> </ul>
<p>Tire pressures will be displayed after driving a few minutes</p>	<p>The tire pressure monitor is measuring the tire pressure.</p> <ul style="list-style-type: none"> <li>► Drive on.</li> </ul> <p>The tire pressures appear in the multifunction display after you have been driving for a few minutes.</p>
<p>Tire Press. Monitor Inoperative</p>	<p>The tire pressure monitor is defective.</p> <ul style="list-style-type: none"> <li>► Visit a qualified specialist workshop.</li> </ul>
<p>Tire Press. Monitor Inoperative No Wheel Sensors</p>	<p>The wheels mounted do not have a suitable tire pressure sensor. The tire pressure monitor is deactivated.</p> <ul style="list-style-type: none"> <li>► Mount wheels with suitable tire pressure sensors.</li> </ul> <p>The tire pressure monitor is activated automatically after driving for a few minutes.</p>



Display messages	Possible causes/consequences and ► Solutions
Check Tires	<p> <b>Risk of accident</b></p> <p>The tire pressure in one or more tires has dropped significantly. The wheel position is displayed in the multifunction display. A warning tone also sounds.</p> <ul style="list-style-type: none"> <li>► Stop the vehicle without making any sudden steering or braking maneuvers. Pay attention to the traffic conditions as you do so.</li> <li>► Correct the tire pressure (▷ page 355).</li> <li>► If necessary, change a wheel (▷ page 370).</li> </ul>
Caution: Tire Malfunction	<p> <b>Risk of accident</b></p> <p>The tire pressure in one or more tires has dropped suddenly. The wheel position is displayed in the multifunction display.</p> <ul style="list-style-type: none"> <li>► Stop the vehicle without making any sudden steering or braking maneuvers. Pay attention to the traffic conditions as you do so.</li> <li>► If necessary, change a wheel (▷ page 370).</li> </ul>
Correct Tire Pressure	<p>The tire pressure is too low in at least one of the tires or the tire pressure difference between the wheels is too great.</p> <ul style="list-style-type: none"> <li>► Check the tire pressures at the next opportunity. If necessary, correct the tire pressure (▷ page 355).</li> <li>► Restart the tire pressure monitor (▷ page 357).</li> </ul>
Tire Press. Sensor(s) Missing	<p>There is no signal from the tire pressure sensor of one or several wheels. The pressure of the affected tire is not displayed in the multifunction display.</p> <ul style="list-style-type: none"> <li>► Have the defective tire pressure sensor replaced at a qualified specialist workshop.</li> </ul>
Tire Press. Monitor Currently Unavail.	<p>Due to a source of radio interference, no signals can be received from the wheel sensors. The tire pressure monitor is temporarily malfunctioning.</p> <ul style="list-style-type: none"> <li>► Drive on. The tire pressure monitor restarts automatically as soon as the problem has been solved.</li> </ul>
 Tire Press. Warning Caution Tire Malfunction	<p> <b>Risk of accident</b></p> <p>The tire pressure in one or more tires has dropped suddenly. A warning tone also sounds.</p> <ul style="list-style-type: none"> <li>► Stop the vehicle without making any sudden steering or braking maneuvers. Pay attention to the traffic conditions as you do so.</li> <li>► If necessary, change a wheel (▷ page 370).</li> </ul>

Display messages	Possible causes/consequences and ► Solutions
 Check Tire Pressure	<p> <b>Risk of accident</b></p> <p>The tire pressure in one or more tires has dropped significantly.</p> <ul style="list-style-type: none"> <li>► Stop the vehicle without making any sudden steering or braking maneuvers. Pay attention to the traffic conditions as you do so.</li> <li>► If necessary, change a wheel (▷ page 370).</li> <li>► Check the tire pressure. If necessary, correct the tire pressure (▷ page 355).</li> </ul>
 Correct Tire Pressure	<p>The tire pressure is too low in at least one of the tires or the tire pressure difference between the wheels is too great.</p> <ul style="list-style-type: none"> <li>► Check the tire pressures at the next opportunity. If necessary, correct the tire pressure (▷ page 355).</li> </ul>





## Vehicle





Display messages	Possible causes/consequences and ► Solutions
Shift to 'P' or 'N' to Start Engine	<p>You have attempted to start the engine with the transmission in position <b>R</b> or <b>D</b>.</p> <ul style="list-style-type: none"> <li>► Shift the transmission to position <b>P</b> or <b>N</b>.</li> </ul>
Auxiliary Battery Malfunction	<p>The auxiliary battery for the automatic transmission is no longer being charged.</p> <ul style="list-style-type: none"> <li>► Visit a qualified specialist workshop.</li> </ul>
Apply Brake to Shift from 'P'	<p>You have attempted to move the transmission selector lever to position <b>D</b>, <b>R</b> or <b>N</b> without depressing the brake pedal.</p> <ul style="list-style-type: none"> <li>► Depress the brake pedal.</li> </ul>
Door Open Vehicle Not in 'P'	<p>The driver's door is open and the transmission is in position <b>R</b>, <b>N</b> or <b>D</b>.</p> <p>A warning tone also sounds.</p> <ul style="list-style-type: none"> <li>► Shift the transmission to position <b>P</b>.</li> <li>► Apply the parking brake.</li> </ul>



Display messages	Possible causes/consequences and ► Solutions
Service Required Do Not Shift Gears Visit Dealer	You cannot change the transmission position due to a malfunction. A warning tone also sounds. If transmission position <b>D</b> is selected: <ul style="list-style-type: none"> <li>► Drive to a qualified specialist workshop without shifting the transmission from position <b>D</b>.</li> </ul> If transmission position <b>R</b> , <b>N</b> or <b>P</b> is selected: <ul style="list-style-type: none"> <li>► Notify a qualified specialist workshop or breakdown service.</li> </ul>
Only Shift to 'P' when Vehicle is Stationary	The vehicle is moving. <ul style="list-style-type: none"> <li>► Pull over and stop the vehicle safely as soon as possible, paying attention to road and traffic conditions.</li> <li>► Shift the transmission to position <b>P</b>.</li> </ul>
	Sedan: the trunk lid is open. <ul style="list-style-type: none"> <li>► Close the trunk lid.</li> </ul>
	Wagon: the tailgate is open. <ul style="list-style-type: none"> <li>► Close the tailgate.</li> </ul>
 or 	<p><b>⚠ Risk of accident</b></p> The hood is open. <ul style="list-style-type: none"> <li>► Pull over and stop the vehicle safely as soon as possible, paying attention to road and traffic conditions.</li> <li>► Apply the parking brake.</li> <li>► Close the hood.</li> </ul>
	At least one door is open. <ul style="list-style-type: none"> <li>► Close all the doors.</li> </ul>
 Rear Left Backrest Not Latched or Rear Right Backrest Not Latched	<p><b>⚠ Risk of injury</b></p> Sedan with through-loading feature in the rear bench seat: The backrest in the rear is not engaged on the left-hand and/or right-hand side. <ul style="list-style-type: none"> <li>► Push the backrest back until it engages.</li> </ul>

Display messages	Possible causes/consequences and ► Solutions
 <p>Power Steering Malfunction See Operator's Manual</p>	<p> <b>Risk of accident</b></p> <p>The power steering is malfunctioning. You will need to use more force to steer. A warning tone also sounds.</p> <ul style="list-style-type: none"> <li>► Check whether you are able to apply the extra force required.</li> <li>► <b>If you are able to steer safely:</b> carefully drive on to a qualified specialist workshop.</li> <li>► <b>If you are unable to steer safely:</b> do not drive on. Contact the nearest qualified specialist workshop.</li> </ul>
<p>Phone No Service</p>	<p>Your vehicle is outside the network provider's transmitter/receiver range.</p> <ul style="list-style-type: none"> <li>► Wait until the mobile phone operational readiness symbol appears in the multifunction display.</li> </ul>
 <p>Check Washer Fluid</p>	<p>The washer fluid level in the washer fluid reservoir has dropped below the minimum.</p> <ul style="list-style-type: none"> <li>► Add washer fluid (► page 311).</li> </ul>

## SmartKey







Display messages	Possible causes/consequences and ► Solutions
 <p>Key Does Not Belong to Vehicle</p>	<p>You have put the wrong SmartKey in the ignition lock.</p> <ul style="list-style-type: none"> <li>► Use the correct SmartKey.</li> </ul>
 <p>Take Your Key from Ignition</p>	<p>The SmartKey is in the ignition lock.</p> <ul style="list-style-type: none"> <li>► Remove the SmartKey.</li> </ul>
 <p>Obtain a New Key</p>	<p>The SmartKey needs to be replaced.</p> <ul style="list-style-type: none"> <li>► Visit a qualified specialist workshop.</li> </ul>
 <p>Replace Key Battery</p>	<p>The batteries of the KEYLESS-GO key are discharged.</p> <ul style="list-style-type: none"> <li>► Change the batteries (► page 78).</li> </ul>



Display messages	Possible causes/consequences and ► Solutions
 <p>Don't Forget Your Key</p>	<p>The display message is shown for a maximum of 60 seconds and is only a reminder.</p> <p>You have opened the driver's door with the engine switched off. The KEYLESS-GO key is not in the ignition lock.</p> <ul style="list-style-type: none"> <li>► Remember to take the KEYLESS-GO key with you when you leave the vehicle.</li> </ul>
 <p>Key Not Detected (red display message)</p>	<p>The KEYLESS-GO key is not in the vehicle. A warning tone also sounds.</p> <p>If the engine is switched off, you can no longer lock the vehicle centrally or start the engine.</p> <ul style="list-style-type: none"> <li>► Pull over and stop the vehicle safely as soon as possible, paying attention to road and traffic conditions.</li> <li>► Apply the parking brake.</li> <li>► Locate the KEYLESS-GO key.</li> </ul> <p>The KEYLESS-GO key is not detected while the engine is running because there is interference from a strong source of radio waves. A warning tone also sounds.</p> <ul style="list-style-type: none"> <li>► Pull over and stop the vehicle safely as soon as possible, paying attention to road and traffic conditions.</li> <li>► Engage the parking brake.</li> <li>► Operate the vehicle with the SmartKey in the ignition lock.</li> </ul>
 <p>Key Not Detected (White display message)</p>	<p>The KEYLESS-GO key cannot be detected at present.</p> <ul style="list-style-type: none"> <li>► Change the location of the key with the KEYLESS-GO functions in the vehicle.</li> </ul> <p>If the KEYLESS-GO key is still not detected:</p> <ul style="list-style-type: none"> <li>► Operate the vehicle with the SmartKey in the ignition lock.</li> </ul>
 <p>Key Detected in Vehicle</p>	<p>The KEYLESS-GO key has been detected inside the vehicle during locking.</p> <ul style="list-style-type: none"> <li>► Remove the KEYLESS-GO key from the vehicle.</li> </ul>

Display messages	Possible causes/consequences and ► Solutions
 <p>Remove 'Start' Button and Insert Key</p>	<p>KEYLESS-GO is temporarily malfunctioning or is defective. A warning tone also sounds.</p> <ul style="list-style-type: none"> <li>► Insert the SmartKey into the ignition lock and turn it to the desired position.</li> <li>► Visit a qualified specialist workshop.</li> </ul>
 <p>Close Doors to Lock Vehicle</p>	<p>At least one door is open. A warning tone also sounds.</p> <ul style="list-style-type: none"> <li>► Close all doors and lock the vehicle again.</li> </ul>







## Warning and indicator lamps in the instrument cluster

### Seat belt

Problem	Possible causes/consequences and ► Solutions
 <p>After starting the engine, the red seat belt warning lamp lights up for six seconds.</p>	<p>The seat belt warning lamp reminds the driver and front passenger to fasten their seat belts.</p> <ul style="list-style-type: none"> <li>► Fasten your seat belt (▷ page 51).</li> </ul>
 <p>After starting the engine, the red seat belt warning lamp lights up. In addition, a warning tone sounds for up to six seconds.</p>	<p> <b>Risk of injury</b></p> <p>The driver's seat belt is not fastened.</p> <ul style="list-style-type: none"> <li>► Fasten your seat belt (▷ page 51). The warning tone ceases.</li> </ul>
 <p>The red seat belt warning lamp lights up after the engine starts, as soon as the driver's or the front-passenger door is closed.</p>	<p> <b>Risk of injury</b></p> <p>The driver or front passenger has not fastened their seat belt.</p> <ul style="list-style-type: none"> <li>► Fasten your seat belt (▷ page 51). The warning lamp goes out.</li> </ul> <p> <b>Risk of injury</b></p> <p>There are objects on the front-passenger seat.</p> <ul style="list-style-type: none"> <li>► Remove the objects from the front-passenger seat and stow them in a secure place. The warning lamp goes out.</li> </ul>

Problem	Possible causes/consequences and ► Solutions
 <p>The red seat belt warning lamp flashes and an intermittent audible warning sounds.</p>	<p> <b>Risk of injury</b></p> <p>The driver or front passenger has not fastened their seat belt. In addition, you are driving faster than 15 mph (25 km/h) or you have briefly driven faster than 15 mph (25 km/h).</p> <ul style="list-style-type: none"> <li>► Fasten your seat belt (► page 51). The warning lamp goes out and the intermittent warning tone ceases.</li> </ul> <p> <b>Risk of injury</b></p> <p>There are objects on the front-passenger seat. In addition, you are driving faster than 15 mph (25 km/h) or you have briefly driven faster than 15 mph (25 km/h).</p> <ul style="list-style-type: none"> <li>► Remove the objects from the front-passenger seat and stow them in a secure place. The warning lamp goes out and the intermittent warning tone ceases.</li> </ul>



















Safety systems	
Problem	Possible causes/consequences and ► Solutions
<p> (USA only)</p> <p> (Canada only)</p> <p>The red brake system warning lamp comes on while the engine is running. A warning tone also sounds.</p>	<p> <b>Risk of accident</b></p> <p>The brake boosting effect is malfunctioning and the braking characteristics may be affected.</p> <ul style="list-style-type: none"> <li>► Pull over and stop the vehicle safely as soon as possible, paying attention to road and traffic conditions. Do not continue driving under any circumstances.</li> <li>► Engage the parking brake.</li> <li>► Consult a qualified specialist workshop.</li> <li>► Observe the additional display messages in the multifunction display.</li> </ul>
<p> (USA only)</p> <p> (Canada only)</p> <p>The red brake system warning lamp comes on while the engine is running. A warning tone also sounds.</p>	<p> <b>Risk of accident</b></p> <p>There is not enough brake fluid in the brake fluid reservoir.</p> <ul style="list-style-type: none"> <li>► Pull over and stop the vehicle safely as soon as possible, paying attention to road and traffic conditions. Do not continue driving under any circumstances.</li> <li>► Engage the parking brake.</li> <li>► Consult a qualified specialist workshop immediately.</li> <li>► Observe the additional display messages in the multifunction display.</li> </ul> <p>Do not add brake fluid. This will not rectify the malfunction.</p>







 **WARNING**

Driving with the brake warning lamp illuminated can result in an accident. Have your brake system checked immediately if the brake warning lamp stays on. Do not add brake fluid before checking the brake system.

Overfilling the brake fluid reservoir can result in spilling brake fluid on hot engine parts and the brake fluid catching fire. You can be seriously burned.

Problem	Possible causes/consequences and ► Solutions
 <p>The yellow ABS warning lamp is lit while the engine is running.</p>	<p> <b>Risk of accident</b></p> <p>ABS (Anti-lock Brake System) is deactivated due to a malfunction. ESP® (Electronic Stability Program), BAS (Brake Assist), BAS PLUS, PRE-SAFE®, PRE-SAFE® Brake, the HOLD function and hill start assist are therefore also deactivated, for example.</p> <p>The brake system continues to function normally, but without the functions listed above. The wheels could therefore lock if you brake hard, for example.</p> <p>ATTENTION ASSIST is deactivated.</p> <ul style="list-style-type: none"> <li>► Observe the additional display messages in the multifunction display.</li> <li>► Drive on carefully.</li> <li>► Visit a qualified specialist workshop.</li> </ul>
 <p>The yellow ABS warning lamp is lit while the engine is running. A warning tone also sounds.</p>	<p> <b>Risk of accident</b></p> <p>EBD (electronic brake force distribution), is malfunctioning. Therefore, ABS, BAS, BAS PLUS, ESP®, PRE-SAFE®, PRE-SAFE® Brake, the HOLD function and hill start assist are also unavailable, for example.</p> <p>The brake system continues to function normally, but without the functions listed above. The wheels could therefore lock if you brake hard, for example.</p> <ul style="list-style-type: none"> <li>► Observe the additional display messages in the multifunction display.</li> <li>► Drive on carefully.</li> <li>► Visit a qualified specialist workshop.</li> </ul>
<p> (USA only)</p> <p> (Canada only)</p> <p>  </p> <p>The red brake warning lamp, the yellow ESP® and ESP® OFF warning lamps and the yellow ABS warning lamp are lit while the engine is running.</p>	<p> <b>Risk of accident</b></p> <p>ABS and ESP® are faulty. Other systems, e.g. BAS, BAS PLUS, EBD, PRE-SAFE®, PRE-SAFE® Brake, the HOLD function and hill start assist, are also not available due to a malfunction.</p> <p>The brake system continues to function normally, but without the functions listed above. The wheels could therefore lock if you brake hard, for example.</p> <p>ATTENTION ASSIST is deactivated.</p> <ul style="list-style-type: none"> <li>► Observe the additional display messages in the multifunction display.</li> <li>► Drive on carefully.</li> <li>► Visit a qualified specialist workshop.</li> </ul>





Problem	Possible causes/consequences and ► Solutions
 <p>The yellow ESP® warning lamp flashes while the vehicle is in motion.</p>	<p> <b>Risk of accident</b></p> <p>ESP® or traction control has intervened because there is a risk of skidding or at least one wheel has started to spin. Cruise control or DISTRONIC PLUS is deactivated.</p> <ul style="list-style-type: none"> <li>► Only depress the accelerator pedal as far as necessary when pulling away.</li> <li>► Ease off the accelerator pedal while the vehicle is in motion.</li> <li>► Adapt your driving style to suit the road and weather conditions.</li> <li>► Do not deactivate ESP®. Exceptions: (► page 66).</li> </ul>
 <p>The yellow ESP® OFF warning lamp is lit while the engine is running.</p>	<p> <b>Risk of accident</b></p> <p>ESP® is deactivated. ESP® will not stabilize the vehicle if it starts to skid or if a wheel starts to spin.</p> <ul style="list-style-type: none"> <li>► Reactivate ESP®. Exceptions: (► page 66).</li> <li>► Adapt your driving style to suit the road and weather conditions.</li> </ul> <p>If ESP® cannot be activated:</p> <ul style="list-style-type: none"> <li>► Have ESP® checked at a qualified specialist workshop.</li> </ul>
 <p>AMG vehicles only: The yellow SPORT handling mode warning lamp is lit while the engine is running.</p>	<p> <b>Risk of accident</b></p> <p>SPORT handling mode is activated. ESP® only stabilizes the vehicle in extreme situations. ESP® intervention may not be able to provide sufficient assistance in such situations and the vehicle may start to skid.</p> <ul style="list-style-type: none"> <li>► Reactivate ESP®. Exceptions: (► page 66).</li> </ul> <p>If ESP® cannot be activated:</p> <ul style="list-style-type: none"> <li>► Have ESP® checked at a qualified specialist workshop.</li> </ul>

Problem	Possible causes/consequences and ► Solutions
 <p>The yellow ESP® and ESP® OFF warning lamps are lit while the engine is running.</p>	<p> <b>Risk of accident</b></p> <p>ESP®, BAS, BAS PLUS, PRE-SAFE®, PRE-SAFE® Brake, the HOLD function and hill start assist are not available due to a malfunction. ESP® will not stabilize the vehicle if it starts to skid or if a wheel starts to spin.</p> <p>The brake system continues to function normally, but without the functions listed above.</p> <p>ATTENTION ASSIST is deactivated.</p> <ul style="list-style-type: none"> <li>► Observe the additional display messages in the multifunction display.</li> <li>► Drive on carefully.</li> <li>► Visit a qualified specialist workshop.</li> </ul>
<p> (USA only)</p> <p> (Canada only)</p> <p>The red brake system warning lamp comes on while the vehicle is moving. A warning tone also sounds.</p>	<p>You are driving with the parking brake applied.</p> <ul style="list-style-type: none"> <li>► Release the parking brake</li> </ul> <p>The warning lamp goes out and the warning tone ceases.</p>
<p></p> <p>The red SRS warning lamp is lit while the engine is running.</p>	<p> <b>Risk of injury</b></p> <p>The restraint systems are malfunctioning. The air bags or ETDs may either be triggered unintentionally or, in the event of an accident, not be triggered at all.</p> <ul style="list-style-type: none"> <li>► Drive on carefully.</li> <li>► Visit a qualified specialist workshop immediately.</li> </ul>



### **WARNING**

In the event a malfunction of the SRS is indicated as outlined above, the SRS may not be operational.

For your safety, we strongly recommend that you contact an authorized Mercedes-Benz Center immediately to have the system checked. Otherwise the SRS may not be activated when needed in an accident, which could result in serious or fatal injury, or it might deploy unexpectedly and unnecessarily which could also result in injury.

Engine	
Problem	Possible causes/consequences and ► Solutions
 <p>The yellow Check Engine warning lamp lights up while the engine is running.</p>	<p>There may be a malfunction, for example:</p> <ul style="list-style-type: none"> <li>• in the engine management</li> <li>• in the fuel injection system</li> <li>• in the exhaust system</li> <li>• in the ignition system (for vehicles with a gasoline engine)</li> <li>• in the fuel system</li> </ul> <p>The emission limit values may be exceeded and the engine may be running in emergency mode.</p> <p>► Have the vehicle checked as soon as possible at a qualified specialist workshop.</p> <p><b>i</b> In some states, you are required by law to immediately visit a qualified specialist workshop as soon as the yellow Check Engine warning lamp lights up. If in doubt, check whether such legal regulations apply in the state/province in which you are currently driving.</p> <p>Vehicles with a diesel engine: the fuel tank has been run dry (&gt; page 164).</p> <p>► Start the engine three to four times after refueling. If the yellow Check Engine warning lamp goes out, emergency running mode is canceled. The vehicle need not be checked.</p>
 <p>The yellow reserve fuel warning lamp flashes while the vehicle is in motion. In addition, the yellow Check Engine warning lamp  may light up.</p>	<p>The fuel system pressure is too low. The fuel filler cap is not closed correctly or the fuel system is leaking.</p> <ul style="list-style-type: none"> <li>► Observe the additional display messages in the multifunction display.</li> <li>► Check that the fuel filler cap is correctly closed.</li> <li>► <b>If the fuel filler cap is not correctly closed:</b> close the fuel filler cap.</li> <li>► <b>If the fuel filler cap is closed:</b> visit a qualified specialist workshop.</li> </ul>
 <p>The yellow reserve fuel warning lamp lights up while the engine is running.</p>	<p>The fuel level has dropped into the reserve range.</p> <ul style="list-style-type: none"> <li>► Refuel at the nearest gas station.</li> </ul>

Problem	Possible causes/consequences and ► Solutions
 <p>The red coolant warning lamp lights up while the engine is running and the coolant temperature gauge is at the start of the scale.</p>	<p>The temperature sensor for the coolant temperature gauge is defective.</p> <p>The coolant temperature is no longer being monitored. There is a risk of engine damage if the coolant temperature is too high.</p> <ul style="list-style-type: none"><li>► Pull over and stop the vehicle safely and switch off the engine, paying attention to road and traffic conditions. Do not continue driving under any circumstances.</li><li>► Apply the parking brake.</li><li>► Consult a qualified specialist workshop.</li></ul>

Problem	Possible causes/consequences and ► Solutions
 <p>The red coolant warning lamp comes on while the engine is running.</p>	<p>The coolant level is too low.</p> <p>If the coolant level is correct, the airflow to the engine radiator may be blocked or the electric engine radiator fan may be malfunctioning.</p> <p>The coolant is too hot and the engine is no longer being cooled sufficiently.</p> <ul style="list-style-type: none"> <li>► Observe the additional display messages in the multifunction display.</li> <li>► Pull over and stop the vehicle safely and switch off the engine, paying attention to road and traffic conditions.</li> <li>► Allow the engine and coolant to cool.</li> <li>► Check the coolant level and add coolant (▷ page 311). Observe the warning notes.</li> <li>► If you need to add coolant more often than usual, have the engine coolant system checked.</li> <li>► Make sure that the air supply to the engine radiator is not blocked, e.g. by snow, slush or ice.</li> <li>► At coolant temperatures under 248 °F (120 °C), drive to the next qualified specialist workshop.</li> <li>► Avoid subjecting the engine to heavy loads, e.g. driving in mountainous terrain, and stop-and-go traffic.</li> </ul>
 <p>The red coolant warning lamp comes on while the engine is running. A warning tone also sounds.</p>	<p>The coolant temperature has exceeded 248 °F (120 °C). The airflow to the engine radiator may be blocked or the coolant level may be too low.</p> <p>The engine is not being cooled sufficiently and may be damaged.</p> <ul style="list-style-type: none"> <li>► Observe the additional display messages in the multifunction display.</li> <li>► Pull over and stop the vehicle safely and switch off the engine, paying attention to road and traffic conditions.</li> <li>► Allow the engine and coolant to cool.</li> <li>► Check the coolant level and add coolant (▷ page 311). Observe the warning notes.</li> <li>► If you need to add coolant more often than usual, have the engine coolant system checked.</li> <li>► Make sure that the air supply to the engine radiator is not blocked, e.g. by snow, slush or ice.</li> <li>► At coolant temperatures under 248 °F (120 °C), drive to the next qualified specialist workshop.</li> <li>► Avoid subjecting the engine to heavy loads, e.g. driving in mountainous terrain, and stop-and-go traffic.</li> </ul>

 **WARNING**

Driving when your engine is overheated can cause some fluids which may have leaked into the engine compartment to catch fire. You could be seriously burned.

Steam from an overheated engine can cause serious burns which can occur just by opening the engine hood. Stay away from the engine if you see or hear steam coming from it.

Stop the vehicle in a safe location away from other traffic. Turn off the engine, get out of the vehicle and do not stand near the vehicle until the engine has cooled down.

-  If the coolant temperature exceeds 248 °F(120 °C) do not continue driving. The engine will otherwise be damaged.

**Driving systems****Problem**

The red distance warning lamp lights up while the vehicle is in motion. A warning tone also sounds.



**Possible causes/consequences and ► Solutions** **Risk of accident**

The warning is issued if you approach a stationary vehicle or a vehicle driving ahead of you at too high a speed.

- Be prepared to brake immediately.
- Pay careful attention to the traffic situation. You may have to brake or take evasive action.

More information about DISTRONIC PLUS (► page 177) and PRE-SAFE® Brake (► page 69).



Tires	
Problem	Possible causes/consequences and ► Solutions
 USA only: The yellow tire pressure monitor warning lamp (pressure loss/malfunction) is lit. Canada only: The yellow tire pressure monitor warning lamp (pressure loss) is lit.	 <b>Risk of accident</b> The tire pressure monitor has detected a loss of pressure in at least one of the tires. <ul style="list-style-type: none"> <li>► Stop the vehicle without making any sudden steering or braking maneuvers. Pay attention to the traffic conditions as you do so.</li> <li>► Observe the additional display messages in the multifunction display.</li> <li>► Check the tire pressure. If necessary, correct the tire pressure (► page 355).</li> <li>► If necessary, change a wheel (► page 370).</li> </ul>
 USA only: The yellow tire pressure monitor warning lamp (pressure loss/malfunction) flashes for 60 seconds and then remains lit.	The tire pressure monitor is faulty. <ul style="list-style-type: none"> <li>► Observe the additional display messages in the multifunction display.</li> <li>► Visit a qualified specialist workshop.</li> </ul>

### WARNING

Each tire, including the spare (if provided), should be checked at least every two weeks when cold and inflated to the pressure recommended by the vehicle manufacturer on the Tire and Loading Information placard on the driver's door B-pillar or, if available, the tire pressure label on the inside of the fuel filler flap. If your vehicle has tires of a different size than the size indicated on the Tire and Loading Information placard or the tire pressure label, you should determine the proper tire pressure for those tires.

As an added safety feature, your vehicle has been equipped with a tire pressure monitoring system (TPMS) that illuminates a low tire pressure telltale when one or more of your tires are significantly underinflated. Accordingly, when the low tire pressure telltale illuminates, you should stop and check your tires as soon as possible, and inflate them to the proper pressure. Driving on a significantly underinflated tire causes the tire to overheat and can lead to tire failure.

Underinflation also reduces fuel efficiency and tire tread life, and may affect the vehicle's handling and stopping ability. Please note that the TPMS is not a substitute for proper tire maintenance, and it is the driver's responsibility to maintain correct tire pressure, even if underinflation has not reached the level to trigger illumination of the TPMS low tire pressure telltale.

USA only:

Your vehicle has also been equipped with a TPMS malfunction indicator to indicate when the system is not operating properly. The TPMS malfunction indicator is combined with the low tire pressure telltale. When the system detects a malfunction, the telltale will flash for approximately 1 minute and then remain continuously illuminated. This sequence will be repeated every time

the vehicle is started as long as the malfunction exists. When the malfunction indicator is illuminated, the system may not be able to detect or signal low tire pressure as intended.

TPMS malfunctions may occur for a variety of reasons, including the installation of incompatible replacement or alternate tires or wheels on the vehicle that prevent the TPMS from functioning properly. Always check the TPMS malfunction telltale after replacing one or more tires or wheels on your vehicle to ensure that the replacement or alternate tires and wheels allow the TPMS to continue to function properly.

Useful information .....	274
Loading guidelines .....	274
Stowage areas .....	274
Features .....	289

## Useful information

- i** This Operator's Manual describes all models and all standard and optional equipment of your vehicle available at the time of publication of the Operator's Manual. Country-specific differences are possible. Please note that your vehicle may not be equipped with all features described. This also applies to safety-related systems and functions.
- i** Please read the information on qualified specialist workshops (▷ page 25).

## Loading guidelines

### WARNING

Always fasten items being carried as securely as possible. Use cargo tie-down rings and fastening materials appropriate for the weight and size of the load.

In an accident, during hard braking or sudden maneuvers, loose items will be thrown around inside the vehicle. This can cause injury to vehicle occupants unless the items are securely fastened in the vehicle.

To help avoid personal injury during a collision or sudden maneuver, exercise care when transporting cargo. Do not pile luggage or cargo higher than the seat backrests.

The trunk is the preferred place to carry objects.

Never drive a vehicle with the trunk open. Deadly carbon monoxide (CO) gases may enter vehicle interior resulting in unconsciousness and death.

The handling characteristics of a laden vehicle are dependent on the distribution of the load within the vehicle. For this reason, you should observe the following notes when transporting a load:

- when transporting a load, never exceed the maximum permissible gross vehicle weight or the gross axle weight rating of the

vehicle (including occupants). The values are specified on the vehicle identification plate on the B-pillar of the driver's door.

- position heavy loads as far forwards as possible and as low down in the trunk/cargo compartment as possible.
- the load must not protrude above the upper edge of the seat backrests.
- always place the load against the rear or front seat backrests. Make sure that the seat backrests are securely locked into place.
- always place the load behind unoccupied seats if possible.
- secure the load with sufficiently strong and wear-resistant tie down. pad sharp edges for protection.

## Stowage areas

### Stowage compartments

#### Important safety notes

### WARNING

To help avoid personal injury during a collision or sudden maneuver, exercise care when storing objects in the vehicle. Put luggage or cargo in the trunk if possible.

Do not pile luggage or cargo higher than the seat backrests.

Keep compartment lids closed. This will help to prevent stored objects from being thrown about and injuring vehicle occupants during

- braking
- vehicle maneuvers
- an accident

#### Stowage compartments in the front

##### Glove box

- i** The glove box can be ventilated (▷ page 141).

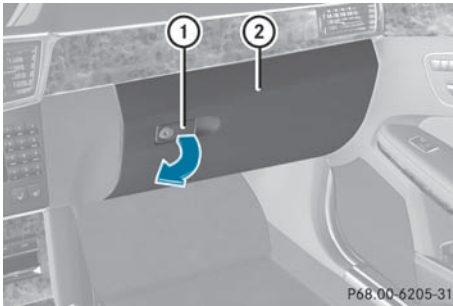

- ▶ **To open:** pull handle ① and open glove box flap ②.
- ▶ **To close:** fold glove box flap ② upwards until it engages.

The glove box can only be locked and unlocked using the mechanical key.

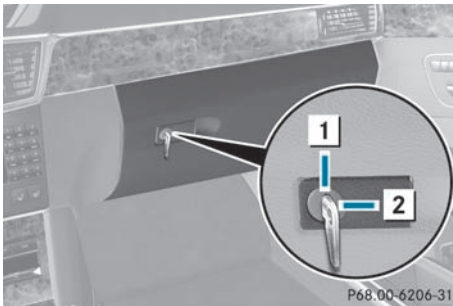

- ▶ **To lock:** insert the mechanical key into the lock and turn it 90° clockwise to position ②.
- ▶ **To unlock:** insert the mechanical key into the lock and turn it 90° counter-clockwise to position ①.

### Eyeglasses compartment

There is a compartment to stow eyeglasses in the headliner on the driver's side.

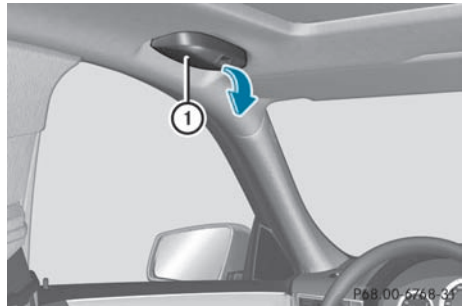

- ▶ **To open:** pull down eyeglasses compartment ① by the handle.

### Stowage compartment in the center console

- ❗ A stowage compartment is located under the cup holder at the front of the center console.

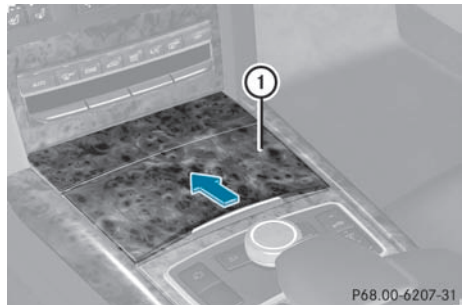

- ▶ **To open:** slide cover ① forwards until it engages.
- ▶ Remove the cup holder at the front of the center console (▷ page 289).

### Stowage compartment under the armrest

- ❗ Depending on the vehicle's equipment, a USB connection and an AUX IN connection or a Media Interface are installed in the stowage compartment. A Media Interface is a universal interface for mobile audio equipment, e.g. for an iPod® or MP3 player (see the separate COMAND operating instructions).

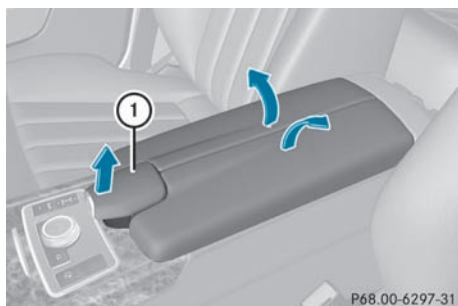

All models except E 63 AMG

- ▶ **To open:** pull handle ① upwards. The armrest folds out.

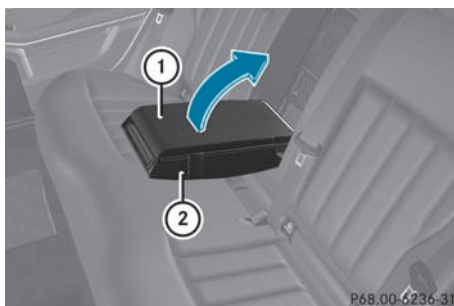

- ▶ **To open:** fold down seat armrest ②.
- ▶ Fold cover ① of the armrest upwards.

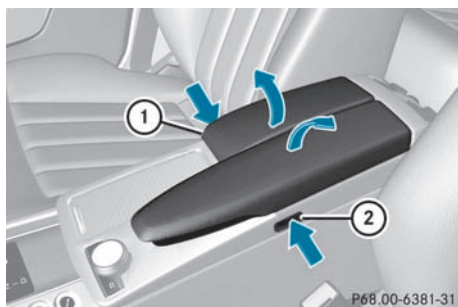

E 63 AMG

- ▶ **To open:** press left-hand button ② or right-hand button ①. The stowage compartment opens.

### Stowage net in the rear

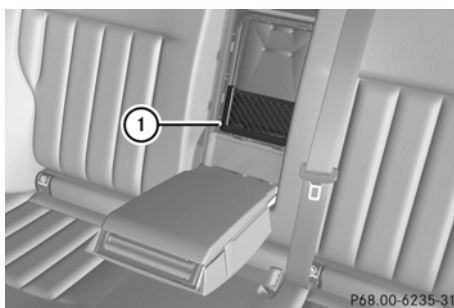

- ① Stowage net

### Stowage compartments in the rear

#### Stowage compartment in the rear

- ❗ Do not sit or lean your bodyweight on the armrests when they are folded out as you could damage them.
- ❗ Close the cover of the stowage compartment before folding the rear seat armrest back into the seat backrest.

#### Stowage pockets

##### ⚠ WARNING

Storage bags are intended for storing light-weight items only.

Heavy objects, objects with sharp edges or fragile objects may not be transported in the storage bag. In an accident, during hard braking, or sudden maneuvers, they could be thrown around inside the vehicle and cause injury to vehicle occupants.

Storage bags cannot protect transported goods in the event of an accident.

Storage bags are located in the rear compartment on the driver's and front-passenger seat backrests.

## Parcel nets

### WARNING

Parcel nets are intended for storing light-weight items only, such as road maps, mail, etc.

Heavy objects, objects with sharp edges, or fragile objects may not be transported in the parcel nets. In an accident, during hard braking, or sudden maneuvers, they could be thrown around inside the vehicle and cause injury to vehicle occupants.

Parcel nets cannot protect transported goods in the event of an accident.

Parcel nets are located in the front-passenger footwell and on the left and right-hand sides of the trunk/cargo compartment.

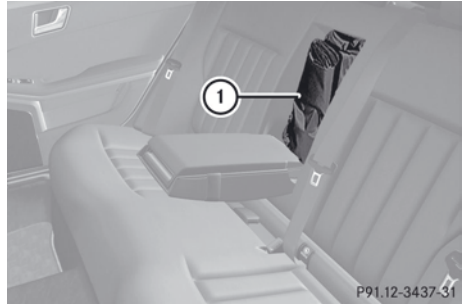

- ▶ Pull skibag ① into the vehicle interior and unfold it.
- ▶ Open the trunk lid.

## Skibag

### Unfolding the skibag and loading skis

### WARNING

The skibag is designed for up to four pairs of skis. Do not load the skibag with any other objects.

Always fasten the skibag securely. In an accident, an unfastened ski bag can cause injury to vehicle occupants.

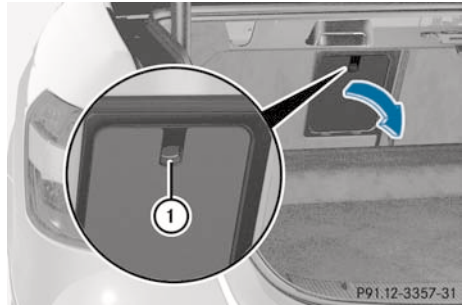

- ▶ Press release button ①. The flap opens downwards.
- ▶ Slide the skis into the skibag from the trunk.

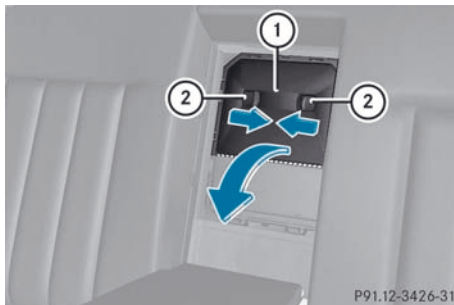

- ▶ Fold down the rear seat armrest.
- ▶ Press release catches ② together and fold down cover ①.

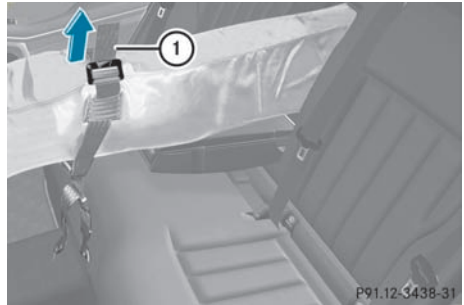

- ▶ Pull strap ① tight by the loose end until the skis are held firmly inside the skibag.

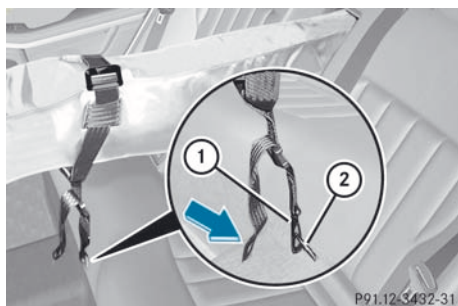

- ▶ Engage hook ① in securing ring ②.
- ▶ Pull the strap tight by the loose end.

### Removing the skis and folding up the skibag

- ▶ Loosen the two straps.
- ▶ Remove hook ① from securing ring ②.
- ▶ Take the skis out of the skibag.
- ▶ Close the flap in the trunk.
- ▶ Smooth out the skibag and fold it up.
- ▶ Put the skibag into the backrest.
- ▶ Fold the cover back up.

**i** You should always close the flap in the trunk if you do not require the skibag. This will prevent unauthorized access to the trunk from the vehicle interior.

### Removing the skibag

#### **⚠ WARNING**

When the skibag has been removed, always drive with the trunk lid closed. Exhaust fumes could otherwise enter the vehicle interior.

The skibag can be removed for cleaning or drying.

- ▶ Open the trunk lid.

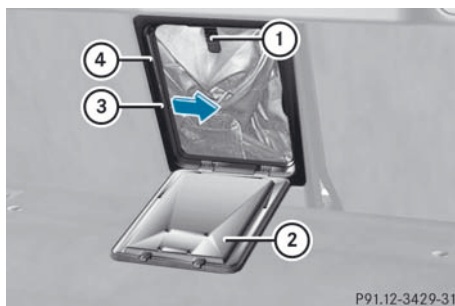

- ▶ Press release catch ①. Flap ② folds down.
- ▶ Press catch ③ in and pull out frame ④ containing the skibag.

### Through-loading facility in the rear compartment

#### **⚠ WARNING**

Do not transport any unsecured items in the through-loading area.

The through-loading facility is opened from the trunk.

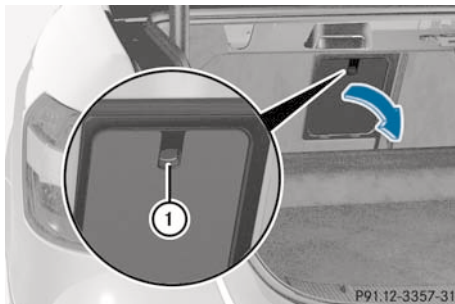

- ▶ Fold down the rear seat armrest.
- ▶ Press release button ①. The flap opens downwards.



## Through-loading facility in the rear bench seat (Sedan)

### Important safety notes

#### WARNING

When expanding the cargo volume, always fold the seat backrests fully forward.

Unless you are transporting cargo, the seat backrests must remain properly locked in the upright position.

In an accident, during hard braking or sudden maneuvers, loose items will be thrown around inside the vehicle. This can cause injury to vehicle occupants unless the items are securely fastened in the vehicle.

Always use the cargo tie-down rings.

The left-hand and right-hand rear seat backrests can be folded down separately to increase the trunk capacity.

### Folding the seat backrest forward

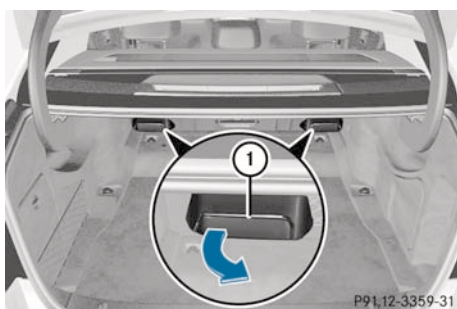

- i** Vehicles with memory function: when you fold one or both parts of the rear seat backrest forwards, the respective front seat moves forward slightly, when necessary, in order to avoid contact.

- ▶ Vehicles without memory function: if necessary, move the driver's or front-passenger seat forwards.
- ▶ Open the trunk.
- ▶ Pull right-hand or left-hand rear seat backrest release handle ①. The corresponding rear seat backrest is released and the rear seat head restraints are lowered.

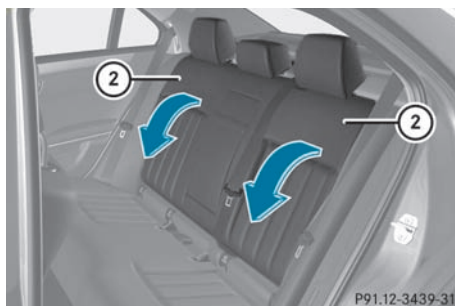

- ▶ Fold rear seat backrest ② forwards.
- ▶ Move the driver's or front-passenger seat back if necessary.

### Folding the seat backrest back

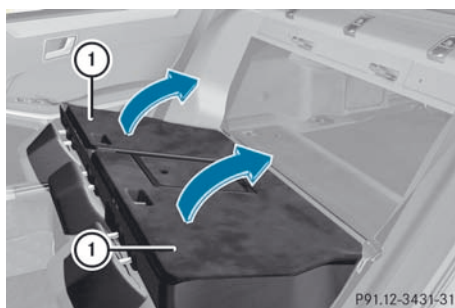

- ▶ Move the driver's or front-passenger seat forward if necessary.
- !** Make sure that the seat belt does not become trapped when folding the rear seat backrest back. Otherwise, it could be damaged.
- ▶ Fold rear seat backrest ① back until it engages.

**⚠ WARNING**

Always lock the seat backrest in its upright position when the rear seat bench is occupied, or the extended cargo volume is not in use.

Check for secure locking by pushing and pulling on the seat backrest.

In an accident, during hard braking or sudden maneuvers, loose items will be thrown around inside the vehicle. This can cause injury to vehicle occupants unless the items are securely fastened in the vehicle.

To help avoid personal injury during a collision or sudden maneuver, exercise care when transporting cargo.

- i** You should always engage the rear seat backrests if you do not need the through-loading feature. This will prevent unauthorized access to the trunk from the vehicle interior.

- ▶ Adjust the head restraints if necessary (▷ page 101).
- ▶ Move the driver's or front-passenger seat back if necessary.

**EASY-PACK through-loading facility in the rear bench seat (Wagon)****Important safety notes****⚠ WARNING**

Never drive a vehicle with the tailgate open. Deadly carbon monoxide (CO) gases may enter vehicle interior resulting in unconsciousness and death.

**Folding the rear seat backrest forward**

The left-hand and right-hand rear seat backrests can be folded forwards separately to increase the cargo compartment capacity.

The combined cargo cover and net can remain installed.

- !** When folding the rear seat backrest forwards, ensure that there are no items lying on the seat cushions. These items could otherwise be damaged or could themselves damage the rear seats.

- i** When you fold one or both parts of the rear seat backrests forwards, the headrests are also lowered if necessary. In the case of vehicles with memory function, the respective front seat is moved forwards slightly to avoid contact with the seat behind it.

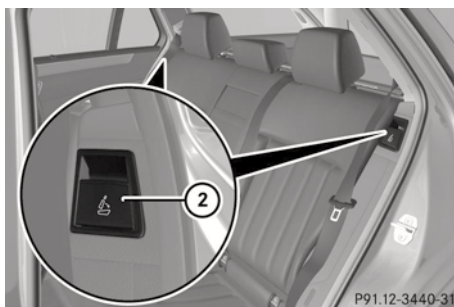
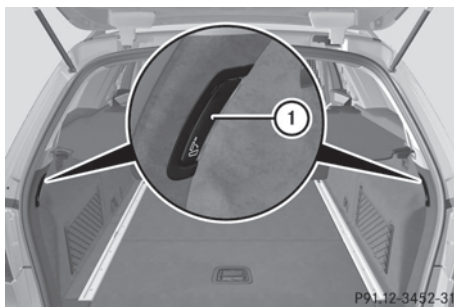

- ▶ Vehicles without memory function: if necessary, move the driver's or front-passenger seat forwards.
- ▶ Pull the left-hand or right-hand release handle at the rear in cargo compartment ① or at the side beside backrests ②. The corresponding backrest folds forwards.
- ▶ Move the driver's or front-passenger seat back if necessary.

## Folding the rear seat backrest back

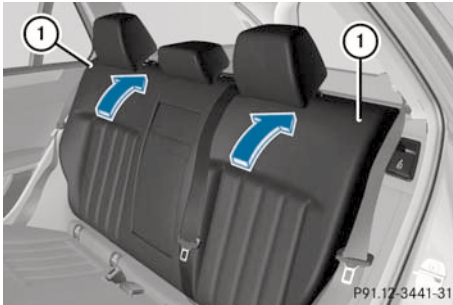

- ▶ Move the driver's or front-passenger seat forward if necessary.
- ⚠ Make sure that the seat belt does not become trapped when folding the rear seat backrest back. Otherwise, it could be damaged.
- ▶ Fold seat backrest ① back until it engages.

### ⚠ WARNING

Make sure that the rear seat backrest is correctly engaged. Otherwise, vehicle occupants could be injured by objects being thrown around if you

- brake sharply
- change direction suddenly
- are involved in an accident

If the rear seat backrest is not engaged, this will be shown in the multifunction display in the instrument cluster.

- ▶ Adjust the head restraints if necessary (▷ page 101).
- ▶ Move the driver's or front-passenger seat back if necessary.

## Securing cargo

### Plastic hooks (Sedan)

On vehicles without a through-loading feature in the rear bench seat, six plastic hooks are installed to the trunk floor.

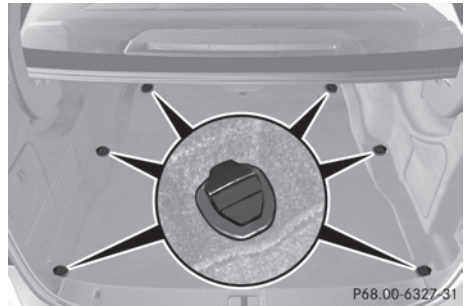

## Cargo tie-down rings

Observe the following notes on securing loads:

- secure the load using the cargo tie down rings.
- do not use elastic straps or nets to secure a load, as these are only intended as an anti-slip protection for light loads.
- do not route tie downs across sharp edges or corners.
- pad sharp edges for protection.

There are six cargo tie down rings in the trunk/cargo compartment.



Sedan

① Cargo tie down rings

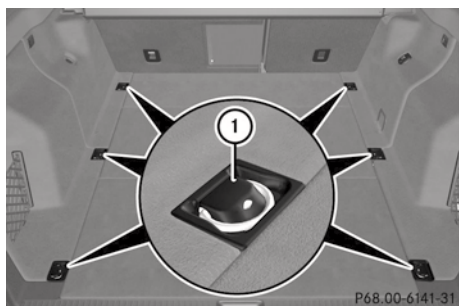

Wagon

① Cargo tie down rings

### Bag hooks in the trunk/cargo compartment

#### Important safety notes

⚠ The bag hook can bear a maximum load of 6.6 lbs (3 kg). Do not use it to secure a load.

Sedan

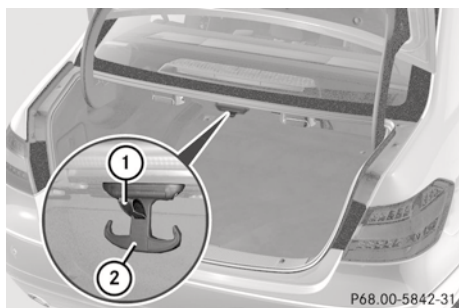

► Pull bag hook ② down by tab ①.

Wagon

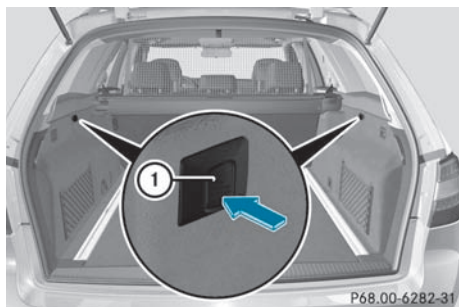

► **To open:** press bag hook ① (arrow). Bag hook ① slides out.

► **To close:** press bag hook ① until it engages.

### EASY-PACK cargo compartment cover

#### Important safety notes

⚠ When loading the vehicle, make sure that you do not stack the load in the cargo compartment higher than the lower edge of the side windows. Do not place heavy objects on top of the cargo compartment cover.

The cargo compartment cover and the cargo net are attached to anchorages on the right and left in the cargo compartment as a combined cargo cover and net.

When the tailgate is opened, the cargo compartment cover is automatically raised to make loading easier. It is automatically lowered again when the tailgate is closed.

When the cargo compartment cover is clipped in, there should be no objects obstructing the downwards movement of the cover in the cargo compartment when the tailgate is closed. The cargo compartment cover will otherwise be raised again.

#### Extending and retracting the cargo compartment cover

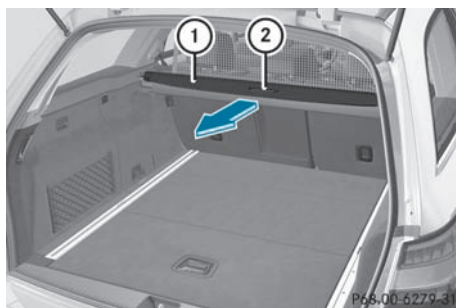

- **To extend:** pull cargo compartment cover ① back by grab handle ② and clip it into the retainers on the left and right.

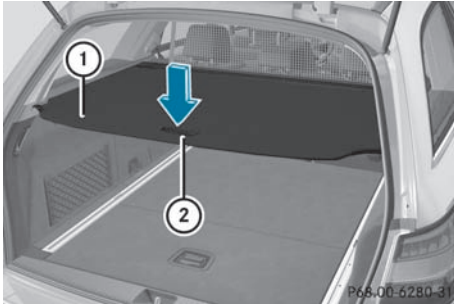

- **To retract:** unhook cargo compartment cover ① from the retainers on the left and right and guide it forwards by grab handle ② until it is fully retracted.

### Installing/removing the combined cargo cover and net

You can reach the combined cargo cover and net to install and remove it from the cargo compartment and, with the seat backrest folded forwards, from the left-hand rear door.

- Make sure that the cargo net and the cargo compartment cover are rolled up.

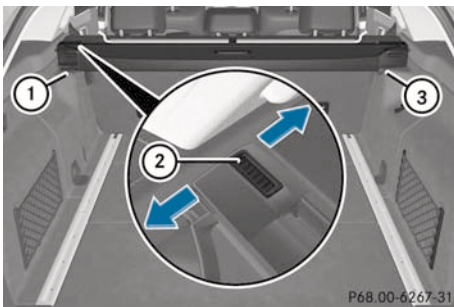

- **To remove:** press button ②.
- Fold the combined cargo cover and net forwards on the left-hand side with the seat backrest folded forwards, and fold it backwards with the seat backrest folded up.

- First, detach the combined cargo cover and net from left-hand catch ① and then remove it from right-hand fixture ③.
- **To install:** push the combined cargo cover and net up to the stop into right-hand fixture ③.
- Place the combined cargo cover and net into the left-hand fixture and push it into catch ① until the combined cargo cover and net engages audibly.

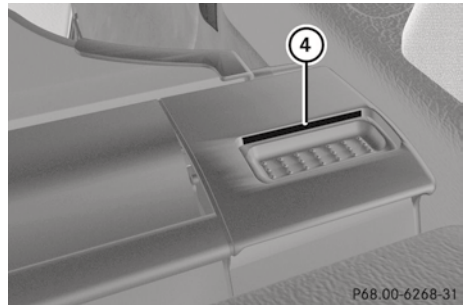

- Make sure that red lock status indicator ④ is no longer visible. The combined cargo cover and net will otherwise not be locked in place.

### Attaching the combined cargo cover and net to the rear seat backrest

- Fold the left and right seat backrest forwards (> page 280).

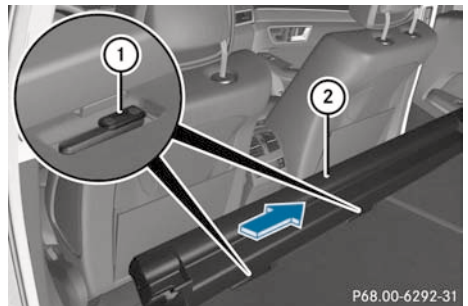

- Insert combined cargo cover and net ② into the two guides ① and push it up to the stop in the direction of the arrow.



- ! If you have attached the combined cargo cover and net to a rear seat backrest that is folded forwards, do not fold the backrest back.

### Cargo net (Wagon)

#### Important safety notes

It is particularly important to use a safety net if the vehicle is loaded with small objects above the level of the backrests. For safety reasons, always use a cargo net when transporting loads.

#### Cargo net without cargo compartment enlargement

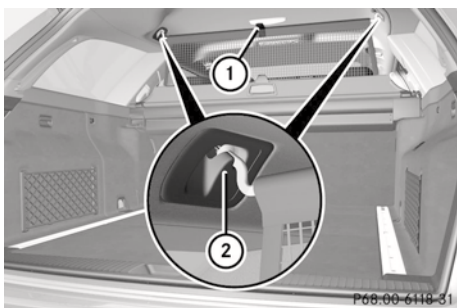

- Pull the cargo net up by tab ① and hook it into eyelets ②.

#### Cargo net with cargo compartment enlargement

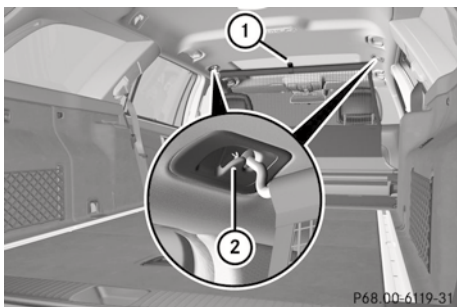

- Make sure that the cargo net is attached to the rear seat backrest (▷ page 283).
- Guide the cargo net up by tab ① and hook it into eyelets ②.

### Coat hooks on the tailgate

#### ⚠ WARNING

The tailgate may close if too great a load is placed on the coat hooks.

You and/or others could be trapped and injured.

Only use the coat hooks for light clothing.

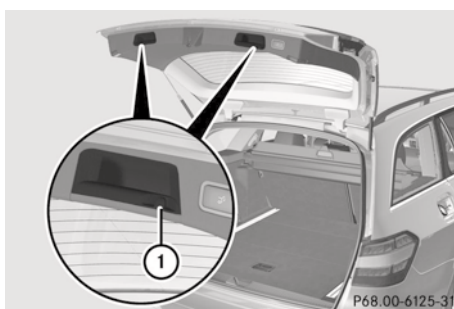

- ① Coat hooks

### EASY-PACK load-securing kit (Wagon)

#### Components and storage

The EASY-PACK load-securing kit allows you to use your cargo compartment for a variety of purposes. The accessory parts are located under the cargo compartment floor.

- Open the EASY-PACK folding luggage-compartment floor (▷ page 286).

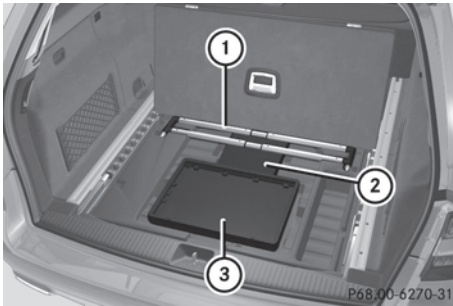

EASY-PACK load-securing kit accessory parts

- ① Telescopic rod
- ② Bag containing the brackets and luggage holder
- ③ Folding box

### Inserting the brackets into the loading rail

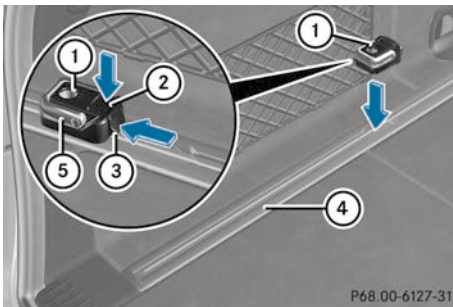

- ▶ Insert bracket ① into the center of loading rail ④.
- ▶ Press release button ② and push bracket ① into the desired position in loading rail ④.
- ▶ Let go of release button ②.
- ▶ Press locking button ③. Bracket ① is locked in loading rail ④.
- ▶ If necessary, fold cargo tie-down ring ⑤ upwards.

#### **WARNING**

Distribute the load on the cargo tie down rings evenly.

Otherwise, vehicle occupants could be injured by objects being thrown around if you:

- brake sharply
- change direction suddenly
- are involved in an accident

Please observe the loading guidelines.

### Luggage holder

The luggage holder can be used to secure light loads against the side wall of the cargo compartment to prevent them from moving around.

**!** Only use the luggage holder to secure cargo with a maximum weight of 15.4 lb (7 kg) and with dimensions that the luggage holder can safely and securely contain.

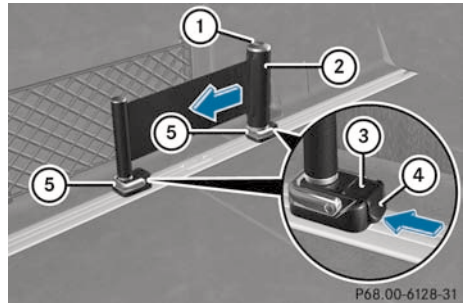

- ▶ **To install:** insert two brackets ⑤ into the left or right loading rail (▶ page 284).
- ▶ Press release button ① of the luggage holder and pull the strap out slightly.
- ▶ Insert luggage holder ② into brackets ⑤ and, while doing so, press release button ③ and push the luggage holder downwards until it engages.
- ▶ Press release button ① of the luggage holder and pull the strap out in the direction of the arrow.
- ▶ Place the load between the strap and the cargo compartment side wall.
- ▶ Using one hand, press locking button ① of the luggage holder.

- ▶ With your other hand, let the strap go slowly until the load is secured.
- ▶ Make sure that locking button ④ on brackets ⑤ is pressed. This keeps brackets ⑤ in place on the loading rail.
- ▶ **To remove:** press release button ③ on respective bracket ⑤ and remove luggage holder ② by pulling upwards and out.

### Telescopic rod

The telescopic rod can be used to secure the load against the rear seats to prevent it from moving around.

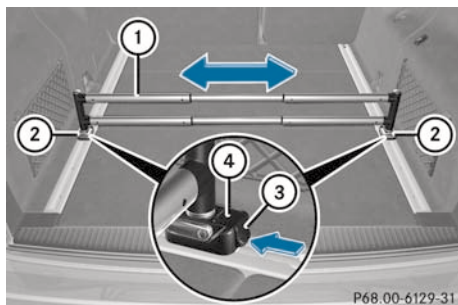

- ▶ **To install:** insert one bracket ② into both the left and the right loading rails and slide it to the desired position (▶ page 284).
- ▶ Insert telescopic rod ① into brackets ② and, while doing so, press release button ④ and push the rod downwards until it engages.
- ▶ Make sure that locking button ③ on brackets ② is pressed. This keeps brackets ② in place on the loading rail.
- ▶ **To remove:** press release button ④ on respective bracket ② and remove telescopic rod ① by pulling it upwards and out.

### Stowage well under the trunk floor (Sedan)

The TIREFIT kit, the vehicle tool kit, etc. are located in the stowage compartment.

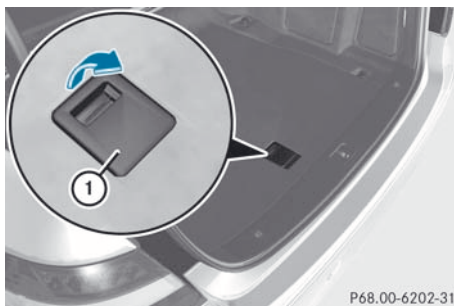

- ▶ **To open:** pull handle ① upwards.

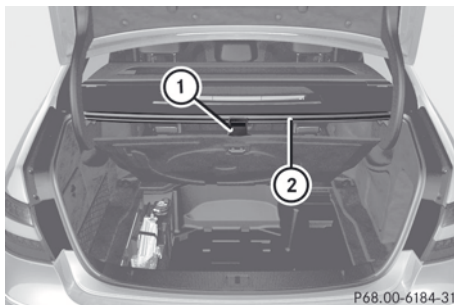

- ▶ Hook handle ① into rain trough ②.

**!** Unhook the handle before again before closing the trunk lid and clip it in securely to prevent the handle flap from protruding. Otherwise, you could damage the handle.

### EASY-PACK folding floor with stowage compartment under the trunk floor (Wagon)

#### Important safety notes

##### WARNING

Do not carry unsecured objects under the EASY-PACK folding luggage-compartment floor if it is open.

Otherwise, you and other vehicle occupants could be injured by objects being thrown



around the vehicle in the event of sharp braking, a sudden change in direction or an accident.

- ! Do not apply pressure to the EASY-PACK folding luggage-compartment floor when it is fully open. You may otherwise damage the hinges of the EASY-PACK folding luggage-compartment floor.

### Opening and closing the folding luggage-compartment floor

A removable insert under the EASY-PACK folding luggage-compartment floor contains the parts of the EASY-PACK load-securing kit and a folding box. Beneath the insert, you will find the TIREFIT kit, the "Minispare" emergency spare wheel, the vehicle tool kit, etc.

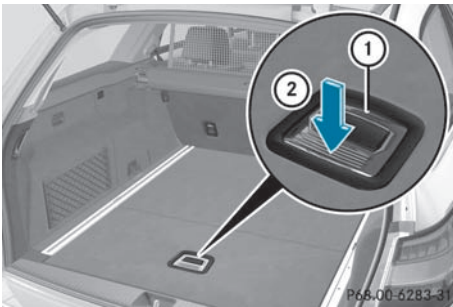

- ▶ **To open:** open the tailgate.
- ▶ Holding the ribbing, press handle ① downwards ②. Handle ① folds upwards.

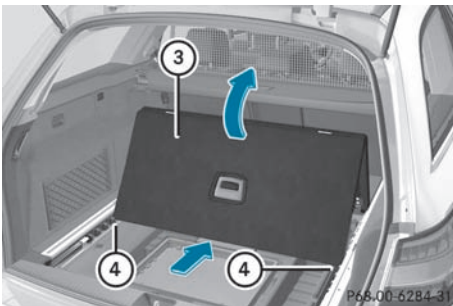

- ▶ Pull EASY-PACK folding luggage-compartment floor ③ in the direction of the arrow by handle ① until it reaches the desired position and engages in side ④.
- ▶ **To close:** disengage the EASY-PACK folding luggage-compartment floor and pull it back.
- ▶ Press the EASY-PACK folding luggage-compartment floor down ② until it engages.

### Installing and removing the folding luggage-compartment floor

- ▶ Remove the combined cargo cover and net (> page 283).

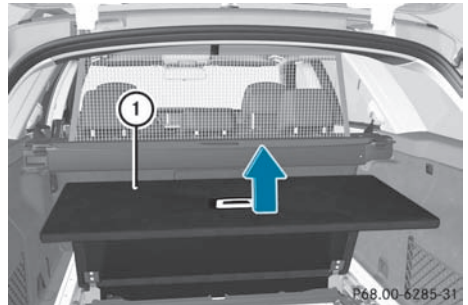

120° position

- ▶ **To remove:** move EASY-PACK folding luggage-compartment floor ① into the 120° position and lift it upwards.
- ▶ **To install:** push EASY-PACK folding luggage-compartment floor ① to the stop, move it into the 120° position and make sure it engages audibly.
- ▶ Pull EASY-PACK folding luggage-compartment floor ① forwards.

### EASY-PACK rear sill protector (Wagon)

The EASY-PACK rear sill protector is attached to the underside of the EASY-PACK folding luggage-compartment floor by means of magnets. It is designed to prevent clothing

becoming stained and the paintwork being scratched when loading.

- ▶ Open the EASY-PACK folding luggage-compartment floor (▶ page 286).

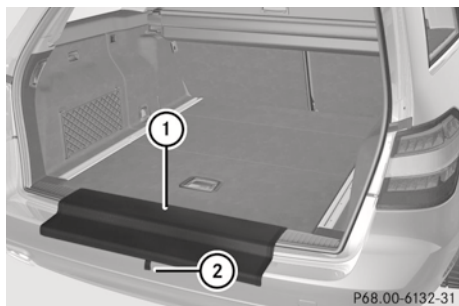

- ▶ Use tab ② to detach EASY-PACK rear sill protector ① from the magnets and place it over the loading sill.
- ▶ Close the EASY-PACK folding luggage-compartment floor.

- ❗ Before closing the tailgate, refasten the EASY-PACK rear sill protector on the underside of the EASY-PACK folding luggage-compartment floor.

The EASY-PACK rear sill protector could otherwise be damaged.

## Roof carrier

### Important safety notes

#### WARNING

Only use roof racks approved by Mercedes-Benz for your vehicle model to avoid damage to the vehicle.

Follow the manufacturer's installation instructions. Otherwise, an improperly attached roof rack system or its load could become detached from the vehicle.

Do not exceed the maximum roof load of 220 lb (100 kg).

Take into consideration that when the roof rack is loaded, the handling characteristics

are different from those when operating the vehicle without the roof rack loaded.

- ❗ Mercedes-Benz recommends that you only use roof carriers that have been tested and approved for Mercedes-Benz vehicles. This helps to prevent damage to the vehicle.

Position the load on the roof carrier in such a way that the vehicle will not sustain damage even when it is in motion.

Ensure that when the roof carrier is installed:

- you can raise the sliding sunroof or the panorama roof with power tilt/sliding panel fully (depending on the vehicle's equipment)
- you can open the tailgate or trunk lid fully
- the roof carrier does not come into contact with the antenna

- ❗ To avoid damaging or scratching the covers, do not use metallic or hard objects to open them.

### Attaching the roof carrier (Sedan)

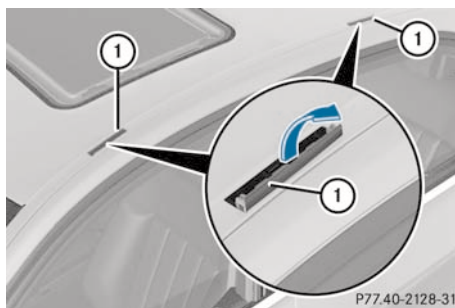

Vehicles with a steel roof or sliding sunroof (illustration)

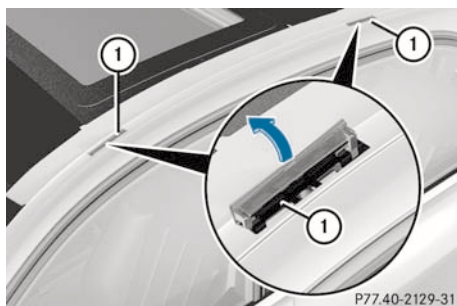

Vehicles with a panorama roof with power tilt/sliding panel

- ▶ Open covers ① carefully in the direction of the arrow.
- ▶ Fold covers ① upwards.
- ▶ Only secure the roof carrier to the anchorage points under covers ①.
- ▶ Observe the manufacturer's installation instructions.

### Attaching the roof carrier (Wagon)

- ▶ Secure the roof carrier to the roof rails.
- ▶ Observe the manufacturer's installation instructions.

## Features

### Cup holders

#### Important safety notes

#### WARNING

In order to help prevent spilling liquids on vehicle occupants and/or vehicle equipment, only use containers that fit into the cup holder. Use lids on open containers and do not fill containers to a height where the contents, especially hot liquids, could spill during braking, vehicle maneuvers, or in an accident. Liquids spilled on vehicle occupants may cause serious personal injury. Liquids spilled on vehicle equipment may cause damage not covered by the Mercedes-Benz Limited Warranty.

When not in use, keep the cup holder closed. An open cup holder may cause injury to you or others when contacted during braking, vehicle maneuvers, or in an accident.

Keep in mind that objects placed in the cup holder may come loose during braking, vehicle maneuvers, or in an accident and be thrown around in the vehicle interior. Objects thrown around in the vehicle interior may cause an accident and/or serious personal injury.

### Cup holder in the front-compartment center console

You can remove the cup holder to clean it. Clean with clear, lukewarm water only.

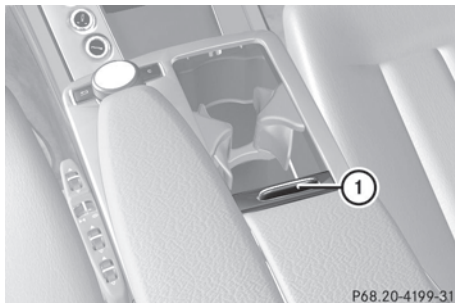

E 63 AMG

- ▶ **To open:** slide cover ① back.

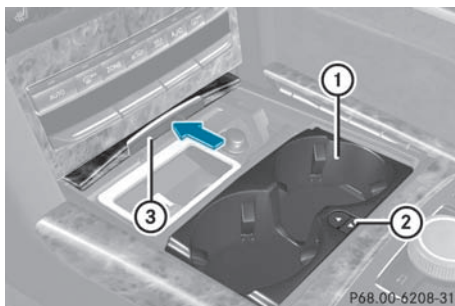

All vehicles except E 63 AMG

- ▶ **To open:** slide cover ③ forwards until it engages.
- ▶ **To remove:** slide catch ② forwards and pull out cup holder ①.

- ▶ **To insert:** insert cup holder ① and slide back catch ②.
- ▶ **To close:** press cover ③ briefly at the front.  
Cover ② moves back.

### Cup holder in the rear seat armrest

- ❗ Do not sit on or support your body weight on the rear seat armrest when it is folded down, as you could otherwise damage it.
- ❗ Close the cup holder before folding the rear seat armrest up. Otherwise, the cup holder could be damaged.

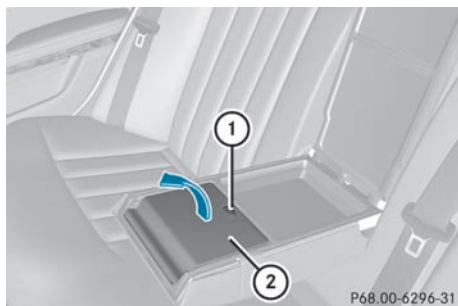

- ▶ Fold down the rear seat armrest.
- ▶ **To open:** raise the rear seat armrest cover.
- ▶ Press release catch ①.  
Cup holder ② folds out forwards.
- ▶ Swing the rear seat armrest cover back down, if necessary.
- ▶ **To close:** raise the rear seat armrest cover.  
Swing cup holder ② back until it engages.

### Bottle holder

#### ⚠ WARNING

Do not transport heavy, sharp-edged, or fragile bottles in the bottle holder.

In the event of an accident, the bottle holder cannot secure a bottle sufficiently. You and/or vehicle occupants could be injured.

- ❗ Make sure that any bottles weighing more than 0.5 kg that are stored in the bottle holder rest on the vehicle floor. The bottle holder could otherwise be damaged.

The bottle holder is suitable for bottles sized between 25 fl.oz (0.7 l) and 54 fl.oz (1.5 l).

The bottle holder does not secure the bottles; it merely prevents them from tipping over.

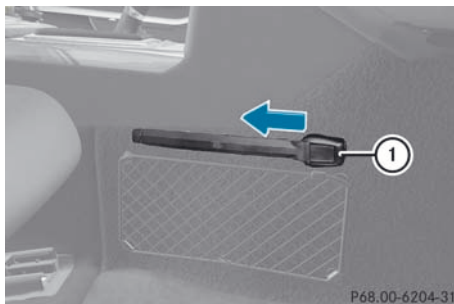

- ▶ Press the outer edge of button ① and slide in the direction of the arrow until the bottle fits into the opening.
- ▶ Insert the bottle into the bottle holder.

### Sun visors

#### Overview of sun visors

#### ⚠ WARNING

Do not use the vanity mirror while driving. Keep the vanity mirrors in the sun visors closed while the vehicle is in motion. Reflected glare can endanger you and others.

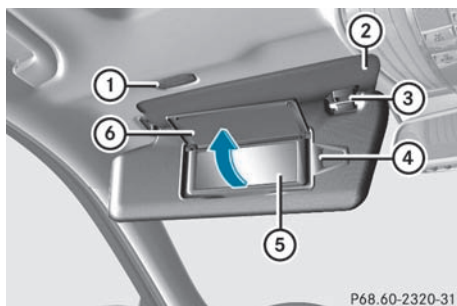

P68.60-2320-31

- ① Mirror light
- ② Additional sun visor
- ③ Bracket
- ④ Retaining clip, e.g. for a car park ticket
- ⑤ Vanity mirror
- ⑥ Mirror cover

### Vanity mirror in the sun visor

Mirror light ① only functions if the sun visor is clipped into retainer ③ and mirror cover ⑥ has been folded up.

### Glare from the side

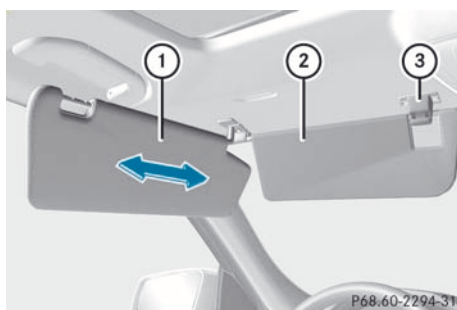

P68.60-2294-31

- ▶ Fold down sun visor ①.
- ▶ Pull sun visor ① out of retainer ③.
- ▶ Swing sun visor ① to the side.
- ▶ **Vehicles with an additional sun visor:** slide sun visor ① horizontally as desired.
- ▶ Fold down additional sun visor ②.

### Sunblinds on the rear side windows

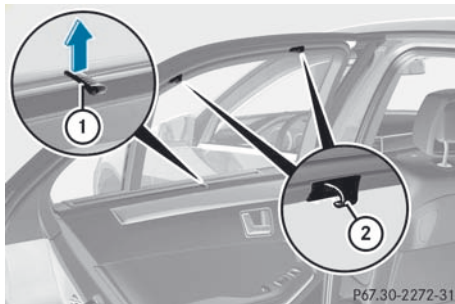

P67.30-2272-31

- ▶ **To extend:** pull the roller sunblind out by tab ① and hook it onto retainers ② at the top of the window.

⚠ Always guide the roller sunblind by hand. Do not let it snap back suddenly as this would damage the automatic roller mechanism.

⚠ Do not drive the vehicle with the roller sunblind hooked in and the side windows opened simultaneously. The roller sunblind can jump out of the retainers and spring back suddenly when driving at high speeds, e.g. when driving on the freeway. This could damage the inertia reel. Therefore, either close the side window or retract the roller sunblind before driving at high speeds.



## Rear window roller sunblind (Sedan)

### Important safety notes

#### WARNING

When leaving the vehicle, always remove the SmartKey from the ignition lock. Always take the SmartKey with you and lock the vehicle. Do not leave children unattended in the vehicle, even if they are secured in a child restraint system, or with access to an unlocked vehicle. A child's unsupervised access to a vehicle could result in an accident and/or serious personal injury. The children could:

- injure themselves on parts of the vehicle
- be seriously or fatally injured through excessive exposure to extreme heat or cold
- injure themselves or cause an accident with vehicle equipment that can be operated even if the SmartKey is removed from the ignition lock or removed from the vehicle, such as seat adjustment, steering wheel adjustment, or the memory function

If children open a door, they could injure other persons or get out of the vehicle and injure themselves or be injured by following traffic.

Do not expose the child restraint system to direct sunlight. The child restraint system's metal parts, for example, could become very hot, and the child could be burned on these parts.

#### WARNING

When adjusting a roller sunblind, the roller blind moves up or down. You might become trapped in the process.

In the event of danger, briefly press the button for the roller sunblind to change the roller blind's direction of movement.

### Extending/retracting the roller sunblind

- ❗ Make sure that the roller sunblind can move freely. Otherwise, the roller sunblind or other objects could be damaged.

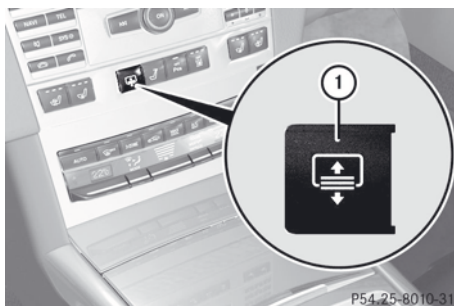

- ▶ Turn the key to position **2** in the ignition lock.
- ▶ **To extend or retract:** briefly press button **1**.  
The roller sunblind fully extends or fully retracts.

## Ashtray

### Ashtray in the front-compartment center console

- i** You can remove the ashtray insert and use the resulting compartment for stowage.
- ❗ The stowage space under the ashtray is not heat resistant. Before placing lit cigarettes in the ashtray, make sure that the ashtray is properly engaged. Otherwise, the stowage space could be damaged.

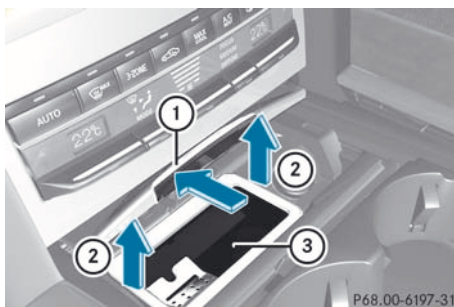

- ▶ **To open:** slide cover **1** forwards until it engages.
- ▶ **To remove insert:** hold insert **3** by the ribbing at the sides and lift it up **2** and out.

- ▶ **To re-install the insert:** press insert ③ into the holder until it engages.
- ▶ **To close:** press cover ① briefly at the front. The cover moves back.

### Ashtray in the rear-compartment center console

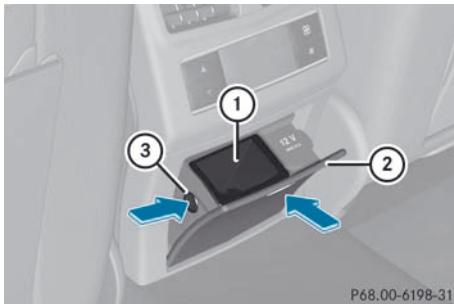

- ▶ **To open:** briefly press cover ② at the top. The ashtray opens.
- ▶ **To remove the insert:** press release button ③ and lift the insert up and out.
- ▶ **To install the insert:** install insert ① from above into the holder and press down into the holder until it engages.

### Cigarette lighter

#### ⚠ WARNING

When leaving the vehicle, always remove the SmartKey from the ignition lock. Always take the SmartKey with you and lock the vehicle. Do not leave children unattended in the vehicle, even if they are secured in a child restraint system, or with access to an unlocked vehicle. A child's unsupervised access to a vehicle could result in an accident and/or serious personal injury. The children could:

- injure themselves on parts of the vehicle
- be seriously or fatally injured through excessive exposure to extreme heat or cold
- injure themselves or cause an accident with vehicle equipment that can be operated even if the SmartKey is removed from the ignition lock or removed from the vehicle, such as seat adjustment, steering wheel adjustment, or the memory function

If children open a door, they could injure other persons or get out of the vehicle and injure themselves or be injured by following traffic.

Do not expose the child restraint system to direct sunlight. The child restraint system's metal parts, for example, could become very hot, and the child could be burned on these parts.

#### ⚠ WARNING

Never touch the heating element or sides of the lighter; they are extremely hot. Hold the knob only.

Make sure any children traveling with you do not injure themselves or start a fire with the hot cigarette lighter.

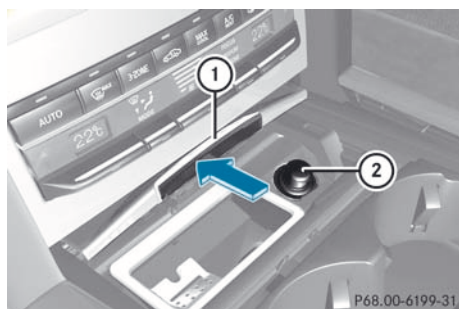

- ▶ Turn the SmartKey to position **2** in the ignition lock.
- ▶ **To open:** slide cover **1** forwards until it engages.
- ▶ Press in cigarette lighter **2**. Cigarette lighter **2** will pop out automatically when the heating element is red-hot.
- ▶ **To close:** press cover **1** briefly at the front. The cover moves back.

### 12 V sockets

#### Points to observe before use

The sockets can be used for accessories, e.g. lamps or mobile phone chargers with a maximum current draw of 180 W (15 A). If you use the sockets for long periods when the engine is switched off, the battery may discharge.

- ▶ Turn the SmartKey to position **1** in the ignition lock.
- i** An emergency cut-out ensures that the on-board voltage does not drop too low. If the on-board voltage is too low, the power to the sockets is automatically cut. This ensures that there is sufficient power to start the engine.

#### Socket in the front-compartment center console

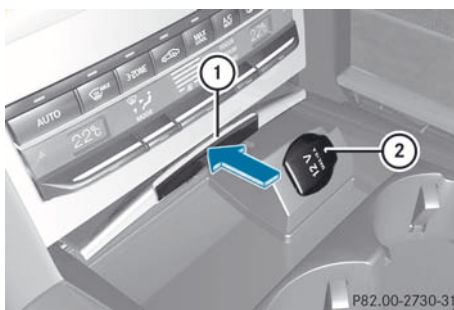

- ▶ **To open:** slide cover **1** forwards until it engages.
- ▶ Lift up the cover of socket **2**.
- ▶ **To close:** press cover **1** briefly at the front. The cover moves back.

#### Socket in the rear-compartment center console

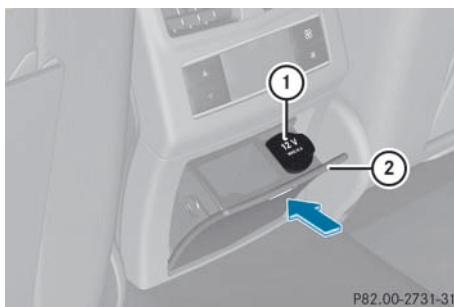

- ▶ Briefly press cover **2** at the top. The cover opens.
- ▶ Lift up the cover of socket **1**.



## Socket in the trunk/cargo compartment

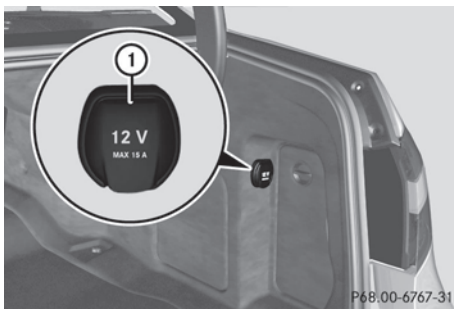

Power socket in the trunk (Sedan)

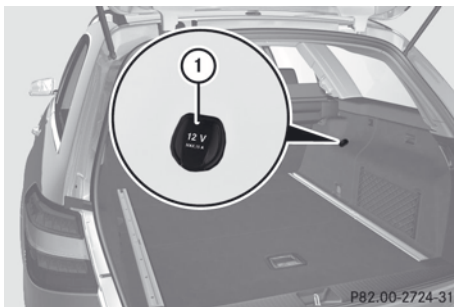

Power socket in the cargo compartment (Wagon)

- ▶ Lift up the cover of socket ①.

### 115 V power socket

#### WARNING

The 115V AC socket operates at high voltage. Use the 115V AC socket in the vehicle with the same caution and prudence that you exercise when using power outlets at home. Keep any fluids away from the 115V AC socket. Do not clean the socket with fluids or tapered objects. Keep the 115V AC socket cover in the closed position, when not in use. Otherwise, you could suffer an electric shock and be seriously or even fatally injured.

#### WARNING

Any device that you connect must have a suitable plug and meet U.S. standards. Never pull at a cable to disconnect a plug from a

115 V AC power socket. Never use a damaged connection cable. The 115 V AC power socket must never be connected to another 115 V AC power source. Do not use a converter with an earthed plug for the 115 V AC power socket. This could cause serious injury to you and/or other people.

#### WARNING

If the 115V AC socket is damaged or torn out of the trim, do not use or touch the 115V AC socket. Using a 115V AC socket that is damaged or torn out of the trim could cause serious personal injury to you and/or others.

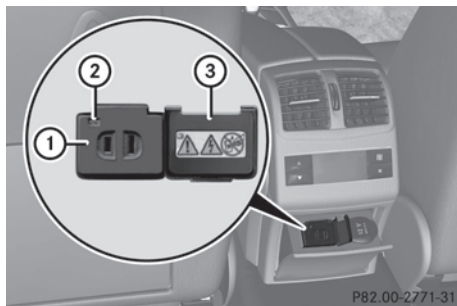

115 V socket ① provides an alternating voltage of 115 V, so that small electronic devices can be connected. These devices, such as games consoles, chargers and laptops, together should not consume more than a maximum of 150 W.

Requirements for operation of these devices:

- the plug of the electronic device must be inserted fully into 115 V power socket ①.
- the maximum wattage of the device to be connected must not exceed 150 W.
- the on-board power supply is within a permissible volt range.
- the 12 V sockets in the rear and the cargo compartment/trunk are operational (> page 294).

- ▶ Open flap ③.
- ▶ Insert the plug of the electronic device into 115 V power socket ①. Indicator lamp ② lights up.

If indicator lamp ② does not light up, consult the section on malfunctions.

- ▶ **To turn off:** disconnect the plug from 115 V power socket ①.

Ensure that you do not pull on the cord.

- ▶ Close flap ③.

Possible causes of malfunction:

- the on-board power supply is not within a permissible volt range.
- the temperature of the DC/AC converter is temporarily too high.
- some small electronic devices have a constant nominal power of less than 150 W, but a very high inrush current. These devices will not work. If you connect such a device, 115 V power socket ① will not supply it with power.

If indicator lamp ② still does not light up, contact a specialist workshop, e.g. an authorized Mercedes-Benz Center.

## mbrace

### Important safety notes

- ❗ A license agreement must exist in order to activate the mbrace service. Ensure that your system is activated and ready for use, and press the  MB Info call button to register. If any of the steps mentioned is not carried out, the system may not be activated.

If you have questions about the activation, contact one of the following telephone assistance services:

- **USA:** Mercedes-Benz Customer Assistance Center under 1-800-FOR-MERCEdes (1-800-367-6372) or 1-888-990-9007
- **Canada:** Customer Service at 1-888-923-8367

Shortly after successfully registering with the mbrace service, a user ID and password will be sent to you by post. You can use this password to log in to the mbrace section under "Owners Online" at <http://www.mbusa.com><sup>24</sup>.

The mbrace system is available if:

- it has been activated and is operational.
- the corresponding mobile phone network is available for transmitting data to the Customer Center.
- a service subscription is available.
- the starter battery is sufficiently charged.



- ❗ Determining the location of the vehicle on a map is only possible if there is sufficient GPS reception and the vehicle position can be forwarded to the Customer Center.

### The mbrace system

The mbrace system provides different services, e.g.:

- automatic and manual emergency call
- Roadside Assistance call
- MB Info call

To adjust the volume during an mbrace call, proceed as follows:

- ▶ Press the  or  button on the multifunction steering wheel.

or

- ▶ Use the volume controller of COMAND.

You can find further information and a description of all available features under "Owners Online" at <http://www.mbusa.com><sup>25</sup>.

### System self-test





After you have switched on the ignition, the system carries out a self-diagnosis.

<sup>24</sup> USA only.

<sup>25</sup> USA only.

**⚠ WARNING**

A malfunction in the system has been detected if one of the following conditions occurs:

- the indicator lamp in the SOS button does not light up during the system self-diagnosis.
- the indicator lamp in the  Roadside Assistance button does not light up during the system self-diagnosis.
- The indicator lamp in the  information button does not light up during self-diagnosis of the system.
- the indicator lamp in the SOS button,  Roadside Assistance button or  information button continues to be lit red after the system self-diagnosis.
- The **Tele Aid Inoperative** or **Tele Aid Not Activated** message appears in the multifunction display after the system self-test.

If a malfunction is indicated as outlined above, the system may not operate as expected. In the event of an emergency, assistance must be summoned by other means.

Have the system checked at the nearest authorized Mercedes-Benz Center or contact the following service hotlines:

- **USA:** Mercedes-Benz Customer Assistance Center under 1-800-FOR-MERCEdes(1-800-367-6372) or 1-888-990-9007
- **Canada:** Customer Service at 1-888-923-8367

## Emergency call

### Important safety notes

**!** A license agreement must exist in order to activate the mbrace service. Ensure that your system is activated and ready for use, and press the  MB Info call button to register. If any of the steps mentioned is not carried out, the system may not be activated.

If you have questions about the activation, contact one of the following telephone assistance services:

- **USA:** Mercedes-Benz Customer Assistance Center under 1-800-FOR-MERCEdes (1-800-367-6372) or 1-888-990-9007
- **Canada:** Customer Service at 1-888-923-8367

An emergency call is dialed automatically if an air bag or Emergency Tensioning Device is triggered.

**i** An mbrace emergency call that has been initiated automatically cannot be terminated by the customer.

An emergency call can also be initiated manually.

As soon as the emergency call has been initiated, the indicator lamp in the SOS button flashes. The **Connecting Call** message appears on the multifunction display.

The audio output is muted.

Once a connection has been established, the **Call Connected** message appears in the multifunction display.

All important information on the emergency is transmitted, for example:

- current location of the vehicle (as determined by the GPS system)
- vehicle identification number
- information on the type of emergency

Shortly after the emergency call has been initiated, a voice connection is automatically established between the Mercedes-Benz Customer Assistance Center and the vehicle occupants. If the vehicle occupants respond, the Mercedes-Benz Customer Assistance Center attempts to get more information on the emergency.

**i** If no vehicle occupant answers, an ambulance is immediately sent to the vehicle.

### WARNING

If the indicator lamp in the SOS button is flashing continuously and no voice connection to the Mercedes-Benz Customer Assistance Center was established, then the mbrace system could not initiate an emergency call (e.g. the relevant cellular phone network is not available).

The message **Call Failed** appears in the multifunction display for approximately 10 seconds.

Should this occur, assistance must be summoned by other means.

### Making an emergency call

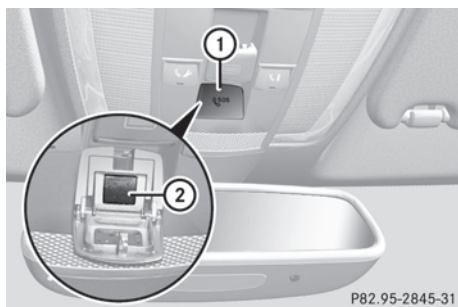

- ▶ **To initiate an emergency call manually:** press cover ① briefly to open it.
- ▶ Press SOS button ② briefly. The indicator lamp in SOS button ② flashes until the emergency call is concluded.
- ▶ Wait for a voice connection to the Mercedes-Benz Customer Assistance Center.
- ▶ After the emergency call is ended, close cover ①.

### WARNING

If you feel in any way in jeopardy when in the vehicle (e.g. smoke or fire in the vehicle, vehicle in a dangerous road location), please do not wait for voice contact after you have pressed the SOS button. Carefully leave the vehicle and move to a safe location. The

Mercedes-Benz Customer Assistance Center will automatically contact local emergency officials with the vehicle's approximate location if they receive an automatic SOS signal and cannot make voice contact with the vehicle occupants.

### Roadside Assistance button



- ▶ Press and hold Roadside Assistance button ① for more than two seconds. This initiates a call to the Mercedes-Benz Customer Assistance Center. The indicator lamp in Roadside Assistance button ① flashes while the call is active. The **Connecting Call** message appears in the multifunction display. The audio output is muted.

If a connection can be established, the **Call Connected** message appears in the multifunction display.

If a cellular phone network is available and there is sufficient GPS reception, the mbrace system transmits data to the Mercedes-Benz Customer Assistance Center, for example:

- current location of the vehicle
- vehicle identification number

**i** The COMAND display shows that an mbrace call is active. During the call, you can change to the navigation menu by pressing the NAVI button on COMAND, for example.

Voice output is not available.

A voice connection is established between the Mercedes-Benz Customer Assistance Center and the vehicle occupants.

- Describe the type of assistance needed.

The Mercedes-Benz Customer Assistance Center either sends a qualified Mercedes-Benz technician or organizes for your vehicle to be transported to the nearest authorized Mercedes-Benz Center. You may be charged for services such as repair work and/or towing. Further details are available in your mbrace manual.

**i** The mbrace system failed to initiate a Roadside Assistance call if:

- the indicator lamp in Roadside Assistance button ① is flashing continuously.
- no voice connection to the Mercedes-Benz Customer Assistance Center was established.

This may be because the corresponding mobile phone network is not available.

The **Call Failed** message appears in the multifunction display.

- **To end a call:** press the  button on the multifunction steering wheel.

or

- Press the corresponding button for ending a phone call on COMAND.

### MB Info call button



- Press and hold MB Info call button ① for more than two seconds. This initiates a call to the Mercedes-Benz Customer Assistance Center. The indicator lamp in MB Info call button ① flashes while the connection is being established. The **Connecting Call** message appears in the multifunction display. The audio output is muted.

If a connection can be established, the **Call Connected** message appears in the multifunction display.

If a cellular phone network is available and there is sufficient GPS reception, the mbrace system transmits data to the Mercedes-Benz Customer Assistance Center, for example:

- current location of the vehicle
- vehicle identification number

**i** The COMAND display shows that an mbrace call is active. During the call, you can change to the navigation menu by pressing the NAVI button on COMAND, for example.

Voice output is not available.

A voice connection is established between the Mercedes-Benz Customer Assistance Center and the vehicle occupants. You can obtain information on how to operate your vehicle's systems, on the location of the nearest authorized Mercedes-Benz Center, and on further products and services offered by Mercedes-Benz USA.

Further details on the mbrace system can be found under <http://www.mbusa.com><sup>26</sup>. Log in under "Owners Online".

**i** The mbrace system failed to initiate an MB Info call if:

- the indicator lamp in MB Info call button ① is flashing continuously.
- no voice connection to the Mercedes-Benz Customer Assistance Center was established.

<sup>26</sup> USA only.

This may be because the corresponding mobile phone network is not available. The **Call Failed** message appears in the multifunction display.

▶ **To end a call:** press the  button on the multifunction steering wheel.

or

▶ Press the corresponding button for ending a phone call on COMAND.

### Call priority

When service calls are active, e.g. Roadside Assistance or MB Info calls, an emergency call can still be initiated. In this case, an emergency call will take priority and override all other active calls.

The indicator lamp of the respective button flashes until the call is ended. An emergency call can only be terminated by the Mercedes-Benz Customer Assistance Center. All other calls can be ended by pressing the  button on the multifunction steering wheel or the corresponding button for ending a telephone call on COMAND.

**i** If an mbrace call is initiated, audio output is muted. The mobile phone is no longer connected to COMAND. However, if you want to use your mobile phone, we recommend that you do this only when the vehicle is stationary and in a safe location.

### Downloading destinations in COMAND

**i** Information on the components and operating principles of COMAND can be found in the separate COMAND operating instructions.

**i** You can only use the Destination Download function if the vehicle is equipped with a navigation system.

Destination Download gives you access to a database with over 15 million points of interest (POIs)/important destinations that can be downloaded onto the navigation system of your vehicle. If you know the

destination, you can download the address or obtain the location of points of interest (POIs)/important destinations in the surrounding area.

You are prompted to confirm route guidance to the address entered.

The system calculates the route and subsequently starts the route guidance with the address entered.

**i** If you select **No**, the address can be stored in the address book.

**i** The Destination Download function is available if the corresponding mobile phone network is available and data transfer is possible.

### Route Assistance

This service is part of the mbrace PLUS Package and cannot be purchased separately.

**i** You can also use the Route Assistance function if your vehicle is not equipped with a navigation system.

Within the framework of this service, you receive a professional and reliable form of navigation support without having to leave your vehicle.

The customer service representative determines a suitable driving route based on your current vehicle position and the desired destination and guides you live through the current sections of the route.

### Search & Send

"Search & Send" is a destination entry service. You can find further information on "Search & Send" in the separate COMAND operating instructions.

### Vehicle remote opening

If you have unintentionally locked your vehicle (e.g. the SmartKey is still in the vehicle) and a replacement SmartKey is not



available, the vehicle can be opened by a Mercedes-Benz Customer Assistance Center.

The vehicle can be opened remotely up to four days after the ignition was last switched off.

► Contact the following service hotlines:

- **USA:** Mercedes-Benz Customer Assistance Center under 1-800-FOR-MERCedes(1-800-367-6372) or 1-888-990-9007
- **Canada:** Customer Service at 1-888-923-8367

You will be asked for your password.

- Return to your vehicle at the time agreed upon with the Mercedes-Benz Customer Assistance Center.
- Pull the trunk handle/tailgate handle for at least 20 seconds until the indicator lamp in the SOS button (► page 297) flashes. The **Connecting Call** message appears on the multifunction display.

Alternatively, the vehicle can also be opened via the Internet or an iPhone in the "Owners Online" section using your ID number and password<sup>27</sup>.

**i** Vehicle remote unlocking is only possible if the corresponding mobile phone network is accessible.

The SOS button flashes and the **Connecting Call** message appears in the multifunction display to confirm that the command for vehicle remote unlocking has been received.

If you pull the trunk handle for more than 20 seconds before receiving authorization for remote unlocking, you must wait 15 minutes before you can pull the trunk lid handle again.

### **Vehicle remote closing**

If you forget to lock your vehicle but are no longer in the vicinity of the vehicle, it can be locked for you by the Mercedes-Benz Customer Assistance Center.

The vehicle can be locked remotely up to four days after the ignition was last switched off.

► Contact the following service hotlines:

- **USA:** Mercedes-Benz Customer Assistance Center under 1-800-FOR-MERCedes(1-800-367-6372) or 1-888-990-9007
- **Canada:** Customer Service at 1-888-923-8367

You will be asked for your PIN.

The next time you are in your vehicle and switch on the ignition, the **Tele Aid Doors locked by remote control** message appears in the multifunction display.

Alternatively, the vehicle can also be locked via the Internet or an iPhone in the "Owners Online" section using your ID number and password.

**i** The vehicle valet locking feature is available when the relevant mobile phone network is available and data connection is possible.

### **Service for recovering a stolen vehicle**

If your vehicle has been stolen:

- Notify the police. The police will issue a numbered incident report.
- This number will be forwarded to the Mercedes-Benz Customer Assistance Center together with your PIN. The Mercedes-Benz Customer Assistance Center then attempts to locate the mbrace system. The Mercedes-Benz Customer Assistance Center contacts you and the local law enforcement agency if the vehicle is located. However, only the law enforcement agency is informed of the location of the vehicle.

**i** If the anti-theft alarm system is active for longer than 30 seconds, mbrace automatically informs the Mercedes-Benz Customer Assistance Center.

<sup>27</sup> USA only.

## Garage door opener

### Important safety notes

The HomeLink® garage door opener integrated in the rear-view mirror allows you to operate up to three different door and gate systems.

**i** Certain garage door drives are incompatible with the integrated garage door opener. If you have difficulty programming the integrated garage door opener, contact an authorized Mercedes-Benz Center or call one of the following telephone hotlines:

- **USA:** Mercedes-Benz Customer Assistance Center at 1-800-FOR-MERCedes
- **Canada:** Customer Service at 1-800-387-0100

#### WARNING

Before programming the integrated remote control to a garage door opener or gate operator, make sure people and objects are out of the way of the device to prevent potential harm or damage. When programming a garage door opener, the door moves up or down. When programming a gate operator, the gate opens or closes.

Do not use the integrated remote control with any garage door opener that lacks safety stop and reverse features as required by U.S. federal safety standards (this includes any garage door opener model manufactured before April 1, 1982). A garage door that cannot detect an object - signaling the door to stop and reverse - does not meet current U.S. federal safety standards.

When programming a garage door opener, park vehicle outside the garage.

Do not run the engine while programming the integrated remote control. Inhalation of exhaust gas is hazardous to your health. All exhaust gas contains carbon monoxide (CO), and inhaling it can cause unconsciousness and possible death. All exhaust gas contains

carbon monoxide (CO), and inhaling it can cause unconsciousness and possible death.

**i** USA only:

This device complies with part 15 of the FCC Rules. Operation is subject to the following two conditions:

1. This device may not cause harmful interference, and
2. this device must accept any interference received, including interference that may cause undesired operation.

Any unauthorized modification to this device could void the user's authority to operate the equipment.

FCC ID: CB2HMIHL4

**i** Canada only:

This device complies with RSS-210 of Industry Canada. Operation is subject to the following two conditions:

1. This device may not cause interference, and
2. this device must accept any interference received, including interference that may cause undesired operation of the device.

Any unauthorized modification to this device could void the user's authority to operate the equipment.

IC: 279B-HMIHL4

## Programming the integrated garage door opener on the rear-view mirror

### Programming

#### WARNING

Only press the transmitter button on the integrated garage door opener if there are no persons or objects present within the sweep of the garage door. People could otherwise be injured by the movement of the door.



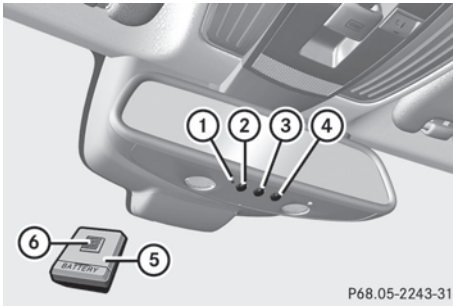

Integrated garage door opener on the rear-view mirror

Garage door remote control ⑤ is not part of this integrated garage door opener.

- i** To achieve the best result, insert new batteries in garage door remote control ⑤ before programming.
- ▶ Before programming for the first time, clear the memory of the integrated garage door opener (▶ page 305).
- ▶ Turn the SmartKey to position **2** in the ignition lock.
- ▶ Press and hold one of transmitter buttons ② to ④ on the integrated garage door opener.  
Indicator lamp ① starts to flash yellow after a short period.
- i** Indicator lamp ① flashes yellow immediately after the transmitter button has been stored for the first time. If the transmitter button has already been programmed, indicator lamp ① does not flash yellow until 10 seconds have elapsed.
- ▶ Release the transmitter button.
- ▶ Point transmitter button ⑥ of garage door remote control ⑤ towards the transmitter buttons on the rear-view mirror at a distance of 2 to 8 inches (5 to 20 cm).
- i** The distance required between garage door remote control ⑤ and the integrated garage door opener depends on the system of the garage door drive. You might require several attempts. You should test every

position for at least 25 seconds before trying another position.

- ▶ Press and hold transmitter button ⑥ on garage door remote control ⑤ until indicator lamp ① lights up green. Programming is complete if indicator lamp ① lights up or flashes green.
- ▶ Release transmitter button ②, ③ or ④ on the integrated garage door opener and the transmitter button on garage door remote control ⑥.

If indicator lamp ① lights up red:

- ▶ Repeat the programming procedure for the transmitter button. When doing so, vary the distance between the garage door remote control and the rear-view mirror.
- i** If the indicator lamp flashes green after successful programming, the garage door system is operating on a rolling code. After programming, you must synchronize the garage door opener integrated in the rear-view mirror with the receiver of the garage door system.

### Synchronizing the rolling code

Your vehicle must be within range of the garage or gate opener drive. Make sure that neither your vehicle nor any persons/objects are present within the sweep of the door or gate.

Observe the safety notes when performing the rolling code synchronization.

- ▶ Turn the SmartKey to position **2** in the ignition lock.
- ▶ Press the programming button of the door or gate drive (see the door or gate drive operating instructions, e.g. under "Programming of additional remote controls").
- i** You now normally have 30 seconds to initiate the next step.
- ▶ Press the previously programmed transmitter button of the HomeLink®

integrated garage door opener repeatedly in succession until the door opens. The rolling code synchronization is then complete.

### Notes on programming the remote control

Canadian radio frequency laws require a "break" (or interruption) of the transmission signals after broadcasting for a few seconds. These signals may not therefore last long enough for the integrated garage door opener to recognize the signal during programming. Comparable with Canadian law, some U.S. garage door openers also have a built-in "interruption".

If you live in Canada or have difficulties programming the garage door opener (regardless of where you live) when using the programming steps (see above), proceed as follows:

- ▶ Press and hold one of transmitter buttons ② to ④ of the integrated garage door opener. Indicator lamp ① starts to flash yellow after a short period.
- ▶ Release the transmitter button.
- ▶ Press transmitter button ⑥ of the garage door remote control and hold for two seconds, then release for two seconds, then press again and hold for two seconds.
- ▶ Repeat this sequence on transmitter button ⑥ of the garage door remote control until indicator lamp ① is green. Repeat the process if indicator lamp ① turns red.
- ▶ Continue with the other programming steps (see above).

### Problems when programming

If you are experiencing problems programming the integrated garage door opener on the rear-view mirror, take note of the following instructions:

- check the transmission frequency of garage door remote control ⑤ (usually

found on the reverse side of the remote control).

The integrated garage door opener is compatible with devices that can be operated with units in a frequency range of 280 to 390 MHz.

- change the batteries in garage door remote control ⑤. This increases the probability that garage door remote control ⑤ will send a strong and precise signal to the integrated garage door opener on the rear-view mirror.
- when programming, hold garage door remote control ⑤ at different distances and angles from the transmitter button that you are programming. Try different angles at a distance between 2 and 12 inches (5 to 30 cm) or the same angle at varying distances.
- if another remote control for the same garage door drive is available, repeat the same programming steps with this remote control. Before you perform the steps of the operation, make sure that there are new batteries in the garage door remote control.
- note that some remote controls only transmit for a limited amount of time (the indicator lamp on the remote control goes out). Press the remote control button again before it stops transmitting.
- align the antenna cable of the garage door opener unit. This can improve signal reception/transmission.

### Opening/closing the garage door

Once programmed, the integrated garage door opener will assume the function of the garage door system's remote control. Please also read the operating instructions for the garage door system.

- ▶ Turn the SmartKey to position **2** in the ignition lock.
- ▶ Press transmitter button **(2)**, **(3)** or **(4)** in the overhead control panel that you have programmed to operate the garage door. Garage door system with a fixed code: indicator lamp **(1)** lights up green.

Garage door system with a rolling code: indicator lamp **(1)** flashes green.

- i** The transmitter will transmit a signal for as long as the transmitter button is being pressed. After a maximum of ten seconds, transmission is terminated and indicator lamp **(1)** flashes yellow. Press the transmitter button again, if necessary.

### Clearing the memory of the integrated garage door opener on the rear-view mirror

- ▶ Turn the SmartKey to position **2** in the ignition lock.
- ▶ Press transmitter buttons **(2)** and **(4)**. The indicator lamp lights up yellow.
- ▶ Press and hold transmitter buttons **(2)** and **(4)** until the indicator lamp turns green.

- i** Make sure that you clear the memory of the integrated garage door opener before selling the vehicle.

### Compass

#### Calling up the compass

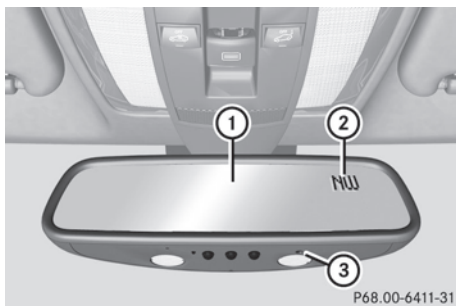

P68.00-6411-31

To obtain a correct display in rear-view mirror **(1)**, the compass must be calibrated and the magnetic field zone must be set.

- ▶ Press button **(3)** briefly. The compass shows which direction the vehicle is currently traveling in: **N, NE, E, SE, S, SW, W** or **NW**.

### Setting the compass

- ▶ Determine your position using the following zone maps.

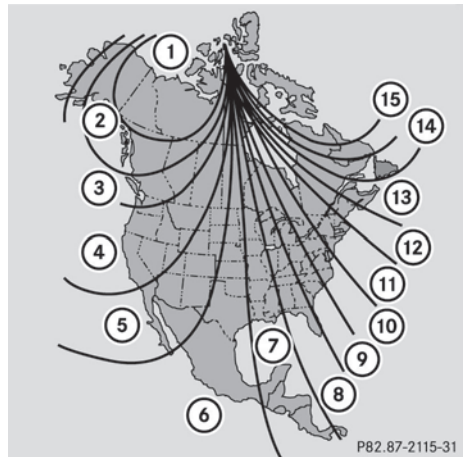

P82.87-2115-31

North America zone map

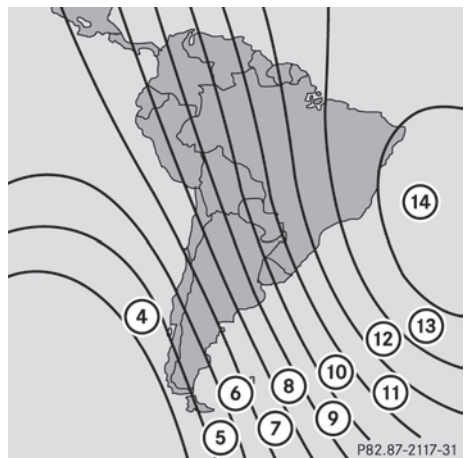

P82.87-2117-31

South America zone map

- ▶ Press and hold button ③ (▷ page 305) for approximately three seconds. The currently selected zone appears in compass display ② (▷ page 305).
- ▶ **To select the zone:** press button ③ (▷ page 305) repeatedly until the desired zone is selected. The zone has been selected when compass display ② (▷ page 305) shows the heading. This takes a few seconds.

### Calibrating the compass

- ▶ Make sure that there is sufficient space for you to drive in a circle without impeding the remaining traffic.

In order to calibrate the compass correctly, observe the following points:

- calibrate the compass in the open and not in the vicinity of steel constructions or high-voltage transmission lines.
- switch off electrical consumers, for example, the climate control, windshield wipers or rear window defroster.
- close all doors and the trunk lid/tailgate.
- ▶ Switch the ignition on.
- ▶ Press and hold button ③ (▷ page 305) for approximately six seconds until the **C** symbol appears in compass display ② (▷ page 305).
- ▶ Drive a full circle at approximately 3 mph (5 km/h) to 6 mph (10 km/h). Once the calibration has been successfully completed, the current direction appears in compass display ② (▷ page 305).

### Floormat on the driver's side

#### **WARNING**

Whenever you are using a floormat, make sure there is enough clearance and that the floormat is securely fastened.

The floormat should always be securely fastened using the fastening equipment.

Before driving off, check that the floormat is securely in place and adjust it if necessary. A loose floormat could slip and hinder proper functioning of the pedals.

Do not place several floormats on top of each other as this may impair pedal movement.

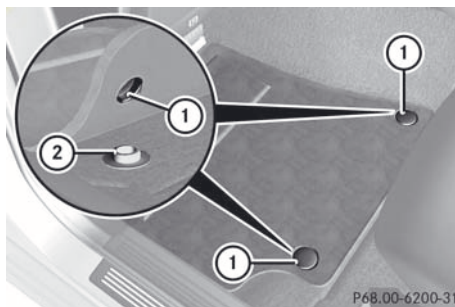

- ▶ Slide the seat backwards.
- ▶ **To install:** place the floormat in the footwell.
- ▶ Press studs ① onto retainers ②.
- ▶ **To remove:** pull the floormat off retainers ②.
- ▶ Remove the floormat.

P68.00-6200-31

Useful information .....	308
Engine compartment .....	308
Maintenance .....	312
Care .....	313

## Useful information

- i** This Operator's Manual describes all models and all standard and optional equipment of your vehicle available at the time of publication of the Operator's Manual. Country-specific differences are possible. Please note that your vehicle may not be equipped with all features described. This also applies to safety-related systems and functions.
- i** Please read the information on qualified specialist workshops (► page 25).

## Engine compartment

## Hood

## Opening the hood

 **WARNING**

Do not pull the release lever while the vehicle is in motion. Otherwise, the hood could be forced open by passing air flow.

This could cause the hood to come loose and injure you and/or others.

 **WARNING**

Do not open the hood when the engine is overheated. You could be seriously injured. Observe the coolant temperature gauge to determine whether the engine may be overheated. If you see flames or smoke coming from the engine compartment, move away from the vehicle. Wait until the engine has cooled. If necessary, call the fire department.

 **WARNING**

There is a risk of injury if the hood is open, even if the engine is not running.

Some engine components can become very hot.

To avoid the risk of burns, only touch those components described in the Operator's Manual and observe the relevant safety notes.

 **WARNING**

To help prevent personal injury, stay clear of moving parts when the hood is open and the engine is running.

The radiator fan may continue to run for approximately 30 seconds or may even restart after the engine has been turned off. Stay clear of fan blades.

 **WARNING**

Vehicles with gasoline engine:

The engine is equipped with a transistorized ignition system. Because of the high voltage it is dangerous to touch any components (ignition coils, spark plug sockets, diagnostic socket) of the ignition system

- with the engine running
- while starting the engine
- when the ignition is switched on and the engine is turned manually

 **WARNING**

Vehicles with diesel engine:

The engine is equipped with a high-voltage electronic control unit for the injection system. Because of the high voltage it is dangerous to touch any components of the injection system (injectors, electrical wires)

- with the engine running
- while starting the engine
- when the ignition is switched on

- Make sure that the windshield wipers are switched off.

 **WARNING**

The windshield wipers and wiper linkage could be set in motion.

When the hood is open, you or others could be injured by the wiper linkage.

Make sure that the windshield wipers are switched off. Remove the SmartKey or make sure that no ignition position has been selected with KEYLESS-GO. All indicator lamps must be off in the instrument cluster.

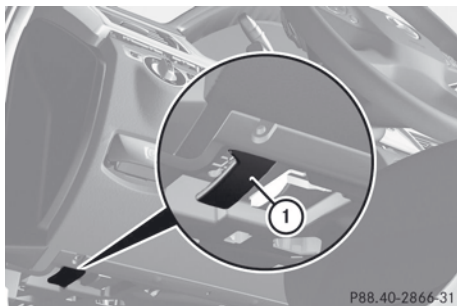

- ▶ Pull release lever ① for the hood. The hood is released.

**!** Make sure that the windshield wipers are not folded away from the windshield. You could otherwise damage the windshield wipers or the hood.

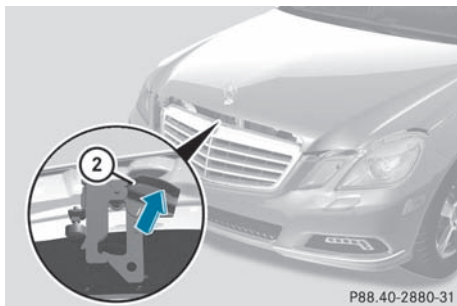

- ▶ Reach into the gap, pull hood catch handle ② up and lift the hood. Once you have lifted the hood about 15 inches (40 cm), it is automatically opened the rest of the way and held open by the gas-filled struts.

### Closing the hood

**⚠ WARNING**

When closing the hood, use extreme caution not to catch hands or fingers. Be careful that you do not close the hood on anyone.

Make sure the hood is securely engaged before driving off. Do not continue driving if the hood can no longer engage after an accident, for example. The hood could

otherwise come loose while the vehicle is in motion and injure you and/or others.

- ▶ Lower the hood and let it fall from a height of approximately 8 inches (20 cm).
- ▶ Check that the hood has engaged properly. If the hood can be raised slightly, it is not properly engaged. Open it again and close it with a little more force.

### Radiator

**i** **Vehicles with a diesel engine:** do not cover the radiator, for example with a winter front or bug cover. Otherwise, the readings of the on-board-diagnostic system may be inaccurate. Some of these readings are required by law and must be accurate at all times.

### Engine oil

#### Notes on the oil level

Depending on the driving style, the vehicle consumes up to 0.9 US qts. (0.8 l) of oil over a distance of 600 miles (1000 km). The oil consumption may be higher than this when the vehicle is new or if you frequently drive at high engine speeds.

#### Checking the oil level using the oil dipstick

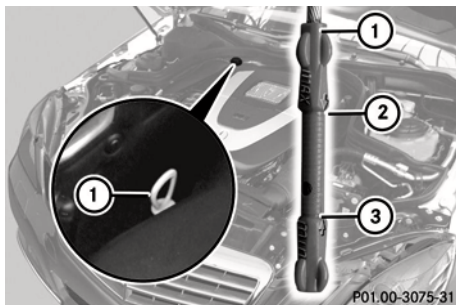

Example: vehicles with a gasoline engine



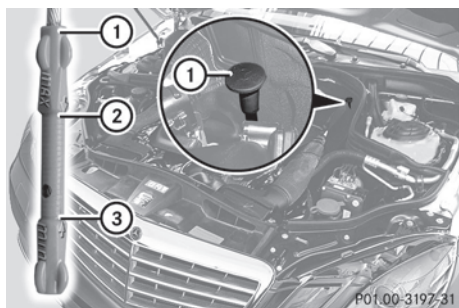

Example: vehicles with a diesel engine

- ▶ Park the vehicle on a level surface.

To check the oil level with the engine at operating temperature, switch the engine off and wait for approximately five minutes.

- ▶ Pull oil dipstick ① out of the dipstick guide tube.
- ▶ Wipe off oil dipstick ①.
- ▶ Slowly slide oil dipstick ① into the guide tube to the stop, and take it out again. If the level is between MIN mark ③ and MAX mark ②, the oil level is correct.
- ▶ If the fuel level has sunk to MIN mark ③ or below, add 0.55 to 1.1 US qt (0.5 to 1.0 l) engine oil.

## Adding engine oil

### WARNING

If engine oil comes into contact with hot engine parts, it may ignite and you could burn yourself. Do not spill any engine oil on hot engine parts.

### Environmental note

When adding oil, take care not to spill any. If oil enters the soil or waterways, it is harmful to the environment.

- ! Use only engine oils and oil filters that have been approved for vehicles equipped with a service system. A list of the engine oils and oil filters tested and approved in accordance with the Mercedes-Benz Specifications for Service Products can be

called up by visiting <http://www.mbusa.com> (USA only). More information about tested and approved engine oils and oil filters is available from any authorized Mercedes-Benz Center.

Damage to the engine or exhaust system is caused by the following:

- using engine oils and oil filters which have not been specifically approved for the service system.
- replacing the engine oil or oil filter after the replacement interval required by the service system has elapsed
- using engine oil additives.

- ! Do not add too much oil. If the oil level is above the "max" mark on the dipstick, too much oil has been added. This can lead to damage to the engine or the catalytic converter. Have excess oil siphoned off.



Example: engine oil cap

- ▶ Turn cap ① counterclockwise and remove it.
- ▶ Add engine oil. If the oil level is at or below the MIN mark on the oil dipstick, add 0.55 to 1.1 US qt (0.5 to 1.0 l) engine oil.
- ▶ Replace cap ① on the filler neck and turn clockwise. Ensure that the cap locks into place securely.
- ▶ Check the oil level again with the oil dipstick (▶ page 309).



Further information on engine oil  
(▷ page 387).

## Checking and adding other service products

### Checking the coolant level

Only check the coolant level when the vehicle is on a level surface and the engine has cooled down.

- ▶ Turn the SmartKey to position **2** (▷ page 145) in the ignition lock.  
On vehicles with KEYLESS-GO, press the Start/Stop button twice (▷ page 145).
- ▶ Check the coolant temperature display in the instrument cluster.  
The coolant temperature must be below 158 °F (70 °C).

#### WARNING

In order to avoid any potentially serious burns:

- use extreme caution when opening the hood if there are any signs of steam or coolant leaking from the cooling system, or if the coolant temperature display indicates that the coolant is overheated.
- do not remove the pressure cap on the coolant reservoir if the coolant temperature is above 158 °F (70 °C). Allow the engine to cool down before removing the cap. The coolant reservoir contains hot fluid and is under pressure.
- using a rag, slowly turn the cap approximately  $1/2$  turn to relieve excess pressure. If opened immediately, scalding hot fluid and steam will be blown out under pressure.
- do not spill antifreeze on hot engine parts. Antifreeze contains ethylene glycol which may burn if it comes into contact with hot engine parts.

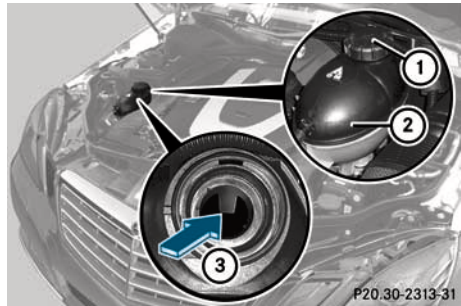

- ▶ Slowly turn cap **1** half a turn counter-clockwise and allow excess pressure to escape.
- ▶ Turn cap **1** further counter-clockwise and remove it.  
If the coolant is at the level of marker bar **3** in the filler neck when cold, there is enough coolant in coolant expansion tank **2**.

If the coolant is approximately 0.6 in (1.5 cm) above marker bar **3** in the filler neck when warm, there is enough coolant in coolant expansion tank **2**.

- ▶ If necessary, add coolant that has been tested and approved by Mercedes-Benz.
- ▶ Replace cap **1** and turn it clockwise as far as it will go.

For further information on coolant, see  
(▷ page 389).

### Windshield washer system and headlamp cleaning system

The washer fluid reservoir is used for both the windshield washer system and the headlamp cleaning system.

- i** Vehicle components and their service products must match. You should, therefore, only use products that have been tested and approved by Mercedes-Benz.

Information on tested and approved products can be obtained at any authorized Mercedes-Benz Center or on the Internet at <http://www.mbusa.com> (USA only).

### ⚠ WARNING

Washer solvent/antifreeze is highly flammable. Do not spill washer solvent/antifreeze on hot engine parts, because it may ignite and burn. You could be seriously burned.

- ❗ At temperatures below freezing: always fill the washer fluid reservoir with a mix of water and windshield washer concentrate (e.g. MB WinterFit). There is otherwise a risk of damaging the windshield washer system/headlamp cleaning system.
- ❗ Only use washer fluid concentrate which is suitable for plastic lenses. Unsuitable washer fluid concentrate could damage the plastic lenses of the headlamps.
- ❗ Do not add distilled or de-ionized water to the washer fluid container. Otherwise, the level sensor may be damaged.
- ℹ Add windshield washer concentrate, e.g. MB SummerFit, to the washer fluid all year round.

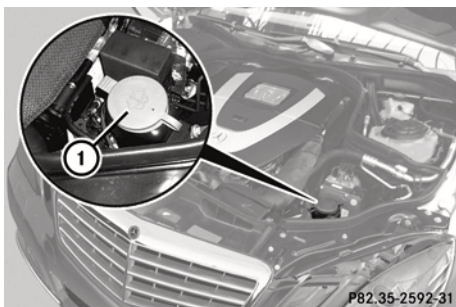

Example: washer fluid reservoir

- ▶ Mix the windshield washer fluid in a container beforehand.
- ▶ **At temperatures above freezing:** fill the washer fluid reservoir with a mix of water and windshield washer concentrate (e.g. MB SummerFit).
- ▶ **At temperatures below freezing:** fill the washer fluid reservoir with a mix of water and windshield washer concentrate (e.g. MB WinterFit). Adapt the mixing ratio to the

outside temperature. For information on the mixing ratio (▶ page 389).

- ▶ **To open:** pull cap ① upwards by the tab.
- ▶ Add the premixed washer fluid.
- ▶ **To close:** press cap ① onto the filler neck until it engages.

### Brake fluid level

- ❗ If you notice that the brake fluid level in the brake fluid reservoir has fallen to the MIN mark or less, check the brake system immediately for leaks. Also check the thickness of the brake linings. Contact a qualified specialist workshop, e.g. an authorized Mercedes-Benz Center immediately.

Do not add brake fluid. This does not correct the error.

Only check the brake fluid level when the vehicle is stationary and on a level surface.

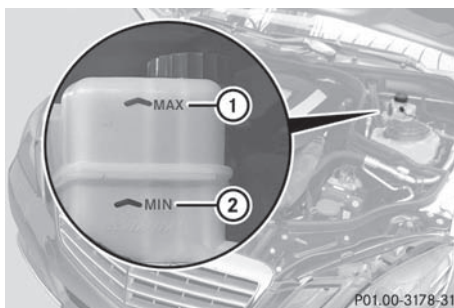

The brake fluid level is correct if it is between MIN marking ② and MAX marking ① on the brake fluid reservoir.

## Maintenance

### Service interval display

#### Service messages

Information on the type of service and service intervals (see separate Service Booklet).

You can obtain further information from an authorized Mercedes-Benz Center or at <http://www.mbusa.com> (USA only).

The service interval message informs you of the next service due date.

The multifunction display shows a service message for several seconds, e.g.:

Next Service A in .. days

Service A Due

Service A Exceeded by ... days

The letter indicates which service is due. **A** stands for a minor service and **B** for a major service. A number or another letter may be displayed after the letter. This figure indicates any necessary additional maintenance work to be performed.

You can obtain further information from an authorized Mercedes-Benz Center.

The service interval display does not take into account any periods of time during which the battery is disconnected.

Maintaining the time-dependent service schedule:

► Note down the service due date displayed in the multifunction display before disconnecting the battery.

or





► Subtract the battery disconnection periods from the service date shown on the display after reconnecting the battery.

**i** The service interval display does not provide any information regarding the engine's oil level. Observe the notes on the engine oil level (▷ page 309).

### Hiding a service message

► Press the  or **OK** button on the steering wheel.

### Displaying service messages

- Switch on the ignition.
- Press  or  on the steering wheel to select the **Serv.** menu.
- Press  or  to select the **ASSYST PLUS** submenu and press **OK** to confirm. The service due date appears in the multifunction display.

### Please bear the following in mind

#### Resetting the service interval display

A qualified specialist workshop, e.g. an authorized Mercedes-Benz Center, will reset the service interval display after the necessary service work has been carried out.

Further information, on maintenance for example, can be obtained at an authorized Mercedes-Benz Center or directly from Mercedes-Benz.

**!** If the service interval display has been reset unintentionally, have the setting corrected at a Mercedes-Benz Center.

Have service work carried out as described in the Service Booklet. This may otherwise lead to increased wear and damage to the major assemblies or the vehicle.

#### Driving abroad

An extensive Mercedes-Benz Service network is also available in other countries. You can obtain further information from any authorized Mercedes-Benz Center.

## Care

### Notes on care

Regular care of your vehicle is a condition for retaining the quality in the long term.

Use care products and cleaning agents recommended and approved by Mercedes-Benz.

 **WARNING**

Many cleaning products can be hazardous. Some are poisonous, others are flammable. Always follow the instructions on the particular container. Always open your vehicle's doors or windows when cleaning the inside.

Never use fluids or solvents that are not designed for cleaning your vehicle.

Always lock away cleaning products and keep them out of reach of children.

**!** For cleaning your vehicle, do not use any of the following:

- dry, rough or hard cloths
- abrasive cleaning agents
- solvents
- cleaning agents containing solvents

Do not scrub.

Do not touch the surfaces or protective films with hard objects, e.g. a ring or ice scraper. You could otherwise scratch or damage the surfaces and protective film.

 **Environmental note**

Dispose of empty packaging and cleaning cloths in an environmentally responsible manner.

**!** Do not park the vehicle for an extended period straight after cleaning it, particularly after having cleaned the wheels with wheel cleaner. Wheel cleaners could cause increased corrosion of the brake discs and brake pads/linings. For this reason, you should drive for a few minutes after cleaning. Braking heats the brake discs and the brake pads/linings, thus drying them. The vehicle can then be parked.

**Exterior care****Automatic car wash** **WARNING**

Braking efficiency is reduced after washing the vehicle. This could cause an accident. For this reason, you must drive particularly carefully after washing the vehicle until the brakes have dried.

 **WARNING**

The vehicle is braked when the HOLD function or DISTRONIC PLUS is activated. Therefore, deactivate the HOLD function and DISTRONIC PLUS before the vehicle is washed in an automatic car wash.

You can wash the vehicle in an automatic car wash from the very start.

**!** Never clean your vehicle in a Touchless Automatic Car Wash as these use special cleaning agents. These cleaning agents can damage the paintwork or plastic parts.

If the vehicle is very dirty, pre-wash it before cleaning it in an automatic car wash.

**!** In car washes with a towing mechanism, make sure that the automatic transmission is in transmission position **N**, otherwise the vehicle could be damaged.

- Vehicles with a SmartKey:

Do not remove the SmartKey from the ignition lock. Do not open the driver's door or front-passenger door when the engine is switched off. Otherwise, the automatic transmission selects park position **P** automatically and locks the wheels. You can prevent this by shifting the automatic transmission to **N** beforehand.

- Vehicles with KEYLESS-GO:

Do not open the driver's door or front-passenger door when the engine is switched off. Otherwise, the automatic transmission selects park position **P** automatically and locks the wheels.

Observe the following to make sure that the automatic transmission stays in position **N**:

- ▶ Make sure the vehicle is stationary and the ignition is switched off.
- ▶ Turn the SmartKey to position **2** (▷ page 145) in the ignition lock. Use the SmartKey instead of the Start/ Stop button on vehicles with KEYLESS-GO.
- ▶ Depress and hold the brake pedal.
- ▶ Shift the automatic transmission to position **N**.
- ▶ Release the brake pedal.
- ▶ Release the parking brake.
- ▶ Switch off the ignition and leave the SmartKey in the ignition lock.

**!** Make sure that:

- the side windows and the sliding sunroof are fully closed.
- the ventilation/heating is switched off (the OFF button has been pressed).
- the windshield wiper switch is in position **0**.

Otherwise, the vehicle might be damaged.

After using an automatic car wash, wipe off wax from the windshield and the wiper blades. This will prevent smears and reduce wiping noises caused by residue on the windshield.

### Washing by hand

Carefully remove all deposits of road salt as soon as possible when driving in winter.

Also, clean the insides of the wheels when washing the underbody of the vehicle.

- ▶ Do not use hot water and do not wash the vehicle in direct sunlight.
- ▶ Use a soft car sponge for cleaning.
- ▶ Use a gentle cleaning agent, e.g. a Mercedes-Benz approved car shampoo.
- ▶ Wash down the vehicle with a gentle water jet.
- ▶ Do not point the water jet directly at the air inlets.

- ▶ Use plenty of water and rinse the sponge frequently.
- ▶ Rinse the vehicle with clean water and dry it thoroughly with a chamois.
- ▶ Do not allow the cleaning agent to dry on the paintwork.

### Power washers

#### WARNING

Do not use power washers with circular-jet nozzles (dirt grinders) to clean your vehicle, in particular the tires. You could otherwise damage the tires and cause an accident.

- !** Always maintain a distance of at least 11.8 in (30 cm) between the vehicle and the power washer nozzle. Information about the correct distance is available from the equipment manufacturer.

Move the power washer nozzle around when cleaning your vehicle.

Do not aim directly at any of the following:

- tires
- door gaps, roof gaps, joints etc.
- electrical components
- battery
- connectors
- lights
- seals
- trim elements
- ventilation slots

Damaged seals or electrical components can lead to leaks or failures.

### Cleaning the wheels

- !** Do not use acidic wheel cleaning products to remove brake dust. This could damage wheel bolts and brake components.

- !** Do not park the vehicle for an extended period straight after cleaning it, particularly after having cleaned the wheels with wheel cleaner. Wheel cleaners could cause increased corrosion of the brake discs and

brake pads/linings. For this reason, you should drive for a few minutes after cleaning. Braking heats the brake discs and the brake pads/linings, thus drying them. The vehicle can then be parked.

### Cleaning the paintwork

Scratches, corrosive deposits, areas affected by corrosion and damage caused by inadequate care cannot always be completely repaired. In such cases, visit a qualified specialist workshop, e.g. an authorized Mercedes-Benz Center.

- ▶ Remove impurities immediately, where possible, whilst avoiding rubbing too hard.
- ▶ Soak insect remains with insect remover and rinse off the treated areas afterwards.
- ▶ Soak bird droppings with water and rinse off the treated areas afterwards.
- ▶ Remove coolant, brake fluid, tree resin, oils, fuels and greases by rubbing gently with a cloth soaked in petroleum ether or lighter fluid.
- ▶ Use tar remover to remove tar stains.
- ▶ Use silicone remover to remove wax.

#### ! Do not affix:

- stickers
  - films
  - magnetic plates or similar items
- to painted surfaces. You could otherwise damage the paintwork.

If water no longer forms "beads" on the paint surface, use the paint care products recommended and approved by Mercedes-Benz. This is the case approximately every three to five months, depending on the climate conditions and the care product used. If dirt has penetrated the paint surface or the paint has become dull, the paint cleaner recommended and approved by Mercedes-Benz should be used.

Do not use these care products in the sun or on the hood while the hood is hot.

- ▶ Use a suitable touch-up stick, e.g. MB Touch-Up Stick, to correct smaller areas of paint damage quickly and provisionally.

### Matte finish care

If your vehicle has a clear matte finish, observe the following instructions in order to avoid damage to the paintwork due to incorrect care.

These notes also apply to light alloy wheels with a clear matte finish.

**!** Never polish the vehicle or the light alloy wheels. Polishing causes the finish to shine.

**!** The following may cause the paint to become shiny and thus reduce the matte effect:

- Vigorous rubbing with unsuitable materials.
- Frequent use of car washes.
- Washing the vehicle in direct sunlight.

**!** Never use paint cleaner, buffing or polishing products, or gloss preserver, e.g. wax. These products are only suitable for high-gloss surfaces. Their use on vehicles with matte finish leads to considerable surface damage (shiny, spotted areas). Always have paintwork repairs performed at a qualified specialist workshop, e.g. an authorized Mercedes-Benz Center.

**!** Do not use wash programs with a hot wax treatment under any circumstances.

**i** The vehicle should preferably be washed by hand using a soft sponge, car shampoo and plenty of water.

**i** Use only insect remover and car shampoo from the range of recommended and approved Mercedes-Benz care products.



## Cleaning the windows

### WARNING

Before cleaning the windshield or wiper blades, switch off the windshield wipers and remove the SmartKey from the ignition lock. On vehicles with KEYLESS-GO, press the Start/Stop button repeatedly until all indicator lamps in the instrument cluster have gone out. The windshield wipers could otherwise move and injure you.

- ▶ Clean the inside and outside of the windows with a damp cloth and a cleaning agent that is recommended and approved by Mercedes-Benz.
- ❗ Do not use dry cloths, abrasive products, solvents or cleaning agents containing solvents to clean the inside of the windows. Do not touch the insides of the windows with hard objects, e.g. an ice scraper or ring. There is otherwise a risk of damaging the windows.
- ❗ Clean the water drainage channels of the windshield and the rear window at regular intervals. Deposits such as leaves, petals and pollen may under certain circumstances prevent water from draining away. This can lead to corrosion damage and damage to electronic components.

## Cleaning the wiper blades

### WARNING

Before cleaning the windshield or wiper blades, switch off the windshield wipers and remove the SmartKey from the ignition lock. On vehicles with KEYLESS-GO, press the Start/Stop button repeatedly until all indicator lamps in the instrument cluster have gone out. The windshield wipers could otherwise move and injure you.

- ❗ Do not pull the wiper blade. Otherwise, the wiper blade could be damaged.

❗ Do not clean wiper blades too often and do not rub them too hard. Otherwise, the graphite coating could be damaged. This could cause wiper noise.

- ▶ Fold the wiper arms away from the windshield.
- ▶ Carefully clean the wiper blades with a damp cloth.
- ▶ Fold the windshield wipers back again before switching on the ignition.

❗ Hold the wiper arm securely when folding back. The windshield could be damaged if the wiper arm smacks against it suddenly.

## Cleaning the exterior lighting

- ▶ Clean the plastic lenses of the exterior lights with a wet sponge and a mild cleaning agent, e.g. Mercedes-Benz car shampoo or cleaning cloths.

❗ Only use cleaning agents or cleaning cloths which are suitable for plastic light lenses. Unsuitable cleaning agents or cleaning cloths could scratch or damage the plastic light lenses.

## Cleaning the sensors

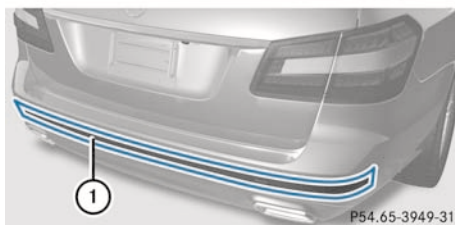

- ▶ Clean sensors ① of the driving systems with water, car shampoo and a soft cloth.

P54.65-3949-31



- ❗ When cleaning the sensors with a power washer, maintain a distance between the vehicle and the nozzle of the power washer of at least 11.8 in (30 cm). Information about the correct distance is available from the equipment manufacturer.

### Cleaning the rear view camera

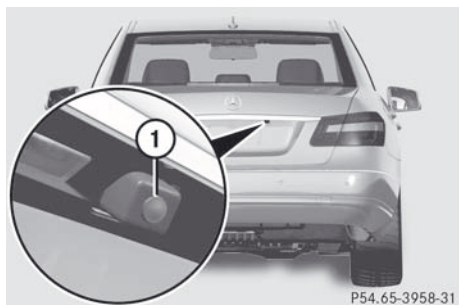

P54.65-3958-31

Example: Sedan

- ▶ Use clear water and a soft cloth to clean camera lens ①.
- ❗ Do not clean the camera lens and the area around the rear view camera with a power washer.

### Cleaning the exhaust tail pipes

Impurities combined with the effects of road grit and corrosive environmental factors may cause flash rust to form on the surface. You can restore the original shine of the exhaust tail pipe by cleaning it regularly, especially in winter and after washing.

- ❗ Do not clean the exhaust tail pipes with alkaline-based cleaning agents, such as wheel cleaner.
- ▶ Clean the exhaust tail pipes with a chrome care product tested and approved by Mercedes-Benz.

## Interior care

### Cleaning the display

- ▶ Before cleaning the display, make sure that it is switched off and has cooled down.
- ▶ Clean the display surface using a commercially-available microfiber cloth and TFT/LCD display cleaner.
- ▶ Dry the display surface using a dry microfiber cloth.

- ❗ For cleaning, do not use any of the following:

- alcohol-based thinner or gasoline
- abrasive cleaning agents
- commercially-available household cleaning agents

These may damage the display surface. Do not put pressure on the display surface when cleaning. This could lead to irreparable damage to the display.

### Cleaning Night View Assist Plus

- ❗ Never clean the camera lens. When cleaning the field of vision of the driving systems, make sure that you do not spray glass cleaner on the camera lens. If the camera lens is dirty, visit a qualified specialist workshop.

#### WARNING

Please do not forget that your primary responsibility is to drive the vehicle. A driver's attention to the road must always be his/her primary focus when driving. For your safety and the safety of others, stop before trying to remove window fogging or cleaning the window in front of the Night View Assist Plus camera.

Bear in mind that at a speed of just 30 mph (approximately 50 km/h), your vehicle is covering a distance of 44 feet (approximately 14 m) every second.

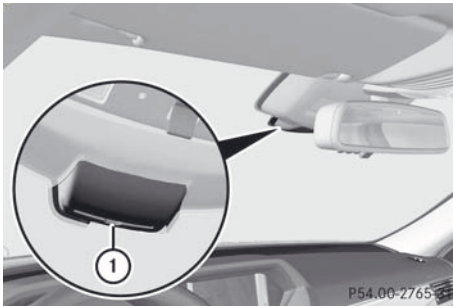

- ▶ Fold down the camera cover by recess ①.

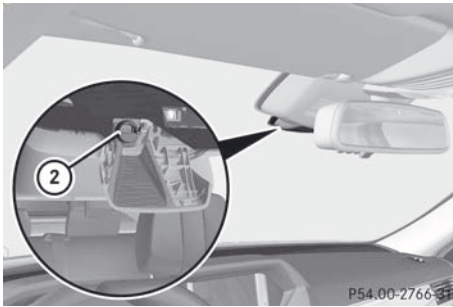

- ▶ Use a soft cloth to clean the windshield in front of camera ②.

### Cleaning the plastic trim

#### WARNING

When cleaning the steering wheel boss and dashboard, do not use cockpit sprays or cleaning agents containing solvents. Cleaning agents containing solvents cause the surface to become porous, and as a result, plastic parts may break away and be thrown around the interior when an air bag is deployed, which may result in severe injuries.

- ❗ Do not affix the following to plastic surfaces:

- stickers
- films
- scented oil bottles or similar items

You can otherwise damage the plastic.

- ❗ Do not allow cosmetics, insect repellent or sunscreen to come into contact with the

plastic trim. This maintains the high-quality look of the surfaces.

- ▶ Wipe the plastic trim with a damp, lint-free cloth, e.g. a microfiber cloth.
- ▶ **Heavy soiling:** use car care and cleaning products recommended and approved by Mercedes-Benz. The surface may change color temporarily. Wait until the surface is dry again.

### Cleaning the steering wheel and gear or selector lever

- ▶ Thoroughly wipe with a damp cloth or use leather care agents that have been recommended and approved by Mercedes-Benz.

### Cleaning genuine wood and trim elements

- ▶ Wipe the wooden trim and trim pieces with a damp, lint-free cloth, e.g. a microfiber cloth.
- ▶ **Heavy soiling:** use car care and cleaning products recommended and approved by Mercedes-Benz.

❗ Do not use solvent-based cleaning agents such as tar remover, wheel cleaners, polishes or waxes. There is otherwise a risk of damaging the surface.

❗ Do not use chrome polish on trim pieces. The trim pieces have a chrome look but are mostly made of anodized aluminum and can lose their shine if chrome polish is used. Use a damp, lint-free cloth instead when cleaning the trim pieces.

If the chrome-plated trim pieces are very dirty, you can use a chrome polish. If you are unsure as to whether the trim pieces are chrome-plated or not, consult an authorized Mercedes-Benz Center.

### Cleaning the seat covers

---

- ❗ Do not use microfiber cloths to clean genuine leather, artificial leather or Alcantara® covers. If used often, these can damage the cover.
- ❗ Observe the following when cleaning:
  - clean genuine leather covers carefully with a damp cloth and then wipe the covers down with a dry cloth. Make sure that the leather does not become soaked. It may otherwise become rough and cracked. Only use leather care agents that have been tested and approved by Mercedes-Benz. You can obtain these from a qualified specialist workshop, e.g. a Mercedes-Benz Service center.
  - clean artificial leather covers with a cloth moistened with a solution containing 1% detergent (e.g. dish washing liquid).
  - clean cloth covers with a microfiber cloth moistened with a solution containing 1% detergent (e.g. dish washing liquid). Rub carefully and always wipe entire seat sections to avoid leaving visible lines. Leave the seat to dry afterwards. Cleaning results depend on the type of dirt and how long it has been there.
  - clean Alcantara® covers with a damp cloth. Make sure you wipe entire seat sections to avoid leaving visible lines.
- i Note that regular care is essential to ensure that the appearance and comfort of the covers is retained over time.

### Cleaning the seat belts

---

- ▶ Use clean, lukewarm water and soap solution.
- ❗ Do not clean the seat belts using chemical cleaning agents. Do not dry the seat belts by warming them above 176 °F (80 °C) or placing them in direct sunlight.

### WARNING

Do not bleach or dye seat belts as this may severely weaken them. In a crash, they may not be able to provide adequate protection.

### Cleaning the headliner and carpets

---

- ▶ **Roof lining:** use soft brushes or dry shampoo if it is particularly dirty.
- ▶ **Carpets:** use carpet and textile cleaners that have been approved and recommended by Mercedes-Benz.

Useful information .....	322
Where will I find...? .....	322
Flat tire .....	325
Battery .....	335
Jump-starting .....	338
Towing and tow-starting .....	340
Fuses .....	342

## Useful information

- i** This Operator's Manual describes all models and all standard and optional equipment of your vehicle available at the time of publication of the Operator's Manual. Country-specific differences are possible. Please note that your vehicle may not be equipped with all features described. This also applies to safety-related systems and functions.
- i** Please read the information on qualified specialist workshops (► page 25).

## Where will I find...?

### First-aid kit

**Sedan:** the first-aid kit is in the right-hand storage compartment in the trunk.

- Open the trunk lid.
- Slide down the parcel net.
- Open the storage compartment.

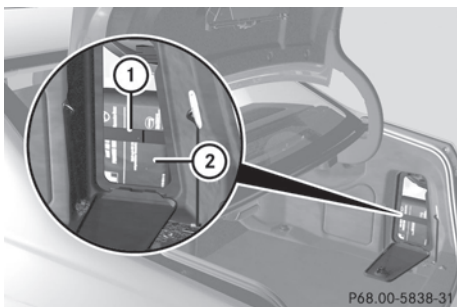

- Release strap ①.
- Remove first-aid kit ②.

**Wagon:** depending on the vehicle's equipment, the first-aid kit is in the parcel net or behind the side trim panel.

- Open the tailgate.

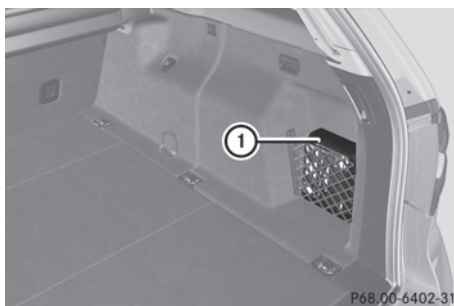

In the parcel net

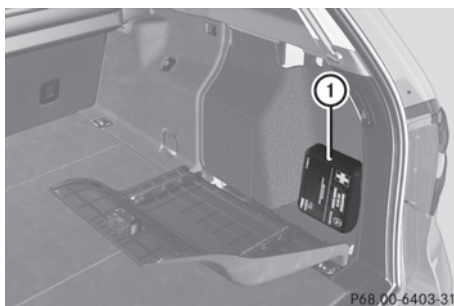

Behind the side trim panel

- Open the right-hand side trim panel if the first-aid kit is in the side trim panel.
  - Remove first-aid kit ①.
- i** Check the expiration date on the first-aid kit at least once a year. Replace the contents if necessary, and replace missing contents.

### Vehicle tool kit

The vehicle tool kit can be found in the storage well under the trunk floor/cargo compartment floor. Depending on the vehicle equipment, the vehicle tool kit is on the left-hand side or the right-hand side in the storage well under the trunk floor/cargo compartment floor.

- ▶ **Sedan with TIREFIT kit<sup>28</sup>:** lift the trunk floor up (▷ page 286).
- ▶ **Wagon with TIREFIT kit:** remove the seat cushions of the folding bench seat (▷ page 103).
- ▶ Lift up the floor of the cargo compartment.

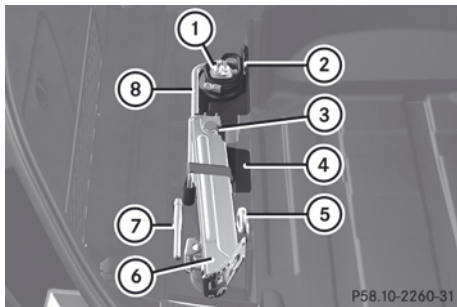

Example: vehicle tool kit in the left-hand stowage space

- ① Tire sealant filler bottle
- ② Folding wheel chock
- ③ One pair of gloves (under jack)
- ④ Tire inflation compressor
- ⑤ Towing eye
- ⑥ Jack
- ⑦ Alignment bolt
- ⑧ Lug wrench

- ▶ **Sedan with spare wheel/"Minispare" emergency spare wheel:** lift the trunk floor up (▷ page 286).
- ▶ **Wagon with spare wheel/"Minispare" emergency spare wheel:** remove the seat cushions of the folding bench seat (▷ page 103).
- ▶ Lift up the floor of the cargo compartment.

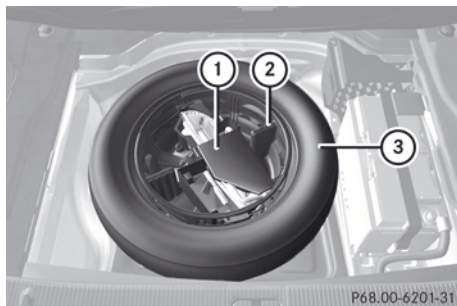

- ① Vehicle tool kit tray
- ② Stowage well
- ③ Spare wheel/"Minispare" emergency spare wheel

The vehicle tool kit contains:

- Folding wheel chock
- Fuse allocation chart
- Jack
- Alignment bolt
- One pair of gloves
- Lug wrench
- Towing eye

- ▶ **Vehicles with a collapsible spare wheel<sup>29</sup>:** lift up the trunk floor (▷ page 286).

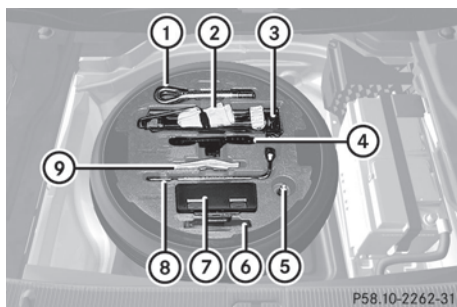

- ① Towing eye
- ② One pair of gloves
- ③ Jack
- ④ Folding wheel chock
- ⑤ Alignment bolt

<sup>28</sup> Vehicles with BlueTEC only.

<sup>29</sup> AMG vehicles only.

- ⑥ Sheet for faulty wheel
- ⑦ Tire inflation compressor
- ⑧ Lug wrench
- ⑨ Fuse allocation chart

### "Minispare" emergency spare wheel/ collapsible spare wheel

#### Removing the "Minispare" emergency spare wheel/collapsible spare wheel

##### Opening the stowage well

**Sedan:** the emergency spare wheel can be found in the stowage well under the trunk floor.

- ▶ Lift the trunk floor upwards (▷ page 286).

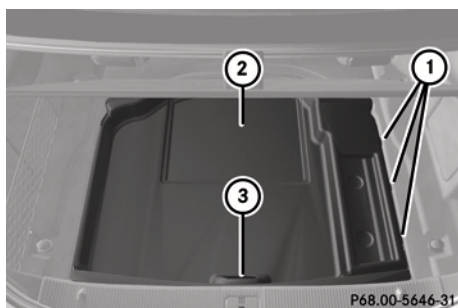

Example: well insert

- ▶ Release tabs ① on the right of well insert ②.
- ▶ Reach into recess ③ of well insert ②, swing the insert up and remove it.

**Wagon:** the emergency spare wheel is located in the stowage well under the cargo compartment floor.

- ▶ Remove the seat cushions of the folding bench seat (▷ page 103).
- ▶ Lift up the floor of the cargo compartment.

#### Removing the emergency spare wheel: Sedan

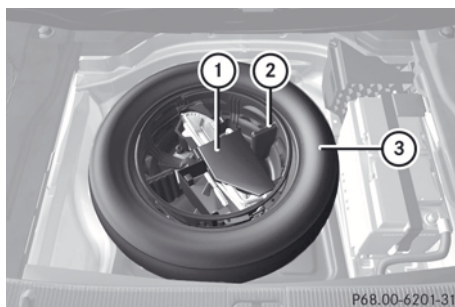

Example: Sedan

- ▶ Remove vehicle tool kit tray ①.
- ▶ Turn stowage well ② counter-clockwise and remove it.
- ▶ Remove "Minispare" emergency spare wheel ③.

#### Removing the emergency spare wheel: Wagon

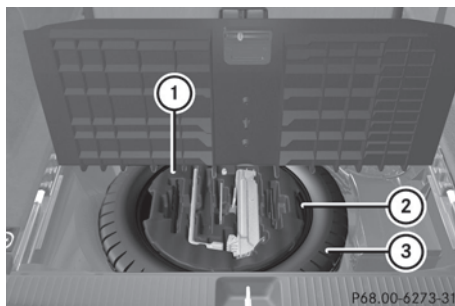

Example: emergency spare wheel

- ▶ Remove vehicle tool kit tray ① by recess ②.
- ▶ Remove "Minispare" emergency spare wheel ③.



## Removing the emergency spare wheel: AMG vehicles

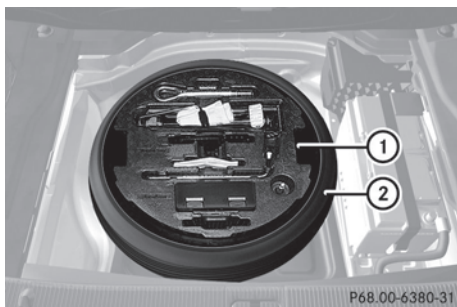

- ▶ Reach into cutout ① in the tool holder and lift it up.
- ▶ Remove collapsible spare wheel ②.

For further information on changing a wheel and mounting the spare wheel, see (▷ page 329).

## Stowing a used collapsible spare wheel

Take the following steps to stow a used collapsible spare wheel. It will otherwise not fit in the spare wheel well. Mercedes-Benz recommends that you have this work carried out at a qualified specialist workshop, e.g. an authorized Mercedes-Benz Center.

- ❗ Only place the collapsible spare wheel in the vehicle when it is dry. Otherwise, moisture may get into the vehicle.
- ▶ Unscrew the valve cap from the valve.
- ▶ Use the back of the valve cap to unscrew the valve insert from the valve and release the air.
- ⓘ Fully deflating the tire can take a few minutes.
- ▶ Screw the valve insert back into the valve.
- ▶ Screw the valve cap back on.

- ▶ Remove the protective sheet from the vehicle tool kit and pull it over the collapsible spare wheel.
- ▶ Stow the collapsible spare wheel in the emergency spare wheel well under the trunk.

## Flat tire

### Preparing the vehicle

Your vehicle may be equipped with:

- TIREFIT kit<sup>30</sup>
- a "Minispare" emergency spare wheel
- a collapsible spare wheel
- MOExtended tires (tires with run-flat properties) (▷ page 334)
- ⓘ Vehicle preparation is not necessary on vehicles with MOExtended tires.
- ⓘ Vehicles equipped with MOExtended tires are not equipped with a TIREFIT kit at the factory. It is therefore recommended that you additionally equip your vehicle with a TIREFIT kit if you mount tires that do not feature run-flat properties, e.g. winter tires. A TIREFIT kit can be obtained from an authorized Mercedes-Benz Center.
- ▶ Vehicles with AIRMATIC: make sure that "normal" level is selected (▷ page 189).
- ▶ Stop the vehicle as far away as possible from traffic on solid, non-slippery and level ground.
- ▶ Switch on the hazard warning lamps.
- ▶ Firmly depress the parking brake.
- ▶ Bring the front wheels into the straight-ahead position.
- ▶ Move the selector lever/DIRECT SELECT lever to **P**.
- ▶ Switch off the engine.

<sup>30</sup> Canada only.

- ▶ **Vehicles without KEYLESS-GO:** remove the SmartKey from the ignition lock.
- ▶ **Vehicles with KEYLESS-GO:** open the driver's door.  
The on-board electronics have status **0**, which is the same as the SmartKey having been removed.
- ▶ **Vehicles with KEYLESS-GO:** remove the Start/Stop button from the ignition lock (▷ page 145).
- ▶ All occupants must get out of the vehicle. Make sure that they are not endangered as they do so.
- ▶ Make sure that no one is near the danger area while a wheel is being changed. Anyone who is not directly assisting in the wheel change should, for example, stand behind the barrier.
- ▶ Get out of the vehicle. Pay attention to traffic conditions when doing so.
- ▶ Close the driver's door.

### TIREFIT kit

#### Using the TIREFIT kit

You can use the TIREFIT kit to seal small punctures, particularly those in the tire tread. You can use TIREFIT at outside temperatures down to -4 °F (-20 °C).

#### WARNING

TIREFIT is a limited repair device. TIREFIT cannot be used for cuts or punctures larger than approximately 0.16 in (4 mm) and tire damage caused by driving with extremely low tire inflation pressure, or on a flat tire, or a damaged wheel.

Do not drive the vehicle under such circumstances.

Contact the nearest authorized Mercedes-Benz Center for assistance or call Roadside Assistance.

- ▶ Do not remove any foreign objects which have penetrated the tire, e.g. screws or nails.
- ▶ Remove the tire sealant bottle, the accompanying "max. 80 km/h" sticker and the tire inflation compressor from the stowage well underneath the trunk floor/trunk floor (▷ page 322).

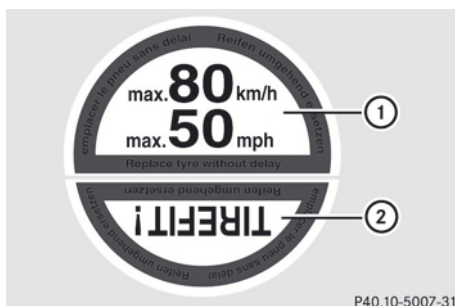

P40.10-5007-31

- ▶ Affix part ① of the sticker within the driver's field of vision.
- ▶ Affix part ② of the sticker near the valve on the wheel with the defective tire.

#### WARNING

Take care not to allow the contents of TIREFIT to come in contact with hair, eyes or clothing. TIREFIT is harmful if inhaled, swallowed or absorbed through the skin - causes skin, eye and respiratory irritation.

Any contact with eyes or skin should be flushed immediately with plenty of water.

If clothing comes in contact with TIREFIT, change clothing as soon as possible.

In case of allergic reaction or rash, consult a physician immediately.

#### WARNING

Keep TIREFIT away from children. If swallowed, rinse mouth immediately with plenty of water and drink plenty of water.

Do not induce vomiting.

Consult a doctor immediately.

Keep away from open flame or heat source.

- ▶ If TIREFIT leaks out, allow it to dry. It can then be removed like a layer of film.

If you get TIREFIT on your clothing, have it cleaned as soon as possible with perchloroethylene.

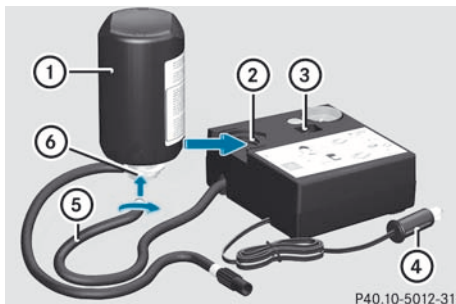

- ▶ Pull connector (4) with the cable and hose (5) out of the housing.
- ▶ Screw hose (5) onto flange (6) of tire sealant bottle (1).
- ▶ Insert tire sealant bottle (1) upside down into opening (2) on the tire inflation compressor.

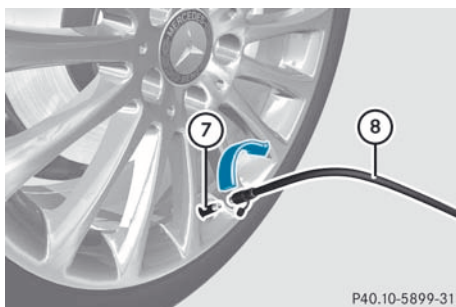

- ▶ Remove the cap from valve (7) on the defective tire.
- ▶ Screw filler hose (8) onto valve (7).
- ▶ Insert plug (4) into the cigarette lighter socket (▶ page 293) or into a 12 V socket in your vehicle (▶ page 294).

- ▶ Turn the SmartKey to position 1 (▶ page 145) in the ignition lock.
- ▶ Press on/off switch (3) on the tire inflation compressor to I. The tire inflation compressor is switched on. The tire is inflated.

- ▶ First, TIREFIT is pumped into the tire. The pressure can briefly rise to approximately 500 kPa (5 bar/73 psi).

### **Do not switch off the tire inflation compressor during this phase.**

- ▶ Allow the tire inflation compressor to run for five minutes. The tire should then have attained a pressure of at least 180 kPa (1.8 bar/26 psi).

- ▶ **!** Do not operate the tire inflation compressor for longer than eight minutes at a time without a break. It may otherwise overheat.

The tire inflation compressor can be operated again once it has cooled down.

If a pressure of 180 kPa (1.8 bar/26 psi) has been achieved after five minutes, see (▶ page 328).

If a pressure of 180 kPa (1.8 bar/26 psi) has not been achieved after five minutes, see (▶ page 327).

### **Tire pressure of at least 180 kPa (1.8 bar/26 psi) is not reached**

If, after five minutes, a pressure of 180 kPa (1.8 bar/26 psi) has not been achieved:

- ▶ Press the on/off switch on the tire inflation compressor to 0. The tire inflation compressor is switched off.
- ▶ Unscrew the filler hose from the valve of the faulty tire.
- ▶ Very slowly drive forwards or reverse approximately 30 ft (10 m).
- ▶ Pump up the tire again.

**⚠ WARNING**

If after five minutes a pressure of 180 kPa (1.8 bar/26 psi) cannot be achieved, the tire is too badly damaged to be repaired reliably using TIREFIT.

In this case TIREFIT cannot seal the tire properly.

Do not drive any further.

Contact the nearest authorized Mercedes-Benz Center for assistance or call Roadside Assistance.

**Tire pressure of 180 kPa (1.8 bar/26 psi) is reached**

- ▶ Press the on/off switch on the tire inflation compressor to **0**.  
The tire inflation compressor is switched off.
- ▶ Unscrew the filler hose from the valve of the faulty tire.

**!** After use, excess TIREFIT may run out of the filler hose. This could cause stains. Therefore, place the filler hose in the plastic bag which contained the TIREFIT kit.

▶ Stow the tire sealant bottle and the tire inflation compressor.

▶ **Pull away immediately.**

**⚠ WARNING**

Do not exceed a vehicle speed of 50 mph (80 km/h). A TIREFIT repair is not designed to operate at higher speeds.

The sticker must be attached on the instrument cluster where it will be easily seen by the driver.

Vehicle handling characteristics of a TIREFIT repaired tire may change. Adapt your driving accordingly.

- ▶ Stop after driving for approximately ten minutes and check the tire pressure with the tire inflation compressor.

**⚠ WARNING**

If tire inflation pressure has fallen below 130 kPa (1.3 bar/26 psi) do not continue to drive the vehicle.

Park your vehicle safely away from the roadway and contact the nearest authorized Mercedes-Benz Center or Roadside Assistance.

Have the damaged tire replaced.

- ▶ Correct the tire pressure if it is at least 130 kPa (1.3 bar/20 psi) (for the required values, see the Tire and Loading Information placard on the driver's side B-pillar or the tire pressure table inside the fuel filler flap).
- ▶ **To increase the tire pressure:** switch on the tire inflation compressor.

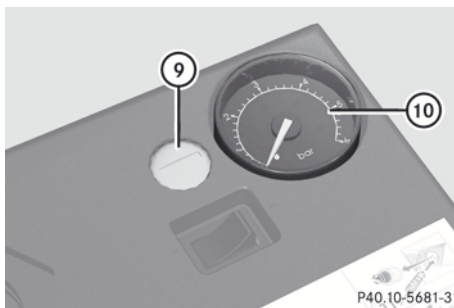

- ▶ **To reduce the tire pressure:** press pressure release button **9** next to pressure gauge **10**.
- ▶ Stow the tire sealant bottle and the tire inflation compressor.
- ▶ Drive to the nearest workshop and have the tire changed there.
- ▶ Have the tire sealant bottle replaced as soon as possible at a qualified specialist workshop, e.g. at an authorized Mercedes-Benz Center.

**♻ Environmental note**

Have the used tire sealant bottle disposed of professionally, e.g. at an authorized Mercedes-Benz Center.

- ▶ Have the tire sealant bottle replaced every four years at a qualified specialist workshop, e.g. an authorized Mercedes-Benz Center.

## Changing a wheel and mounting the spare wheel

### Preparing the vehicle

#### WARNING

The wheel and tire size of the emergency spare wheel/spare wheel may differ to that of the damaged wheel. When using an emergency spare wheel/spare wheel the handling characteristics of the vehicle may change.

Adapt your style of driving accordingly.

Never operate the vehicle with more than one emergency spare wheel/spare wheel that differs in size.

Only use an emergency spare wheel/spare wheel of a differing size briefly and do not switch off ESP®.

When using an emergency spare wheel, you must not exceed the maximum speed of 50 mph (80 km/h).

#### WARNING

Have the emergency spare wheel/spare wheel replaced with a new wheel as soon as possible at a qualified specialist workshop which has the necessary specialist knowledge and tools to carry out the work required. Mercedes-Benz recommends that you use an authorized Mercedes-Benz Center for this purpose. In particular, work relevant to safety or on safety-related systems must be carried out at a qualified specialist workshop.

- i** Vehicles without a spare wheel/emergency spare wheel are not equipped with a tire-change tool kit at the factory. For more information on which tools are required to perform a wheel change on your vehicle, e.g. wheel chock, lug wrench or

alignment bolt, consult an authorized Mercedes-Benz Center.

- ▶ Prepare the vehicle as described (▷ page 325).
- ▶ Remove the following items (depending on the vehicle's equipment) from the stowage well under the trunk/trunk floor:
  - the emergency spare wheel
  - the lug wrench
  - the folding wheel chock
  - the jack
  - the alignment bolt
  - the tire inflation compressor
- ▶ Secure the vehicle to prevent it from rolling away.

### Securing the vehicle to prevent it from rolling away

#### WARNING

Only jack up the vehicle on level ground or on slight inclines/declines. The vehicle could otherwise fall off the jack and injure you or others.

If your vehicle is equipped with a wheel chock, it can be found in the vehicle tool kit (▷ page 322).

The folding wheel chock is an additional securing measure to prevent the vehicle from rolling away, for example when changing a wheel.

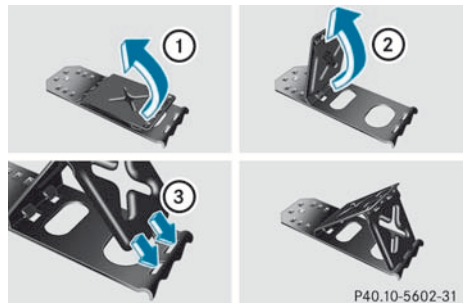

P40.10-5602-31

- ▶ Fold both plates upwards ①.
- ▶ Fold out lower plate ②.
- ▶ Guide the lugs on the lower plate fully into the openings in base plate ③.



Securing the vehicle on level ground (example: Sedan)

- ▶ **On level ground:** place chocks or other suitable items under the front and rear of the wheel that is diagonally opposite the wheel you wish to change.



Securing the vehicle on slight downhill gradients (example: Sedan)

- ▶ **On downhill gradients:** place chocks or other suitable items in front of the wheels of the front and rear axle.

## Raising the vehicle

### WARNING

When jacking up the vehicle, only use the jack which has been specifically approved by Mercedes-Benz for your vehicle.

The jack is designed exclusively for jacking up the vehicle at the jacking points built into both

sides of the vehicle. The jack saddle must be placed centrally under the jacking point. The jack must always be vertical when in use, especially on inclines or declines.

The jack is intended only for lifting the vehicle briefly for wheel changes. It is not suited for performing maintenance work under the vehicle. To help avoid personal injury, use the jack only to lift the vehicle during a wheel change.

Never get beneath the vehicle while it is supported by the jack. Keep hands and feet away from the area under the lifted vehicle. Always lower the vehicle onto sufficient capacity jackstands before working under the vehicle.

Always firmly engage the parking brake and block the wheels with wheel chocks or other sizable objects before raising the vehicle with the jack. Do not disengage the parking brake while the vehicle is raised.

Make sure that the ground on which the vehicle is standing and where you place the jack is solid, level and not slippery. If necessary, use a large underlay. On slippery surfaces, such as tiled floors, you should use a non-slip underlay, for example a rubber mat. Do not use wooden blocks or similar objects as a jack underlay. Otherwise, the jack may not be able to achieve its load-bearing capacity if it is not at its full height.

Never start the engine when the vehicle is raised.

Also observe the notes on the jack.

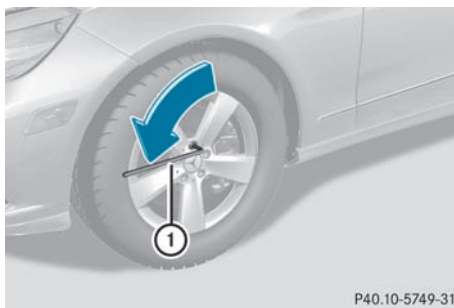



- ▶ Using lug wrench ①, loosen the bolts on the wheel you wish to change by about one full turn. Do not unscrew the bolts completely.

The jacking points for the jack are located behind the wheel housings of the front wheels and in front of the wheel housings of the rear wheels (arrows).

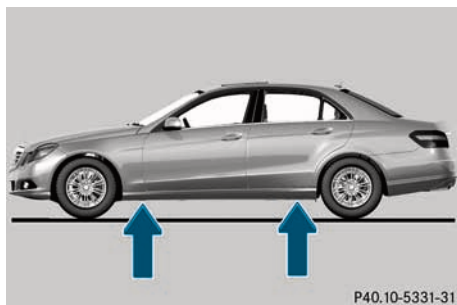

Jacking points for the jack (example: Sedan)

**AMG vehicles and vehicles with AMG equipment:** to protect the vehicle body, the vehicle has covers next to the jacking points on the outer sills.

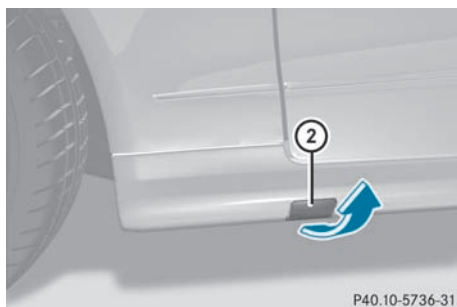

Cover, front (example: vehicles with AMG Sports package)

- ▶ **AMG vehicles and vehicles with AMG equipment:** fold cover ② upwards.

### **WARNING**

The jack is designed exclusively for jacking up the vehicle at the jacking points. The jack saddle must be placed centrally under the jacking point.

If you do not position the jack correctly in the jacking point, the vehicle can fall off the jack and seriously or fatally injure you or others.

- ❗ The jack is designed exclusively for jacking up the vehicle at the jacking points. Otherwise, your vehicle could be damaged.

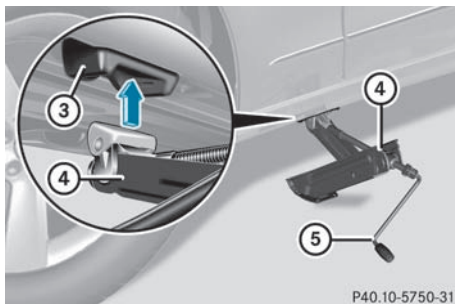

- ▶ Position jack ④ at jacking point ③.

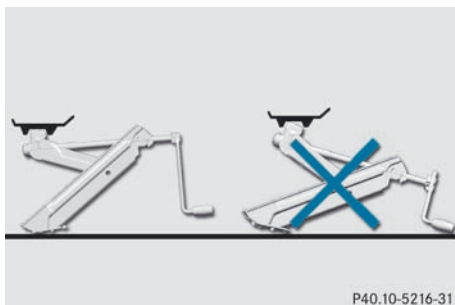

- ▶ Make sure that the base of the jack is positioned directly under the jacking point.
- ▶ Turn crank ⑤ clockwise until jack ④ sits completely on jacking point ③ and the base of the jack lies evenly on the ground.
- ▶ Turn crank ⑤ until the tire is raised a maximum of 1.2 inches (3 cm) off the ground.

### Removing a wheel

- ❗ **AMG vehicles:** during removal and repositioning of the wheel, the wheel rim can strike the ceramic-brake disc and damage it. Therefore, take precautions and get a second person to assist you.



Alternatively, you can use a second alignment bolt.

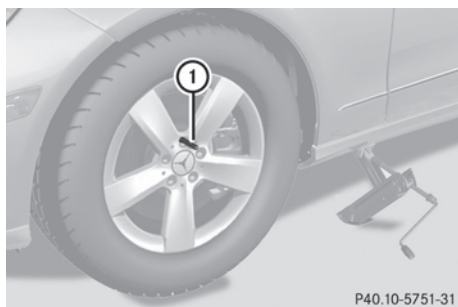

P40.10-5751-31

- ▶ Unscrew the uppermost wheel bolt completely.
  - ▶ Screw alignment bolt ① into the thread instead of the wheel bolt.
  - ▶ Unscrew the remaining wheel bolts fully.
- !** Do not place wheel bolts in sand or on a dirty surface. The bolt and wheel hub threads could otherwise be damaged when you screw them in.
- ▶ Remove the wheel.

### Mounting a new wheel

#### **!** WARNING

Always replace wheel bolts that are damaged or rusted.

Never apply oil or grease to wheel bolts.

Damaged wheel hub threads should be repaired immediately. Do not continue to drive under these circumstances! Contact an authorized Mercedes-Benz Center or call Roadside Assistance.

Incorrect wheel bolts or improperly tightened wheel bolts can cause the wheel to come off. This could cause an accident. Make sure to use the correct wheel bolts.

#### **!** WARNING

Only use genuine Mercedes-Benz wheel bolts. Other wheel bolts may come loose.

Do not tighten the wheel bolts when the vehicle is raised. Otherwise, the vehicle could fall off the jack.

#### **!** WARNING

Make sure to use the original length wheel bolts when remounting the original wheel after it has been repaired.

- ▶ Clean the wheel and wheel hub contact surfaces.
- !** To prevent damage to the paintwork, hold the wheel securely against the wheel hub while screwing in the first wheel bolt.
- !** **AMG vehicles:** during removal and repositioning of the wheel, the wheel rim can strike the ceramic-brake disc and damage it. Therefore, take precautions and get a second person to assist you. Alternatively, you can use a second alignment bolt.

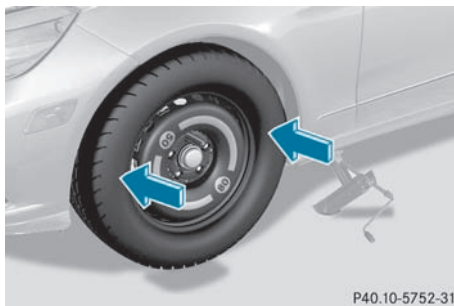

P40.10-5752-31

- ▶ Slide the emergency spare wheel onto the alignment bolt and push it on.
- ▶ Tighten the wheel bolts until they are finger-tight.
- ▶ Unscrew the alignment bolt.
- ▶ Tighten the last wheel bolt until it is finger-tight.

### Inflating the collapsible spare wheel

#### **!** WARNING

Inflate the collapsible spare wheel only after the wheel is properly attached.

Inflate the collapsible spare wheel using the tire inflation compressor **before** lowering the vehicle.

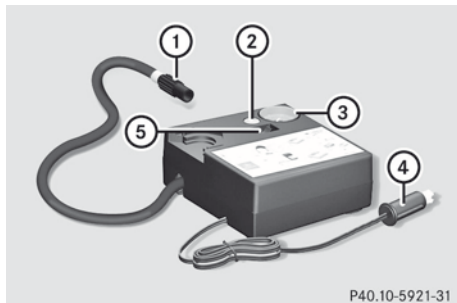

- ▶ Pull connector ④ and the air hose out of the housing.
- ▶ Remove the cap from the valve on the collapsible spare wheel.
- ▶ Screw union nut ① on the air hose onto the valve.
- ▶ Make sure on/off switch ⑤ of the tire inflation compressor is set to **0**.
- ▶ Insert plug ④ into the socket of the cigarette lighter (▶ page 293) or into a 12 V power socket (▶ page 294) in your vehicle.
- ▶ Make sure that the SmartKey is in position **1** (▶ page 145) in the ignition lock.
- ▶ Press on/off switch ⑤ on the tire inflation compressor to **I**.  
The tire inflation compressor is switched on. The tire is inflated. Gauge ③ shows the tire pressure.
- ❗ Do not operate the tire inflation compressor for longer than eight minutes at a time without a break. It may otherwise overheat.  
The tire inflation compressor can be operated again once it has cooled down.
- ▶ Inflate the tire to the specified tire pressure.

The specified tire pressure is printed on the yellow label of the emergency spare wheel.

- ▶ When the specified tire pressure has been reached, press on/off switch ⑤ on the electric air pump to **0**.  
The tire inflation compressor is switched off.
- ▶ Turn the SmartKey to position **0** in the ignition lock.
- ▶ If the tire pressure is higher than the specified pressure, press pressure release button ② until the correct tire pressure has been reached.
- ▶ Unscrew union nut ① on the air hose from the valve.
- ▶ Screw the valve cap onto the collapsible spare wheel valve again.
- ▶ Stow plug ④ and the air hose in the lower section of the compressor housing.
- ▶ Stow the tire inflation compressor in the designated place in the vehicle.

### Lowering the vehicle

#### **WARNING**

Vehicles with a spare wheel with a collapsible spare wheel only: do not inflate the collapsible spare wheel until it has been mounted.  
Inflate the collapsible spare wheel using the tire inflation compressor **before** lowering the vehicle.

- ▶ Turn the crank of the jack counter-clockwise until the vehicle is once again standing firmly on the ground.
- ▶ Place the jack to one side.

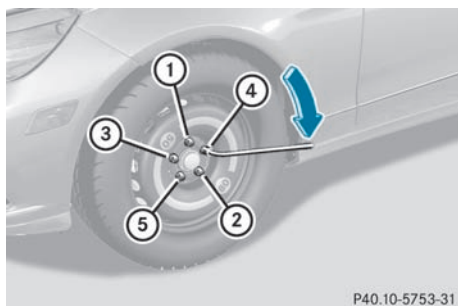

- ▶ Tighten the wheel bolts evenly in a crosswise pattern in the sequence indicated (① to ⑤). The tightening torque must be **96 lb-ft (130 Nm)**.

#### **WARNING**

Have the tightening torque checked immediately after a wheel is changed. The wheels could come loose if they are not tightened to a torque of **96 lb/ft (130 Nm)**.

- ▶ Turn the jack back to its initial position and store it together with the rest of the tire-change tool kit in the trunk/cargo compartment.
- ▶ **AMG vehicles and vehicles with AMG equipment:** insert the cover into the outer sill.

Vehicles with an emergency spare wheel:

- ▶ Transport the defective wheel in the trunk/cargo compartment.
- or
- ▶ Depending on the size of the wheel, you may also be able to secure the defective wheel in the spare wheel well. In this case, you will have to remove the stowage well casing from the spare wheel well and stow it securely in the trunk/cargo compartment.

For further information on stowing the collapsible spare wheel, see (▶ page 325).

- i** When you are driving with the collapsible spare wheel mounted, the tire pressure loss warning system or the tire pressure

monitoring system cannot function reliably. Only restart the tire pressure loss warning system/tire pressure monitoring system when the defective wheel has been replaced with a new wheel.

Vehicles with tire pressure monitoring system: all mounted wheels must be equipped with functioning sensors and the defective wheel should no longer be in the vehicle.

#### **MOExtended tires (tires with run-flat properties)**

MOExtended tires (tires with run-flat properties) allow you to continue driving your vehicle even if one or more tires are entirely deflated.

MOExtended tires may only be used in conjunction with the activated tire pressure loss warning system or with the activated tire pressure monitoring system.

The maximum permissible distance which can be driven in run-flat mode depends on the load in the vehicle. You can drive 50 miles (80 km) if the vehicle is partially laden and 18 miles (30 km) if it is fully laden.

The maximum permissible distance which can be driven in run-flat mode is counted from the moment the tire pressure loss warning appears in the multifunction display.

You must not exceed a maximum speed of 50 mph (80 km/h).

#### **WARNING**

The handling characteristics of your vehicle deteriorate in run-flat mode, for example:

- when cornering
- when braking
- when accelerating rapidly

Adapt your driving style accordingly and avoid sudden changes in direction and sudden acceleration, as well as driving over obstacles (i.e. curbs, potholes), and driving off-road.

This is particularly the case when the vehicle is heavily laden.

The maximum permissible distance that can be driven in run-flat mode depends to a large extent on the loads placed on the vehicle. It can be shorter due to high speeds, a heavy load, sudden changes in direction, the road surface condition, outside temperature, etc., or further if you drive carefully and conservatively.

Do not continue to drive in run-flat mode if:

- you hear banging noises.
- the vehicle starts to shake.
- you see smoke and smell rubber.
- ESP® is intervening constantly.
- there are tears in the sidewalls of the tire.

After driving in run-flat mode, you must have the wheel(s) checked for damage at a qualified specialist workshop which has the necessary specialist knowledge and tools to carry out the work required. The defective tire must be replaced in every case.

Mercedes-Benz recommends that you use an authorized Mercedes-Benz Center for this purpose. In particular, work relevant to safety or on safety-related systems must be carried out at a qualified specialist workshop.

- i** When replacing one or all tires, make sure that you only use tires marked MOExtended and of the specified size for the vehicle.
- i** Vehicles equipped with MOExtended tires are not equipped with a TIREFIT kit at the factory. It is therefore recommended that you additionally equip your vehicle with a TIREFIT kit if you mount tires that do not feature run-flat properties, e.g. winter tires. A TIREFIT kit can be obtained from an authorized Mercedes-Benz Center.

## Battery

### Important safety notes

In order for the battery to achieve the maximum possible service life, it must always be sufficiently charged.

**!** Have the battery checked regularly at a qualified specialist workshop, such as an authorized Mercedes-Benz Center.

Adhere to the service intervals indicated in the service booklet or ask a qualified specialist workshop, such as an authorized Mercedes-Benz Center.

Have the battery charge checked more frequently if you use the vehicle mainly for short trips or if you leave it standing idle for a lengthy period.

Only replace a battery with a battery that has been recommended by Mercedes-Benz.

Consult an authorized Mercedes-Benz Center if you wish to leave your vehicle parked for a long period of time.

### WARNING

Comply with safety precautions and take protective measures when handling batteries.



Risk of explosion



Fire, naked flames and smoking are prohibited when handling the battery. Avoid creating sparks.



Battery acid is caustic. Avoid contact with the skin, eyes or clothing.

Wear suitable protective clothing, in particular gloves, an apron and a face mask.

Immediately rinse acid splashes off with clean water. Consult a doctor if necessary.



Wear eye protection.



Keep children away.



Observe this Operator's Manual.



### Environmental note



Batteries contain dangerous substances. It is against the law to dispose of them with the household rubbish. They must be collected separately and recycled to protect the environment.



Dispose of batteries in an environmentally friendly manner. Return discharged batteries to a qualified specialist workshop, e.g. an authorized Mercedes-Benz Center, or to a special collection point for old batteries.



### WARNING

Failure to follow these instructions can result in severe injury or death.

Never lean over batteries while connecting. You might get injured.

Battery fluid contains sulfuric acid. Do not allow this fluid to come in contact with eyes, skin or clothing. In case it does, immediately flush affected area with water and seek medical help if necessary.

A battery will also produce hydrogen gas, which is flammable and explosive. Keep flames or sparks away from battery, avoid improper connection of jumper cables, smoking etc.



### WARNING

Do not place any metal objects on the battery as this could result in a short circuit.

Use leak-proof batteries only to avoid the risk of acid burns in the event of an accident.

Take care that you do not become statically charged, e.g. by wearing synthetic clothing or rubbing against textiles. For this reason, you also should not pull or push the battery over carpets or other synthetic materials.

Never touch the battery first. First, touch the outside body of the vehicle in order to release any possible electrostatic charges.

Do not rub the battery with rags or cloths. The battery could explode if touched due to electrostatic charge or due to spark formation.

**!** Before working on the battery, e.g. loosening the battery terminals, switch off the engine and remove the SmartKey from the ignition. On vehicles with KEYLESS-GO, make sure that the ignition is switched off. Check that all the indicator lamps in the instrument cluster are off. You may otherwise destroy electronic components, such as the alternator.

**!** Like other batteries, the vehicle battery may discharge over time if you do not use the vehicle. In this case have the battery checked at a qualified specialist workshop, such as an authorized Mercedes-Benz Center. You can also charge the battery with a charger recommended by Mercedes-Benz. Contact an authorized Mercedes-Benz Center for more information.

The battery and the cover of the positive terminal clamp must be installed securely during operation.

**i** Remove the SmartKey if you park the vehicle and do not require any electrical consumers. The vehicle will then use very little energy, thus conserving battery power.

Mercedes-Benz recommends that you do not carry out work on batteries yourself, e.g. removing or charging. Always have this work performed at a qualified specialist workshop, e.g. an authorized Mercedes-Benz Center.

### Charging the battery

#### WARNING

Never charge a battery still installed in the vehicle unless a battery charger unit approved by Mercedes-Benz is being used. Gases may escape during charging and cause explosions that may result in paint damage, corrosion or personal injury.

A battery charger unit specially adapted for Mercedes-Benz vehicles and tested and approved by Mercedes-Benz is available as an accessory. It permits the charging of the battery in its installed position. Contact an authorized Mercedes-Benz Center for further information and availability.



Charge the battery in accordance with the separate instructions for the battery charger.

#### WARNING

There is a risk of acid burns during the charging process due to the gases which escape from the battery. Do not lean over the battery during the charging process.

#### WARNING

Battery acid is caustic. Avoid contact with the skin, eyes or clothing.

-  Only charge the installed battery with a battery charger which has been tested and approved by Mercedes-Benz. These battery chargers allow the battery to be charged while still installed.
-  Only use battery chargers with a maximum charging voltage of 14.8 V.
-  Only charge the battery using the jump-starting connection point.

The jump-starting connection point is in the engine compartment (▷ page 338).

- ▶ Open the hood (▷ page 308).
- ▶ Connect the battery charger to the positive terminal and earth point in the same order as when connecting the donor battery in the jump-starting procedure (▷ page 338).
- ▶ Read the battery charger's operating instructions before charging the battery.

## Jump-starting

 **WARNING**

Failure to follow these directions will cause damage to the electronic components, and can lead to a battery explosion and severe injury or death.

Never lean over batteries while connecting or jump starting. You might get injured.

Battery fluid contains sulfuric acid. Do not allow this fluid to come in contact with eyes, skin or clothing. In case it does, immediately flush affected area with water, and seek medical help if necessary.

A battery will also produce hydrogen gas, which is flammable and explosive. Keep flames or sparks away from battery, avoid improper connection of jumper cables, smoking, etc.

Attempting to jump start a frozen battery can result in it exploding, causing personal injury.

Read all instructions before proceeding.

**!** Avoid repeated and lengthy starting attempts. Otherwise, non-combusted fuel may damage the catalytic converter<sup>31</sup> and create a risk of fire.

Do not use a rapid-charging device to start the engine.

Make sure the jumper cables are not damaged.

Make sure the jumper cables are not touching any other metal objects when they are connected to the battery.

If your vehicle's battery is discharged, the engine can be jump-started from another vehicle or from a second battery using jumper cables.

Observe the following points:

- ▶ The battery is not accessible in all vehicles. If the other vehicle's battery is not accessible, jump-start the vehicle using a second battery or a jump-starting device.
  - ▶ Only jump-start the vehicle when the engine is cold and the catalytic converter system has cooled down<sup>32</sup>.
  - ▶ Do not start the engine if the battery is frozen. Let the battery thaw first.
  - ▶ Jump-starting may only be performed from batteries with a nominal voltage of 12 V.
  - ▶ Only use jumper cables which have a sufficient cross-section and insulated terminal clamps.
  - ▶ Make sure that the jumper cables cannot come into contact with parts, such as the pulley or the fan. These parts move when the engine is started and while it is running.
  - ▶ If the battery is fully discharged, leave the battery that is being used to jump-start connected for a few minutes before attempting to start. This charges the empty battery a little.
- i** Jumper cables and further information about jump-starting can be obtained from any authorized Mercedes-Benz Center, for example.
- ▶ Make sure that the two vehicles do not touch.
  - ▶ Apply the parking brake firmly.
  - ▶ Shift the transmission to position **P**.

<sup>31</sup> Only vehicles with a gasoline engine.

<sup>32</sup> Only vehicles with a gasoline engine.



- ▶ Switch off all electrical consumers (e.g. radio, blower, etc.).
- ▶ Open the hood (▶ page 308).

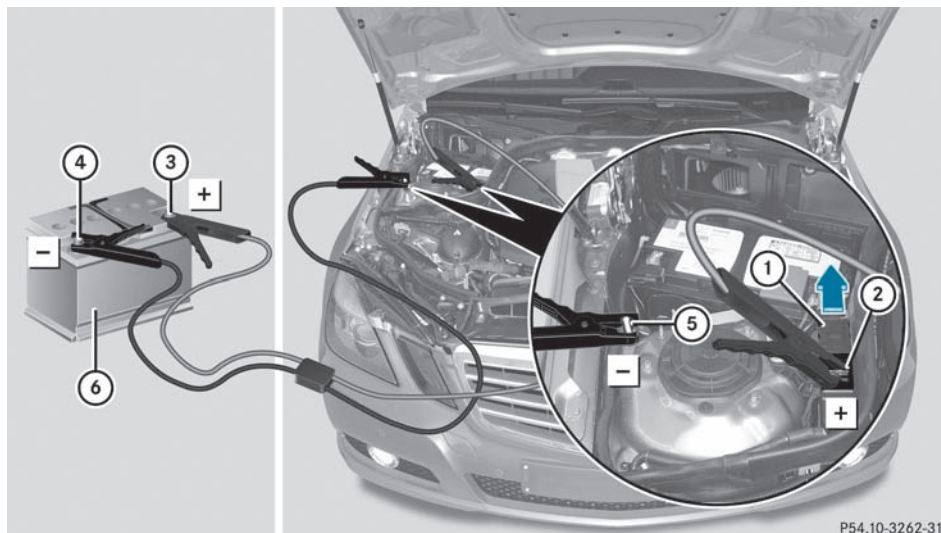

P54.10-3262-31

Position number ⑥ identifies the charged battery of the other vehicle or an equivalent jump-starting device.

- ▶ Slide cover ① of positive terminal ② in the direction of the arrow.
- ▶ Connect positive terminal ② on your vehicle to positive terminal ③ of donor battery ⑥ using the jumper cable, beginning with your own battery.
- ▶ Start the engine of the donor vehicle and run it at idling speed.
- ▶ Connect negative terminal ④ of donor battery ⑥ to earth point ⑤ of your vehicle using the jumper cable, connecting the jumper cable to donor battery ⑥ first.
- ▶ Start the engine.
- ▶ Allow the engine to run for a few minutes before disconnecting the jumper cable.
- ▶ First, remove the jumper cable from earth point ⑤ and negative terminal ④, then from positive terminal ② and positive terminal ③, each time disconnecting from the contacts on your own vehicle first.
- ▶ After removing the jumper cable, close cover ① on positive terminal ②.
- ▶ Have the battery checked at a qualified specialist workshop, e.g. an authorized Mercedes-Benz Center. The jump-starting procedure is not a standard operating state; therefore, have the battery checked.

## Towing and tow-starting

### Important safety notes

#### WARNING

If you tow the vehicle, you must use a rigid towing bar if:

- the engine is not running.
- there is a brake system malfunction.
- there is a malfunction in the power supply or the vehicle's electrical system.

The power assistance for the steering and the brake force booster do not work when the engine is not running. You will need more force to steer and brake, you may have to depress the brake pedal with maximum force.

Before towing away, make sure that the steering can be moved and is not locked.

If you tow or tow-start another vehicle, its weight must not exceed the maximum permissible gross vehicle weight of your vehicle.

#### WARNING

The vehicle is braked when the HOLD function or DISTRONIC PLUS is activated. Therefore, deactivate HOLD and DISTRONIC PLUS if the vehicle is to be towed.

It is better to have the vehicle transported than to have it towed.

- ❗ You may only tow the vehicle a maximum distance of 30 miles (50 km). A towing speed of 30 mph (50 km/h) must not be exceeded.

For towing distances over 30 miles (50 km), the vehicle must be loaded onto a transporter.

- ❗ Only secure the tow rope or tow bar at the towing eyes. Otherwise, the vehicle could be damaged.
- ❗ Do not use the towing eye for recovery, as this could damage the vehicle. If in doubt, recover the vehicle with a crane.

- ❗ When towing, pull away slowly and smoothly. If the tractive power is too high, the vehicles could be damaged.

- ❗ Do not tow with sling-type equipment. This could damage the vehicle.

- ❗ When towing vehicles with KEYLESS-GO, use the key instead of the Start/Stop button. Otherwise, the automatic transmission may shift to position **P** when the driver's or front-passenger door are opened, which could lead to damage to the transmission.

The automatic transmission must be in position **N** when the vehicle is being towed. The battery must be connected and charged. Otherwise, you:

- cannot turn the SmartKey to position **2** in the ignition lock
  - cannot shift the automatic transmission to position **N**
-  Before the vehicle is towed, switch off the automatic locking feature (▷ page 83). You could otherwise be locked out when pushing or towing the vehicle.

### Installing/removing the towing eye

#### Installing the towing eye

- ▶ Remove the towing eye from the vehicle tool kit (▷ page 322).

#### WARNING

The exhaust tail pipe may be hot. You could burn yourself if you touch the tail pipe. Be particularly careful when removing the rear cover.

The mountings for the removable towing eyes are located in the bumpers. They are at the front and at the rear, under the covers.

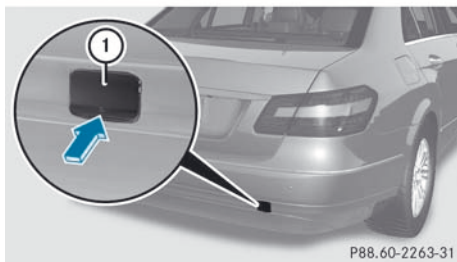

Example: Sedan

- ▶ Press the mark on cover ① inwards in the direction of the arrow.
- ▶ Take cover ① off the opening.
- ▶ Screw the towing eye in clockwise to the stop and tighten it.

### Removing the towing eye

- ▶ Loosen the towing eye and unscrew it.
- ▶ Attach cover ① to the bumper and press until it engages.
- ▶ Place the towing eye in the vehicle tool kit.

### Towing the vehicle with the rear axle raised

#### Only possible on vehicles without 4MATIC.

When towing your vehicle with the rear axle raised, it is important that you observe the safety instructions (▷ page 340).

- ❗ The ignition must be switched off if you are towing the vehicle with the rear axle raised. Intervention by ESP® could otherwise damage the brake system.

- ▶ Switch on the hazard warning lamps (▷ page 118).
- ▶ Turn the SmartKey to position **0** in the ignition lock and remove the SmartKey from the ignition lock.
- ▶ When leaving the vehicle, take the SmartKey or the KEYLESS-GO key with you.

### Towing a vehicle with both axles on the ground

When having your vehicle towed, observe the important safety notes (▷ page 340).

#### ⚠ WARNING

The power assistance for the steering and the brake force booster do not work when the engine is not running. You will then need much more effort to brake and steer the vehicle. Adapt your style of driving accordingly.

The automatic transmission automatically shifts to position **P** when you open the driver's or front-passenger door or when you remove the SmartKey from the ignition lock. In order to ensure that the automatic transmission stays in position **N** when towing the vehicle, you must observe the following points:

- ▶ Make sure that the vehicle is stationary and the SmartKey in the ignition lock is in position **0**.
- ▶ Turn the SmartKey to position **2** in the ignition lock.  
On vehicles with KEYLESS-GO, use the key instead of the Start/Stop button (▷ page 145).
- ▶ Depress and hold the brake pedal.
- ▶ Shift the automatic transmission to position **N**.
- ▶ Release the brake pedal.
- ▶ Release the parking brake.
- ▶ Leave the SmartKey in position **2** in the ignition lock.

### Transporting the vehicle

The towing eye can be used to pull the vehicle onto a trailer or transporter for transporting purposes.

- ▶ Turn the SmartKey to position **2** in the ignition lock.
- ▶ Shift the automatic transmission to position **N**.

#### As soon as the vehicle is loaded:

- ▶ Prevent the vehicle from rolling away by applying the parking brake.
- ▶ Shift the automatic transmission to position **P**.
- ▶ Turn the SmartKey to position **0** in the ignition lock and remove the SmartKey from the ignition lock.
- ▶ Secure the vehicle.

**!** Only lash the vehicle down by the wheels or wheel rims, not by parts of the vehicle such as axle or steering components. Otherwise, the vehicle could be damaged.

### Notes for 4MATIC vehicles

**!** Vehicles with 4MATIC must not be towed with either the front or the rear axle raised, as doing so will damage the transmission.

If the vehicle has transmission damage or damage to the front or rear axle, have it transported on a transporter or trailer.

#### In the event of damage to the electrical system

If the battery is defective, the automatic transmission will be locked in position **P**. To shift the automatic transmission to position **N**, you must provide power to the vehicle's electrical system in the same way as when jump-starting (▷ page 338).

Have the vehicle transported on a transporter or trailer.

### Tow-starting (emergency starting)

**!** Vehicles with automatic transmission must not be started by tow-starting. This could otherwise damage the transmission.

## Fuses

### Important safety notes

The fuses in your vehicle serve to close down faulty circuits. If a fuse blows, all the components on the circuit and their functions stop operating.

#### WARNING

Only use fuses approved by Mercedes-Benz with the specified amperage for the system in question and do not attempt to repair or bridge a blown fuse. Using other than approved fuses or using repaired or bridged fuses may cause an overload leading to a fire, and/or cause damage to electrical components and/or systems. Have the cause determined and remedied by an authorized Mercedes-Benz Center.

Blown fuses must be replaced with fuses of the same rating, which you can recognize by the color and value. The fuse ratings are listed in the fuse allocation chart. An authorized Mercedes-Benz Center will be happy to advise you.

**i** If a fuse has blown, contact a breakdown service or an authorized Mercedes-Benz Center.

If the newly inserted fuse also blows, have the cause traced and rectified at a qualified specialist workshop, e.g. an authorized Mercedes-Benz Center.

**!** Only use fuses that have been approved for Mercedes-Benz vehicles and which have the correct fuse rating for the system concerned. Otherwise, components or systems could be damaged.

### Before changing a fuse

- ▶ Park the vehicle and apply the parking brake.
- ▶ Switch off all electrical consumers.
- ▶ Remove the SmartKey from the ignition lock.

The fuses are located in various fuse boxes:

- fuse box in the engine compartment on the left-hand side of the vehicle, when viewed in the direction of travel
- fuse box in the trunk/cargo compartment on the right-hand side of the vehicle, when viewed in the direction of travel

The fuse allocation chart is located in the vehicle tool kit (▷ page 322) in the stowage compartment under the trunk/cargo compartment floor.

### Fuse box in the engine compartment

- ▶ Make sure that the windshield wipers are turned off.

#### WARNING

Make sure that the windshield wipers are switched off and that the SmartKey is removed from the ignition lock before you open the cover of the fuse box. Otherwise, the windshield wipers and the wiper rods above the cover could be set in motion. This could lead to you or others being injured by the wiper rods.

- ▶ Open the hood (▷ page 308).

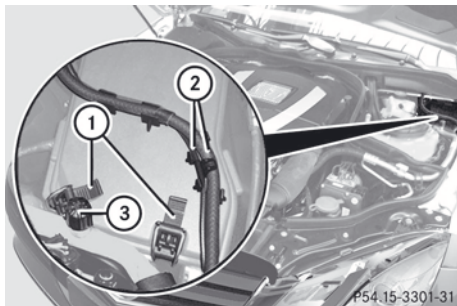

- ▶ Remove any existing moisture from the fuse box using a dry cloth.
- ▶ Take lines ② from the guides.
- ▶ Move aside lines ②. Route the lines behind connection ③ to do this.
- ▶ **To open:** open clamps ①.
- ▶ Remove the fuse box cover forwards.

**!** Make sure that no moisture can enter the fuse box when the cover is open.

- ▶ **To close:** check whether the rubber seal is lying correctly in the cover.
- ▶ Insert the cover at the rear of the fuse box into the retainer.
- ▶ Fold down the cover and close clamps ①.
- ▶ Secure lines ② in the guides.

**!** The cover must be seated properly, otherwise moisture or dirt could impair the function of the fuses.

- ▶ Close the hood (▷ page 309).

### Fuse box in the trunk

- ▶ Open the trunk lid (▷ page 84).

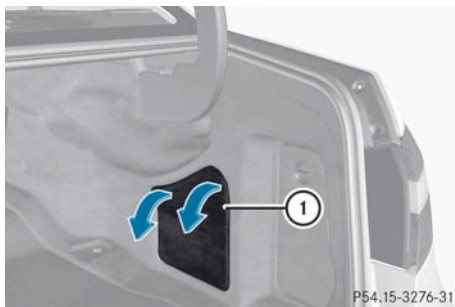

- ▶ **To open:** release cover ① at the top right and left-hand sides with a flat object.
- ▶ Open cover ① downwards in the direction of the arrow.

### Fuse box in the cargo compartment

- ▶ Open the tailgate.

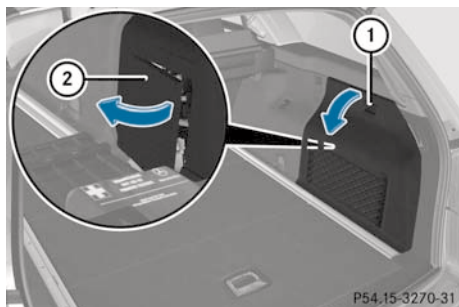

- ▶ **To open:** pull handle ①.
- ▶ Open the cover downwards.
- ▶ Fold trim ② forwards.

Useful information .....	346
Important safety notes .....	346
Operation .....	346
Winter operation .....	348
Tire pressure .....	349
Loading the vehicle .....	358
Maximum load rating .....	361
Uniform Tire Quality Grading Standards .....	362
Tire labeling .....	363
Definition of terms for tires and loading .....	367
Changing a wheel .....	370
Wheel and tire combinations .....	371



### Useful information

- i** This Operator's Manual describes all models and all standard and optional equipment of your vehicle available at the time of publication of the Operator's Manual. Country-specific differences are possible. Please note that your vehicle may not be equipped with all features described. This also applies to safety-related systems and functions.
- i** Please read the information on qualified specialist workshops (▷ page 25).

### Important safety notes

Consult an authorized Mercedes-Benz Center if you require information on approved and recommended tires and wheels for summer and winter operation. Advice on purchasing and caring for tires is also available there.

#### WARNING

Replace rims or tires with the same designation, manufacturer and type as shown on the original part. For further information contact an authorized Mercedes-Benz Center. If incorrectly sized rims and tires are mounted, the wheel brakes or suspension components can be damaged. Also, the operating clearance of the wheels and the tires may no longer be correct.

#### WARNING

Worn, old tires can cause accidents. If the tire tread is worn to minimum tread depth, or if the tires have sustained damage, replace them.

When replacing rims, only use genuine Mercedes-Benz wheel bolts specified for the particular rim type. Failure to do so can result in the bolts loosening and possibly an accident.

Retreaded tires are not tested or recommended by Mercedes-Benz, since previous damage cannot always be

recognized on retreads. The operating safety of the vehicle cannot be assured when such tires are used.

#### WARNING

If you feel a sudden significant vibration or ride disturbance, or you suspect that possible damage to your vehicle has occurred, you should turn on the hazard warning flashers, carefully slow down, and drive with caution to an area which is a safe distance from the road.

Inspect the tires and the vehicle underbody for possible damage. If the vehicle appears unsafe, have the vehicle towed to the nearest authorized Mercedes-Benz Center or tire dealer for repairs.

#### WARNING

Do not drive with a flat tire. A flat tire affects the ability to steer or brake the vehicle. You might lose control of the vehicle. Continued driving with a flat tire or driving at high speed with a flat tire will cause excessive heat build-up and possibly a fire.

- i** Further information about Tires and wheels can be obtained from any authorized Mercedes-Benz Center.

### Operation

#### Notes on driving

- If the vehicle is heavily laden, check the tire pressures and correct them if necessary.
- When parking your vehicle, make sure that the tires do not get deformed by the curb or other obstacles. If it is necessary to drive over curbs, speed humps or similar elevations, try to do so slowly and at an obtuse angle. Otherwise, the tires, particularly the sidewalls, can get damaged.

**Notes on regularly inspecting wheels and tires**

**⚠ WARNING**

Regularly check the tires for damage. Damaged tires can cause tire inflation pressure loss. As a result, you could lose control of your vehicle.

Worn, old tires can cause accidents. If the tire tread is worn to minimum tread depth, or if the tires have sustained damage, replace them.

- Regularly check the wheels and tires of your vehicle for damage (e.g. cuts, punctures, tears, bulges on tires and deformation or cracks or severe corrosion on wheels) at least once a month, as well as after driving off-road or on rough roads. Damaged wheels can cause a loss of tire pressure.
- Regularly check the tire tread depth and the condition of the tread across the whole width of the tire (▷ page 347). If necessary, turn the front wheels to full lock in order to inspect the inner side of the tire surface.
- All wheels must have a valve cap to protect the valve against dirt and moisture. Do not mount anything onto the valve (such as tire pressure monitoring systems) other than the standard valve cap or other valve caps approved by Mercedes-Benz for your vehicle.
- Regularly check the pressure of all the tires including the emergency spare wheel or the spare wheel, particularly prior to long trips, and correct the pressure as necessary (▷ page 349).

**Tire tread**

**⚠ WARNING**

Although the applicable federal motor vehicle safety laws consider a tire to be worn when the tread wear indicators (TWI) become visible at approximately  $1/16$  in (1.6 mm), we

recommend that you do not allow your tires to wear down to that level. As tread depth approaches  $1/8$  in (3 mm), the adhesion properties on a wet road are sharply reduced. Depending upon the weather and/or road surface (conditions), the tire traction varies widely.

Do not use tires that are excessively worn as the tire traction on wet road surfaces decreases significantly when the tread depth is less than  $1/8$  inch (3 mm).

Tread wear indicators (TWI) are required by law. Six indicators are positioned on the tire tread. They become visible as soon as a tread depth of approximately  $1/16$  inch (1.6 mm) has been reached. If this is the case, the tire is so worn that it must be replaced.

The recommended tread depth for summer tires is at least  $1/8$  inch (3 mm). The recommended tread depth for winter tires is at least  $1/6$  inch (4 mm).

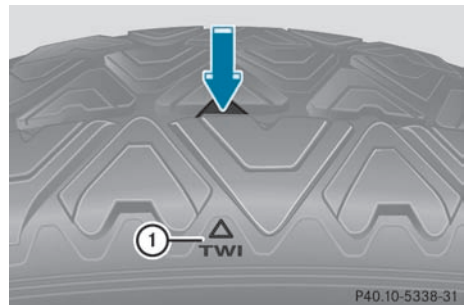

Bar marking ① for tread wear is integrated into the tire tread.

**Notes on selecting, mounting and replacing tires**

- Only mount tires and wheels of the same type and make.
- Only mount tires of the correct size onto the wheels.
- After mounting new tires, run them in at moderate speeds for the first 60 miles

(100 km) as they only reach their full performance after this distance.

- Do not use tires that are excessively worn as the tire traction on wet road surfaces decreases significantly when the tread depth is less than  $\frac{1}{8}$  inch (3 mm).
- Replace the tires after six years at the latest, regardless of wear. This also applies to the spare wheel/emergency spare wheel.

The service life of tires depends on the following factors amongst other things:

- driving style
- tire pressure
- mileage

### MOExtended tires (tires with run-flat properties)

MOExtended tires (tires with run-flat properties) allow you to continue driving your vehicle even if one or more tires are entirely deflated.

MOExtended tires may be used only in conjunction with the activated tire pressure loss warning system or the activated tire pressure monitoring system and only on wheels specifically tested by Mercedes-Benz.

- i** Vehicles equipped with MOExtended tires are not equipped with a TIREFIT kit at the factory. It is therefore recommended that you additionally equip your vehicle with the TIREFIT kit if you mount tires that do not feature run-flat properties, e.g. winter tires. A TIREFIT kit can be obtained from an authorized Mercedes-Benz Center.

You will find notes on driving with MOExtended tires in the "Breakdown assistance" section (▷ page 334).

## Winter operation

### Please bear the following in mind

At the onset of winter, have your vehicle winterproofed at a qualified specialist workshop, e.g. at an authorized Mercedes-Benz Center.

Observe the notes in the "Changing a wheel" section (▷ page 370).

### Driving with summer tires

At temperatures below 45 °F (+7 °C), the elasticity of summer tires and therefore also traction and braking capability are reduced considerably – equip your vehicle with M+S tires. Using summer tires at very cold temperatures could cause tears to form, thereby damaging the tires permanently. Mercedes-Benz cannot accept responsibility for this type of damage.

### M+S tires

At temperatures below 45 °F (+7 °C), use winter tires or all-season tires. Both types of tire are identified by the M+S marking. Only winter tires bearing the  snowflake symbol in addition to the M+S marking provide the best possible grip in wintry road conditions. Only these tires will allow driving safety systems such as ABS and ESP® to function optimally in winter, as these tires have been designed specifically for driving on snow.

Use M+S tires of the same make and tread on all wheels to maintain safe handling characteristics.

### WARNING

M+S tires with a tread depth of less than  $\frac{1}{6}$  inch (4 mm) must be replaced immediately. They are no longer suitable for use in winter.

Always observe the maximum permissible speed specified for the M+S tires you have mounted.

Once you have mounted the winter tires:

- ▶ Check the tire pressures (▷ page 353).
- ▶ Restart the tire pressure monitor (▷ page 355).

### WARNING

If you use your spare wheel when M+S tires are mounted on the other wheels, be aware that the difference in tire characteristics impairs cornering ability and reduces driving stability. Adapt your driving style accordingly.

Have the spare wheel replaced by a normal wheel with an M+S tire at the nearest Mercedes-Benz Center.

### Snow chains

For safety reasons, Mercedes-Benz recommends that you only use snow chains which have been specially approved for your vehicle by Mercedes-Benz, or are of a corresponding standard of quality.

- !** On vehicles with AIRMATIC, you must drive at raised vehicle level if snow chains have been mounted. The vehicle may otherwise be damaged.
- !** There is not enough space for snow chains on some wheel sizes. Observe the information under "Tires and wheels" in the "Technical Data" section to avoid damage to the vehicle or the wheels.
- Only use snow chains when driving on roads completely covered by snow. Do not exceed the maximum permissible speed of 30 mph (50 km/h). Remove the snow chains as soon as possible when you are no longer driving on snow-covered roads.
- Local regulations may restrict the use of snow chains. Applicable regulations must

be observed if you wish to mount snow chains.

- Snow chains must not be mounted on emergency spare wheels.

If you intend to mount snow chains, please bear the following points in mind:

- you may not attach snow chains to all wheel-tire combinations; see the information under "Wheel and tire combinations" in the "Wheels and tires" section.
- mount snow chains only in pairs and only to the rear wheels. Observe the manufacturer's installation instructions.

**!** If snow chains are mounted on the front wheels, the snow chains could grind against the bodywork or components of the chassis. This could result in damage to the vehicle or the tires.

**!** **Vehicles with steel wheels:** if you wish to mount snow chains on steel wheels, make sure that you remove the respective wheels' hubcaps first. The hubcaps may otherwise be damaged.

**i** You may wish to deactivate ESP® (▷ page 66) when pulling away with snow chains mounted. This way you can allow the wheels to spin in a controlled manner, achieving an increased driving force (cutting action).

### Tire pressure

#### Tire pressure specifications

### WARNING

Follow recommended tire inflation pressures. Do not underinflate tires. Underinflated tires wear excessively and/or unevenly, adversely affect handling and fuel economy, and are more likely to fail from being overheated.

Do not overinflate tires. Overinflated tires can adversely affect handling and ride comfort, wear unevenly, increase stopping distance,

and result in sudden deflation (blowout) because they are more likely to become punctured or damaged by road debris, potholes etc.

Do not overload the tires by exceeding the specified load limit as indicated on the Tire and Loading Information placard on the driver's door B-pillar. Overloading the tires can overheat them, possibly causing a blowout. Overloading the tires can also result in handling or steering problems, or brake failure.

The recommended tire pressures for the tires mounted at the factory can be found on the labels described here.

Option 1) **Tire and Loading Information placard** on the B-pillar on the driver's side of the vehicle (▷ page 358).

The Tire and Loading Information placard contains the recommended tire pressures for cold tires on a fully loaded vehicle and for the maximum permissible vehicle speed.

① The specifications given on the following Tire and Loading Information placard are examples. Tire pressure specifications are vehicle-specific and may deviate from the data shown here. The tire pressures applicable to your vehicle can be found on the Tire and Loading Information placard on your vehicle.

**TIRE AND LOADING INFORMATION**  
RENSEIGNEMENTS POUR LES PNEUS ET LE CHARGEMENT

SEATING CAPACITY / NOMBRE DE SIÈGES: 509

FRONT / AVANT: 2 | MIDDLE / MILIEU: 2 | REAR / ARRIÈRE: 2

The combined weight of occupants and cargo should never exceed 2000 kg or 2000 lbs. Le poids total des occupants et des marchandises ne doit jamais dépasser 2000 kg ou 2000 lbs.

TIRE / PNEU	SIZE / TAILLE	COLD TIRE PRESSURE / PRESSION DES PNEUS À FROID
FRONT / AVANT	255/40 ZR18 99YXL	200 kPa, 29 PSI
REAR / ARRIÈRE	285/35 ZR18 101YXL	200 kPa, 29 PSI
SPARE / DE REMPLACEMENT	175/55-18 95P	420 kPa, 40 PSI

SEE OWNERS MANUAL FOR ADDITIONAL INFORMATION

P40.00-2133-31

① Recommended tire pressures

Option 2) **Tire pressure table** on the inside of the fuel filler flap.

The tire pressure table contains the recommended pressures for cold tires for various operating conditions, i.e. differing load and speed conditions.

① Specifications shown in the examples of tire pressure tables are for illustration purposes only. Tire pressure specifications are vehicle-specific and may deviate from the data shown here. Tire pressure specifications applicable to your vehicle are located in your vehicle's tire pressure table.

**COLD TIRE PRESSURE**

normal load | maximum load

Warm tires up to: + 4 psi

P40.00-2179-31

Example: tire pressure table for all tires approved ex-works for this vehicle

If a tire size precedes a tire pressure, the tire pressure information following is only valid for that tire size. The load conditions "partially laden" and "fully laden" are defined in the table for different numbers of passengers and amounts of luggage. The actual number of seats may differ.

**LUFTDRUCK PRESSURE PRESSION PRESSION**

für kalte Reifen / for cold tires / des pneus froids / de inflado

100 kPa = 1 bar

	195/55 R16	215/45 R17	215/40 R18
partially laden	200 kPa	200 kPa	200 kPa
fully laden	200 kPa	200 kPa	200 kPa

Warme Reifen: Warm tires up to: + 30 kPa / + 4 psi

Pneus échauffés jusqu'à: Neumáticos calentados hasta:

P40.00-2183-31

Example: tire pressure table with tire dimensions  
Some tire pressure tables show only the rim diameters instead of the full tire size, e.g.

**R18.** The rim diameter is part of the tire size and can be found on the tire sidewall (▷ page 364).

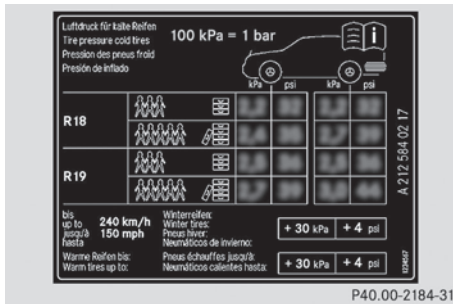

If the tire pressures have been set to the lower values for lighter loads and/or lower road speeds, the pressures should be reset to the higher values:

- if you want to drive with an increased load and/or
- if you want to drive at higher road speeds.

**i** The tire pressures for increased loads and/or higher road speeds, shown in the tire pressure table, may have a negative effect on driving comfort.

Option 3) The **tire pressure for the emergency/collapsible spare wheel** (depending on vehicle equipment) can be found:

- printed in yellow on the rim of the emergency/collapsible spare wheel
- in the "Wheel and tire combinations" section (▷ page 371) in this manual
- on the Tire and Loading Information placard on the B-pillar on the driver's side.

If the tire pressure is not set correctly, this can lead to an excessive build up of heat and a sudden loss of pressure.

For further information, consult a qualified specialist workshop, e.g. an authorized Mercedes-Benz Center.

## Important notes on tire pressure

### ⚠ WARNING

Should the tire pressure drop repeatedly:

- check the tire for foreign bodies.
- check whether the wheel is losing air or the valve is leaking.
- make sure that only a valve cap approved by Mercedes-Benz is used on the tire valve.

Tire pressures that are too low have a negative effect on vehicle safety, which could lead you to cause an accident.

To test tire pressure, use a suitable tire pressure gauge. The outer appearance of a tire does not permit any reliable conclusion about the tire pressure. On vehicles equipped with the electronic tire pressure monitoring system, the tire pressure can be checked using the on-board computer.

The tire temperature and pressure increase when the vehicle is in motion. This is dependent on the driving speed and the load. Therefore, you should only correct tire pressures when the tires are cold.

The tires are cold:

- if the vehicle has been parked without direct sunlight on the tires for at least three hours and
- if the vehicle has not been driven more than 1 mile (1.6 km).

The tire temperature changes depending on the outside temperature, the vehicle speed and the tire load. If the tire temperature changes by 18 °F (10 °C), the tire pressure changes by approximately 10 kPa (0.1 bar / 1.5 psi). Take this into account when checking the pressure of warm tires and only correct the tire pressure if it is too low for the current operating conditions. If you check the tire pressure when the tires are warm, the resulting value will be higher than if the tires were cold. This is normal. Do not reduce the tire pressure to the value specified for cold tires. The tire pressure would otherwise be too low.

Observe the recommended tire pressures for cold tires

- on the Tire and Loading Information placard on the B-pillar on the driver's side,
- in the tire pressure table on the inside of the fuel filler flap,
- printed in yellow on the rim of the emergency/collapsible spare wheel (depending on vehicle equipment).

### Underinflated or overinflated tires

#### Underinflated tires

##### WARNING

Follow recommended tire inflation pressures. Do not underinflate tires. Underinflated tires wear excessively and/or unevenly, adversely affect handling and fuel economy, and are more likely to fail from being overheated.

Underinflated tires can:

- wear excessively and/or unevenly
- adversely affect fuel economy
- fail from being overheated
- adversely affect handling

#### Overinflated tires

##### WARNING

Follow recommended tire inflation pressures. Do not overinflate tires. Overinflated tires can adversely affect handling and ride comfort, wear unevenly, increase stopping distance, and result in sudden deflation (blowout) because they are more likely to become punctured or damaged by road debris, potholes etc.

Overinflated tires can:

- adversely affect handling
- wear excessively and/or unevenly
- be more likely to become damaged

- adversely affect ride comfort
- increase stopping distance

### Maximum tire pressure

##### WARNING

Never exceed the maximum tire inflation pressure. Follow recommended tire inflation pressures.

Do not underinflate tires. Underinflated tires wear excessively and/or unevenly, adversely affect handling and fuel economy, and are more likely to fail from being overheated.

Do not overinflate tires. Overinflated tires can adversely affect handling and ride comfort, wear unevenly, increase stopping distance, and result in sudden deflation (blowout) because they are more likely to become punctured or damaged by road debris, potholes etc.



① Maximum permitted tire pressure (example)

 The actual values for tires are specific to each vehicle and may deviate from the values in the illustration.

When adjusting the tire pressures always observe the recommended tire pressure for your vehicle (▷ page 349).



## Checking the tire pressures

### Important safety notes

#### WARNING

Follow recommended tire inflation pressures.

Do not underinflate tires. Underinflated tires wear excessively and/or unevenly, adversely affect handling and fuel economy, and are more likely to fail from being overheated.

Do not overinflate tires. Overinflated tires can adversely affect handling and ride comfort, wear unevenly, increase stopping distance, and result in sudden deflation (blowout) because they are more likely to become punctured or damaged by road debris, potholes etc.

Do not overload the tires by exceeding the specified load limit as indicated on the Tire and Loading Information placard on the driver's door B-pillar. Overloading the tires can overheat them, possibly causing a blowout. Overloading the tires can also result in handling or steering problems, or brake failure.

Check the tire pressure at least once a month. Only check and correct tire pressures when the tires are cold (▷ page 349).

### Checking tire pressure manually

To determine and set the correct tire pressure, proceed as follows:

- ▶ Remove the valve cap of the tire that is to be checked.
- ▶ Press the tire pressure gauge securely onto the valve.
- ▶ Read the tire pressure and compare it with the recommended value on the Tire and Loading Information placard on the B-pillar on the driver's side of your vehicle.
- ▶ If necessary, increase the tire pressure to the recommended value (▷ page 349).
- ▶ If the tire pressure is too high, release air by pressing down the metal pin in the valve using the tip of a pen, for example. Then

check the tire pressure again using the tire pressure gauge.

- ▶ Screw the valve cap onto the valve.
- ▶ Repeat these steps for the other tires.

### Tire pressure loss warning system (Canada only)

#### Important safety notes

While the vehicle is in motion, the tire pressure loss warning system monitors the set tire pressure using the rotational speed of the wheels. This enables the system to detect significant pressure loss in a tire. If the speed of rotation of a wheel changes as a result of a loss of pressure, a corresponding warning message will appear in the multifunction display.

#### WARNING

If the **Check Tire Pressure Soon** message appears in the multifunction display, one or more tires are significantly underinflated. Stop the vehicle as soon as possible and inflate the tires to the pressure specified on the vehicle's Tire and Loading Information placard or (where available) in the tire pressure table.

Driving on a significantly underinflated tire causes the tire to overheat and can lead to tire failure. Underinflation also reduces fuel efficiency and tire tread life, and may affect the vehicle's handling and stopping ability.

Check all tires when cold, including the spare tire, at least once a month. The tires should be inflated to the recommended pressure. This information can be found:

- on the Tire and Loading Information placard on the B-pillar on the driver's side or
- in the table for the tire pressure on the inside of the fuel filler flap

**⚠ WARNING**

The tire pressure loss warning system does not provide a warning for wrongly selected tire inflation pressures. Always adjust tire inflation pressure according to the Tire and Loading Information placard on the driver's door B-pillar or on the tire inflation pressure label located on the inside of the fuel filler flap.

The tire pressure loss warning system does not replace regular checks of the tire inflation pressures since a gradual pressure loss in more than one tire cannot be detected by the tire pressure loss warning system.

The tire pressure loss warning system is not able to issue a warning due to a sudden dramatic loss of tire inflation pressure (e.g. tire blowout caused by a foreign object). In this case bring the vehicle to a halt by carefully applying the brakes and avoiding abrupt steering maneuvers.

The function of the tire pressure loss warning system is limited or delayed if:

- snow chains are mounted to your vehicle's tires.
- road conditions are wintry.
- you are driving on sand or gravel.
- you adopt a very sporty driving style (cornering at high speeds or driving with high rates of acceleration).
- you are driving with a heavy load (in the vehicle or on the roof).

**Restarting the tire pressure loss warning system**

Restart the tire pressure loss warning system if you have:

- changed the tire pressure
  - changed the wheels or tires
  - mount new wheels or tires
- Before restarting, consult the Tire and Loading Information placard on the B-pillar on the driver's side or the tire pressure table on the inside of the fuel filler flap to ensure the tire pressure in all four

tires is set correctly for the current operating conditions.





- Observe the notes in the section on tire pressures (▷ page 349).

**⚠ WARNING**





The tire pressure loss warning system can only give reliable warnings if you have set the correct tire pressure.

If an incorrect tire pressure is set, these incorrect values will be monitored.

A tire with insufficient pressure results in vehicle instability when driving, thus increasing the risk of an accident.

- Make sure that the SmartKey is in position **2** (▷ page 145) in the ignition lock.
- Press the  or  button to select the **Serv.** menu.
- Press the  or  button to select **Tire Pressure**.
- Press the  button.  
The **Run Flat Indicator Active Press 'OK' to Restart** message appears in the multifunction display.

**If you wish to confirm the restart:**



- Press the  button.  
The **Tire Pressure Now OK?** message appears in the multifunction display.
- Press  or  to select **Yes**.
- Press the  button.  
The **Run Flat Indicator Restarted** message appears in the multifunction display.

After a teach-in period, the tire pressure loss warning system will monitor the set tire pressures of all four tires.

**If you wish to cancel the restart:**

- Press the  button.

or

- If the **Tire Pressure Now OK?** message appears, press  or  to select **Cancel**.

- ▶ Press the **OK** button.

The tire pressure values stored at the last restart will continue to be monitored.

## Tire pressure monitor

### Important safety notes

If a tire pressure monitor system is installed, the vehicle's wheels have sensors that monitor the tire pressures in all four tires. The tire pressure monitor warns you when the pressure drops in one or more of the tires. The tire pressure monitor only functions if the correct wheel electronics units are installed on all wheels.

The tire pressure monitor has a yellow warning lamp in the instrument cluster for indicating pressure loss/malfunctions (USA) or pressure loss (Canada). Whether the warning lamp flashes or lights up indicates whether a tire pressure is too low or the tire pressure monitoring system is malfunctioning:

- if the warning lamp is lit continuously, the tire pressure on one or more tires is significantly too low. The tire pressure monitor is not malfunctioning.
- USA only: if the warning lamp flashes for 60 seconds and then remains lit constantly, the tire pressure monitor is malfunctioning.

#### WARNING

Each tire, including the spare (if provided), should be checked at least once a month when cold and inflated to the pressure recommended by the vehicle manufacturer on the Tire and Loading Information placard on the driver's door B-pillar or the tire pressure label on the inside of the fuel filler flap. If your vehicle has tires of a different size than the size indicated on the Tire and Loading Information placard or the tire pressure label, you should determine the proper tire pressure for those tires.

As an added safety feature, your vehicle has been equipped with a tire pressure monitoring system (TPMS) that illuminates a low tire pressure telltale when one or more of your tires are significantly underinflated.

Accordingly, when the low tire pressure telltale illuminates, you should stop and check your tires as soon as possible, and inflate them to the proper pressure. Driving on a significantly underinflated tire causes the tire to overheat and can lead to tire failure. Underinflation also reduces fuel efficiency and tire tread life, and may affect the vehicle's handling and stopping ability.

Please note that the TPMS is not a substitute for proper tire maintenance, and it is the driver's responsibility to maintain correct tire pressure, even if underinflation has not reached the level to trigger illumination of the TPMS low tire pressure telltale.

USA only:

Your vehicle has also been equipped with a TPMS malfunction indicator to indicate when the system is not operating properly. The TPMS malfunction indicator is combined with the low tire pressure telltale. When the system detects a malfunction, the telltale will flash for approximately one minute and then remain continuously illuminated. This sequence will be repeated every time the vehicle is started as long as the malfunction exists.

When the malfunction indicator is illuminated, the system may not be able to detect or signal low tire pressure as intended. TPMS malfunctions may occur for a variety of reasons, including the installation of incompatible replacement or alternate tires or wheels on the vehicle that prevent the TPMS from functioning properly. Always check the TPMS malfunction telltale after replacing one or more tires or wheels on your vehicle to ensure that the replacement or alternate tires and wheels allow the TPMS to continue to function properly.

 USA only:

If the tire pressure monitor is malfunctioning, it may take more than 10 minutes for the tire pressure warning lamp to inform you of the malfunction by flashing for 60 seconds and then remaining lit.

When the malfunction has been rectified, the tire pressure warning lamp goes out after driving for a few minutes.

Information on tire pressures is displayed in the multifunction display. After a few minutes of driving, the current tire pressure of each tire is shown in the multifunction display.

**i** The tire pressure values indicated by the on-board computer may differ from those measured at a gas station with a pressure gauge. The tire pressures shown by the on-board computer refer to those measured at sea level. At high altitudes, the tire pressure values indicated by a pressure gauge are higher than those shown by the on-board computer. In this case, do not reduce the tire pressures.

**i** The operation of the tire pressure monitor can be affected by interference from radio transmitting equipment (e.g. radio headphones, two-way radios) that may be being operated in or near the vehicle.

**i** USA only:

This device complies with Part 15 of the FCC Rules. Operation is subject to the following two conditions:

1. This device may not cause harmful interference, and
2. this device must accept any interference received, including interference that may cause undesired operation.

Any unauthorized modification to this device could void the user's authority to operate the equipment.





**i** Canada only:

This device complies with the RSS-210 of Industry Canada. Operation is subject to the following two conditions:

1. This device may not cause harmful interference, and
2. this device must accept any interference received, including interference that may cause undesired operation.

Any unauthorized modification to this device could void the user's authority to operate the equipment.

### Checking tire pressure electronically

- ▶ Make sure that the SmartKey is in position **2** (▶ page 145) in the ignition lock.
- ▶ Press the  or  button on the steering wheel to select the **Service** menu.
- ▶ Press the  or  button to select **Tire Pressure**.
- ▶ Press the  button.

The current tire pressure for each wheel will be displayed in the multifunction display.

If the vehicle has been parked for longer than 20 minutes, the **Tire pressures will be displayed after driving a few minutes** message appears in the display.

After a teach-in period, the tire pressure monitor automatically recognizes new wheels or new sensors. If a clear allocation of the tire pressure values to the individual wheels is not possible, the **Tire Pressure Monitor Active** message is shown instead of the tire pressure display. The tire pressures are already being monitored.

**i** If a spare wheel/emergency spare wheel is mounted, the system may continue to show the tire pressure of the wheel that has been removed for a few minutes. If this occurs, note that the value displayed for the position where the spare tire is mounted is not the same as the spare wheel/emergency spare wheel's current tire pressure.

## Tire pressure monitor warning messages

If the tire pressure monitor detects a significant pressure loss on one or more tires, a warning message is shown in the multifunction display. A warning tone also sounds and the tire pressure warning lamp lights up in the instrument cluster.

Each tire that is affected by a significant loss of pressure is highlighted with a color.

If the **Correct Tire Pressure** message appears in the multifunction display:

- ▶ Check the tire pressure on all four wheels and correct it if necessary.

**i** If the wheel positions on the vehicle are interchanged, the tire pressures may be displayed for the wrong positions for a short time. This is rectified after a few minutes of driving, and the tire pressures are displayed for the correct positions.

## Restarting the tire pressure monitor

### WARNING

It is the driver's responsibility to set the tire pressure to the recommended cold tire pressure. Underinflated tires affect the ability to steer or brake the vehicle. You might lose control over the vehicle.





When you restart the tire pressure monitor, all existing warning messages are deleted and the warning lamps go out. The monitor uses the currently set tire pressures as the reference values for monitoring.

The tire pressure monitor must be restarted when you set the tire pressure to a new value (as a result of changed drive or load characteristics, for example). The tire pressure monitor then monitors the new tire pressure values.

**i** Canada only: in most cases, the tire pressure monitor recognizes the new reference values automatically. However,

you can also define reference values manually as described here.

Restart the tire pressure monitor after you have set the tire pressure to the value recommended for the desired driving situation (▷ page 349). Only correct tire pressures on cold tires. Comply with the recommended tire pressures on the Tire and Loading Information placard on the B-pillar on the driver's side. Additional tire pressure values for driving at high speeds or with heavy loads can be found in the tire pressure table on the inside of the fuel filler flap.

- ▶ Make sure that the tire pressure is correct on all four wheels.
- ▶ Make sure that the SmartKey is in position **2** in the ignition lock.
- ▶ Press the  or  button on the steering wheel to select the **Serv.** menu.
- ▶ Press the  or  button to select **Tire Pressure**.
- ▶ Press the  button.

The multifunction display shows the current tire pressure of the individual tires or the **Tire pressures will be displayed after driving a few minutes** message.

- ▶ Press the  button. The **Use Current Pressures as New Reference Values** message appears in the multifunction display.

### If you wish to confirm the restart:

- ▶ Press the  button. The **Tire Press. Monitor Restarted** message appears in the multifunction display.

After driving for a few minutes, the system checks whether the current tire pressures are within the specified range. The new tire pressures are then accepted as reference values and monitored.

### If you wish to cancel the restart:

- ▶ Press the  button.

The tire pressure values stored at the last restart will continue to be monitored.

## Loading the vehicle

### Instruction labels for tires and loads

#### WARNING

Do not overload the tires by exceeding the specified load limit as indicated on the Tire and Loading Information placard on the driver's door B-pillar. Overloading the tires can overheat them, possibly causing a blowout. Overloading the tires can also result in handling or steering problems, or brake failure.

Two instruction labels on your vehicle show the maximum possible load.

- (1) The Tire and Loading Information placard on the B-pillar on the driver's side. The Tire and Loading Information placard shows the maximum permissible number of occupants and the maximum permissible vehicle load. It also contains details of the tire sizes and corresponding pressures for tires mounted at the factory.
- (2) The vehicle identification plate is on the B-pillar on the driver's side. The vehicle identification plate informs you of the gross vehicle weight rating. It is made up of the vehicle weight, all vehicle occupants, the fuel and the cargo. You can also find information about the maximum gross axle weight rating on the front and rear axle.  
The maximum gross axle weight rating is the maximum weight that can be carried by one axle (front or rear axle). Never exceed the maximum load or the maximum gross axle weight rating for the front or rear axle.

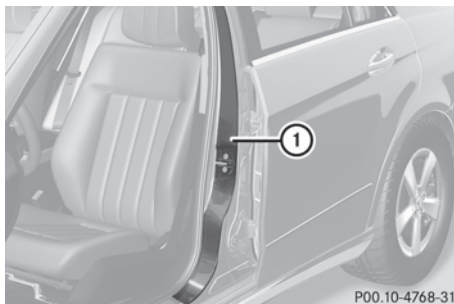

B-pillar (example: Sedan)

- ① B-pillar, driver's side

### Maximum permissible gross vehicle weight rating

-  The specifications shown on the Tire and Loading Information placard in the illustration are examples. The maximum permissible gross vehicle weight rating is vehicle-specific and may differ from that in the illustration. You can find the valid maximum permissible gross vehicle weight rating for your vehicle on the Tire and Loading Information placard.

TIRE RENSEIGNEMENTS		TIRE LOADING INFORMATION		
RENSEIGNEMENTS POUR LES PNEUS		INFORMATION POUR LES PNEUS ET LE CHARGEMENT		
SEATING CAPACITY NOMBRE DE SIÈGES	TOT	FRONT AVANT	MIDDLE MILIEU	REAR ARRIÈRE
The combined weight of occupants and cargo should never exceed XXXX kg or XXXX lbs.* Le poids total des occupants et des marchandises ne doit jamais dépasser XXXX kg ou XXXX lb.*				
TIRE PNEU	SIZE TAILLE	COLD TIRE PRESSURE PRESSION DES PNEUS À FROID		SEE OWNERS MANUAL FOR ADDITIONAL INFORMATIONS
FRONT AVANT	255/40 ZR18 99Y XL	200 kPa, 29 PSI		
REAR ARRIÈRE	285/35 ZR18 101Y XL	200 kPa, 29 PSI		
SPARE DE RECHANGE	175/55-18 98P	420 kPa, 60 PSI		

P40.00-2131-31

- ▶ The Tire and Loading Information placard gives you details on maximum permissible gross vehicle weight rating ①: "The gross weight of occupants and luggage must never exceed XXX kilograms or XXX pounds."

The gross weight of all vehicle occupants, cargo, luggage and trailer load/noseweight (if applicable) must not exceed the specified value.

## Number of seats

**i** The specifications shown on the Tire and Loading Information placard in the illustration are examples. The number of seats is vehicle-specific and can differ from the details shown. The number of seats in your vehicle can be found on the Tire and Loading Information placard.

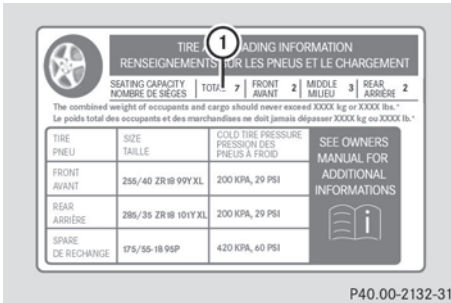

Maximum number of seats **①** determines the maximum number of occupants allowed to travel in the vehicle. This information can be found on the Tire and Loading Information placard.

## Determining the correct load limit

### Step-by-step instructions

The following steps have been developed as required of all manufacturers under Title 49, Code of U.S. Federal Regulations, Part 575 pursuant to the "National Traffic and Motor Vehicle Safety Act of 1966".

- ▶ **Step 1:** Locate the statement "The combined weight of occupants and cargo should never exceed XXX kg or XXX lbs." on your vehicle's Tire and Loading Information placard.
- ▶ **Step 2:** Determine the combined weight of the driver and passengers that will be riding in your vehicle.
- ▶ **Step 3:** Subtract the combined weight of the driver and passengers from XXX kilograms or XXX lbs.

- ▶ **Step 4:** The resulting figure equals the available amount of cargo and luggage load capacity. For example, if the "XXX" amount equals 1400 lbs and there will be five 150 lbs passengers in your vehicle, the amount of available cargo and luggage load capacity is 650 lbs ( $1400 - 750 (5 \times 150) = 650$  lbs).
- ▶ **Step 5:** Determine the combined weight of luggage and cargo being loaded on the vehicle. That weight may not safely exceed the available cargo and luggage load capacity calculated in step 4.
- ▶ **Step 6 (if applicable):** If your vehicle will be towing a trailer, load from your trailer will be transferred to your vehicle. Consult this manual to determine how this reduces the available cargo and luggage load capacity of your vehicle (▶ page 361).



**Example: step 1 to 3**

The following table shows examples on how to calculate total and cargo load capacities with varying seating configurations and number and size of occupants. The following examples use a load limit of 1500 lbs. **This is for illustration purposes only.** Make sure you are using the actual load limit for your vehicle stated on the vehicle's Tire and Loading Information placard (▷ page 359).

		Example 1	Example 2	Example 3
<b>Step 1</b>	<b>Combined maximum weight of occupants and cargo (data from the Tire and Loading Information placard)</b>	1500 lbs (680 kg)	1500 lbs (680 kg)	1500 lbs (680 kg)

		Example 1	Example 2	Example 3
<b>Step 2</b>	<b>Number of people in the vehicle (driver and occupants)</b>	5	3	1
	<b>Distribution of the occupants</b>	Front: 2 Rear: 3	Front: 1 Rear: 2	Front: 1
	<b>Weight of the occupants</b>	Occupant 1: 150 lbs (68 kg) Occupant 2: 180 lbs (82 kg) Occupant 3: 160 lbs (73 kg) Occupant 4: 140 lbs (63 kg) Occupant 5: 120 lbs (54 kg)	Occupant 1: 200 lbs (91 kg) Occupant 2: 190 lbs (86 kg) Occupant 3: 150 lbs (68 kg)	Occupant 1: 150 lbs (68 kg)
	<b>Gross weight of all occupants</b>	750 lbs (340 kg)	540 lbs (245 kg)	150 lbs (68 kg)

		Example 1	Example 2	Example 3
<b>Step 3</b>	<b>Permissible cargo and trailer load/noseweight (maximum gross vehicle weight rating from the Tire and Loading Information placard minus the gross weight of all occupants)</b>	1500 lbs (680 kg) - 750 lbs (340 kg) = 750 lbs (340 kg)	1500 lbs (680 kg) - 540 lbs (245 kg) = 960 lbs (435 kg)	1500 lbs (680 kg) - 150 lbs (68 kg) = 1350 lbs (612 kg)

The higher the weight of all the occupants, the smaller the maximum load for luggage. Further information can be found under "Towing a trailer" (▷ page 361).

### Vehicle identification plate

Even if you have calculated the total load carefully, you should still make sure that the gross vehicle weight rating and the gross axle weight rating are not exceeded. Details can be found on the vehicle identification plate on the B-pillar on the driver's side (▷ page 358).

**Gross vehicle weight:** the gross weight of the vehicle, all passengers, cargo and trailer load/noseweight (if applicable) must not exceed the permissible gross vehicle weight.

**Gross axle weight rating:** the maximum permissible load that can be carried by one axle (front or rear axle).

To ensure that your vehicle does not exceed the maximum permissible values (gross vehicle weight and maximum gross axle weight rating), have your loaded vehicle (including driver, occupants, cargo, and full trailer load if applicable) weighed on a suitable vehicle weighbridge.

### Trailer load/noseweight

The trailer load/noseweight affects the gross weight of the vehicle. If a trailer is attached, the trailer load/noseweight is included in the load along with occupants and luggage. The trailer load/noseweight is usually

approximately 10% of the gross weight of the trailer and its load.

Your Mercedes-Benz has been designed primarily to carry passengers and their luggage. Mercedes-Benz does not recommend towing a trailer with your vehicle.

### Maximum load rating

#### WARNING

Do not overload the tires by exceeding the specified load limit as indicated on the Tire and Loading Information placard on the driver's door B-pillar. Overloading the tires can overheat them, possibly causing a blowout. Overloading the tires can also result in handling or steering problems, or brake failure.



**i** The actual values for tires are specific to each vehicle and may deviate from the values in the illustration.

Maximum tire load **1** is the maximum permitted weight for which the tire is approved.

Further information on tire loads (▷ page 363).

## Uniform Tire Quality Grading Standards

### Overview of Tire Quality Grading Standards

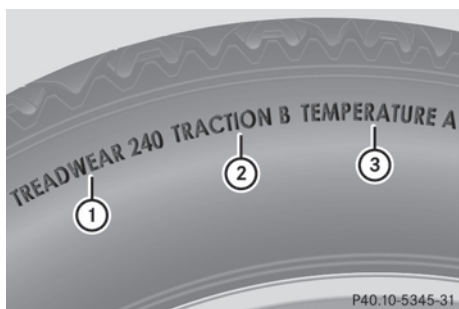

The Uniform Tire Quality Grading is a U.S. Government requirement. Their purpose is to provide drivers with consistent and reliable information regarding tire performance. Tire manufacturers are required to grade tires using three performance factors: tread wear **1**, tire traction **2**, and temperature resistance **3**. Although not a Government of Canada requirement, all tires made for sale in

North America have these grades branded on the sidewall.

**i** The actual values for tires are vehicle-specific and may deviate from the values in the illustration.

Where applicable, the tire grading information can be found on the tire sidewall between the tread shoulder and maximum tire width.

For example:

Tread wear	Traction	Temperature
200	AA	A

All passenger car tires must conform to the statutory safety requirements in addition to these grades.

### Tread wear

The tread wear grade is a comparative rating based on the wear rate of the tire when tested under controlled conditions on a specified U.S. government course. For example, a tire graded 150 would wear one and one-half times as well on the government course as a tire graded 100.

The relative performance of tires depends upon the actual conditions of their use, however, and may depart significantly from the norm, due to variations in driving habits, service practices and differences in road characteristics and climate conditions.

### Traction

#### **⚠ WARNING**

The traction grade assigned to this tire is based on straight-ahead braking traction tests, and does not include acceleration, cornering, hydroplaning, or peak traction characteristics.

The traction grades, from highest to lowest, are AA, A, B, and C. Those grades represent

the tire's ability to stop on a wet surface as measured under controlled conditions on specified government test surfaces of asphalt and concrete. A tire marked C may have poor traction performance.

### WARNING

If ice has formed on the road, tire traction will be substantially reduced. Under such weather conditions, drive, steer and brake with extreme caution.

The safe speed on a wet, snow covered or icy road is always lower than on dry road surfaces.

You should pay special attention to road conditions when temperatures are around the freezing point.

Mercedes-Benz recommends a minimum tire tread depth of  $\frac{1}{16}$  in (4 mm) for all four winter tires (▷ page 174) to maintain normal driving characteristics in winter. Winter tires can reduce the braking distance on snow covered surfaces in comparison to summer tires. Stopping distance, however, is still considerably greater than when the road is not covered with ice or snow. Take appropriate care when driving.

**!** Avoid wheelspin. This can lead to damage to the drive train.

### Temperature

### WARNING

The temperature grade for this tire is established for a tire that is properly inflated and not overloaded. Excessive speed, underinflation, or excessive loading, either separately or in combination, can cause excessive heat build-up and possible tire failure.

The temperature grades are A (the highest), B, and C. These represent the tire's resistance to the generation of heat and its ability to dissipate heat when tested under

controlled conditions on a specified indoor laboratory test wheel. Sustained high temperature can cause the material of the tire to degenerate and reduce tire life, and excessive temperature can lead to sudden tire failure. The grade C corresponds to a level of performance which all passenger car tires must meet under the Federal Motor Vehicle Safety Standard No. 109. Grades B and A represent higher levels of performance on the laboratory test wheel than the minimum required by law.

### Tire labeling

#### Tire labeling overview

The following markings are on the tire in addition to the tire name (sales designation) and the manufacturer's name:

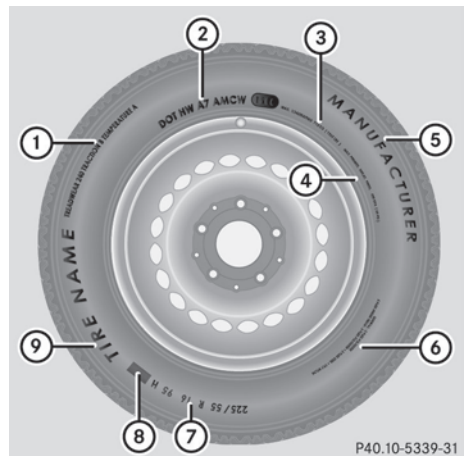

- ① Uniform tire Quality Grading Standard (▷ page 368)
- ② DOT, Tire Identification Number (▷ page 366)
- ③ Maximum tire load (▷ page 361)
- ④ Maximum tire pressure (▷ page 352)
- ⑤ Manufacturer
- ⑥ Tire material (▷ page 367)
- ⑦ Tire size designation, load-bearing capacity and speed rating (▷ page 364)

- ⑧ Load index (> page 366)
- ⑨ Tire name
- ① Tire data is vehicle-specific and may deviate from the data in the example.

### Tire size designation, load-bearing capacity and speed rating

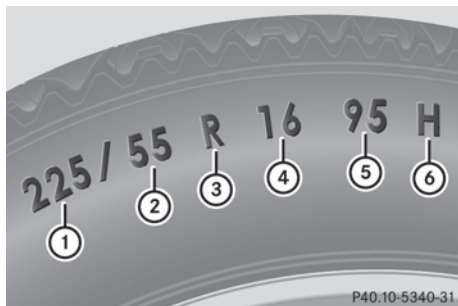

- ① Tire width
- ② Nominal aspect ratio in %
- ③ Tire code
- ④ Rim diameter
- ⑤ Load bearing index
- ⑥ Speed rating

- ① Tire data is vehicle-specific and may deviate from the data in the example.

**General:** depending on the manufacturer's standards, the size imprinted in the tire wall may not contain any letters or may contain one letter that precedes the size description.

If there is no letter preceding the size description (as shown above): these are passenger vehicle tires according to European manufacturing standards.

If "P" precedes the size description: these are passenger vehicle tires according to U.S. manufacturing standards.

If "LT" precedes the size description: these are light truck tires according to U.S. manufacturing standards.

If "T" precedes the size description: these are compact emergency spare wheels at high tire

pressure, to be used only temporarily in an emergency.

**Tire width:** tire width ① shows the nominal tire width in millimeters.

**Nominal aspect ratio:** aspect ratio ② is the size ratio between the tire height and the tire width and is shown in percent. The aspect ratio is calculated by dividing the tire width by the tire height.

**Tire code:** tire code ③ specifies the tire type. "R" represents radial tires. "D" represents diagonal tires, "B" represents diagonal radial tires.

Optionally, tires with a maximum speed of over 149 mph(240 km/h) may have "ZR" in the size description depending on the manufacturer (e.g. 245/40 ZR 18).

**Rim diameter:** rim diameter ④ is the diameter of the bead seat, not the diameter of the rim flange. The rim diameter is specified in inches (in).

**Load bearing index:** load bearing index ⑤ is a numerical code which specifies the maximum load-bearing capacity of a tire.

#### WARNING

The tire load rating must always be at least half of the GAWR of your vehicle. Otherwise, sudden tire failure may be the result which could cause an accident and/or serious injury to you or others.

Always replace rims and tires with rims and tires having the same specifications (designation, manufacturer and type) as shown on the original part.

#### WARNING

Do not overload the tires by exceeding the specified load limit as indicated on the Tire and Loading Information placard on the driver's door B-pillar. Overloading the tires can overheat them, possibly causing a blowout. Overloading the tires can also result in handling or steering problems, or brake failure.

Example:

The load bearing index 91 is equivalent to a maximum load of 1356 lbs (615 kg) that the tire can carry. For further information on the maximum tire load in kilograms and pounds, see (▷ page 361).

For further information on the load bearing index, see Load index (▷ page 366).

**Speed rating:** speed rating (6) specifies the approved maximum speed of the tire.

### WARNING

Even when permitted by law, never operate a vehicle at speeds greater than the maximum speed rating of the tires.

Exceeding the maximum speed for which tires are rated can lead to sudden tire failure, causing loss of vehicle control and possibly resulting in an accident and/or serious personal injury and possible death, for you and for others.

Regardless of the speed rating always observe the speed limits. Drive carefully and adapt your driving style to the traffic conditions.

Summer tires	
Index	Speed rating
Q	Up to 100 mph (160 km/h)
R	Up to 106 mph (170 km/h)
S	Up to 112 mph (180 km/h)
T	Up to 118 mph (190 km/h)
H	Up to 130 mph (210 km/h)
V	Up to 149 mph (240 km/h)
W	Up to 168 mph (270 km/h)
Y	Up to 186 mph (300 km/h)
ZR...Y	Up to 186 mph (300 km/h)

### Summer tires

Index	Speed rating
ZR...(Y)	Above 186 mph (300 km/h)
ZR	Above 149 mph (240 km/h)

- Optionally, tires with a maximum speed of over 149 mph (240 km/h) may have "ZR" in the size description depending on the manufacturer (e.g. 245/40 ZR 18).

The service specifications consist of load bearing index (5) and speed rating (6).

- If the size description of your tire includes "ZR" and there are no service specifications, ask the tire manufacturer in order to find out the maximum speed.

If a service specification is available, the maximum speed is limited according to the speed rating in the service specification.

Example: 245/40 ZR 18 97 Y. In this example, "97 Y" is the service specification. The letter "Y" represents the speed rating and the maximum speed of the tire is limited to 186 mph (300 km/h).

- Every tire that has a maximum speed above 186 mph (300 km/h) must have "ZR" in the size description **and** the service specification must be given in brackets. Example: 275/40 ZR 18 (99 Y). The speed rating "(Y)" shows that the maximum speed of the tire is above 186 mph (300 km/h). Ask the tire manufacturer to find out the maximum speed.

### All-weather tires and winter tires

Index	Speed rating
Q M+S <sup>33</sup>	Up to 100 mph (160 km/h)
T M+S <sup>33</sup>	Up to 118 mph (190 km/h)
H M+S <sup>33</sup>	Up to 130 mph (210 km/h)
V M+S <sup>33</sup>	Up to 149 mph (240 km/h)

<sup>33</sup> Or M+S  for winter tires.

**i** Not all tires that have the M+S identification offer the driving characteristics of winter tires. Winter tires have, in addition to the M+S identification, the  snowflake symbol on the tire sidewall. Tires with this identification fulfill the requirements of the Rubber Manufacturers Association (RMA) and the Rubber Association of Canada (RAC) regarding the tire traction on snow and have been especially developed for driving on snow.

An electronic speed limiter prevents your vehicle from exceeding the following speeds:

- All vehicles (except AMG vehicles): 130 mph (210 km/h)
- AMG vehicles: 155 mph (250 km/h)
- AMG vehicles with Performance Package (Wagon): 174 mph (280 km/h)
- AMG vehicles with Performance Package (Sedan): 186 mph (300 km/h)

The speed rating of tires mounted at the factory may be higher than the maximum speed that the electronic speed limiter permits.

Make sure that your tires have the required speed rating as specified in the "Tires" section (▷ page 371), e.g. if you buy new tires.

Further information about reading tire data can be obtained from any qualified specialist workshop, e.g. an authorized Mercedes-Benz Center.

### Load index



**i** Tire data is vehicle-specific and may deviate from the data in the example.

In addition to the load bearing index, load index **1** may be imprinted after the letters that identify speed index **6** (▷ page 364) on the sidewall of the tire.

- If no specification is given: no text (as in the example above), represents a standard load (SL) tire
- XL or Extra Load: represents a reinforced tire
- Light load: represents a light load tire
- C, D, E: represents a load range that depends on the maximum load that the tire can carry at a certain pressure

### DOT, Tire Identification Number (TIN)

U.S. tire regulations prescribe that every manufacturer of new tires or retreader has to imprint a TIN in or on the sidewall of each tire produced.

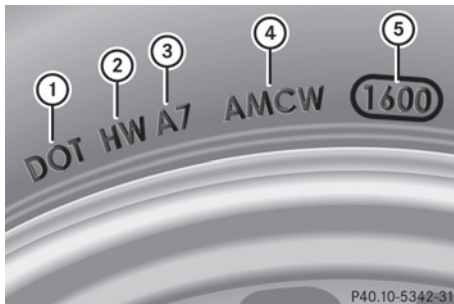



The TIN is a unique identification number. The TIN enables the tire manufacturers to inform purchasers of recalls and other safety-relevant matters. It makes it possible for the purchaser to easily identify the affected tires. The TIN is made up of manufacturer identification code ②, tire size ③, tire type code ④ and manufacturing date ⑤.

- ① Tire data is vehicle-specific and may deviate from the data in the example.

**DOT (Department of Transportation):** tire symbol ① indicates that the tire complies with the requirements of the U.S. Department of Transportation.

**Manufacturer identification code:** manufacturer identification code ② provides details on the tire manufacturer. New tires have a code with two symbols. Retreaded tires have a code with four symbols. Further information about retreaded tires (▷ page 346).

**Tire size:** identifier ③ describes the tire size.

**Tire type code:** tire type code ④ can be used by the manufacturer as a code to describe specific characteristics of the tire.

**Date of manufacture:** date of manufacture ⑤ provides information about the age of a tire. The first and second positions represent the week of manufacture, starting with "01" for the first calendar week. Positions three and four represent the year of manufacture. For example, a tire that is marked with "3208", was manufactured in week 32 in 2008.

### Tire characteristics

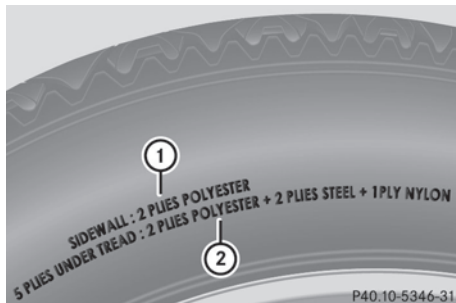

- ① Tire data is vehicle-specific and may deviate from the data in the example.

This information describes the tire cord and the number of layers in sidewall ① and under the tread ②.

### Definition of terms for tires and loading

#### Tire ply composition and material used

Describes the number of plies or the number of layers of rubber-coated fabric in the tire tread and sidewall. These are made of steel, nylon, polyester and other materials.

#### Bar

Metric unit for tire pressure. There are 14.5038 pounds per square inch (psi) to 1 bar; there are 100 kilopascals (kPa) to 1 bar.

#### DOT (Department of Transportation)

DOT marked tires fulfill the requirements of the United States Department of Transportation.

**Normal occupant weight**

The number of occupants the vehicle is designed to seat, multiplied by 68 kilograms (150 lbs).

**Uniform Tire Quality Grading Standards**

A uniform standard to grade the quality of tires with regards to tread quality, tire traction and temperature characteristics. Ratings are determined by tire manufacturers using U.S. government testing procedures. The ratings are molded into the sidewall of the tire.

**Recommended tire pressure**

The recommended tire pressure applies to the tires mounted at the factory. The Tire and Loading Information placard contains the recommended tire pressures for cold tires on a fully loaded vehicle and for the maximum permissible vehicle speed. The tire pressure table contains the recommended tire pressures for cold tires under various operating conditions, i.e. differing load and speed conditions.

**Increased vehicle weight due to optional equipment**

This is the combined weight of all standard and optional equipment available for the vehicle, regardless of whether it is actually installed on the vehicle or not.

**Rim**

This is the part of the wheel on which the tire is mounted.

**GAWR (Gross Axle Weight Rating)**

The GAWR is the maximum permissible axle weight. The actual load on an axle must never exceed the gross axle weight rating. The gross axle weight rating can be found on the vehicle identification plate on the B-pillar on the driver's side.

**Speed rating**

The speed rating is part of the tire identification. It specifies the speed range for which the tire is approved.

**GVW (Gross Vehicle Weight)**

The gross vehicle weight comprises the weight of the vehicle including fuel, tools, the spare wheel, accessories installed, occupants, luggage and the drawbar noseweight, if applicable. The gross vehicle weight must not exceed the gross vehicle weight rating GVWR as specified on the vehicle identification plate on the B pillar on the driver's side.

**GVWR (Gross Vehicle Weight Rating)**

The GVWR is the maximum permissible gross weight of a fully loaded vehicle (the weight of the vehicle including all accessories, occupants, fuel, luggage and the drawbar noseweight, if applicable). The gross vehicle weight rating is specified on the vehicle identification plate on the B-pillar on the driver's side.

**Maximum loaded vehicle weight**

The maximum weight is the sum of the curb weight of the vehicle, the weight of the accessories, the total load limit and the weight of the optional equipment installed at the factory.

**Kilopascal (kPa)**

Metric unit for tire pressure. 6.9 kPa is the equivalent of 1 psi. Another unit for tire pressure is bar. There are 100 kilopascals (kPa) to 1 bar.

**Load index**

In addition to the load bearing index, the load index may also be imprinted on the sidewall of the tire. This specifies the load bearing capacity more precisely.

**Curb weight**

The weight of a vehicle with standard equipment including the maximum capacity of fuel, oil and coolant. It also includes the air-conditioning system and optional equipment if these are installed in the vehicle, but does not include passengers or luggage.

**Maximum load rating**

The maximum load rating in kilograms or pounds is the maximum weight for which a tire is approved.

**Maximum permissible tire pressure**

Maximum permissible tire pressure for one tire.

**Maximum load on one tire**

Maximum load on one tire. This is calculated by dividing the maximum axle load of one axle by two.

**PSI (pounds per square inch)**

A standard unit of measure for tire pressure.

**Aspect ratio**

Relationship between tire height and tire width in percent.

**Tire pressure**

This is pressure inside the tire applying an outward force to each square inch of the tire's surface. The tire pressure is specified in pounds per square inch (psi), in kilopascal (kPa) or in bar. The tire pressure should only be corrected when the tires are cold.

**Tire pressure of cold tires**

The tires are cold:

- if the vehicle has been parked without direct sunlight on the tires for at least three hours and
- if the vehicle has not been driven more than 1 mile (1.6 km).

**Tread**

The part of the tire that comes into contact with the road.

**Bead**

The tire bead ensures that the tire sits securely on the wheel. There are several steel wires in the bead to prevent the tire from coming loose from the wheel rim.

**Sidewall**

The part of the tire between the tread and the bead.

**Weight of optional extras**

The combined weight of those optional extras that weigh more than the replaced standard part and more than 2.3 kilograms (5 lbs).

These optional extras, such as high-performance brakes, level control, a roof rack or a high-performance battery, are not included in the curb weight and accessory weight.

### TIN (Tire Identification Number)

This is a unique identifier which can be used by a tire manufacturer to identify tires, for example for a product recall, and thus identify the purchasers. The TIN is made up of the manufacturer's identity code, tire size, tire type code and the manufacturing date.

### Load bearing index

The load bearing index (also load index) is a code that contains the maximum load bearing capacity of a tire.

### Traction

Traction is the result of friction between the tires and the road surface.

### Treadwear indicators

Narrow bars (tread wear bars) that are distributed over the tire tread. If the tire tread is level with the bars, the wear limit of  $\frac{1}{16}$  in (1.6 mm) has been reached.

### Occupant distribution

The distribution of occupants in a vehicle at their designated seating positions.

### Total load limit

Rated cargo and luggage load plus 68 kilograms (150 lbs) times the vehicle's designated seating capacity.

## Changing a wheel

### Flat tire

The "Breakdown assistance" section ([▷ page 325](#)) contains information and notes on how to deal with a flat tire. It also provides instructions on changing a wheel or mounting the spare wheel/emergency spare wheel.

## Interchanging the wheels

### WARNING

Rotate front and rear wheels only if the tires are of the same dimension.

If your vehicle is equipped with mixed-size tires (different tire dimensions front vs. rear), tire rotation is not possible.

### WARNING

Have the tightening torque checked after changing a wheel. Wheels could become loose if not tightened with a torque of 96 lb-ft (130 Nm).

Only use genuine Mercedes-Benz wheel bolts specified for your vehicle's rims.

The wear patterns on the front and rear tires differ, depending on the operating conditions. Rotate the wheels before a clear wear pattern has formed on the tires. Front tires typically wear more on the shoulders and the rear tires in the center.

If your vehicle's tire configuration allows, you can rotate the wheels according to the intervals in the tire manufacturer's warranty book in your vehicle documents. If this is not available, the tires should then be replaced every 3000 to 6000 miles (5000 to 10,000 km), or earlier if the tire wear requires this. Do not change the direction of wheel rotation.

Clean the contact surfaces of the wheel and the brake disc thoroughly every time a wheel is interchanged. Check the tire pressures.

Information on changing a wheel and mounting the spare wheel ([▷ page 329](#)).

**!** On vehicles equipped with a tire pressure monitor, electronic components are located in the wheel.

Tire-mounting tools should not be used near the valve. This could damage the electronic components.

Always have the tires changed at a qualified specialist workshop, e.g. an authorized Mercedes-Benz Center.

### Direction of rotation

Tires with a specified direction of rotation have additional benefits, e.g. if there is a risk of hydroplaning. You will only gain these benefits if the correct direction of rotation is maintained.

An arrow on the sidewall of the tire indicates its correct direction of rotation.

You may mount a spare wheel/emergency spare wheel against the direction of rotation. Observe the time restriction on use as well as the speed limit specified on the spare wheel/emergency spare wheel.

### Storing wheels

Store wheels that are not being used in a cool, dry and preferably dark place. Protect the tires from oil, grease, gasoline and diesel.

### Cleaning the wheels

#### WARNING

Do not use power washers with circular-jet nozzles (dirt grinders) to clean your vehicle, in particular the tires. You could otherwise damage the tires and cause an accident.

## Wheel and tire combinations

### Please bear the following in mind

**!** For safety reasons, Mercedes-Benz recommends that you only use Tires and

wheels which have been approved by Mercedes-Benz specifically for your vehicle.

These tires have been specially adapted for use with the control systems, such as ABS or ESP®, and are marked as follows:

- MO = Mercedes-Benz Original
- MOE = Mercedes-Benz Original Extended (tires featuring run-flat characteristics)
- MO1 = Mercedes-Benz Original (only certain AMG tires)

Mercedes-Benz Original Extended tires may only be used on wheels that have been specifically approved by Mercedes-Benz.

Only use tires, wheels or accessories tested and approved by Mercedes-Benz. Certain characteristics, e.g. handling, vehicle noise emissions or fuel consumption, may otherwise be adversely affected. In addition, when driving with a load, tire dimension variations could cause the tires to come into contact with the bodywork and axle components. This could result in damage to the tires or the vehicle. Mercedes-Benz accepts no liability for damage resulting from the use of tires, wheels or accessories other than those tested and approved.

Further information about tires, wheels and approved combinations can be obtained from any authorized Mercedes-Benz Center.

**i** The Tire and Load Information placard with the recommended tire pressures is attached to the B-pillar on the driver's side. Further information about driving at high speeds or driving with vehicle loads that are lighter than the maximum vehicle load can be found in the tire pressure table on the inside of the fuel filler flap. Check tire pressures regularly, and only when the tires are cold. Comply with the maintenance recommendations of the tire manufacturer in the vehicle document wallet.

For further information on the recommended tire inflation pressure and on tire pressures for specific driving conditions, see (▷ page 349).

- i** Notes on the vehicle equipment – always equip the vehicle:
  - with tires of the same size on a given axle (left/right)
  - with the same type of tires at a given time (summer tires, winter tires, MOExtended tires)
- i** Vehicles equipped with MOExtended tires are not equipped with a TIREFIT kit at the factory. It is therefore recommended that you additionally equip your vehicle with a TIREFIT kit if you mount tires that do not feature run-flat properties, e.g. winter tires. A TIREFIT kit can be obtained from an authorized Mercedes-Benz Center.

- i** On the following pages, you can find information on approved wheel rims and tire sizes for equipping your vehicle with winter tires. Winter tires are not available ex factory as standard equipment or optional extras.

If you want to equip your vehicle with approved winter tires, it may be necessary to obtain wheel rims in the corresponding size, as the size of the approved winter tires may differ from the standard tires. This is dependent on the model and the equipment installed at the factory.

The tires and wheel rims, as well as further information, can be obtained at a qualified specialist workshop, e.g. at an authorized Mercedes-Benz Center.

- i** Overview of abbreviations used in the following tire tables:
  - BA: both axles
  - FA: front axle
  - RA: rear axle

In the following table, the wheel/tire combinations are allocated to the vehicle models through variants, e.g. V1, V2 etc.:

Sedan	
V1	E 350 BlueTEC
V2	E 350 <sup>34</sup>
V3	E 350 4MATIC <sup>34</sup>
V4	E 550 4MATIC <sup>34</sup>
V5	E 63 AMG

Wagon	
V1	E 350 4MATIC <sup>34</sup>
V2	E 63 AMG

- i** Not all wheel and tire combinations are available from the factory for all countries.

## Tires

## Sedan

	Summer tires	Alloy wheels	V1	V2	V3	V4	V5
BA	245/40 R18 97 Y XL <sup>35</sup>	8.5 J x 18 H2 Offset: 1.89 in (48 mm)	•	•	•	•	—
FA	245/40 R18 97 Y XL	8.5 J x 18 H2 Offset: 1.89 in (48 mm)	—	•	—	—	—
RA	265/35 R18 97 Y XL <sup>36</sup>	9.0 J x 18 H2 Offset: 2.13 in (54 mm)	—	—	—	—	—
FA	255/40 ZR 18 (99 Y) XL MO1 <sup>37</sup>	9.0 J x 18 H2 Wheel offset: 1.46 in (37 mm)	—	—	—	—	•
RA	285/35 ZR18 (101 Y) XL MO1 <sup>36, 37</sup>	9.5 J x 18 H2 Wheel offset: 2.05 in (52 mm)	—	—	—	—	•
FA	255/35 ZR 19 (96 Y) XL	9.0 J x 19 H2 Wheel offset: 1.46 in (37 mm)	—	—	—	—	•
RA	285/30 ZR 19 (98 Y) XL <sup>36</sup>	9.5 J x 19 H2 Wheel offset: 2.05 in (52 mm)	—	—	—	—	•

	All-weather tires	Alloy wheels	V1	V2	V3	V4	V5
BA	245/45 R17 99 H XL M+S	8.0 J x 17 H2 Offset: 1.89 in (48 mm)	•	•	•	—	—
BA	245/45 R17 95 H M+S MOExtended <sup>38</sup>	8.0 J x 17 H2 Offset: 1.89 in (48 mm)	•	•	•	—	—
BA	245/45 R17 99 H XL M+S	8.5 J x 17 H2 Offset: 1.89 in (48 mm)	•	•	•	—	—
BA	245/45 R17 95 H M+S MOExtended <sup>38</sup>	8.5 J x 17 H2 Offset: 1.89 in (48 mm)	•	•	•	—	—

<sup>35</sup> E 350 BlueTEC: Canada only.











<sup>36</sup> Use of snow chains not permitted. Observe the notes in the "Snow chains" section.

<sup>37</sup> Not in combination with a ceramic brake system.

<sup>38</sup> MOExtended tires (tires with run-flat characteristics) only in combination with an activated tire pressure loss warning system or tire pressure monitor.



	All-weather tires	Alloy wheels	V1	V2	V3	V4	V5
BA	245/40 R18 97 V XL M+S <sup>35</sup>	8.5 J x 18 H2 Offset: 1.89 in (48 mm)	•	•	•	•	—
FA	245/40 R18 97 V XL M+S	8.5 J x 18 H2 Offset: 1.89 in (48 mm)	—	•	—	—	—
RA	265/40 R18 97 V XL M+S <sup>36</sup>	9.0 J x 18 H2 Offset: 2.13 in (54 mm)	—	—	—	—	—

	Winter tires	Alloy wheels	V1	V2	V3	V4	V5
BA	245/45 R17 99 H XL M+S 	8.0 J x 17 H2 Offset: 1.89 in (48 mm)	•	•	•	—	—
BA	245/45 R17 99 H XL M+S  MOExtended <sup>38</sup>	8.0 J x 17 H2 Offset: 1.89 in (48 mm)	•	•	•	—	—
BA	245/45 R17 99 H XL M+S 	8.5 J x 17 H2 Offset: 1.89 in (48 mm)	•	•	•	—	—
BA	245/45 R17 99 H XL M+S  MOExtended <sup>38</sup>	8.5 J x 17 H2 Offset: 1.89 in (48 mm)	•	•	•	—	—
BA	245/40 R18 97 H XL M+S  <sup>35</sup>	8.5 J x 18 H2 Offset: 1.89 in (48 mm)	•	•	•	•	—
FA	255/40 R18 99 V XL M+S  <sup>37</sup>	9.0 J x 18 H2 Wheel offset: 1.46 in (37 mm)	—	—	—	—	•
RA	255/40 R18 99 V XL M+S  <sup>37, 39</sup>	9.5 J x 18 H2 Wheel offset: 2.05 in (52 mm)	—	—	—	—	•
FA	255/35 R19 96 V XL M+S 	9.0 J x 19 H2 Wheel offset: 1.46 in (37 mm)	—	—	—	—	•
RA	255/35 R19 96 V XL M+S  <sup>39</sup>	9.5 J x 19 H2 Wheel offset: 2.05 in (52 mm)	—	—	—	—	•
FA	255/35 R19 96 V XL M+S 	9.0 J x 19 H2 Wheel offset: 1.46 in (37 mm)	—	—	—	—	•
RA	285/30 R19 98 V XL M+S  <sup>36</sup>	9.5 J x 19 H2 Wheel offset: 2.05 in (52 mm)	—	—	—	—	•

<sup>35</sup> E 350 BlueTEC: Canada only.

<sup>36</sup> Use of snow chains not permitted. Observe the notes in the "Snow chains" section.

<sup>38</sup> MOExtended tires (tires with run-flat characteristics) only in combination with an activated tire pressure loss warning system or tire pressure monitor.

<sup>37</sup> Not in combination with a ceramic brake system.

<sup>39</sup> Snow chain usage: please contact an authorized Mercedes-Benz Center.

<b>"Minispare" emergency spare wheel<sup>36</sup></b>						
<b>Tires</b>	<b>Wheels</b>	<b>V1</b>	<b>V2</b>	<b>V3</b>	<b>V4</b>	<b>V5</b>
T 155/70 R17 110 M Tire pressure: 420 kPa (4.2 bar/ 61 psi)	4.0 B x 17 H2 Wheel offset: 1.54 in (39 mm)	–	•	•	–	–
T 155/60 R18 107 M Tire pressure: 420 kPa (4.2 bar/ 61 psi)	4.5 B x 18 H2 Wheel offset: 1.42 in (36 mm)	–	–	–	•	–

<b>Collapsible spare wheel<sup>36</sup></b>						
<b>Tires</b>	<b>Wheels</b>	<b>V1</b>	<b>V2</b>	<b>V3</b>	<b>V4</b>	<b>V5</b>
T 175/50 - 19 97 P Tire pressure: 350 kPa (3.5 bar/ 51 psi)	6.5 B x 19 H2 Wheel offset: 0.55 in (14 mm)	–	–	–	–	•

**i** The specified tire pressure is printed in yellow on the emergency/collapsible spare wheel.

## Wagon

	<b>Summer tires</b>	<b>Alloy wheels</b>	<b>V1</b>	<b>V2</b>
FA	255/40 ZR18 (99 Y) XL MO1 <sup>37</sup>	9.0 J x 18 H2 Wheel offset: 1.46 in (37 mm)	–	•
RA	285/35 ZR18 (101 Y) XL MO1 <sup>36, 37</sup>	9.5 J x 18 H2 Wheel offset: 2.05 in (52 mm)	–	–
FA	255/35 ZR 19 (96 Y) XL	9.0 J x 19 H2 Wheel offset: 1.46 in (37 mm)	–	•
RA	285/30 ZR 19 (98 Y) XL <sup>36</sup>	9.5 J x 19 H2 Wheel offset: 2.05 in (52 mm)	–	–

	<b>All-weather tires</b>	<b>Alloy wheels</b>	<b>V1</b>	<b>V2</b>
BA	245/45 R17 99 H XL M+S	8.0 J x 17 H2 Offset: 1.89 in (48 mm)	•	–
BA	245/45 R17 99 H XL M+S	8.5 J x 17 H2 Offset: 1.89 in (48 mm)	•	–

<sup>36</sup> Use of snow chains not permitted. Observe the notes in the "Snow chains" section.

<sup>37</sup> Not in combination with a ceramic brake system.

	Winter tires	Alloy wheels	V1	V2
BA	245/45 R17 99 H XL M+S 	8.0 J x 17 H2 Offset: 1.89 in (48 mm)	•	—
BA	245/45 R17 99 H XL M+S  MOExtended <sup>38</sup>	8.0 J x 17 H2 Offset: 1.89 in (48 mm)	•	—
BA	245/45 R17 99 H XL M+S 	8.5 J x 17 H2 Offset: 1.89 in (48 mm)	•	—
BA	245/45 R17 99 H XL M+S  MOExtended <sup>38</sup>	8.5 J x 17 H2 Offset: 1.89 in (48 mm)	•	—
FA	255/40 R18 99 V XL M+S  <sup>37</sup>	9.0 J x 18 H2 Wheel offset: 1.46 in (37 mm)	—	•
RA	255/40 R18 99 V XL M+S  <sup>37, 39</sup>	9.5 J x 18 H2 Wheel offset: 2.05 in (52 mm)	—	•
FA	255/35 R19 96 V XL M+S  <sup>40</sup>	9.0 J x 19 H2 Wheel offset: 1.46 in (37 mm)	—	•
RA	255/35 R19 96 V XL M+S  <sup>39, 40</sup>	9.5 J x 19 H2 Wheel offset: 2.05 in (52 mm)	—	•
FA	255/35 R19 96 V XL M+S 	9.0 J x 19 H2 Wheel offset: 1.46 in (37 mm)	—	•
RA	285/30 R19 98 V XL M+S  <sup>36</sup>	9.5 J x 19 H2 Wheel offset: 2.05 in (52 mm)	—	•

**"Minispare" emergency spare wheel<sup>36</sup>**

Tires	Wheels	V1	V2
T 155/70 R17 110 M Tire pressure: 420 kPa (4.2 bar/61 psi)	4.0 B x 17 H2 Wheel offset: 1.54 in (39 mm)	•	—

**Collapsible spare wheel<sup>36</sup>**

Tires	Wheels	V1	V2
T 175/50 - 19 97 P Tire pressure: 350 kPa (3.5 bar/51 psi)	6.5 B x 19 H2 Wheel offset: 0.55 in (14 mm)	—	•

<sup>38</sup> MOExtended tires (tires with run-flat characteristics) only in combination with an activated tire pressure loss warning system or tire pressure monitor.

<sup>37</sup> Not in combination with a ceramic brake system.

<sup>39</sup> Snow chain usage: please contact an authorized Mercedes-Benz Center.

<sup>40</sup> Permissible top speed 137 mph(220 km/h).

<sup>36</sup> Use of snow chains not permitted. Observe the notes in the "Snow chains" section.

- i** The specified tire pressure is printed in yellow on the emergency/collapsible spare wheel.



Useful information .....	380
Notes on technical data .....	380
Genuine Mercedes-Benz parts .....	380
Warranty .....	381
Identification plates .....	381
Service products and capacities .....	382
Vehicle data .....	390

### Useful information

- i** This Operator's Manual describes all models and all standard and optional equipment of your vehicle available at the time of publication of the Operator's Manual. Country-specific differences are possible. Please note that your vehicle may not be equipped with all features described. This also applies to safety-related systems and functions.
- i** Please read the information on qualified specialist workshops (▷ page 25).

### Notes on technical data

- i** The data stated here specifically refers to a vehicle with standard equipment. Consult an authorized Mercedes-Benz Center for the data for all vehicle variants and trim levels.

### Genuine Mercedes-Benz parts

All Mercedes-Benz Centers maintain a supply of genuine Mercedes-Benz parts for necessary service and repair work. In addition, strategically located parts delivery centers provide for quick and reliable parts service.

There are more than 300,000 different genuine Mercedes-Benz parts available for Mercedes-Benz models.

Genuine Mercedes-Benz parts are subject to strict quality control. Each part has been specially developed, manufactured or selected for Mercedes-Benz vehicles and fine-tuned for them.

Therefore, only genuine Mercedes-Benz parts should be used.

### WARNING

Driving safety may be impaired if non-approved parts, tires and wheels or safety-relevant accessories are used.

This could lead to malfunctions in safety-relevant systems, e.g. the brake system. This could cause you to lose control of your vehicle and cause an accident.

For this reason, Mercedes-Benz recommends that you use genuine Mercedes-Benz parts or parts of equal quality. Only use tires, wheels and accessories that have been specifically approved for your vehicle.

**!** Air bags and Emergency Tensioning Devices, as well as control units and sensors for these restraint systems may be installed in the following areas of your vehicle:

- doors
- door pillars
- door sills
- seats
- dashboard
- instrument cluster
- center console

Do not install accessories such as audio systems in these areas. Do not carry out repairs or welding. You could impair the operating efficiency of the restraint systems.

Have aftermarket accessories installed at a qualified specialist workshop. Mercedes-Benz recommends that you use an authorized Mercedes-Benz Center for this purpose.

### Environmental note

Daimler AG also supplies reconditioned major assemblies and parts which are of the same quality as new parts. They are covered by the same Limited Warranty entitlements as new parts.

Always specify the vehicle identification number (VIN) (▷ page 381) and the engine



number (▷ page 382) when ordering genuine Mercedes-Benz parts.

### Warranty

The Service and Warranty Information booklet contains detailed information about the warranties covering your vehicle.

Your authorized Mercedes-Benz Center will exchange or repair any defective parts originally installed in the vehicle in accordance with the terms of the following warranties:

- New Vehicle Limited Warranty
- Emission System Warranty
- Emission Performance Warranty
- California, Connecticut, Maine, Massachusetts, New York, Pennsylvania, Rhode Island and Vermont Emission Control Systems Warranty
- State Warranty Enforcement Laws (Lemon Laws)

Replacement parts and accessories are covered by the Mercedes-Benz Parts and Accessories warranties. You can obtain information about this from any authorized Mercedes-Benz Center.

- 1 Should you lose your Service and Warranty Information booklet, have an authorized Mercedes-Benz Center arrange for a replacement. It will be mailed to you.

### Identification plates

#### Vehicle identification plate with vehicle identification number (VIN) and paint code number

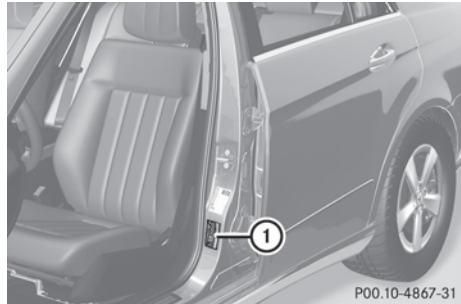

- ▶ Open the driver's door. You will see vehicle identification plate ①.

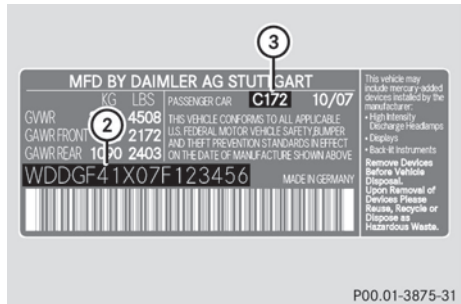

Example: vehicle identification plate (USA only)

- ② VIN
- ③ Paint code

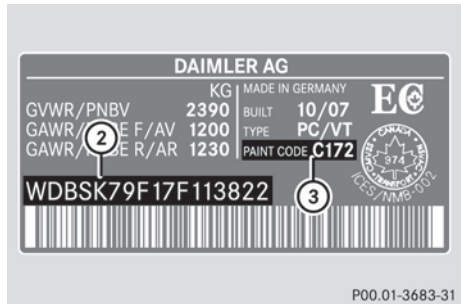

Example: vehicle identification plate (Canada only)

- ② VIN
- ③ Paint code

**i** The data shown on the identification plate is example data. This data is different for every vehicle and can deviate from the data shown here. You can find the data applicable to your vehicle on the vehicle's identification plate.

### Vehicle identification number (VIN)

The vehicle identification number (VIN) can be found in the following locations:

- on the vehicle identification plate (▷ page 381)
- on the lower edge of the windshield (▷ page 382)

In addition to being stamped on the vehicle identification plate, the vehicle identification number (VIN) is also stamped onto the vehicle body.

It is located on the floor in front of the right-hand front seat.

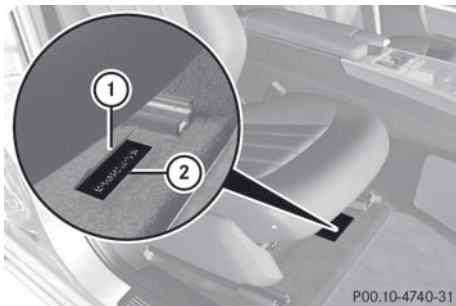

- ▶ Slide the right-hand front seat to its rearmost position.
- ▶ Fold floor covering ① upwards. You will see vehicle identification number (VIN) ②.

### Engine number

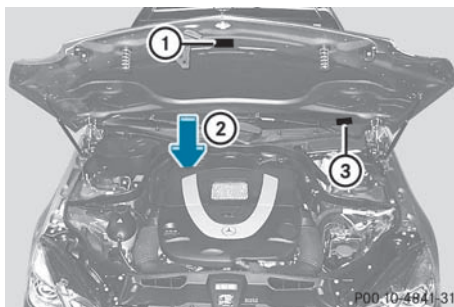

- ① Emission control information plate, including the certification of both federal and Californian emissions standards
- ② Engine number (stamped into the crankcase)
- ③ VIN (on the lower edge of the windshield)

## Service products and capacities

### Important safety notes

Service products include the following:

- fuels (e.g. gasoline, diesel)
- additives for exhaust gas aftertreatment (DEF)
- lubricants (e.g. engine oil, transmission oil)
- coolant
- brake fluid
- windshield washer fluid

Vehicle components and their respective lubricants must match. You should therefore only use products that have been tested and approved by Mercedes-Benz.

Information on tested and approved products can be obtained at a Mercedes-Benz Center or on the Internet at <http://www.mbusa.com> (USA only).

### WARNING

Comply with all valid regulations with respect to handling, storing and disposing of service fluids. Otherwise, you could endanger persons or the environment.

Keep service fluids out of the reach of children.

For health reasons, you should prevent service fluids from coming into direct contact with your skin or clothing.

If a service fluid is swallowed, contact a physician immediately.

Capacities			
	Model	Capacity	Fuel, coolant, lubricants, etc.
<b>Engine oil and filter</b>	E 350 <sup>41, 42</sup> E 350 4MATIC <sup>41</sup>	6.9 US qt (6.5 l)	Approved engine oils
	E 350 BlueTEC E 550 4MATIC <sup>41</sup>	8.5 US qt (8.0 l)	
	E 63 AMG <sup>43</sup>	9.0 US qt (8.5 l)	
<b>Cooling system</b>	E 350 <sup>41, 42</sup> E 350 4MATIC <sup>41</sup>	Approximately 10.1 US qt (9.6 l)	MB 325.0 or MB 326.0 anticorrosion/antifreeze
	E 350 BlueTEC	Approximately 13.0 US qt (12.3 l)	
	E 550 4MATIC <sup>41</sup>	Approximately 13.4 US qt (12.7 l)	
	E 63 AMG	Approximately 13.6 US qt (12.9 l)	
<b>Tank capacity</b>	All models except AMG vehicles	21.1 US gal (80.0 l)	Gasoline engines: premium-grade unleaded gasoline (at least 91 octane, average value between 96 RON/86 MON)
	E 63 AMG	17.4 US gal (66.0 l)	
<b>Reserve</b>	All models except AMG vehicles	Approximately 2.4 US gal (9.0 l)	Diesel engines: ULTRA-LOW SULFUR HIGHWAY DIESEL FUEL (ULSD, maximum sulfur content 15 ppm)
	E 63 AMG	Approximately 3.7 US gal (14.0 l)	
<b>DEF tank</b>	E 350 BlueTEC	6.5 US gal (24.5 l)	DEF in accordance with ISO 22241

<sup>41</sup> BlueEFFICIENCY

<sup>42</sup> USA only.

<sup>43</sup> Including external oil cooler.

	Model	Capacity	Fuel, coolant, lubricants, etc.
Windshield/ headlamp cleaning system	All models except Wagon E 350 4MATIC <sup>41</sup>	3.7 US qt (3.5 l)	MB windshield washer concentrate <sup>44</sup> (▷ page 389)
	Wagon E 350 4MATIC <sup>41</sup>	6.3 US qt (6.0 l)	Mixing ratio for washer fluid (▷ page 389)

## Fuel

### Important safety notes

#### WARNING

Gasoline and diesel fuels are highly flammable and poisonous. They burn violently and can cause serious injury.

Never allow sparks, flames or smoking materials near gasoline or diesel fuel!

Turn off the engine before refueling.

Whenever you are around gasoline or diesel fuel, avoid inhaling fumes and any skin or clothing contact. Extinguish all smoking materials.

Direct skin contact with fuels and the inhalation of fuel vapors are damaging your health.

### Premium-grade unleaded gasoline

**!** To ensure the longevity and full performance of the engine, only premium-grade unleaded gasoline may be used.

If there is no premium-grade unleaded gasoline available and regular-grade unleaded gasoline may be used; please observe the following precautions:

- only fill the fuel tank to half full with regular-grade unleaded gasoline and fill

the rest with premium-grade unleaded gasoline as soon as possible.

- do not drive at the maximum speed.
- avoid sudden acceleration.
- if the vehicle is carrying a light load, e.g. two passengers without luggage, do not allow the engine to rev above 3,000 rpm.
- if the vehicle is fully loaded or is being operated in mountainous terrain, do not depress the accelerator pedal further than  $\frac{2}{3}$  of the pedal travel.

### Fuel requirements

#### Gasoline engines

Use only premium-grade unleaded gasoline. The octane number should be at least 91.

Details can be found on the gas pump. The octane number is the average value of the Research Octane Number (RON) and the Motor Octane Number (MON):  $(RON + MON) / 2$ , also known as knock resistance.

Reformulated Gasoline (RFG) and/or unleaded gasoline with additives can be used if the concentration of the additives in the fuel does not exceed 10%, e.g.:

- Ethanol
- TAME
- ETBE

<sup>41</sup> BlueEFFICIENCY

<sup>44</sup> Mixed with water or premixed washer fluid with antifreeze protection.

- IPA
- TBA

For MTBE, the concentration should not exceed 15%.

The concentration of methanol in gasoline including other additives must not exceed 3%.

Using mixtures of methanol and ethanol is not permitted. Gasohol, a mixture of 10% ethanol and 90% unleaded gasoline, can be used.

All of these mix fuels must fulfill the fuel requirements, e.g.:

- knock resistance
- boiling point
- vapor pressure

### Diesel engines – important safety notes

**!** Only use commercially available ULTRA-LOW SULFUR DIESEL FUEL (ULSD, 15 ppm MAXIMUM SULFUR) that meets the ASTM D975 standard. Failure to use ULTRA-LOW SULFUR DIESEL FUEL (ULSD) can severely damage the vehicle's exhaust gas aftertreatment system.

**!** Do not fill the tank with gasoline. Do not blend diesel fuel with gasoline or kerosene. Otherwise, the fuel system and the engine could be damaged.

To prevent malfunctions, diesel fuel with improved flow characteristics is available in the winter months. Check with your gas station.

Information on the fuel grade can usually be found on the gas pump. If the information cannot be found on the gas pump, ask the gas station personnel. For further information, consult an authorized Mercedes-Benz Center or go to the Internet site <http://www.mbusa.com> (USA only).

### Diesel engines – fuels containing biodiesel (FAME [fatty acid methyl ester])

Mercedes-Benz USA approves the use of B5 (ULSD with a maximum of up to five percent by volume biodiesel) for all diesel engines

with common rail direct injection (CDI) and BlueTEC.

Pure biodiesel and diesel fuels that have a higher percentage of biodiesel, e.g. B20, can damage the fuel system and the engine and are therefore not approved.

For further information, please ask the gas station personnel. The label on the gas pump must indicate clearly that the B5 biodiesel blend fulfills the ULSD standard. If the label is not clear, do not refuel the vehicle.

Do not refuel your vehicle with fuels unless they have been approved by Mercedes-Benz.

### Additives in gasoline

One of the main problems of poor fuel quality is the forming of deposits that are caused during the gasoline combustion process. Mercedes-Benz recommends that you use fuel brands that have the additives.

If you use fuels without these additives for an extended period of time, there may be a buildup of carbon deposits, especially on the inlet valves and in the combustion chamber.

This could lead to engine problems, e.g.:

- longer engine warm-up phase
- uneven idle
- engine noise
- misfiring
- loss of power

Carbon deposits may form if the availability of gasoline with relevant additives is insufficient (in certain regions). In this case, Mercedes-Benz recommends the use of additives that have been approved for Mercedes-Benz vehicles.

Consult an authorized Mercedes-Benz Center or go to the Internet site <http://www.mbusa.com> (USA only) for a list of approved products. Observe the instructions for use on the product label.

Do not mix other fuel additives with fuel. This causes unnecessary costs and could damage the engine.

- ❗ Do not refuel with low-grade fuel and do not use fuel additives that are not tested and approved for Mercedes-Benz vehicles. Damage to or malfunctions of the fuel system may otherwise occur.

## DEF

### Important safety notes

- ℹ For BlueTEC vehicles only.

DEF is a non-flammable, non-toxic, colorless, odorless and water-soluble fluid.

- ❗ Rinse surfaces that have come into contact with DEF immediately with water or remove DEF using a damp cloth and cold water. If the DEF has already crystallized, use a sponge and cold water to clean it. DEF residues crystallize after time and contaminate the affected surfaces.

### High outside temperatures

If DEF heats up to over 122 °F (50 °C) for extended periods, e.g. as a result of direct sunlight on the DEF reservoir, DEF can decompose. Ammonia vapors develop as a result.

#### WARNING

When opening the filler cap of the DEF tank ammonia gas vapors may escape. Refill DEF in a well ventilated area only. Ammonia gas vapors have a pungent odor and are particularly irritating for your skin, mucous membranes, and eyes. Inhaling ammonia gas vapors will cause burning eyes, nose, and throat, as well as coughing and watering eyes.

### Low outside temperatures

DEF freezes at a temperature of approximately 12 °F (-11 °C). The vehicle is equipped with a DEF preheating system when it leaves the factory. Winter operation is therefore also guaranteed at temperatures below 12 °F (-11 °C).

### Additives

- ❗ Only use DEF in accordance with ISO 22241. Do not use additives with DEF and do not dilute DEF with water. This may destroy the BlueTEC exhaust gas aftertreatment system.

### Purity

Assuring the purity of DEF is particularly important with respect to avoiding malfunctions in the exhaust gas aftertreatment system.

If DEF is pumped out of the DEF tank, e.g. during repair work, it must not be returned to the tank. The purity of the fluid can no longer be guaranteed.

- ❗ Impurities in DEF (e.g. due to other service products, cleaning agents or dust) lead to:
  - increased emission values
  - damage to the catalytic converter
  - engine damage
  - malfunctions in the BlueTEC exhaust gas aftertreatment system

## Engine oil

### Please bear the following in mind

The engine oils are matched to the performance of Mercedes-Benz engines and service intervals. You should therefore only use engine oils and oil filters that are approved for vehicles with maintenance systems.

For a list of approved engine oils and oil filters, consult an authorized Mercedes-Benz Center or go to the Internet site <http://www.mbusa.com> (USA only).

- ❗ Never use engine oil or an oil filter of a specification other than is necessary to fulfill the prescribed service intervals. Do not change the engine oil or oil filter in order to achieve longer replacement



intervals than those prescribed. You could otherwise cause engine damage or damage to the exhaust gas aftertreatment.

Follow the instructions in the service interval display regarding the oil change.

Otherwise, you may damage the engine and the exhaust gas aftertreatment.

The table shows which engine oils have been approved for your vehicle.

Model	Engine model	MB Approval
<b>E 350</b> <sup>45, 46</sup>	276	229.5
<b>E 350 4MATIC</b> <sup>45</sup>		
<b>E 350 BlueTEC</b>	642	228.51, 229.31, 229.51
<b>E 550 4MATIC</b> <sup>45</sup>	278	229.5
<b>E 63 AMG</b>	157	229.5 <sup>47</sup>

- MB approval is indicated on the oil containers.

### Additives

- Do not use any additives in the engine oil. This could damage the engine.

### Engine oil viscosity

Viscosity describes the flow characteristics of a fluid. If an engine oil has a high viscosity, this means that it is thick; a low viscosity means that it is thin.

Select an engine oil with an SAE (viscosity) classification suitable for the prevailing outside temperatures. The following table shows the correct SAE classification to be used. The low-temperature characteristics of engine oils can deteriorate significantly, e.g. as a result of aging, soot and fuel deposits. It is therefore strongly recommended that you

carry out regular oil changes using an approved engine oil with the appropriate SAE classification.

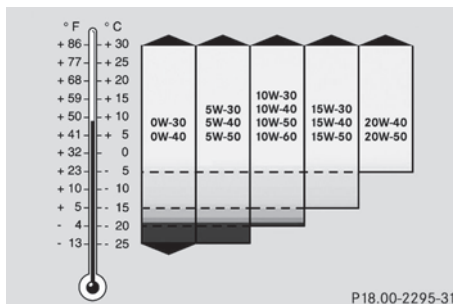

### Refrigerant of the air-conditioning system

The air-conditioning system is filled with R134a refrigerant and a special PAG lubricant.

- Never use refrigerant R 12 (CFC) or mineral lubricants. Otherwise, you could damage the air-conditioning system.

### Brake fluid

#### ⚠ WARNING

Over a period of time, the brake fluid absorbs moisture from the air; this lowers its boiling point.

If the boiling point of the brake fluid is too low, vapor pockets may form in the brake system when the brakes are applied hard (e.g. when driving downhill). This would impair braking efficiency.

You should have the brake fluid renewed at regular intervals. The brake fluid change intervals can be found in the Service Booklet.

Only use brake fluid approved by Mercedes-Benz. Information about approved brake

<sup>45</sup> BlueEFFICIENCY

<sup>46</sup> USA only.

<sup>47</sup> Restriction: only SAE 0W-40 or SAE 5W-40 engine oils may be used.

fluids can be obtained from any authorized Mercedes-Benz Center or on the Internet at <http://bevo.mercedes-benz.com>.

## Coolant

### Important safety notes

The coolant is a mixture of water and antifreeze/corrosion inhibitor. It performs the following tasks:

- corrosion protection
- antifreeze protection
- raising the boiling point

The engine cooling system is filled at the factory with coolant that contains an antifreeze/corrosion inhibitor that ensures protection down to approximately  $-35^{\circ}\text{F}$  ( $-37^{\circ}\text{C}$ ).

**!** Only add coolant that has been premixed with the desired antifreeze protection. Otherwise, the engine could be damaged. Further information on coolants and on filling can be found in the Mercedes-Benz Specifications for Service Products, MB Approval 310.1, e.g. on the Internet at <http://bevo.mercedes-benz.com>. You can also consult an authorized Mercedes-Benz Center.

**!** Always use a suitable coolant mixture, even in countries where high temperatures prevail. Otherwise, the engine cooling system is not sufficiently protected from corrosion and overheating.

If the coolant has antifreeze protection down to  $-35^{\circ}\text{F}$  ( $-37^{\circ}\text{C}$ ), the boiling point of the coolant under operating conditions is approximately  $266^{\circ}\text{F}$  ( $130^{\circ}\text{C}$ ).

Your vehicle has a range of aluminum components. Aluminum components in the engine make it necessary to use antifreeze/corrosion inhibitor coolant that has been specifically formulated to protect the aluminum parts. Using other antifreeze/

corrosion inhibitors without these characteristics affects the service life.

The coolant must be used throughout the year in order to maintain the necessary corrosion protection and to provide protection from overheating. In the Service Booklet, you can find information on the intervals for renewal.

The renewal interval is determined by the coolant type and the engine cooling system design. The renewal interval in the Service Booklet is only valid if the coolant is renewed or filled up with Mercedes-Benz approved products. Therefore, only use MB 325.0 or 326.0 anticorrosion/antifreeze or another Mercedes-Benz approved product of the same specification.

Information on other products with the same specifications that are approved by Mercedes-Benz can be obtained at an authorized Mercedes-Benz Center or on the Internet at <http://bevo.mercedes-benz.com>. The coolant is checked at every maintenance interval at an authorized Mercedes-Benz Center.

The antifreeze/corrosion inhibitor concentration in the engine cooling system should:

- be at least 50%. This will protect the engine cooling system against freezing down to approximately  $-35^{\circ}\text{F}$  ( $-37^{\circ}\text{C}$ ).
- not exceed 55% (antifreeze protection to  $-49^{\circ}\text{F}$  [ $-45^{\circ}\text{C}$ ]); otherwise, heat will not dissipate as effectively.

If the coolant level is too low, MB 325.0 or 326.0 anticorrosion/antifreeze should be added. Have the engine cooling system checked for possible leaks.

### Windshield/headlamp cleaning system

#### WARNING

Washer solvent/antifreeze is highly flammable. Do not spill washer solvent/antifreeze on hot engine parts, because it may

ignite and burn. You could be seriously burned.

Use MB SummerFit windshield washer concentrate at temperatures above freezing:

- ▶ Mix 1 part MB SummerFit with 100 parts water.

Use MB WinterFit windshield washer concentrate at temperatures below freezing:

- ▶ At temperatures down to 14 °F(- 10 °C): mix 1 part MB WinterFit with 2 parts water.
- ▶ At temperatures down to - 4 °F(- 20 °C): mix 1 part MB WinterFit with 1 part water.
- ▶ At temperatures down to - 20.2 °F(- 29 °C): mix 2 parts MB WinterFit with 1 part water.

**!** Only SummerFit and WinterFit can be mixed. Otherwise, the jets could become blocked.

## Vehicle data

For the specified vehicle data, please note that:

- The heights specified may vary due to:
  - tires
  - load
  - condition of the suspension
  - optional equipment

Missing values were not available at time of going to print.

All models	
<b>Vehicle length</b>	191.8 in (4872 mm)
<b>Vehicle width including exterior mirrors</b>	81.5 in (2071 mm)
<b>Vehicle height</b>	58.0 in (1474 mm)
<b>Wheelbase</b>	113.1 in (2874 mm)
<b>Front track</b>	62.1 in (1578 mm)

All models	
<b>Rear track</b>	62.8 in (1594 mm)
<b>Turning circle</b>	36.9 ft (11.25 m)
<b>Maximum roof load</b>	
<b>Maximum trunk load</b>	

E 350 4MATIC BlueEFFICIENCY	
<b>Vehicle length, Sedan</b>	191.8 in (4872 mm)
<b>Vehicle height, Sedan</b>	58.0 in (1474 mm)
<b>Front track, Sedan</b>	62.1 in (1578 mm)
<b>Rear track, Sedan</b>	62.8 in (1594 mm)
<b>Vehicle length, Wagon</b>	192.9 in (4899 mm)
<b>Vehicle height, Wagon</b>	59.7 in (1517 mm)
<b>Front track, Wagon</b>	62.1 in (1578 mm)
<b>Rear track, Wagon</b>	63.0 in (1599 mm)

E 63 AMG	
<b>Vehicle length, Sedan</b>	192.6 in (4891 mm)
<b>Vehicle height, Sedan</b>	56.8 in (1442 mm)
<b>Vehicle length, Wagon</b>	193.6 in (4918 mm)
<b>Vehicle height, Wagon</b>	59.1 in (1501 mm)
<b>Front track</b>	64.0 in (1625 mm)
<b>Track width, rear</b>	62.8 in (1594 mm)

<b>E 350 BlueTEC</b>	
<b>Vehicle height, Sedan<sup>48</sup></b>	58.0 in (1474 mm)
<b>Maximum roof load</b>	Maximum 220 lb (100 kg)
<b>Maximum trunk load</b>	Maximum 220 lb (100 kg)

<sup>48</sup> On vehicles with the AIRMATIC package, values vary depending on the level set for the vehicle suspension.



## **Publication details**

### **Internet**

Further information about Mercedes-Benz vehicles and about Daimler AG can be found on the following websites:

<http://www.mbusa.com> (USA only)

<http://www.mercedes-benz.ca> (Canada only)

### **Editorial office**

Not to be reprinted, translated or otherwise reproduced, in whole or in part, without the written permission of Daimler AG.



2125846181

Order no. 6515 3501 13 Part no. 212 584 61 81 Edition A 2012