





## Your Operator's Manual

-  **Digital form inside the vehicle**  
Familiarize yourself with the contents of the Operator's Manual directly via your vehicle's multimedia system (Menu item "Vehicle").
-  **Booklet inside the vehicle**  
In addition to the vehicle's Operator's Manual, you can obtain the complete multimedia system Supplement from your authorized Mercedes-Benz Center.
-  **Digital form via the Internet**  
You can find the Operator's Manual on the Mercedes-Benz homepage.
-  **Digital form as an App**  
The Mercedes-Benz Guides App is available for free on the Apple® App store or Google Play.

Apple® iOS



Android™



# GLC

Operator's Manual



2535846704

Order no. P253 0614 13 Part no. 253 584 67 04 Edition C 2018

GLC Operator's Manual

Mercedes-Benz



## Symbols

Registered trademarks:

- Bluetooth® is a registered trademark of Bluetooth SIG Inc.
- DTS™ is a registered trademark of DTS, Inc.
- Dolby® and MLP™ are registered trademarks of DOLBY Laboratories.
- BabySmart™, ESP® and PRE-SAFE® are registered trademarks of Daimler AG.
- HomeLink® is a registered trademark of Johnson Controls.
- iPod® and iTunes® are registered trademarks of Apple Inc.
- Burmester® is a registered trademark of Burmester Audiosysteme GmbH.
- Microsoft® and Windows media® are registered trademarks of Microsoft Corporation.
- SIRIUS® is a registered trademark of Sirius XM Radio Inc.
- HD Radio™ is a registered trademark of iBiquity Digital Corporation.
- Gracenote® is a registered trademark of Gracenote, Inc.
- ZAGAT Survey® and related brands are registered trademarks of Zagat Survey, LLC.

In this Operator's Manual you will find the following symbols:

### **WARNING**

Warning notes make you aware of dangers which could pose a threat to your health or life, or to the health and life of others.

### **Environmental note**

Environmental notes provide you with information on environmentally aware actions or disposal.

 Notes on material damage alert you to dangers that could lead to damage to your vehicle.

 Practical tips or further information that could be helpful to you.

- ▶ This symbol indicates an instruction that must be followed.
- ▶ Several of these symbols in succession indicate an

instruction with several steps.

(▷ This symbol tells you where you can find more information about a topic.

▷▷ This symbol indicates a warning or an instruction that is continued on the next page.

**Display** This text indicates a message on the multifunction display/multimedia display.

## Publication details

### Internet

Further information about Mercedes-Benz vehicles and about Daimler AG can be found on the following websites:

<http://www.mbusa.com> (USA only)

<http://www.mercedes-benz.ca> (Canada only)

### Editorial office

©Daimler AG: not to be reprinted, translated or otherwise reproduced, in whole or in part, without written permission from Daimler AG.

### Vehicle manufacturer

Daimler AG  
Mercedesstraße 137  
70327 Stuttgart  
Germany

## Welcome to the world of Mercedes-Benz

We urge you to read this Operator's Manual carefully and familiarize yourself with the vehicle before driving. For your own safety and a longer vehicle life, follow the instructions and warning notices in this Operator's Manual. Ignoring them could result in damage to the vehicle or personal injury to you or others.

Vehicle damage caused by failure to follow instructions is not covered by the Mercedes-Benz Limited Warranty.

The equipment or product designation of your vehicle may vary depending on:

- Model
- Order
- Country specification
- Availability

Mercedes-Benz therefore reserves the right to introduce changes in the following areas:

- Design
- Equipment
- Technical features

The equipment in your vehicle may therefore differ from that shown in the descriptions and illustrations.

The following are integral components of the vehicle:

- Digital Operator's Manual
- Printed Operator's Manual
- Maintenance Booklet
- Equipment-dependent supplements

Keep these documents in the vehicle at all times. If you sell the vehicle, always pass all documents on to the new owner.



Apple® iOS



Android™

Please note that the Mercedes-Benz Guides app may not yet be available in your country.

Mercedes-Benz USA, LLC

Mercedes-Benz Canada, Inc.

A Daimler Company

<b>Index</b> .....	<b>4</b>	Mirrors .....	107
<b>Digital Operator's Manual</b> .....	<b>27</b>	Memory function .....	110
Introduction .....	27	<b>Lights and windshield wipers</b> .....	<b>112</b>
Operation .....	27	Exterior lighting .....	112
<b>Introduction</b> .....	<b>28</b>	Interior lighting .....	116
Protecting the environment .....	28	Replacing bulbs .....	116
Genuine Mercedes-Benz parts .....	28	Windshield wipers .....	120
Operator's Manual .....	29	<b>Climate control</b> .....	<b>124</b>
Service and vehicle operation .....	29	Overview of climate control systems ...	124
Operating safety .....	31	Operating the climate control systems .....	127
QR code for rescue card .....	33	Air vents .....	133
Data stored in the vehicle .....	33	<b>Driving and parking</b> .....	<b>135</b>
Information on copyright .....	35	Notes on breaking-in a new vehicle .....	135
<b>At a glance</b> .....	<b>36</b>	Driving .....	135
Cockpit .....	36	DYNAMIC SELECT switch .....	144
Instrument cluster .....	37	Automatic transmission .....	146
Multifunction steering wheel .....	38	Refueling .....	155
Center console .....	39	Parking .....	158
Overhead control panel .....	42	Driving tips .....	160
Door control panel .....	43	Driving systems .....	169
<b>Safety</b> .....	<b>44</b>	Towing a trailer .....	214
Panic alarm .....	44	<b>On-board computer and displays</b> .....	<b>220</b>
Occupant safety .....	44	Important safety notes .....	220
Children in the vehicle .....	60	Displays and operation .....	220
Pets in the vehicle .....	65	Menus and submenus .....	224
Driving safety systems .....	66	Display messages .....	239
Protection against theft .....	76	Warning and indicator lamps in the instrument cluster .....	268
<b>Opening and closing</b> .....	<b>78</b>	<b>Multimedia system</b> .....	<b>280</b>
SmartKey .....	78	General notes .....	280
Doors .....	84	Important safety notes .....	280
Cargo compartment .....	85	Function restrictions .....	280
Side windows .....	91	Operating system .....	281
Panorama roof with power tilt/sliding panel .....	94	<b>Stowage and features</b> .....	<b>290</b>
<b>Seats, steering wheel and mirrors</b> ....	<b>99</b>	Stowage areas .....	290
Correct driver's seat position .....	99	Features .....	302
Seats .....	99		
Steering wheel .....	105		

---

<b>Maintenance and care</b> .....	<b>318</b>
Engine compartment .....	318
ASSYST PLUS .....	322
Care .....	324

---

<b>Breakdown assistance</b> .....	<b>332</b>
Where will I find...? .....	332
Flat tire .....	334
Battery (vehicle) .....	338
Jump-starting .....	341
Towing and tow-starting .....	343
Fuses .....	347

---

<b>Wheels and tires</b> .....	<b>349</b>
Important safety notes .....	349
Operation .....	349
Winter operation .....	351
Tire pressure .....	352
Loading the vehicle .....	359
All about wheels and tires .....	362
Changing a wheel .....	369
Wheel/tire combination .....	373

---

<b>Technical data</b> .....	<b>375</b>
Information regarding technical data ...	375
Vehicle electronics .....	375
Identification plates .....	376
Service products and filling capacities .....	377
Vehicle data .....	382
Vehicle data for off-road driving .....	383
Trailer tow hitch .....	384

## 1, 2, 3 ...

**4ETS (Electronic Traction System)**

see ETS/4ETS (Electronic Traction System)

**4MATIC (permanent four-wheel**

**drive)** ..... 187

**12 V socket**

see Socket (12 V)

**115 V socket** ..... 305

**360° camera**

Cleaning ..... 328

Display in the multimedia system .. 201

Function/notes ..... 199

**A****ABS (Anti-lock Braking System)**

Display message ..... 240

Function/notes ..... 66

Warning lamp ..... 271

**Accident**

Automatic measures after an accident ..... 59

**Accident warning**

see Driving safety system

**Activating media mode**

General notes ..... 288

**Activating/deactivating cooling**

**with air dehumidification** ..... 128

**Active Blind Spot Assist**

Activating/deactivating (on-board computer) ..... 232

Display message ..... 258

Function/notes ..... 209

**Active Brake Assist**

Activating or deactivating ..... 232

Display message ..... 245

Function/notes ..... 67

**Active Brake Assist with cross-traffic function**

Activating or deactivating ..... 232

Display message ..... 246

Function/notes ..... 73

Important safety notes ..... 74

Warning lamp ..... 277

**Active Lane Keeping Assist**

Activating/deactivating (on-board computer) ..... 233

Display message ..... 257

Function/information ..... 212

**Active light function**

Display message ..... 251

**ADAPTIVE BRAKE** ..... 73

**Adaptive Brake Assist**

Function/notes ..... 68

**Adaptive Damping System**

Function/notes ..... 186

**Adaptive Damping System with continuous damping adjustment (ADS PLUS)**

..... 184

**Adaptive Highbeam Assist**

Display message ..... 252

Function/notes ..... 114

Switching on/off ..... 115

**Additional speedometer** ..... 235

**Additives (engine oil)** ..... 380

**Address book**

see also Digital Operator's Manual ..... 280

**Adjusting the volume**

Multimedia system ..... 281

**Air bags**

Deployment ..... 56

Display message ..... 249

Front air bag (driver, front passenger) ..... 50

Important safety notes ..... 49

Introduction ..... 49

Knee bag ..... 51

Occupant Classification System (OCS) ..... 52

PASSENGER AIR BAG indicator lamps ..... 45

Side impact air bag ..... 51

Window curtain air bag ..... 51

**AIR BODY CONTROL**

Display message ..... 256

Function/notes ..... 184

Lowering the rear of the vehicle .... 186

Raising the rear of the vehicle ..... 186

Setting the normal vehicle level .... 186

Setting the raised vehicle level ..... 185

- Air suspension**
  - see AIR BODY CONTROL
- Air vents**
  - Important safety notes ..... 133
  - Rear ..... 134
  - Setting ..... 133
  - Setting the center air vents ..... 134
  - Setting the side air vents ..... 134
- Air-conditioning system**
  - see Climate control
- Airbag**
  - Warning lamp ..... 274
- Alarm**
  - ATA (Anti-Theft Alarm system) ..... 77
  - Switching off (ATA) ..... 77
  - Switching the function on/off (ATA) ..... 77
- Alarm system**
  - see ATA (Anti-Theft Alarm system)
- All-wheel drive**
  - see 4MATIC (permanent four-wheel drive)
- AMG**
  - Switchable performance exhaust system ..... 142
- AMG menu (on-board computer) ..... 235**
- Anti-lock braking system**
  - see ABS (Anti-lock Braking System)
- Anti-Theft Alarm system**
  - see ATA (Anti-Theft Alarm system)
- AppCode**
  - see QR code
- Approach/departure angle ..... 168**
- Armrest**
  - Stowage compartment ..... 291
- Ashtray ..... 304**
- Assistance display (on-board computer) ..... 231**
- Assistance menu (on-board computer) ..... 232**
- ASSYST PLUS**
  - Displaying a service message ..... 323
  - Driving abroad ..... 323
  - Hiding a service message ..... 323
  - Resetting the service interval display ..... 323
  - Service message ..... 322
  - Special service requirements ..... 323
- ATA (Anti-Theft Alarm system)**
  - Activating/deactivating ..... 77
  - Function ..... 77
  - Switching off the alarm ..... 77
- ATTENTION ASSIST**
  - Activating/deactivating ..... 233
  - Display message ..... 256
  - Displaying level ..... 204
  - Function/notes ..... 203
- Authorized Mercedes-Benz Center**
  - see Qualified specialist workshop
- Authorized workshop**
  - see Qualified specialist workshop
- AUTO lights**
  - Display message ..... 251
  - see Lights
- Automatic car wash (care) ..... 324**
- Automatic engine start (ECO start/stop function) ..... 141**
- Automatic engine switch-off (ECO start/stop function) ..... 141**
- Automatic headlamp mode ..... 112**
- Automatic transmission**
  - Accelerator pedal position ..... 149
  - Changing gear ..... 149
  - DIRECT SELECT lever ..... 146
  - Display message ..... 264
  - Double-clutch function ..... 149
  - Drive program ..... 150
  - Drive program display ..... 148
  - Driving tips ..... 149
  - DYNAMIC SELECT switch ..... 144
  - Emergency running mode ..... 155
  - Engaging drive position ..... 147
  - Engaging neutral ..... 147
  - Engaging park position automatically ..... 147
  - Engaging reverse gear ..... 147
  - Engaging the park position ..... 146
  - Gearshift recommendation ..... 154
  - Gliding mode ..... 149
  - Kickdown ..... 149
  - Manual shifting ..... 152
  - Oil temperature (on-board computer, Mercedes-AMG vehicles) ..... 235
  - Overview ..... 146
  - Permanent setting ..... 152

- Problem (malfunction) ..... 155  
 Pulling away ..... 139  
 Starting the engine ..... 138  
 Steering wheel paddle shifters ..... 152  
 Trailer towing ..... 150  
 Transmission position display  
 (DIRECT SELECT lever) ..... 148  
 Transmission positions ..... 148
- Automatic transmission emergency mode** ..... 155  
**Axle load, permissible (trailer towing)** ..... 384
- B**
- Back button** ..... 281  
**Backup lamp**  
 Display message ..... 251  
 Replacing bulbs ..... 119  
**Bag hook** ..... 296  
**Ball coupling**  
 Installing ..... 216  
 Removing ..... 218  
**BAS (Brake Assist System)** ..... 67  
**Battery (SmartKey)**  
 Checking ..... 81  
 Important safety notes ..... 81  
 Replacing ..... 81  
**Battery (vehicle)**  
 Charging ..... 340  
 Display message ..... 253  
 Important safety notes ..... 338  
 Jump starting ..... 341  
**Belt warning** ..... 49  
**Blind Spot Assist**  
 Activating/deactivating (on-board computer) ..... 232  
 Display message ..... 258  
 Notes/function ..... 205  
 see Active Blind Spot Assist  
**Blower**  
 see Climate control  
**Bluetooth®**  
 Searching for a mobile phone ..... 288  
 see also Digital Operator's Manual ..... 280
- Brake**  
 Active Brake Assist with cross-traffic function ..... 73  
**Brake Assist**  
 see BAS (Brake Assist System)  
**Brake assistance**  
 see BAS (Brake Assist System)  
**Brake fluid**  
 Display message ..... 245  
 Notes ..... 380  
**Brake force distribution**  
 see EBD (electronic brake force distribution)  
**Brake linings**  
 Display message ..... 245  
**Brakes**  
 ABS ..... 66  
 Adaptive Brake Assist ..... 68  
 BAS ..... 67  
 Brake fluid (notes) ..... 380  
 Display message ..... 240  
 EBD ..... 73  
 Hill start assist ..... 140  
 HOLD function ..... 178  
 Important safety notes ..... 163  
 Maintenance ..... 164  
 Parking brake ..... 159  
 Riding tips ..... 163  
 Warning lamp ..... 270  
**Breakdown assistance**  
 Where will I find...? ..... 332  
 see Flat tire  
 see Towing away  
**Brightness control (instrument cluster lighting)** ..... 36  
**Buttons on the steering wheel** ..... 221
- C**
- California**  
 Important notice for retail customers and lessees ..... 29  
**Calling up a malfunction**  
 see Display messages  
**Calling up the climate control bar**  
 Multimedia system ..... 284



- Calling up the climate control menu**
- Multimedia system ..... 284
- Camera**
- see 360° camera
- see Rear view camera
- Car**
- see Vehicle
- Car wash**
- see Care
- Care**
- 360° camera ..... 328
- Car wash ..... 324
- Carpets ..... 331
- Display ..... 329
- Exhaust pipe ..... 328
- Exterior lights ..... 327
- General notes ..... 324
- Interior ..... 329
- Matte finish ..... 326
- Paint ..... 326
- Plastic trim ..... 329
- Power washer ..... 325
- Rear view camera ..... 328
- Roof lining ..... 331
- Seat belt ..... 330
- Seat cover ..... 330
- Selector lever ..... 329
- Sensors ..... 328
- Side running board ..... 328
- Steering wheel ..... 329
- Trim pieces ..... 330
- Washing by hand ..... 325
- Wheels ..... 326
- Windows ..... 327
- Wiper blades ..... 327
- Wooden trim ..... 330
- Cargo compartment**
- Opening/closing (from outside, HANDS-FREE ACCESS) ..... 88
- Plug-in module (telescopic rods) ... 299
- Cargo compartment cover**
- Important safety notes ..... 296
- Notes/how to use ..... 296
- Cargo compartment enlargement** ... 293
- Cargo compartment floor**
- Important safety notes ..... 300
- Opening/closing ..... 300
- Stowage well (under) ..... 300
- Cargo compartment plug-in module (telescope bars)** ..... 299
- Cargo net**
- Attaching ..... 297
- Important safety information ..... 297
- Cargo tie down rings** ..... 295
- CD**
- see also Digital Operator's Manual ..... 280
- CD player (on-board computer)** ..... 229
- Center console**
- Lower section (Mercedes-AMG vehicles) ..... 41
- Upper section ..... 39
- Central locking**
- Locking/unlocking (SmartKey) ..... 78
- Change of address** ..... 30
- Change of ownership** ..... 30
- Changing the media source** ..... 228
- Charge-air pressure (on-board computer, Mercedes-AMG vehicles)** ..... 235
- Child**
- Restraint system ..... 61
- Child seat**
- Forward-facing restraint system ..... 64
- LATCH-type (ISOFIX) child seat anchors ..... 62
- On the front-passenger seat ..... 63
- Rearward-facing restraint system .... 64
- Top Tether ..... 62
- Child-proof locks**
- Important safety notes ..... 64
- Rear doors ..... 65
- Children**
- Special seat belt retractor ..... 60
- Children in the vehicle**
- Important safety notes ..... 60
- Cigarette lighter** ..... 304
- Cleaning**
- Mirror turn signal ..... 327
- Trailer tow hitch ..... 329
- Climate control**
- Control panel for 3-zone automatic climate control ..... 125

- Control panel for dual-zone automatic climate control ..... 124
- Controlling automatically ..... 128
- Cooling with air dehumidification .. 128
- Cooling with air dehumidification (multimedia system) ..... 285
- Defrosting the windows ..... 130
- Defrosting the windshield ..... 130
- ECO start/stop function ..... 127
- General notes ..... 124
- Indicator lamp ..... 128
- Ionization ..... 133
- Ionization (multimedia system) ..... 285
- Notes on using the automatic climate control ..... 126
- Overview ..... 284
- Overview of systems ..... 124
- Perfume atomizer ..... 132
- Perfume atomizer (multimedia system) ..... 285
- Pre-entry climate control (via key) (multimedia system) ..... 285
- Pre-entry climate control at departure time (multimedia system) ..... 285
- Problem with the rear window defroster ..... 131
- Problems with cooling with air dehumidification ..... 128
- Rear control panel ..... 125
- Refrigerant ..... 381
- Refrigerant filling capacity ..... 382
- Setting the air distribution ..... 129
- Setting the air vents ..... 133
- Setting the airflow ..... 129
- Setting the climate mode ..... 128
- Setting the climate mode (multimedia system) ..... 285
- Setting the temperature ..... 128
- Switching air-recirculation mode on/off ..... 131
- Switching on/off ..... 127
- Switching residual heat on/off ..... 131
- Switching the rear window defroster on/off ..... 130
- Switching the synchronization function on and off ..... 130
- Synchronization function (multimedia system) ..... 285
- Climate control settings**
  - Multimedia system ..... 284
- Climate control system**
  - Climate control ..... 127
- Coat hooks** ..... 299
- Cockpit**
  - Overview ..... 36
- Code for Apps**
  - see QR code
- COMAND display**
  - Cleaning ..... 329
- Combination switch** ..... 113
- Connecting a USB device**
  - see also Digital Operator's Manual ..... 280
- Consumption statistics (on-board computer)** ..... 225
- Controller** ..... 281
- Controlling the speed**
  - see Distance Pilot DISTRONIC
- Convenience closing feature** ..... 92
- Convenience opening feature** ..... 92
- Coolant (engine)**
  - Checking the level ..... 322
  - Display message ..... 252
  - Filling capacity ..... 381
  - Important safety notes ..... 380
  - Temperature display in the instrument cluster ..... 221
  - Warning lamp ..... 275
- Cooling**
  - see Climate control
- Copyright** ..... 35
- Cornering light function**
  - Display message ..... 251
  - Function/notes ..... 114
- Crosswind Assist** ..... 73
- Cruise control**
  - Cruise control lever ..... 169
  - Deactivating ..... 170
  - Display message ..... 261
  - Driving system ..... 169
  - Function/notes ..... 169
  - General notes ..... 169
  - Important safety notes ..... 169

- Setting a speed ..... 170
  - Storing and maintaining current speed ..... 169
  - Storing the current speed or calling up the last stored speed ..... 170
  - Cup holder**
    - Center console ..... 302
    - Important safety notes ..... 302
    - Rear compartment ..... 302
  - Customer Assistance Center (CAC)** ..... 32
  - Customer Relations Department** ..... 32
- D**
- Data**
    - see Technical data
  - Data carrier**
    - Selecting ..... 229
  - Daytime running lamps**
    - Display message ..... 251
    - Function/notes ..... 112
    - Switching on/off (on-board computer) ..... 234
  - Diagnostics connection** ..... 32
  - Digital Operator's Manual**
    - Help ..... 27
    - Introduction ..... 27
  - Digital speedometer** ..... 225
  - DIRECT SELECT lever**
    - Automatic transmission ..... 146
  - Display**
    - see Display messages
    - see Warning and indicator lamps
  - Display messages**
    - ASSYST PLUS ..... 322
    - Calling up (on-board computer) ..... 239
    - Driving systems ..... 256
    - Engine ..... 252
    - General notes ..... 239
    - Hiding (on-board computer) ..... 239
    - Introduction ..... 239
    - Lights ..... 251
    - Safety systems ..... 240
    - SmartKey ..... 267
    - Tires ..... 262
    - Vehicle ..... 264
  - Distance Pilot DISTRONIC**
    - Activating ..... 172
    - Activation conditions ..... 172
    - Cruise control lever ..... 172
    - Display Message ..... 259
    - Displays in the instrument cluster .. 175
    - Driving tips ..... 176
    - Driving with Distance Pilot DISTRONIC ..... 173
    - Function/notes ..... 170
    - Important safety notes ..... 171
    - Setting a speed ..... 174
    - Setting the specified minimum distance ..... 174
    - Stopping ..... 174
    - Switching off ..... 176
    - with Steering Pilot ..... 177
  - Distance recorder** ..... 224
  - Distance warning (warning lamp) ...** 277
  - Distance warning function**
    - Function/notes ..... 68
  - Distance warning system**
    - see Active Brake Assist
  - Doors**
    - Automatic locking (switch) ..... 85
    - Central locking/unlocking (SmartKey) ..... 78
    - Control panel ..... 43
    - Display message ..... 266
    - Emergency locking ..... 85
    - Emergency unlocking ..... 85
    - Important safety notes ..... 84
    - Opening (from inside) ..... 84
  - Drinking and driving** ..... 161
  - Drive program**
    - Automatic transmission ..... 150
    - SETUP (on-board computer, Mercedes-AMG vehicles) ..... 236
  - Drive programs**
    - Display (DIRECT SELECT lever) ..... 148
    - DYNAMIC SELECT switch ..... 144
  - Drive system**
    - DSR ..... 180
  - Driver's door**
    - see Doors
  - Driving abroad**
    - Mercedes-Benz Service ..... 323
  - Driving Assistance PLUS package ...** 209

<b>Driving downhill</b> .....	168	Lane Tracking package .....	205
<b>Driving in mountainous terrain</b>		Rear view camera .....	194
Approach/departure angle .....	168	Traffic Sign Assist .....	205
<b>Driving off-road</b>		<b>Driving tips</b>	
Driving downhill .....	168	Automatic transmission .....	149
see Off-road driving		Brakes .....	163
<b>Driving on flooded roads</b> .....	165	Break-in period .....	135
<b>Driving safety system</b>		Distance Pilot DISTRONIC .....	176
Active Brake Assist .....	67	Downhill gradient .....	163
Crosswind Assist .....	73	Drinking and driving .....	161
<b>Driving safety systems</b>		Driving in winter .....	165
ABS (Anti-lock Braking System) .....	66	Driving on flooded roads .....	165
Active Brake Assist with cross-		Driving on sand .....	167
traffic function .....	73	Driving on wet roads .....	164
ADAPTIVE BRAKE .....	73	Exhaust check .....	161
Adaptive Brake Assist .....	68	Fuel .....	161
BAS (Brake Assist System) .....	67	General .....	160
Distance warning function .....	67	Hydroplaning .....	164
EBD (electronic brake force distri-		Icy road surfaces .....	165
bution) .....	73	Important safety notes .....	135
ESP® (Electronic Stability Pro-		Limited braking efficiency on sal-	
gram) .....	69	ted roads .....	163
Important safety information .....	66	Off-road driving .....	165
Overview .....	66	Snow chains .....	351
STEER CONTROL .....	76	Subjecting brakes to a load .....	163
<b>Driving system</b>		The first 1000 miles (1500 km) ....	135
AIR BODY CONTROL .....	184	Tire ruts .....	167
AMG sports suspension based on		Towing a trailer .....	215
AIR BODY CONTROL .....	186	Traveling uphill .....	168
Distance Pilot DISTRONIC .....	170	Wet road surface .....	163
Distance Pilot DISTRONIC with		<b>DSR (Downhill Speed Regulation)</b>	
Steering Pilot .....	177	Display message .....	259
Off-road program .....	181	Function/notes .....	180
Parking assist PARKTRONIC .....	191	<b>DVD video</b>	
Parking Pilot .....	188	Operating (on-board computer) ....	229
RACE START (Mercedes-AMG		see also Digital Operator's Man-	
vehicles) .....	183	ual .....	280
<b>Driving systems</b>		<b>DYNAMIC SELECT switch</b>	
360° camera .....	199	Automatic transmission .....	144
Active Blind Spot Assist .....	209	Climate control (dual-zone auto-	
Active Lane Keeping Assist .....	212	matic climate control) .....	127
ATTENTION ASSIST .....	203		
Blind Spot Assist .....	205		
Cruise control .....	169		
Display message .....	256		
Driving Assistance Plus package ...	209		
HOLD function .....	178		
Lane Keeping Assist .....	207		
		<b>E</b>	
		<b>EASY-ENTRY feature</b>	
		Function/notes .....	106
		<b>EASY-EXIT feature</b>	
		Function/notes .....	106

- EBD (electronic brake force distribution)**
  - Display message ..... 242
  - Function/notes ..... 73
- ECO display**
  - Function/notes ..... 161
  - On-board computer ..... 225
- ECO start/stop function**
  - Automatic engine start ..... 141
  - Automatic engine switch-off ..... 141
  - Deactivating/activating ..... 142
  - General information ..... 141
  - Important safety notes ..... 140
  - Introduction ..... 140
- Electronic brake force distribution**
  - see EBD (electronic brake force distribution)
- Electronic Stability Program**
  - see ESP® (Electronic Stability Program)
- Electronic Traction System**
  - see ETS/4ETS (Electronic Traction System)
- Emergency**
  - Automatic measures after an accident ..... 59
- Emergency braking**
  - see BAS (Brake Assist System)
- Emergency release**
  - Driver's door ..... 85
  - Vehicle ..... 85
- Emergency Tensioning Devices**
  - Activation ..... 56
- Emergency unlocking**
  - Tailgate ..... 90
- Emissions control**
  - Service and warranty information .... 29
- Engine**
  - Check Engine warning lamp ..... 274
  - Display message ..... 252
  - ECO start/stop function ..... 140
  - Engine number ..... 377
  - Irregular running ..... 143
  - Jump-starting ..... 341
  - Starting (important safety notes) ... 138
  - Starting problems ..... 143
  - Starting the engine with the SmartKey ..... 138
  - Starting via smartphone ..... 139
  - Starting with the Start/Stop button ..... 138
  - Switching off ..... 158
  - Tow-starting (vehicle) ..... 347
- Engine electronics**
  - Problem (malfunction) ..... 143
- Engine oil**
  - Adding ..... 320
  - Additives ..... 380
  - Checking the oil level ..... 319
  - Checking the oil level using the dipstick ..... 320
  - Checking the oil level using the on-board computer ..... 320
  - Display message ..... 254
  - Filling capacity ..... 380
  - General notes ..... 379
  - Notes about oil grades ..... 379
  - Notes on oil level/consumption .... 319
  - Temperature (on-board computer, Mercedes-AMG vehicles) ..... 235
- Entering an address**
  - see also Digital Operator's Manual ..... 280
- ESC (Electronic Stability Control)**
  - see ESP® (Electronic Stability Program)
- ESP® (Electronic Stability Program)**
  - AMG menu (on-board computer) ... 236
  - Characteristics ..... 70
  - Crosswind Assist ..... 73
  - Deactivating/activating (button in Mercedes-AMG vehicles) ..... 71
  - Deactivating/activating (notes, except Mercedes-AMG vehicles) ..... 70
  - Display message ..... 240
  - Function/notes ..... 69
  - General notes ..... 69
  - Important safety information ..... 70
  - Trailer stabilization ..... 72
  - Warning lamp ..... 271
- ETS/4ETS (Electronic Traction System)**
  - ..... 69
- Exhaust**
  - see Exhaust pipe
- Exhaust check** ..... 161

- Exhaust pipe**  
 Cleaning ..... 328
- Exterior lighting**  
 Cleaning ..... 327  
 Setting options ..... 112  
 see Lights
- Exterior mirrors**  
 Adjusting ..... 107  
 Dipping (automatic) ..... 108  
 Folding in/out (automatically) ..... 108  
 Folding in/out (electrically) ..... 108  
 Out of position (troubleshooting) ... 108  
 Setting ..... 108  
 Storing settings (memory function) ..... 110  
 Storing the parking position ..... 109
- Eyeglasses compartment** ..... 291
- F**
- Favorites**  
 Overview ..... 283
- Features** ..... 302
- Flat tire**  
 Changing a wheel/mounting the spare wheel ..... 369  
 MOExtended tires ..... 334  
 Preparing the vehicle ..... 334  
 TIREFIT kit ..... 335
- Floormats** ..... 317
- Frequencies**  
 Mobile phone ..... 375  
 Two-way radio ..... 375
- Front wheel arch**  
 Removing/installing the cover ..... 118
- Front wheel arch cover**  
 Installing/removing ..... 118
- Fuel**  
 Additives ..... 379  
 Consumption statistics ..... 225  
 Displaying the current consumption ..... 225  
 Displaying the range ..... 225  
 Driving tips ..... 161  
 E10 ..... 378  
 Fuel gauge ..... 37  
 Gasoline ..... 378  
 Grade (gasoline) ..... 378
- Important safety notes ..... 378  
 Problem (malfunction) ..... 157  
 Refueling ..... 155  
 Tank content/reserve fuel ..... 378
- Fuel level**  
 Calling up the range (on-board computer) ..... 225
- Fuel tank**  
 Capacity ..... 378  
 Problem (malfunction) ..... 157
- Fuses**  
 Allocation chart ..... 348  
 Before changing ..... 347  
 Dashboard fuse box ..... 347  
 Fuse box in the cargo compartment ..... 348  
 Fuse box in the engine compartment ..... 348  
 Fuse box in the front-passenger footwell ..... 347  
 Important safety notes ..... 347
- G**
- G-Meter (on-board computer, Mercedes-AMG vehicles)** ..... 236
- Garage door opener**  
 Clearing the memory ..... 317  
 General notes ..... 314  
 Important safety notes ..... 314  
 Opening/closing the garage door .. 316  
 Problems when programming ..... 316  
 Programming (button in the rear-view mirror) ..... 315  
 Synchronizing the rolling code ..... 315
- Gasoline** ..... 378
- Gear indicator (on-board computer, Mercedes-AMG vehicles)** ..... 235
- Genuine parts** ..... 28
- Glove box** ..... 291
- Google™ Local Search**  
 see also Digital Operator's Manual ..... 280
- H**
- Handling control system**  
 see ESP® (Electronic Stability Program)

- HANDS-FREE ACCESS** ..... 88
- Handwriting recognition**
- Switching text reader function ..... 283
  - on/off ..... 283
  - Touchpad ..... 282
- Hazard warning lamps** ..... 114
- Head restraints**
- Adjusting (electrically) ..... 102
  - Adjusting (manually) ..... 102
  - Adjusting (rear) ..... 102
  - Adjusting the fore-and-aft position manually ..... 102
  - General notes ..... 102
  - Important safety notes ..... 101
  - Installing/removing (rear) ..... 103
- Head-up display**
- Adjusting the brightness ..... 234
  - Displays and operating ..... 223
  - Function/notes ..... 223
  - Important safety notes ..... 223
  - Selecting displays ..... 233
  - Setting the position ..... 234
  - Storing settings (memory function) ..... 110
  - Switching on or off ..... 223
- Headlamps**
- Display message ..... 251
  - Fogging up ..... 115
  - see Automatic headlamp mode
- Heating**
- see Climate control
- High beam flasher** ..... 113
- High-beam headlamps**
- Adaptive Highbeam Assist ..... 114
  - Display message ..... 251
  - Replacing bulbs ..... 118
  - Switching on/off ..... 113
- Hill start assist** ..... 140
- HOLD function**
- Activating ..... 179
  - Activation conditions ..... 179
  - Deactivating ..... 179
  - Display message ..... 259
  - Function/notes ..... 178
  - General notes ..... 178
- Home address**
- see also Digital Operator's Manual ..... 280
- Hood**
- Closing ..... 319
  - Display message ..... 266
  - Important safety notes ..... 318
  - Opening ..... 318
- Horn** ..... 36
- HUD**
- see Head-up display
- Hydroplaning** ..... 164
- I**
- Ignition lock**
- see Key positions
- Immobilizer** ..... 76
- Indicator lamps**
- see Warning and indicator lamps
- Indicators**
- see Turn signals
- Insect protection on the radiator** .... 319
- Instrument cluster**
- Overview ..... 37
  - Warning and indicator lamps ..... 37
- Instrument cluster lighting** ..... 220
- Interior lighting**
- Automatic control ..... 116
  - Control ..... 116
  - Overview ..... 116
  - Reading lamp ..... 116
- iPod®**
- see also Digital Operator's Manual ..... 280
- J**
- Jack**
- Using ..... 370
- Jump starting (engine)** ..... 341
- K**
- Key positions**
- SmartKey ..... 136
  - Start/Stop button ..... 137
- KEYLESS-GO**
- Activating ..... 79
  - Convenience closing feature ..... 93
  - Deactivation ..... 79
  - Locking ..... 79

- Removing the Start/Stop button ... 137
  - Start function ..... 80
  - Unlocking ..... 79
  - Kickdown**
  - Driving tips ..... 149
  - Manual gearshifting ..... 154
  - Knee bag** ..... 51
- L
- Lamps**
  - see Warning and indicator lamps
  - Lane Change Assist**
  - see Active Blind Spot Assist
  - Lane detection (automatic)**
  - see Lane Keeping Assist
  - Lane Keeping Assist**
  - Activating/deactivating ..... 208
  - Activating/deactivating (on-board computer) ..... 233
  - Display message ..... 257
  - Function/information ..... 207
  - see Active Lane Keeping Assist
  - Lane Tracking package** ..... 205
  - Lap time (RACETIMER)** ..... 237
  - LATCH-type (ISOFIX) child seat anchors** ..... 62
  - Level control**
  - Display message ..... 257
  - see AIR BODY CONTROL
  - License plate lamp (display message)** ..... 251
  - Light function, active**
  - Display message ..... 251
  - Light switch**
  - Operation ..... 112
  - Lights**
  - Adaptive Highbeam Assist ..... 114
  - Automatic headlamp mode ..... 112
  - Cornering light function ..... 114
  - Fogged up headlamps ..... 115
  - General notes ..... 112
  - Hazard warning lamps ..... 114
  - High beam flasher ..... 113
  - High-beam headlamps ..... 113
  - Light switch ..... 112
  - Low-beam headlamps ..... 113
  - Parking lamps ..... 113
  - Rear fog lamp ..... 113
  - Setting exterior lighting ..... 112
  - Standing lamps ..... 113
  - Switching the daytime running lamps on/off (on-board computer) ..... 234
  - Turn signals ..... 113
  - see Interior lighting
  - Loading guidelines** ..... 290
  - Locking**
  - see Central locking
  - Locking (doors)**
  - Automatic ..... 85
  - Emergency locking ..... 85
  - From inside (central locking button) ..... 84
  - Locking centrally**
  - see Central locking
  - Low-beam headlamps**
  - Display message ..... 251
  - Replacing bulbs ..... 117
  - Switching on/off ..... 113
  - Lumbar support**
  - Adjusting the 4-way lumbar support ..... 103
- M
- M+S tires** ..... 351
  - Malfunction message**
  - see Display messages
  - Matte finish (cleaning instructions)** ..... 326
  - mbrace**
  - Call priority ..... 310
  - Display message ..... 245
  - Downloading destinations (COMAND) ..... 311
  - Downloading routes ..... 313
  - Emergency call ..... 308
  - General notes ..... 307
  - Geo fencing ..... 314
  - Info call button ..... 310
  - Locating a stolen vehicle ..... 312
  - Remote fault diagnosis ..... 312
  - Remote vehicle locking ..... 312
  - Roadside assistance button ..... 309
  - Search & Send ..... 311



- Self-test ..... 308  
 Speed alert ..... 313  
 System ..... 307  
 Triggering the vehicle alarm ..... 314  
 Vehicle remote unlocking ..... 312
- Mechanical key**  
 Function/notes ..... 80  
 General notes ..... 80  
 Inserting ..... 80  
 Locking vehicle ..... 85  
 Removing ..... 80  
 Unlocking the driver's door ..... 85
- Media Interface**  
 see Digital Operator's Manual
- Memory card (audio)** ..... 229
- Memory function**  
 Seats, steering wheel, exterior mirrors ..... 110
- Mercedes-Benz Intelligent Drive**  
 360° camera ..... 199  
 Active Blind Spot Assist ..... 209  
 Active Lane Keeping Assist ..... 212  
 ATTENTION ASSIST ..... 203  
 Blind Spot Assist ..... 205  
 Distance Pilot DISTRONIC ..... 170  
 Distance Pilot DISTRONIC with Steering Pilot ..... 177  
 General notes ..... 169  
 Lane Keeping Assist ..... 207  
 Parking Assist PARKTRONIC ..... 191  
 Parking Pilot ..... 188  
 PRE-SAFE® (anticipatory occupant protection) ..... 58  
 PRE-SAFE® PLUS (anticipatory occupant protection PLUS) ..... 59  
 Rear view camera ..... 194  
 Traffic Sign Assist ..... 205
- Message memory (on-board computer)** ..... 239
- Messages**  
 see Display messages  
 see Warning and indicator lamps
- Mirror turn signal**  
 Cleaning ..... 327
- Mirrors**  
 see Exterior mirrors  
 see Vanity mirror (in the sun visor)
- Mobile phone**  
 Connecting (device manager) ..... 287  
 Frequencies ..... 375  
 Installation ..... 375  
 Menu (on-board computer) ..... 230  
 Transmission output (maximum) .... 375
- Modifying the programming (SmartKey)** ..... 80
- MOExtended tires** ..... 334
- Mounting wheels**  
 Lowering the vehicle ..... 373  
 Mounting a new wheel ..... 372  
 Preparing the vehicle ..... 370  
 Raising the vehicle ..... 370  
 Removing a wheel ..... 372  
 Securing the vehicle against rolling away ..... 370
- MP3**  
 Operation ..... 229  
 see also Digital Operator's Manual ..... 280
- Multifunction display**  
 Function/notes ..... 222
- Multifunction steering wheel**  
 Operating the on-board computer .. 221  
 Overview ..... 38
- Multimedia system**  
 Switching on and off ..... 281
- Music files**  
 see also Digital Operator's Manual ..... 280
- N**
- Navigation**  
 Displaying (on-board computer) ..... 226  
 Menu (on-board computer) ..... 226  
 see also Digital Operator's Manual ..... 280
- Notes on breaking-in a new vehicle** ..... 135
- O**
- Occupant Classification System (OCS)**  
 Conditions ..... 52  
 Faults ..... 55

- Operation ..... 52
- System self-test ..... 54
- Occupant safety**
  - Air bags ..... 49
  - Automatic measures after an accident ..... 59
  - Belt warning ..... 49
  - Children in the vehicle ..... 60
  - Important safety notes ..... 44
  - Introduction to the restraint system ..... 44
  - Occupant Classification System (OCS) ..... 52
  - PASSENGER AIR BAG indicator lamps ..... 45
  - Pets in the vehicle ..... 65
  - PRE-SAFE® (anticipatory occupant protection) ..... 58
  - PRE-SAFE® PLUS (anticipatory occupant protection PLUS) ..... 59
  - Restraint system warning lamp ..... 45
  - Seat belt ..... 45
- OCS**
  - Conditions ..... 52
  - Faults ..... 55
  - Operation ..... 52
  - System self-test ..... 54
- Odometer** ..... 224
- Off-road driving**
  - Approach/departure angle ..... 384
  - Checklist after driving off-road ..... 167
  - Checklist before driving off-road ..... 167
  - General information ..... 166
  - Important safety notes ..... 165
  - Maximum gradient climbing ability ..... 384
  - Maximum water depth ..... 383
  - Traveling uphill ..... 168
- Off-road program**
  - Activating/deactivating ..... 183
  - General notes ..... 181
  - Overview of programs ..... 182
- Off-road system**
  - DSR ..... 180
  - Off road drive program ..... 181
  - Off-road 4ETS ..... 70
  - Off-road ESP® ..... 72
- Oil**
  - see Engine oil
- On-board computer**
  - AMG menu ..... 235
  - Assistance graphic menu ..... 231
  - Assistance menu ..... 232
  - Display messages ..... 239
  - Displaying a service message ..... 323
  - Displays and operation ..... 220
  - Distance Pilot DISTRONIC ..... 175
  - Factory settings ..... 235
  - G-Meter ..... 236
  - Head-up display ..... 223
  - Head-up display menu ..... 233
  - Important safety notes ..... 220
  - Instrument cluster menu ..... 234
  - Lights menu ..... 234
  - Media menu ..... 228
  - Menu overview ..... 224
  - Message memory ..... 239
  - Navigation menu ..... 226
  - RACETIMER ..... 237
  - Radio menu ..... 228
  - Service menu ..... 231
  - Settings menu ..... 231
  - Standard display ..... 224
  - Telephone menu ..... 230
  - Trip menu ..... 224
  - Video DVD operation ..... 229
- Opening and closing the side trim panels** ..... 119
- Operating safety**
  - Declaration of conformity ..... 31
  - Important safety notes ..... 31
- Operating system**
  - see On-board computer
- Operation**
  - Digital Operator's Manual ..... 27
- Operator's Manual**
  - Overview ..... 29
  - Vehicle equipment ..... 29
- Outside temperature display** ..... 221
- Overhead control panel** ..... 42
- Override feature**
  - Rear side windows ..... 65

## P

**Paddle shifters**

see Steering wheel paddle shifters

**Paint code number** ..... 376

**Paintwork (cleaning instructions)** ... 326

**Panic alarm** ..... 44

**Panorama roof with power tilt/  
sliding panel**

Important safety notes ..... 94

Operating ..... 95

Operating the roller sunblinds for

the sliding sunroof ..... 96

Problem (malfunction) ..... 97

Rain closing feature ..... 96

Reversing feature ..... 95

**Parcel net** ..... 298

**Parking**

Important safety notes ..... 158

Parking brake ..... 159

Parking position for the exterior  
mirror on the front-passenger

side ..... 109

Rear view camera ..... 194

Switching off the engine ..... 158

see Parking Assist PARKTRONIC

**Parking aid**

see 360° camera

see Exterior mirrors

see Parking Assist PARKTRONIC

see Parking Pilot

see Rear view camera

**Parking Assist**

Display message ..... 258

**Parking Assist PARKTRONIC**

Deactivating/activating ..... 193

Driving system ..... 191

Function/notes ..... 191

Important safety notes ..... 191

Problems (malfunctions) ..... 194

Sensor range ..... 192

Warning display ..... 193

**Parking assistance**

see Parking Assist PARKTRONIC

**Parking brake**

Applying automatically ..... 159

Applying or releasing manually ..... 159

Display message ..... 242

Electric parking brake ..... 159

Emergency braking ..... 160

General notes ..... 159

Releasing automatically ..... 160

Warning lamp ..... 274

**Parking lamps**

Switching on/off ..... 113

**Parking Pilot**

Canceling ..... 191

Detecting parking spaces ..... 188

Exiting a parking space ..... 190

Function/notes ..... 188

Important safety notes ..... 188

Parking ..... 189

**PASSENGER AIR BAG**

Display message ..... 249

Indicator lamps ..... 45

Problems (malfunction) ..... 249

**Perfume atomizer**

Operating ..... 132

Problem (malfunction) ..... 133

Setting the perfume intensity

(multimedia system) ..... 285

Vial ..... 132

**Permanent all-wheel drive**

see 4MATIC (permanent four-  
wheel drive)

**Pets in the vehicle** ..... 65

**Phone book**

see also Digital Operator's Man-  
ual ..... 280

**Plastic trim (cleaning instruc-  
tions)** ..... 329

**Power washers** ..... 325

**Power windows**

see Side windows

**PRE-SAFE® (anticipatory occupant  
protection)**

Display message ..... 246

Operation ..... 58

**PRE-SAFE® PLUS (anticipatory  
occupant protection PLUS)**

Operation ..... 59

**Program**

see Drive programs

**Protection against theft**

ATA (Anti-Theft Alarm system) ..... 77

- Immobilizer ..... 76
  - Protection of the environment**
  - General notes ..... 28
  - Pulling away**
  - Automatic transmission ..... 139
  - General notes ..... 139
  - Hill start assist ..... 140
  - Trailer ..... 140
- Q**
- QR code**
  - Mercedes-Benz Guide App ..... 1
  - Rescue card ..... 33
  - Qualified specialist workshop** ..... 32
  - Quick access for audio and telephone**
  - Changing the station/music track ..... 283
- R**
- RACE START (Mercedes-AMG vehicles)** ..... 183
  - RACE TIMER (on-board computer, Mercedes-AMG vehicles)** ..... 237
  - Radar sensor system**
  - Display message ..... 247
  - Radiator cover** ..... 319
  - Radio**
  - Selecting a station ..... 228
  - Radio mode**
  - see also Digital Operator's Manual ..... 280
  - Radio-wave reception/transmission in the vehicle**
  - Declaration of conformity ..... 31
  - Rain closing feature (panorama roof with power tilt/sliding panel)** .... 96
  - Reading lamp** ..... 116
  - Rear compartment**
  - Setting the air vents ..... 134
  - Setting the airflow ..... 129
  - Setting the temperature ..... 128
  - Rear fog lamp**
  - Display message ..... 251
  - Switching on/off ..... 113
  - Rear seat**
  - Adjusting the angle of the backrests ..... 295
  - Rear seat (folding the backrest forwards/back)** ..... 293
  - Rear seat backrest**
  - Display message ..... 266
  - Rear seats**
  - Display message ..... 266
  - Rear view camera**
  - "Reverse parking" function ..... 196
  - Cleaning instructions ..... 328
  - Coupling up a trailer function ..... 198
  - Display in the multimedia system .. 195
  - General notes ..... 194
  - Object detection (function/notes) ..... 198
  - Switching on/off ..... 195
  - Wide-angle function ..... 198
  - Rear window defroster**
  - Problem (malfunction) ..... 131
  - Switching on/off ..... 130
  - Rear window wiper**
  - Replacing the wiper blade ..... 122
  - Switching on/off ..... 121
  - Rear-view mirror**
  - Dipping (automatic) ..... 108
  - Recuperation display** ..... 225
  - Reflective safety jacket** ..... 332
  - Refrigerant (air-conditioning system)**
  - Important safety notes ..... 381
  - Refueling**
  - Fuel gauge ..... 37
  - Important safety notes ..... 155
  - see Fuel
  - Remote control**
  - Garage door opener ..... 314
  - Programming (garage door opener) ..... 315
  - Replacing bulbs**
  - Backup lamp ..... 119
  - High-beam headlamps ..... 118
  - Important safety notes ..... 116
  - Installing/removing the cover (front wheel arch) ..... 118
  - Low-beam headlamps ..... 117
  - Opening/closing side trim panels .. 119

- Overview of bulb types ..... 117
  - Replacing front bulbs (vehicles with halogen headlamps) ..... 117
  - Turn signals (front) ..... 118
  - Reporting safety defects** ..... 33
  - Rescue card** ..... 33
  - Reserve (fuel tank)**  
see Fuel
  - Reserve fuel**  
Display message ..... 255  
Warning lamp ..... 274
  - Residual heat (climate control)** ..... 131
  - Restraint system**  
Display message ..... 247  
Introduction ..... 44  
Warning lamp ..... 274  
Warning lamp (function) ..... 45
  - Reversing feature**  
Panorama sliding sunroof ..... 95  
Roller sunblinds ..... 96  
Side windows ..... 91  
Tailgate ..... 86
  - Roadside Assistance (breakdown)** .... 30
  - Roll away protection**  
see HOLD function
  - Roller sunblind**  
Operating ..... 97  
Panorama roof with power tilt/  
sliding panel ..... 96  
Rear side windows ..... 303  
Resetting ..... 97
  - Roof carrier** ..... 301
  - Roof lining and carpets (cleaning guidelines)** ..... 331
  - Roof load (maximum)** ..... 382
  - Route guidance**  
see also Digital Operator's Manual ..... 280
  - Route guidance active** ..... 226
- S**
- Safety**  
Children in the vehicle ..... 60  
see Occupant safety  
see Operating safety
  - Safety system**  
see Driving safety systems
  - SD card**  
Inserting/removing ..... 289  
Selecting ..... 229
  - SD memory card**  
see also Digital Operator's Manual ..... 280
  - Search & Send**  
see also Digital Operator's Manual ..... 280
  - Seat**  
Correct driver's seat position ..... 99
  - Seat belts**  
Adjusting the driver's and front-passenger seat belt ..... 48  
Adjusting the height ..... 48  
center rear-compartment seat ..... 48  
Cleaning ..... 330  
Correct usage ..... 47  
Fastening ..... 48  
Important safety guidelines ..... 46  
Introduction ..... 45  
Releasing ..... 48  
Warning lamp ..... 269  
Warning lamp (function) ..... 49
  - Seats**  
Adjusting (electrically) ..... 101  
Adjusting the 4-way lumbar support ..... 103  
Adjusting the head restraint ..... 101  
Calling up a stored setting (memory function) ..... 110  
Cleaning the cover ..... 330  
Folding the backrest (rear compartment) forwards/back ..... 293  
Important safety notes ..... 99  
Seat heating ..... 103  
Seat heating problem ..... 104  
Seat ventilation ..... 104  
Seat ventilation problem ..... 104  
Storing settings (memory function) ..... 110
  - Securing cargo** ..... 295
  - Selector lever**  
Cleaning ..... 329  
see Automatic transmission
  - Sensors (cleaning instructions)** ..... 328
  - Service menu (on-board computer)** ..... 231

- Service message**  
see ASSYST PLUS
- Service products**  
Brake fluid ..... 380  
Coolant (engine) ..... 380  
Engine oil ..... 379  
Fuel ..... 377  
Important safety notes ..... 377  
Refrigerant (air-conditioning system) ..... 381  
Washer fluid ..... 381
- Setting the date/time format**  
see also Digital Operator's Manual ..... 280
- Setting the language**  
see also Digital Operator's Manual ..... 280
- Setting the time**  
see also Digital Operator's Manual ..... 280
- Settings**  
Factory (on-board computer) ..... 235  
On-board computer ..... 231
- SETUP (on-board computer, Mercedes-AMG vehicles)** ..... 236
- Side impact air bag** ..... 51
- Side marker lamp (display message)** ..... 251
- Side running board**  
Cleaning ..... 328
- Side windows**  
Cleaning ..... 327  
Convenience closing feature ..... 92  
Convenience opening feature ..... 92  
Important safety information ..... 91  
Opening/closing ..... 91  
Problem (malfunction) ..... 94  
Resetting ..... 93  
Reversing feature ..... 91
- SIRIUS services**  
see also Digital Operator's Manual ..... 280
- Ski and snowboard bag** ..... 292
- Sliding sunroof**  
Important safety notes ..... 94  
Problem (malfunction) ..... 97  
see Panorama roof with power tilt/sliding panel
- SmartKey**  
Changing the battery ..... 81  
Changing the programming ..... 80  
Checking the battery ..... 81  
Convenience closing feature ..... 93  
Convenience opening feature ..... 92  
Display message ..... 267  
Door central locking/unlocking ..... 78  
Important safety notes ..... 78  
KEYLESS-GO start function ..... 80  
Loss ..... 82  
Mechanical key ..... 80  
Overview ..... 78  
Positions (ignition lock) ..... 136  
Problem (malfunction) ..... 82  
Starting the engine ..... 138
- Smartphone**  
Starting the engine ..... 139
- SMS**  
see also Digital Operator's Manual ..... 280
- Snow chains** ..... 351
- Socket (12 V)**  
Cargo compartment ..... 305  
Center console ..... 305  
General notes ..... 305  
Rear compartment ..... 305
- Sound**  
Switching on/off ..... 281
- Special seat belt retractor** ..... 60
- Specialist workshop** ..... 32
- Speed, controlling**  
see Cruise control
- Speedometer**  
Activating/deactivating the additional speedometer ..... 235  
Digital ..... 225  
In the Instrument cluster ..... 37  
Segments ..... 220  
Selecting the display unit ..... 234
- SPORT handling mode**  
Deactivating/activating (Mercedes-AMG vehicles) ..... 71  
Warning lamp ..... 273
- Sports exhaust system**  
AMG ..... 142
- Standing lamps**  
Display message ..... 251

- Switching on/off ..... 113
  - Start button**
    - Display message ..... 268
  - Start/Stop button**
    - Key positions ..... 137
    - Starting the engine ..... 138
  - Start/stop function**
    - see ECO start/stop function
  - Starting (engine)** ..... 138
  - STEER CONTROL** ..... 76
  - Steering**
    - Display message ..... 267
    - Warning lamps ..... 279
  - Steering assistant STEER CONTROL**
    - see STEER CONTROL
  - Steering Pilot**
    - Display message ..... 261
    - with Distance Pilot DISTRONIC ..... 177
  - Steering wheel**
    - Adjusting (electrically) ..... 105
    - Adjusting (manually) ..... 105
    - Button overview ..... 38
    - Buttons (on-board computer) ..... 221
    - Cleaning ..... 329
    - EASY ENTRY/EXIT feature ..... 106
    - Important safety notes ..... 105
    - Storing settings (memory function) ..... 110
  - Steering wheel heating**
    - Problem (malfunction) ..... 106
    - Switching on/off ..... 105
  - Steering wheel paddle shifters** ..... 152
  - Stopwatch (RACETIMER)** ..... 237
  - Stowage areas** ..... 290
  - Stowage compartments**
    - Armrest (under) ..... 291
    - Center console ..... 291
    - Cup holders ..... 302
    - Door ..... 292
    - Eyeglasses compartment ..... 291
    - Glove box ..... 291
    - Important safety information ..... 290
    - Map pockets ..... 292
    - Rear ..... 292
    - Stowage net ..... 292
    - see Stowage areas
  - Stowage net** ..... 292
  - Summer tires**
    - In winter ..... 351
  - Sun visor** ..... 303
  - Suspension settings**
    - AIR BODY CONTROL ..... 184
  - Suspension tuning**
    - AMG sports suspension based on AIR BODY CONTROL ..... 186
    - SETUP (on-board computer, Mercedes-AMG vehicles) ..... 236
  - SUV**
    - (Sport Utility Vehicle) ..... 31
  - Switching air-recirculation mode on/off** ..... 131
  - Switching on media mode**
    - Via the device list ..... 288
- T**
- Tachometer** ..... 221
  - Tail lamps**
    - Display message ..... 251
  - Tailgate**
    - Display message ..... 266
    - Emergency unlocking ..... 90
    - HANDS-FREE ACCESS ..... 88
    - Important safety notes ..... 85
    - Limiting the opening angle ..... 90
    - object detection ..... 86
    - Opening dimensions ..... 382
    - Opening/closing (automatically from inside) ..... 89
    - Opening/closing (automatically from outside) ..... 87
    - Opening/closing (manually from outside) ..... 86
    - Reversing feature ..... 86
  - Tank content**
    - Fuel gauge ..... 37
  - Technical data**
    - Capacities ..... 377
    - Drawbar load (maximum) ..... 384
    - Information ..... 375
    - Trailer loads ..... 384
    - Vehicle data ..... 382

- Telephone**
- Accepting a call (multifunction steering wheel) ..... 230
  - Authorizing a mobile phone (connecting) ..... 288
  - Connecting a mobile phone (device manager) ..... 287
  - Display message ..... 267
  - Introduction ..... 230
  - Menu (on-board computer) ..... 230
  - Number from the phone book ..... 230
  - Redialing ..... 231
  - Rejecting/ending a call ..... 230
  - see also Digital Operator's Manual ..... 280
  - see Mobile phone
- Temperature**
- Coolant (display in the instrument cluster) ..... 221
  - Engine oil (on-board computer, Mercedes-AMG vehicles) ..... 235
  - Outside temperature ..... 221
  - Setting (climate control) ..... 128
  - Transmission oil (on-board computer, Mercedes-AMG vehicles) ..... 235
- Timing (RACETIMER)** ..... 237
- Tire pressure**
- Calling up (on-board computer) ..... 356
  - Checking manually ..... 355
  - Display message ..... 262
  - Maximum ..... 355
  - Not reached (TIREFIT) ..... 337
  - Notes ..... 353
  - Reached (TIREFIT) ..... 337
  - Recommended ..... 352
  - Using the TIREFIT kit ..... 336
- Tire pressure loss warning system**
- General notes ..... 355
  - Important safety notes ..... 355
  - Restarting ..... 356
- Tire pressure monitor**
- Checking the tire pressure electronically ..... 358
  - Function/notes ..... 356
  - General notes ..... 356
  - Important safety notes ..... 357
  - Radio type approval for the tire pressure monitor ..... 359
  - Restarting ..... 358
  - Warning lamp ..... 278
  - Warning message ..... 358
- Tire pressure sensors**
- Display message ..... 263
- Tire-change tool kit** ..... 333
- TIREFIT kit**
- Important safety notes ..... 335
  - Storage location ..... 333
  - Tire pressure not reached ..... 337
  - Tire pressure reached ..... 337
  - Using ..... 336
- Tires**
- Aspect ratio (definition) ..... 368
  - Average weight of the vehicle occupants (definition) ..... 367
  - Bar (definition) ..... 367
  - Changing a wheel ..... 369
  - Characteristics ..... 367
  - Checking ..... 349
  - Curb weight (definition) ..... 368
  - Definition of terms ..... 367
  - Direction of rotation ..... 369
  - Display message ..... 262
  - Distribution of the vehicle occupants (definition) ..... 369
  - DOT (Department of Transportation) (definition) ..... 367
  - DOT, Tire Identification Number (TIN) ..... 366
  - GAWR (Gross Axle Weight Rating) (definition) ..... 367
  - GVW (Gross Vehicle Weight) (definition) ..... 368
  - GVWR (Gross Vehicle Weight Rating) (definition) ..... 368
  - Important safety notes ..... 349
  - Increased vehicle weight due to optional equipment (definition) ..... 367
  - Information on driving ..... 349
  - Kilopascal (kPa) (definition) ..... 368
  - Labeling (overview) ..... 364
  - Load bearing index (definition) ..... 369
  - Load index ..... 366
  - Load index (definition) ..... 368
  - Maximum load on a tire (definition) ..... 368



- Maximum loaded vehicle weight (definition) ..... 368
- Maximum permissible tire pressure (definition) ..... 368
- Maximum tire load ..... 366
- Maximum tire load (definition) ..... 368
- MOExtended tires ..... 351
- Optional equipment weight (definition) ..... 369
- PSI (pounds per square inch) (definition) ..... 368
- Replacing ..... 369
- Service life ..... 350
- Sidewall (definition) ..... 368
- Snow chains ..... 351
- Speed rating (definition) ..... 368
- Storing ..... 370
- Structure and characteristics (definition) ..... 367
- Summer tires in winter ..... 351
- Temperature ..... 363
- TIN (Tire Identification Number) (definition) ..... 369
- Tire bead (definition) ..... 368
- Tire pressure (definition) ..... 368
- Tire pressures (recommended) ..... 367
- Tire size (data) ..... 373
- Tire size designation, load-bearing capacity, speed rating ..... 364
- Tire tread ..... 350
- Tire tread (definition) ..... 368
- Total load limit (definition) ..... 369
- Traction ..... 363
- Traction (definition) ..... 369
- Tread wear ..... 363
- Uniform Tire Quality Grading Standards ..... 362
- Uniform Tire Quality Grading Standards (definition) ..... 367
- Wear indicator (definition) ..... 369
- Wheel and tire combination ..... 373
- Wheel rim (definition) ..... 367
- see Flat tire
- Top Tether** ..... 62
- Touchpad**
  - Changing the station/music track ..... 283
  - Character suggestions ..... 282
  - Deleting characters ..... 282
  - Entering a space ..... 282
  - Entering characters ..... 282
  - Gesture control ..... 282
  - Handwriting recognition ..... 282
  - Operating the touchpad ..... 282
  - Overview ..... 282
  - Quick access for Audio ..... 283
  - Switching ..... 282
  - Switching input line ..... 282
- Tow-starting**
  - Emergency engine starting ..... 347
  - Important safety notes ..... 343
- Towing a trailer**
  - Axle load, permissible ..... 384
  - Cleaning the trailer tow hitch ..... 329
  - Coupling up a trailer ..... 216
  - Decoupling a trailer ..... 218
  - Driving tips ..... 215
  - ESP® (Electronic Stability Program) ..... 72
  - Important safety notes ..... 214
  - Installing the ball coupling ..... 216
  - Lights display message ..... 251
  - Power supply ..... 218
  - Pulling away with a trailer ..... 140
  - Removing the ball coupling ..... 218
  - Trailer loads ..... 384
- Towing away**
  - Important safety guidelines ..... 343
  - Installing the towing eye ..... 344
  - Notes for 4MATIC vehicles ..... 346
  - Removing the towing eye ..... 345
  - Transporting the vehicle ..... 346
  - With both axles on the ground ..... 345
- Towing eye** ..... 333
- Traction system**
  - see ETS/4ETS (Electronic Traction System)
- Traffic reports**
  - see also Digital Operator's Manual ..... 280
- Traffic Sign Assist**
  - Activating/deactivating the warning function ..... 232
  - Display message ..... 259
  - Function/notes ..... 205
  - Important safety notes ..... 205

- Instrument cluster display ..... 205
  - Trailer coupling**
    - see Towing a trailer
  - Trailer loads and drawbar nose-weights** ..... 218
  - Trailer towing**
    - Active Lane Keeping Assist ..... 214
    - Blind Spot Assist ..... 207
    - Permissible trailer loads and drawbar noseweights ..... 218
  - Transfer case** ..... 155
  - Transmission**
    - Display message ..... 265
    - see Automatic transmission
  - Transmission oil**
    - Temperature (on-board computer, Mercedes-AMG vehicles) ..... 235
  - Transmission position display** ..... 148
  - Transporting the vehicle** ..... 346
  - Traveling uphill**
    - Brow of hill ..... 168
    - Driving downhill ..... 168
    - Maximum gradient-climbing capability ..... 168
  - Trim pieces (cleaning instructions)** ..... 330
  - Trip computer (on-board computer)** ..... 225
  - Trip odometer**
    - Calling up ..... 224
    - Resetting (on-board computer) ..... 226
  - Trunk**
    - see Cargo compartment
  - Turn signals**
    - Display message ..... 251
    - Replacing bulbs (front) ..... 118
    - Switching on/off ..... 113
  - Two-way radio**
    - Frequencies ..... 375
    - Installation ..... 375
    - Transmission output (maximum) .... 375
  - Type identification plate**
    - see Vehicle identification plate
  - From inside the vehicle (central unlocking button) ..... 84
  - USB devices**
    - Connecting to the Media Interface ..... 289
- ## V
- Vanity mirror (in the sun visor)** ..... 303
  - Vehicle**
    - Correct use ..... 32
    - Data acquisition ..... 33
    - Display message ..... 264
    - Electronics ..... 375
    - Equipment ..... 29
    - Individual settings ..... 231
    - Limited Warranty ..... 33
    - Loading ..... 359
    - Locking (in an emergency) ..... 85
    - Locking (SmartKey) ..... 78
    - Lowering ..... 373
    - Maintenance ..... 30
    - Operating safety ..... 31
    - Operation outside the USA/Canada ..... 30
    - Parking ..... 158
    - Parking for a long period ..... 160
    - Pulling away ..... 139
    - Raising ..... 370
    - Reporting problems ..... 32
    - Securing from rolling away ..... 370
    - Technical data ..... 375
    - Towing away ..... 343
    - Transporting ..... 346
    - Unlocking (in an emergency) ..... 85
    - Unlocking (SmartKey) ..... 78
    - Vehicle data ..... 382
  - Vehicle data**
    - Dimensions ..... 382
  - Vehicle data (off-road driving)**
    - Approach/departure angle ..... 384
    - Maximum gradient climbing ability ..... 384
    - Maximum water depth ..... 383
  - Vehicle emergency locking** ..... 85
  - Vehicle identification number**
    - see VIN
  - Vehicle identification plate** ..... 376
- ## U
- Unlocking**
    - Emergency unlocking ..... 85

- Vehicle level**
    - AIR BODY CONTROL ..... 185
    - Display message ..... 256
  - Video**
    - Operating the DVD ..... 229
    - see also Digital Operator's Manual ..... 280
  - VIN**
    - Seat ..... 377
    - Type plate ..... 376
- W**
- Warning and indicator lamps**
    - ABS ..... 271
    - Active Brake Assist ..... 277
    - Airbag ..... 274
    - Brakes ..... 270
    - Coolant ..... 275
    - Distance warning ..... 277
    - Engine diagnostics ..... 274
    - ESP® ..... 271
    - ESP® OFF ..... 273
    - Fuel tank ..... 274
    - General notes ..... 268
    - Overview ..... 37
    - Parking brake ..... 274
    - PASSENGER AIR BAG ..... 45
    - Reserve fuel ..... 274
    - Restraint system ..... 274
    - Seat belt ..... 269
    - SPORT handling mode ..... 273
    - Steering ..... 279
    - Tire pressure monitor ..... 278
  - Warranty** ..... 29
  - Washer fluid**
    - Display message ..... 267
  - Weather display (COMAND)**
    - see also Digital Operator's Manual ..... 280
  - Wheel and tire combinations**
    - Tires ..... 373
  - Wheel bolt tightening torque** ..... 373
  - Wheel chock** ..... 370
  - Wheels**
    - Changing a wheel ..... 369
    - Checking ..... 349
    - Cleaning ..... 326
    - Important safety notes ..... 349
    - Information on driving ..... 349
    - Interchanging/changing ..... 369
    - Mounting a new wheel ..... 372
    - Mounting a wheel ..... 370
    - Removing a wheel ..... 372
    - Snow chains ..... 351
    - Storing ..... 370
    - Tightening torque ..... 373
    - Wheel size/tire size ..... 373
  - Window curtain air bag**
    - Display message ..... 248
    - Operation ..... 51
  - Windows**
    - see Side windows
  - Windshield**
    - Defrosting ..... 130
  - Windshield washer fluid**
    - see Windshield washer system
  - Windshield washer system**
    - Adding washer fluid ..... 322
    - Important safety notes ..... 381
  - Windshield wipers**
    - Problem (malfunction) ..... 123
    - Rear window wiper ..... 121
    - Replacing the wiper blades ..... 121
    - Switching on/off ..... 120
  - Winter driving**
    - Important safety notes ..... 351
    - Slippery road surfaces ..... 165
    - Snow chains ..... 351
  - Winter operation**
    - Radiator cover ..... 319
    - Summer tires ..... 351
  - Winter tires**
    - M+S tires ..... 351
  - Wiper arm**
    - Moving to a vertical position ..... 121
  - Wiper blades**
    - Cleaning ..... 327
    - Important safety notes ..... 121
    - Replacing ..... 121
    - Replacing (rear window) ..... 122
    - Replacing (windshield) ..... 121
  - Without changing gears**
    - Display message ..... 265
  - Wooden trim (cleaning instructions)** ..... 330

**Workshop**

see Qualified specialist workshop

## Introduction

The printed Operator's Manual provides information about the safe operation of your vehicle. The Digital Operator's Manual provides comprehensive and specifically adapted information on your vehicle's equipment and multimedia system. You can call up the Digital Operator's Manual via the multimedia system.

- i** You will not incur any costs when calling up the Digital Operator's Manual. The Digital Operator's Manual works without connecting to the Internet.

There are three ways to access the topics of the Digital Operator's Manual:

### • Visual search

The visual search allows you to explore your vehicle "virtually". Starting from either the vehicle exterior view or interior view, you can access many of the different topics covered by the Digital Operator's Manual. To access the vehicle interior section, select the "Vehicle interior" view.

### • Keyword search

The keyword search allows you to search for a keyword by entering characters.





### • Contents

You can select individual sections in the contents.

- i** The Digital Operator's Manual is deactivated for safety reasons while driving.

## Operation

### Calling up the Digital Operator's Manual

- ▶ Press the  button on the center console. The overview relating to the vehicle appears.
- ▶ Select the "Operator's Manual" menu item by turning  or pressing  the controller.
- ▶ Confirm  the message about the warning and safety notes. The menu for the Digital Operator's Manual appears.

## Operating the Digital Operator's Manual













### General notes

Please observe the information about the operation of the controller (> page 281).

### Content pages

The content pages can be accessed by means of a visual search, a keyword search or using the contents.



- ▶ **To scroll forward/back:** turn  the controller.
- ▶ **To display in full-screen or animation:** slide  the controller to the left  ①.
- ▶ **To select information text or save bookmarks:** slide  the controller to the right  ②.
- ▶ **To select a link:** slide  the controller down  ③.
- ▶ **To exit a content page:** select the  symbol ④.
- ▶ **To call up the menu of the Digital Operator's Manual:** select the  symbol ⑤.
- ▶ **To switch functions to the multimedia system using the buttons on the center console:** press the , ,  or  button. The selected menu appears. The Digital Operator's Manual remains open in the background.

**Protecting the environment****General notes****🌱 Environmental note**

Daimler's declared policy is one of comprehensive environmental protection.

The objectives are for the natural resources that form the basis of our existence on this planet to be used sparingly and in a manner that takes the requirements of both nature and humanity into account.

You too can help to protect the environment by operating your vehicle in an environmentally responsible manner.

Fuel consumption and the rate of engine, transmission, brake and tire wear are affected by these factors:

- operating conditions of your vehicle
- your personal driving style

You can influence both factors. You should bear the following in mind:

Operating conditions:

- avoid short trips as these increase fuel consumption.
- always make sure that the tire pressures are correct.
- do not carry any unnecessary weight.
- remove roof racks once you no longer need them.
- a regularly serviced vehicle will contribute to environmental protection. You should therefore adhere to the service intervals.
- always have service work carried out at a qualified specialist workshop.

Personal driving style:

- do not depress the accelerator pedal when starting the engine.
- do not warm up the engine when the vehicle is stationary.
- drive carefully and maintain a safe distance from the vehicle in front.
- avoid frequent, sudden acceleration and braking.

- change gear in good time and use each gear only up to  $\frac{2}{3}$  of its maximum engine speed.
- switch off the engine in stationary traffic.
- keep an eye on the vehicle's fuel consumption.

**Environmental concerns and recommendations**

Wherever the Operator's Manual requires you to dispose of materials, first try to regenerate or reuse them. Observe the relevant environmental rules and regulations when disposing of materials. In this way you will help to protect the environment.

**Genuine Mercedes-Benz parts****🌱 Environmental note**

Daimler AG also supplies reconditioned major assemblies and parts which are of the same quality as new parts. They are covered by the same Limited Warranty entitlements as new parts.

**!** Air bags and Emergency Tensioning Devices, as well as control units and sensors for these restraint systems, may be installed in the following areas of your vehicle:

- doors
- door pillars
- door sills
- seats
- cockpit
- instrument cluster
- center console

Do not install accessories such as audio systems in these areas. Do not carry out repairs or welding. You could impair the operating efficiency of the restraint systems.

Have aftermarket accessories installed at a qualified specialist workshop.

You could jeopardize the operating safety of your vehicle if you use parts, tires and wheels as well as accessories relevant to safety which have not been approved by Mercedes-Benz. This could lead to malfunctions in safety-relevant

systems, e.g. the brake system. Use only genuine Mercedes-Benz parts or parts of equal quality. Only use tires, wheels and accessories that have been specifically approved for your vehicle.

Genuine Mercedes-Benz parts are subject to strict quality control. Every part has been specifically developed, manufactured or selected for and adapted to Mercedes-Benz vehicles. Therefore, only genuine Mercedes-Benz parts should be used.

More than 300,000 different genuine Mercedes-Benz parts are available for Mercedes-Benz models.

All authorized Mercedes-Benz Centers maintain a supply of genuine Mercedes-Benz parts for necessary service and repair work. In addition, strategically located parts delivery centers provide quick and reliable parts service.

Always specify the vehicle identification number (VIN) when ordering genuine Mercedes-Benz parts (> page 376).

## Operator's Manual

### Vehicle equipment

**i** This Operator's Manual describes all models and all standard and optional equipment of your vehicle available at the time of publication of the Operator's Manual. Country-specific differences are possible. Bear in mind that your vehicle may not feature all functions described here. This also applies to safety-relevant systems and functions. The equipment in your vehicle may therefore differ from that shown in the descriptions and illustrations.

The original purchase agreement lists all systems installed in your vehicle.

Should you have any questions concerning equipment and operation, please consult an authorized Mercedes-Benz Center.

The Operator's Manual and Maintenance Booklet are important documents and should be kept in the vehicle.

## Service and vehicle operation

### Warranty

The Limited Warranty for your vehicle applies in accordance with the warranty terms and conditions in the Service and Warranty Information booklet.

Your authorized Mercedes-Benz Center will replace and repair all factory-installed parts in accordance with the following warranty terms and conditions:

- New Vehicle Limited Warranty
- Emission System Warranty
- Emission Performance Warranty
- California, Connecticut, Maine, Massachusetts, New York, Pennsylvania, Rhode Island and Vermont Emission Control System Warranty
- State warranty enforcement laws (lemon laws)

Replacement parts and accessories are covered by the Mercedes-Benz Parts and Accessories warranties. These are available at any authorized Mercedes-Benz Center.

**i** Should you lose your Service and Warranty Information booklet, have an authorized Mercedes-Benz Center arrange for a replacement. The new Service and Warranty Information booklet will be posted to you.

### Information for customers in California

Under California law you may be entitled to a replacement of your vehicle or a refund of the purchase price or lease price, if after a reasonable number of repair attempts Mercedes-Benz USA, LLC and/or its authorized repair or service facilities fail to fix one or more substantial defects or malfunctions in the vehicle that are covered by its express warranty.

During the period of 18 months from original delivery of the vehicle or the accumulation of 18,000 miles (approximately 29,000 km) on the odometer of the vehicle, whichever occurs first, a reasonable number of repair attempts is presumed for a retail buyer or lessee if one or more of the following occurs:

- (1) the substantial defect or malfunction can result in death or serious injuries for the

- vehicle occupants while driving and this defect has already been repaired at least twice and Mercedes-Benz, LLC has been informed in writing of the necessity of a repair.
- (2) the defect or malfunction, though less serious than (1) above, has already been repaired at least four times and Mercedes-Benz has been informed in writing of the necessity of a repair.
  - (3) the vehicle cannot be used for longer than 30 calendar days because of repair work resulting from this or other substantial defects or malfunctions.

Please send your written notice to:

Mercedes-Benz USA, LLC

Customer Assistance Center

3 Mercedes Drive

Montvale, NJ 07645-0350

### Maintenance

Always bring the Maintenance Booklet with you when taking the vehicle to an authorized Mercedes-Benz Center. Your customer service advisor will enter every service into your Maintenance Booklet on your behalf.

### Roadside Assistance

The Mercedes-Benz Roadside Assistance Program offers technical help in the event of a breakdown. Calls to the toll-free Roadside Assistance Hotline are answered by our agents 24 hours a day, 365 days a year.

**1-800-FOR-MERCEdes (1-800-367-6372)**  
**(USA)**

**1-800-387-0100 (Canada)**

For additional information, refer to the Mercedes-Benz Roadside Assistance Program brochure (USA) or the "Roadside Assistance" section in the Service and Warranty Booklet (Canada). You will find both in the vehicle document wallet.

### Change of address or change of ownership

In the event of a change of address, please send us the "Notification of Address Change" in the

Service and Warranty Booklet or simply call the Mercedes-Benz Customer Assistance Center (USA) at the hotline number 1-800-FOR-MERCEdes (1-800-367-6372) or Customer Service Center (Canada) at 1-800-387-0100. This will assist us in contacting you in a timely manner should the need arise.

If you sell your Mercedes, please leave all literature in the vehicle so that it is available to the next owner.

If you have purchased a used car, please send us the "Notification of Used Car Purchase" in the Service and Warranty Booklet or simply call the Mercedes-Benz Customer Assistance Center (USA) at the hotline number 1-800-FOR-MERCEdes (1-800-367-6372) or Customer Service (Canada) at 1-800-387-0100.

### Vehicle operation outside the USA and Canada

When you are abroad with your vehicle, observe the following points:

- Service facilities or replacement parts may not be readily available.
- Lead-free fuel for vehicles with a catalytic converter may not be available. Leaded fuel can cause damage to the catalytic converter.
- The fuel may have a considerably lower octane number. Unsuitable fuel can cause engine damage.

Some Mercedes-Benz models are available for delivery in Europe through our European Delivery Program. For details, consult an authorized Mercedes-Benz Center or write to one of the following addresses.

#### In the USA

Mercedes-Benz USA, LLC  
European Delivery Department  
One Mercedes Drive  
Montvale, NJ 07645-0350

#### In Canada

Mercedes-Benz Canada, Inc.  
European Delivery Department  
98 Vanderhoof Avenue  
Toronto, Ontario M4G 4C9



## Sports Utility Vehicle

### WARNING

Due to the high center of gravity, the vehicle may start to skid and roll over in the event of an abrupt steering maneuver and/or when the vehicle's speed is not adapted to the road conditions. There is a risk of an accident.

Always adapt your speed and driving style to the vehicle's driving characteristics and to the prevailing road and weather conditions.

Utility vehicles have a significantly higher roll-over rate than other types of vehicles.

Failure to operate this vehicle safely may result in an accident, rollover of the vehicle, and severe or fatal injury.

In a rollover crash, an unbelted person is significantly more likely to die than a person wearing a seat belt.

You and all vehicle occupants should always wear your seat belts.

## Operating safety

### Important safety notes

#### WARNING

If you do not have the prescribed service/maintenance work or any required repairs carried out, this can result in malfunctions or system failures. There is a risk of an accident. Always have the prescribed service/maintenance work as well as any required repairs carried out at a qualified specialist workshop.

#### WARNING

Flammable material such as leaves, grass or twigs may ignite if they come into contact with hot parts of the exhaust system. There is a risk of fire.

When driving on an unpaved road or off-road, check the vehicle underside regularly. In particular, remove trapped plant parts or other flammable material. Contact a qualified specialist workshop immediately if damage is detected.

### WARNING

Modifications to electronic components, their software as well as wiring can impair their function and/or the function of other networked components. In particular, systems relevant to safety could also be affected. As a result, these may no longer function as intended and/or jeopardize the operating safety of the vehicle. There is an increased risk of an accident and injury.

Never tamper with the wiring as well as electronic components or their software. You should have all work to electrical and electronic equipment carried out at a qualified specialist workshop.

-  There is a risk of damage to the vehicle if:
- the vehicle becomes stuck, e.g. on a high curb or an unpaved road
  - you drive too fast over an obstacle, e.g. a curb, a speed bump or a pothole in the road
  - a heavy object strikes the underbody or parts of the chassis

In situations like this, the body, the underbody, chassis parts, wheels or tires could be damaged without the damage being visible. Components damaged in this way can unexpectedly fail or, in the case of an accident, no longer withstand the loads they are designed to.

If the underbody paneling is damaged, combustible materials such as leaves, grass or twigs can gather between the underbody and the underbody paneling. If these materials come in contact with hot parts of the exhaust system, they can catch fire.

In such situations, have the vehicle checked and repaired immediately at a qualified specialist workshop. If on continuing your journey you notice that driving safety is impaired, pull over and stop the vehicle immediately, paying attention to road and traffic conditions. In such cases, consult a qualified specialist workshop.

### Declaration of conformity for wireless vehicle components

**USA:** "The wireless devices of this vehicle comply with Part 15 of the FCC Rules. Operation is

subject to the two following two conditions: 1) These devices may not cause harmful interference, and 2) These devices must accept any interference received, including interference that may cause undesired operation. Changes or modifications not expressly approved by the party responsible for compliance could void the user's authority to operate the equipment."

**Canada:** "The wireless devices of this vehicle comply with Industry Canada license-exempt RSS standard(s). Operation is subject to the following two conditions: (1) These devices may not cause interference, and (2) These devices must accept any interference, including interference that may cause undesired operation of the device."

### Diagnostics connection

The diagnostics connection is only intended for the connection of diagnostic equipment at a qualified specialist workshop.

#### WARNING

If you connect equipment to a diagnostics connection in the vehicle, it may affect the operation of vehicle systems. As a result, the operating safety of the vehicle could be affected. There is a risk of an accident.

Only connect equipment to a diagnostics connection in the vehicle, which is approved for your vehicle by Mercedes-Benz.

#### WARNING

Objects in the driver's footwell can restrict the pedal travel or obstruct a depressed pedal. The operating and road safety of the vehicle is jeopardized. There is a risk of an accident.

Make sure that all objects in the vehicle are stowed correctly, and that they cannot enter the driver's footwell. Install the floormats securely and as specified in order to ensure sufficient clearance for the pedals. Do not use loose floormats and do not place floormats on top of one another.

**!** If the engine is switched off and equipment on the diagnostics connection is used, the starter battery may discharge.

Connecting equipment to the diagnostics connection can lead to emissions monitoring information being reset, for example. This may lead to the vehicle failing to meet the requirements of the next emissions test during the main inspection.

### Qualified specialist workshop

An authorized Mercedes-Benz Center is a qualified specialist workshop. It has the necessary specialist knowledge, tools and qualifications to correctly carry out the work required on your vehicle. This is especially the case for work relevant to safety.

Observe the notes in the Maintenance Booklet. Always have the following work carried out at an authorized Mercedes-Benz Center:

- work relevant to safety
- service and maintenance work
- repair work
- alterations, installation work and modifications
- work on electronic components

### Correct use

If you remove any warning stickers, you or others could fail to recognize certain dangers. Leave warning stickers in position.

Observe the following information when driving your vehicle:

- the safety notes in this manual
- technical data for the vehicle
- traffic rules and regulations
- laws and safety standards pertaining to motor vehicles

### Problems with your vehicle

If you should experience a problem with your vehicle, particularly one that you believe may affect its safe operation, we urge you to contact an authorized Mercedes-Benz Center immediately to have the problem diagnosed and rectified. If the problem is not resolved to your satisfaction, please discuss the problem again with an authorized Mercedes-Benz Center or, if nec-

essary, contact us at one of the following addresses.

### In the USA

Customer Assistance Center  
Mercedes-Benz USA, LLC  
3 Mercedes Drive  
Montvale, NJ 07645-0350

### In Canada

Customer Relations Department  
Mercedes-Benz Canada, Inc.  
98 Vanderhoof Avenue  
Toronto, Ontario M4G 4C9

## Reporting safety defects

USA only:

The following text is reproduced as required of all manufacturers under Title 49, Code of U.S. Federal Regulations, Part 575 pursuant to the National Traffic and Motor Vehicle Safety Act of 1966.

If you believe that your vehicle has a defect which could cause a crash or could cause injury or death, you should immediately inform the National Highway Traffic Safety Administration (NHTSA) in addition to notifying Mercedes-Benz USA, LLC.

If NHTSA receives similar complaints, it may open an investigation, and if it finds that a safety defect exists in a group of vehicles, it may order a recall and remedy campaign. However, NHTSA cannot become involved in individual problems between you, your dealer, or Mercedes-Benz USA, LLC.

To contact NHTSA, you may call the Vehicle Safety Hotline toll-free at 1-888-327-4236 (TTY: 1-800-424-9153); go to <http://www.safercar.gov>; or write to: Administrator, NHTSA, 400 Seventh Street, SW., Washington, DC 20590.

You can also obtain other information about motor vehicle safety from

<http://www.safercar.gov>

## Limited Warranty

**!** Observe the notes in this Operator's Manual regarding the correct operation of your vehicle and possible damage to the vehicle. Damage to the vehicle which is caused by violation

of these notes is not covered by the Mercedes-Benz implied warranty or the new or used-vehicle warranty.

## QR code for rescue card

The QR codes are secured in the fuel filler flap and on the opposite side on the B-pillar. In the event of an accident, rescue services can use the QR code to quickly find the appropriate rescue card for your vehicle. The current rescue card contains the most important information about your vehicle in a compact form, e.g. the routing of the electric cables.

You can find more information under [www.mercedes-benz.de/qrcode](http://www.mercedes-benz.de/qrcode).

## Data stored in the vehicle

### Data storage

A wide range of electronic components in your vehicle contain data memories.

These data memories temporarily or permanently store technical information about:

- the vehicle's operating state
- incidents
- malfunctions

In general, this technical information documents the state of a component, a module, a system or the surroundings.

This includes, for example:

- operating conditions of system components. For example, fluid levels
- the vehicle's status messages and those of its individual components, e.g. number of wheel revolutions/speed, deceleration in movement, lateral acceleration, accelerator pedal position
- malfunctions and defects in important system components, e.g. lights, brakes
- vehicle reactions and operating conditions in special driving situations, e.g. air bag deployment, intervention of stability control systems
- ambient conditions, e.g. outside temperature

This data is of an exclusively technical nature and can be used to:

- assist in recognizing and rectifying malfunctions and defects
- analyze vehicle functions, e.g. after an accident
- optimize vehicle functions

The data cannot be used to trace the vehicle's movements.

When your vehicle is serviced, technical information can be read from the event data memory and malfunction data memory.

Services include, for example:

- repair services
- service processes
- warranties
- quality assurance

The vehicle is read out by employees of the service network (including the manufacturer) using special diagnostic testers. More detailed information is obtained from it, if required.

After a malfunction has been rectified, the information is deleted from the malfunction memory or is continually overwritten.

When operating the vehicle, situations are conceivable in which this technical data, in connection with other information (if necessary, under consultation with an authorized expert), could be traced to a person.

Examples include:

- accident reports
- damage to the vehicle
- witness statements

Further additional functions that have been contractually agreed upon with the customer allow certain vehicle data to be conveyed by the vehicle as well. The additional functions include, for example, vehicle location in case of an emergency.

### COMAND/mbrace

If the vehicle is equipped with COMAND or mbrace, additional data about the vehicle's operation, the use of the vehicle in certain situations, and the location of the vehicle may be compiled through COMAND or the mbrace system.

For additional information, please refer to the COMAND User Manual or Digital Operator's

Manual and/or the mbrace Terms and Conditions.

### Event data recorders

This vehicle is equipped with an event data recorder (EDR). This vehicle is equipped with an event data recorder (EDR). The main purpose of an EDR is to record, in certain crash or near crash-like situations, such as an air bag deployment or hitting a road obstacle, data that will assist in understanding how a vehicle's systems performed. The EDR is designed to record data related to vehicle dynamics and safety systems for a short period of time, typically 30 seconds or less.

The EDR in this vehicle is designed to record such data as:

- How various systems in your vehicle were operating
- Whether or not the driver and passenger safety belts were buckled/fastened
- How far (if at all) the driver was depressing the accelerator and/or brake pedal and
- How fast the vehicle was traveling

These data can help provide a better understanding of the circumstances in which crashes and injuries occur. NOTE: EDR data are recorded by your vehicle only if a non-trivial crash situation occurs; no data are recorded by the EDR under normal driving conditions and no personal data (e.g. name, gender, age and crash location) are recorded. However, other parties, such as law enforcement could combine the EDR data with the type of personally identifying data routinely acquired during a crash investigation.

Access to the vehicle and/or the EDR is needed to read data that is recorded by an EDR, and special equipment is required. In addition to the vehicle manufacturer, other parties that have the special equipment, such as law enforcement, can read the information by accessing the vehicle or the EDR.

EDR data may be used in civil and criminal matters as a tool in accident reconstruction, accident claims and vehicle safety. Since the Crash Data Retrieval CDR tool that is used to extract data from the EDR is commercially available, Mercedes-Benz USA, LLC ("MBUSA") expressly disclaims any and all liability arising from the extraction of this information by unauthorized Mercedes-Benz personnel.

MBUSA will not share EDR data with others without the consent of the vehicle owners or, if the vehicle is leased, without the consent of the lessee. Exceptions to this representation include responses to subpoenas by law enforcement; by federal, state or local government; in connection with or arising out of litigation involving MBUSA or its subsidiaries and affiliates; or, as required by law.

Warning: The EDR is a component of the Restraint System Module. Tampering with, altering, modifying or removing the EDR component may result in a malfunction of the Restraint System Module and other systems.

State laws or regulations regarding EDRs that conflict with federal regulation are pre-empted. This means that in the event of such conflict, the federal regulation governs. As of February 2013, 13 states have enacted laws relating to EDRs.

- SIRIUS® is a registered trademark of Sirius XM Radio Inc.
- HD Radio™ is a registered trademark of iBiquity Digital Corporation.
- Gracernote® is a registered trademark of Gracernote, Inc.
- ZAGAT Survey® and related brands are registered trademarks of Zagat Survey, LLC.

## Information on copyright

### Free and open-source software

Information on license for free and open-source software used in your vehicle can be found on the data carrier in your vehicle document wallet and, including updates, on the following website:

<http://www.mercedes-benz.com/opensource>

### Registered trademarks



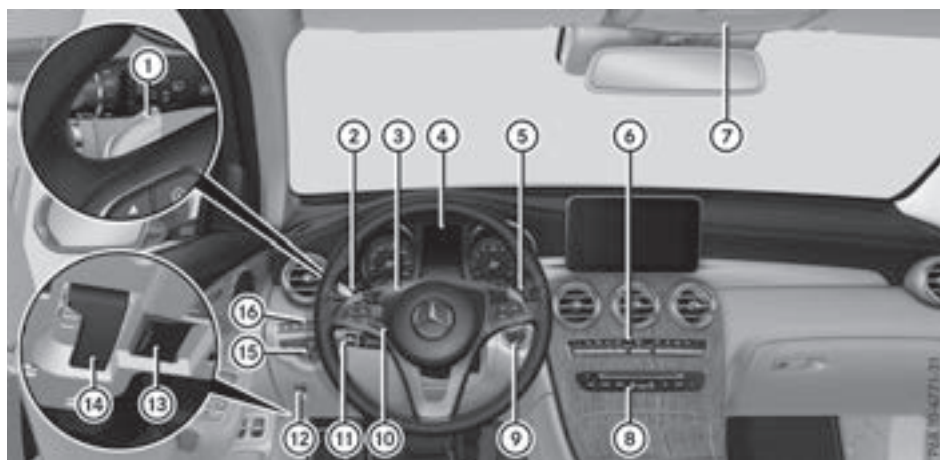

Registered trademarks:

- Bluetooth® is a registered trademark of Bluetooth SIG Inc.
- DTS™ is a registered trademark of DTS, Inc.
- Dolby® and MLP™ are registered trademarks of DOLBY Laboratories.
- BabySmart™, ESP® and PRE-SAFE® are registered trademarks of Daimler AG.
- HomeLink® is a registered trademark of Johnson Controls.
- iPod® and iTunes® are registered trademarks of Apple Inc.
- Burmester® is a registered trademark of Burmester Audiosysteme GmbH.
- Microsoft® and Windows media® are registered trademarks of Microsoft Corporation.

## Cockpit



	Function	Page
①	Steering wheel paddle shifters	152
②	Combination switch	113
③	Horn	
④	Instrument cluster	37
⑤	DIRECT SELECT lever	146
⑥	Climate control systems	124
⑦	Overhead control panel	42
⑧	Control panel for multimedia system and vehicle functions	39
⑨	Ignition lock	136
	Start/Stop button	137
⑩	Adjusts the steering wheel	105
⑪	Cruise control lever	169
⑫	Electric parking brake	159

	Function	Page
⑬	Diagnostics connection	32
⑭	Opens the hood	318
⑮	Light switch	112
⑯	Control panel for:	
	 Activating Distance Pilot DISTRONIC with Steering Pilot	177
	 Switching on Active Lane Keeping Assist	212
	 Deactivating Parking Assist PARKTRONIC	193
	 Switching on the 360° camera	199
	Switching on the head-up display	223
	Vehicles without a driver assistance system: map/coin holder	

## Instrument cluster

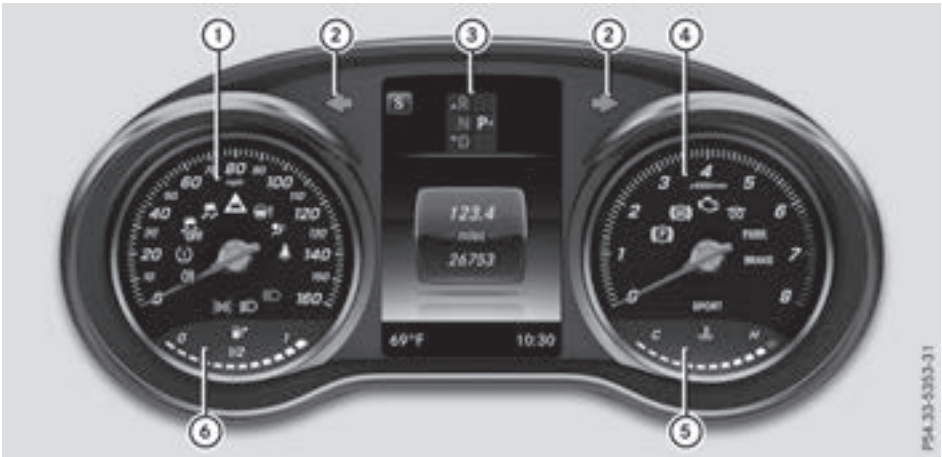

	Function	Page		Function	Page
①	Speedometer with segments	220	⑤	ABS malfunctioning	271
	Warning and indicator lamps:			Check Engine	274
	ESP® OFF	271		This indicator lamp has no function	
	ESP®	271		Electric parking brake applied (red)	274
	Distance warning	277		USA only	
	Power steering assistance malfunctioning	279		Canada only	
	Restraint system	45		Brakes (red)	270
	Seat belt not fastened	269		USA only	
	High-beam headlamps	113		Canada only	
	Low-beam headlamps	113		SPORT handling mode (Mercedes-AMG vehicles)	273
	Parking lamps	113			
	Rear fog lamp	113			
	Tire pressure monitor	278			
	②	Turn signals		113	
③	Multifunction display	222			
④	Tachometer	221			
	Warning and indicator lamps:				
	Electric parking brake (yellow)	274			

**i** Information on displaying the outside temperature in the multifunction display can be

found under "Outside temperature display" (> page 221).



Multifunction steering wheel

At a glance



	Function	Page
①	Multifunction display	222
②	Multimedia system display	
③	Rejects or ends a call Makes or accepts a call Further telephone functions Adjusts volume Mute Switches on voice-operated control for navigation or the Voice Control System	230

	Function	Page
④	Opens the menu list Selects a menu Confirms the selection Back Operates the on-board computer Switches on voice-operated control for navigation or the Voice Control System	221

**i** Vehicles with Audio 20 multimedia system: you can find further information

- on the multimedia system in the Digital Operator's Manual
- on voice-controlled navigation in the manufacturer's operating instructions

**i** Vehicles with COMAND multimedia system: you can find further information



- on the multimedia system in the Digital Operator's Manual
- on the single DVD drive in the Digital Operator's Manual
- on the Voice Control System in the separate operating instructions





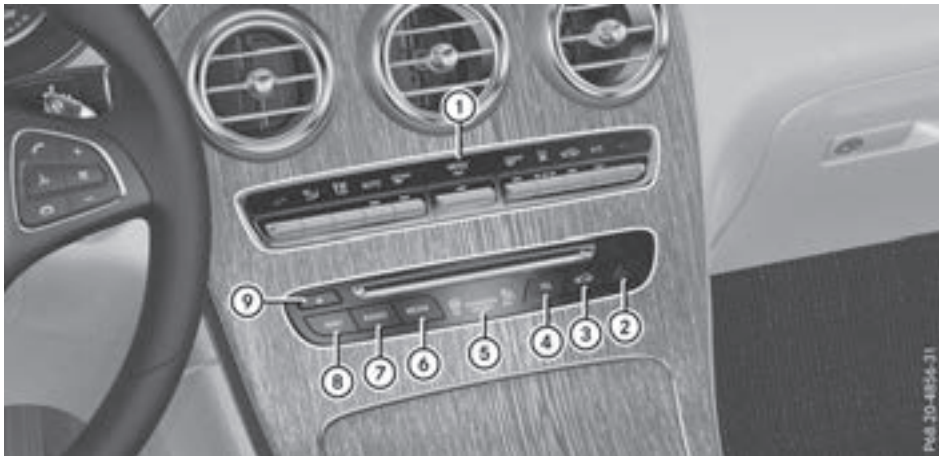

## Center console

## Center console, upper section









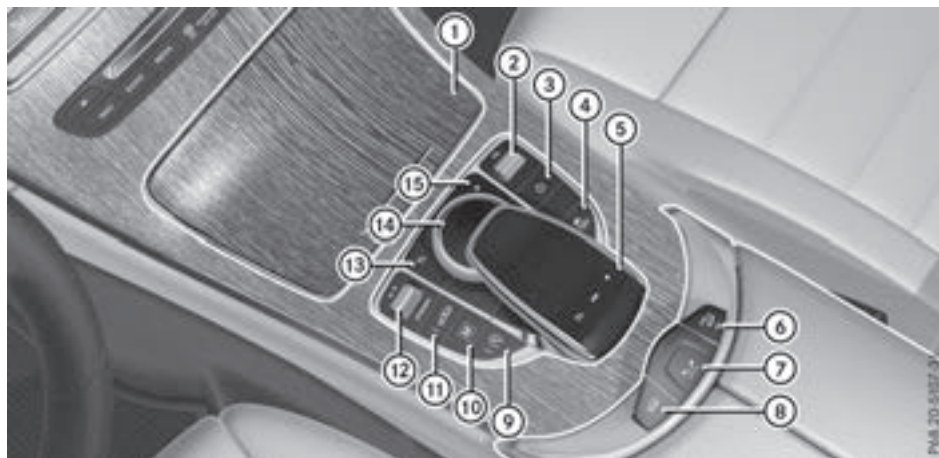

	Function	Page
①	Climate control systems	124
②	 Hazard warning lamps	114
③	 Vehicle functions/ system settings button (see Digital Operator's Manual)	
④	 Telephone button (see Digital Operator's Manual)	
⑤	PASSENGER AIRBAG indica- tor lamps	45
	ATA indicator lamp	77

	Function	Page
⑥	 Media button (see Digi- tal Operator's Manual)	
⑦	 Radio button (see Digi- tal Operator's Manual)	
⑧	 Navigation button (see Digital Operator's Manual)	
⑨	 Inserts or ejects a CD or DVD (see Digital Opera- tor's Manual)	

## Center console, lower section (except Mercedes-AMG vehicles)



	Function	Page
①	Stowage compartment	290
	Ashtray	304
	Cigarette lighter	304
	Socket	305
	Cup holder	302
②	Adjusts the volume	281
	Switches the sound on or off	281
③	 Switches the multimedia system on/off	281
④	 Activates/deactivates ESP®	70
⑤	Touchpad	282
⑥	 DSR (Downhill Speed Regulation)	180
⑦	Opens stowage compartment with Media Interface	290

	Function	Page
⑧	Activates/deactivates the off-road program	181
⑨	 ECO start/stop function	140
⑩	 Manual gearshifting (permanent setting)	152
⑪	 Adjusts the vehicle level (AIR BODY CONTROL)	185
	 Deactivates Parking Assist PARKTRONIC	193
⑫	DYNAMIC SELECT switch	144
⑬	 Back button	281
⑭	Controller	281
⑮	 Favorites button	283



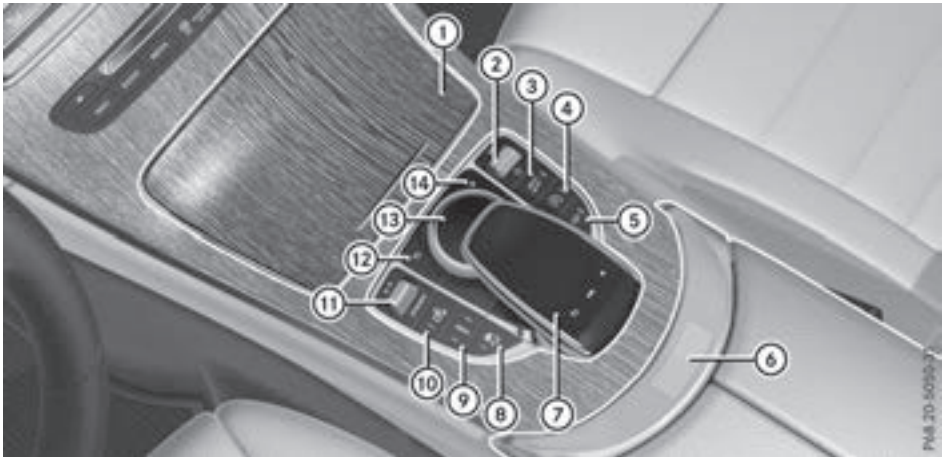



## Center console, lower section (Mercedes-AMG vehicles)

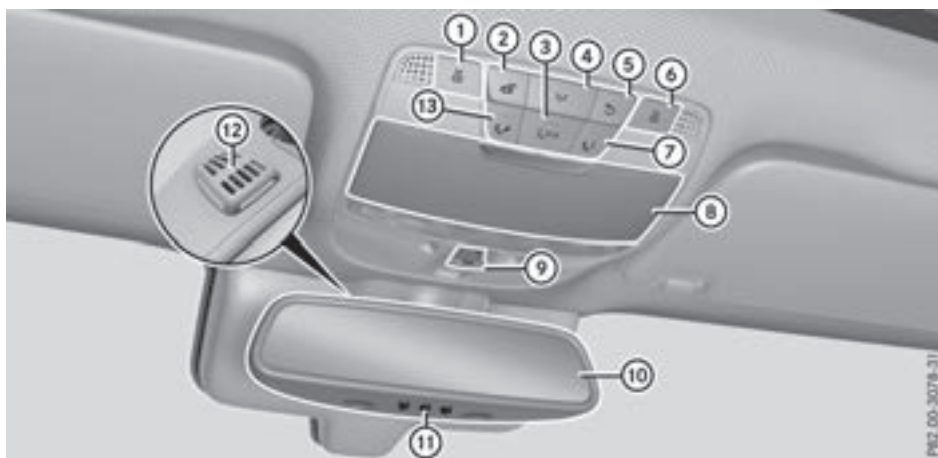



	Function	Page		Function	Page	
①	Stowage compartment	290	⑥	Stowage compartment with Media Interface	290	
	Ashtray	304		⑦	Touchpad	282
	Cigarette lighter	304			⑧	Activates/deactivates ESP®
	Socket	305		Activates/deactivates SPORT handling mode		71
	Cup holder	302		⑨	AMG sports suspension based on AIR BODY CONTROL	186
②	Adjusts the volume	281	⑩		Manual gearshifting (permanent setting)	152
	Switches the sound on or off	281		⑪	DYNAMIC SELECT switch	144
③	Vehicles with AMG Performance exhaust system:		⑫		Back button	281
	Switches the multimedia system on/off	281		⑬	Controller	281
④	AMG performance exhaust system can be selected	142	⑭		Favorites button	283
	Switches the multimedia system on/off	281				
④	ECO start/stop function	140				
⑤	Adjusts the vehicle level (AIR BODY CONTROL)	185				

## Overhead control panel



	Function	Page
①	 Switches the left-hand reading lamp on/off	116
②	 Switches the automatic interior lighting control on/off	116
③	 SOS button (mbrace system)	308
④	 Switches the front interior lighting on/off	116
⑤	 Switches the rear interior lighting on/off	116
⑥	 Switches the right-hand reading lamp on/off	116
⑦	 Info call button (mbrace system)	310

	Function	Page
⑧	Eyeglasses compartment	291
⑨	 Operates the panorama roof with power tilt/sliding panel	95
	Operates the roller sunblinds	96
⑩	Rear-view mirror Automatic anti-glare	108
⑪	Buttons for the garage door opener	315
⑫	Microphone for mbrace system, telephone and the Voice Control System, see the separate operating instructions	
⑬	 Breakdown assistance call button (mbrace system)	309

## Door control panel

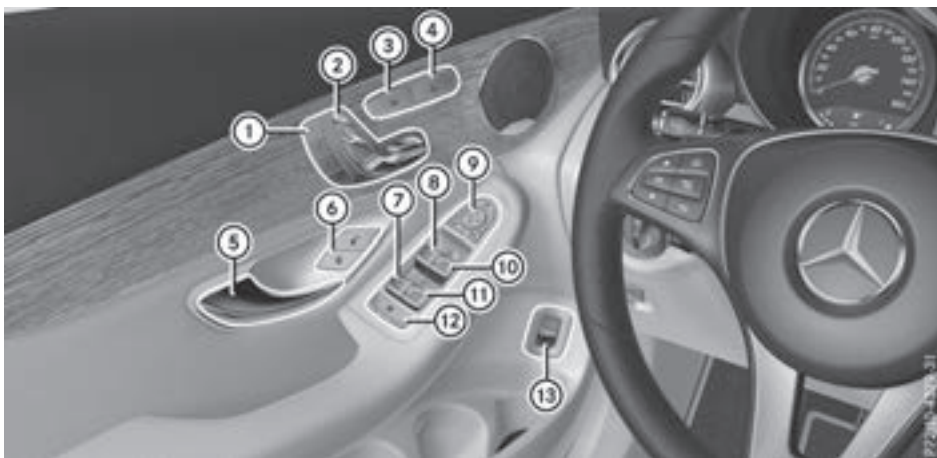

	Function	Page
①	Stores settings for the seat, exterior mirrors and steering column	110
②	Adjusts the seats electrically	101
③	Seat heating	103
④	Seat ventilation	104
⑤	Opens the door	84
⑥	Unlocks/locks the vehicle	84
⑦	Opens/closes the rear left side window	91
⑧	Opens/closes the left side window	91

	Function	Page
⑨	Adjusts and folds the exterior mirrors out/in electrically	107
⑩	Opens/closes the right side window	91
⑪	Opens/closes the rear right side window	91
⑫	Override feature for the controls in the rear compartment	65
⑬	Opens/closes the tailgate	89

## Panic alarm



- ▶ **To arm:** press and hold the **PANIC** button ① for approximately one second. A visual and audible alarm is triggered if the alarm system is armed.
- ▶ **To disarm:** press the **PANIC** button ① again.
- or
- ▶ Insert the SmartKey into the ignition lock.
- or
- ▶ Press the Start/Stop button.  
The SmartKey must be in the vehicle.

## Occupant safety

### Introduction to the restraint system

The restraint system can reduce the risk of vehicle occupants coming into contact with parts of the vehicle's interior in the event of an accident. The restraint system can also reduce the forces to which vehicle occupants are subjected during an accident.

The restraint system comprises:

- Seat belt system
- Air bags
- Child restraint system
- Child seat securing systems

The components of the restraint system work in conjunction with each other. They can only deploy their protective function if, at all times, all vehicle occupants:

- have fastened their seat belts correctly (▷ page 47)
- have the seat and head restraint adjusted properly (▷ page 99)

As the driver, you also have to make sure that the steering wheel is adjusted correctly. Observe the information relating to the correct driver's seat position (▷ page 99).

You also have to make sure that an air bag can inflate properly if deployed (▷ page 49).

An air bag supplements a correctly worn seat belt. As an additional safety device, the air bag increases the level of protection for vehicle occupants in the event of an accident. For example, if, in the event of an accident, the protection offered by the seat belt is sufficient, the air bags are not deployed. When an accident occurs, only the air bags that increase protection in that particular accident situation are deployed. However, seat belts and air bags generally do not protect against objects penetrating the vehicle from the outside.

Information on restraint system operation can be found under "Triggering of the Emergency Tensioning Devices and air bags" (▷ page 56).

See "Children in the vehicle" for information on children traveling with you in the vehicle as well as on child restraint systems (▷ page 60).

### Important safety notes

#### WARNING

Modifications to the restraint system may cause it to no longer work as intended. The restraint system may then not perform its intended protective function and may fail in an accident or trigger unexpectedly, for example. This poses an increased risk of injury or even fatal injury.

Never modify parts of the restraint system. Never tamper with the wiring, the electronic components or their software.

If it is necessary to modify components of the restraint system to accommodate a person with disabilities, contact an authorized Mercedes-Benz Center for details. USA only: for further information contact our Customer Assistance Center at 1-800 FOR-MERCEDES (1-800-367-6372).

Mercedes-Benz recommends that you only use driving aids which have been approved specifically for your vehicle by Mercedes-Benz.

## Restraint system warning lamp

The functions of the restraint system are checked after the ignition is switched on and at regular intervals while the engine is running. Therefore, malfunctions can be detected in good time.

The  restraint system warning lamp on the instrument cluster lights up when the ignition is switched on. It goes out no later than a few seconds after the vehicle is started. The components of the restraint system are in operational readiness.

A malfunction has occurred if the  restraint system warning lamp:

- does not light up after the ignition is switched on
- does not go out after a few seconds with the engine running
- lights up again while the engine is running



### WARNING

If the restraint system is malfunctioning, restraint system components may be triggered unintentionally or may not deploy as intended during an accident. This can affect for example the Emergency Tensioning Device or the air bag. This poses an increased risk of injury or even fatal injury.

Have the restraint system checked and repaired in a qualified specialist workshop as soon as possible.

## PASSENGER AIR BAG indicator lamp



PASSENGER AIR BAG ON indicator lamp  and PASSENGER AIR BAG OFF indicator lamp  are part of the Occupant Classification System (OCS).

The indicator lamps display the status of the front-passenger front air bag.

- PASSENGER AIR BAG ON lights up for 60 seconds, subsequently both indicator lamps are off (PASSENGER AIR BAG ON and OFF): the front-passenger front air bag is able to deploy in the event of an accident.
- PASSENGER AIR BAG OFF lights up: the front-passenger front air bag is deactivated. It will then not be deployed in the event of an accident.

If the PASSENGER AIR BAG ON indicator lamp is off, only the PASSENGER AIR BAG OFF indicator lamp shows the status of the front-passenger front air bag. The PASSENGER AIR BAG OFF indicator lamp may be lit continuously or be off. Depending on the person in the front-passenger seat, the front-passenger front air bag must either be deactivated or enabled; see the following points. You must make sure of this both before and during a journey.

### • Children in a child restraint system:

whether the front-passenger front air bag is enabled or deactivated depends on the installed child restraint system, and the age and size of the child. Therefore, be sure to observe the notes on the "Occupant Classification System (OCS)" ([▷ page 52](#)) and on "Children in the vehicle" ([▷ page 60](#)). There you will also find instructions on rearward and forward-facing child restraint systems on the front-passenger seat.

- **All other persons:** depending on the classification of the person in the front-passenger seat, the front-passenger front air bag is enabled or deactivated ([▷ page 52](#)). Be sure to observe the notes on "Seat belts" ([▷ page 45](#)) and "Air bags" ([▷ page 49](#)). There you can also find information on the correct seat position.

## Seat belts

### Introduction

Seat belts are the most effective means of restricting the movement of vehicle occupants in the event of an accident or the vehicle rolling over. This reduces the risk of vehicle occupants coming into contact with parts of the vehicle interior or being ejected from the vehicle. Furthermore, the seat belt helps to keep the vehicle



occupant in the best position in relation to the air bag.

The seat belt system comprises:

- Seat belts
- Emergency Tensioning Devices for the front seat belts and the outer seat belts in the rear
- Seat belt force limiters for the front seat belts and the outer seat belts in the rear

If the seat belt is pulled out of the belt outlet quickly or with a jerky movement, the belt retractor locks. The belt strap cannot be extracted any further.

The Emergency Tensioning Device tightens the seat belt in an accident, pulling the belt close against the body. However it does not pull the vehicle occupant back in the direction of the backrest.

The Emergency Tensioning Device does not correct an incorrect seat position or the routing of an incorrectly fastened seat belt.

When triggered, a seat belt force limiter helps to reduce the force exerted by the seat belt on the vehicle occupant.

The seat belt force limiters for the front seats are synchronized with the front air bags, which absorb part of the deceleration force. This can reduce the force exerted on the vehicle occupants during an accident.

**!** If the front-passenger seat is not occupied, do not engage the seat belt tongue in the buckle on the front-passenger seat. Otherwise, in the event of an accident the Emergency Tensioning Device and the side impact air bag, in addition to other systems, may be triggered and have to be replaced.

### Important safety notes

The use of seat belts and child restraint systems is required by law in:

- all 50 states
- the U.S. territories
- the District of Columbia
- all Canadian provinces

Even where this is not required by law, all vehicle occupants should correctly fasten their seat belts before starting the journey.

#### WARNING

If the seat belt is not worn correctly, it cannot perform its intended protective function. An

incorrectly fastened seat belt can also cause injuries, for example, in the event of an accident or when braking or changing direction abruptly. This poses an increased risk of injury or even fatal injury.

Always ensure that all vehicle occupants have their seat belts fastened correctly and are sitting properly.

The components of the restraint system work in conjunction with each other. They can only deploy their protective function if, at all times, all vehicle occupants:

- have fastened their seat belts correctly (▷ page 47)
- have the seat and head restraint adjusted properly (▷ page 99)

#### WARNING

The seat belt does not offer the intended level of protection if you have not moved the backrest to an almost vertical position. When braking or in the event of an accident, you could slide underneath the seat belt and sustain abdomen or neck injuries, for example. This poses an increased risk of injury or even fatal injury.

Adjust the seat properly before beginning your journey. Always ensure that the backrest is in an almost vertical position and that the shoulder section of your seat belt is routed across the center of your shoulder.

#### WARNING

Persons less than 5 ft (1.50 m) tall cannot wear the seat belt correctly without an additional and suitable restraint system. If the seat belt is not worn correctly, it cannot perform its intended protective function. An incorrectly fastened seat belt can also cause injuries, for example, in the event of an accident or when braking or changing direction abruptly. This poses an increased risk of injury or even fatal injury.

For this reason, always secure persons under 5 ft (1.50 m) tall in suitable additional restraint systems.



If a child younger than twelve years old and under 5 ft (1.50 m) in height is traveling in the vehicle:

- always secure the child in a child restraint system suitable for this Mercedes-Benz vehicle. The child restraint system must be appropriate to the age, weight and size of the child
- always observe the instructions and safety notes on "Children in the vehicle" (▷ page 60) in addition to the child restraint system manufacturer's installation and operating instructions
- always observe the instructions and safety notes on the "Occupant classification system (OCS)" (▷ page 52)

### WARNING

The seat belts may not perform their intended protective function if:

- they are damaged, modified, extremely dirty, bleached or dyed
- the seat belt buckle is damaged or extremely dirty
- the Emergency Tensioning Devices, belt anchorages or inertia reels have been modified.

Seat belts may be damaged in an accident, although the damage may not be visible, e.g. due to splinters of glass. Modified or damaged seat belts may tear or fail, e.g. in an accident. Modified Emergency Tensioning Devices could accidentally trigger or fail to deploy when necessary. This poses an increased risk of injury or even fatal injury.

Never modify the seat belts, Emergency Tensioning Devices, belt anchorages and inertia reels. Make sure that the seat belts are undamaged, not worn out and clean. Following an accident, have the seat belts checked immediately at a qualified specialist workshop.

Only use seat belts that have been approved for your vehicle by Mercedes-Benz.

**AMG Performance seat:** this seat is designed for the standard three-point seat belt. If you install another multi-point seat belt, e.g. sport or racing seat belts, the restraint system cannot provide the best level of protection.

### WARNING

If you feed seat belts through the opening in the seat backrest, the seat backrest may be damaged or may even break in the event of an accident. This poses an increased risk of injury or even fatal injury.

Only use the standard three-point seat belt. Never modify the seat belt system.

## Proper use of the seat belts

Observe the safety notes on the seat belt (▷ page 46).

All vehicle occupants must be wearing the seat belt correctly before beginning the journey. Also make sure that all vehicle occupants are always wearing the seat belt correctly while the vehicle is in motion.

When fastening the seat belt, always make sure that:

- the seat belt buckle tongue is inserted only into the belt buckle belonging to that seat
- the seat belt is pulled tight across your body  
Avoid wearing bulky clothing, e.g. a winter coat.
- the seat belt is not twisted  
Only then can the forces which occur be distributed over the area of the belt.
- the shoulder section of the belt is routed across the center of your shoulder  
The shoulder section of the seat belt should not touch your neck or be routed under your arm or behind your back. Where possible, adjust the seat belt to the appropriate height.
- the lap belt is taut and passes across your lap as low down as possible  
The lap belt must always be routed across your hip joints and not across your abdomen. This applies particularly to pregnant women. If necessary, push the lap belt down to your hip joint and pull it tight using the shoulder section of the belt.
- the seat belt is not routed across sharp, pointed or fragile objects  
If you have such items located on or in your clothing, e.g. pens, keys or eyeglasses, store these in a suitable place.
- only one person is using a seat belt  
Infants and children must never travel sitting on the lap of a vehicle occupant. In the event

of an accident, they could be crushed between the vehicle occupant and seat belt.

- objects are never secured with a seat belt if the seat belt is also being used by one of the vehicle's occupants

Also ensure that there are never objects between a person and the seat, e.g. cushions.

Seat belts are only intended to secure and restrain vehicle occupants. Always observe the "Loading guidelines" for securing objects, luggage or loads (▷ page 290).

### Fastening and adjusting the seat belts

Observe the safety notes on the seat belt (▷ page 46) and the notes on correct use of seat belts (▷ page 47).

If the center rear seat belt is being used, also observe the information about the seat belt for the center rear seat (▷ page 48).

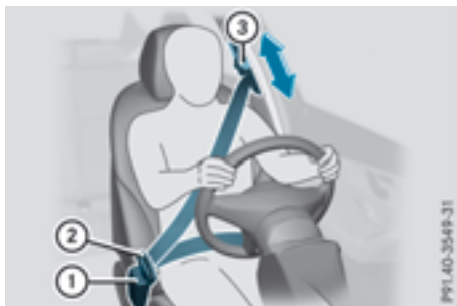

Basic illustration

- ▶ Adjust the seat (▷ page 99). The seat backrest must be in an almost upright position.
- ▶ Pull the seat belt smoothly from the belt outlet and engage belt tongue ② into belt buckle ①. The seat belt on the driver's seat and the front-passenger seat may be tightened automatically, see "Belt adjustment" (▷ page 48).
- ▶ If necessary, pull up on the shoulder section of the seat belt to tighten the belt across your body.

The shoulder section of the seat belt must always be routed across the center of the shoulder. Adjust the belt outlet if necessary.

- ▶ **To raise:** slide the belt outlet up. The belt outlet will engage in various positions.
- ▶ **To lower:** hold belt outlet release ③ and slide the belt outlet down.
- ▶ Let go of belt outlet release ③ in the desired position and make sure that the belt outlet engages.

All seat belts except the driver's seat belt are equipped with a special seat belt retractor to securely fasten child restraint systems in the vehicle. Further information can be found under "Special seat belt retractor" (▷ page 60).

### Seat belt for the center rear seat

If the left-hand rear seat backrest is folded down and back up again, the rear center seat belt may lock. The seat belt can then not be pulled out.

- ▶ **To release the rear center seat belt:** pull the seat belt out approximately 1 in (25 mm) at the belt outlet on the backrest and then release it again. The seat belt is retracted and released.

### Releasing seat belts

- ❗ Make sure that the seat belt is fully rolled up. Otherwise, the seat belt or belt tongue will be trapped in the door or in the seat mechanism. This could damage the door, the door trim panel and the seat belt. Damaged seat belts can no longer fulfill their protective function and must be replaced. Visit a qualified specialist workshop.
- ▶ Press the release button in the belt buckle, hold the belt tongue firmly and guide the belt back.

### Seat belt adjustment

The belt adjustment is a convenience function integrated into PRE-SAFE®. With this function, the driver's and front-passenger seat belts are adjusted to the upper body of the vehicle occupant.

The seat belt strap will slightly tighten if:



- the belt tongue is inserted into the buckle and
- the ignition is switched on

The seat belt adjustment will apply a certain tightening force if any slack is detected between the vehicle occupant and the seat belt. Do not grab hold of the seat belt.

You can switch the seat belt adjustment on and off using the multimedia system. Information on switching the seat belt adjustment on and off can be found in the Digital Operating Instructions.

## Belt warning for the driver and front passenger

The  seat belt warning lamp in the instrument cluster is a reminder that all vehicle occupants must wear their seat belts. It may light up continuously or flash. In addition, there may be a warning tone.

Regardless of whether the driver's seat belt has already been fastened, the  seat belt warning lamp lights up for six seconds each time the engine is started. If the front doors are closed and the driver's or front-passenger seat belt has not been fastened, the  seat belt warning lamp lights up again after the six seconds. As soon as the driver's and front-passenger seat belts are fastened or a front door is opened again, the  seat belt warning lamp goes out. If the driver's seat belt is not fastened after the engine is started, an additional warning tone will sound. The warning tone switches off after six seconds or once the driver's seat belt is fastened.

If the vehicle's speed exceeds 15 mph (25 km/h) once and the driver's and front-passenger seat belts are not fastened, a warning tone sounds. A warning tone also sounds with increasing intensity for 60 seconds or until the driver or front passenger have fastened their seat belts.

If the driver or front passenger unfasten their seat belts during the journey, the seat belt warning is activated again.

## Air bags

### Introduction

The installation point of an air bag can be recognized by the AIRBAG marking.

An air bag complements the correctly fastened seat belt. It is no substitute for the seat belt. The

air bag provides additional protection in applicable accident situations.

Not all air bags are deployed in an accident. The different air bag systems function independently from one another (▷ page 56).

However, no system available today can completely eliminate injuries and fatalities.

It is also not possible to rule out a risk of injury caused by an air bag due to the high speed at which the air bag must be deployed.

## Important safety notes

### WARNING

If you do not sit in the correct seat position, the air bag cannot protect as intended and could even cause additional injury when deployed. This poses an increased risk of injury or even fatal injury.

To avoid hazardous situations, always make sure that all of the vehicle's occupants:

- have fastened their seat belts correctly, including pregnant women
- are sitting correctly and maintain the greatest possible distance to the air bags
- follow the following instructions

Always make sure that there are no objects between the air bag and the vehicle's occupants.

- Adjust the seats properly before beginning your journey. Always make sure that the seat is in an almost upright position. The center of the head restraint must support the head at about eye level.
- Move the driver's and front-passenger seats as far back as possible. The driver's seat position must allow the vehicle to be driven safely.
- Only hold the steering wheel on the outside. This allows the air bag to be fully deployed.
- Always lean against the backrest while driving. Do not lean forward or lean against the door or side window. You may otherwise be in the deployment area of the air bags.
- Always keep your feet in the footwell in front of the seat. Do not put your feet on the dash-

board, for example. Your feet may otherwise be in the deployment area of the air bag.

- For this reason, always secure persons less than 5 ft (1.50 m) tall in suitable restraint systems. Up to this height, the seat belt cannot be worn correctly.

**If a child is traveling in your vehicle, also observe the following notes:**

- Always secure children under twelve years of age and less than 5 ft (1.50 m) tall in suitable child restraint systems.
- Child restraint systems should be installed on the rear seats.
- Only secure a child in a rearward-facing child restraint system on the front-passenger seat when the front-passenger front air bag is deactivated. If the PASSENGER AIR BAG OFF indicator lamp is permanently lit, the front-passenger front air bag is deactivated (▷ page 45).
- Always observe the instructions and safety notes on the "Occupant Classification System (OCS)" (▷ page 52) and on "Children in the vehicle" (▷ page 60) in addition to the child restraint system manufacturer's installation and operating instructions.

**Objects in the vehicle interior may prevent an air bag from functioning correctly.** Before starting your journey and to avoid risks resulting from the speed of the air bag as it deploys, make sure that:

- there are no people, animals or objects between the vehicle occupants and an air bag
- there are no objects between the seat, door and B-pillar
- there are no hard objects, e.g. coat hangers, hanging on the grab handles or coat hooks
- no accessories, such as cup holders, are attached to the vehicle within the deployment area of an air bag, e.g. to doors, side windows, rear side trim or side walls
- no heavy, sharp-edged or fragile objects are in the pockets of your clothing. Store such objects in a suitable place

**⚠ WARNING**

If you modify the air bag cover or affix objects such as stickers to it, the air bag can no longer function correctly. There is an increased risk of injury.

Never modify an air bag cover or affix objects to it.

**⚠ WARNING**

Sensors to control the air bags are located in the doors. Modifications or work not performed correctly to the doors or door paneling, as well as damaged doors, can lead to the function of the sensors being impaired. The air bags might therefore not function properly anymore. Consequently, the air bags cannot protect vehicle occupants as they are designed to do. There is an increased risk of injury.

Never modify the doors or parts of the doors. Always have work on the doors or door paneling carried out at a qualified specialist workshop.

### Front air bags

- ❗ Do not place heavy objects on the front-passenger seat. This could cause the system to identify the seat as being occupied. In the event of an accident, the restraint systems on the front-passenger side may be triggered and have to be replaced.



Driver's air bag ① deploys in front of the steering wheel. Front-passenger front air bag ② deploys in front of and above the glove box.

When deployed, the front air bags offer additional head and thorax protection for the occupants in the front seats.

The PASSENGER AIR BAG OFF indicator lamp informs you about the status of the front-passenger front air bag (▷ page 45).

The front-passenger front air bag will only deploy if:

- the system, based on the OCS weight sensor readings, detects that the front-passenger seat is occupied (▷ page 52). The PASSENGER AIR BAG OFF indicator lamp is not lit (▷ page 52)
- the restraint system control unit predicts a high accident severity

### Driver's knee bag



Driver's knee bag ① deploys under the steering column. The driver's knee bag is deployed together with the front air bag.

The driver's knee bag offers additional thigh, knee and lower leg protection for the occupant in the driver's seat.

### Side impact air bags

#### WARNING

Unsuitable seat covers can obstruct or prevent deployment of the air bags integrated into the seats. Consequently, the air bags cannot protect vehicle occupants as they are designed to do. In addition, the operation of the occupant classification system (OCS) could be adversely affected. This poses an increased risk of injury or even fatal injury.

You should only use seat covers that have been approved for the respective seat by Mercedes-Benz.

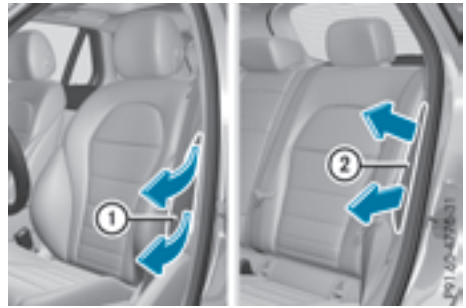

Front side impact air bags ① and rear side impact air bags ② deploy next to the outer bolster of the seat backrest.

When deployed, the side impact air bag offers additional thorax protection. However, it does not protect the:

- Head
- Neck
- Arms

If the restraint system control unit detects a side impact, the side impact air bag is deployed on the side on which the impact occurs.

The side impact air bag on the front-passenger side deploys under the following conditions:

- the OCS system detects that the front-passenger seat is occupied or
- the seat belt buckle tongue is engaged in the belt buckle of the front-passenger seat

If the belt tongue is engaged in the belt buckle, the side impact air bag on the front-passenger side deploys if an appropriate accident situation occurs. In this case, deployment is independent of whether the front-passenger seat is occupied or not.

### Window curtain air bags



Window curtain air bags ① are integrated into the side of the roof frame and deployed in the area from the A-pillar to the C-pillar.

When deployed, the window curtain air bag enhances the level of protection for the head. However, it does not protect the chest or arms. If the restraint system control unit detects a side impact, the window curtain air bag is deployed on the side on which the impact occurs.

If the system determines that they can offer additional protection to that provided by the seat belt, a window curtain air bag may be deployed in other accident situations (▷ page 56).

## Occupant Classification System (OCS)

### Introduction

The Occupant Classification System (OCS) categorizes the person in the front-passenger seat. Depending on that result, the front-passenger front air bag is either enabled or deactivated.

The system does not deactivate:

- the side impact air bag
- the window curtain air bag
- the Emergency Tensioning Devices

### Requirements

To be classified correctly, the front passenger must sit:

- with the seat belt fastened correctly
- in an almost upright position with their back against the seat backrest
- with their feet resting on the floor, if possible

If the front passenger does not observe these conditions, OCS may produce a false classification, e.g. because the front passenger:

- transfers their weight by supporting themselves on a vehicle armrest
- sits in such a way that their weight is raised from the seat cushion

If it is absolutely necessary to install a child restraint system on the front-passenger seat, be sure to observe the correct positioning of the child restraint system. Never place objects under or behind the child restraint system, e.g. a cushion. Fully retract the seat cushion length. The entire base of the child restraint system

must always rest on the seat cushion of the front-passenger seat. The backrest of the forward-facing child restraint system must lie as flat as possible against the backrest of the front-passenger seat.

The child restraint system must not touch the roof or be subjected to a load by the head restraint. Adjust the angle of the seat backrest and the head restraint position accordingly.

Only then can OCS be guaranteed to function correctly. Always observe the child restraint system manufacturer's installation and operating instructions.

## Occupant Classification System operation (OCS)



- ① PASSENGER AIR BAG ON indicator lamp
- ② PASSENGER AIR BAG OFF indicator lamp

The indicator lamps inform you whether the front-passenger front air bag is deactivated or enabled.

- ▶ Press the Start/Stop button once or twice, or turn the SmartKey to position ① or ② in the ignition lock.

The system carries out self-diagnostics.

The PASSENGER AIR BAG OFF and PASSENGER AIR BAG ON indicator lamps must light up simultaneously for approximately six seconds.

The indicator lamps display the status of the front-passenger front air bag.

- PASSENGER AIR BAG ON lights up for 60 seconds, subsequently both indicator lamps are off (PASSENGER AIR BAG ON and OFF): the front-passenger front air bag is able to deploy in the event of an accident.
- PASSENGER AIR BAG OFF lights up: the front-passenger front air bag is deactivated. It will then not be deployed in the event of an accident.



If the PASSENGER AIR BAG ON indicator lamp is off, only the PASSENGER AIR BAG OFF indicator lamp shows the status of the front-passenger front air bag. The PASSENGER AIR BAG OFF indicator lamp may be lit continuously or be off. If the status of the front-passenger front air bag changes while the vehicle is in motion, an air bag display message appears in the instrument cluster (▷ page 249). When the front-passenger seat is occupied, always pay attention to the PASSENGER AIR BAG OFF indicator lamp. Be aware of the status of the front-passenger front air bag both before and during the journey.

### WARNING

If the PASSENGER AIR BAG OFF indicator lamp is lit, the front-passenger front air bag is disabled. It will not be deployed in the event of an accident and cannot perform its intended protective function. A person in the front-passenger seat could then, for example, come into contact with the vehicle's interior, especially if the person is sitting too close to the dashboard. This poses an increased risk of injury or even fatal injury.

When the front-passenger seat is occupied, always ensure that:

- the classification of the person in the front-passenger seat is correct and the front-passenger front air bag is enabled or disabled in accordance with the person in the front-passenger seat
- the front-passenger seat has been moved back as far back as possible.
- the person is seated correctly.

Make sure, both before and during the journey, that the status of the front-passenger front air bag is correct.

### WARNING

If you secure a child in a rearward-facing child restraint system on the front-passenger seat and the PASSENGER AIR BAG OFF indicator lamp is off, the front-passenger front air bag can deploy in the event of an accident. The child could be struck by the air bag. This poses an increased risk of injury or even fatal injury.

Make sure that the front-passenger front air bag has been deactivated. The PASSENGER AIR BAG OFF indicator lamp must be lit.

NEVER use a rearward-facing child restraint on a seat protected by an ACTIVE FRONT AIR-BAG in front of it; DEATH or SERIOUS INJURY to the child can occur.

If the PASSENGER AIR BAG OFF indicator lamp stays off, do not install a rearward-facing child restraint system on the front-passenger seat. You can find more information on OCS under "Problems with the Occupant Classification System" (▷ page 55).

### WARNING

If you secure a child in a forward-facing child restraint system on the front-passenger seat and you position the front-passenger seat too close to the dashboard, in the event of an accident, the child could:

- come into contact with the vehicle's interior if the PASSENGER AIR BAG OFF indicator lamp is lit, for example
- be struck by the air bag if the PASSENGER AIR BAG OFF indicator lamp is off

This poses an increased risk of injury or even fatal injury.

Always move the front-passenger seat as far back as possible and fully retract the seat cushion length. Always make sure that the shoulder belt strap is correctly routed from the vehicle belt sash guide to the shoulder belt guide on the child restraint system. The shoulder belt strap must be routed forwards and downwards from the vehicle belt sash guide. If necessary, adjust the vehicle belt sash guide and the front-passenger seat accordingly. Always observe the child restraint system manufacturer's installation instructions.

If OCS determines that:

- The front-passenger seat is unoccupied, the PASSENGER AIR BAG OFF indicator lamp lights up after the system self-test and

remains lit. This indicates that the front-passenger front air bag is deactivated.

- The front-passenger seat is occupied by a child of up to twelve months old, in a standard child restraint system, the PASSENGER AIR BAG OFF indicator lamp lights up after the system self-test and remains lit. This indicates that the front-passenger front air bag is deactivated.

But even in the case of a twelve-month-old child, in a standard child restraint system, the PASSENGER AIR BAG OFF indicator lamp can go out after the system self-test. This indicates that the front-passenger front air bag is activated. The result of the classification is dependent on, among other factors, the child restraint system and the child's stature. It is recommended that you install the child restraint system on a suitable rear seat.

- The front-passenger seat is occupied by a person of smaller stature (e.g. a teenager or small adult), the PASSENGER AIR BAG OFF indicator lamp lights up and remains lit after the system self-test depending on the result of the classification or, alternatively, goes out.
  - If the PASSENGER AIR BAG OFF indicator lamp is off, move the front-passenger seat as far back as possible. Alternatively, a person of smaller stature can sit on a rear seat.
  - If the PASSENGER AIR BAG OFF indicator lamp is lit, a person of smaller stature should not use the front-passenger seat.
- The front-passenger seat is occupied by an adult or a person of adult stature, the PASSENGER AIR BAG OFF indicator lamp goes out after the system self-test. This indicates that the front-passenger front air bag is activated.

If children are traveling in the vehicle, be sure to observe the notes on "Children in the vehicle" (▷ page 60).

When the Occupant Classification System (OCS) is malfunctioning, the red  restraint system warning lamp on the instrument cluster and the PASSENGER AIR BAG OFF indicator lamp light up simultaneously. The front-passenger front air bag is deactivated in this case and does not deploy during an accident. Have the Occupant Classification System (OCS) checked and repaired immediately at a qualified specialist workshop. Mercedes-Benz recommends that you use an authorized Mercedes-Benz Center for this purpose.

If the front-passenger seat, the seat cover or the seat cushion are damaged, have the necessary repair work carried out at a qualified specialist workshop. Mercedes-Benz recommends that you use an authorized Mercedes-Benz Center for this purpose.

For safety reasons, Mercedes-Benz recommends that you only use seat accessories that have been approved by Mercedes-Benz.

If the driver's air bag deploys, this does not mean that the front-passenger front air bag will also deploy. The Occupant Classification System (OCS) categorizes the occupant on the front-passenger seat. Depending on that result, the front-passenger front air bag is either enabled or deactivated.

### System self-test

#### DANGER

If both the PASSENGER AIR BAG OFF and PASSENGER AIR BAG ON indicator lamps do not light up during the system self-test, the system is malfunctioning. The front-passenger front air bag might be triggered unintentionally or might not be triggered at all in the event of an accident with high deceleration. This poses an increased risk of injury or even fatal injury.

In this case the front-passenger seat may not be used. Do not install a child restraint system on the front-passenger seat. Have the Occupant Classification System (OCS) checked and repaired immediately at a qualified specialist workshop.

#### WARNING

If the PASSENGER AIR BAG OFF indicator lamp remains lit after the system self-test, the front-passenger front air bag is disabled. It will not be deployed in the event of an accident. In this case, the front-passenger front air bag cannot perform its intended protective function, e.g. when a person is seated in the front-passenger seat.

That person could, for example, come into contact with the vehicle's interior, especially if the person is sitting too close to the dash-



board. This poses an increased risk of injury or even fatal injury.

When the front-passenger seat is occupied, always ensure that:

- the classification of the person in the front-passenger seat is correct and the front-passenger front air bag is enabled or disabled in accordance with the person in the front-passenger seat
- the person is seated properly with a correctly fastened seatbelt
- the front-passenger seat has been moved as far back as possible

If the PASSENGER AIR BAG OFF indicator lamp remains lit when it should not, the front-passenger seat may not be used. Do not install a child restraint system on the front-passenger seat. Have the Occupant Classification System (OCS) checked and repaired immediately at a qualified specialist workshop.

#### **WARNING**

Objects between the seat surface and the child restraint system could affect OCS operation. This could result in the front-passenger

air bag not functioning as intended during an accident. This poses an increased risk of injury or even fatal injury.

Do not place any objects between the seat surface and the child restraint system. The entire base of the child restraint system must always rest on the seat cushion of the front-passenger seat. The backrest of the forward-facing child restraint system must, as far as possible, be resting on the backrest of the front-passenger seat. Always comply with the child restraint system manufacturer's installation instructions.

After the system self-test, the PASSENGER AIR BAG OFF or PASSENGER AIR BAG ON indicator lamp displays the status of the front-passenger front air bag (▷ page 52). If the front-passenger front air bag is enabled, the PASSENGER AIR BAG ON indicator lamp lights up for 60 seconds and then goes out.

If the PASSENGER AIR BAG ON indicator lamp is off, only the PASSENGER AIR BAG OFF indicator lamp shows the status of the front-passenger front air bag. The PASSENGER AIR BAG OFF indicator lamp may be lit continuously or be off. For more information about the OCS, see "Problems with the Occupant Classification System" (▷ page 55).

## Problems with the Occupant Classification System (OCS)

Be sure to observe the notes on "System self-test" (▷ page 54).

Problem	Possible causes/consequences and ► Solutions
<p>The PASSENGER AIR BAG OFF indicator lamp lights up and remains lit, even though the front-passenger seat is occupied by an adult or a person of a stature corresponding to that of an adult.</p>	<p>The classification of the person on the front-passenger seat is incorrect.</p> <ul style="list-style-type: none"> <li>► Make sure the conditions for a correct classification of the person on the front-passenger seat are met (► page 52).</li> <li>► If the PASSENGER AIR BAG OFF indicator lamp remains lit, the front-passenger seat may not be used.</li> <li>► Have OCS checked as soon as possible at an authorized Mercedes-Benz Center.</li> </ul>
<p>The PASSENGER AIR BAG OFF indicator lamp does not light up and/or does not stay on.</p> <p>The front-passenger seat is:</p> <ul style="list-style-type: none"> <li>• unoccupied</li> <li>• occupied by the weight of a child up to twelve months old in a child restraint system</li> </ul>	<p>OCS is malfunctioning.</p> <ul style="list-style-type: none"> <li>► Make sure there is nothing between the seat cushion and the child seat.</li> <li>► Make sure that the entire base of the child restraint system rests on the seat cushion of the front-passenger seat. The backrest of the forward-facing child restraint system must lie as flat as possible against the backrest of the front-passenger seat. If necessary, adjust the position of the front-passenger seat.</li> <li>► Make sure that the seat cushion length is fully retracted.</li> <li>► When installing the child restraint system, make sure that the seat belt is tight. Do not pull the seat belt tight using the front-passenger seat adjustment. This could result in the seat belt and the child restraint system being pulled too tightly.</li> <li>► Check for correct installation of the child restraint system. Make sure that the head restraint does not apply a load to the child restraint system. If necessary, adjust the head restraint accordingly.</li> <li>► Make sure that no objects are applying additional weight onto the seat.</li> <li>► If the PASSENGER AIR BAG OFF indicator lamp remains off and/or the PASSENGER AIR BAG ON indicator lamp lights up, do not install a child restraint system on the front-passenger seat. It is recommended that you install the child restraint system on a suitable rear seat.</li> <li>► Have OCS checked as soon as possible at an authorized Mercedes-Benz Center.</li> </ul>

### Deployment of Emergency Tensioning Devices and air bags

#### Important safety notes

##### WARNING

The air bag parts are hot after an air bag has been deployed. There is a risk of injury. Do not touch the air bag parts. Have a deployed air bag replaced at a qualified specialist workshop as soon as possible.

##### WARNING

A deployed air bag no longer offers any protection and cannot provide the intended protection in an accident. There is an increased risk of injury.

Have the vehicle towed to a qualified specialist workshop in order to have a deployed air bag replaced.

It is important for your safety and that of your passenger to have deployed air bags replaced

and to have any malfunctioning air bags repaired. This will help to make sure the air bags continue to perform their protective function for the vehicle occupants in the event of a crash.

### WARNING

Emergency Tensioning Devices that have deployed pyrotechnically are no longer operational and are unable to perform their intended protective function. This poses an increased risk of injury or even fatal injury. Have pyrotechnically triggered Emergency Tensioning Devices replaced immediately at a qualified specialist workshop.

An electric motor is used by PRE-SAFE® to trigger the tightening of the seat belt in hazardous situations. This procedure is reversible.

If Emergency Tensioning Devices are triggered or air bags are deployed, you will hear a bang, and some powder may also be released. The  restraint system warning lamp lights up.

Only in rare cases will the bang affect your hearing. The powder that is released generally does not constitute a health hazard, but it may cause short-term breathing difficulties in people with asthma or other respiratory problems. Provided it is safe to do so, you should leave the vehicle immediately or open the window in order to prevent breathing difficulties.

Air bags and pyrotechnic Emergency Tensioning Devices (ETDs) contain perchlorate material, which may require special handling and regard for the environment. National guidelines must be observed during disposal. In California, see [www.dtsc.ca.gov/HazardousWaste/Perchlorate/index.cfm](http://www.dtsc.ca.gov/HazardousWaste/Perchlorate/index.cfm).

## Method of operation

During the first stage of a collision, the restraint system control unit evaluates important physical data relating to vehicle deceleration or acceleration, such as:

- duration
- direction
- intensity

Based on the evaluation of this data, the restraint system control unit triggers the Emergency Tensioning Devices during a frontal or rear collision.

An Emergency Tensioning Device can only be triggered, if:

- the ignition is switched on
- the components of the restraint system are operational. You can find further information under "Restraint system warning lamp" (> page 45)
- the seat belt buckle tongue has engaged in the belt buckle of the respective front seat

The Emergency Tensioning Devices in the rear compartment are triggered independently of the lock status of the seat belts.

If the restraint system control unit detects a more severe accident, further components of the restraint system are activated independently of each other in certain frontal collision situations:

- Front air bags and driver's knee bag
- Window curtain air bag, if the system determines that deployment can offer additional protection to that provided by the seat belt

The front-passenger front air bag is activated or deactivated depending on the person on the front-passenger seat. The front-passenger front air bag can only deploy in an accident if the PASSENGER AIR BAG OFF indicator lamp is off. Observe the information on the PASSENGER AIR BAG indicator lamps (> page 45).

Your vehicle has two-stage front air bags. In the first deployment stage, the front air bag is filled with propellant gas. The front air bag is fully deployed with the maximum amount of propellant gas if a second deployment threshold is reached within a few milliseconds.

The activation threshold of the Emergency Tensioning Devices and the air bags is determined by evaluating the rate of vehicle deceleration or acceleration which occurs at various points in the vehicle. This process is pre-emptive in nature. Deployment should take place in good time at the start of the collision.

The rate of vehicle deceleration or acceleration and the direction of the force are essentially determined by:

- the distribution of forces during the collision
- the collision angle
- the deformation characteristics of the vehicle
- the characteristics of the object with which the vehicle has collided

Factors which can only be seen and measured after a collision has occurred do not play a decisive role in the deployment of an air bag. Nor do

they provide an indication of air bag deployment.

The vehicle can be deformed considerably, without an air bag being deployed. This is the case if only parts which are relatively easily deformed are affected and the rate of deceleration is not high. Conversely, air bags may be deployed even though the vehicle suffers only minor deformation. This is the case if, for example, very rigid vehicle parts such as longitudinal body members are hit, and sufficient deceleration occurs as a result.

If the restraint system control unit detects a side impact or if the vehicle rolls over, the applicable components of the restraint system are deployed independently of each other depending on the apparent type of accident.

- Side impact air bags on the side where the impact takes place, independently of the Emergency Tensioning Device and the use of the seat belt on the driver's seat and outer seats in the second row

The side impact air bag on the front-passenger side deploys under the following conditions:

- the OCS system detects that the front-passenger seat is occupied or
- the seat belt buckle tongue is engaged in the belt buckle of the front-passenger seat
- Window curtain air bag on the side of impact, independently of the use of the seat belt and independently of whether the front-passenger seat is occupied
- Front Emergency Tensioning Devices, if the system determines that deployment can offer additional protection for the vehicle occupants in this situation
- Rear Emergency Tensioning Devices in certain situations if the vehicle rolls over
- Window curtain air bags on the driver's and front-passenger side in certain situations when the vehicle rolls over, if the system determines that deployment can offer additional protection to that provided by the seat belt

**i** Not all air bags are deployed in an accident. The different air bag systems work independently of each other.

How the air bag system works is determined by the severity of the accident detected, especially the vehicle deceleration or acceleration and the apparent type of accident:

- Frontal collision
- Side impact
- Rollover

## PRE-SAFE® (anticipatory occupant protection system)

### Introduction

In certain hazardous situations, PRE-SAFE® takes pre-emptive measures to protect the vehicle occupants.

### Important safety notes

**!** Make sure that there are no objects in the footwell or behind the seats. There is a danger that the seats and/or objects could be damaged when PRE-SAFE® is activated.

Despite your vehicle being equipped with the PRE-SAFE® system, the possibility of personal injuries occurring as a result of an accident cannot be eliminated. Always adapt your driving style to suit the prevailing road and weather conditions and maintain a safe distance from the vehicle in front. Drive carefully.

### Function

PRE-SAFE® intervenes:

- in emergency braking situations, e.g. when BAS is activated
- in critical driving situations, e.g. when physical limits are exceeded and the vehicle understeers or oversteers severely
- vehicles with the Driving Assistance package: when a driver assistance system intervenes powerfully or the radar sensor system detects an imminent danger of collision in certain situations

PRE-SAFE® takes the following measures depending on the hazardous situation detected:

- the front seat belts are pre-tensioned.
- if the vehicle skids, the side windows and the panorama roof with power tilt/sliding panel are closed.
- vehicles with the memory function for the front-passenger seat: the front-passenger seat is adjusted if it is in an unfavorable position.

If the hazardous situation passes without resulting in an accident, PRE-SAFE® slackens the belt pre-tensioning. All settings made by PRE-SAFE® can then be reversed.

If the seat belt pre-tensioning is not reduced:

- ▶ Move the seat backrest or seat back slightly when the vehicle is stationary. The seat belt pre-tensioning is reduced and the locking mechanism is released.

The seat-belt adjustment is an integral part of the PRE-SAFE® convenience function. Information about the convenience function can be found under "Belt adjustment" (▷ page 48).

## PRE-SAFE® PLUS (anticipatory occupant protection system PLUS)

### Introduction

PRE-SAFE® PLUS is only available in vehicles with the Driving Assistance package.

Using the radar sensor system, PRE-SAFE® PLUS is able to detect that a head-on or rear-end collision is imminent. In certain hazardous situations, PRE-SAFE® PLUS takes pre-emptive measures to protect the vehicle occupants.

### Important safety notes

The intervention of PRE-SAFE® PLUS cannot prevent an imminent collision.

The driver is not warned about the intervention of PRE-SAFE® PLUS.

PRE-SAFE® PLUS does not intervene:

- if the vehicle is backing up
- when the vehicle is towing a trailer and there is a risk of a rear-end collision

When driving, or when parking or exiting a parking space with assistance from Parking Pilot, PRE-SAFE® PLUS will not apply the brakes.

### Function

PRE-SAFE® PLUS intervenes in certain situations if the radar sensor system detects an imminent head-on or rear-end collision.

PRE-SAFE® PLUS takes the following measures depending on the hazardous situation detected:

- if the radar sensor system detects that a head-on collision is imminent, the seat belts are pre-tensioned.
- if the radar sensor system detects that a rear-end collision is imminent:
  - the brake pressure is increased if the driver applies the brakes when the vehicle is stationary.
  - the seat belts are pre-tensioned.

The PRE-SAFE® PLUS braking application is canceled:

- if the accelerator pedal is depressed when a gear is engaged
- if the risk of a collision passes or is no longer detected
- if Distance Pilot DISTRONIC indicates an intention to pull away

If the hazardous situation passes without resulting in an accident, the original settings are restored.

### Automatic measures after an accident

Immediately after an accident, the following measures are implemented, depending on the type and severity of the impact:

- the hazard warning lamps are switched on
- the emergency lighting is activated
- the vehicle doors are unlocked
- the front side windows are lowered
- vehicles with a memory function: the electrically adjustable steering wheel is raised when the driver's door is opened
- the engine is switched off and the fuel supply is cut off
- vehicles with mbrace: automatic emergency call

## Children in the vehicle

### Important safety notes

Accident statistics show that children secured in the rear seats are safer than children secured in the front-passenger seat. For this reason, Mercedes-Benz strongly advises that you install a child restraint system on a rear seat. Children are generally better protected there.

If a child younger than twelve years old and under 5 ft (1.50 m) in height is traveling in the vehicle:

- always secure the child in a child restraint system suitable for Mercedes-Benz vehicles. The child restraint system must be appropriate to the age, weight and size of the child
- be sure to observe the instructions and safety notes in this section in addition to the child restraint system manufacturer's installation instructions
- be sure to observe the instructions and safety notes on the "Occupant classification system (OCS)" (▷ page 52)

#### WARNING

If you leave children unsupervised in the vehicle, they could set it in motion by, for example:

- release the parking brake.
- shift the automatic transmission out of the parking position **P**.
- start the engine.

In addition, they may operate vehicle equipment and become trapped. There is a risk of an accident and injury.

When leaving the vehicle, always take the SmartKey with you and lock the vehicle. Never leave children unsupervised in the vehicle.

#### WARNING

If persons, particularly children are subjected to prolonged exposure to extreme heat or cold, there is a risk of injury, possibly even fatal. Never leave children unattended in the vehicle.

#### WARNING

If the child restraint system is subjected to direct sunlight, parts may get very hot. Chil-

dren may burn themselves on these parts, particularly on the metal parts of the child restraint system. There is a risk of injury.

If you leave the vehicle, taking the child with you, always ensure that the child restraint system is not exposed to direct sunlight. Protect it with a blanket, for example. If the child restraint system has been exposed to direct sunlight, let it cool down before securing the child in it. Never leave children unattended in the vehicle.

Always ensure that all vehicle occupants have their seat belts fastened correctly and are sitting properly. Particular attention must be paid to children.

Observe the safety notes on the seat belt (▷ page 46) and the notes on correct use of seat belts (▷ page 47).

A booster seat may be necessary to achieve proper seat belt positioning for children over 40 lbs (18 kg) until they reach a height where a three-point seat belt can be properly fastened without a booster seat.

### Special seatbelt retractor

#### WARNING

If the seat belt is released while driving, the child restraint system will no longer be secured properly. The special seat belt retractor is disabled and the inertia reel draws in a portion of the seat belt. The seat belt cannot be immediately refastened. There is an increased risk of injury, possibly even fatal.

Stop the vehicle immediately, paying attention to road and traffic conditions. Reactivate the special seat belt retractor and secure the child restraint system properly.

All seat belts in the vehicle, except the driver's seat belt, are equipped with a special seat belt retractor. When activated, the special seat belt retractor ensures that the seat belt cannot slacken once the child seat is secured.

Installing a child restraint system:

- ▶ Make sure you observe the child restraint system manufacturer's installation instructions.
- ▶ Pull the seat belt smoothly from the belt outlet.
- ▶ Engage seat belt tongue in belt buckle.

Activating the special seat belt retractor:

- ▶ Pull the seat belt out fully and let the inertia reel retract it again.  
While the seat belt is retracting, you should hear a ratcheting sound. The special seat belt retractor is enabled.
- ▶ Push the child restraint system down so that the seat belt is tight and does not loosen.

Removing the child restraint system and deactivating the special seat belt retractor:

- ▶ Make sure you observe the child restraint system manufacturer's installation instructions.
- ▶ Press the release button of the seat belt buckle and guide the seat belt tongue back towards the belt sash guide.  
The special seat belt retractor is deactivated.

### Child restraint system

The use of seat belts and child restraint systems is required by law in:

- all 50 states
- the U.S. territories
- the District of Columbia
- all Canadian provinces

You can obtain further information about the correct child restraint system from any authorized Mercedes-Benz Center.

#### WARNING

If the child restraint system is installed incorrectly on a suitable seat, it cannot protect as intended. The child cannot then be restrained in the event of an accident, heavy braking or sudden changes of direction. There is an increased risk of injury, possibly even fatal.

Make sure that you observe the child restraint system manufacturer's installation instructions and the notes on use. Please ensure, that the base of the child restraint system is

always resting completely on the seat cushion. Never place objects, e.g. cushions, under or behind the child restraint system. Only use child restraint systems with the original cover designed for them. Only replace damaged covers with genuine covers.

#### WARNING

If the child restraint system is installed incorrectly or is not secured, it can come loose in the event of an accident, heavy braking or a sudden change in direction. The child restraint system could be thrown about, striking vehicle occupants. There is an increased risk of injury, possibly even fatal.

Always install child restraint systems properly, even if they are not being used. Make sure that you observe the child restraint system manufacturer's installation instructions.

You will find further information on stowing objects, luggage or loads under "Loading guidelines" (▷ page 290).

#### WARNING

Child restraint systems or their securing systems which have been damaged or subjected to a load in an accident can no longer protect as intended. The child cannot then be restrained in the event of an accident, heavy braking or sudden changes of direction. There is an increased risk of injury, possibly even fatal.

Replace child restraint systems which have been damaged or subjected to a load in an accident as soon as possible. Have the securing systems on the child restraint system checked at a qualified specialist workshop, before you install a child restraint system again.

The securing systems of child restraint systems are:

- the seat belt system
- the LATCH-type (ISOFIX) securing rings
- the Top Tether anchorages

If it is absolutely necessary to carry a child on the front-passenger seat, be sure to observe the



information on the "Occupant Classification System (OCS)" (> page 52). There you will also find information on deactivating the front-passenger front air bag.

All child restraint systems must meet the following standards:

- U.S. Federal Motor Vehicle Safety Standards 213 and 225
- Canadian Motor Vehicle Safety Standards 213 and 210.2

Confirmation that the child restraint system corresponds to the standards can be found on an instruction label on the child restraint system. This confirmation can also be found in the installation instructions that are included with the child restraint system.

Observe the warning labels in the vehicle interior and on the child restraint system.

### LATCH-type (ISOFIX) child seat securing system

#### WARNING

For LATCH-type (ISOFIX) child restraint systems in which the child is secured using the safety belt integrated in the child restraint system, the maximum permissible weight of the child and child restraint system together is 73 lbs (33 kg).

If the child and the child restraint system together weigh more than 73 lbs (33 kg), the LATCH-type (ISOFIX) child restraint system with integrated safety belt no longer offers sufficient protection. The LATCH-type (ISOFIX) child seat securing system may be overloaded, and the child may not be restrained in an accident, for example. This poses an increased risk of injury or even fatal injury.

If the child and the child restraint system together weigh more than 73 lbs (33 kg), use only a LATCH-type (ISOFIX) child restraint system in which the child is also secured with the vehicle seat belt. Also secure the child restraint system with the Top Tether belt, if available.

Regularly check that the permissible gross weight of the child together with the child restraint system is still maintained.

Always comply with the manufacturer's installation and operating instructions for the child restraint system used.

Before every trip, make sure that the LATCH-type (ISOFIX) child restraint system is engaged correctly in both LATCH-type (ISOFIX) securing rings

- ❗ When installing the child restraint system, make sure that the seat belt for the middle seat does not get trapped. The seat belt could otherwise be damaged.



**Vehicles with rear seat armrest:** adjust the rear seat armrest so that LATCH-type (ISOFIX) securing rings ① for the LATCH-type (ISOFIX) child restraint system are accessible.

- Install the LATCH-type (ISOFIX) child restraint system on both LATCH-type (ISOFIX) securing rings ①.

LATCH-type (ISOFIX) is a standardized securing system for specially designed child restraint systems on the rear seats. LATCH-type (ISOFIX) securing rings for two LATCH-type (ISOFIX) child restraint systems are installed on the left and right of the rear seats.

Non-LATCH-type (ISOFIX) child seats may also be used and can be installed using the vehicle's seat belt system. Install the child seat according to the manufacturer's instructions.

### Top Tether

#### Introduction

Top Tether provides an additional connection between the LATCH-type (ISOFIX) child restraint system secured with a LATCH-type (ISOFIX) sys-



tem and the vehicle. This helps reduce the risk of injury even further. If the child restraint system is equipped with a Top Tether belt, this should always be used.

### Important safety notes

#### WARNING

If the rear seat backrests are not locked, they could fold forwards in the event of an accident, heavy braking or sudden changes of direction. As a result, child restraint systems cannot perform their intended protective function. Rear seat backrests that are not locked can also cause additional injuries, e.g. in the event of an accident. This poses an increased risk of injury or even fatal injury.

Always lock rear seat backrests after installing a Top Tether belt. Observe the lock verification indicator.

If the rear seat backrest is not engaged and locked, this will be shown in the multifunction display in the instrument cluster.

### Top Tether anchorages

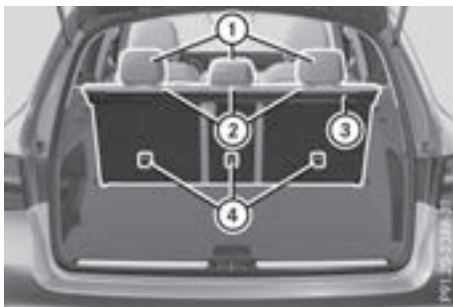

Top Tether anchorage points (4) are located on the rear side of the rear seat backrests.

- ▶ Move head restraint (1) upwards.
- ▶ Install the LATCH-type (ISOFIX) child restraint system with Top Tether. Always comply with the child restraint system manufacturer's installation instructions when doing so.

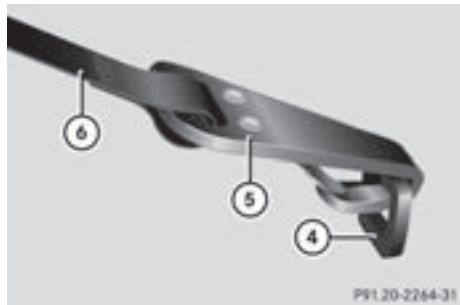

- ▶ Route Top Tether belt (6) under head restraint (1) between the two head restraint bars.
- ▶ Guide Top Tether belt (6) down between cargo compartment cover (3) and seat backrest (2).
- ▶ Hook Top Tether hook (5) into Top Tether anchorage (4) on the back of seat backrest (2).
- ▶ Make sure that Top Tether belt (6) is not twisted.
- ▶ Tension Top Tether belt (6). Always comply with the child restraint system manufacturer's installation instructions when doing so.
- ▶ Move head restraint (1) back down again slightly if necessary (▷ page 102). Make sure that you do not interfere with the correct routing of Top Tether belt (6).

### Child restraint system on the front-passenger seat

#### General notes

Accident statistics show that children secured in the rear seats are safer than children secured in the front-passenger seat. For this reason, Mercedes-Benz strongly advises that you install the child restraint system on a rear seat.

If it is absolutely necessary to install a child restraint system on the front-passenger seat, always observe the instructions and safety notes on the "Occupant Classification System (OCS)" (▷ page 52).

You can thus avoid the risks that could arise as a result of:

- an incorrectly categorized person in the front-passenger seat
- the unintentional deactivation of the front-passenger front air bag
- the unsuitable positioning of the child restraint system, e.g. too close to the dashboard

### Rearward-facing child restraint system

If it is absolutely necessary to install a rearward-facing child restraint system on the front-passenger seat, always make sure that the front-passenger front air bag is deactivated. Only if the PASSENGER AIR BAG OFF indicator lamp is permanently lit (> page 45) is the front-passenger front air bag deactivated.

Always observe the child restraint system manufacturer's installation and operating instructions.

### Forward-facing child restraint system

If it is absolutely necessary to install a forward-facing child restraint system on the front-passenger seat, always move the front-passenger seat as far back as possible. Fully retract the seat cushion length. The entire base of the child restraint system must always rest on the seat cushion of the front-passenger seat. The backrest of the child restraint system must lie as flat as possible against the backrest of the front-passenger seat. The child restraint system must not touch the roof or be subjected to a load by the head restraint. Adjust the angle of the seat backrest and the head restraint position accordingly. Always make sure that the shoulder belt strap is correctly routed from the vehicle belt outlet to the shoulder belt guide on the child restraint system. The shoulder belt strap must be routed forward and down from the vehicle belt outlet. If necessary, adjust the vehicle belt outlet and the front-passenger seat accordingly.

Always observe the child restraint system manufacturer's installation and operating instructions.

## Child-proof locks

### Important safety notes

#### WARNING

If children are traveling in the vehicle, they could:

- open doors, thus endangering other people or road users
- exit the vehicle and be caught by oncoming traffic
- operate vehicle equipment and become trapped

There is a risk of an accident and injury.

Always activate the child-proof locks and override feature if children are traveling in the vehicle. When leaving the vehicle, always take the key with you and lock the vehicle. Never leave children unattended in the vehicle.

Override feature for:

- the rear doors (> page 65)
- the rear side windows (> page 65)

#### WARNING

If you leave children unsupervised in the vehicle, they could set it in motion by, for example:

- release the parking brake.
- shift the automatic transmission out of the parking position **P**.
- start the engine.

In addition, they may operate vehicle equipment and become trapped. There is a risk of an accident and injury.

When leaving the vehicle, always take the SmartKey with you and lock the vehicle. Never leave children unsupervised in the vehicle.

#### WARNING

If persons, particularly children are subjected to prolonged exposure to extreme heat or cold, there is a risk of injury, possibly even fatal. Never leave children unattended in the vehicle.

**⚠ WARNING**

If the child restraint system is subjected to direct sunlight, parts may get very hot. Children may burn themselves on these parts, particularly on the metal parts of the child restraint system. There is a risk of injury.

If you leave the vehicle, taking the child with you, always ensure that the child restraint system is not exposed to direct sunlight. Protect it with a blanket, for example. If the child restraint system has been exposed to direct sunlight, let it cool down before securing the child in it. Never leave children unattended in the vehicle.

**Child-proof locks for the rear doors**



You secure each door individually with the child-proof locks on the rear doors. A door secured with a child-proof lock cannot be opened from inside the vehicle. When the vehicle is unlocked, the door can be opened from the outside.

- ▶ **To activate:** press the child-proof lock lever up in the direction of arrow ①.
- ▶ Make sure that the child-proof locks are working properly.
- ▶ **To deactivate:** press the child-proof lock lever down in the direction of arrow ②.

**Child-proof locks for the rear side windows**



- ▶ **To enable/disable:** press button ②. If indicator lamp ① is lit, operation of the rear side windows is disabled. Operation is only possible using the switches in the driver's door. If indicator lamp ① is off, operation is possible using the switches in the rear compartment.

**Pets in the vehicle**

**⚠ WARNING**

If you leave animals unattended or unsecured in the vehicle, they could press buttons or switches, for example.

As a result, they could:

- activate vehicle equipment and become trapped, for example
- activate or deactivate systems, thereby endangering other road users

Unsecured animals could also be flung around the vehicle in the event of an accident or sudden steering or braking, thereby injuring vehicle occupants. There is a risk of an accident and injury.

Never leave animals unattended in the vehicle. Always secure animals properly during the journey, e.g. use a suitable animal transport box.

## Driving safety systems

### Overview of driving safety systems

In this section, you will find information about the following driving safety systems:

- **ABS (Anti-lock Braking System)** (▷ page 66)
- **BAS (Brake Assist System)** (▷ page 67)
- **Active Brake Assist** (▷ page 67)
- **ESP® (Electronic Stability Program)** (▷ page 69)
- **EBD (Electronic Brake force Distribution)** (▷ page 73)
- **ADAPTIVE BRAKE** (▷ page 73)
- **Active Brake Assist with cross-traffic function** (▷ page 73)
- **STEER CONTROL** (▷ page 76)

### Important safety notes

If you fail to adapt your driving style or if you are inattentive, the driving safety systems can neither reduce the risk of an accident nor override the laws of physics. Driving safety systems are merely aids designed to assist driving. You are responsible for maintaining the distance to the vehicle in front, for vehicle speed, for braking in good time, and for staying in lane. Always adapt your driving style to suit the prevailing road and weather conditions and maintain a safe distance from the vehicle in front. Drive carefully.

The driving safety systems described only work as effectively as possible when there is adequate contact between the tires and the road surface. Pay particular attention to the information regarding tires, recommended minimum tire tread depths etc. in the "Wheels and tires" section (▷ page 349).

In wintry driving conditions, always use winter tires (M+S tires) and if necessary, snow chains. Only in this way will the driving safety systems described in this section work as effectively as possible.

## ABS (Anti-lock Braking System)

### General information

ABS regulates brake pressure in such a way that the wheels do not lock when you brake. This allows you to continue steering the vehicle when braking.

The  ABS warning lamp in the instrument cluster lights up when the ignition is switched on. It goes out when the engine is running.

ABS works from a speed of about 5 mph (8 km/h), regardless of road-surface conditions. ABS works on slippery surfaces, even when you only brake gently.

### Important safety notes

- **i** Observe the "Important safety notes" section (▷ page 66).

#### **WARNING**

If ABS is faulty, the wheels could lock when braking. The steerability and braking characteristics may be severely impaired. Additionally, further driving safety systems are deactivated. There is an increased danger of skidding and accidents.

Drive on carefully. Have ABS checked immediately at a qualified specialist workshop.

When ABS is malfunctioning, other systems, including driving safety systems, will also become inoperative. Observe the information on the ABS warning lamp (▷ page 271) and display messages which may be shown in the instrument cluster (▷ page 240).

### Braking

- ▶ **If ABS intervenes:** continue to depress the brake pedal vigorously until the braking situation is over.
- ▶ **To make a full brake application:** depress the brake pedal with full force.

If ABS intervenes when braking, you will feel a pulsing in the brake pedal.

The pulsating brake pedal can be an indication of hazardous road conditions, and functions as a reminder to take extra care while driving.

## BAS (Brake Assist System)

### General information

BAS operates in emergency braking situations. If you depress the brake pedal quickly, BAS automatically boosts the braking force, thus shortening the stopping distance.

### Important safety notes

- Observe the "Important safety notes" section (▷ page 66).

#### WARNING

If BAS is malfunctioning, the braking distance in an emergency braking situation is increased. There is a risk of an accident.

In an emergency braking situation, depress the brake pedal with full force. ABS prevents the wheels from locking.

### Braking

- Keep the brake pedal firmly depressed until the emergency braking situation is over. ABS prevents the wheels from locking.

The brakes will function as usual once you release the brake pedal. BAS is deactivated.

## Active Brake Assist

### General information

- Observe the "Important safety notes" section (▷ page 66).

Active Brake Assist consists of a distance warning function with an autonomous braking function and Adaptive Brake Assist.

Active Brake Assist can help you to minimize the risk of a collision with the vehicle traveling in front or reduce the effects of such a collision.

If Active Brake Assist detects that there is a risk of collision, you will be warned visually and acoustically. If you do not react to the visual and audible collision warning, autonomous braking can be initiated in critical situations. If you apply the brake yourself in a critical situation, Adaptive Brake Assist of the Active Brake Assist system supports you.

### Important safety notes

In particular, the detection of obstacles can be impaired if:

- there is dirt on the sensors or anything else covering the sensors
- there is snow or heavy rain
- there is interference by other radar sources
- there are strong radar reflections, for example in parking garages
- a narrow vehicle is traveling in front, e.g. a motorbike
- a vehicle is traveling in front on a different line
- you are driving a new vehicle or servicing on the Active Brake Assist system has just been carried out

Observe the important safety notes in the "Breaking-in notes" section (▷ page 135).

Following damage to the front end of the vehicle, have the configuration and operation of the radar sensor checked at a qualified specialist workshop. This also applies to collisions at slow speeds where there is no visible damage to the front of the vehicle.

### Activating/deactivating

Active Brake Assist is automatically active after switching on the ignition.

You can activate or deactivate Active Brake Assist (▷ page 232) in the on-board computer. When deactivated, the distance warning function and the autonomous braking function are also deactivated.

If Active Brake Assist is deactivated, the  symbol appears on the assistant display.

### Distance warning function

#### General information

The distance warning function can help you to minimize the risk of a front-end collision with a vehicle ahead or reduce the effects of such a collision. If the distance warning function detects that there is a risk of a collision, you will be warned visually and acoustically.

#### Important safety notes

- Observe the "Important safety notes" section for driving safety systems (▷ page 66).

**⚠ WARNING**

The distance warning function does not react:

- to people or animals
- to oncoming vehicles
- to crossing traffic
- when cornering

The distance warning function may not give warnings in all critical situations. There is a risk of an accident.

Always pay careful attention to the traffic situation and be ready to brake.

Always adapt your speed to suit the prevailing road and traffic conditions.

**⚠ WARNING**

The distance warning function cannot always clearly identify objects and complex traffic situations.

In such cases, the distance warning function may:

- give an unnecessary warning
- not give a warning

There is a risk of an accident.

Always pay careful attention to the traffic situation and do not rely solely on the distance warning function.

**Function**

Starting at a speed of approximately 4 mph (7 km/h), the distance warning function warns you if you are rapidly approaching a vehicle in front. An intermittent warning tone will then sound, and the  distance warning lamp will light up in the instrument cluster.

- ▶ Brake immediately in order to increase the distance from the vehicle in front.

or

- ▶ Take evasive action, provided it is safe to do so.

Due to the nature of the system, particularly complicated but non-critical driving conditions may also cause the system to display a warning. With the help of the radar sensor system, the distance warning function can detect obstacles that are in the path of your vehicle for an extended period of time.

Up to a speed of approximately 44 mph (70 km/h), the distance warning function can also react to stationary obstacles, such as stopped or parked vehicles.

**Autonomous braking function**

If the driver does not react to the distance warning signal in a critical situation, Active Brake Assist can assist the driver with the autonomous braking function.

**Vehicles without Distance Pilot DISTRONIC:** the autonomous braking function is available in the following speed ranges:

- 4–65 mph (7–105 km/h) for moving objects
- 4–31 mph (7–50 km/h) for stationary objects

**Vehicles with Distance Pilot DISTRONIC:** the autonomous braking function is available in the following speed ranges:

- 4–124 mph (7–200 km/h) for moving objects
- 4–31 mph (7–50 km/h) for stationary objects

Due to the nature of the system, particularly complicated but non-critical driving conditions may also cause the Autonomous Braking Function to intervene.

If the autonomous braking function requires a particularly high braking force, preventative passenger protection measures (PRE-SAFE®) are activated simultaneously (▷ page 58).

**Adaptive Brake Assist****General information**

- i** Observe the "Important safety notes" section (▷ page 66).

With the help of adaptive Brake Assist, the distance warning signal can detect obstacles that are in the path of your vehicle for an extended period of time.

If adaptive Brake Assist detects a risk of collision with the vehicle in front, it calculates the braking force necessary to avoid a collision. If you apply the brakes forcefully, adaptive Brake Assist will automatically increase the braking force to a level suitable for the traffic conditions. Adaptive Brake Assist provides braking assistance in hazardous situations at speeds above 4 mph (7 km/h). It uses radar sensor technology to assess the traffic situation.

Up to a speed of approximately 155 mph (250 km/h), Adaptive Brake Assist is capable of



reacting to moving objects that have already been detected as such at least once over the period of observation.

Up to a speed of approximately 44 mph (70 km/h), Adaptive Brake Assist reacts to stationary obstacles.

If adaptive Brake Assist demands particularly high braking force, preventative passenger protection measures (PRE-SAFE®) are activated simultaneously (▷ page 58).

- ▶ Keep the brake pedal depressed until the emergency braking situation is over. ABS prevents the wheels from locking.

The brakes will work normally again if:

- you release the brake pedal.
- there is no longer any danger of a collision.
- no obstacle is detected in front of your vehicle.

Adaptive Brake Assist is then deactivated.

### Important safety notes

- i** Observe the "Important safety notes" section for driving safety systems (▷ page 66).

#### WARNING

Adaptive Brake Assist cannot always clearly identify objects and complex traffic situations.

In such cases, Adaptive Brake Assist can:

- intervene unnecessarily
- not intervene

There is a risk of an accident.

Always pay careful attention to the traffic situation and be ready to brake. Terminate the intervention in a non-critical driving situation.

#### WARNING

Adaptive Brake Assist does not react:

- to people or animals
- to oncoming vehicles
- to crossing traffic
- when cornering

As a result, the Adaptive Brake Assist may not intervene in all critical conditions. There is a risk of an accident.

Always pay careful attention to the traffic situation and be ready to brake.

Always adapt your speed to suit the prevailing road and traffic conditions.

Due to the nature of the system, particularly complicated but non-critical driving conditions may also cause Brake Assist to intervene.

If adaptive Brake Assist is not available due to a malfunction in the radar sensor system, the brake system remains available with full brake boosting effect and BAS.

### ESP® (Electronic Stability Program)

#### General notes

- i** Observe the "Important safety notes" section (▷ page 66).

ESP® monitors driving stability and traction, i.e. power transmission between the tires and the road surface.

If ESP® detects that the vehicle is deviating from the direction desired by the driver, one or more wheels are braked to stabilize the vehicle. The engine output is also modified to keep the vehicle on the desired course within physical limits. ESP® assists the driver when pulling away on wet or slippery roads. ESP® can also stabilize the vehicle during braking.

### ETS/4ETS (Electronic Traction System)

- i** Observe the "Important safety notes" section (▷ page 66).

ETS traction control is part of ESP®. On vehicles with 4MATIC, 4ETS is part of ESP®.

Traction control brakes the drive wheels individually if they spin. This enables you to pull away and accelerate on slippery surfaces, for example if the road surface is slippery on one side. In addition, more drive torque is transferred to the wheel or wheels with traction.

Traction control remains active, even if you deactivate ESP®.



## Off-road 4ETS (Electronic Traction System)

A 4ETS system specifically suited to off-road terrain is activated automatically once the off-road program is activated (▷ page 181).

### Important safety notes

- Observe the "Important safety notes" section (▷ page 66).

#### WARNING

If ESP® is malfunctioning, ESP® is unable to stabilize the vehicle. Additionally, further driving safety systems are deactivated. This increases the risk of skidding and an accident.

Drive on carefully. Have ESP® checked at a qualified specialist workshop.

If the  ESP® OFF warning lamp lights up continuously, ESP® is deactivated.

If the  ESP® warning lamp lights up continuously, ESP® is not available due to a malfunction.

Observe the information on warning lamps (▷ page 271) and display messages which may be shown in the instrument cluster (▷ page 240).

Only use wheels with the recommended tire sizes. Only then will ESP® function properly.

## Characteristics of ESP®

### General information

If the  ESP® warning lamp goes out before beginning the journey, ESP® is automatically active.

If ESP® intervenes, the  ESP® warning lamp flashes in the instrument cluster.

If ESP® intervenes:

- ▶ Do not deactivate ESP® under any circumstances.
- ▶ Only depress the accelerator pedal as far as necessary when pulling away.
- ▶ Adapt your driving style to suit the prevailing road and weather conditions.

## ECO start/stop function

The ECO start/stop function switches the engine off automatically when the vehicle stops moving. The engine starts automatically when the driver wants to pull away again. ESP® remains in its previously selected status, e.g. if ESP® was deactivated before the engine was automatically switched off.

## Deactivating/activating ESP® (except Mercedes-AMG vehicles)

### Important safety notes

- Observe the "Important safety notes" section (▷ page 66).

You can select between the following states of ESP®:

- ESP® is activated.
- ESP® is deactivated.

#### WARNING

If you deactivate ESP®, ESP® no longer stabilizes the vehicle. There is an increased risk of skidding and an accident.

Only deactivate ESP® in the situations described in the following.

It may be best to deactivate ESP® in the following situations:

- when using snow chains
- in deep snow
- on sand or gravel



Spinning the wheels results in a cutting action which provides better grip.

- Observe the "Important safety notes" section (▷ page 66). Activate ESP® as soon as the situations described above no longer apply. ESP® will otherwise not be able to stabilize the vehicle if the vehicle starts to skid or a wheel starts to spin.

- ⚠ Avoid spinning the driven wheels for an extended period with ESP® deactivated. You could otherwise damage the drivetrain.

## Deactivating/activating ESP®



- ▶ **To deactivate:** press button ①.  
The  ESP® OFF warning lamp in the instrument cluster lights up.
- ▶ **To activate:** press button ①.  
The  ESP® OFF warning lamp in the instrument cluster goes out.

### Characteristics when ESP® is deactivated

If ESP® is deactivated and one or more wheels start to spin, the  ESP® warning lamp in the instrument cluster flashes. In such situations, ESP® will not stabilize the vehicle.

If you deactivate ESP®:

- ESP® no longer improves driving stability.
- Engine torque is no longer limited and the drive wheels are able to spin.
- Traction control is still activated.
- Active Brake Assist is no longer available; nor is it activated if you brake firmly with assistance from ESP®.
- PRE-SAFE® is no longer available, nor is it activated if you brake firmly and ESP® intervenes.
- PRE-SAFE® Brake is no longer available, it is also not activated if you brake firmly and ESP® intervenes.
- ESP® still provides support when you brake firmly.

## Deactivating/activating ESP® (Mercedes-AMG vehicles)

### Important safety notes

- ❗ Observe the "Important safety notes" section (▷ page 66).

You can select between the following states of ESP®:

- ESP® is activated.
- SPORT handling mode is activated.
- ESP® is deactivated.

### WARNING

When SPORT handling mode is activated, there is a greater risk of skidding and accidents.

Only activate SPORT handling mode in the situations described in the following.

### WARNING

If you deactivate ESP®, ESP® no longer stabilizes the vehicle. There is an increased risk of skidding and an accident.

Only deactivate ESP® in the situations described in the following.

- ❗ Avoid spinning the driven wheels for an extended period with ESP® deactivated. You could otherwise damage the drivetrain.

In the following situations, it may be better to activate SPORT handling mode or deactivate ESP®:

- when using snow chains
- in deep snow
- on sand or gravel
- on specially designated roads when the vehicle's own oversteering and understeering characteristics are desired

Spinning the wheels results in a cutting action which provides better grip.

Driving in SPORT handling mode or without ESP® requires an extremely qualified and experienced driver.

- ❗ Activate ESP® as soon as the situations described above no longer apply. ESP® will otherwise not be able to stabilize the vehicle if

the vehicle starts to skid or a wheel starts to spin.

### Deactivating/activating ESP®



- ▶ **To activate SPORT handling mode:** briefly press button ①. The **SPORT** SPORT handling mode warning lamp in the instrument cluster lights up. The **SPORT handling mode** message appears on the multifunction display.
- ▶ **To deactivate SPORT handling mode:** briefly press button ①. The **SPORT** SPORT handling mode warning lamp in the instrument cluster goes out.
- ▶ **To deactivate ESP®:** press button ① until the **ESP OFF** ESP® OFF warning lamp lights up in the instrument cluster. The **ESP OFF** message appears on the multifunction display.
- ▶ **To activate ESP®:** briefly press button ①. The **ESP OFF** ESP® OFF warning lamp in the instrument cluster goes out. The **ESP ON** message appears on the multifunction display.

### Characteristics of activated SPORT handling mode

If SPORT handling mode is activated and one or more wheels start to spin, the **ESP** ESP® warning lamp in the instrument cluster flashes. ESP® only stabilizes the vehicle to a limited degree. When SPORT handling mode is activated:

- ESP® only improves driving stability to a limited degree.
- Traction control is still activated.

- Engine torque is no longer limited and the drive wheels are able to spin.
- ESP® still provides support when you brake firmly.

### Characteristics when ESP® is deactivated

If ESP® is deactivated and one or more wheels start to spin, the **ESP** ESP® warning lamp in the instrument cluster does not flash. In such situations, ESP® will not stabilize the vehicle.

If you deactivate ESP®:

- ESP® no longer improves driving stability.
- Engine torque is no longer limited and the drive wheels are able to spin.
- Traction control is still activated.
- Active Brake Assist is no longer available; nor is it activated if you brake firmly with assistance from ESP®.
- PRE-SAFE® is no longer available, nor is it activated if you brake firmly and ESP® intervenes.
- PRE-SAFE® Brake is no longer available, it is also not activated if you brake firmly and ESP® intervenes.
- ESP® still provides support when you brake firmly.

### Off-road ESP®

An ESP® system specifically suited to off-road terrain is activated automatically once the off-road program is activated (> page 181).

Offroad ESP® intervenes with a delay if there is oversteering or understeering, thus improving traction.

### ESP® trailer stabilization

#### General information

If your vehicle/trailer combination begins to swerve, ESP® assists you in this situation. ESP® slows the vehicle down by braking and limiting the engine output until the vehicle/trailer combination has stabilized.

#### Important safety notes

##### **WARNING**

If road and weather conditions are poor, trailer stabilization will not be able to prevent

the vehicle/trailer combination from swerving. Trailers with a high center of gravity can tip over before ESP® can detect this. There is a risk of an accident.

Always adapt your driving style to the prevailing road and weather conditions.

If your vehicle with trailer (vehicle/trailer combination) begins to lurch, you can only stabilize the vehicle/trailer combination by depressing the brake firmly.

ESP® trailer stabilization is active above speeds of approximately 40 mph (65 km/h).

ESP® trailer stabilization does not work if ESP® is deactivated or malfunctioning.

## Crosswind Assist

### General information

Strong crosswind gusts can impair the ability of your vehicle to drive straight ahead. The crosswind driving assistance function integrated in ESP® noticeably reduces these impairments.

ESP® intervenes automatically according to the direction and intensity of the crosswinds affecting your vehicle.

ESP® intervenes with stabilizing braking to assist you in keeping the vehicle in the lane.

Crosswind Assist is active at vehicle speeds above 50 mph (80 km/h) when driving straight ahead or cornering gently.

### Important safety notes

Crosswind Assist does not work if ESP® is switched off or deactivated because of a malfunction.

## EBD (electronic brake force distribution)

### General information

EBD monitors and controls the brake pressure on the rear wheels to improve driving stability while braking.

## Important safety notes

**i** Observe the "Important safety notes" section (▷ page 66).

### WARNING

If EBD is malfunctioning, the rear wheels can lock, e.g. under full braking. This increases the risk of skidding and an accident.

You should therefore adapt your driving style to the different handling characteristics. Have the brake system checked at a qualified specialist workshop.

Observe information regarding indicator and warning lamps (▷ page 271) as well as display messages (▷ page 242).

## ADAPTIVE BRAKE

ADAPTIVE BRAKE enhances braking safety and offers increased braking comfort. In addition to the braking function, ADAPTIVE BRAKE also has the HOLD function (▷ page 178) and hill start assist (▷ page 140).

## Active Brake Assist with cross-traffic function

### General information

**i** Observe the important safety notes in the "Driving safety systems" section (▷ page 66).

Active Brake Assist with cross-traffic function can help you to minimize the risk of a collision with a vehicle in front or a pedestrian and reduce the effects of such a collision. If the Active Brake Assist with cross-traffic function detects a risk of collision, you will be warned visually and acoustically and, if necessary, your brake application will be assisted according to the situation. If you do not react, the system can also react by braking automatically. In the event of a detected risk of collision due to crossing traffic, you will also be visually and acoustically warned as well as assisted by the brake boosting effect according to the situation.

Active Brake Assist with cross-traffic function is only available in vehicles with the Driving Assistance Plus package.

For Active Brake Assist with cross-traffic function to assist you when driving, the radar sensor system and the camera system must be operational.

If the radar sensor system or the camera system is malfunctioning, Active Brake Assist with cross-traffic function is restricted or no longer available. The brake system is still available with complete brake boosting effect and BAS.

The radar sensor system and camera system help Active Brake Assist with cross-traffic function to detect obstacles that are in the path of your vehicle for an extended period of time.

In addition, pedestrians in the path of your vehicle can be detected.

Active Brake Assist with cross-traffic function detects pedestrians using typical characteristics such as body contours and the posture of a person standing upright.

-  Observe the restrictions described in the "Important safety notes" section (> page 74).

### Important safety notes

#### WARNING

Active Brake Assist with cross-traffic function will initially brake your vehicle by a partial application of the brakes if a danger of collision is detected. There may be a collision unless you brake yourself. Even after subsequent full application of the brakes a collision cannot always be avoided, particularly when approaching at too high a speed. There is a risk of an accident.

Always apply the brakes yourself and try to take evasive action, provided it is safe to do so.

In the event of a partial application of the brakes, the vehicle is braked with up to 50% of the full braking pressure.

#### WARNING

Active Brake Assist with cross-traffic function cannot always clearly identify objects and complex traffic situations.

In such cases, Active Brake Assist with cross-traffic function might:

- issue an unnecessary warning or engage
- neither give a warning nor intervene

There is a risk of an accident.

Always pay particular attention to the traffic situation and be prepared to brake, especially if Active Brake Assist with cross-traffic function alerts you. Terminate the intervention in a non-critical driving situation.

#### WARNING

Active Brake Assist with cross-traffic function cannot always clearly identify people, particularly if they are moving. Active Brake Assist with cross-traffic function cannot intervene in these cases. There is a risk of an accident.

Always pay particular attention to the traffic situation and be prepared to brake, especially if Active Brake Assist with cross-traffic function alerts you.

In order to maintain the appropriate distance to the vehicle in front and thus prevent a collision, you must apply the brakes yourself.

#### WARNING

Active Brake Assist with cross-traffic function does not react:

- to small people, e.g. children
- to animals
- to oncoming vehicles
- when cornering

As a result, Active Brake Assist with cross-traffic function may not warn you or engage in all critical situations. There is a risk of an accident.

Always pay careful attention to the traffic situation and be ready to brake.

In the event of snowfall or heavy rain, the recognition can be impaired.

Recognition by the radar sensor system is also impaired if:

- there is dirt on the sensors or anything else covering the sensors
- there is interference by other radar sources
- there are strong radar reflections, for example in parking garages
- a narrow vehicle is traveling in front, e.g. a motorbike
- a vehicle is traveling in front on a different line
- vehicles moving quickly into the radar sensor system detection range

Recognition by the camera system is also impaired in the event of:

- dirt on the camera or if the camera is covered
- glare on the camera system, e.g. from the sun being low in the sky
- darkness
- or if:
  - pedestrians move quickly, e.g. into the path of the vehicle
  - the camera system no longer recognizes a pedestrian as a person due to special clothing or other objects
  - a pedestrian is concealed by other objects
  - the typical outline of a pedestrian is not distinguishable from the background

Following damage to the front end of the vehicle, have the configuration and operation of the radar sensors checked at a qualified specialist workshop. This also applies to collisions at slow speeds where there is no visible damage to the front of the vehicle.

Following damage to the windshield, have the configuration and operation of the camera system checked at a qualified specialist workshop.

## Function

► **To activate or deactivate:** activate or deactivate Active Brake Assist with cross-traffic function using the on-board computer (▷ page 232).

If Active Brake Assist with cross-traffic function is deactivated, the  symbol appears on the multifunction display.

Starting at a speed of around 4 mph (7 km/h), this function warns you if you are rapidly approaching a vehicle in front. An intermittent warning tone will then sound and the  dis-

tance warning lamp will light up in the instrument cluster.

- Brake immediately to defuse the situation. or
- Take evasive action provided it is safe to do so.

Active Brake Assist with cross-traffic function can also brake the vehicle automatically under the following conditions:

- the driver and front passenger have their seat belts fastened
- the vehicle speed is between approximately 4 mph (7 km/h) and 124 mph (200 km/h)

Up to a speed of approximately 44 mph (70 km/h), Active Brake Assist with cross-traffic function may react to:

- stationary objects in the path of your vehicle, e.g. stopped or parked vehicles
- pedestrians in the path of your vehicle

**i** If there is an increased risk of a collision, preventive passenger protection measures (PRE-SAFE®) are triggered (▷ page 58).

If the risk of collision with the vehicle in front remains and you do not brake, take evasive action or accelerate significantly, the vehicle may perform automatic emergency braking, up to the point of full brake application. Automatic emergency braking is not performed until immediately prior to an imminent accident.

If you apply the brake yourself in a critical situation or during autonomous braking, situation-dependent braking assistance is implemented. If necessary, this increases the brake pressure up to full brake application.

To avoid a collision, Active Brake Assist with cross-traffic function calculates the brake force necessary if:

- you approach an obstacle, and
- Active Brake Assist with cross-traffic function has detected a risk of a collision

**When driving at a speed under 20 mph (30 km/h):** if you depress the brake pedal, Active Brake Assist with cross-traffic function is activated. The increase in brake pressure from Active Brake Assist with cross-traffic function is carried out at the last possible moment.

**When driving at a speed above 20 mph (30 km/h):** if you depress the brake pedal sharply, Active Brake Assist with cross-traffic

function automatically increases the brake pressure to a degree suited to the traffic situation.

Active Brake Assist with cross-traffic function provides braking assistance in hazardous situations with vehicles in front within a speed range between 4 mph (7 km/h) and 155 mph (250 km/h).

Up to a speed of approximately 44 mph (70 km/h) the Active Brake Assist with cross-traffic function assists you with braking in hazardous situations with:

- stationary obstacles in the path of the vehicle, e.g. stopped or parked vehicles
  - stationary pedestrians in the path of the vehicle
  - obstacles crossing your path that move in the detection range of the sensors and are detected
- Keep the brake pedal depressed until the emergency braking situation is over. ABS prevents the wheels from locking.

You can prevent the intervention of Active Brake Assist with cross-traffic function at any time by:

- depressing the accelerator pedal further.
- activating kickdown.
- releasing the brake pedal

The braking application of Active Brake Assist with cross-traffic function is ended automatically if:

- you maneuver to avoid the obstacle.
- there is no longer a risk of collision.
- an obstacle is no longer detected in front of your vehicle.

## STEER CONTROL

### General information

STEER CONTROL helps you by transmitting a noticeable steering force to the steering wheel in the direction required for vehicle stabilization. This steering assistance is provided in particular if:

- both right wheels or both left wheels are on a wet or slippery road surface when you brake
- the vehicle begins to skid

### Important safety notes

**i** Observe the "Important safety notes" section (> page 66).

No steering support is provided from STEER CONTROL, if:

- ESP® is deactivated
- ESP® is malfunctioning
- the steering is malfunctioning

If ESP® is malfunctioning, you will be assisted further by the electrical power steering.

## Protection against theft

### Immobilizer

The immobilizer prevents your vehicle from being started without the correct SmartKey.

- **To activate with the SmartKey:** remove the SmartKey from the ignition lock.
- **To activate with KEYLESS-GO start-function or KEYLESS-GO:** switch the ignition off and open the driver's door.
- **To deactivate:** switch on the ignition.

When leaving the vehicle, always take the SmartKey with you and lock the vehicle. Anyone can start the engine if a valid SmartKey has been left inside the vehicle.

**i** The immobilizer is always deactivated when you start the engine.

In the event that the engine cannot be started (yet the vehicle's battery is charged), the system is not operational. Contact an authorized Mercedes-Benz Center or call 1-800-FOR-MERcedes (in the USA) or 1-800-387-0100 (in Canada).



## ATA (anti-theft alarm system)



- ▶ **To arm:** lock the vehicle with the SmartKey or KEYLESS-GO.

Indicator lamp ① flashes. The alarm system is armed after approximately ten seconds.

- ▶ **To disarm:** unlock the vehicle with the SmartKey or KEYLESS-GO.

or

- ▶ Insert the SmartKey into the ignition lock.

or

- ▶ Press the Start/Stop button.

The SmartKey must be in the vehicle.

A visual and audible alarm is triggered if the alarm system is armed and you open:

- a door
- the vehicle with the mechanical key
- the tailgate
- the hood

- ▶ **To stop the alarm with the SmartKey:**

press the  or  button on the SmartKey.

The alarm is stopped.

or

- ▶ Remove the Start/Stop button from the ignition lock (▷ page 137).

- ▶ Insert the SmartKey into the ignition lock.

The alarm is stopped.

- ▶ **To stop the alarm using KEYLESS-GO:**

grasp the outside door handle. The SmartKey must be outside the vehicle.

The alarm is stopped.

or

- ▶ Press the Start/Stop button on the dashboard. The SmartKey must be inside the vehicle.

The alarm is stopped.

The alarm is not switched off, even if you close the open door that triggered it, for example.

- ❗ If the alarm continues for more than 30 seconds, the mbrace emergency call system automatically notifies the Customer Assistance Center. This is done either by text message or data connection.

The emergency call system sends a message or establishes a data connection provided that:

- you have subscribed to the mbrace service.
- the mbrace service has been activated properly.
- the necessary mobile phone network is available.

## SmartKey

### Important safety notes

#### WARNING

If children are left unsupervised in the vehicle, they could:

- open the doors, thus endangering other people or road users.
- get out and disrupt traffic.
- operate the vehicle's equipment.

Additionally, children could set the vehicle in motion if, for example, they:

- release the parking brake.
- shifting the automatic transmission out of park position **P**
- Start the engine.

There is a risk of an accident and injury.

When leaving the vehicle, always take the SmartKey with you and lock the vehicle. Never leave children or animals unattended in the vehicle. Always keep the SmartKey out of reach of children.

#### WARNING

If you attach heavy or large objects to the SmartKey, the SmartKey could be unintentionally turned in the ignition lock. This could cause the engine to be switched off. There is a risk of an accident.

Do not attach any heavy or large objects to the SmartKey. Remove any bulky key rings before inserting the SmartKey into the ignition lock.

- !** Keep the SmartKey away from strong magnetic fields. Otherwise, the remote control function could be affected.

Strong magnetic fields can occur in the vicinity of powerful electrical installations.

Do not keep the SmartKey:

- with electronic devices, e.g. a mobile phone or another SmartKey.
- with metallic objects, e.g. coins or metal foil.
- inside metallic objects, e.g. a metal case.

This can affect the functionality of the SmartKey.



**Vehicles with KEYLESS-GO start function:** do not keep the SmartKey in the cargo compartment. Otherwise, the SmartKey may not be detected, e.g. when starting the engine using the Start/Stop button.

A brief radio connection between the vehicle and the SmartKey determines whether a valid SmartKey is in, or in the direct vicinity of, the vehicle. This occurs, for example:

- when starting the engine
- while driving
- when using HANDS-FREE ACCESS
- when the external door handles are touched
- during convenience closing

### SmartKey functions



- ①  Locks the vehicle
- ②  Opens/closes the tailgate
- ③  Unlocks the vehicle

► **To unlock centrally:** press  button.

If you do not open the vehicle within approximately 40 seconds of unlocking:

- the vehicle is locked again.
- protection against theft is reactivated.

► **To lock centrally:** press the  button.

The SmartKey centrally locks and unlocks the following components:

- the doors
- the tailgate
- the fuel filler flap



The turn signals flash once when unlocking and three times when locking.

You can also set an audible signal to confirm that the vehicle has been locked. The audible signal can be activated and deactivated via the

multimedia system; see the Digital Operator's Manual.

You will receive visual and acoustic locking confirmation if all components were able to be locked.

When the locator lighting is activated via the multimedia system, it lights up when it is dark after the vehicle is unlocked with the SmartKey; see the Digital Operator's Manual.

- ▶ **To open the tailgate automatically from outside the vehicle:** press and hold the  button until the tailgate opens.
- ▶ **To close the tailgate automatically from outside the vehicle:** if the SmartKey is located in the immediate vicinity of the vehicle, press the  button on the SmartKey. When the tailgate closes you can then release the button.

## KEYLESS-GO

### General notes

Bear in mind that the engine can be started by any of the vehicle occupants if there is a SmartKey in the vehicle (▷ page 138).

### Locking/unlocking centrally

You can start, lock or unlock the vehicle using KEYLESS-GO. To do this, you only need carry the SmartKey with you. You can combine the functions of KEYLESS-GO with those of a conventional SmartKey. Unlock the vehicle by using KEYLESS-GO, for instance, and lock it using the  button on the SmartKey.

The driver's door and the door at which the handle is used, must both be closed. The SmartKey must be outside the vehicle. When locking or unlocking with KEYLESS-GO, the distance between the SmartKey and the corresponding door handle must not be greater than 3 ft (1 m).

A brief radio connection between the vehicle and the SmartKey determines whether a valid SmartKey is in, or in the direct vicinity of, the vehicle. This occurs, for example:

- when starting the engine
- while driving
- when using HANDS-FREE ACCESS
- when the external door handles are touched
- during convenience closing



- ▶ **To unlock the vehicle:** touch the inner surface of the door handle.
- ▶ **To lock the vehicle:** touch sensor surface ① or ②. Make sure that you do not touch the inner surface of the door handle.
- ▶ **Convenience closing feature:** touch recessed sensor surface ② for an extended period. Further information on the convenience closing feature (▷ page 92).
- ▶ **To unlock the tailgate:** pull the tailgate handle.

### Deactivating and activating

If you do not intend to use a SmartKey for an extended period of time, you can deactivate the KEYLESS-GO function of the SmartKey. The SmartKey will then use very little power, thereby conserving battery power. For the purposes of activation/deactivation, the vehicle must not be nearby.

- ▶ **To deactivate:** press the  button on the SmartKey twice in rapid succession. The battery check lamp (▷ page 81) of the SmartKey flashes twice briefly and lights up once, then KEYLESS-GO is deactivated.
- ▶ **To activate:** press any button on the SmartKey.

or

- ▶ Insert the SmartKey into the ignition lock. KEYLESS-GO and all of its associated features are available again.



## KEYLESS-GO start function



### General notes

Bear in mind that the engine can be started by any of the vehicle occupants if there is a SmartKey in the vehicle (> page 138).

### Changing the settings of the locking system





You can change the settings of the locking system. This means that only the driver's door and the fuel filler flap are unlocked when the vehicle is unlocked. This is useful if you frequently travel alone.

- ▶ **To change the setting:** press and hold down the  and  buttons simultaneously for approximately six seconds until the battery check lamp (> page 81) flashes twice.

If the setting of the locking system is changed within the signal range of the vehicle, pressing the  or  button:

- locks or
- unlocks the vehicle

The SmartKey now functions as follows:

- ▶ **To unlock:** press the  button once.
- ▶ **To unlock centrally:** press the  button twice.
- ▶ **To lock:** press the  button.
- ▶ **To restore the factory settings:** press and hold the  and  buttons simultaneously for approximately six seconds until the battery check lamp (> page 81) flashes twice.

The KEYLESS-GO functions can be changed as follows:

- ▶ **To unlock the driver's door:** touch the inner surface of the door handle on the driver's door.
- ▶ **To unlock centrally:** touch the inner surface of the door handle on the front-passenger door or the rear door.
- ▶ **To lock centrally:** touch the outer sensor surface on one of the door handles.

## Mechanical key

### General notes

If the vehicle can no longer be locked or unlocked with the SmartKey or KEYLESS-GO, use the mechanical key.

If you use the mechanical key to unlock and open the driver's door, the anti-theft alarm system will be triggered. Switch off the alarm (> page 77).

If you unlock the vehicle using the mechanical key, the fuel filler flap will not be unlocked automatically.

- ▶ **To unlock the fuel filler flap:** insert the SmartKey into the ignition lock.

### Removing the mechanical key



- ▶ Push release catch ① in the direction of the arrow and at the same time remove mechanical key ② from the SmartKey.

For further information about:

- Locking/unlocking the driver's door (> page 85)
- Unlocking the tailgate (> page 90)

### Inserting the mechanical key

- ▶ Push mechanical key ② completely into the SmartKey until it engages and release catch ① is back in its basic position.

## SmartKey battery

### Important safety notes

#### WARNING

Batteries contain toxic and corrosive substances. If batteries are swallowed, it can result in severe health problems. There is a risk of fatal injury.

Keep batteries out of the reach of children. If a battery is swallowed, seek medical attention immediately.

#### Environmental note



Batteries contain dangerous substances. It is against the law to dispose of them with the household rubbish. They must be collected separately and recycled to protect the environment.







Dispose of batteries in an environmentally friendly manner. Take discharged batteries to a qualified specialist workshop or a special collection point for used batteries.

The SmartKey batteries contain perchlorate material, which may require special handling and regard for the environment. National guidelines must be observed during disposal. In California, see [www.dtsc.ca.gov/HazardousWaste/Perchlorate/index.cfm](http://www.dtsc.ca.gov/HazardousWaste/Perchlorate/index.cfm).

Mercedes-Benz recommends that you have the batteries replaced at a qualified specialist workshop.

### Checking the battery



- ▶ Press the  or  button. The battery is working properly if battery check lamp ① lights up briefly. The battery is discharged if battery check lamp ① does not light up briefly.
  - ▶ Change the battery (> page 81).
- If the SmartKey battery is checked within the signal reception range of the vehicle, pressing the  or  button:

- locks or
- unlocks the vehicle

**i** You can get a battery at any qualified specialist workshop.

### Replacing the battery

You require a CR 2025 3 V cell battery.

- ▶ Take the mechanical key out of the SmartKey (> page 80).

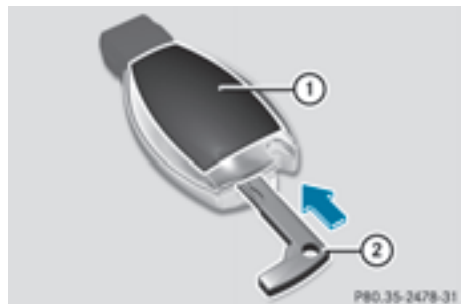

- ▶ Press mechanical key ② into the SmartKey opening in the direction of the arrow until battery compartment cover ① opens. Do not hold battery compartment cover ① closed while doing so.
- ▶ Remove battery compartment cover ①.



- ▶ Insert the front tabs of battery compartment cover ① into the housing first and then press to close it.
- ▶ Insert mechanical key ② into the SmartKey (▷ page 80).
- ▶ Check the function of all SmartKey buttons on the vehicle.

- ▶ Repeatedly tap the SmartKey against your palm until battery ③ falls out.
- ▶ Insert the new battery with the positive terminal facing upwards. Use a lint-free cloth to do so.
- ▶ Make sure that the surface of the battery is free of lint, grease and other contaminants.

### Problems with the SmartKey

Problem	Possible causes/consequences and ▶ Solutions
You can no longer lock or unlock the vehicle using the SmartKey.	The SmartKey battery is discharged or nearly discharged. ▶ Check the SmartKey battery (▷ page 81) and replace it if necessary (▷ page 81). If this does not work: ▶ Lock or unlock the vehicle using the mechanical key (▷ page 85).
	There is interference from a powerful source of radio waves. ▶ Lock or unlock the vehicle using the mechanical key (▷ page 85).
	The SmartKey is faulty. ▶ Lock or unlock the vehicle using the mechanical key (▷ page 85). ▶ Have the SmartKey checked at a qualified specialist workshop.
You can no longer lock or unlock the vehicle using KEYLESS-GO.	KEYLESS-GO was deactivated. ▶ Reactivate KEYLESS-GO (▷ page 79).
	The SmartKey battery is discharged or nearly discharged. ▶ Check the SmartKey battery (▷ page 81) and replace it if necessary (▷ page 81). If this does not work: ▶ Lock or unlock the vehicle using the mechanical key (▷ page 85).
	There is interference from a powerful source of radio waves. ▶ Lock or unlock the vehicle using the mechanical key (▷ page 85).

Problem	Possible causes/consequences and ► Solutions
	<p>KEYLESS-GO is malfunctioning.</p> <ul style="list-style-type: none"> <li>► Lock/unlock the vehicle using the remote control function of the SmartKey.</li> <li>► Have the vehicle and SmartKey checked at a qualified specialist workshop.</li> </ul> <p>If the vehicle can also not be locked/unlocked using the remote control function:</p> <ul style="list-style-type: none"> <li>► Lock or unlock the vehicle using the mechanical key (▷ page 85).</li> <li>► Have the vehicle and SmartKey checked at a qualified specialist workshop.</li> </ul>
<p>The engine cannot be started using the SmartKey.</p>	<p>The on-board voltage is too low.</p> <ul style="list-style-type: none"> <li>► Switch off non-essential consumers, e.g. seat heating or interior lighting, and try to start the engine again.</li> </ul> <p>If this does not work:</p> <ul style="list-style-type: none"> <li>► Check the starter battery and charge it if necessary (▷ page 340).</li> <li>or</li> <li>► Jump-start the vehicle (▷ page 341).</li> <li>or</li> <li>► Consult a qualified specialist workshop.</li> </ul>
<p>The engine cannot be started using the Start/Stop button. The SmartKey is in the vehicle.</p>	<p>The vehicle is locked.</p> <ul style="list-style-type: none"> <li>► Unlock the vehicle and try to start the vehicle again.</li> </ul> <p>The SmartKey battery is discharged or nearly discharged.</p> <ul style="list-style-type: none"> <li>► Check the SmartKey battery (▷ page 81) and replace it if necessary (▷ page 81).</li> </ul> <p>If this does not work:</p> <ul style="list-style-type: none"> <li>► Start your vehicle with the SmartKey in the ignition lock.</li> </ul> <p>There is interference from a powerful source of radio waves.</p> <ul style="list-style-type: none"> <li>► Start your vehicle with the SmartKey in the ignition lock.</li> </ul>
<p>You have lost a SmartKey.</p>	<ul style="list-style-type: none"> <li>► Have the SmartKey deactivated at a qualified specialist workshop.</li> <li>► Report the loss immediately to the vehicle insurers.</li> <li>► If necessary, have the locks changed as well.</li> </ul>
<p>You have lost the mechanical key.</p>	<ul style="list-style-type: none"> <li>► Report the loss immediately to the vehicle insurers.</li> <li>► If necessary, have the locks changed as well.</li> </ul>



## Doors

### Important safety notes

#### WARNING

If children are left unsupervised in the vehicle, they could:

- open the doors, thus endangering other people or road users.
- get out and disrupt traffic.
- operate the vehicle's equipment.

Additionally, children could set the vehicle in motion if, for example, they:

- release the parking brake.
- shifting the automatic transmission out of park position **P**
- Start the engine.

There is a risk of an accident and injury.

When leaving the vehicle, always take the SmartKey with you and lock the vehicle. Never leave children or animals unattended in the vehicle. Always keep the SmartKey out of reach of children.

### Unlocking and opening doors from the inside

You can open a door from inside the vehicle even if it has been locked. You can only open the rear doors from inside the vehicle if they are not secured by the child-proof locks (▷ page 65). If the vehicle has been locked with the SmartKey or with KEYLESS-GO, opening a door from the inside will trigger the anti-theft alarm system. Switch off the alarm (▷ page 77).



- ▶ **To unlock and open a front door:** pull door handle ②.  
If the door is locked, locking knob ① pops up. The door is unlocked and opens.
- ▶ **To unlock a rear door:** pull rear door handle. The locking knob on the rear door pops up and the rear door unlocks.
- ▶ **To open a rear door:** pull rear door handle again. The rear door opens.

### Centrally locking and unlocking the vehicle from the inside

You can centrally lock and unlock the vehicle from the inside. The switches are on the driver's door.



- ▶ **To unlock:** press button ①.
- ▶ **To lock:** press button ②.  
When the front-passenger door is closed, the vehicle is locked.

Meanwhile, the fuel filler flap will not be locked or unlocked.

You cannot unlock the vehicle centrally from the inside if the vehicle has been locked with the SmartKey or KEYLESS-GO.

If the vehicle has been locked with the SmartKey or with KEYLESS-GO, opening a door from the inside will trigger the anti-theft alarm system. Switch off the alarm (▷ page 77).

If a locked door is opened from the inside, the previous unlock status of the vehicle will be taken into consideration if:

- the vehicle was locked using the locking button for the central locking, or
- the vehicle was locked automatically

The vehicle will be fully unlocked if it had previously been fully unlocked. If only the driver's door had been previously unlocked, only the door which has been opened from the inside is unlocked.

### Automatic locking feature



- ▶ **To deactivate:** press and hold button ① for approximately five seconds until a tone sounds.
- ▶ **To activate:** press and hold button ② for approximately five seconds until a tone sounds.

If you press one of the two buttons and do not hear a tone, the relevant setting has already been selected.

The vehicle is locked automatically when the ignition is switched on and the wheels are turning.

You could therefore be locked out if:

- the vehicle is being pushed
- the vehicle is being towed
- the vehicle is being tested on a dynamometer.

You can activate and deactivate the automatic locking mechanism via the multimedia system (see the Digital Operator's Manual).

### Locking/unlocking the driver's door with the mechanical key

- ❗ If you want to centrally lock the vehicle using the mechanical key, begin by pressing the locking button for the interior locking mechanism while the driver's door is open. Then lock the driver's door using the mechanical key.

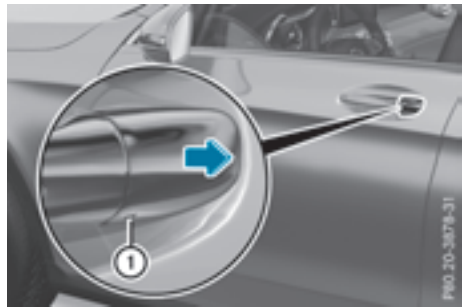

- ▶ Insert the mechanical key into opening ① in the protective cap.
- ▶ Pull and hold the door handle.
- ▶ Pull the protective cap on the mechanical key as straight as possible away from the vehicle until it releases.
- ▶ Release the door handle.

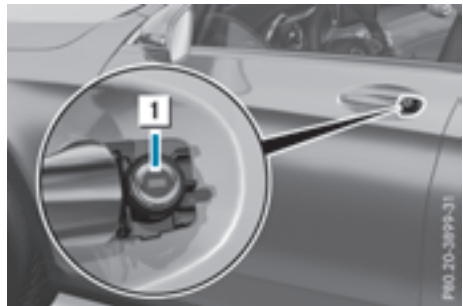

- ▶ **To lock:** turn the mechanical key clockwise as far as it will go to position 1.
- ▶ **To unlock:** turn the mechanical key counter-clockwise as far as it will go to position 1.

If you use the mechanical key to unlock and open the driver's door, the anti-theft alarm system will be triggered. Switch off the alarm (> page 77).

### Cargo compartment

#### Important safety notes

#### WARNING

Combustion engines emit poisonous exhaust gases such as carbon monoxide. If the tailgate is open when the engine is running, particularly if the vehicle is moving, exhaust fumes

could enter the passenger compartment. There is a risk of poisoning.

Turn off the engine before opening the tailgate. Never drive with the tailgate open.

#### WARNING

If objects, luggage or loads are not secured or not secured sufficiently, they could slip, tip over or be flung around and thereby hit vehicle occupants. There is a risk of injury, particularly in the event of sudden braking or a sudden change in direction.

Always store objects so that they cannot be flung around. Secure objects, luggage or loads against slipping or tipping before the journey.

**!** The tailgate swings upwards and to the rear when opened. Therefore, make sure that there is sufficient clearance above and behind the tailgate.

The opening dimensions of the tailgate can be found in the "Vehicle data" section (▷ page 382).

You can limit the opening angle of the tailgate (▷ page 90).

Do not leave the SmartKey in the cargo compartment. You could otherwise lock yourself out.

You should preferably place luggage or loads in the cargo compartment. Observe the loading guidelines (▷ page 290).

#### Tailgate object detection with reversing feature

##### Vehicles with remote tailgate closing:

The tailgate is equipped with automatic object detection with reversing function. If a solid object blocks or restricts the tailgate when automatically opening, this procedure is stopped. If a solid object blocks or restricts the tailgate when automatically closing, the tailgate automatically opens again slightly. Automatic object detection with reversing function is only an aid. It is not a substitute for your attentiveness when opening and closing the tailgate.

#### WARNING

The reversing feature does not respond:

- to soft, light and thin objects, e.g. fingers
- over the last  $\frac{1}{3}$  in (8 mm) of the closing movement

The reversing feature cannot prevent someone from becoming trapped in these situations in particular. There is a risk of injury.

Make sure that no body parts are in close proximity during the closing procedure.

If somebody becomes trapped:

- press the  button on the SmartKey, or
- pull or press the remote operating switch on the driver's door or
- press the closing or locking button on the tailgate or
- pull the handle on the tailgate

#### Vehicles with HANDS-FREE ACCESS:

It is also possible to stop the closing process by performing a kicking movement under the rear bumper.

#### Opening and closing manually

##### Opening



- ▶ Press the  button on the SmartKey.
- or
- ▶ Pull handle ①.  
The tailgate opens.

## Closing



- ▶ Pull the tailgate down using recesses ① and push it closed.
- ▶ Lock the vehicle if necessary with the  button on the SmartKey or with KEYLESS-GO (▷ page 79).

### Opening/closing automatically from the outside

#### Important safety notes

##### WARNING

Combustion engines emit poisonous exhaust gases such as carbon monoxide. If the tailgate is open when the engine is running, particularly if the vehicle is moving, exhaust fumes could enter the passenger compartment.

There is a risk of poisoning.

Turn off the engine before opening the tailgate. Never drive with the tailgate open.

##### WARNING

Parts of the body could become trapped during automatic closing of the tailgate. Moreover, people, e.g. children, may be standing in the closing area or may enter the closing area during the closing process. There is a risk of injury.

Make sure that nobody is in the vicinity of the closing area during the closing process.

Use one of the following options to stop the closing process:

- press the  button on the SmartKey.
- pull or press the remote operating switch on the driver's door.
- press the closing or locking button on the tailgate.
- pull the handle on the tailgate

#### Vehicles with HANDS-FREE ACCESS:

It is also possible to stop the closing process by performing a kicking movement under the rear bumper.

**!** The tailgate swings upwards and to the rear when opened. Therefore, make sure that there is sufficient clearance above and behind the tailgate.

Two warning tones sound while the tailgate is opening or closing.

The opening dimensions of the tailgate can be found in the "Vehicle data" section (▷ page 382).

#### Opening automatically

You can open the tailgate automatically with the SmartKey or the handle in the tailgate.

- ▶ Press and hold the  button on the SmartKey until the tailgate opens.

or

- ▶ If the tailgate is unlocked, pull the handle and let it go again immediately.

or

- ▶ With the tailgate stopped in an intermediate position, pull the tailgate upwards. You can release the tailgate as soon as the tailgate starts to open.

## Closing automatically



① Closing button

② Locking button

▶ Press closing button ① in the tailgate.

or

▶ Pull the tailgate down slightly.

You can release the tailgate as soon as the tailgate starts to close.

When the driver's door is closed, you can simultaneously close the tailgate and lock the vehicle. To do this, the SmartKey must be in the KEYLESS-GO detection range to the rear of the vehicle.

▶ Press locking button ② in the tailgate.

If KEYLESS-GO detects a SmartKey outside the vehicle, the tailgate closes. The vehicle is locked.

or

▶ **Vehicles with EASY-PACK tailgate and KEYLESS-GO or KEYLESS-GO start function:** if the SmartKey is located in the immediate vicinity of the vehicle, press the  button on the SmartKey.

You can release the button as soon as the tailgate starts to close.

If KEYLESS-GO detects a SmartKey in the cargo compartment, the tailgate is unlocked again after closing.

If KEYLESS-GO detects a second SmartKey outside the vehicle, the tailgate remains locked.

If KEYLESS-GO detects a SmartKey in the cargo compartment before the closing procedure starts, the tailgate remains open.

## HANDS-FREE ACCESS

### General notes

With KEYLESS-GO and HANDS-FREE ACCESS, you can open or close the tailgate or stop the procedure without using your hands. This is useful if you have your hands full. To do this, make a kicking movement under the bumper with your foot.

Observe the following points:

- Carry your KEYLESS-GO key about your person. The SmartKey must be at the rear of the vehicle in the detection range of KEYLESS-GO.
- When making the kicking movement, make sure that you are standing firmly on the ground and that there is sufficient clearance to the rear of the vehicle. You could otherwise lose your balance, for example on ice.



- Always ensure that you only make the kicking movement within the detection range of sensors ①.
- Stand at least 12 in (30 cm) away from the rear area while doing so.
- Do not come into contact with the bumper while making the kicking movement. Otherwise, the sensors may not function correctly.
- HANDS-FREE ACCESS does not function during engine start.
- Dirt caused by road salt or snow around sensors ① may restrict functionality. Using the HANDS-FREE ACCESS with a prosthetic leg may restrict functionality.
- If a KEYLESS-GO key is at the rear of the vehicle in the detection range of KEYLESS-GO, HANDS-FREE ACCESS could be triggered.

The tailgate could thus be opened or closed unintentionally, for example, if you:

- install or remove the ball coupling.
- couple or uncouple a trailer.
- install or remove a rear-mounted bicycle rack.
- load/unload bicycles on/from a rear-mounted bicycle rack.
- sit on the edge of the cargo compartment.
- set something down or lift something up behind the vehicle.
- polish the rear of the vehicle.

Do not carry the KEYLESS-GO key about your person in these situations or in situations similar to these. This will prevent unintentional opening or closing of the tailgate.

### Important safety notes

#### WARNING

The vehicle exhaust system can become very hot. If you use HANDS-FREE ACCESS, you could burn yourself by touching the exhaust system. There is a risk of injury. Always ensure that you make the kicking movement only within the detection range of the sensors.

**!** If the SmartKey is within the rear detection range of KEYLESS-GO, the following situations, for example, could lead to the unintentional opening of the tailgate:

- when using an automatic car wash
- when using a power washer

Make sure that the SmartKey is at least 10 ft (3 m) away from the vehicle.

### Operation

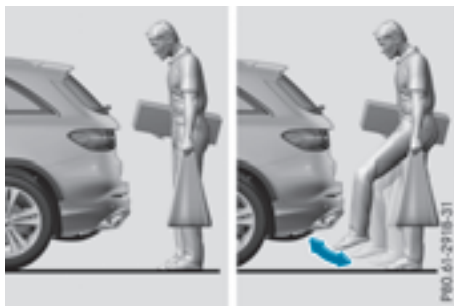

► **To open or close:** kick with your foot into sensor detection range ① beneath the bumper.  
Two warning tones sound while the tailgate is opening or closing.

► **If the tailgate does not open or close after several attempts:** wait at least ten seconds then kick under the bumper once again.

If you hold your foot under the bumper for too long, the tailgate does not open or close. Repeat the leg movement more quickly if this occurs.

To stop the opening or closing procedure, you have the following options:

- Kick with your foot into sensor detection range ① beneath the bumper.
- Pull the handle on the outside of the tailgate.
- Press the closing button on the tailgate.
- Press the  button on the SmartKey.

If the tailgate closing procedure has been stopped:

- Move your foot under the bumper again and the tailgate will open.

If the tailgate opening procedure has been stopped:

- Kick with your foot under the bumper again and the tailgate will close.

### Opening/closing automatically from inside

### Important safety notes

#### WARNING

Combustion engines emit poisonous exhaust gases such as carbon monoxide. If the tailgate is open when the engine is running, particularly if the vehicle is moving, exhaust fumes could enter the passenger compartment. There is a risk of poisoning.

Turn off the engine before opening the tailgate. Never drive with the tailgate open.

#### WARNING

Parts of the body could become trapped during automatic closing of the tailgate. In addition, people may be standing in the closing area or may enter the closing area, e.g. chil-



dren, during the closing procedure. There is a risk of injury.

Make sure that nobody is in the vicinity of the closing area during the closing process.

Release the remote operating switch immediately if somebody becomes trapped. To reopen the tailgate pull on the remote operating switch.

#### Vehicles with HANDS-FREE ACCESS:

It is also possible to stop the closing process by performing a kicking movement under the rear bumper.

**!** The tailgate swings upwards and to the rear when opened. Therefore, make sure that there is sufficient clearance above and behind the tailgate.

Two warning tones sound while the tailgate is opening or closing.

The opening dimensions of the tailgate can be found in the "Vehicle data" section (> page 382).

### Opening and closing



- ▶ **To open:** pull remote operating switch ① for the tailgate until the tailgate opens.
- ▶ **To close:** turn the SmartKey to position 1 or 2 in the ignition lock.
- ▶ Press and hold remote operating switch for tailgate ① until the tailgate is completely closed.

When the vehicle is stationary, you can close the tailgate from the driver's seat. When the vehicle is also unlocked, you can also open the tailgate from inside.

### Limiting the opening angle of the tailgate

#### General notes

**!** Make sure there is sufficient clearance to open the tailgate fully when setting the opening angle. The tailgate could otherwise be damaged. Ideally, set the opening angle outside.

You can limit the opening angle of the tailgate. This is possible in the top half of its opening range, up to approximately 8 in (20 cm) before the stop.

To open the tailgate fully, pull the handle on the outside of the tailgate again after it has stopped automatically. This does not delete the stored position.

#### Activating

- ▶ **To open the tailgate:** pull the handle on the tailgate.
- ▶ **To stop the opening procedure at the desired position:** press the closing button in the tailgate or pull the handle on the outside of the tailgate again.
- ▶ **To store the position:** press and hold the closing button in the tailgate until you hear a short tone. The opening angle limiter is activated. The tailgate will now stop in the stored position when opening.

#### Deactivating

- ▶ Press and hold the closing button on the tailgate until two short tones sound.

### Unlocking the tailgate using the mechanical key

#### General notes

Use the mechanical key if the tailgate can no longer be unlocked:

- using the SmartKey
- using HANDS-FREE ACCESS
- using the remote operating switch on the door control panel



**!** The tailgate swings upwards and to the rear when opened. Therefore, make sure that there is sufficient clearance above and behind the tailgate.

## Unlocking

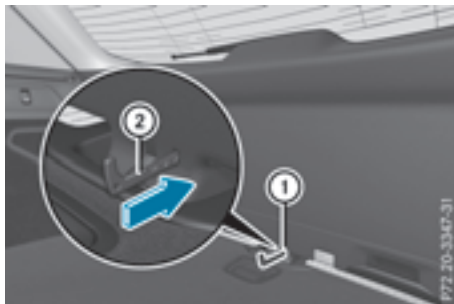

- ▶ Remove the cargo compartment cover (▷ page 296).
- ▶ Fold the rear seat backrest forward (▷ page 293).
- ▶ Insert mechanical key ② into opening ① in the paneling and push it in.
- ▶ Open the tailgate.

When you lock the vehicle, the cargo compartment is also locked again.

## Side windows

### Important safety notes

#### **!** WARNING

While opening the side windows, body parts could become trapped between the side window and the door frame as the side window moves. There is a risk of injury.

Make sure that nobody touches the side window during the opening procedure. If somebody becomes trapped, release the switch or pull the switch to close the side window again.

#### **!** WARNING

While closing the side windows, body parts in the closing area could become trapped. There is a risk of injury.

When closing make sure that no parts of the body are in the closing area. If somebody

becomes trapped, release the switch or press the switch to open the side window again.

#### **!** WARNING

If children operate the side windows they could become trapped, particularly if they are left unsupervised. There is a risk of injury.

Activate the override feature for the rear side windows. When leaving the vehicle, always take the SmartKey with you and lock the vehicle. Never leave children unsupervised in the vehicle.

### Side window reversing feature

The side windows are equipped with an automatic reversing feature. If a solid object blocks or restricts a side window from traveling upwards during the automatic closing process, the side window opens again automatically. During the manual closing process, the side window only opens again automatically after the corresponding switch is released. The automatic reversing feature is only an aid and does not relieve you of the responsibility of paying attention when closing a side window.

#### **!** WARNING

The reversing feature does not react:

- to soft, light and thin objects, e.g. small fingers
- while adjusting

This means that the reversing feature cannot prevent someone being trapped in these situations. There is a risk of injury.

Make sure that no body parts are in close proximity during the closing procedure. If someone becomes trapped, press the  button to open the side window again.

### Opening and closing the side windows

The switches for all side windows are located on the driver's door. There is also a switch on each door for the corresponding side window.

The switches on the driver's door take precedence.



- ① Front left
- ② Front right
- ③ Rear right
- ④ Rear left

- ▶ Turn the SmartKey to position **1** or **2** in the ignition lock.
- ▶ **To open manually:** press and hold the corresponding switch.
- ▶ **To open fully:** press the switch beyond the pressure point and release it. Automatic operation is started.
- ▶ **To close manually:** pull the corresponding switch and hold it.
- ▶ **To close fully:** pull the switch beyond the pressure point and release it. Automatic operation is started.
- ▶ **To interrupt automatic operation:** press/pull the corresponding switch again.

If you press the switch beyond the pressure point and release, automatic operation is started in the corresponding direction. You can stop automatic operation by pressing/pulling the switch again.

You can continue to operate the side windows after you switch off the engine or remove the SmartKey. This function remains active for five minutes or until you open a front door.

When the override feature for the side windows is activated, the side windows cannot be operated from the rear (> page 65).

Information on opening and closing the roller sunblinds on the rear side windows (> page 303).

## Convenience opening

### General notes

If the SmartKey is in close proximity to the vehicle, the convenience opening function is available.



**Vehicles with KEYLESS-GO or KEYLESS-GO start function:** you can ventilate the vehicle before you start driving.

To do this, the SmartKey is used to carry out the following functions simultaneously:

- unlock the vehicle
- open the side windows
- open the panorama roof with power tilt/sliding panel and the roller sunblind
- switch on the seat ventilation for the driver's seat

The "convenience opening" feature is also available when the vehicle is unlocked.

### Convenience opening

- ▶ Press and hold the  button on the SmartKey until the side windows and the panorama roof with power tilt/sliding panel are in the desired position. If the roller sunblinds of the panorama roof with power tilt/sliding panel are closed, the roller sunblinds are opened first.
- ▶ Press and hold the  button again until the panorama roof with power tilt/sliding panel is in the desired position.
- ▶ **To interrupt convenience opening:** release the  button.

## Convenience closing feature

### Important safety notes

#### WARNING

When the convenience closing feature is operating, parts of the body could become trapped in the closing area of the side window and the sliding sunroof. There is a risk of injury.

Observe the complete closing procedure when the convenience closing feature is operating. Make sure that no body parts are in close proximity during the closing procedure.

**Vehicles with KEYLESS-GO or KEYLESS-GO**

**start function:** if the SmartKey is in close proximity to the vehicle, the convenience closing function is available.

When you lock the vehicle, you can simultaneously:



- close the side windows
- close the panorama roof with power tilt/sliding panel

On vehicles with a panorama roof with power tilt/sliding panel, you can then close the roller sunblinds.

Notes on the automatic reversing feature for:

- the side windows (▷ page 91)
- the panorama roof with power tilt/sliding panel (▷ page 95)

**Using the SmartKey**

- ▶ Press and hold the  button until the side windows and the panorama roof with power tilt/sliding panel are fully closed.
- ▶ Make sure that all the side windows and the panorama roof with power tilt/sliding panel are closed.
- ▶ Press and hold the  button again until the roller sunblinds of the panorama roof with power tilt/sliding panel are closed.
- ▶ **To interrupt convenience closing:** release the  button.



**Using KEYLESS-GO**

The driver's door and the door at which the handle is used, must both be closed. The SmartKey must be outside the vehicle. The gap between the SmartKey and the corresponding door handle should not be greater than 3 ft (1 m).





- ▶ Touch recessed sensor surface  on the door handle until the side windows and the panorama roof with power tilt/sliding panel are fully closed.

Make sure you touch only recessed sensor surface .

- ▶ Make sure that all the side windows and the panorama roof with power tilt/sliding panel are closed.
- ▶ Touch recessed sensor surface  on the door handle again until the roller sunblinds of the panorama roof with power tilt/sliding panel close.
- ▶ **To interrupt convenience closing:** release recessed sensor surface  on the door handle.

**Resetting the side windows**

If a side window can no longer be closed fully, you must reset it.

- ▶ Close all the doors.
- ▶ Turn the SmartKey to position  or  in the ignition lock.
- ▶ Pull the corresponding switch on the door control panel until the side window is completely closed (▷ page 91).
- ▶ Hold the switch for an additional second.

If the side window opens again slightly:

- ▶ Immediately pull the corresponding switch on the door control panel until the side window is completely closed (▷ page 91).
- ▶ Hold the switch for an additional second.
- ▶ If the respective side window remains closed after the button is released, then it has been set correctly. If this is not the case, repeat the steps above.

## Problems with the side windows

### WARNING

If you close a side window again immediately after it has been blocked or reset, the side window closes with increased or maximum force. The reversing feature is then not active. Parts of the body could be trapped in the closing area in the process. This poses an increased risk of injury or even fatal injury.

Make sure that no parts of the body are in the closing area. To stop the closing process, release the switch or push the switch again to reopen the side window.

Problem	Possible causes/consequences and ► Solutions
A side window cannot be closed because it is blocked by objects, e.g. leaves in the window guide.	<ul style="list-style-type: none"> <li>► Remove the objects.</li> <li>► Close the side window.</li> </ul>
A side window cannot be closed and you cannot see the cause.	<p>If a side window is obstructed during closing and reopens again slightly:</p> <ul style="list-style-type: none"> <li>► Immediately after the window blocks, pull the corresponding switch again until the side window has closed. The side window is closed with increased force.</li> </ul> <p>If a side window is obstructed again during closing and reopens again slightly:</p> <ul style="list-style-type: none"> <li>► Immediately after the window blocks, pull the corresponding switch again until the side window has closed. The side windows are closed without the automatic reversing feature.</li> </ul>

## Panorama roof with power tilt/sliding panel

### Important safety notes

In the following section, the term "sliding sunroof" refers to the panorama roof with power tilt/sliding panel.

### WARNING

While opening and closing the sliding sunroof, body parts in close proximity could become trapped. There is a risk of injury.

Make sure that no body parts are in close proximity during the opening and closing procedures.

If somebody becomes trapped:

- release the switch immediately, or
- during automatic operation, push the switch briefly in any direction

The opening or closing procedure will be stopped.

### WARNING

If children operate the sliding sunroof they could become trapped, particularly if they are left unsupervised. There is a risk of injury.

When leaving the vehicle, always take the SmartKey with you and lock the vehicle. Never leave children unsupervised in the vehicle.

**⚠ WARNING**

At high speeds the raised sliding sunroof automatically lowers slightly at the rear. This could trap you or other persons. There is a risk of injury. Make sure that nobody reaches into the sweep of the sliding sunroof whilst the vehicle is in motion.

If somebody becomes trapped, immediately pull back the sliding sunroof switch. The sliding sunroof lifts during opening.

**!** Only open the sliding sunroof if it is free of snow and ice. Otherwise, malfunctions may occur.

Do not allow anything to protrude from the sliding sunroof. Otherwise, the seals could be damaged.

**!** The weather can change abruptly. It could start to rain or snow. Make sure that the sliding sunroof is closed when you leave the vehicle. The vehicle electronics can be damaged if water enters the vehicle interior.

Resonance noises can occur in addition to the usual airflow noises when the sliding sunroof is open. They are caused by minor pressure fluctuations in the vehicle interior. Change the position of the sliding sunroof or open a side window slightly to reduce or eliminate these noises.

**Sliding sunroof reversing feature**

In the following section, the term "sliding sunroof" refers to the panorama roof with power tilt/sliding panel.

The sliding sunroof is equipped with an automatic reversing feature. If a solid object blocks or restricts the sliding sunroof during the closing process, the sliding sunroof opens again automatically. The automatic reversing feature is only an aid and is no substitute for your attention when closing the sliding roof.

**⚠ WARNING**

The reversing feature does not react:

- to soft, light and thin objects, e.g. small fingers
- over the last 1/6 in (4 mm) of the closing movement

- during resetting
- when closing the sliding sunroof again manually immediately after automatic reversing

This means that the reversing feature cannot prevent someone being trapped in these situations. There is a risk of injury.

Make sure that no body parts are in close proximity during the closing procedure.

If somebody becomes trapped:

- release the switch immediately, or
- press the switch in any direction during the automatic closing process

The closing process is stopped.

**Operating the panorama roof with power tilt/sliding panel****Opening and closing**

- ① To raise
- ② To open
- ③ To close/lower

The panorama roof with power tilt/sliding panel can only be operated when the roller sunblind is open.

- ▶ Turn the SmartKey to position **1** or **2** in the ignition lock.
- ▶ Press or pull the  switch in the corresponding direction.

If you press or pull the  switch beyond the pressure point, automatic operation is started in the corresponding direction. You can stop automatic operation by pressing or pulling again.

If the panorama roof with power tilt/sliding panel is raised at the rear, it automatically lowers slightly at higher speeds. The noise level in

the vehicle interior is reduced as a result. At low speeds it raises again automatically.

You can also temporarily deactivate automatic lowering. To do so, press the  switch. The panorama roof with power tilt/sliding panel raises again automatically.

You can continue to operate the panorama roof with power tilt/sliding panel after you switch off the engine or remove the SmartKey. This function remains active for five minutes or until you open a front door.

When a roof carrier is mounted the panorama roof with power tilt/sliding panel cannot be opened. The panorama roof with power tilt/sliding panel can still be raised to allow ventilation of the vehicle interior. If the panorama roof with power tilt/sliding panel makes contact with a roof carrier approved by Mercedes-Benz, the sunroof will lower slightly but remain raised at the rear.

### Rain-closing feature

The raised panorama roof with power tilt/sliding panel automatically lowers when driving if it starts to rain. The sliding sunroof is lowered depending on:

- the road speed
- the intensity of the rain

You can manually cancel the automatic closing procedure. Press or pull the  switch in any direction.

To raise the panorama roof with power tilt/sliding panel again, press the  switch in direction ①.

The rain-closing feature is then deactivated until you:

- press or pull the  switch in any direction or
- turn the SmartKey to another position in the ignition lock (▷ page 136)

### Operating the roller sunblinds for the panorama roof with power tilt/sliding panel

#### Important safety notes

##### WARNING

Parts of the body could become trapped between the roller sunblind and frame or sliding sunroof during automatic opening or closing. There is a risk of injury.

When opening or closing, make sure that no body parts are in the sweep of the roller sunblind.

If somebody becomes trapped:

- release the switch immediately, or
- during automatic operation, push the switch briefly in any direction

The opening or closing procedure will be stopped.

The roller sunblinds shield the vehicle interior from sunlight. The roller sunblinds can only be opened and closed when the panorama roof with power tilt/sliding panel is closed.

#### Roller sunblind reversing feature

The roller sunblinds are equipped with an automatic reversing feature. If a solid object blocks or restricts a roller sunblind during the closing process, the roller sunblind opens again automatically. However, the automatic reversing feature is only an aid and is not a substitute of your attentiveness when closing the roller sunblind.

##### WARNING

The reversing feature does not react in particular to soft, light and thin objects, e.g. small fingers. This means that the reversing feature cannot prevent someone being trapped in these situations. There is a risk of injury.

When closing the roller sunblind, make sure that no body parts are in the sweep area.

If somebody becomes trapped:

- release the switch immediately, or
- press the switch in any direction during the automatic closing process

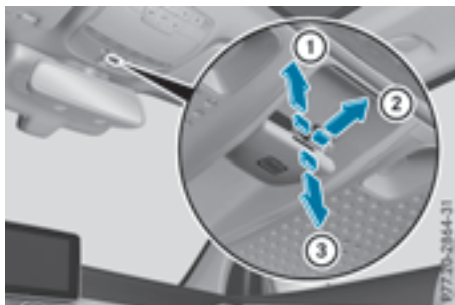

The closing process is stopped.

## Opening and closing the roller sunblinds



- ① To open
- ② To open
- ③ To close

You can only close the roller sunblinds when the panorama roof with power tilt/sliding panel is closed.

- ▶ Turn the SmartKey to position ① or ② in the ignition lock.
- ▶ Press the  switch in direction ①. Both roller sunblinds open, then the panorama roof with power tilt/sliding panel is raised.
- ▶ Pull the  switch in direction ②. The sunblinds open.
- ▶ Pull the  switch in direction ③. The roller sunblinds close when the panorama roof with power tilt/sliding panel is closed.





If you press or pull the  switch beyond the pressure point, automatic operation is started in the corresponding direction. You can stop automatic operation by pressing or pulling again.

## Resetting the panorama roof with power tilt/sliding panel or the front roller sunblind

- ! If the panorama roof with power tilt/sliding panel and the roller sunblinds cannot be fully opened or closed after resetting, contact a qualified specialist workshop.



Reset the panorama roof with power tilt/sliding panel or the roller sunblinds if the panorama roof with power tilt/sliding panel or the front roller sunblind does not move smoothly.

- ▶ Turn the SmartKey to position ① or ② in the ignition lock.
- ▶ Pull the  switch repeatedly to the point of resistance in the direction of arrow ① until the panorama roof with power tilt/sliding panel is fully closed.
- ▶ Keep the  switch pulled for an additional second.
- ▶ Pull the  switch several times in the direction of arrow ① until the roller sunblinds are closed.
- ▶ Keep the  switch pulled for an additional second.
- ▶ Make sure that the panorama roof with power tilt/sliding panel and the roller sunblinds can be fully opened and closed again.
- ▶ If this is not the case, repeat the steps above again.

## Problems with the panorama roof with power tilt/sliding panel

In the following section, the term "sliding sunroof" refers to the panorama roof with power tilt/sliding panel.



 **WARNING**

If you close the sliding sunroof again immediately after it has been blocked or reset, the sliding sunroof closes with increased or maximum force. The reversing feature is then not active. Parts of the body could be trapped in the closing area in the process. This poses an increased risk of injury or even fatal injury.



Make sure that no parts of the body are in the closing area.

If somebody becomes trapped:

- release the switch immediately, or
- press the switch in any direction during the automatic closing process

The closing process is stopped.

**!** If the sliding sunroof still cannot be opened or closed as a result of a malfunction, contact a qualified specialist workshop.

Problem	Possible causes/consequences and ► Solutions
<p>The panorama roof with power tilt/sliding panel cannot be closed and you cannot see the cause.</p>	<p>If the panorama roof with power tilt/sliding panel is obstructed during closing and reopens again slightly:</p> <ul style="list-style-type: none"> <li>► Immediately after it blocks, pull the  switch down again to the point of resistance until the panorama roof with power tilt/sliding panel is closed. The panorama roof with power tilt/sliding panel is closed with more force.</li> </ul> <p>If the panorama roof with power tilt/sliding panel is obstructed again during closing and reopens again slightly:</p> <ul style="list-style-type: none"> <li>► Immediately after it blocks, pull the  switch down again to the point of resistance until the panorama roof with power tilt/sliding panel is closed. The panorama roof with power tilt/sliding panel is closed without the automatic reversing feature.</li> </ul>

## Correct driver's seat position

### WARNING

You could lose control of your vehicle if you do the following while driving:

- adjust the driver's seat, head restraint, steering wheel or mirrors
- fasten the seat belt

There is a risk of an accident.

Adjust the driver's seat, head restraint, steering wheel and mirror and fasten your seat belt before starting the engine.



Observe the following when adjusting steering wheel ①, seat belt ② and driver's seat ③:

- you are as far away from the driver's air bag as possible
- you are sitting in a normal upright position
- your thighs are slightly supported by the seat cushion
- your legs are not entirely stretched and you can depress the pedals properly
- the back of your head is supported at eye level by the center of the head restraint
- you can hold the steering wheel with your arms slightly bent
- you can move your legs freely
- you can see all the displays in the instrument cluster clearly

- you should have a good overview of traffic conditions
  - the seat belt is pulled snugly against the body and is routed across the center of your shoulder and across your hips in the pelvic area
- Further related subjects:

- Adjusting the seats electrically (▷ page 101).
- Adjusting the steering wheel mechanically (▷ page 105).
- Adjusting the steering wheel electrically (▷ page 105).
- Fastening the seat belt correctly (▷ page 48).
- Adjusting the rear-view mirror and exterior mirrors (▷ page 107).
- Storing the seat, steering wheel, exterior mirror and head-up display settings with the memory function (▷ page 110).

## Seats

### Important safety notes

#### WARNING

Children could become trapped if they adjust the seats, particularly when unattended. There is a risk of injury.

When leaving the vehicle, always take the SmartKey with you and lock the vehicle. Never leave children unsupervised in the vehicle.

The seats can still be adjusted when there is no SmartKey in the ignition lock.

#### WARNING

When you adjust a seat, you or other vehicle occupants could become trapped, e.g. on the seat guide rail. There is a risk of injury.

Make sure when adjusting a seat that no one has any body parts in the sweep of the seat.

Observe the safety notes on "Air bags" (▷ page 49) and "Children in the vehicle" (▷ page 60).

#### WARNING

If the head restraints are not installed or not adjusted correctly, they cannot provide protection as intended. There is an increased risk

of injury in the head and neck area, e.g. in the event of an accident or when braking.

Always drive with the head restraints installed. Before driving off, make sure for every vehicle occupant that the center of the head restraint supports the back of the head at about eye level.

Do not rotate the head restraints of the front and rear seats. Otherwise, you cannot adjust the height and angle of the head restraints correctly.

Using the fore-and-aft adjustment, adjust the head restraint so that it is as close as possible to your head.

#### WARNING

If the driver's seat is not engaged, it could move unexpectedly while the vehicle is in motion. This could cause you to lose control of the vehicle. There is a risk of an accident.

Always make sure that the driver's seat is engaged before starting the vehicle.

#### WARNING

You could lose control of your vehicle if you do the following while driving:

- adjust the driver's seat, head restraint, steering wheel or mirrors
- fasten the seat belt

There is a risk of an accident.

Adjust the driver's seat, head restraint, steering wheel and mirror and fasten your seat belt before starting the engine.

#### WARNING

If you adjust the seat height carelessly, you or other vehicle occupants could be trapped and thereby injured. Children in particular could accidentally press the electrical seat adjustment buttons and become trapped. There is a risk of injury.

While moving the seats, make sure that your hands or other body parts do not get under the lever assembly of the seat adjustment system.

#### WARNING

The seat belt does not offer the intended level of protection if you have not moved the backrest to an almost vertical position. When braking or in the event of an accident, you could slide underneath the seat belt and sustain abdomen or neck injuries, for example. This poses an increased risk of injury or even fatal injury.

Adjust the seat properly before beginning your journey. Always ensure that the backrest is in an almost vertical position and that the shoulder section of your seat belt is routed across the center of your shoulder.

 To avoid damage to the seats and the seat heating, observe the following information:

- keep liquids from spilling on the seats. If liquid is spilled on the seats, dry them as soon as possible.
- if the seat covers are damp or wet, do not switch on the seat heating. The seat heating should also not be used to dry the seats.
- clean the seat covers as recommended; see "Interior care".
- do not transport heavy loads on the seats. Do not place sharp objects on the seat cushions, e.g. knives, nails or tools. The seats should only be occupied by passengers, if possible.
- when the seat heating is in operation, do not cover the seats with insulating materials, e.g. blankets, coats, bags, seat covers, child seats or booster seats.

 Make sure that there are no objects in the footwell under or behind the seats when moving the seats back. There is a risk that the seats and/or the objects could be damaged.

 The rear-compartment head restraints can be removed (> page 103).

For more information, contact a qualified specialist workshop.

 Related topic:

- EASY-PACK Quickfold rear bench seat (> page 293)

### Adjusting the seats electrically

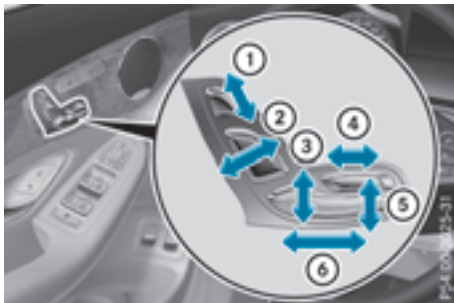

Electrically adjustable seats with memory function

- ① Head restraint height
- ② Backrest angle
- ③ Seat height
- ④ Seat cushion length
- ⑤ Seat cushion angle
- ⑥ Seat fore-and-aft adjustment

**i** Further related subjects:

- You can store the seat settings using the memory function (> page 110).
- If PRE-SAFE® is triggered, the front-passenger seat will be moved to a better position if it was previously in an unfavorable position (> page 58).
- When the seat is moved forward or back, the headrest is moved up or down automatically.

Vehicles with AMG Performance Seat: the height of the head restraints cannot be adjusted.



Electrically adjustable seats without memory function

- ① Backrest angle
- ② Seat height

- ③ Seat cushion angle
- ④ Seat fore-and-aft adjustment



Electrically adjustable seats without memory function

- ① Seat cushion length
- ▶ Lift lever ① and slide the seat cushion forward or back.
- ▶ Release lever ① again. The seat cushion engages.

### Adjusting the head restraints

#### Important safety notes

**⚠ WARNING**

You could lose control of your vehicle if you do the following while driving:

- adjust the driver's seat, head restraint, steering wheel or mirrors
- fasten the seat belt

There is a risk of an accident.

Adjust the driver's seat, head restraint, steering wheel and mirror and fasten your seat belt before starting the engine.

**⚠ WARNING**

If the head restraints are not installed or not adjusted correctly, they cannot provide protection as intended. There is an increased risk of injury in the head and neck area, e.g. in the event of an accident or when braking.

Always drive with the head restraints installed. Before driving off, make sure for every vehicle occupant that the center of the head

restraint supports the back of the head at about eye level.

### General notes

Pay attention to the important safety notes (▷ page 99).

Do not rotate the head restraints of the front and rear seats. Otherwise, you cannot adjust the height and angle of the head restraints to the correct position.

### Adjusting the head restraint height manually

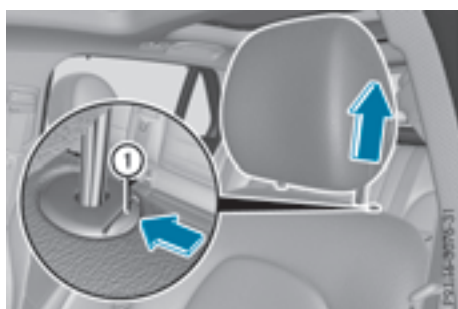

- ▶ **To raise:** pull the head restraint up to the desired position.
- ▶ **To lower:** press release catch ① in the direction of the arrow and push the head restraint down to the desired position.

### Adjusting the head restraint fore-and-aft position manually

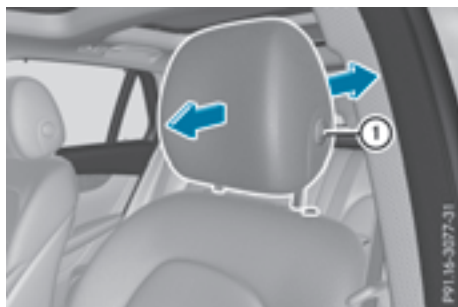

With this function you can adjust the distance between the head restraint and the back of the seat occupant's head.

- ▶ **To move forward:** pull the head restraint forward in the direction of the arrow until it engages in the desired position.
- ▶ **To move back:** press and hold the release catch ①.
- ▶ Push the head restraint back.
- ▶ Release the release button once the head restraint is in the desired position.
- ▶ Ensure that the head restraint has engaged properly.

Using the fore-and-aft adjustment, adjust the head restraint so that it is as close as possible to your head.

### Adjusting the height of the head restraints electrically

- ▶ **To adjust the head restraint height:** slide the switch for the head restraint adjustment (▷ page 101) up or down in the direction of the arrow.

### Adjusting the rear seat head restraint height

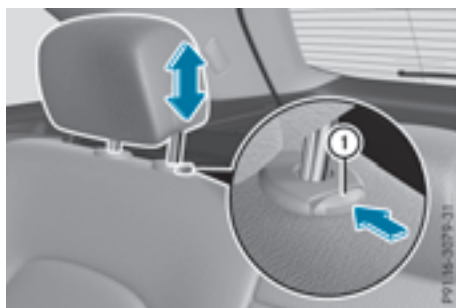

- ▶ Once the head restraint is fully lowered, press release catch ①.
- ▶ **To raise:** pull the head restraint up to the desired height.
- ▶ **To lower:** press release catch ① and push the head restraint down until it is in the desired position.

## Installing and removing rear head restraints

- ▶ Release the rear seat backrest and fold it slightly forward (▷ page 293).
- ▶ **To remove:** pull the head restraint up to the stop.
- ▶ Press release catch ① and pull the head restraint out of the guides.
- ▶ **To re-install:** insert the head restraint so that the notches on the bar are on the left when viewed in the direction of travel.
- ▶ Push the head restraint down until you hear it engage in position.
- ▶ Fold back the rear seat backrest until it engages.

## Adjusting the 4-way lumbar support

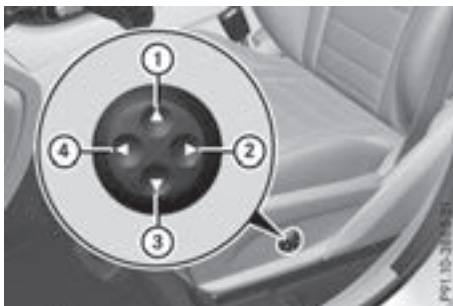

- ① Raises the backrest contour
- ② Softens the backrest contour
- ③ Lowers the backrest contour
- ④ Hardens the backrest contour

You can adjust the contour of the front seat backrests individually to provide optimum support for your back.

## Switching the seat heating on/off

### Switching on/off

#### WARNING

Repeatedly switching on the seat heating can cause the seat cushion and backrest pads to become very hot. The health of persons with limited temperature sensitivity or a limited ability to react to high temperatures may be

affected or they may even suffer burn-like injuries. There is a risk of injury.

Therefore, do not switch the seat heating on repeatedly.

- ❗ Heat accumulation can occur if the seat heating is switched on and there are objects or underlays placed on the seats, e.g. seat cushions or child seats.

This can lead to damage to the seat surface.

Make sure that no objects or underlays are placed on the seats when the seat heating is switched on.



Front seats



Rear seats

The three red indicator lamps in the button indicate the heating level you have selected.

The system automatically switches down from level **3** to level **2** after approximately eight minutes.

The system automatically switches down from level **2** to level **1** after approximately ten minutes.

The system automatically switches off approximately 20 minutes after it is set to level **1**.

- ▶ Turn the SmartKey to position **1** or **2** in the ignition lock (▷ page 136).
  - ▶ **To switch on:** press button **1** repeatedly until the desired heating level is set.
  - ▶ **To switch off:** press button **1** repeatedly until all the indicator lamps go out.
- i** If the battery voltage is too low, the seat heating may switch off.
- i** If drive program **E** is selected, the power of the seat heating is reduced.

The blue indicator lamps in the button indicate the blower setting you have selected.

- ▶ Turn the SmartKey to position **1** or **2** in the ignition lock (▷ page 136).
  - ▶ **To switch on:** press button **1** repeatedly until the desired blower setting is set.
  - ▶ **To switch off:** press button **1** repeatedly until all the indicator lamps go out.
- i** If the battery voltage is too low, the seat ventilation may switch off.

**i** You can open the side windows and the sliding sunroof using the "Convenience opening" feature (▷ page 92). The seat ventilation of the driver's seat automatically switches to the highest level.

**i** When the vehicle is stationary, the fan speed can be reduced automatically. This reduces the noises of the seat ventilation.

### Switching the seat ventilation on/off

#### Switching on/off



### Problems with the seat heating / seat ventilation

Problem	Possible causes/consequences and ► Solutions
The seat heating or seat ventilation has switched off prematurely or cannot be switched on.	<p>The on-board voltage is too low because too many electrical consumers are switched on.</p> <p>► Switch off electrical consumers that you do not need, such as the rear window defroster or interior lighting. Once the battery is sufficiently charged, the seat heating or seat ventilation can be switched back on manually.</p>



## Steering wheel

### Important safety notes

#### WARNING

You could lose control of your vehicle if you do the following while driving:

- adjust the driver's seat, head restraint, steering wheel or mirrors
- fasten the seat belt

There is a risk of an accident.

Adjust the driver's seat, head restraint, steering wheel and mirror and fasten your seat belt before starting the engine.

#### WARNING

Children could injure themselves if they adjust the steering wheel. There is a risk of injury.

When leaving the vehicle, always take the SmartKey with you and lock the vehicle. Never leave children unsupervised in the vehicle.

The electrically adjustable steering wheel can still be adjusted when there is no key in the ignition lock.

### Adjusting the steering wheel manually



- ① Release lever
- ② Adjusts the steering wheel height
- ③ Adjusts the steering wheel position (fore-and-aft adjustment)

- ▶ Push release lever ① down completely. The steering column is unlocked.
- ▶ Adjust the steering wheel to the desired position.
- ▶ Push release lever ① up as far as it will go. The steering column is locked.
- ▶ Check if the steering column is locked. When doing so, try to push the steering wheel up or down or try to move it in the fore-and-aft direction.

### Adjusting the steering wheel electrically

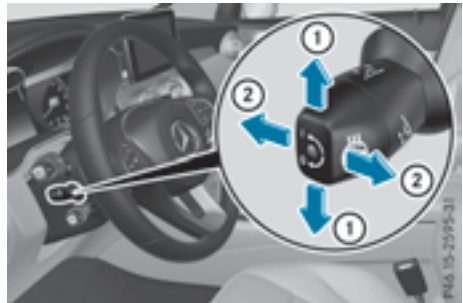

- ① Adjusts the steering wheel height
- ② Adjusts the steering wheel position (fore-and-aft adjustment)

#### Further related subjects:

- EASY-ENTRY/EXIT feature (> page 106)
- Storing settings (> page 110)

### Steering wheel heating

#### Switching on/off

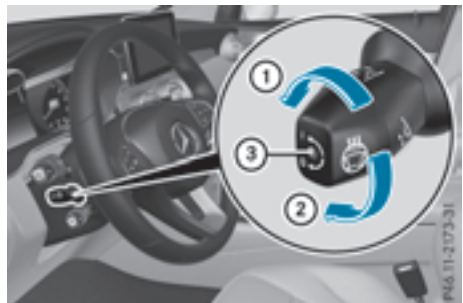

- ▶ Turn the SmartKey to position **2** in the ignition lock (▷ page 136).
- ▶ **To switch on/off:** turn the lever in the direction of arrow **1** or **2**. Indicator lamp **3** lights up or goes out.

If you switch off the ignition, the steering wheel heating is deactivated.

## Problems with the steering wheel heating

Problem	Possible causes/consequences and ▶ Solutions
The steering wheel heating has switched off prematurely or cannot be switched on.	The on-board voltage is too low because too many electrical consumers are switched on. ▶ Switch off electrical consumers that you do not need, such as the rear window defroster or interior lighting.

### EASY-ENTRY/EXIT feature

#### Important safety notes

##### WARNING

When the EASY-ENTRY/EXIT feature adjusts the steering wheel, you and other vehicle occupants – particularly children – could become trapped. There is a risk of injury.

While the EASY-ENTRY/EXIT feature is making adjustments, make sure that no one has any body parts in the sweep of the steering wheel.

Move the steering wheel adjustment lever if there is a risk of entrapment by the steering wheel. The adjustment process is stopped.

You can stop the adjustment process by pressing one of the memory function's position buttons. This function is only available on vehicles with memory function.

##### WARNING

If children activate the EASY-ENTRY/EXIT feature, they can become trapped, particularly when unattended. There is a risk of injury.

When leaving the vehicle, always take the SmartKey with you and lock the vehicle. Never leave children unsupervised in the vehicle.

##### WARNING

If you drive off while the EASY-ENTRY/EXIT feature is making adjustments, you could lose

control of the vehicle. There is a risk of an accident.

Always wait until the adjustment process is complete before driving off.

The EASY-ENTRY/EXIT feature makes getting in and out of your vehicle easier.

You can activate and deactivate the EASY-ENTRY/EXIT feature using the multimedia system (see the Digital Operator's Manual)

### Position of the steering wheel when the EASY-ENTRY/EXIT feature is active

The steering wheel swings up when you:

- remove the SmartKey from the ignition lock
- **with KEYLESS-GO or KEYLESS-GO start function:** open the driver's door; the voltage supply must be switched on
- **with the SmartKey:** open the driver's door; the SmartKey must be in position **0** or **1** in the ignition lock (▷ page 136)
- open the driver's door when the ignition is switched off

**i** The steering wheel only tilts up if the driving position is stored after the steering column adjustment has been adjusted (▷ page 110).

The most recent driving position of the steering wheel is stored if:

- the ignition is switched off
- the setting is stored using the memory function (▷ page 110)

- i** The steering wheel only moves up if it has not already reached the upper steering limiter.

### Position of the steering wheel for driving

The steering wheel is moved to the last selected position when:

- the driver's door is closed and you insert the SmartKey into the ignition lock
- you close the driver's door when the ignition is switched on
- you press the Start/Stop button once in vehicles with KEYLESS-GO or the KEYLESS-GO start function

- i** The steering wheel only returns to the last set position if the driving position is stored after the seat or steering column has been adjusted (▷ page 110).

The most recent driving position of the steering wheel is stored if:

- the ignition is switched off
- the setting is stored using the memory function (▷ page 110)

### Crash-responsive EASY-EXIT feature

If the crash-responsive EASY-EXIT feature is triggered in an accident, the steering column will move up when the driver's door is opened or the SmartKey is removed from the ignition lock. This makes it easier to exit the vehicle and rescue the occupants.

The crash-responsive EASY-EXIT feature is operational only if the EASY-EXIT/ENTRY feature is activated in the multimedia system (see Digital Operator's Manual).

## Mirrors

### Exterior mirrors

#### Important safety notes

##### **⚠ WARNING**

You could lose control of your vehicle if you do the following while driving:

- adjust the driver's seat, head restraint, steering wheel or mirrors
- fasten the seat belt

There is a risk of an accident.

Adjust the driver's seat, head restraint, steering wheel and mirror and fasten your seat belt before starting the engine.

##### **⚠ WARNING**

The exterior mirror on the front-passenger side reduces the size of the image. Visible objects are actually closer than they appear. This means that you could misjudge the distance from road users traveling behind, e.g. when changing lane. There is a risk of an accident.

For this reason, always make sure of the actual distance from the road users traveling behind by glancing over your shoulder.

#### Adjusting the exterior mirrors

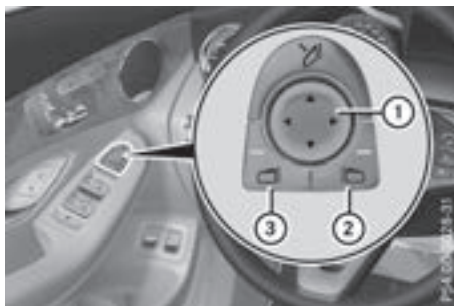

- ▶ Turn the SmartKey to position **1** or **2** in the ignition lock (▷ page 136).
- ▶ Exterior mirror on the front-passenger side: press button **2**.

Exterior mirror on the driver's side: press button ③.

The indicator lamp lights up in the button that has been pressed.

The indicator lamp goes out again after some time. You can adjust the selected exterior mirror using button ① as long as the indicator lamp is lit.

- ▶ Press button ① up, down, or to the left or right until you have adjusted the exterior mirror to the correct position. You should have a good overview of traffic conditions.

The convex exterior mirrors provide a larger field of vision.

After the engine has been started, the exterior mirrors are automatically heated if the rear window defroster is switched on and the outside temperature is low.

### Folding the exterior mirrors in or out electrically



- ▶ Turn the SmartKey to position ① or ② in the ignition lock (▷ page 136).
- ▶ Briefly press ①. Both exterior mirrors fold in or out.
- ⓘ Make sure that the exterior mirrors are always folded out fully while driving. They could otherwise vibrate.
- ⓘ If you are driving faster than 30 mph (47 km/h), you can no longer fold in the exterior mirrors.

### Resetting the exterior mirrors

If the battery has been disconnected or completely discharged, the exterior mirrors must be reset. The exterior mirrors will otherwise not fold in if you have activated the **Automatic**

**Mirror Folding** function in the multimedia system.

- ▶ Turn the SmartKey to position ① or ② in the ignition lock (▷ page 136).
- ▶ Briefly press ①.

### Folding the exterior mirrors in or out automatically

When the **Automatic Mirror Folding** function is activated in the multimedia system (see Digital Operator's Manual):

- the exterior mirrors fold in automatically as soon as you lock the vehicle from the outside.
- the exterior mirrors fold out again automatically as soon as you unlock the vehicle.

ⓘ If the exterior mirrors have been folded in manually, they do not fold out.

### Exterior mirror pushed out of position

If an exterior mirror has been pushed out of position, proceed as follows:

- ▶ **Vehicles without electrically folding exterior mirrors:** manually move the exterior mirror into the correct position.
- ▶ **Vehicles with electrically folding exterior mirrors:** press and hold button ① until you hear a click and then the mirror engaging in position (▷ page 108). The mirror housing is engaged again and you can adjust the exterior mirrors as usual (▷ page 107).

If an exterior mirror has been pushed out of position, proceed as follows:

- ▶ Press and hold button ① until you hear a click and the mirror engages audibly into position (▷ page 108). The mirror housing is engaged again and you can adjust the exterior mirrors as usual (▷ page 107).

### Automatic anti-glare mirrors

#### ⚠ WARNING

Electrolyte may escape if the glass in an automatic anti-glare mirror breaks. The electrolyte is harmful and causes irritation. It must not come into contact with your skin, eyes, res-

piratory organs or clothing or be swallowed. There is a risk of injury.

If you come into contact with the electrolyte, observe the following:

- Rinse off the electrolyte from your skin immediately with water.
- Immediately rinse the electrolyte out of your eyes thoroughly with clean water.
- If the electrolyte is swallowed, immediately rinse your mouth out thoroughly. Do not induce vomiting.
- If electrolyte comes into contact with your skin or hair or is swallowed, seek medical attention immediately.
- Immediately change out of clothing which has come into contact with electrolyte.
- If an allergic reaction occurs, seek medical attention immediately.

The exterior mirror on the driver's side and the rear-view mirror automatically go into anti-glare mode if:

- the ignition is switched on
- incident light from headlamps strikes the sensor in the rear-view mirror

The mirrors do not go into anti-glare mode if reverse gear is engaged or if the interior lighting is switched on.

### Parking position for the exterior mirror on the front-passenger side

#### Storing the parking position

You can set the front-passenger side exterior mirror such that you can see the rear wheel on that side as soon as you engage reverse gear. You can store this position.

#### Storing using reverse gear



- ① Memory button **M**
- ② Button for the exterior mirror setting
- ③ Button for the front-passenger side exterior mirror
- ④ Button for the driver's side exterior mirror

- ▶ Start the engine.
- ▶ Press button ③.
- ▶ Engage reverse gear.
  - The exterior mirror on the front-passenger side moves to the preset parking position.
- ▶ Use button ② to adjust the exterior mirror to a position that allows you to see the rear wheel and the curb.
  - The parking position is stored.

- ▶ **i** If you shift the transmission to another position, the exterior mirror on the front-passenger side returns to the driving position.

#### Saving using the memory button

You can store the parking position of the exterior mirror on the front-passenger side using memory button **M** ①. The reverse gear must not be engaged.

- ▶ Turn the SmartKey to position ② in the ignition lock (▶ page 136).
- ▶ Press button ③.
- ▶ Use button ② to adjust the exterior mirror to a position that allows you to see the rear wheel and the curb.
- ▶ Press memory button **M** ① and one of the arrows on button ② within three seconds. The parking position is stored if the exterior mirror does not move.
- ▶ If the mirror moves out of position, repeat the steps.
- ▶ After successfully storing, reset the driving position of the exterior mirror.

## Calling up a stored parking position setting

- ▶ Turn the SmartKey to position **2** in the ignition lock (▷ page 136).
- ▶ Adjust the exterior mirror on the front-passenger side using button **3**.
- ▶ Engage reverse gear.  
The exterior mirror on the front-passenger side moves to the stored parking position.

The exterior mirror on the front-passenger side moves back to its original position:

- as soon as you exceed a speed of 9 mph (15 km/h)
- about ten seconds after you have disengaged reverse gear
- when you use button **4** to select the exterior mirror on the driver's side

## Memory function

### Important safety notes

#### WARNING

If you use the memory function on the driver's side while driving, you could lose control of the vehicle as a result of the adjustments being made. There is a risk of an accident.

Only use the memory function on the driver's side when the vehicle is stationary.

#### WARNING

When the memory function adjusts the seat or steering wheel, you and other vehicle occupants – particularly children – could become trapped. There is a risk of injury.

While the memory function is making adjustments, make sure that no one has any body parts in the sweep of the seat or steering wheel. If somebody becomes trapped, immediately release the memory function position button. The adjustment process is stopped.

#### WARNING

Children could become trapped if they activate the memory function, particularly when unattended. There is a risk of injury.

When leaving the vehicle, always take the SmartKey with you and lock the vehicle. Never leave children unsupervised in the vehicle.

The memory function can be used at any time, e.g. even when the SmartKey is not in the ignition lock.

## Storing settings

With the memory function, you can store up to three different settings, e.g. for three different people.

The following settings are stored as a single memory preset:

- position of the seat, backrest and head restraint
- driver's side: position of the exterior mirrors on the driver's and front-passenger sides
- position of the head-up display



- ▶ Adjust the seat accordingly (▷ page 101).
- ▶ On the driver's side, adjust the steering wheel (▷ page 105) and the exterior mirrors (▷ page 107).
- ▶ Press memory button **M** and then press one of the memory position buttons **1**, **2** or **3** within three seconds.  
The settings are stored in the selected preset position. A tone sounds when the settings have been completed.

## Calling up a stored setting

- ▶ Press and hold the relevant memory position button **1**, **2** or **3** until the following components are in the saved position:

- Seat
- Steering wheel
- Exterior mirrors
- Head-up display

**i** If you release the memory position switch, the seat, steering wheel and mirror setting functions stop immediately. The head-up display continues to be adjusted.



## Exterior lighting

### General notes

USA only: if you wish to drive during the daytime without lights, switch off the **Daytime Running Lights** function via the on-board computer (▷ page 234).

### Setting the exterior lighting

#### Setting options

Exterior lighting can be set using the:

- light switch (▷ page 112)
- combination switch (▷ page 113)
- on-board computer (▷ page 234)

#### Light switch

##### Operation

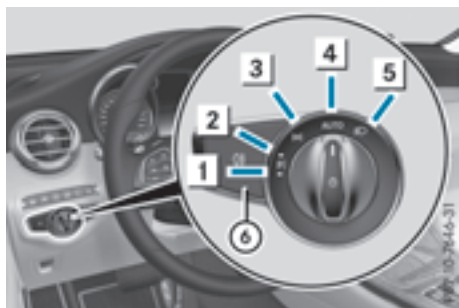

- 1 Left-hand standing lamps
- 2 Right-hand standing lamps
- 3 Parking lamps, license plate and instrument cluster lighting
- 4 **AUTO** Automatic headlamp mode, controlled by the light sensor
- 5 Low-beam/high-beam headlamps
- 6 Rear fog lamp

If you hear a warning tone when you leave the vehicle, the lights may still be switched on.

- ▶ Turn the light switch to the **AUTO** position.

The exterior lighting (except the parking/standing lamps) switches off automatically if you:

- remove the SmartKey from the ignition lock
- open the driver's door with the SmartKey in position **0** in the ignition lock

### Automatic headlamp mode

#### WARNING

When the light switch is set to **AUTO**, the low-beam headlamps may not be switched on automatically if there is fog, snow or other causes of poor visibility due to the weather conditions such as spray. There is a risk of an accident.

In such situations, turn the light switch to



The automatic headlamp mode is only an aid. The driver is responsible for the vehicle's lighting at all times.

**AUTO** is the favored light switch setting.

The light setting is automatically selected according to the brightness of the ambient light, but not in the event of poor visibility due to weather conditions such as fog, snow or spray.

- With the SmartKey in position **1** in the ignition lock, the parking lamps are switched on or off automatically depending on the brightness of the ambient light.
- USA only: if you have switched on the **Daytime Running Lights** function via the on-board computer, and the engine is running, the daytime running lamps or the parking lamps and low-beam headlamps are switched on or off automatically depending on the ambient light.
- Canada only: depending on the ambient light, the daytime running lamps or the parking and low-beam headlamps are switched on/off automatically when the engine is running.

- ▶ **To switch on the automatic headlamps:** turn the light switch to the **AUTO** position.

USA only: the daytime running lamps improve the visibility of your vehicle during the day. Here, the **Daytime Running Lights** function must be switched on via the on-board computer (▷ page 234).

If the engine is running and you turn the light switch to the or position, the manual settings take precedence over the daytime running lamps.

Canada only: the daytime running lamps improve the visibility of your vehicle during the day. The daytime running lamps function is required by law in Canada. It cannot therefore be deactivated.

When the engine is running and the vehicle is stationary: if you move the selector lever from a driving position to **P**, the daytime driving lights and low-beam headlamps go out after three minutes.

When the engine is running, the vehicle is stationary and in bright ambient light: if you turn the light switch to the **☰** position, the daytime running lamps and parking lamps switch on.

If the engine is running and you turn the light switch to the **☰** position, the manual settings take precedence over the daytime running lamps.

### Low-beam headlamps

#### WARNING

When the light switch is set to **AUTO**, the low-beam headlamps may not be switched on automatically if there is fog, snow or other causes of poor visibility due to the weather conditions such as spray. There is a risk of an accident.

In such situations, turn the light switch to



Even if the light sensor does not detect that it is dark, the parking lamps and low-beam headlamps switch on when the ignition is switched on and the light switch is set to the **☰** position. This is a particularly useful function in the event of rain and fog.

- ▶ **To switch on the low-beam headlamps:** turn the SmartKey to position **2** in the ignition lock or start the engine.
- ▶ Turn the light switch to the **☰** position. The green **☰** indicator lamp in the instrument cluster lights up.

### Rear fog lamp

The rear fog lamp improves visibility of your vehicle for the traffic behind in the event of thick fog. You must observe the legal requirements for the country in which you are currently driving when operating the rear fog lamp.

- ▶ **To switch on the rear fog lamp:** turn the SmartKey in the ignition lock to position **2** or start the engine.
- ▶ Turn the light switch to the **☰** or **AUTO** position.
- ▶ Press the **☰** button. The yellow **☰** indicator lamp on the instrument cluster lights up.

### Parking lamps

- ! If the battery charge is very low, the parking lamps or standing lamps are automatically switched off to enable the next engine start. Always park your vehicle safely and in a well lit area, in accordance with the relevant legal stipulations. Avoid using the **☰** parking lamps over a period of several hours. If possible, switch on the right-hand **☰** or left-hand **☰** standing lamps.
- ▶ **To switch on the parking lamps:** turn the light switch to the **☰** position. The green **☰** indicator lamp on the instrument cluster lights up.

### Standing lamps

Switching on the standing lamps ensures the corresponding side of the vehicle is illuminated.

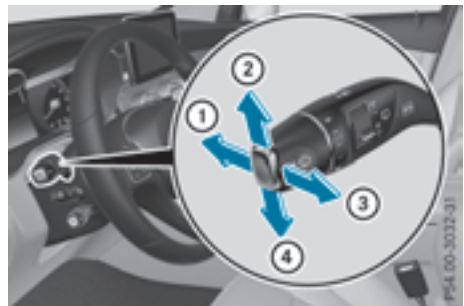

- ▶ **To switch on the parking lamp:** turn the SmartKey to position **0** in the ignition lock or remove the SmartKey.
- ▶ Turn the light switch to the **☰** (left-hand side of the vehicle) or **☰** (right-hand side of the vehicle) position.

### Combination switch



- ① High-beam headlamps
- ② Turn signal, right

- ③ High-beam flasher
- ④ Turn signal, left

- ▶ **To indicate briefly:** press the combination switch briefly to the pressure point in the direction of arrow ② or ④.  
The corresponding turn signal flashes three times.
- ▶ **To indicate:** press the combination switch beyond the pressure point in the direction of arrow ② or ④.
- ▶ **To switch on the high-beam headlamps:** turn the light switch to the  or **AUTO** position.
- ▶ Press the combination switch beyond the pressure point in the direction of arrow ①.  
In the **AUTO** position, the high-beam headlamps are switched on only when it is dark and the engine is running.  
The blue  indicator lamp on the instrument cluster lights up when the high-beam headlamps are switched on.
- ▶ **To switch off the high-beam headlamps:** move the combination switch back to its normal position.  
The blue  indicator lamp on the instrument cluster goes out.

#### Vehicles with Adaptive Highbeam Assist:

If Adaptive Highbeam Assist is active, it automatically controls activation and deactivation of the high-beam headlamps (▷ page 114).

- ▶ **High-beam flasher:** pull the combination switch in the direction of arrow ③.

#### Hazard warning lamps



- ▶ **To switch the hazard warning lamps on or off:** press button ①.  
The turn signal lamps flash when the hazard warning lamps are switched on. If you now

switch on a turn signal lamp using the combination switch, only the turn signal lamp on the corresponding side of the vehicle will flash.

The hazard warning lamps switch on automatically if an air bag is deployed.

The hazard warning lamps still operate if the ignition is switched off.

#### Cornering light function

The cornering light function improves the illumination of the road over a wide angle in the direction you are turning, enabling better visibility in tight bends, for example. It can only be activated when the low-beam headlamps are switched on.

##### Active:

- if you are driving at speeds below 25 mph (40 km/h) and switch on the turn signal or turn the steering wheel
- if you are driving at speeds between 25 mph (40 km/h) and 45 mph (70 km/h) and turn the steering wheel

The cornering lamp may remain lit for a short time, but is automatically switched off after no more than three minutes.

#### Cornering light function with traffic circle function:

The cornering light function is activated on both sides before entering a traffic circle through an evaluation of the current GPS position of the vehicle. It remains active until after the vehicle has left the traffic circle. In this way, pedestrians crossing the road, for example, are illuminated by your vehicle in good time.

Only vehicles with the COMAND multimedia system have this function.

#### Adaptive Highbeam Assist

##### General notes

You can use this function to set the headlamps to change between low beam and high beam automatically. The system recognizes vehicles with their lights on, either approaching from the opposite direction or traveling in front of your vehicle, and consequently switches the headlamps from high beam to low beam.

The system automatically adapts the low-beam headlamp range depending on the distance to the other vehicle. Once the system no longer detects any other vehicles, it reactivates the high-beam headlamps.

The system's optical sensor is located behind the windshield near the overhead control panel.

### Important safety notes

#### WARNING

Adaptive Highbeam Assist does not recognize road users:

- who have no lights, e.g. pedestrians
- who have poor lighting, e.g. cyclists
- whose lighting is blocked, e.g. by a barrier

On very rare occasions, Adaptive Highbeam Assist may fail to recognize other road users that have lights, or may recognize them too late. In this, or in similar situations, the automatic high-beam headlamps will not be deactivated or will be activated regardless. There is a risk of an accident.



Always carefully observe the traffic conditions and switch off the high-beam headlamps in good time.

Adaptive Highbeam Assist cannot take into account road, weather or traffic conditions. Adaptive Highbeam Assist is only an aid. You are responsible for adjusting the vehicle's lighting to the prevailing light, visibility and traffic conditions.

In particular, the detection of obstacles can be impaired if:

- there is poor visibility, e.g. due to fog, heavy rain or snow
- there is dirt on the sensors or anything else covering the sensors

### Switching Adaptive Highbeam Assist on/off

- ▶ **To switch on:** turn the light switch to the  position.
- ▶ Press the combination switch forwards beyond the pressure point (▷ page 113). The  indicator lamp on the multifunction display lights up when it is dark and the light sensor switches on the low-beam headlamps.



If you are driving at speeds above approximately 16 mph (25 km/h):

The headlamp range is set automatically depending on the distance between the vehicle and other road users.

If you are driving at speeds above approximately 19 mph (30 km/h) and no other road users are detected:

The high-beam headlamps are switched on automatically. The  indicator lamp on the instrument cluster also lights up.

If you are driving at speeds below approximately 16 mph (25 km/h) or other road users are detected or the roads are adequately lit:

The high-beam headlamps are switched off automatically. The  indicator lamp on the instrument cluster goes out. The  indicator lamp on the multifunction display remains lit.

- ▶ **To switch off:** move the combination switch back to its normal position or move the light switch to another position.

The  indicator lamp on the instrument cluster goes out.

### Headlamps fogged up on the inside

Certain climatic and physical conditions may cause moisture to form in the headlamp. This moisture does not affect the functionality of the headlamp.

## Interior lighting

### Overview of interior lighting

#### Front overhead control panel



- ① Left-hand front reading lamp
- ② Automatic interior lighting control
- ③ Front interior lighting
- ④ Rear interior lighting
- ⑤ Right-hand front reading lamp

#### Control panel in the grab handle (rear compartment)



- ① Reading lamp
- ② Switches the reading lamp on/off

### Interior lighting control

#### General notes

In order to prevent the vehicle's battery from discharging, the interior lighting functions are automatically deactivated after some time except for when the SmartKey is in position **2** in the ignition lock.

The color and brightness of the ambient lighting are set using the multimedia system (see Digital Operator's Manual).

#### Automatic interior lighting control

- **To switch on or off:** press the button. When the automatic interior lighting control is activated, the button is flush with the overhead control panel.

The interior lighting automatically switches on if you:

- unlock the vehicle
- open a door
- remove the SmartKey from the ignition lock

The interior lighting is switched on for a set time when the SmartKey is removed from the ignition lock. This delayed switch-off can be adjusted via the multimedia system (see Digital Operator's Manual).

## Replacing bulbs

### Important safety notes

#### WARNING

Bulbs, lamps and connectors can get very hot when operating. If you change a bulb, you could burn yourself on these components. There is a risk of injury.

Allow these components to cool down before changing a bulb.

Do not use a bulb if it has been dropped or if its glass tube has been scratched.

The bulb may explode if:

- you touch it
- it is hot
- you drop it
- you scratch it

Use bulbs only in closed lamps that have been designed for this purpose. Only install spare bulbs of the same type and the specified voltage.

Marks on the glass tube reduce the service life of the bulbs. Do not touch the glass tube with your bare hands. If necessary, clean the glass tube when cold with alcohol or spirit and rub it off with a lint-free cloth.

Protect bulbs from moisture during operation. Do not allow bulbs to come into contact with liquids.

Replace only the bulbs listed (▷ page 117). Have the bulbs that you cannot change yourself replaced at a qualified specialist workshop.

If you require assistance replacing bulbs, consult a qualified specialist workshop.

If the new bulb still does not light up, consult a qualified specialist workshop.

Headlamps and lights are an important aspect of vehicle safety. You must therefore make sure that these function correctly at all times. Have the headlamp setting checked regularly.

**Vehicles with LED headlamps:** the front and rear light clusters of your vehicle are equipped with LED bulbs. Do not replace the bulbs yourself. Contact a qualified specialist workshop which has the necessary specialist knowledge and tools to carry out the work required.

### Overview of bulb types

You can replace the following bulbs. The bulb type can be found in the legend.

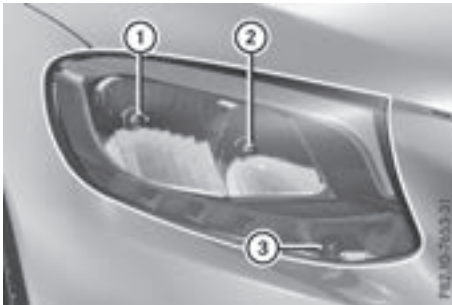

#### Halogen headlamps

- ① Low-beam headlamp: H7 55 W
- ② High-beam headlamp: H7 55 W
- ③ Turn signal lamp: PY 21 W



#### Rear lamp cluster

- ① Backup lamp: W 16 W

### Replacing front bulbs (vehicles with halogen headlamps)

#### Low-beam headlamps

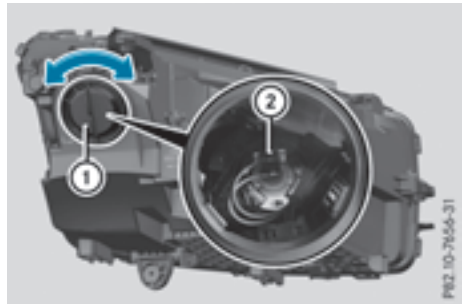

- ▶ Switch off the lights.
- ▶ Open the hood.
- ▶ Turn housing cover ① counter-clockwise and remove it.
- ▶ Push bulb holder ② up and pull out.
- ▶ Pull defective bulb out of bulb holder ②.
- ▶ Insert new bulb into bulb holder ②.
- ▶ Insert bulb holder ② into groove with lug at top.
- ▶ Push bulb holder ② down until it engages audibly.
- ▶ Press on housing cover ① and turn it clockwise.



## High-beam headlamps

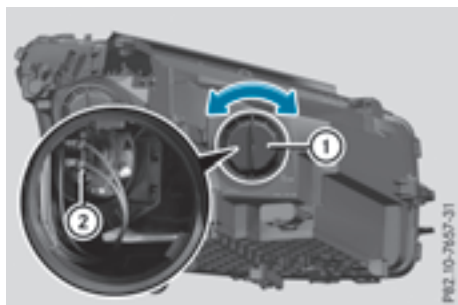

- ▶ Switch off the lights.
- ▶ Open the hood.
- ▶ Turn housing cover ① counter-clockwise and remove it.
- ▶ Push bulb holder ② upwards and pull out.
- ▶ Pull defective bulb out of bulb holder ②.
- ▶ Insert new bulb into bulb holder ②.
- ▶ Insert bulb holder ② into groove with lug at top.
- ▶ Push bulb holder ② down until it engages audibly.
- ▶ Press on housing cover ① and turn it clockwise.

## Turn signals

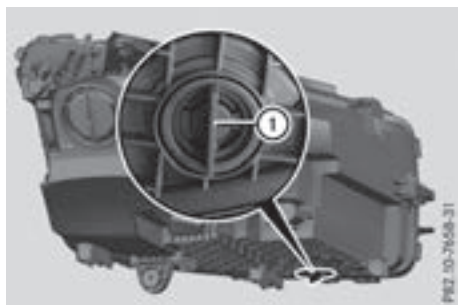

- ▶ Remove the cover in the front wheel housing (▷ page 118).
- ▶ Turn bulb holder ① counter-clockwise using the grip under the headlamp casing and remove it downwards with bulb.
- ▶ Turn defective bulb counter-clockwise and remove it from bulb holder ①.
- ▶ Insert new bulb into bulb holder ①.

- ▶ Insert bulb holder ①, turn it clockwise and lock.
- ▶ Replace the cover in the front wheel housing (▷ page 118).

## Removing and installing the cover in the front wheel housing

You must remove the cover of the front wheel housing before you can change the front turn signal lamp.



- ▶ **To remove:** switch off the lights.
- ▶ Turn the front wheels inwards.
- ▶ Turn rotary knob ① 180° outwards until it stops using a suitable object. Cover ② is released.
- ▶ Fold cover ② up.
- ▶ **To install:** insert cover ② into the left, right and two lower catches.
- ▶ Turn rotary knob ① 180° inwards until it stops using a suitable object. Cover ② is locked.



## Replacing rear bulbs (vehicles with halogen headlamps)

### Opening and closing the side trim panels



Example: right-hand side paneling

You must open the side trim panel in the cargo compartment before you can replace the bulbs in the tail lamps.

- ▶ **To open:** release right or left side trim panel ① at the top and fold it down in the direction of the arrow.
- ▶ **To close:** insert side trim panel ①.

### Rear lamp cluster

#### Changing the backup lamp

Due to their location, have the bulbs in the backup lamp in the tailgate replaced at a qualified specialist workshop.

- ▶ Switch off the lights.
- ▶ Open the tailgate.

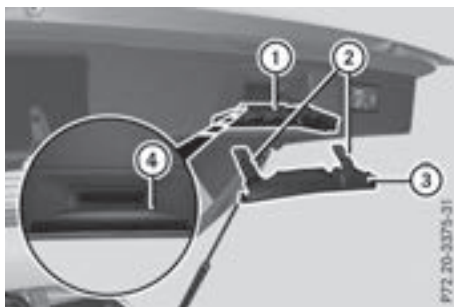

Example: right-hand side handle

- ▶ In recess ④ on the inside of the closing handle, pry off and remove the upper section of

handle ③ with a flat, smooth object, e.g. a screwdriver.

- ▶ Pull the lower section of handle ① with a strong tug to remove it from the trim and then place it to one side.

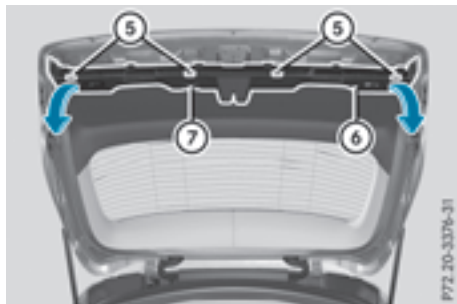

- ▶ Reach under the right-hand side of trim ⑥ and lightly tug along the entire length of the trim in order to unclip it.
- ▶ Pull out connector ⑦ of the surround lighting by releasing the latches.
- ▶ Vehicles with EASY-PACK tailgate: pull out the plug connector for the switch at the top right of the trim.
- ▶ Vehicles with electric fold-out trailer tow hitch: unlock and pull out the plug connector for the switch at the top left of the trim.
- ▶ Place trim ⑥ to one side.



- ▶ Unclip the remaining part of trim ⑧ from the assembly on the corresponding side using a sudden, sharp movement, until bulb holder ⑨ is accessible.



- ▶ Pull the defective bulb out of bulb holder ⑨.
- ▶ Insert the new bulb into bulb holder ⑨.
- ▶ Position trim ⑧ and engage it in place by tapping it with your hand.
- ▶ Check that all the metal clips are inserted in the parts that were placed to one side: two clips ② in the upper section of handle ③ and four clips ⑤ in trim ⑥.
- ▶ If not, remove the missing metal clips from the metal openings in the tailgate and insert them in the appropriate places.
- ▶ Grasp trim ⑥ and connect plug connector ⑦ to the surround lighting.

**i** The surround lighting only illuminates when the tailgate has been shut and reopened.

- ▶ Vehicles with EASY-PACK tailgate: insert the plug connector for the switch at the top right of the trim.
- ▶ Vehicles with electric fold-out trailer tow hitch: insert the plug connector for the switch at the top left of the trim.
- ▶ Position trim ⑥ and engage it in place by tapping it with your hand, starting from the outside.
- ▶ Clip in the lower section of handle ① again.
- ▶ Insert and engage the upper section of handle ③ into lower section ①.

## Windshield wipers

### Switching the windshield wipers on/off

**!** Do not operate the windshield wipers when the windshield is dry, as this could damage the wiper blades. Moreover, dust that has collected on the windshield can scratch the glass if wiping takes place when the windshield is dry.

If it is necessary to switch on the windshield wipers in dry weather conditions, always use washer fluid when operating the windshield wipers.

**!** If the windshield wipers leave smears on the windshield after the vehicle has been washed in an automatic car wash, wax or other residues may be the reason for this. Clean the windshield using washer fluid after washing the vehicle in an automatic car wash.

**!** Intermittent wiping with rain sensor: due to optical influences and the windshield becoming dirty in dry weather conditions, the windshield wipers may be activated inadvertently. This could then damage the windshield wiper blades or scratch the windshield.

For this reason, you should always switch off the windshield wipers in dry weather.

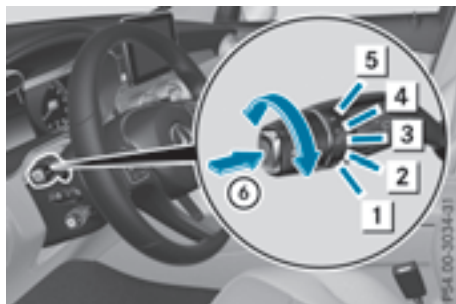

- |   |      |                             |
|---|------|-----------------------------|
| 1 | 0    | Windshield wiper off        |
| 2 | ...  | Intermittent wipe, normal   |
| 3 | .... | Intermittent wipe, frequent |
| 4 | —    | Continuous wipe, slow       |
| 5 | ==   | Continuous wipe, fast       |
| 6 |      | Single wipe                 |
|   |      | Wipe with washer fluid      |

- ▶ Switch on the ignition.
- ▶ Turn the combination switch to the corresponding position.

**Vehicles with a rain sensor:** in the .... or ... position, the appropriate wipe frequency is automatically set according to the intensity of the rain. In the .... position, the rain sensor is more sensitive than in the ... position, causing the windshield wiper to wipe more frequently.

If the wiper blades are worn, the windshield will no longer be wiped properly. This could prevent you from observing the traffic conditions.

## Switching the rear window wipers on/off



- ① Switch
- ② Wipes with washer fluid
- ③ Intermittent wiper
- ④ Switches off intermittent wiper
- ⑤ Wipes with washer fluid

- ▶ Turn the SmartKey to position ① or ② in the ignition lock (▷ page 136).
- ▶ Turn switch ① on the combination switch to the corresponding position. When the rear window wiper is switched on, the symbol appears in the instrument cluster.

## Replacing the wiper blades

### Important safety notes

#### WARNING

If the windshield wipers begin to move while you are changing the wiper blades, you could be trapped by the wiper arm. There is a risk of injury.

Always switch off the windshield wipers and ignition before changing the wiper blades.

- ❗ Never open the hood/tailgate if a wiper arm has been folded away from the windshield/rear window.

Never fold a windshield wiper arm without a wiper blade back onto the windshield/rear window.

Hold the windshield wiper arm firmly when you change the wiper blade. If you release the wiper arm without a wiper blade and it falls onto the windshield/rear window, the wind-

shield/rear window may be damaged by the force of the impact.

Mercedes-Benz recommends that you have the wiper blades changed at a qualified specialist workshop.

- ❗ To avoid damaging the wiper blades, make sure that you touch only the wiper arm of the wiper.

## Changing the windshield wiper blades

### Moving the wiper arms to a vertical position

#### On vehicles without KEYLESS-GO or KEYLESS-GO start function:

- ▶ Turn the SmartKey to position ① or ② in the ignition lock (▷ page 136).
- ▶ Set the windshield wipers to the position on the combination switch.
- ▶ When the wiper arms are vertical to the hood, turn the SmartKey to position ④ in the ignition lock and remove SmartKey.
- ▶ Fold the wiper arm away from the windshield.

#### On vehicles with KEYLESS-GO or KEYLESS-GO start function:

- ▶ Switch off the engine.
- ▶ Remove your foot from the brake pedal.
- ▶ Set the windshield wiper to the position on the combination switch.
- ▶ Press the Start/Stop button repeatedly until the windshield wiper starts.
- ▶ When the wiper arms are vertical to the hood, press the Start/Stop button.
- ▶ Fold the wiper arm away from the windshield.

### Removing the wiper blades

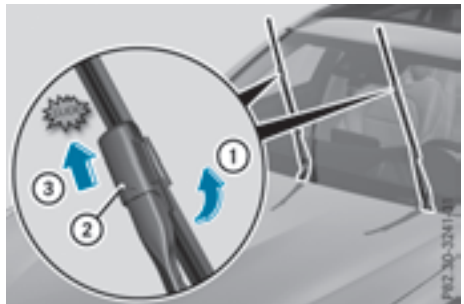

- ▶ Hold on to the wiper arm with one hand. With the other hand, turn the wiper blade in the direction of arrow ① away from the wiper arm as far as it will go.
- ▶ Slide the catch ② in the direction of arrow ③ until it engages in the removal position with a noticeable click.

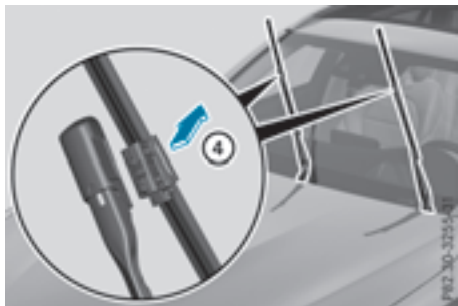

- ▶ Remove the wiper blade in the direction of arrow ④ away from the wiper arm.

### Installing the wiper blades

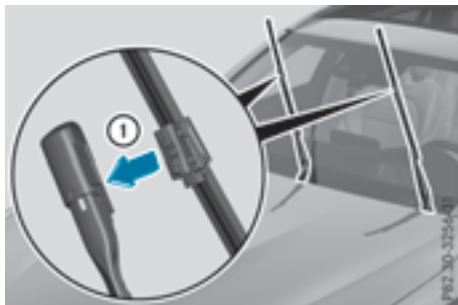

- ▶ Insert the new wiper blade into the wiper arm in the direction of arrow ①.

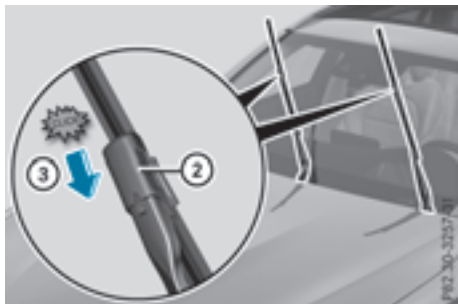

- ▶ Slide the catch ② in the direction of arrow ③ until it engages in the locking position with a noticeable click.
- ▶ Make sure that the wiper blade is seated correctly.
- ▶ Fold the wiper arm back onto the windshield.



- ▶ Remove the protective film ① from the service indicator on the tip of the wiper blade.

If the color of the service indicator changes from black to yellow, the wiper blades should be replaced.

- ① The duration of the color change varies depending on the usage conditions.

### Changing the rear window wiper blade

#### Removing a wiper blade

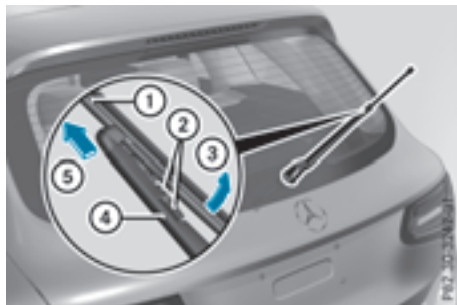

- ▶ Switch off the engine.
- ▶ Remove the SmartKey from the ignition lock. or, on vehicles with KEYLESS-GO or KEYLESS-GO start function:
- ▶ Open the driver's door. The vehicle electronics are now in position ①. This is the same as: "Key removed".

- ▶ Fold wiper arm ④ away from the rear window.
- ▶ Press both release clips ②.
- ▶ Fold wiper blade ① in the direction of arrow ③ away from wiper arm ④.
- ▶ Remove wiper blade ① in the direction of arrow ⑤.
- ▶ Position new wiper blade ① with recess ⑥ on lug ⑤.
- ▶ Fold wiper blade ① in the direction of arrow ③ onto the wiper arm until retaining clips ② engage in bracket ④.
- ▶ Make sure that wiper blade ① is seated correctly.
- ▶ Fold the wiper arm back onto the rear window.

### Installing a wiper blade



### Problems with the windshield wipers

Problem	Possible causes/consequences and ▶ Solutions
The windshield wipers are jammed.	<p>Leaves or snow, for example, are obstructing windshield wiper movement. The wiper motor has been deactivated.</p> <ul style="list-style-type: none"> <li>▶ Switch off the engine.</li> <li>▶ Remove the SmartKey from the ignition lock.</li> </ul> <p>or, on vehicles with KEYLESS-GO or KEYLESS-GO start function:</p> <ul style="list-style-type: none"> <li>▶ Open the driver's door. The vehicle electronics are now in position <b>0</b>. This means: "Key removed".</li> <li>▶ Remove the cause of the obstruction.</li> <li>▶ Switch the windshield wipers back on.</li> </ul>
The windshield wipers fail completely.	<p>The windshield wiper drive is malfunctioning.</p> <ul style="list-style-type: none"> <li>▶ Select another wiper speed on the combination switch.</li> <li>▶ Have the windshield wipers checked at a qualified specialist workshop.</li> </ul>
The windshield washer fluid from the spray nozzles no longer hits the center of the windshield.	<p>The spray nozzles are misaligned.</p> <ul style="list-style-type: none"> <li>▶ Have the spray nozzles adjusted at a qualified specialist workshop.</li> </ul>

## Overview of climate control systems

### General notes

Observe the settings recommended on the following pages. The windows could otherwise fog up.

To prevent the windows from fogging up:

- switch off climate control only briefly
- switch on air-recirculation mode only briefly
- switch on the cooling with air dehumidification function
- activate the "Windshield defrosting" function briefly, if required

Climate control regulates the temperature and air humidity in the vehicle interior. The interior filter cleans the air, thus improving the interior climate.

The "Cooling with air dehumidification" function is only available when the engine is running. Optimum climate control is only achieved with the side windows and roof closed.

If you start the engine using your smartphone, the last selected climate control setting is reactivated (▷ page 139).

The integrated filter filters out most particles of dust and soot and completely filters out pollen.

It also reduces gaseous pollutants and odors. A clogged filter reduces the amount of air supplied to the vehicle interior. For this reason, you should always observe the interval for replacing the filter, which is specified in the Maintenance Booklet. As it depends on environmental conditions, e.g. heavy air pollution, the interval may be shorter than stated in the Maintenance Booklet.

- i** Ventilate the vehicle for a brief period during warm weather, e.g. using the convenience opening feature (▷ page 92). This will speed up the cooling process and the desired interior temperature will be reached more quickly.
- i** It is possible that the blower may be activated automatically 60 minutes after the Smart-Key has been removed depending on various factors, e.g. the outside temperature. The vehicle is then ventilated for 30 minutes to dry the automatic climate control.
- i** **Hybrid vehicles:** be sure to observe the notes in the supplement. Otherwise, you may not recognize dangers.

### Control panel for dual-zone automatic climate control

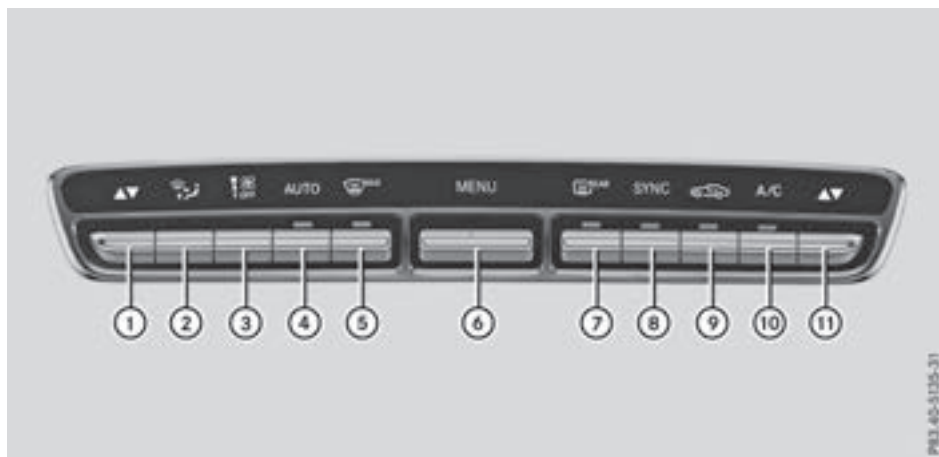

Example: control panel for dual-zone automatic climate control

- ① Sets the temperature, left (▷ page 128)
- ② Sets the air distribution (▷ page 129)



- ③ Sets the airflow (▷ page 129)
- Switches off climate control (▷ page 127)
- ④ Sets climate control to automatic (▷ page 128)
- ⑤ Defrosts the windshield (▷ page 130)
- ⑥ Calls up the climate control menu of the multimedia system (▷ page 284)
- ⑦ Switches the rear window defroster on/off (▷ page 130)
- ⑧ Activates or deactivates synchronization (▷ page 130)
- ⑨ Switches air-recirculation mode manually on/off (▷ page 131)
- ⑩ Switches cooling with air dehumidification on/off (▷ page 128)
- ⑪ Sets the temperature, right (▷ page 128)

### Control panel for 3-zone automatic climate control

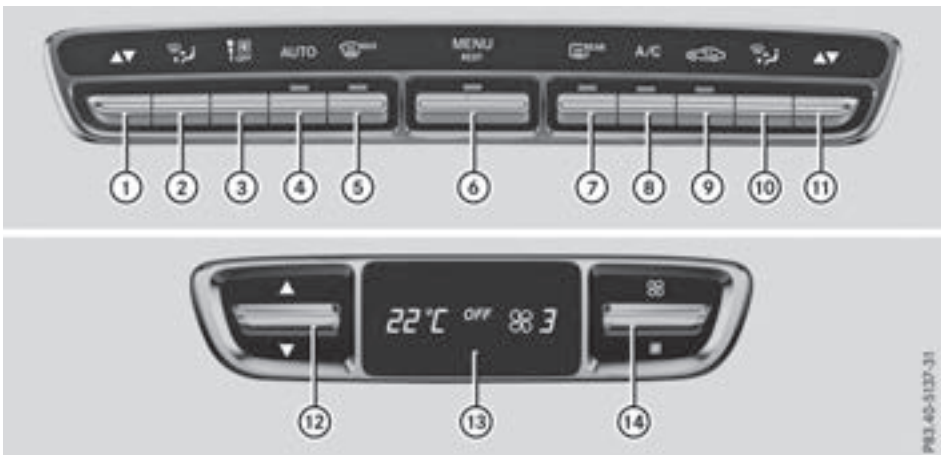

Example for vehicles in Canada: control panel for 3-zone automatic climate control

#### Front control panel

- ① Sets the temperature, left (▷ page 128)
- ② Sets the air distribution, left (▷ page 129)
- ③ Sets the airflow (▷ page 129)
- Switches off climate control (▷ page 127)
- ④ Sets climate control to automatic (▷ page 128)
- ⑤ Defrosts the windshield (▷ page 130)
- ⑥ Calls up the climate control menu of the multimedia system (▷ page 284)
- Switches the residual heat on/off (▷ page 131)
- ⑦ Switches the rear window defroster on/off (▷ page 130)
- ⑧ Switches cooling with air dehumidification on/off (▷ page 128)
- ⑨ Switches air-recirculation mode manually on/off (▷ page 131)
- ⑩ Sets the air distribution, right (▷ page 129)
- ⑪ Sets the temperature, right (▷ page 128)

#### Rear control panel

- ⑫ Sets the temperature (▷ page 128)



- ⑬ Display
- ⑭ Sets the airflow (▷ page 129)

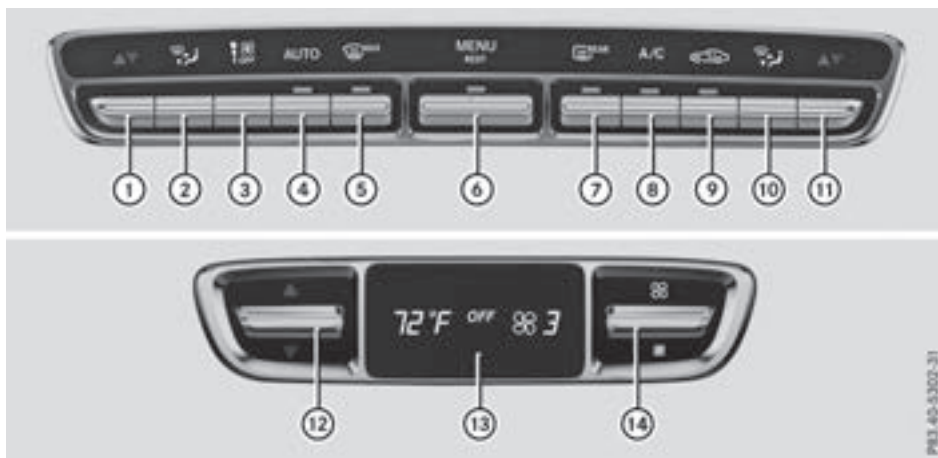

Example for vehicles in the USA: control panel for 3-zone automatic climate control

#### Front control panel

- ① Sets the temperature, left (▷ page 128)
- ② Sets the air distribution, left (▷ page 129)
- ③ Sets the airflow (▷ page 129)  
Switches off climate control (▷ page 127)
- ④ Sets climate control to automatic (▷ page 128)
- ⑤ Defrosts the windshield (▷ page 130)
- ⑥ Calls up the climate control menu of the multimedia system (▷ page 284)  
Switches the residual heat on/off (▷ page 131)
- ⑦ Switches the rear window defroster on/off (▷ page 130)
- ⑧ Switches cooling with air dehumidification on/off (▷ page 128)
- ⑨ Switches air-recirculation mode manually on/off (▷ page 131)
- ⑩ Sets the air distribution, right (▷ page 129)
- ⑪ Sets the temperature, right (▷ page 128)

#### Rear control panel

- ⑫ Sets the temperature (▷ page 128)
- ⑬ Display
- ⑭ Sets the airflow (▷ page 129)

### Optimum use of automatic climate control

#### Optimum use of automatic climate control

The following contains notes and recommendations on how best to use dual-zone automatic climate control or 3-zone automatic climate control.

- ▶ Activate climate control using the **AUTO** rocker switch. The indicator lamp above the **AUTO** rocker switch lights up. The "Cooling with dehumidification" function is activated in automatic mode.
- ▶ Set the temperature to 72 °F (22 °C).

**i** Only use the "Windshield defrosting" function briefly until the windshield is clear again.

- i** Only use air-recirculation mode briefly, e.g. if there are unpleasant outside odors or when in a tunnel. The windows could otherwise fog up, since no fresh air is drawn into the vehicle in air-recirculation mode.

Vehicles with 3-zone automatic climate control: use the "Residual heat" function if you want to heat or ventilate the vehicle interior when the ignition is switched off. The residual heat function can only be activated or deactivated with the ignition switched off. The residual heat function is deactivated when the ignition is switched on.

### DYNAMIC SELECT switch (except Mercedes-AMG GLC 63 4MATIC/ GLC 63 S 4MATIC)

You can choose between various drive programs with the DYNAMIC SELECT switch (> page 144).

If you have selected drive program **E**:

- when heating, the electrical heater booster is deactivated and heat output is reduced as a result
- the rear window defroster running time is reduced

If you have selected drive program **C**, **S** or **S+**, the current climate settings are maintained.

### ECO start/stop function

During automatic engine switch-off, the climate control system only operates at a reduced capa-

city. If you require the full climate control output, you can switch off the ECO start/stop function by pressing the ECO button (> page 142).

## Operating the climate control systems



### Activates/deactivates climate control

#### General notes

When the climate control is switched off, the air supply and air circulation are also switched off. The windows could fog up. Therefore, switch off climate control only briefly

Switch on climate control primarily using the  rocker switch (> page 128).

#### Activating/deactivating

- ▶ Turn the SmartKey to position **2** in the ignition lock (> page 136).
- ▶ **To switch on:** set the airflow to level **1** or higher using the  rocker switch.
- ▶ **To switch off:** set the airflow to level **0** using the  rocker switch.

- i** 3-zone automatic climate control: when climate control is switched off, "OFF" appears in the rear-compartment display.

## Switching cooling with air dehumidification on/off

### General notes

If you deactivate the "Cooling with air-dehumidification" function, the air inside the vehicle will not be cooled. The air inside the vehicle will also not be dehumidified. The windows can fog up more quickly. Therefore, only deactivate the "Cooling with air-dehumidification" function briefly.

The "Cooling with air dehumidification" function is only available when the engine is running. The air inside the vehicle is cooled and dehumidified according to the temperature selected.

Condensation may drip from the underside of the vehicle when it is in cooling mode. This is normal and not a sign that there is a malfunction.

## Activating/deactivating

- ▶ Press the  rocker switch up or down.  
The indicator lamp above the rocker switch lights up or goes out.

## Problems with the "Cooling with air dehumidification" function

Problem	Possible causes/consequences and ▶ Solutions
The indicator lamp above the  rocker switch remains off. The cooling with air dehumidification function cannot be activated via the multimedia system any longer (▷ page 285).	Cooling with air dehumidification has been deactivated due to a malfunction. ▶ Visit a qualified specialist workshop.







## Setting climate control to automatic

### General notes

In automatic mode, the set temperature is maintained automatically at a constant level. The system automatically regulates the temperature of the dispensed air, the airflow and the air distribution.

During automatic controlling, the "Cooling with air dehumidification" function is activated.

### Automatic control

- ▶ Turn the SmartKey to position  in the ignition lock (▷ page 136).
- ▶ **To activate:** press the  rocker switch up or down.  
The indicator lamp above the  rocker switch lights up.
- ▶ Set the desired temperature using the  rocker switch on the front control unit.
- ▶ **To switch to manual operation:** press the  rocker switch up or down.  
or
- ▶ Press the  rocker switch up or down.  
The indicator lamp above the  rocker switch goes out.

In automatic mode, if you adjust the airflow or air distribution manually, the indicator lamp above the  rocker switch goes out. The function which has not been changed manually, however, continues to be controlled automatically. When the manually set function switches

back to automatic mode, the indicator lamp above the  rocker switch lights up again.

## Adjusting the climate mode settings

This function is only available with 3-zone automatic climate control.

In automatic mode you can select the following airflow settings for the driver's and front-passenger areas:



- FOCUS high airflow, slightly cooler setting
- MEDIUM medium airflow, standard setting
- DIFFUSE low airflow, slightly warmer and draft-free setting

- ▶ **To set:** set the climate mode using the multimedia system (▷ page 285).

## Setting the temperature

### Dual-zone automatic climate control

Different temperatures can be set for the driver's and front-passenger sides.

- ▶ Turn the SmartKey to position  in the ignition lock (▷ page 136).
- ▶ **To increase or reduce:** press the  rocker switch up or down.  
Only change the temperature setting in small increments. Start at 72 °F (22 °C).

## Dual-zone automatic climate control

### General notes

You can select different temperature settings for the driver's and front-passenger sides as well as for the rear compartment.

### Setting the temperature in the front compartment using the front control panel

- ▶ Turn the SmartKey to position **2** in the ignition lock (▷ page 136).
- ▶ **To increase or reduce:** press rocker switch  up or down.

Only change the temperature setting in small increments. Start at 72 °F (22 °C).









### Setting the temperature in the rear compartment using the rear control panel

- ▶ Turn the SmartKey to position **2** in the ignition lock (▷ page 136).
- ▶ **To increase or reduce:** press the  rocker switch on the rear control panel up or down (▷ page 125).

Only change the temperature setting in small increments. Start at 72 °F (22 °C).  
The set temperature appears on the rear-compartment display.

## Setting the air distribution

### Air distribution settings

-  Directs air through the defroster vents
-  Directs air through the center and side air vents
-  Directs air through the footwell air vents
-  Directs air through the center, side and footwell vents
-  Directs air through the defroster and footwell vents
-  Directs air through the defroster, center, side and footwell vents
-  Directs air through the defroster, center and side air vents
-  Sets the air distribution to automatic

## Setting

3-zone automatic climate control: you can set the air distribution separately for the driver's and front-passenger side.

- ▶ Turn the SmartKey to position **2** (▷ page 136).
- ▶ Press the  rocker switch up or down. The various air distribution settings appear in the multimedia system.

## Setting the airflow



### Setting the front-compartment airflow

- ▶ Turn the SmartKey to position **2** in the ignition lock (▷ page 136).
- ▶ **To increase or reduce:** press rocker switch  up or down.

### Setting the rear compartment airflow using the rear control panel

It is only possible to set the airflow using the rear control panel on vehicles with 3-zone automatic climate control.

You can set the airflow separately for the front and rear compartment.

- ▶ Turn the SmartKey to position **2** in the ignition lock (▷ page 136).
- ▶ **To increase or reduce:** press rocker switch  or  on the rear control panel up or down. The selected airflow level appears in the rear display.

## Activating or deactivating the synchronization function

### General notes

The "Synchronization" function is available only with dual-zone automatic climate control and 3-zone automatic climate control.

Climate control can be set centrally using the synchronization function. The temperature setting is adopted for the front-passenger side. For 3-zone automatic climate control, the temperature setting is adopted for the front-passenger side and rear compartment.

## Activating/deactivating

### Dual-zone automatic climate control

- ▶ Press the **SYNC** rocker switch up or down. The indicator lamp above the **SYNC** rocker switch lights up or goes out.

The synchronization function deactivates if the settings for the front-passenger side are changed.

### 3-zone automatic climate control

- ▶ Activate or deactivate the "Synchronization" function using the multimedia system (> page 285).

The synchronization function is deactivated:

- if the settings for the front-passenger side are changed
- the settings for the rear compartment are changed

## Defrosting the windshield



### General notes

You can use this function to defrost the windshield or to clear a fogged up windshield or front side windows on the inside.

Switch off the "Windshield defrosting" function as soon as the windshield is clear again.

### Switching the "Windshield defrosting" function on or off

- ▶ Turn the SmartKey to position **2** in the ignition lock (> page 136).

- ▶ **To switch on:** press rocker switch  up or down. The indicator lamp above the  rocker switch lights up. The current climate control settings are deactivated.

The climate control system switches to the following functions:

- high airflow
- high temperature
- air distribution to the windshield and front side windows
- air-recirculation mode off

- ▶ **i** If necessary, the "Cooling with air dehumidification" function is activated. In this case,



the indicator lamp above the  rocker switch remains switched off.

- ▶ **To switch off:** press rocker switch  up or down.

The indicator lamp above the  rocker switch goes out. The previously selected settings are restored. Air-recirculation mode remains deactivated.

## Defrosting the windows

### Windows fogged up on the inside

- ▶ Activate the "Cooling with air dehumidification" function with the  rocker switch.
- ▶ Switch on automatic mode using the **AUTO** rocker switch.
- ▶ If the windows continue to fog up, activate the "Windshield defrosting" function using the  rocker switch.

- ▶ **i** You should only select this setting until the windshield is clear again.

### Windows fogged up on the outside

- ▶ Activate the windshield wipers.
- ▶ Switch on automatic mode using the **AUTO** rocker switch.

- ▶ **i** If you clean the windows regularly, they do not fog up so quickly.

## Rear window defroster



### General notes

The rear window defroster has a high current draw. You should therefore switch it off as soon as the rear window is clear. Otherwise, the rear window defroster switches off automatically after several minutes.

If the battery voltage is too low, the rear window defroster may switch off.

## Activating/deactivating

- ▶ Turn the SmartKey to position **2** in the ignition lock (> page 136).

- ▶ Press rocker switch  up or down. The indicator lamp above rocker switch  lights up or goes out.

## Problems with the rear window defroster

Problem	Possible causes/consequences and ► Solutions
The rear window defroster has deactivated prematurely or cannot be activated.	<p>The battery has not been sufficiently charged.</p> <p>► Switch off any consumers that are not required, e.g. reading lamps, interior lighting or the seat heating.</p> <p>When the battery is sufficiently charged, the rear window defroster can be activated again.</p>

### Switching air-recirculation mode on/off



#### General notes

You can also temporarily deactivate the flow of fresh air manually if unpleasant odors are entering the vehicle from outside. The air already inside the vehicle will then be recirculated.

If you switch on air-recirculation mode, the windows can fog up more quickly, in particular at low temperatures. Only use air-recirculation mode briefly to prevent the windows from fogging up.

#### Activating/deactivating



► Turn the SmartKey to position **2** in the ignition lock (► page 136).

► **To activate:** press the  rocker switch up or down.  
The indicator lamp above the  rocker switch lights up.

Air-recirculation mode switches on automatically:

- at high outside temperatures
- at high levels of pollution (3-zone automatic climate control only)
- in a tunnel (vehicles with a navigation system only)

The indicator lamp above the  rocker switch is not lit when automatic air-recirculation mode is activated. Outside air is added after about 30 minutes.

► **To deactivate:** press the  rocker switch up or down.  
The indicator lamp above the  rocker switch goes out.

Air-recirculation mode deactivates automatically:

- after approximately five minutes at outside temperatures below approximately 41 °F (5 °C)
- after approximately five minutes if cooling with air dehumidification is deactivated
- after approximately 30 minutes at outside temperatures above approximately 41 °F (5 °C) if the "Cooling with dehumidification" function is activated

### Switching the residual heat on or off



#### General notes

The residual heat function is only available with 3-zone automatic climate control.

Once the engine is switched off, it is possible to make use of the residual heat of the engine to continue heating or ventilating the front compartment of the vehicle for approximately 30 minutes. The heating or ventilation time depends on the interior temperature that has been set.

#### Activating/deactivating

► Turn the SmartKey to position **0** in the ignition lock or remove it (► page 136).

► **To activate:** press the  rocker switch up or down.  
The indicator lamp above the  rocker switch lights up.

The blower will run at a low speed regardless of the airflow setting.

If you activate the residual heat function at high temperatures, only the ventilation will be activated. The blower runs at medium speed.

► **To deactivate:** press the  rocker switch up or down.

The indicator lamp above the  rocker switch goes out.

Residual heat is deactivated automatically:

- after approximately 30 minutes
- when the ignition is switched on
- if the battery voltage drops

## Perfume atomizer

### Operating the perfume atomizer

#### WARNING

If children open the vial, they could drink the perfume or it could come into contact with their eyes. There is a risk of injury. Therefore, do not leave children unsupervised in the vehicle.

If the perfume liquid has been drunk, consult a doctor. If perfume comes into contact with your eyes or skin, rinse the eyes with clean water. If you continue to experience difficulties, consult a doctor.

#### Environmental note



Full vials must not be disposed of with household waste. They must be collected separately and recycled to protect the environment.



Dispose of full vials in an environmentally responsible manner and take them to a harmful substance collection point.



- ① Vial lid
- ② Vial

The perfume atomizer helps to improve driving comfort.

Via the multimedia system you can:

- switch the perfume atomizer on/off (▷ page 285)
- regulate the perfume intensity (▷ page 285)

The following conditions can affect your perception of the perfume intensity:

- operating mode of automatic climate control
- interior temperature
- time of year or day
- air humidity
- physiological condition of occupants, e.g. fatigue or hunger

The perfume atomizer is active only when the glove box is closed.

The perfume atomizer is provided with a pre-filled vial. You can also choose from a variety of pre-filled vials and an empty vial which you can fill yourself.

If you refill an empty perfume vial, observe the separate information sheet attached to the vial.

**!** If you do not use genuine Mercedes-Benz interior perfumes, observe the safety notes on the perfume packaging.

Do not refill the pre-filled vial when it is empty. Dispose of the used vial after use.

- **To insert the perfume vial:** open the glove box (▷ page 291).
- Slide the perfume vial into the holder as far as it will go.
- **To remove the perfume vial:** pull out the perfume vial.



- ▶ **To refill the perfume vial:** unscrew the lid of the empty perfume vial to refill it yourself.
- ▶ Fill the perfume vial with a maximum of 0.5 fl. oz. (15 ml) of the desired liquid perfume.
- ▶ Screw the lid back on to the vial.

**!** Only refill the perfume vial when you are outside the vehicle. Otherwise, liquid perfume could drip into the interior and contaminate it.

Always refill the empty refillable vial with the same perfume. Otherwise, you might not achieve optimum results from the perfume atomizer.

## Problems with the perfume atomizer

Problem	Possible causes/consequences and ▶ Solutions
The vehicle interior is not perfumed although the perfume atomizer is activated.	The perfume vial has not been pushed into the holder as far as it will go. <ul style="list-style-type: none"> <li>▶ Slide the perfume vial into the holder as far as it will go.</li> </ul>
	The perfume vial is not filled sufficiently. <ul style="list-style-type: none"> <li>▶ <b>Pre-filled vials:</b> dispose of the empty vial.</li> <li>▶ Use a new pre-filled vial.</li> <li>▶ <b>Refillable vials:</b> refill the vial with a maximum of 0.5 fl. oz. (15 ml) of the same perfume.</li> </ul>
	The perfume atomizer is faulty. <ul style="list-style-type: none"> <li>▶ Have the perfume atomizer checked at a qualified specialist workshop.</li> </ul>

### Ionization

Ionization is used to purify the air in the vehicle interior and attain an improved interior climate. The ionization of the interior air is odorless and cannot be perceived directly in the vehicle interior.

You can switch ionization on/off using the multimedia system (> page 285).

Ionization can only be operated when the automatic climate control is switched on. The side air vent on the driver's side must be open.

the immediate vicinity of the air vents. There is a risk of injury.

Make sure that all vehicle occupants always maintain a sufficient distance to the air outlets. If necessary, redirect the airflow to another area of the vehicle interior.

In order to ensure the direct flow of fresh air through the air vents into the vehicle interior, please observe the following notes:

- keep the air inlet between the windshield and the hood free of blockages, such as ice, snow or leaves.
- never cover the air vents or air intake grilles in the vehicle interior.

## Air vents

### Important safety notes

#### WARNING

Very hot or very cold air can flow from the air vents. This could result in burns or frostbite in

## Setting the air vents

Air vents are located:

- on the left and right-hand side of the dashboard
- in the middle of the dashboard
- in the rear center console, depending on the equipment installed



Side air vent (example)

- ① Side window defroster vent
- ② Side air vent, left
- ③ Control for left side air vent

- ▶ **To open or close:** turn control ③ to the counter-clockwise or clockwise as far as it will go.
- ▶ **To adjust the air direction:** hold side air vent ② by control ③ and move it up or down or to the left or right.

Adjusting the rear air vents (see the Digital Operator's Manual).

## Notes on breaking-in a new vehicle

### Important safety notes

The sensor system of some driving and driving safety systems adjusts automatically while a certain distance is being driven after the vehicle has been delivered or after repairs. Full system effectiveness is not reached until the end of this teach-in procedure.

New and replaced brake pads and discs only reach their optimum braking effect after several hundred kilometers of driving. Compensate for this by applying greater force to the brake pedal.

### The first 1,000 miles (1,500 km)

The more you look after the engine when it is new, the more satisfied you will be with its performance in the future.

- You should therefore drive at varying vehicle and engine speeds for the first 1,000 miles (1,500 km).
- Avoid heavy loads, e.g. driving at full throttle, during this period.
- When changing gears manually, change up in good time, before the tachometer needle reaches  $\frac{2}{3}$  of the way to the red area of the tachometer.
- Do not manually shift to a lower gear to brake the vehicle.
- Try to avoid depressing the accelerator pedal beyond the pressure point (kickdown).
- **All vehicles (except Mercedes-AMG vehicles):** ideally, for the first 1,000 miles (1,500 km), drive in drive program **E**.

Additional breaking-in notes for Mercedes-AMG vehicles:

- Do not drive faster than 85 mph (140 km/h) for the first 1,000 miles (1,500 km).
- Only briefly allow the engine to reach a maximum engine speed of 4,500 rpm.
- Change gear in good time.
- Ideally, for the first 1,000 miles (1,500 km), drive in program **C**.

After 1,000 miles (1,500 km), you can increase the engine speed gradually and accelerate the vehicle to full speed.

You should also observe these notes on breaking in if the engine or parts of the drive train on your vehicle have been replaced.

Always observe the maximum permissible speed.

### Rear axle locking differential (Mercedes-AMG GLC 63 4MATIC+ / GLC 63 S 4MATIC+)

Your vehicle is equipped with a self-locking differential on the rear axle.

Change the oil to improve protection of the rear axle differential:

- after a breaking-in period of 1,850 miles (3,000 km)
- every 31,000 miles (50,000 km) or 3 years

These oil changes prolong the service life of the differential. Have the oil change carried out at a qualified specialist workshop.

## Driving

### Important safety notes

#### WARNING

Objects in the driver's footwell may restrict the clearance around the pedals or block a depressed pedal. This jeopardizes the operating and road safety of the vehicle. There is a risk of an accident.

Stow all objects securely in the vehicle so that they do not get into the driver's footwell.

When using floor mats or carpets, make sure that they are properly secured so that they do not slip or obstruct the pedals. Do not place several floor mats or carpets on top of one another.

#### WARNING

Unsuitable footwear can hinder correct usage of the pedals, e.g.:

- shoes with thick soles
- shoes with high heels
- slippers

There is a risk of an accident.

Wear suitable footwear to ensure correct usage of the pedals.

**⚠ WARNING**

If you switch off the ignition while driving, safety-relevant functions are only available with limitations, or not at all. This could affect, for example, the power steering and the brake boosting effect. You will require considerably more effort to steer and brake. There is a risk of an accident.

Do not switch off the ignition while driving.

**⚠ WARNING**

If the parking brake has not been fully released when driving, the parking brake can:

- overheat and cause a fire
- lose its hold function.

There is a risk of fire and an accident. Release the parking brake fully before driving off.

- !** Do not warm up the engine while stationary. Pull away immediately. Avoid high engine speeds and full throttle until the engine has reached its operating temperature.

In vehicles with automatic transmission, engage positions P and R only when the vehicle is stationary.

Where possible, avoid spinning the drive wheels when pulling away on slippery roads. You could otherwise damage the drive train.

- !** **Mercedes-AMG vehicles:** at low engine oil temperatures below 68 °F (+20 °C), the maximum engine speed is restricted in order to protect the engine. To protect the engine and maintain smooth engine operation, avoid driving at full throttle when the engine is cold.

**Hybrid vehicles:** be sure to observe the notes in the Supplement. Otherwise, you may not recognize dangers.

**Key positions****SmartKey**

- 0** To remove the SmartKey
- 1** Power supply for some consumers, such as the windshield wipers
- 2** Ignition (power supply for all consumers) and drive position
- 3** To start the engine

- i** The SmartKey can be turned in the ignition lock even if it is not the correct SmartKey for the vehicle. The ignition is not switched on. The engine cannot be started.

**Start/Stop button****General notes**

When you insert the Start/Stop button into the ignition lock, the system needs approximately two seconds recognition time. You can then use the Start/Stop button.

Pressing the Start/Stop button several times in succession corresponds to the different SmartKey positions in the ignition lock. This is only the case if you are not depressing the brake pedal.

If you depress the brake pedal and press the Start/Stop button, the engine starts immediately.

A check which periodically establishes a radio connection between the vehicle and the SmartKey determines whether a valid SmartKey is in the vehicle. This occurs, for example, when starting the engine.

To start the vehicle without actively using the SmartKey:

- the Start/Stop button must be inserted in the ignition lock.
- the SmartKey must be in the vehicle.
- the vehicle must not be locked with the SmartKey or KEYLESS-GO. (▷ page 79)

Do not keep the SmartKey:

- with electronic devices, e.g. a mobile phone or another SmartKey.
- with metallic objects, e.g. coins or metal foil.
- inside metallic objects, e.g. a metal case.

This can affect the functionality of the SmartKey.

If you lock the vehicle with the SmartKey remote control or with KEYLESS-GO, after a short time:

- you will not be able to switch on the ignition with the Start/Stop button.
- you will no longer be able to start the engine with the Start/Stop button until the vehicle is unlocked again.

If you lock the vehicle centrally using the button on the front door (▷ page 84), you can continue to start the engine with the Start/Stop button.

The engine can be switched off while the vehicle is in motion by pressing and holding the Start/Stop button for three seconds. This function operates independently of the ECO start/stop automatic engine switch-off function.

### Key positions with the Start/Stop button



- ① Start/Stop button
- ② Ignition lock

As soon as the ignition is switched on, all the indicator lamps in the instrument cluster light up. Warning and indicator lamps: see (▷ page 268).

If Start/Stop button ① has not yet been pressed, this corresponds to the SmartKey being removed from the ignition.

- ▶ **To switch on the power supply:** press Start/Stop button ① once.  
The power supply is switched on. You can now activate the windshield wipers, for example.

The power supply is switched off again if:

- the driver's door is opened and
- you press Start/Stop button ① twice when in this position

- ▶ **To switch on the ignition:** press Start/Stop button ① twice.  
The ignition is switched on.

The ignition is switched off again if:

- you do not start the engine from this position within 15 minutes
- you press Start/Stop button ① once when in this position

The power supply is switched off again if:

- the driver's door is opened and
- you press Start/Stop button ① once when in this position

### Removing the Start/Stop button

You can remove the Start/Stop button from the ignition lock and start the vehicle as normal using the SmartKey.

It is possible to switch between Start/Stop button mode and key operation only when the transmission is in position **P**.

- ▶ Remove Start/Stop button ① from ignition lock ②.

You do not have to remove the Start/Stop button from the ignition lock when you leave the vehicle. You should, however, always take the SmartKey with you when leaving the vehicle. As long as the SmartKey is in the vehicle:

- the vehicle can be started using the Start/Stop button
- the electrically powered equipment can be operated

## Starting the engine

### Important safety notes

#### WARNING

If children are left unsupervised in the vehicle, they could:

- open the doors, thus endangering other people or road users.
- get out and disrupt traffic.
- operate the vehicle's equipment.

Additionally, children could set the vehicle in motion if, for example, they:

- release the parking brake.
- shifting the automatic transmission out of park position **P**
- Start the engine.

There is a risk of an accident and injury.

When leaving the vehicle, always take the SmartKey with you and lock the vehicle. Never leave children or animals unattended in the vehicle. Always keep the SmartKey out of reach of children.

#### WARNING

Combustion engines emit poisonous exhaust gases such as carbon monoxide. Inhaling these exhaust gases leads to poisoning. There is a risk of fatal injury. Therefore never leave the engine running in enclosed spaces without sufficient ventilation.

#### WARNING

Flammable materials introduced through environmental influence or by animals can ignite if in contact with the exhaust system or parts of the engine that heat up. There is a risk of fire.

Carry out regular checks to make sure that there are no flammable foreign materials in the engine compartment or in the exhaust system.

## General notes

The catalytic converter is preheated for up to 30 seconds after a cold start. The sound of the engine may change during this time.

### Automatic transmission

- ▶ Shift the transmission to position **P** (▷ page 146).  
The transmission position indicator on the multifunction display shows **P** (▷ page 148).

 You can start the engine in transmission position **P** and **N**.

### Starting procedure with the SmartKey

To start the engine using the SmartKey instead of the Start/Stop button, pull the Start/Stop button out of the ignition lock.

- ▶ Turn the SmartKey to position **3** in the ignition lock and release it as soon as the engine is running.

If the engine will not start:

- ▶ Remove the SmartKey from the ignition lock.
- ▶ Reinsert the SmartKey into the ignition lock after a short waiting period.
- ▶ Turn the SmartKey to position **2** in the ignition lock (▷ page 136).  
The indicator lamps in the instrument cluster light up (▷ page 268).
- ▶ Turn the SmartKey to position **3** in the ignition lock (▷ page 136) and release it as soon as the engine is running.

### Starting procedure with the Start/Stop button

The Start/Stop button is only available on vehicles with KEYLESS-GO or the KEYLESS-GO start function.

The Start/Stop button can be used to start the vehicle manually without inserting the SmartKey into the ignition lock. The Start/Stop button must be inserted in the ignition lock and the SmartKey must be in the vehicle. This mode for starting the engine operates independently of the ECO start/stop automatic engine start function.

You can start the engine if a valid SmartKey is in the vehicle. Switch off the engine and always

take the SmartKey with you when leaving the vehicle, even if you only leave it for a short time. Pay attention to the important safety notes.

- ▶ Depress the brake pedal and keep it depressed.
- ▶ Press the Start/Stop button once (▷ page 137).  
The engine starts.

### Starting procedure via smartphone

Observe the important safety notes on starting the engine (▷ page 138).

You can also start your engine via your smartphone from outside the vehicle. In this case, the previously selected climate control setting is activated. In this way you can cool or heat the interior of the vehicle before starting the journey.

Only start the engine via your smartphone if it is safe to start and run the engine where your vehicle is parked.

Observe the legal stipulations in the area where your vehicle is parked. Engine start via smartphone may be limited to certain countries or regions.

You can execute a maximum of two consecutive starting attempts via your smartphone. If you press the start/stop button or insert the SmartKey into the ignition lock, you can carry out two more starting attempts with your smartphone.

The engine runs for ten minutes when starting with the smartphone.

Once you have started the engine, you can switch the engine off via your smartphone at any time.

You can only start the engine via your smartphone if:

- the SmartKey is in the ignition lock
- park position **P** is selected
- the accelerator pedal is not depressed
- the anti-theft alarm system is not activated
- the panic alarm is not activated
- the hazard warning lamps are switched off
- the hood is closed
- the doors are closed and locked
- the windows and sliding sunroof are closed

Also make sure that:

- the fuel tank is sufficiently filled
- the starter battery has been sufficiently charged

#### WARNING

Limbs could be crushed or trapped if the engine is started unintentionally during service or maintenance work. There is a risk of injury.

Always secure the engine against unintentional starting before carrying out maintenance or repair work.

Make sure that the engine cannot be started via your smartphone before carrying out maintenance or repairs. You can prevent an engine start via your smartphone, for example, if you:

- switch on the hazard warning lamps
- do not lock the doors
- open a side window
- open the sliding sunroof

### Pulling away

#### General notes

#### WARNING

If the engine speed is above the idling speed and you engage transmission position **D** or **R**, the vehicle could pull away suddenly. There is a risk of an accident.

When engaging transmission position **D** or **R**, always firmly depress the brake pedal and do not simultaneously accelerate.

Depress the accelerator carefully when pulling away.

The vehicle locks centrally once you have pulled away. The locking knobs in the doors drop down. You can open the doors from the inside at any time.

You can also deactivate the automatic locking feature, see the Digital Operator's Manual.

It is possible to shift the transmission from position **P** to the desired position only if you depress the brake pedal. Only then is the parking lock released. If you do not depress the brake pedal, the DIRECT SELECT lever can still



be moved but the parking lock remains engaged.

- i** Upshifts take place at higher engine speeds after a cold start. This helps the catalytic converter to reach its operating temperature more quickly.

Information on the automatic release of the electric parking brake (▷ page 160).

### Pulling away with a trailer



To ensure that you do not roll backwards when pulling away on an uphill slope, engage the electric parking brake.

- ▶ Press and hold handle **1**.  
The electric parking brake continues to brake and prevent the vehicle from rolling backwards.  
The red **PARK** (USA only) or **(P)** (Canada only) indicator lamp in the instrument cluster remains on.
- ▶ Depress the accelerator pedal.
- ▶ As soon as the vehicle/trailer combination is held by the driving force of the engine, release lever **1**.  
The electric parking brake is released.  
The red **PARK** (USA only) or **(P)** (Canada only) indicator lamp in the instrument cluster goes out.

For further information on the electric parking brake, see (▷ page 159).

### Hill start assist

Hill start assist helps you when pulling away forward or in reverse on an uphill gradient. It holds the vehicle for a short time after you have removed your foot from the brake pedal. This gives you enough time to move your foot from

the brake pedal to the accelerator pedal and to depress it before the vehicle begins to roll.

#### **⚠ WARNING**

After a short time, hill start assist will no longer brake your vehicle and it could roll away. There is a risk of an accident and injury.

Therefore, quickly move your foot from the brake pedal to the accelerator pedal. Never leave the vehicle when it is held by hill start assist.

Hill start assist is not active if:

- you are pulling away on a level road or on a downhill gradient.
- the transmission is in position **N**
- the electric parking brake is applied.
- ESP<sup>®</sup> is malfunctioning

### ECO start/stop function

#### Introduction

The ECO start/stop function switches the engine off automatically if the vehicle is stopped under certain conditions.

The engine starts automatically when the driver wants to pull away again. The ECO start/stop function thereby helps you to reduce the fuel consumption and emissions of your vehicle.

#### Important safety notes

#### **⚠ WARNING**

If the engine is switched off automatically and you exit the vehicle, the engine is restarted automatically. The vehicle may begin moving. There is a risk of accident and injury.

If you wish to exit the vehicle, always turn off the ignition and secure the vehicle against rolling away.

## General notes



### ① ECO start/stop display

The ECO start/stop function is activated whenever you start the engine using the SmartKey or the Start/Stop button.

If the engine has been switched off automatically by the ECO start/stop function, the  symbol is shown in the multifunction display.

**Mercedes-AMG GLC 63 4MATIC+/GLC 63 S 4MATIC+:** the ECO start/stop function is automatically switched on only in drive program **C**. The ECO start/stop function is activated whenever you switch on the engine using the SmartKey or the Start/Stop button.

## Automatic engine switch-off

If the vehicle is braked to a standstill with the transmission in **D** or **N**, the ECO start/stop function switches off the engine automatically. The ECO start/stop function is operational when:

- the indicator lamp in the ECO button is lit green
- the outside temperature and the atmospheric air pressure is within the range that is suitable for the system
- the engine is at normal operating temperature
- the set temperature for the vehicle interior has been reached
- the battery is sufficiently charged
- the system detects that the windshield is not fogged up when the air-conditioning system is switched on
- the hood is closed
- the driver's door is closed and the driver's seat belt is fastened

All of the vehicle's systems remain active when the engine is stopped automatically.

The HOLD function can also be activated if the engine has been switched off automatically. It is then not necessary to continue applying the

brakes during the automatic stop phase. When you depress the accelerator pedal, the engine starts automatically and the braking effect of the HOLD function is deactivated.

**Mercedes-AMG GLC 63 4MATIC+:** the number of consecutive automatic engine stops is unlimited.

**All other models:** automatic engine switch-off can take place a maximum of four times in a row (initial switch-off, then three subsequent switch-offs).

## Automatic engine start

The engine starts automatically if:

- you switch off the ECO start/stop function by pressing the ECO button
- **Mercedes-AMG GLC 63 4MATIC+:** you switch to drive program **S+** or **S**
- **all other models:** you switch to drive program **S+**
- you permanently activate manual gearshifting (▷ page 152)
- in transmission position **D** or **N**, the brake pedal is released and the HOLD function is not active
- you depress the accelerator pedal
- you engage reverse gear **R**
- you move the transmission out of position **P**
- you unfasten your seat belt or open the driver's door
- the vehicle starts to roll
- the brake system requires this
- the temperature in the vehicle interior deviates from the set range
- the system detects moisture on the windshield when the air-conditioning system is switched on
- the condition of charge of the battery is too low

Shifting the transmission to position **P** does not start the engine.

## Deactivating or activating the ECO start/stop function

### Mercedes-AMG vehicles



- ▶ **To deactivate:** press ECO button ①. Indicator lamp ② goes out.
- ▶ **To activate:** press ECO button ①. Indicator lamp ② lights up.

If indicator lamp ② is off, the ECO start/stop function has been switched off manually or as the result of a malfunction. The engine will then not be switched off automatically when the vehicle stops.

The ECO start/stop function is deactivated, if:

- **Mercedes-AMG GLC 43 4MATIC:** you switch to drive program **S+** (▷ page 144)
- **Mercedes-AMG GLC 63 4MATIC+:** you switch to drive program **S+** or **S** (▷ page 144)
- you permanently activate manual gearshifting (▷ page 152)

If you have permanently activated manual gearshifting and then press ECO button ①, the ECO start/stop function is switched on.

### All other models



- ▶ **To deactivate:** press ECO button ①. Indicator lamp ② goes out.

- ▶ **To activate:** press ECO button ①. Indicator lamp ② lights up.

If indicator lamp ② is off, the ECO start/stop function has been deactivated manually or as the result of a malfunction. The engine will then not be switched off automatically when the vehicle stops.

Selecting drive program **S+** deactivates the ECO start/stop function. If you press ECO button ①, the ECO start/stop function is activated.

### AMG Performance adjustable exhaust system (Mercedes-AMG vehicles)

The volume of the AMG Performance adjustable exhaust system changes depending on the position of the switchable exhaust flap. The exhaust flap is adjusted automatically according to the selected drive program (▷ page 144).

You can also adjust the position of the exhaust flap and therefore the volume of the exhaust system manually.

The automatic adjustment of the exhaust flap is always active when you change drive program, regardless of the manual setting.

Each time you start the engine with the Smart-Key or the Start/Stop button, the quietest setting is activated.



Setting the volume:

- ▶ Press button ①. If you select the loudest setting, indicator lamp lights up ②.

**Mercedes-AMG GLC 63 4MATIC+/GLC 63 S 4MATIC+:** you can preset the volume of the exhaust system for drive program **I** (Individual). Information on DYNAMIC SELECT and on con-

figuring drive program I with the multimedia system (see the Digital Operator's Manual).

Problems with the engine	
Problem	Possible causes/consequences and ► Solutions
The engine does not start.	<p>The HOLD function or Distance Pilot DISTRONIC is activated.</p> <ul style="list-style-type: none"> <li>► Deactivate the HOLD function (▷ page 179) or Distance Pilot DISTRONIC (▷ page 176).</li> <li>► Try to start the engine again (▷ page 138).</li> </ul>
The engine does not start. The starter motor can be heard.	<ul style="list-style-type: none"> <li>• There is a malfunction in the engine electronics.</li> <li>• There is a malfunction in the fuel supply.</li> </ul> <p>Before attempting to start the engine again:</p> <ul style="list-style-type: none"> <li>► Turn the SmartKey back to position <b>0</b> in the ignition lock.</li> </ul> <p>or</p> <ul style="list-style-type: none"> <li>► Press the Start/Stop button repeatedly until all indicator lamps in the instrument cluster go out.</li> <li>► Try to start the engine again (▷ page 138). Avoid excessively long and frequent attempts to start the engine as these will drain the battery.</li> </ul> <p>If the engine does not start after several attempts:</p> <ul style="list-style-type: none"> <li>► Consult a qualified specialist workshop.</li> </ul>
The engine does not start. The starter motor can be heard. The reserve fuel warning lamp is lit and the fuel gage display is at the reserve level.	<p>The fuel tank is empty.</p> <ul style="list-style-type: none"> <li>► Refuel the vehicle.</li> </ul>
The engine does not start. You cannot hear the starter motor.	<p>The on-board voltage is too low because the battery is too weak or discharged.</p> <ul style="list-style-type: none"> <li>► Jump-start the vehicle (▷ page 341).</li> </ul> <p>If the engine does not start despite attempts to jump-start it:</p> <ul style="list-style-type: none"> <li>► Consult a qualified specialist workshop.</li> </ul> <p>The starter motor was exposed to a thermal load that was too high.</p> <ul style="list-style-type: none"> <li>► Try to start the engine again (▷ page 138).</li> </ul> <p>If the engine still does not start:</p> <ul style="list-style-type: none"> <li>► Consult a qualified specialist workshop.</li> </ul>

Problem	Possible causes/consequences and ► Solutions
The engine is not running smoothly and is misfiring.	There is a malfunction in the engine electronics or in a mechanical component of the engine management system. <ul style="list-style-type: none"> <li>► Only depress the accelerator pedal slightly. Otherwise, non-combusted fuel may get into the catalytic converter and damage it.</li> <li>► Have the cause rectified immediately at a qualified specialist workshop.</li> </ul>
The coolant temperature display indicates a value within the red band.	The coolant level is too low. The coolant is too hot and the engine is no longer being cooled sufficiently. <ul style="list-style-type: none"> <li>► Stop as soon as possible and allow the engine and the coolant to cool down.</li> <li>► Check the coolant level (► page 322). Observe the warning notes as you do so and add coolant if necessary.</li> </ul>

## DYNAMIC SELECT switch

### Mercedes-AMG vehicles

#### General information

Use the DYNAMIC SELECT switch to select the drive program.

#### Available drive programs for Mercedes-AMG GLC 43 4MATIC:

<b>S+</b> Sport Plus	Particularly sporty driving characteristics
<b>S</b> Sport	Sporty driving characteristics
<b>C</b> Comfort	Comfortable and economical driving characteristics
<b>E</b> Economy	Particularly economical driving characteristics
<b>I</b> Individual	Individual settings

#### Available drive programs for Mercedes-AMG GLC 63 4MATIC+/GLC 63 S 4MATIC+:

<b>RACE</b> (S-MODEL)	Driving characteristics suitable for a race circuit
<b>S+</b> Sport Plus	Particularly sporty driving characteristics
<b>S</b> Sport	Sporty driving characteristics

<b>C</b> Comfort	Comfortable and economical driving characteristics
<b>I</b> Individual	Individual settings

Depending on the drive program selected the following vehicle characteristics will change:

- the drive (engine and transmission management)
- the suspension
- the steering
- the driver assistance systems
- ESP® (Mercedes-AMG GLC 63 4MATIC+/GLC 63 S 4MATIC+)
- the position of the exhaust flap (Mercedes-AMG GLC 63 4MATIC+/GLC 63 S 4MATIC+)
- the setting of the ECO start/stop function
- the availability of gliding mode
- the climate control

Further information for automatic drive program characteristics (► page 150).

Additionally, in drive program **I** you can configure the respective vehicle characteristics using the multimedia system. You can find information about this under "DYNAMIC SELECT" in the vehicle's Digital Operator's Manual.

Each time you start the engine with the Smart-Key or the Start/Stop button, drive program **C** is activated. Further information about starting the engine (► page 138).

## Selecting the drive program



- Push DYNAMIC SELECT switch ① forwards or back until the desired drive program is selected. The symbol of the selected drive program is shown in the multifunction display. In addition, the current drive program settings are displayed briefly in the multimedia system display.

You can also change gear yourself using the steering wheel paddle shifters. For further information on the manual drive program (▷ page 152).

## Additional settings

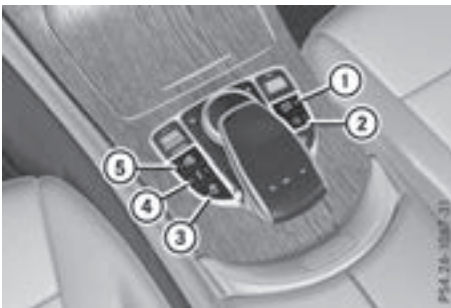

- ① Position of the exhaust flap (▷ page 142)
- ② ECO start/stop function (▷ page 140)
- ③ ESP® (▷ page 69)
- ④ Suspension (▷ page 186)
- ⑤ Permanently activates manual gearshifting (▷ page 152)

When you press buttons ① - ⑤ the corresponding setting is selected. The DYNAMIC SELECT switch setting is overwritten. If you switch to drive program I, all stored characteristics will be accepted. This is also the case

if you have previously pressed one of buttons ① - ⑤.

- i Mercedes-AMG GLC 43 4MATIC:** for a few countries, the ECO start/stop function is deactivated at the factory due to the quality of the available fuel. In this case, the ECO start/stop function is not available in any drive program, regardless of the display in the multimedia system display.

## All other models

**Hybrid vehicles:** be sure to observe the notes in the supplement. Otherwise, you may not recognize dangers.

Use the DYNAMIC SELECT switch to change the drive program.

Depending on the drive program selected the following vehicle characteristics will change:

- the drive (engine and transmission management)
- the suspension
- the steering
- the ECO start/stop function
- the climate control:
  - the climate control settings
  - the rear window defroster operation period
  - the performance of the seat heating

Each time you start the engine with the Smart-Key or the Start/Stop button, drive program C is activated. For further information about starting the engine, see (▷ page 138).



- Push DYNAMIC SELECT switch ① forward or back until the desired drive program is selected. The symbol of the selected drive program is shown in the multifunction display.



In addition, the current drive program settings are displayed briefly in the multimedia system display.

- i** In a few countries, the ECO start/stop function is deactivated at the factory due to the available fuel grade. In this case, the ECO start/stop function is not available in any drive program, regardless of the display in the multimedia system display.

#### Available drive programs:

<b>I</b> Individual	Individual settings
<b>S+</b> Sport Plus	Particularly sporty driving characteristics
<b>S</b> Sport	Sporty driving characteristics
<b>C</b> Comfort	Comfortable and economical driving characteristics
<b>E</b> Economy	Particularly economical driving characteristics

Additional information for drive programs (▷ page 150).

You can also change gear yourself using the steering wheel paddle shifters. For further information on the manual drive program (▷ page 152).

**Vehicles with the Off-Road Engineering package:** information on the off-road programs (▷ page 181).

## Automatic transmission

### Important safety notes

#### WARNING

If the engine speed is above the idling speed and you engage transmission position **D** or **R**, the vehicle could pull away suddenly. There is a risk of an accident.

When engaging transmission position **D** or **R**, always firmly depress the brake pedal and do not simultaneously accelerate.

#### WARNING

The automatic transmission switches to neutral position **N** when you switch off the engine.

The vehicle may roll away. There is a risk of an accident.

After switching off the engine, always switch to parking position **P**. Prevent the parked vehicle from rolling away by applying the parking brake.

**Hybrid vehicles:** be sure to observe the notes in the supplement. Otherwise, you may not recognize dangers.

### DIRECT SELECT lever

#### Overview of transmission positions



- P** Park position with parking lock
- R** Reverse gear
- N** Neutral
- D** Drive

The DIRECT SELECT lever is on the right of the steering column.

The DIRECT SELECT lever always returns to its original position. The current transmission position **P**, **R**, **N** or **D** is shown on the transmission position display on the multifunction display (▷ page 148).

#### Selects park position

**!** If the engine speed is too high or the vehicle is coasting, do not shift the automatic transmission directly from **D** to **R**, from **R** to **D** or directly to **P**. Otherwise, the automatic transmission may be damaged.

- ▶ Push the DIRECT SELECT lever switch in the direction of arrow **P**.



## Engaging park position automatically

Park position **P** is automatically engaged if:

- you switch off the engine using the SmartKey and remove the SmartKey
- you switch off the engine using the SmartKey or using the Start/Stop button and open the driver's door or front-passenger door
- you open the driver's door when the vehicle is stationary or when driving at a very low speed and the transmission is in position **D** or **R**

Under certain conditions, the automatic transmission shifts to transmission position **P** automatically if the HOLD function or Distance Pilot DISTRONIC is activated. Observe the information on the HOLD function (▷ page 179) and Distance Pilot DISTRONIC (▷ page 174).

## Engaging reverse gear

**!** Only move the automatic transmission to **R** when the vehicle is stationary.

- ▶ Depress the brake pedal.
- ▶ Push the DIRECT SELECT lever up past the first point of resistance.

The ECO start/stop function is not available when reverse gear is engaged. Further information on the ECO start/stop function (▷ page 141).

## Engaging neutral

### WARNING

If children are left unsupervised in the vehicle, they could:

- open the doors, thus endangering other people or road users.
- get out and disrupt traffic.
- operate the vehicle's equipment.

Additionally, children could set the vehicle in motion if, for example, they:

- release the parking brake.
- shifting the automatic transmission out of park position **P**
- Start the engine.

There is a risk of an accident and injury.

When leaving the vehicle, always take the SmartKey with you and lock the vehicle. Never

leave children or animals unattended in the vehicle. Always keep the SmartKey out of reach of children.

- ▶ If the transmission is in position **D** or **R**: push the DIRECT SELECT lever up or down to the first point of resistance.
- ▶ If the transmission is in position **P**: depress the brake pedal and push the DIRECT SELECT lever up or down to the first point of resistance.

If you switch the engine off with the transmission in position **R** or **D**, the automatic transmission shifts to **N** automatically.

**With the SmartKey:** if you then open the driver's door or the front-passenger door or remove the SmartKey from the ignition lock, the automatic transmission shifts to **P** automatically.

**With the Start/Stop button:** if you then open the driver's door or the front-passenger door, the automatic transmission shifts to **P** automatically.

If you want the automatic transmission to remain in neutral **N**, e.g. when having the vehicle cleaned in an automatic, tow-through car wash:

- ▶ **Vehicles with KEYLESS-GO or KEYLESS-GO start function:** remove the Start/Stop button from the ignition lock.
- ▶ Insert the SmartKey into the ignition lock.
- ▶ **All vehicles:** switch the ignition on.
- ▶ Depress the brake pedal and keep it depressed.
- ▶ Engage neutral **N**.
- ▶ Release the brake pedal.
- ▶ Release the electric parking brake.
- ▶ Switch off the ignition and leave the SmartKey in the ignition lock.

## Engaging the drive position

- ▶ If the transmission is in position **R** or **N**: push the DIRECT SELECT lever down past the first point of resistance.
- ▶ If the transmission is in position **P**: depress the brake pedal and push the DIRECT SELECT lever down past the first point of resistance.

### Transmission position and drive program display

The current transmission position and drive program appear in the multifunction display.

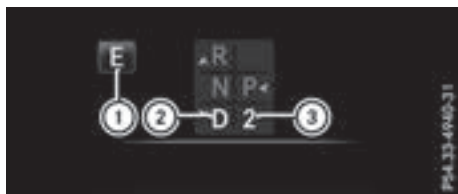

- ① Status symbol drive program
- ② Transmission position
- ③ Gear

The arrows in the transmission position display show how and into which transmission positions you can shift using the DIRECT SELECT lever.

If the transmission position display in the multifunction display is not working, you should pull away carefully to check whether the desired transmission position is engaged. Ideally, you should select transmission position **D** and drive program **E** or **S**.

### Transmission positions

**P**

#### Park position

This prevents the vehicle from rolling away when stopped.

Only shift the transmission into position **P** (> page 146) when the vehicle is stationary. The parking lock should not be used as a brake when parking. Always apply the electronic parking brake in addition to the parking lock in order to secure the vehicle.

Park position **P** is automatically engaged if:

- you switch off the engine using the SmartKey and remove the SmartKey
- you switch off the engine using the SmartKey or using the Start/Stop button and open the driver's door or front-passenger door
- you open the driver's door when the vehicle is stationary or when driving at a very low speed and the transmission is in position **D** or **R**

In the event of a malfunction of the vehicle's electronics, the transmission may lock in position **P**. Have the vehicle electronics checked immediately at a qualified specialist workshop.

**R**

#### Reverse gear

You can only shift the transmission into position **R** when the vehicle is stationary (> page 147).

**N****Neutral**

Do not shift the transmission to **N** while driving. Otherwise, the automatic transmission could be damaged.

No power is transmitted from the engine to the drive wheels.

Releasing the brake pedal will allow you to move the vehicle freely, e.g. to push it or tow it.

If ESP® is deactivated or faulty: shift the transmission to position **N** if the vehicle is in danger of skidding, e.g. on icy roads.

If you switch the engine off with the transmission in position **R** or **D**, the automatic transmission shifts to **N** automatically.

**!** Coasting in neutral **N** may cause damage to the drive train.

**D****Drive**

The automatic transmission changes gear automatically. All forward gears are available.

**Driving tips****Changing gear**

The automatic transmission shifts through the individual gears automatically when it is in transmission position **D**. This automatic gear shifting behavior is determined by:

- the selected drive program
- the position of the accelerator pedal
- the road speed

**Accelerator pedal position**

Your style of driving influences how the automatic transmission shifts gear:

- little throttle: early upshifts
- more throttle: late upshifts

**Double-clutch function**

When shifting down, the double-clutch function is active regardless of the currently selected drive program. The double-clutch function

reduces load change reactions and is conducive to a sporty driving style. The sound generated by the double-clutch function depends on the drive program selected.

**Kickdown**

Use kickdown for maximum acceleration.

- ▶ Depress the accelerator pedal beyond the pressure point.  
The automatic transmission shifts to a lower gear depending on the engine speed.
- ▶ Ease off the accelerator pedal once the desired speed is reached.  
The automatic transmission shifts back up.

**Gliding mode**

Gliding mode is available depending on the equipment.

Gliding mode is characterized by the following:

- The combustion engine is disconnected from the drive train.
- The engine speed corresponds to the idling speed.
- The multifunction display hides the gear indicator and displays transmission position **D** in green (▷ page 148).
- **Mercedes-AMG vehicles:** the multifunction display shows status icon ① for the drive program's status icon.

In drive program **E** or in drive program **C** (Mercedes-AMG GLC 63 4MATIC/ GLC 63 S 4MATIC) you can deactivate and activate gliding mode using the ECO button (▷ page 142).

Gliding mode can be activated under the following conditions:

- The speed is within a suitable range.
- The course of the road is suitable, e.g. there are no steep up or downhill gradients.
- You are no longer depressing the accelerator pedal.

Gliding mode is deactivated under the following conditions:

- You depress the accelerator pedal.
- You depress the brake pedal.
- You change the transmission position (▷ page 146).
- You switch to drive program **RACE** (Mercedes-AMG GLC 63 S 4MATIC), **S+** or **S** (▷ page 144).
- You activate manual gearshifting (▷ page 152).
- You leave the suitable speed range.

**i** If you have selected the "Eco" or "Comfort" (Mercedes-AMG GLC 63 4MATIC/GLC 63 S 4MATIC setting for the drive (engine and transmission management) in drive program **I**, you can also activate gliding mode. Information on DYNAMIC SELECT and on configuring drive program **I** with the multimedia system (see the Digital Operator's Manual).

## Towing a trailer

- ▶ Drive in the middle of the engine speed range on uphill gradients.
- ▶ **Manual shifting:** depending on the uphill or downhill gradient, shift into a gear (▷ page 152), in which the engine will run the middle of the engine speed range. This also applies when cruise control or Distance Pilot DISTRONIC are activated.

## Drive programs

### All vehicles except Mercedes-AMG GLC 63 4MATIC+/GLC 63 S 4MATIC+

#### Drive program **I** (Individual)

In drive program **I** the following properties of the drive program can be selected:

- the drive (engine and transmission management) and therefore indirectly the availability of gliding mode and the properties of the driver assistance systems
- the suspension
- the steering
- the availability of the ECO start/stop function
- the climate control

Information about configuring drive program **I** with the multimedia system can be found under "DYNAMIC SELECT" in the vehicle's Digital Operator's Manual.

#### Drive program **S+** (Sport Plus)

Drive program **S+** is characterized by the following:

- the vehicle exhibits particularly sporty driving characteristics.
- the vehicle pulls away in first gear.
- the automatic transmission shifts up later. The fuel consumption possibly being higher as a result of the later automatic transmission shift points.
- the suspension exhibits particularly stiff springing and damping settings (vehicles with AIR BODY CONTROL).
- gliding mode is not available.
- the ECO start/stop function is deactivated (▷ page 141).

#### Drive program **S** (Sport)

Drive program **S** is characterized by the following:

- the vehicle exhibits sporty driving characteristics.
- the vehicle pulls away in first gear.
- the automatic transmission shifts up later. The fuel consumption possibly being higher as a result of the later automatic transmission shift points.
- the suspension exhibits stiff springing and damping settings (vehicles with AIR BODY CONTROL).
- gliding mode is not available.
- the ECO start/stop function is activated (▷ page 141).

#### Drive program **C** (Comfort)

Drive program **C** is characterized by the following:

- the vehicle delivers comfortable, economical handling characteristics.
- the vehicle pulls away more gently in forward and reverse gears, unless the accelerator pedal is depressed fully.
- the vehicle has improved driving stability, for example on slippery road surfaces.
- optimal fuel consumption resulting from the automatic transmission shifting up sooner.

The vehicle is driven in the low engine speed range and the wheels are less likely to spin.

- gliding mode is not available.
- the ECO start/stop function is activated (▷ page 141).

### Drive program E (Economy)

Drive program **E** is characterized by the following:

- the vehicle exhibits particularly economical handling characteristics.
- the vehicle pulls away more gently in forward and reverse gears, unless the accelerator pedal is depressed fully.
- the vehicle has improved driving stability, for example on slippery road surfaces.
- optimal fuel consumption resulting from the automatic transmission shifting up sooner. The vehicle is driven in the low engine speed range and the wheels are less likely to spin.
- during deceleration, the engine is disconnected from the drive train. The vehicle uses kinetic energy and consumes less fuel.
- the cooling and heating output of the climate control system has been reduced.
- gliding mode is available.
- the ECO start/stop function is activated (▷ page 141).

### Mercedes-AMG GLC 63 4MATIC+ / GLC 63 S 4MATIC+

#### Drive program RACE (S-MODEL)

The **RACE** drive program is characterized by the following:

- the vehicle exhibits driving characteristics suitable for the racetrack.
- all vehicle systems are set for maximum sportiness.
- the gearshift recommendation gives you information for slowly warming up the drive assemblies and for adopting a fuel-efficient driving style (▷ page 152). You can follow the gearshift recommendations at all times and shift gear accordingly using the steering wheel paddle shifters. On the basis of the gearshift recommendation, using the steering wheel paddle shifters, you can optimize the drive train and engine operating mode at any time.

- if you have selected a gear manually, this will be maintained until the vehicle speed increases or decreases dramatically.
- the vehicle pulls away in first gear.
- the automatic transmission shifts up later, the fuel consumption possibly being higher as a result of the later automatic transmission shift points.
- the suspension exhibits particularly hard springing and damping settings.
- gliding mode is not available.
- the ECO start/stop function is switched off (▷ page 141).

#### Drive program S+ (Sport Plus)

Drive program **S+** is characterized by the following:

- the vehicle exhibits particularly sporty driving characteristics.
- the vehicle pulls away in first gear.
- the automatic transmission shifts up later, the fuel consumption possibly being higher as a result of the later automatic transmission shift points.
- the suspension exhibits particularly hard springing and damping settings.
- gliding mode is not available.
- the ECO start/stop function is switched off (▷ page 141).

#### Drive program S (Sport)

Drive program **S** is characterized by the following:

- the vehicle exhibits sporty driving characteristics.
- the vehicle pulls away in first gear.
- the automatic transmission shifts up later, the fuel consumption possibly being higher as a result of the later automatic transmission shift points.
- the suspension exhibits stiff springing and damping settings.
- gliding mode is not available.
- the ECO start/stop function is switched off (▷ page 141).

### Drive program C (Comfort)

Drive program **C** is characterized by the following:

- the vehicle delivers comfortable, economical handling characteristics.
- the vehicle pulls away more gently in forward and reverse gears, unless the accelerator pedal is depressed fully.
- the vehicle has improved driving stability, for example on slippery road surfaces.
- optimal fuel consumption resulting from the automatic transmission shifting up sooner. The vehicle is driven in the low engine speed range and the wheels are less likely to spin.
- gliding mode is available.
- the ECO start/stop function is switched on (> page 141).

### Drive program I (Individual)

In drive program **I** the following properties of the drive program can be selected:

- the drive (engine management) and therefore indirectly the availability of glide mode and the ECO start/stop function as well as the properties of the driver assistance systems
- the transmission management
- ESP® (> page 69)
- the suspension and therefore indirectly the steering
- activation of the exhaust flap

To permanently shift the gears manually in drive program **I** using the steering wheel paddle shifters, select the **M** (Manual) setting for the transmission management.

Information about configuring drive program **I** with the multimedia system can be found under "DYNAMIC SELECT" in the vehicle's Digital Operator's Manual.

## Manual gear shifting

### General notes

You can change gear yourself using the steering wheel paddle shifters. The transmission must be in position **D** for this.

Depending on which steering wheel paddle shifter is pulled, the automatic transmission

immediately shifts into the next gear down or up, if permitted.

To use manual shifting, you have two options:

- temporary setting
- permanent setting

If you activate manual gearshifting, the multi-function display will show the current gear and **M** instead of transmission position **D**.

If you deactivate manual gearshifting, the gears will be shifted automatically again.

### Temporary setting



► **To activate:** shift the DIRECT SELECT lever to position **D**.

► Pull steering wheel paddle shifter ① or ②.

The temporary setting is active for a certain amount of time. In certain conditions, the minimum amount of time is extended, e.g. in the case of lateral acceleration, overrun mode or driving on steep terrain.

► **To deactivate:** pull steering wheel paddle shifter ② and hold it in place.

or

► Use the DIRECT SELECT lever to switch the transmission position.

or

► Use the DYNAMIC SELECT switch to change the drive program.

### Permanent setting

■ **Mercedes-AMG vehicles:** the automatic transmission does not shift up automatically even when the engine limiting speed for the current gear is reached. When the engine limiting speed is reached, the fuel supply is cut to prevent the engine from overrevving. Always make sure that the engine speed does not

reach the red area of the tachometer. There is otherwise a risk of engine damage.

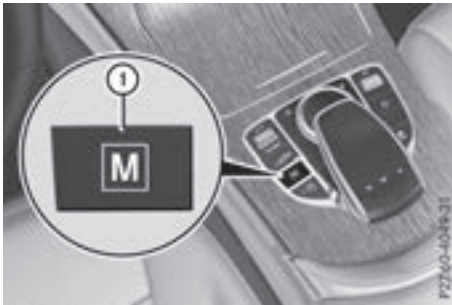

Manual mode button (except Mercedes-AMG vehicles)

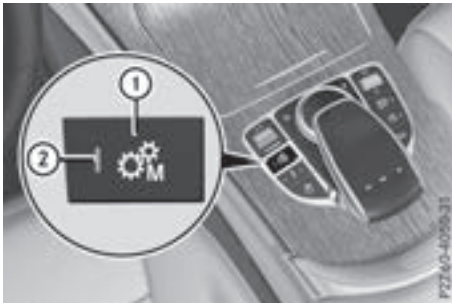

Manual mode button (Mercedes-AMG vehicles)

- ▶ **To activate/deactivate:** shift the DIRECT SELECT lever to position **D**.
- ▶ Press button ①.

**Mercedes-AMG vehicles:** when indicator lamp ② lights up, automatic transmission manual mode is activated.

The manual mode activated with button ① remains activated when the drive program is changed.

**Mercedes-AMG GLC 63 4MATIC+ / GLC 63 S 4MATIC+:** only if the **D** (Automatic) setting has been preselected for the transmission is manual mode deactivated when you change to drive program **I**.

**Mercedes-AMG GLC 63 4MATIC+ / GLC 63 S 4MATIC+:** you can also preset manual mode for drive program **I**. To do so, select the **M** (Manual) setting when configuring the transmission. When driving in drive program **I**, you permanently shift the gears manually using the steering wheel paddle shifters.

Information about configuring drive program **I** with the multimedia system can be found under

"DYNAMIC SELECT" in the vehicle's Digital Operator's Manual.

## Shifting gears



- ▶ **To shift up:** pull steering wheel paddle shifter ②.

The automatic transmission shifts up to the next gear.

If the maximum engine speed in the gear currently engaged is reached and you continue to accelerate, the automatic transmission automatically shifts up in order to prevent engine damage (except Mercedes-AMG vehicles).

**Mercedes-AMG vehicles:** if the temporary setting has been activated and you continue to accelerate when the maximum engine speed has been reached, the automatic transmission automatically shifts up. If the permanent setting is activated, the automatic transmission does not shift up automatically even when the engine limiting speed for the current gear is reached. Observe the protection against reaching the overrevving range on the multifunction display. Always make sure that the engine speed does not reach the red area of the tachometer.

- ▶ **To shift down:** pull steering wheel paddle shifter ①.

The automatic transmission shifts down to the next gear.

Automatic down shifting occurs when coasting.

If the engine exceeds the maximum engine speed when shifting down, the automatic transmission protects against engine damage by not shifting down.



## Shift recommendation



The gearshift recommendations assist you in adopting an economical driving style. The recommended gear is shown in the multifunction display.

- ▶ When the corresponding gearshift recommendation ① appears in the multifunction display of the instrument cluster, shift to recommended gear ②.

## Protection against reaching the over-revving range (Mercedes-AMG vehicles)

**!** In manual mode, the automatic transmission does not shift up automatically even when the engine limiting speed for the current gear is reached. When the engine limiting speed is reached, the fuel supply is cut to prevent the engine from overrevving. Always make sure that the engine speed does not reach the red area of the tachometer. There is otherwise a risk of engine damage.



Before the engine speed reaches the red area, an upshift indicator will be shown in the multifunction display.

- ▶ When message ① appears on the multifunction display, pull the right-hand steering wheel paddle shifter.

## Kickdown

- ▶ For maximum acceleration, depress the accelerator pedal beyond the pressure point. The automatic transmission shifts to a lower gear depending on the engine speed.
- ▶ Shift back up once the desired speed is reached.

If you apply full throttle, the automatic transmission shifts up to the next gear when the maximum engine speed is reached. This prevents the engine from overrevving.

**Mercedes-AMG vehicles:** kickdown is only possible in the temporary setting.

## Problems with the transmission

Problem	Possible causes/consequences and ► Solutions
The transmission has problems shifting gear.	The transmission is losing oil. ► Have the transmission checked at a qualified specialist workshop immediately.
The acceleration ability is deteriorating. The transmission no longer changes gear.	The transmission is in emergency mode. It is possible to shift to a gear and reverse gear only. ► Stop the vehicle. ► Shift the transmission to position <b>P</b> . ► Switch off the engine. ► Wait at least ten seconds before restarting the engine. ► Shift the transmission to position <b>D</b> or <b>R</b> . If <b>D</b> is selected, the transmission only shifts to one gear; if <b>R</b> is selected, the transmission shifts to reverse gear. ► Have the transmission checked at a qualified specialist workshop immediately.

## Transfer case

This section is only valid for vehicles with 4-wheel drive (4MATIC). Power is always transmitted to both axles.

**!** Performance tests may only be carried out on a 2-axle dynamometer. The brake system or transfer case could otherwise be damaged. Contact a qualified specialist workshop for a performance test.

**!** Since ESP® engages automatically, the ignition must be switched off (the SmartKey or Start/Stop button must be in position **0** or **1**) if

- the electrical parking brake is being tested using a dynamometer
- the vehicle is being towed with only one axle raised (not permitted for vehicles with 4MATIC)

Otherwise, the brake system can be damaged.

**!** Vehicles with 4MATIC must not be towed with either the front or the rear axle raised, as doing so will damage the transmission.

## Refueling

### Important safety notes

#### WARNING

Fuel is highly flammable. If you handle fuel incorrectly, there is a risk of fire and explosion.

You must avoid fire, open flames, creating sparks and smoking. Switch off the engine and, if applicable, the auxiliary heating before refueling.

#### WARNING

Fuel is poisonous and hazardous to health. There is a risk of injury.

You must make sure that fuel does not come into contact with your skin, eyes or clothing and that it is not swallowed. Do not inhale fuel vapors. Keep fuel away from children.

If you or others come into contact with fuel, observe the following:

- Wash away fuel from skin immediately using soap and water.
- If fuel comes into contact with your eyes, immediately rinse them thoroughly with

clean water. Seek medical assistance without delay.

- If fuel is swallowed, seek medical assistance without delay. Do not induce vomiting.
- Immediately change out of clothing which has come into contact with fuel.

### WARNING

Electrostatic buildup can create sparks and ignite fuel vapors. There is a risk of fire and explosion.

Always touch the vehicle body before opening the fuel filler flap or touching the fuel pump nozzle. Any existing electrostatic buildup is thereby discharged.

Do not get into the vehicle again during the refueling process. otherwise electrostatic charge could build up again.

**!** Do not use diesel to refuel vehicles with a gasoline engine. Do not switch on the ignition if you accidentally refuel with the wrong fuel. Otherwise, the fuel will enter the fuel system. Even small amounts of the wrong fuel could result in damage to the fuel system and the engine. Notify a qualified specialist workshop and have the fuel tank and fuel lines drained completely.

**!** Overfilling the fuel tank could damage the fuel system.

**!** Take care not to spill any fuel on painted surfaces. You could otherwise damage the paintwork.

**!** Use a filter when adding fuel from a fuel can. The fuel lines and/or the fuel injection system could otherwise be blocked by particles from the fuel can.

If you overfill the fuel tank, fuel could spray out when the fuel pump nozzle is removed.

For further information on fuel and fuel quality (▷ page 377).

## Refueling

### General information

Pay attention to the important safety notes (▷ page 155).

**All vehicles except PLUG-IN HYBRID vehicles:** if you unlock or lock the vehicle from the outside, the fuel filler flap also unlocks or locks.

**PLUG-IN HYBRID vehicles:** the pressure in the fuel tank must be released before refueling (see Digital Operator's Manual).

The position of the  fuel filler cap is displayed on the instrument cluster. The arrow next to the filling pump indicates the side of the vehicle.

### Opening the fuel filler flap

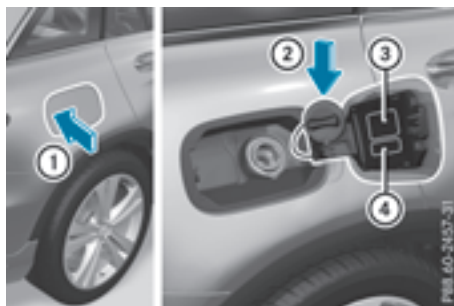

- ① To open the fuel filler flap
- ② To insert the fuel filler cap
- ③ Tire pressure table
- ④ Instruction label for fuel type to be refueled

▶ Switch off the engine.

▶ Remove the SmartKey from the ignition lock. or, in vehicles with KEYLESS-GO start-function or KEYLESS-GO

▶ Open the driver's door.

The vehicle electronics are now in setting . This is the same as "SmartKey removed".

▶ Press the fuel filler flap in the direction of arrow ①.

The fuel filler flap swings up.

▶ Turn the fuel filler cap counterclockwise and remove it.

▶ Insert the fuel filler cap into the holder on the inside of fuel filler flap ②.

- ▶ Completely insert the filler neck of the fuel pump nozzle into the tank, hook in place and refuel.
- ▶ Only fill the tank until the pump nozzle switches off.



Do not add any more fuel after the pump stops filling for the first time. Otherwise, fuel may leak out.

Close the fuel filler flap before locking the vehicle.

If you are driving with the fuel filler cap open, the  reserve fuel warning lamp flashes. A message appears in the multifunction display (▷ page 255).

### Closing the fuel filler flap

- ▶ Replace the cap on the filler neck and turn clockwise until it engages audibly.
- ▶ Close the fuel filler flap.

Problems with fuel and the fuel tank	
Problem	Possible causes/consequences and ▶ Solutions
Fuel is leaking from the vehicle.	<p> <b>WARNING</b></p> <p>The fuel line or the fuel tank is faulty. Risk of explosion or fire.</p> <ul style="list-style-type: none"> <li>▶ Apply the electric parking brake.</li> <li>▶ Switch off the engine.</li> <li>▶ Remove the SmartKey from the ignition lock.</li> </ul> <p>or, in vehicles with KEYLESS-GO start-function or KEYLESS-GO</p> <ul style="list-style-type: none"> <li>▶ Open the driver's door. The vehicle electronics are now in setting . This is the same as "SmartKey removed".</li> <li>▶ Do not restart the engine under any circumstances.</li> <li>▶ Consult a qualified specialist workshop.</li> </ul>
The fuel filler flap cannot be opened.	<p>The fuel filler flap is not unlocked.</p> <ul style="list-style-type: none"> <li>▶ Unlock the vehicle (▷ page 78).</li> </ul>
	<p>The SmartKey battery is discharged or nearly discharged.</p> <ul style="list-style-type: none"> <li>▶ Unlock the vehicle using the mechanical key (▷ page 80).</li> </ul>
	<p>The fuel filler flap is unlocked, but the opening mechanism is jammed.</p> <ul style="list-style-type: none"> <li>▶ Consult a qualified specialist workshop.</li> </ul>

## Parking

### Important safety notes

#### WARNING

Flammable material such as leaves, grass or twigs may ignite if they come into contact with hot parts of the exhaust system or exhaust gas flow. There is a risk of fire.

Park the vehicle so that no flammable materials come into contact with parts of the vehicle which are hot. Take particular care not to park on dry grassland or harvested grain fields.

#### WARNING

If you leave children unsupervised in the vehicle, they could set it in motion by, for example:

- release the parking brake.
- shift the automatic transmission out of the parking position **P**.
- start the engine.

In addition, they may operate vehicle equipment and become trapped. There is a risk of an accident and injury.

When leaving the vehicle, always take the SmartKey with you and lock the vehicle. Never leave children unsupervised in the vehicle.

**!** Always secure the vehicle correctly against rolling away. Otherwise, the vehicle or its drivetrain could be damaged.

To ensure that the vehicle is secured against rolling away unintentionally:

- the electric parking brake must be applied.
- the transmission must be in position **P** and the SmartKey must be removed from the ignition lock.
- the front wheels must be turned towards the curb on steep uphill or downhill gradients.
- the empty vehicle must be secured at the front axle with a wheel chock or similar, for example, on uphill or downhill gradients.
- on uphill or downhill gradients the laden vehicle must also be secured at the rear axle, for example with a wheel chock or similar object.

## Switching off the engine

### Important safety notes

#### WARNING

The automatic transmission switches to neutral position **N** when you switch off the engine. The vehicle may roll away. There is a risk of an accident.

After switching off the engine, always switch to parking position **P**. Prevent the parked vehicle from rolling away by applying the parking brake.

### Vehicles with automatic transmission

- ▶ Apply the electric parking brake.
- ▶ Shift the transmission to position **P**.
- ▶ **With the SmartKey:** turn the SmartKey to position **0** in the ignition lock and remove it. The immobilizer is activated.
- ▶ **With the Start/Stop button:** press the Start/Stop button (▷ page 137). The engine stops and all the indicator lamps in the instrument cluster go out. When the driver's door is closed, this corresponds to key position **1**. When the driver's door is open, this corresponds to key position **0**, "Key removed".

If you switch the engine off with the transmission in position **R** or **D** the automatic transmission shifts to **N** automatically.

**With the SmartKey:** if you then open the driver's door or the front-passenger door or remove the SmartKey from the ignition, the automatic transmission shifts to **P** automatically.

**With the Start/Stop button:** if you then open the driver's door or the front-passenger door, the automatic transmission shifts to **P** automatically.

If you want the automatic transmission to remain in neutral **N**, for example, when having the vehicle cleaned in an automatic car wash with a towing system:

- ▶ **Vehicles with KEYLESS-GO or KEYLESS-GO start function:** remove the Start/Stop button from the ignition lock.
- ▶ Insert the SmartKey into the ignition lock.
- ▶ **All vehicles:** switch the ignition on.

- ▶ Depress the brake pedal and keep it depressed.
- ▶ Engage neutral **[N]**.
- ▶ Release the brake pedal.
- ▶ Release the electric parking brake.
- ▶ Switch off the ignition and leave the SmartKey in the ignition lock.

The engine can be switched off in an emergency while the vehicle is in motion by pressing and holding the Start/Stop button for three seconds. This function operates independently of the ECO start/stop automatic engine switch-off function.

### Electric parking brake

#### General notes

#### WARNING

If you leave children unsupervised in the vehicle, they could set it in motion by, for example:

- release the parking brake.
- shift the automatic transmission out of the parking position **P**.
- start the engine.

In addition, they may operate vehicle equipment and become trapped. There is a risk of an accident and injury.

When leaving the vehicle, always take the SmartKey with you and lock the vehicle. Never leave children unsupervised in the vehicle.

The function of the electric parking brake is depending on the on-board voltage. If the on-board voltage is low or there is a malfunction in the system, it may not be possible to apply the released parking brake.

- ▶ If this happens, park the vehicle on level ground only and secure it to prevent it from rolling away.
- ▶ Shift the transmission to position **[P]**.

It may not be possible to release an applied parking brake if the on-board voltage is low or there is a malfunction in the system. Contact a qualified specialist workshop.

The electric parking brake performs a function test at regular intervals while the engine is

switched off. The sounds that can be heard while this is occurring are normal.

#### Applying or releasing manually



- ▶ **To apply:** push handle ①.  
When the electric parking brake is applied, the red **[PARK]** (USA only) or **[P]** (Canada only) indicator lamp lights up in the instrument cluster.

The electric parking brake can also be applied when the SmartKey is removed.

- ▶ **To release:** pull handle ①.  
The red **[PARK]** (USA only) or **[P]** (Canada only) indicator lamp in the instrument cluster goes out.

The electric parking brake can only be released:

- if the SmartKey is in position **[1]** or **[2]** in the ignition lock (▷ page 136) or
- if the ignition was switched on using the Start/Stop button

#### Applying automatically

The electric parking brake is automatically applied when the transmission is in position **[P]** and:

- the engine is switched off or
- the driver is not wearing a seat belt and the driver's door is opened

To prevent the electric parking brake from being automatically applied, pull handle ①.

The electric parking brake is also engaged automatically if:

- Distance Pilot DISTRONIC brings the vehicle to a standstill or
- the HOLD function is keeping the vehicle stationary
- Parking Pilot is keeping the vehicle stationary

In addition, at least one of the following conditions must be fulfilled:

- the engine is switched off
- the driver is not wearing a seat belt and the driver's door is opened
- there is a system malfunction
- the power supply is insufficient
- the vehicle is stationary for a lengthy period

The red **PARK** (USA only) or **(P)** (Canada only) indicator lamp on the instrument cluster goes out.

The electric parking brake is not automatically engaged if the engine is switched off by the ECO start/stop function.

### Releasing automatically

Your vehicle's electric parking brake is automatically released if all of the following conditions are met:

- the seat belt has been fastened
  - the engine is running
  - the transmission is in position **D** or **R** and you accelerate
- or
- you shift the transmission position from **P** to position **D** or **R**, you will need to accelerate more on steeper gradients

If the transmission is in position **R**, the tailgate must be closed.

If your seat belt is not fastened, the following conditions must be fulfilled to automatically release the electric parking brake:

- the driver's door is closed
- You have shifted out of transmission position **P** or you have previously driven faster than 2 mph (3 km/h).

Ensure that you do not depress the accelerator pedal unintentionally. Otherwise, the parking brake will be released and the vehicle will start to move.

### Emergency braking

The vehicle can also be braked during an emergency by using the electric parking brake.

- ▶ While driving, push handle ① of the electric parking brake (▷ page 159). The vehicle is braked as long as you keep handle ① of the electric parking brake depressed. The longer electric parking brake

handle ① is depressed, the greater the braking force.

During braking:

- a warning tone sounds
- the **Please Release Parking Brake** message appears
- the red **PARK** (USA only) or **(P)** (Canada only) indicator lamp in the instrument cluster flashes

When the vehicle has been braked to a standstill, the electric parking brake is engaged.

### Parking the vehicle for a long period

If you leave the vehicle parked for longer than four weeks, the battery may be damaged by exhaustive discharging.

If you leave the vehicle parked for longer than six weeks, the vehicle may suffer damage as a result of lack of use.

- ▶ Visit a qualified specialist workshop and seek advice.

**i** You can obtain information about trickle chargers from a qualified specialist workshop.

**Hybrid vehicles:** be sure to observe the notes in the supplement. Otherwise, you may not recognize dangers.

### Driving tips

#### General driving tips

#### Important safety notes

##### WARNING

If you switch off the ignition while driving, safety-relevant functions are only available with limitations, or not at all. This could affect, for example, the power steering and the brake boosting effect. You will require considerably more effort to steer and brake. There is a risk of an accident.

Do not switch off the ignition while driving.



**⚠ WARNING**

If you operate mobile communication equipment when driving, you may be distracted from the traffic situation. You could also lose control of the vehicle. There is a risk of an accident.

Only operate this equipment when the vehicle is stationary.

Observe the legal requirements for the country in which you are driving. Some jurisdictions prohibit the driver from using a mobile phone while driving a vehicle.

If you make a call while driving, always use hands-free mode. Only operate the telephone when the traffic situation permits. If you are unsure, pull over to a safe location and stop before operating the telephone.

Bear in mind that at a speed of only 30 mph (approximately 50 km/h), the vehicle covers a distance of 44 ft (approximately 14 m) per second.

**Drive sensibly – save fuel**

Observe the following tips to save fuel:

- ▶ The tires should always be inflated to the recommended tire pressure.
- ▶ Remove unnecessary loads.
- ▶ Remove roof racks when they are not needed.
- ▶ Warm up the engine at low engine speeds.
- ▶ Avoid frequent acceleration or braking.
- ▶ Have all maintenance work carried out as indicated by the service intervals in the Maintenance Booklet or by the service interval display.

Fuel consumption also increases when driving in cold weather, in stop-start traffic and in hilly terrain.

**Drinking and driving****⚠ WARNING**

Drinking and driving and/or taking drugs and driving are very dangerous combinations. Even a small amount of alcohol or drugs can affect your reflexes, perceptions and judgment.

The possibility of a serious or even fatal accident is greatly increased when you drink or take drugs and drive.

Do not drink or take drugs and drive or allow anyone to drive who has been drinking or taking drugs.

**Emission control****⚠ WARNING**

Combustion engines emit poisonous exhaust gases such as carbon monoxide. Inhaling these exhaust gases leads to poisoning. There is a risk of fatal injury. Therefore never leave the engine running in enclosed spaces without sufficient ventilation.

Certain engine systems are designed to keep the level of poisonous components in exhaust fumes within legal limits.

These systems only work at peak efficiency if they are serviced exactly in accordance with the manufacturer's specifications. Always have work on the engine carried out at a qualified specialist workshop. Mercedes-Benz recommends that you use an authorized Mercedes-Benz Center for this purpose. In particular, work relevant to safety or on safety-related systems must be carried out at a qualified specialist workshop.

The engine settings must not be changed under any circumstances. Furthermore, all specific service work must be carried out at regular intervals and in accordance with the Mercedes-Benz service requirements. Details can be found in the Maintenance Booklet.

**ECO display**

The ECO display shows you how economical your driving style is. The ECO display assists you in achieving the most economical driving style for the selected settings and prevailing conditions. Your driving style can significantly influence the vehicle's consumption.



- ① Acceleration
- ② Coasting
- ③ Constant
- ④ Additional range achieved

Range ④ is shown under **Bonus fr. Start** and represents the additional range achieved since the beginning of the journey as a result of an adapted driving style.

If the fuel level has dropped into the reserve range, the **Reserve Fuel** display message is shown instead of range ④ in the multifunction display. The  warning lamp in the instrument cluster also lights up (> page 274).

The ECO display consists of three sections, with an inner and outer area. The sections correspond to the following three categories:

- |   |  |
|---|--|
| ① | <p><b>Acceleration</b> (evaluation of all acceleration processes):</p> <ul style="list-style-type: none"> <li>• the outer area fills up and the inner area lights up green: moderate acceleration, especially at higher speeds</li> <li>• the outer area empties and the inner area is gray: sporty acceleration</li> </ul>  |
| ② | <p><b>Coasting</b> (evaluation of all deceleration processes):</p> <ul style="list-style-type: none"> <li>• the outer area fills up and the inner area lights up green: anticipatory driving, keeping your distance and early release of the accelerator. The vehicle can coast without use of the brakes.</li> <li>• the outer area empties and the inner area is gray: frequent heavy braking</li> </ul> |
| ③ | <p><b>Constant</b> (continuous evaluation over the entire journey):</p> <ul style="list-style-type: none"> <li>• the outer area fills up and the inner area lights up green: constant speed and avoidance of unnecessary acceleration and deceleration</li> <li>• the outer area empties and the inner area is gray: fluctuations in speed</li> </ul>  |

The three inner areas display the current driving style and light up green as a result of a particularly economical driving style. Depending on the driving situation, up to two areas may light up simultaneously.

At the beginning of the journey, the three outer areas are empty and fill up as a result of economical driving. A higher level indicates a more economical driving style. If the three outer areas are completely filled at the same time, the driver has adopted the most economical driving style for the selected settings and prevailing conditions. The ECO display border lights up.

The ECO display does not indicate the actual fuel consumption. The additionally achieved range displayed under **Bonus fr. Start** does not indicate a fixed consumption reduction.

In addition to driving style, the actual consumption is affected by other factors, such as:

- load
- Tire pressure
- Cold start
- Choice of route
- Active electrical consumers

These factors are not included in the ECO display.

An economical driving style specially requires driving at moderate engine speeds.

Achieving a higher value in the categories "Acceleration" and "Constant":

- observe the gearshift recommendations
- drive using drive program **E**

On long journeys at a constant speed, e.g. on the highway, only the outer area for "constant" will change.

The ECO display summarizes the driving style from the start of the journey to its completion. Therefore, there are more marked changes in the outer areas at the start of a journey. On longer journeys, there are fewer changes. For more marked changes, perform a manual rest (▷ page 226).

For further information on the ECO display, see (▷ page 225).

## Brakes

### Important safety notes

#### WARNING

If you shift down on a slippery road surface in an attempt to increase the engine's braking effect, the drive wheels could lose their grip. There is an increased danger of skidding and accidents.

Do not shift down for additional engine braking on a slippery road surface.

### Downhill gradients

**!** On long and steep gradients, you must reduce the load on the brakes by shifting to a lower gear in good time. This allows you to take advantage of the engine's braking effect. This helps you to avoid overheating the brakes and wearing them out excessively.

When you take advantage of engine braking, a drive wheel may not turn for some time, e.g. on a slippery road surface. This could cause damage to the drive train. This type of damage is not covered by the Mercedes-Benz warranty.

### Heavy and light loads

#### WARNING

If you rest your foot on the brake pedal while driving, the braking system can overheat. This increases the stopping distance and can even cause the braking system to fail. There is a risk of an accident.

Never use the brake pedal as a footrest. Never depress the brake pedal and the accelerator pedal at the same time.

**!** Depressing the brake pedal constantly results in excessive and premature wear to the brake pads.

If the brakes have been subjected to a heavy load, do not stop the vehicle immediately. Drive on for a short while. This allows the airflow to cool the brakes more quickly.

### Wet roads

If you have driven for a long time in heavy rain without braking, there may be a delayed reaction from the brakes when braking for the first time. This may also occur after the vehicle has been washed or driven through deep water.

You have to depress the brake pedal more firmly. Maintain a greater distance from the vehicle in front.

After driving on a wet road or having the vehicle washed, brake firmly while paying attention to the traffic conditions. This will warm up the brake discs, thereby drying them more quickly and protecting them against corrosion.

### Limited braking performance on salt-treated roads

If you drive on salted roads, a layer of salt residue may form on the brake discs and brake pads. This can result in a significantly longer braking distance.

- In order to prevent any salt build-up, apply the brakes occasionally while paying attention to the traffic conditions.
- Carefully depress the brake pedal at the beginning and end of a journey.
- Maintain a greater distance to the vehicle ahead.

## Servicing the brakes

- !** The brake fluid level may be too low, if:
- if the red brake warning lamp lights up in the instrument cluster and
  - you hear a warning tone while the engine is running

Observe additional warning messages in the multifunction display.

The brake fluid level may be too low due to brake pad wear or leaking brake lines.

Have the brake system checked immediately. Consult a qualified specialist workshop to arrange this.

- !** **Vehicles with 4MATIC:** function or performance tests may only be carried out on a 2-axle dynamometer. If you wish to operate the vehicle on such a dynamometer, please consult a qualified specialist workshop in advance. You could otherwise damage the drive train or the brake system.

- !** **Vehicles with 4MATIC:** the ESP® system operates automatically. If the electric parking brake is tested on a brake dynamometer, the engine and ignition must be switched off: turn the SmartKey in the ignition lock to position **0** or **1** or press the Start/Stop button repeatedly in accordance with the given SmartKey positions.

Braking triggered automatically by ESP® may cause severe damage to the brake system.

All checks and maintenance work on the brake system must be carried out at a qualified specialist workshop.

Have brake pads installed and brake fluid replaced at a qualified specialist workshop.

If the brake system has only been subject to moderate loads, you should test the functionality of your brakes at regular intervals.

Information on BAS (Brake Assist System) (> page 67) and Active Brake Assist with cross-traffic function (> page 73).

For safety reasons, Mercedes-Benz recommends only installing the following brake disks and brake pads/linings:

- brake disks that have been approved by Mercedes-Benz
- brake pads/linings that have been approved by Mercedes-Benz or that are of an equivalent standard of quality

Other brake disks or brake pads/linings can compromise the safety of your vehicle.

Always replace all brake disks and brake pads/linings on an axle at the same time. Always install new brake pads/linings when replacing brake disks.

The vehicle is equipped with lightweight brake disks to which the wheel assembly with rim and threaded connection is matched.

The use of brake disks other than those approved by Mercedes-Benz can change the track width and is subject to approval, if applicable.

Shock-type loads when handling the brake discs, such as when changing wheels, can lead to a reduction in comfort when driving with lightweight brake discs. Avoid shock-type loads on the lightweight brake disks, particularly on the brake plate.

Mercedes-Benz recommends that you only use brake fluid that has been specially approved for your vehicle by Mercedes-Benz, or which corresponds to an equivalent quality standard. Brake fluid which has not been approved for Mercedes-Benz vehicles or which is not of an equivalent quality could affect your vehicle's operating safety.

## Driving on wet roads

### Hydroplaning

If water has accumulated to a certain depth on the road surface, there is a danger of hydroplaning occurring, even if:

- you drive at low speeds
- the tires have adequate tread depth

For this reason, in the event of heavy rain or in conditions in which hydroplaning may occur, you must drive in the following manner:

- lower your speed
- avoid ruts

- avoid sudden steering movements
- brake carefully

### Driving on flooded roads

**!** Bear in mind that vehicles traveling in front or in the opposite direction create waves. This may cause the maximum permissible water depth to be exceeded.

Failure to observe these notes may result in damage to the engine, electrical systems and transmission.

If you have to drive on stretches of road on which water has collected, please bear in mind that:

- in the case of standing water, the water level may be no higher than the lower edge of the vehicle body
- you should drive no faster than walking pace

### Winter driving

#### WARNING

If you shift down on a slippery road surface in an attempt to increase the engine's braking effect, the drive wheels could lose their grip. There is an increased danger of skidding and accidents.

Do not shift down for additional engine braking on a slippery road surface.

#### DANGER

If the exhaust pipe is blocked or adequate ventilation is not possible, poisonous gases such as carbon monoxide (CO) may enter the vehicle. This is the case, e.g. if the vehicle becomes trapped in snow. There is a risk of fatal injury.

If you leave the engine or the auxiliary heating running, make sure the exhaust pipe and area around the vehicle are clear of snow. To ensure an adequate supply of fresh air, open a window on the side of the vehicle that is not facing into the wind.

Have your vehicle winter-proofed at a qualified specialist workshop at the onset of winter.

Drive particularly carefully on slippery road surfaces. Avoid sudden acceleration, steering and

braking maneuvers. Do not use cruise control or Distance Pilot DISTRONIC.

If the vehicle threatens to skid or cannot be stopped when moving at low speed:

- Shift the transmission to position **N**.

The outside temperature indicator is not designed to serve as an ice-warning device and is therefore unsuitable for that purpose. Changes in the outside temperature are displayed after a short delay.

Indicated temperatures just above the freezing point do not guarantee that the road surface is free of ice. The road may still be icy, especially in wooded areas or on bridges. The vehicle could skid if you fail to adapt your driving style. Always adapt your driving style and drive at a speed to suit the prevailing weather conditions.

You should pay special attention to road conditions when temperatures are around freezing point.

For more information on driving with snow chains, see (▷ page 351).

For more information on driving with summer tires, see (▷ page 351).

Observe the notes in the "Winter operation" section (▷ page 351).

### Off-road driving

#### Important safety notes

#### WARNING

If you drive on a steep incline at an angle or turn when driving on an incline, the vehicle could slip sideways, tip and rollover. There is a risk of an accident.

Always drive on a steep incline in the line of fall (straight up or down) and do not turn the vehicle.

#### WARNING

Flammable material such as leaves, grass or twigs may ignite if they come into contact with hot parts of the exhaust system. There is a risk of fire.

When driving on an unpaved road or off-road, check the vehicle underside regularly. In particular, remove trapped plant parts or other

flammable material. Contact a qualified specialist workshop immediately if damage is detected.

- ! There is a risk of damage to the vehicle if:
- the vehicle becomes stuck, e.g. on a high curb or an unpaved road
  - you drive too fast over an obstacle, e.g. a curb, a speed bump or a pothole in the road
  - a heavy object strikes the underbody or parts of the chassis

In situations like this, the body, the underbody, chassis parts, wheels or tires could be damaged without the damage being visible. Components damaged in this way can unexpectedly fail or, in the case of an accident, no longer withstand the loads they are designed to.

If the underbody paneling is damaged, combustible materials such as leaves, grass or twigs can gather between the underbody and the underbody paneling. If these materials come in contact with hot parts of the exhaust system, they can catch fire.

In such situations, have the vehicle checked and repaired immediately at a qualified specialist workshop. If on continuing your journey you notice that driving safety is impaired, pull over and stop the vehicle immediately, paying attention to road and traffic conditions. In such cases, consult a qualified specialist workshop.

The vehicle is only designed for easily negotiable off-road terrain and poor road surfaces.

When driving off-road, substances such as sand, mud and water or water mixed with oil may get into the brakes. This could result in a reduced braking effect or in total brake failure and also in increased wear and tear. The braking characteristics change depending on the material entering the brakes. Clean the brakes after driving off-road. If you detect a reduced braking effect or grinding noises, have the brake system checked in a qualified specialist workshop as soon as possible. Adapt your driving style to the different braking characteristics.

Driving off-road increases the likelihood of damage to the vehicle, which, in turn, can lead to failure of the mechanical assembly or systems. Adapt your driving style to suit the terrain conditions. Drive carefully. Have damage to the

vehicle rectified immediately at a qualified specialist workshop.

Do not shift into transmission position **N** when driving off-road. You could lose control of the vehicle if you attempt to brake the vehicle using the service brake. If the gradient is too steep for your vehicle, drive back down in reverse gear.

## General notes

### 🌱 Environmental note

Protection of the environment is of primary importance. Treat nature with respect. Observe all prohibiting signs.

Read this section carefully before driving your vehicle off-road.

Off-road driving is only possible with the Off-Road Engineering package (▷ page 181).

The following driving systems are specially adapted for driving over easily negotiable off-road terrain:

- Off-road program (▷ page 181)
- Off-road 4ETS (▷ page 70)
- Off-road ESP® (▷ page 72)
- DSR (Downhill Speed Regulation) (▷ page 180)

Observe the following notes:

- Stop the vehicle before starting to drive along an off-road route. If necessary, activate the off-road program (▷ page 181).
- To avoid damaging the vehicle, make sure there is always sufficient ground clearance.
- Check that items of luggage and loads are stowed safely and are well secured (▷ page 295).
- Always keep the engine running and in gear when driving on a downhill gradient. Activate DSR (▷ page 180).
- Drive slowly and evenly, if necessary at a walking pace.
- Ensure that the wheels are in contact with the ground at all times.
- Drive with extreme care on unfamiliar off-road routes where visibility is poor. For safety reasons, get out of the vehicle first and survey the off-road route.
- Check the depth of water before fording rivers and streams.
- Watch out for obstacles.

- Take care when turning on an uphill or downhill slope or when driving across a slope. The vehicle could otherwise tip over.
- Always keep the side windows and the panorama roof with power tilt/sliding panel closed during the journey.
- Do not deviate from marked routes.

Do not use the HOLD function when driving off-road, on steep uphill or downhill gradients or on slippery or loose surfaces. The HOLD function cannot hold the vehicle on such surfaces.

### Checklist before driving off-road

- ▶ **Engine oil level:** check the engine oil level and add oil if necessary.  
When driving on steep gradients, the engine oil level must be sufficiently high to ensure a correct oil supply in the vehicle.
- ▶ **Wheels and tires:** check the tire tread depth and tire pressure.
- ▶ Check for damage and remove any foreign objects, e.g. small stones, from the wheels/tires.
- ▶ Replace any missing valve caps.
- ▶ Replace dented or damaged wheels.
- ▶ **Rims:** dented or bent rims can result in a loss of tire pressure and damage the tire bead. Before driving off-road, check the wheels and replace them if necessary.

### Checklist after driving off-road

- ❗ If you detect damage to the vehicle after driving off-road, have the vehicle checked immediately at a qualified specialist workshop.
- ▶ Deactivate off-road program (▷ page 181).
- ▶ Deactivate DSR (▷ page 180).
- ▶ Clean the headlamps and rear lights and check for damage.
- ▶ Clean the front and rear license plates.
- ▶ Clean the wheels/tires with a water jet and remove any foreign objects.
- ▶ Clean the wheels, wheel housings and the vehicle underside with a water jet; check for any foreign objects and damage.
- ▶ Check whether twigs or other parts of plants have become trapped. These increase the risk of fire and can damage fuel pipes, brake

hoses or the rubber bellows of the axle joints and propeller shafts.

- ▶ After the trip, examine without fail the entire undercarriage, wheels, tires, brakes, body-work structure, steering, chassis and exhaust system for damage.
- ▶ After driving in sand, mud, gravel, water or similar dirty conditions, have the following checked and cleaned:
  - brake discs
  - wheels
  - brake pads
  - axle joints
- ▶ If you detect strong vibrations after off-road travel, check for foreign objects in the wheels and drive train and remove them if necessary. Foreign objects can disturb the balance and cause vibrations.

Driving over poor road surfaces places greater demands on your vehicle than driving on normal roads. After driving off-road, check the vehicle. This allows you to detect damage promptly and reduce the risk of an accident to yourself and other road users.

### Driving on sand

Observe the following rules when driving on sand:

- Select the off-road program (▷ page 181).
- Avoid high engine speeds.
- Use the left-hand steering wheel paddle shifter to shift to a lower gear appropriate to the terrain.
- Drive quickly to overcome the rolling resistance. Otherwise the vehicle's wheels could become stuck in loose ground.
- Drive in the tracks of other vehicles if possible. Make sure that:
  - the tire ruts are not too deep.
  - the sand is sufficiently firm.
  - the ground clearance of the vehicle is sufficient.

### Tire ruts and gravel roads

- ❗ Check that the ruts are not too deep and that your vehicle has sufficient clearance. Otherwise, your vehicle could be damaged or bottom out and get stuck.



Observe the following rules when driving along ruts in off-road terrain or on roads with loose gravel:

- Activate the off-road program (▷ page 181).
- Avoid high engine speeds.
- Shift to a lower gear using the left-hand steering wheel paddle shifter.
- Drive slowly.
- Where ruts are too deep, drive with the wheels of one side on the center grassy area, if possible.

### Traveling uphill

#### Approach/departure angle

##### WARNING

If you drive on a steep incline at an angle or turn when driving on an incline, the vehicle could slip sideways, tip and rollover. There is a risk of an accident.

Always drive on a steep incline in the line of fall (straight up or down) and do not turn the vehicle.

- Observe the warnings for off-road driving (▷ page 165).
- Follow the line of fall when driving on slopes and steep inclines.
- Before driving on extreme uphill and downhill gradients, select the off-road program (▷ page 181).
- Drive slowly.
- Accelerate gently and make sure that the wheels are gripping.
- Avoid high engine speeds, except when driving on sandy and muddy routes with high driving resistance.
- Use the left-hand steering wheel paddle shifter to shift to a lower gear appropriate to the gradient.
- Use the left-hand steering wheel paddle shifter to shift into a lower gear in good time on long and steep downhill gradients.

Hill start assist will aid you when pulling away on a hill. For further information about hill start assist, see (▷ page 140).

Do not shift into transmission position **N** when driving off-road. You could lose control of the

vehicle if you attempt to brake the vehicle using the service brake. If the gradient is too steep for your vehicle, drive back down in reverse gear.

Always observe the approach/departure angle values (▷ page 384).

### Maximum gradient-climbing capability

Always observe the maximum gradient climbing ability values (▷ page 384).

### Hilltops

When driving up an uphill gradient, slightly reduce pressure on the accelerator immediately before reaching the brow of the hill. Make use of the vehicle's own impetus to travel over the brow.

This style of driving prevents:

- the vehicle from lifting off the ground on the brow of a hill
- the vehicle from traveling too quickly down the other side

### Driving downhill

- Drive slowly.
- Do not drive at an angle down steep inclines. Steer into the line of fall and drive with the front wheels aligned straight. Otherwise, the vehicle could slip sideways, tip and rollover.
- Shift to a lower gear using the left-hand steering wheel paddle shifter before tackling steep downhill gradients.
- Activate DSR. If this is not sufficient, brake gently. When doing so, make sure that the vehicle is facing in the direction of the line of fall.
- Check that the brakes are working normally after a long downhill stretch.

Off-road ABS is activated when the off-road program is selected.

At speeds below 18 mph (30 km/h), the front wheels lock cyclically during braking. The digging-in effect achieved in the process reduces the stopping distance on off-road terrain. The steerability of the vehicle is considerably reduced if the wheels lock.

## Driving systems

### Mercedes-Benz Intelligent Drive

Mercedes-Benz Intelligent Drive stands for innovative driver assistance and safety systems which enhance comfort and support the driver in critical situations. With these intelligent coordinated systems Mercedes-Benz has set a milestone on the path towards autonomous driving. Mercedes-Benz Intelligent Drive embraces all elements of active and passive safety in one well thought out system – for the safety of the vehicle occupants and that of other road users. Further information on driving safety systems (▷ page 66).

### Cruise control

#### General notes

Cruise control maintains a constant road speed for you. It brakes automatically in order to avoid exceeding the set speed. Change into a lower gear in good time on long and steep downhill gradients. This is especially important if the vehicle is laden or towing a trailer. By doing so, you will make use of the braking effect of the engine. This relieves the load on the brake system and prevents the brakes from overheating and wearing too quickly.

Use cruise control only if road and traffic conditions make it appropriate to maintain a steady speed for a prolonged period. You can store any road speed above 20 mph (30 km/h).

#### Important safety notes

Cruise control can neither reduce the risk of an accident if you fail to adapt your driving style nor override the laws of physics. Cruise control cannot take into account the road, traffic and weather conditions. Cruise control is only an aid. You are responsible for maintaining a safe distance to the vehicle in front, for vehicle speed, for braking in good time and for staying in lane.

Do not use cruise control:

- in road and traffic conditions which do not allow you to maintain a constant speed, e.g. in heavy traffic or on winding roads
- on slippery road surfaces. Braking or accelerating could cause the drive wheels to lose traction and the vehicle could then skid
- when there is poor visibility, e.g. due to fog, heavy rain or snow

If there is a change of drivers, advise the new driver of the speed stored.

- ❗ The speed indicated in the speedometer may differ slightly from the speed stored.

#### Cruise control lever

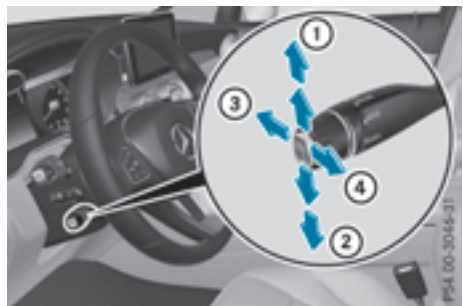

- ① Activates or increases speed
- ② Activates or reduces speed
- ③ Deactivates cruise control
- ④ Activates at the current speed/last stored speed

When you activate cruise control, the stored speed is shown in the multifunction display for five seconds. The  symbol appears on the multifunction display.

**Speedometer with segments:** when cruise control is activated, the segments from the stored speed to the end of the scale light up.

#### Storing and maintaining the current speed

You can store the current speed if you are driving faster than 20 mph (30 km/h).

- ▶ Accelerate the vehicle to the desired speed.
- ▶ Briefly press the cruise control lever up ① or down ②.
- ▶ Remove your foot from the accelerator pedal. Cruise control is activated. The vehicle automatically maintains the stored speed.

**i** Cruise control may be unable to maintain the stored speed on uphill gradients. The stored speed is resumed when the gradient evens out. Cruise control maintains the stored speed on downhill gradients by automatically applying the brakes.

### Storing the current speed or calling up the last stored speed

#### WARNING

If you call up the stored speed and it is lower than the current speed, the vehicle decelerates. If you do not know the stored speed, the vehicle could decelerate unexpectedly. There is a risk of an accident.

Pay attention to the road and traffic conditions before calling up the stored speed. If you do not know the stored speed, store the desired speed again.

- ▶ Briefly pull the cruise control lever towards you ④.
- ▶ Remove your foot from the accelerator pedal. The first time cruise control is activated, it stores the current speed or regulates the speed of the vehicle to the previously stored speed.

### Setting a speed

Keep in mind that it may take a brief moment until the vehicle has accelerated or braked to the speed set.

- ▶ Press the cruise control lever up ① for a higher speed or down ② for a lower speed.
- ▶ **To adjust the set speed in 1 mph increments (1 km/h increments):** briefly press

the cruise control lever up ① or down ② to the pressure point.

Every time the cruise control lever is pressed up ① or down ② the last speed stored is increased or reduced.

- ▶ **To adjust the set speed in 5 mph increments (10 km/h increments):** briefly press the cruise control lever up ① or down ② beyond the pressure point.

Every time the cruise control lever is pressed up ① or down ② the last speed stored is increased or reduced.

- i** Cruise control is not deactivated if you depress the accelerator pedal. If you accelerate to overtake, cruise control adjusts the vehicle's speed to the last speed stored after you have finished overtaking.

### Deactivating cruise control

There are several ways to deactivate cruise control:

- ▶ Briefly press the cruise control lever forward ③.
- or
- ▶ Brake.

Cruise control is automatically deactivated if:

- you engage the electric parking brake
- you are driving at less than 20 mph (30 km/h)
- ESP® intervenes or you deactivate ESP®
- you shift the transmission to position **N** while driving

If cruise control is deactivated, a warning tone sounds. You will see the **Cruise Control Off** message in the multifunction display for approximately five seconds. The message on the multifunction display disappears and the segments on the speedometer go out.

- i** When you switch off the engine, the last speed stored is cleared.

### Distance Pilot DISTRONIC

#### General notes

Distance Pilot DISTRONIC regulates the speed and automatically helps you maintain the distance to the vehicle detected in front. Vehicles are detected with the aid of the radar sensor system. Distance Pilot DISTRONIC brakes automatically so that the set speed is not exceeded.

Change into a lower gear in good time on long and steep downhill gradients. This is especially important if the vehicle is laden. By doing so, you will make use of the braking effect of the engine. This relieves the load on the brake system and prevents the brakes from overheating and wearing too quickly.

If Distance Pilot DISTRONIC detects that there is a risk of a collision, you will be warned visually and acoustically. Without your intervention, Distance Pilot DISTRONIC cannot prevent a collision. An intermittent warning tone will then sound and the distance warning lamp will light up in the instrument cluster. Brake immediately in order to increase the distance to the vehicle in front or take evasive action provided it is safe to do so.

Distance Pilot DISTRONIC operates in the range between 0 mph (0 km/h) and 120 mph (200 km/h).

Do not use Distance Pilot DISTRONIC while driving on roads with steep gradients.

Since Distance Pilot DISTRONIC transmits radar waves, it can resemble the radar detectors of the responsible authorities. You can refer to the relevant chapter in the Operator's Manual if questions are asked about this.

- i** USA only: This device has been approved by the FCC as a "Vehicular Radar System". The radar sensor is intended for use in an automotive radar system only. Removal, tampering, or altering of the device will void any warranties, and is not permitted by the FCC. Do not tamper with, alter, or use in any non-approved way.

Any unauthorized modification to this device could void the user's authority to operate the equipment.

- i** Canada only: This device complies with RSS-210 of Industry Canada. Operation is subject to the following two conditions:
  1. This device may not cause interference, and
  2. This device must accept any interference received, including interference that may cause undesired operation of the device.
 Removal, tampering, or altering of the device will void any warranties, and is not permitted. Do not tamper with, alter, or use in any non-approved way.

Any unauthorized modification to this device could void the user's authority to operate the equipment.

## Important safety notes

### WARNING

Distance Pilot DISTRONIC does not react to:

- people or animals
- stationary objects on the road, e.g. stopped or parked vehicles
- oncoming vehicles and crossing traffic

As a result, Distance Pilot DISTRONIC may neither give warnings nor intervene in such situations. There is a risk of an accident.

Always pay careful attention to the traffic situation and be ready to brake.

### WARNING

Distance Pilot DISTRONIC cannot always clearly identify other road users and complex traffic situations.

In such cases, Distance Pilot DISTRONIC may:

- give an unnecessary warning and then brake the vehicle
- neither give a warning nor intervene
- accelerate or brake unexpectedly

There is a risk of an accident.

Continue to drive carefully and be ready to brake, especially if Distance Pilot DISTRONIC warns you.

### WARNING

Distance Pilot DISTRONIC brakes your vehicle with up to 50% of the maximum possible deceleration. If this deceleration is not sufficient, Distance Pilot DISTRONIC alerts you with a visual and acoustic warning. There is a risk of an accident.

Apply the brakes yourself in these situations and try to take evasive action.

- !** When Distance Pilot DISTRONIC or the HOLD function are activated, the vehicle brakes automatically in certain situations.

To avoid damage to the vehicle, deactivate these systems in the following or similar situations:

- when towing the vehicle
- in the car wash

Distance Pilot DISTRONIC can neither reduce the risk of an accident if you fail to adapt your driving style nor override the laws of physics. Distance Pilot DISTRONIC cannot take into account road, weather or traffic conditions. Distance Pilot DISTRONIC is only an aid. You are responsible for maintaining a safe distance to the vehicle in front, for vehicle speed, for braking in good time and for staying in lane.

Do not use Distance Pilot DISTRONIC:

- in road and traffic conditions which do not allow you to maintain a constant speed, e.g. in heavy traffic or on winding roads
- on slippery road surfaces. Braking or accelerating could cause the drive wheels to lose traction and the vehicle could then skid
- in poor visibility, e.g. due to fog, heavy rain or snow

Distance Pilot DISTRONIC may not detect narrow vehicles driving in front, e.g. motorcycles, or vehicles driving on a different line.

In particular, the detection of obstacles can be impaired if:

- there is dirt on the sensors or anything else covering the sensors
- there is snow or heavy rain
- there is interference by other radar sources
- there are strong radar reflections, for example in parking garages

If Distance Pilot DISTRONIC no longer detects a vehicle in front, it may unexpectedly accelerate to the speed stored.

This speed may:

- be too high if you are driving in a turning lane or an exit lane
- be so high in the right lane that you pass vehicles driving on the left (in countries where they drive on the right)
- be so high in the left lane that you pass vehicles driving on the right (in countries where they drive on the left)

If there is a change of drivers, advise the new driver of the speed stored.

## Cruise control lever

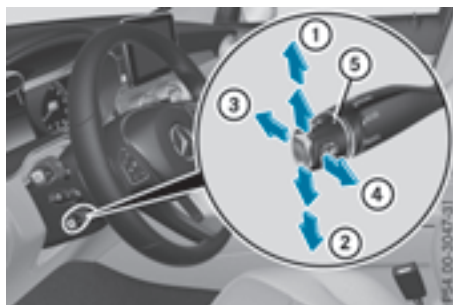

- ① Activates or increases speed
- ② Activates or reduces speed
- ③ Deactivates Distance Pilot DISTRONIC
- ④ Activates at the current speed/last stored speed
- ⑤ Sets a specified minimum distance

When you activate Distance Pilot DISTRONIC, the stored speed will appear on the multifunction display for five seconds.

**Speedometer with segments:** when Distance Pilot DISTRONIC is activated, the segments of the stored speed light up to the end of the scale or to a permanently set speed limit.

## Activating Distance Pilot DISTRONIC

### Activation conditions

To activate Distance Pilot DISTRONIC, the following conditions must be fulfilled:

- the engine must be started. It may take up to two minutes of driving before Distance Pilot DISTRONIC is ready for use.
- the electric parking brake must be released.
- ESP® must be activated, but not intervening at present.
- Parking Pilot must not be activated.
- the transmission must be in position **D**.
- the driver's door must be closed when you shift the transmission from position **P** to **D** or your seat belt must be fastened.
- the front-passenger door and rear doors must be closed.
- on vehicles with the Off-Road Engineering package, DSR and the **Gradient** off-road program must not be activated.
- the vehicle must not slide.

## Activating

- ▶ Briefly pull the cruise control lever towards you ④ or push it up ① or down ②. Distance Pilot DISTRONIC is activated.
- ▶ Remove your foot from the accelerator pedal. The vehicle adapts its speed to that of the vehicle in front, but only up to the desired stored speed.

If you do not fully release the accelerator pedal, the **Distance Pilot Suspended** message appears on the multifunction display. The set distance to a slower-moving vehicle in front will then not be maintained. You will be driving at the speed you determine by the position of the accelerator pedal.

You can also activate Distance Pilot DISTRONIC when stationary. The lowest speed that can be set is 20 mph (30 km/h).

- ▶ Briefly pull the cruise control lever towards you ④ or push it up ① or down ②. Distance Pilot DISTRONIC is activated.

## Activating at the current speed/last stored speed

### WARNING

If you call up the stored speed and it differs from the current speed, the vehicle accelerates or decelerates. If you do not know the stored speed, the vehicle could accelerate or brake unexpectedly. There is a risk of an accident.

Pay attention to the road and traffic conditions before calling up the stored speed. If you do not know the stored speed, store the desired speed again.

- ▶ Briefly pull the cruise control lever towards you ④.
- ▶ Remove your foot from the accelerator pedal. The first time Distance Pilot DISTRONIC is activated, it stores the current speed or regulates the speed of the vehicle to the previously stored speed.

## Driving with Distance Pilot DISTRONIC

### Pulling away and driving

#### ▶ To pull away with Distance Pilot

**DISTRONIC:** remove your foot from the brake pedal.

- ▶ Briefly pull the cruise control lever towards you ④.

or

- ▶ Accelerate briefly.

The vehicle pulls away and adapts its speed to that of the vehicle in front. If no vehicle is detected in front, your vehicle accelerates to the stored speed.

The vehicle can also pull away when it is facing an unidentified obstacle or is driving on a different line from another vehicle. The vehicle then brakes automatically.

If Distance Pilot DISTRONIC does not detect a vehicle in front, the system operates like cruise control.

If Distance Pilot DISTRONIC detects that the vehicle in front has slowed down, it brakes the vehicle. In this way, the specified minimum distance you have selected is maintained.

If Distance Pilot DISTRONIC detects a faster-moving vehicle in front, it increases the driving speed to the set speed.

### Selecting the drive program

Distance Pilot DISTRONIC supports a sporty driving style when you have selected the **S** or **S+** drive program (> page 150). Acceleration behind the vehicle in front or to the set speed is then noticeably more dynamic. If you have selected the **C** or **E** driving program, the vehicle accelerates more gently. This setting is recommended in stop-and-start traffic.

### Changing lanes

If you change to the overtaking lane, Distance Pilot DISTRONIC supports you if:

- you are driving faster than 45 mph (70 km/h)
- you switch on the appropriate turn signal
- Distance Pilot DISTRONIC does not currently detect a danger of collision

If these conditions are fulfilled, your vehicle is accelerated. Acceleration will be interrupted if changing lanes takes too long or if the distance between your vehicle and the vehicle in front becomes too small.



When you change lanes, Distance Pilot DISTRONIC monitors the left lane (on left-hand-drive vehicles) or the right lane (on right-hand-drive vehicles).

### Stopping

#### WARNING

If you leave the vehicle when it is only being braked by Distance Pilot DISTRONIC, it could roll away if:

- there is a malfunction in the system or in the voltage supply.
- Distance Pilot DISTRONIC is switched off using the cruise control lever, e.g. by a vehicle occupant or from outside the vehicle
- the electrical system in the engine compartment, the battery or the fuses are tampered with.
- the battery is disconnected
- the vehicle is accelerated, e.g. by a vehicle occupant.

There is a risk of an accident.

Before leaving the vehicle, always deactivate Distance Pilot DISTRONIC and secure the vehicle against rolling away.

Further information on deactivating Distance Pilot DISTRONIC (▷ page 176).

If Distance Pilot DISTRONIC detects that the vehicle in front is stopping, it brakes your vehicle to a stop.

Once your vehicle is stationary, it remains stationary and you do not need to depress the brake.

After a time, the electric parking brake secures the vehicle and relieves the service brake.

Depending on the specified minimum distance, your vehicle will come to a standstill at a sufficient distance behind the vehicle in front. The specified minimum distance is set using the control on the cruise control lever.

When Distance Pilot DISTRONIC is activated, the transmission shifts automatically to position **P** if:

- the driver's seat belt is not fastened and the driver's door is open.
- the engine is switched off, unless it is automatically switched off by the ECO start/stop function.

The electric parking brake secures the vehicle automatically if Distance Pilot DISTRONIC is activated when the vehicle is stationary and:

- a system malfunction occurs.
- the power supply is insufficient.

If a malfunction occurs, the transmission may also be shifted to position **P** automatically.

### Setting a speed

► Push cruise control lever up ① for a higher speed or down ② for a lower speed.

► **To adjust the set speed in 1 mph increments (1 km/h increments):** briefly push the cruise control lever up ① or down ② to the pressure point.

Every time the cruise control lever is pressed up ① or down ② the last speed stored is increased or reduced.

► **To adjust the set speed in 5 mph increments (10 km/h increments):** briefly push the cruise control lever up ① or down ② beyond the pressure point.

Every time the cruise control lever is pressed up ① or down ②, the last speed stored is increased or reduced.

**i** If you accelerate to overtake, Distance Pilot DISTRONIC adjusts the vehicle's speed to the last speed stored after you have finished overtaking.

### Setting a specified minimum distance

You can set the specified minimum distance for Distance Pilot DISTRONIC by varying the time span between one and two seconds. With this function you can set the minimum distance that Distance Pilot DISTRONIC maintains to the vehicle in front, depending on vehicle speed. You can see this distance in the multifunction display (▷ page 175).

Make sure that you maintain the minimum distance to the vehicle in front as required by law.



Adjust the distance to the vehicle in front if necessary.



- ▶ **To increase:** turn control ② in direction ③. Distance Pilot DISTRONIC then maintains a greater distance between your vehicle and the vehicle in front.
- ▶ **To decrease:** turn control ② in direction ①. Distance Pilot DISTRONIC then maintains a shorter distance between your vehicle and the vehicle in front.

## Displays in the instrument cluster

### Displays in the speedometer



If Distance Pilot DISTRONIC detects a vehicle in front, segments between speed of the vehicle in front ① and stored speed ② light up.

**Vehicles with the Driving Assistance Plus package:** the segments likewise light up if a vehicle in front is detected in the fast lane.

For design reasons, the speed displayed in the speedometer may differ slightly from the speed set for Distance Pilot DISTRONIC.

## Displays in the assistance graphic



### Display when Distance Pilot DISTRONIC is deactivated

- ① Vehicle in front, if detected
- ② Distance indicator, current distance to the vehicle in front
- ③ Specified minimum distance to the vehicle in front; adjustable
- ④ Your vehicle



### Display when Distance Pilot DISTRONIC is activated

- ① Distance Pilot DISTRONIC active (text only appears when the cruise control lever is actuated)
- ② Vehicle in front, if detected
- ③ Specified minimum distance to the vehicle in front; adjustable
- ④ Your vehicle

▶ **To call up the assistance graphic:** select the [Assistance Graphic](#) function using the on-board computer (> page 231).

The multifunction display shows the stored speed for approximately five seconds when you activate Distance Pilot DISTRONIC.

## Deactivating Distance Pilot DISTRONIC



There are several ways to deactivate Distance Pilot DISTRONIC:

- ▶ Briefly push cruise control lever forward ①.
- or
- ▶ Brake, unless the vehicle is stationary

When you deactivate Distance Pilot DISTRONIC, the **Distance Pilot Off** message will appear on the multifunction display for approximately five seconds.

The last speed stored remains stored until you switch off the engine.

Distance Pilot DISTRONIC is not deactivated if you depress the accelerator pedal.

Distance Pilot DISTRONIC is automatically deactivated if:

- you engage the electric parking brake or if the vehicle is automatically secured with the electric parking brake
- ESP® intervenes or you deactivate ESP®
- you shift the transmission to position **P**, **R** or **N**
- you pull the cruise control lever towards you in order to pull away and the front-passenger door or one of the rear doors is open
- the vehicle slips
- you activate Parking Pilot

If, in these cases, Distance Pilot DISTRONIC is deactivated, a warning tone sounds. The **Distance Pilot Off** message will then be shown on the multifunction display for approximately five seconds.

**Vehicles with the Off-Road Engineering package:** if you switch on DSR or the **Gradient** off-road program, Distance Pilot DISTRONIC automatically switches off without advance warning. In this case the assistance display shows the DSR symbol  (▷ page 180).

## Tips for driving with Distance Pilot DISTRONIC

Pay particular attention in the following traffic situations:

- **Cornering, entering and exiting a bend:** the ability of Distance Pilot DISTRONIC to detect vehicles during cornering is limited. Your vehicle may brake unexpectedly or late.
- **Driving on a different line:** Distance Pilot DISTRONIC may not detect vehicles which are not driving in the middle of their lane. The distance to the vehicle in front will be too short.
- **Other vehicles changing lanes:** Distance Pilot DISTRONIC has not detected the vehicle cutting in yet. The distance to this vehicle will be too short.
- **Narrow vehicles:** Distance Pilot DISTRONIC has not yet detected the vehicle in front on the edge of the road because of its narrow width. The distance to the vehicle in front will be too short.
- **Obstacles and stationary vehicles:** Distance Pilot DISTRONIC does not brake for obstacles or stationary vehicles. If, for example, the detected vehicle turns a corner and an obstacle or stationary vehicle is then revealed, Distance Pilot DISTRONIC will not brake for them.
- **Crossing traffic:** Distance Pilot DISTRONIC may mistakenly detect vehicles that are crossing your lane. Activating Distance Pilot DISTRONIC at, for example, a traffic light with crossing traffic, could cause your vehicle to pull away at the wrong time.

In such situations, brake if necessary. Distance Pilot DISTRONIC will then be deactivated.

## Distance Pilot DISTRONIC with Steering Pilot

### General notes



Distance Pilot DISTRONIC with Steering Pilot aids you in keeping the vehicle in the middle of the lane by means of moderate steering interventions in a speed range from 0 - 125 mph (0 - 200 km/h).

It monitors the area in front of your vehicle by means of multifunction camera ①, fixed at the top of the windshield.

In a speed range from 0 - 37 mph (0 - 60 km/h), Steering Pilot focuses on the vehicle in front, taking into account lane markings, e.g. when following vehicles in a traffic jam.

At speeds of more than 37 mph (60 km/h), Steering Pilot focuses on clear lane markings (left and right), focusing on the vehicle in front only if clear lane markings are not present.

If these conditions are not present, Steering Pilot cannot provide assistance.

Distance Pilot DISTRONIC must be active in order for the function to be available.

### Important safety notes

Distance Pilot DISTRONIC and Steering Pilot can neither reduce the risk of an accident if you fail to adapt your driving style nor override the laws of physics. Distance Pilot DISTRONIC with Steering Pilot cannot take into account road, weather or traffic conditions. Distance Pilot DISTRONIC with Steering Pilot is only an aid. You are responsible for maintaining a safe distance to the vehicle in front, for vehicle speed, for braking in good time and for staying in lane.

Distance Pilot DISTRONIC with Steering Pilot does not detect road and traffic conditions and does not detect all road users. If you are following a vehicle which is driving towards the edge of the road, your vehicle could come into contact

with the curb or other road boundaries. Be particularly aware of other road users, e.g. cyclists, that are directly next to your vehicle.

Obstacles such as traffic markers on a construction site that are on the lane or projecting out into the lane are not detected.

An inappropriate steering intervention, e.g. after intentionally driving over a lane marking, can be corrected at any time if you steer slightly in the opposite direction.

DISTRONIC PLUS with Steering Pilot cannot continuously keep your vehicle in lane. In some cases, steering intervention is not sufficient to bring the vehicle back to the lane. In such cases, you must steer the vehicle yourself to ensure that it does not leave the lane.

The system may be impaired or may not function if:

- there is poor visibility, e.g. due to insufficient illumination of the road, or due to snow, rain, fog or spray
- there is glare, e.g. from oncoming traffic, the sun or reflection from other vehicles (e.g. if the road surface is wet)
- the windshield is dirty, fogged up, damaged or covered, for instance by a sticker, in the vicinity of the camera
- there are no or several unclear lane markings for one lane, e.g. roadworks
- the lane markings are worn away, dark or covered up, e.g. by dirt or snow
- the distance to the vehicle in front is too short and thus the lane markings cannot be detected
- the lane markings change quickly, e.g. lanes branch off, cross one another or merge
- the road is narrow and winding
- there are highly variable shade conditions on the roadway

The system is switched to passive and no longer assists you by performing steering interventions if:

- you actively change lane
- you switch on the turn signal
- you take your hands off the steering wheel or do not steer for a prolonged period of time

After you have finished changing lanes, Steering Pilot is automatically active once more.

Steering Pilot cannot provide assistance:

- on very sharp corners
- when towing a trailer
- when a loss of tire pressure or a defective tire has been detected and displayed

Pay attention also to the important safety notes on Distance Pilot DISTRONIC (▷ page 171).

The steering interventions are carried out with a limited steering moment. The system requires the driver to keep his hands on the steering wheel and to steer himself.

If you do not steer yourself or if you take your hands off the steering wheel for a prolonged period of time, the system will first alert you with a visual warning. A steering wheel symbol appears in the multifunction display. If you have still not started to steer and have not taken hold of the steering wheel, a warning tone also sounds to remind you to take control of the vehicle after five seconds at the latest. Steering Pilot is then switched to passive. Distance Pilot DISTRONIC remains active.

### Activating Steering Pilot



- ▶ Press button ②. Indicator lamp ① lights up. The **Steering Pilot On** message appears on the multifunction display. Steering Pilot is activated.

### Information in the multifunction display



If Steering Pilot is activated but not ready for a steering intervention, steering wheel symbol ① appears in gray. If the system provides you with support by means of steering interventions, symbol ① is shown in green.

### Deactivating Steering Pilot

- ▶ Press button ②. Indicator lamp ① goes out. The **Steering Pilot Off** message appears on the multifunction display. Steering pilot is deactivated.

When Distance Pilot DISTRONIC is deactivated or not available, Steering Pilot is deactivated automatically.

### HOLD function

#### General notes

The HOLD function can assist the driver in the following situations:

- when pulling away, especially on steep slopes
- when maneuvering on steep slopes
- when waiting in traffic

The vehicle is kept stationary without the driver having to depress the brake pedal.

The braking effect is canceled and the HOLD function deactivated when you depress the accelerator pedal to pull away.

## Important safety notes

### WARNING

If the vehicle is only braked using the HOLD function, the vehicle may roll away in the following situations when you leave the vehicle:

- if there is a malfunction in the system or in the voltage supply
- if the HOLD function is deactivated by depressing the accelerator pedal or brake pedal, e.g. by a vehicle occupant
- if the electrical system in the engine compartment, the battery or the fuses are tampered with or the battery is disconnected

There is a risk of an accident.

Always deactivate the HOLD function and secure the vehicle against rolling away before you leave it.

**L** When DISTRONIC PLUS or the HOLD function is activated, the vehicle brakes automatically in certain situations.

To avoid damage to the vehicle, deactivate DISTRONIC PLUS and the HOLD function in the following or similar situations:

- when towing the vehicle
- in the car wash

Deactivating the HOLD function (> page 179).

## Activation conditions

You can activate the HOLD function if all of the following conditions are fulfilled:

- the vehicle is stationary.
- the engine is running or if it has been automatically switched off by the ECO start/stop function.
- the driver's door is closed or your seat belt is fastened.
- the electric parking brake is released.
- the transmission is in position **D**, **R** or **N**.
- DISTRONIC PLUS is deactivated.

## Activating the HOLD function



- ▶ Make sure that the activation conditions are met.
- ▶ Depress the brake pedal.
- ▶ Quickly depress the brake pedal further until ① appears in the multifunction display. The HOLD function is activated. You can release the brake pedal.

If depressing the brake pedal the first time does not activate the HOLD function, wait briefly and then try again.

## Deactivating the HOLD function

The HOLD function is deactivated automatically if:

- you depress the accelerator and the transmission is in position **D** or **R**
- the transmission is in position **P**
- you depress the brake pedal again with a certain amount of pressure until display **HOLD** disappears from the multifunction display
- you secure the vehicle using the electric parking brake
- you activate DISTRONIC PLUS

After a time, the electric parking brake secures the vehicle and relieves the service brake.

When the HOLD function is activated, the transmission is shifted automatically to position **P** if:

- the driver's seat belt is not fastened and the driver's door is open
- the engine is switched off, unless it is automatically switched off by the ECO start/stop function

The electric parking brake secures the vehicle automatically if the HOLD function is activated when the vehicle is stationary and:

- a system malfunction occurs
- the power supply is insufficient

If a malfunction occurs, the transmission may also be shifted to position **P** automatically.

## DSR

### General notes

DSR (Downhill Speed Regulation) is an aid to assist you when driving downhill that is available only in vehicles with the Off-Road Engineering package.

It keeps the speed of travel at the speed selected on the on-board computer. The steeper the downhill gradient, the greater the DSR braking effect on the vehicle. When driving on flat stretches of road or on an uphill gradient, the DSR braking effect is minimal or nonexistent.

DSR controls the vehicle's speed when it is activated and the transmission is in position **D**, **R** or **N**. You can drive at a higher or a lower speed than that set on the on-board computer at any time by accelerating or braking.

### Important safety notes

#### WARNING

If the speed driven and the set speed deviate and you activate DSR on a slippery road surface, the wheels may lose traction. There is an increased danger of skidding and accidents.

Before switching DSR on, please take into consideration the road surface and the difference between driving speed and the set speed.

DSR can neither reduce the risk of accident if you fail to adapt your driving style nor override the laws of physics. DSR cannot take account of road, weather and traffic conditions. DSR is only an aid. You are responsible for maintaining a safe distance to the vehicle in front, for vehicle speed, for braking in good time and for staying in lane.

You are always responsible for keeping control of the vehicle and for assessing whether the downhill gradient can be managed. DSR may not

always be able to keep to the set speed, depending on road surface and tire conditions. Select a set speed suitable for the prevailing conditions and when necessary, apply the brakes manually.

Further information about "Driving off-road" (> page 165).

### Activating/deactivating DSR

If you activate DSR and no speed has been set, the vehicle decelerates to 4 mph (6 km/h).

You can activate DSR only when driving at speeds below 25 mph (40 km/h).

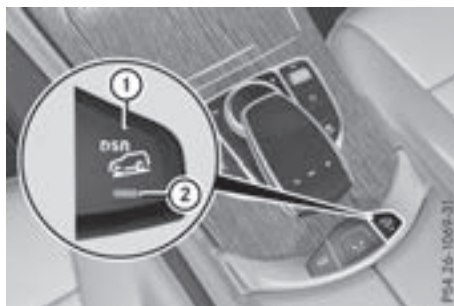

- **To switch on:** press button ①. Indicator lamp ② lights up.

The status indicator on the multifunction display shows e.g. **DSR 6 km/h**.

If the current vehicle speed is too high, the DSR symbol appears on the multifunction display with the **Max. Speed 40 km/h** message.

If you enter or exit a parking space using Parking Pilot and press button ①, indicator lamp ② flashes. DSR can then not be switched on.

- **To switch off:** press button ①. Indicator lamp ② goes out.

The DSR symbol appears on the multifunction display with the **Off** message.

DSR switches off automatically if you drive at speeds greater than 28 mph (45 km/h). The DSR symbol appears on the multifunction display with the **Off** message. A warning tone also sounds.



## Display in the assistance graphic



- ▶ Select the **Assistance Graphic** function using the on-board computer (▶ page 231). When DSR is activated symbol ① appears in the assistance graphics display.

## Changing the set speed while the vehicle is in motion



When DSR is activated, you can change the set speed to a value between 1 mph and 11 mph (Canada: between 4 km/h and 18 km/h) while the vehicle is in motion.

- ▶ **To increase or decrease in 1 mph increments (Canada: 1 km/h increments):** briefly press the cruise control lever to the pressure point, up ① for a higher set speed or down ② for a lower set speed. The multifunction display shows the set value in the status indicator.

## Off-road program

### General notes

The additional off-road programs for driving off-road are available only in vehicles with the Off-Road Engineering package.

With the exception of the **Slippery** off-road program, the off-road programs are intended for driving off-road away from public roads. The **Slippery** off-road program can also be used for driving on slippery or snow-covered roads.

Use the off-road program button to open the Off-road menu in the multimedia system.

Depending on the off-road program selected, the following vehicle characteristics will change:

- the drive (engine and transmission management)
- **vehicles with AIR BODY CONTROL:** the suspension
- the steering
- the availability of the ECO start/stop function

You can choose between the pre-configured off-road programs on the off-road menu. Up to five off-road programs are available, depending on the equipment level.

### Available off-road programs:

<b>Slippery</b>	Optimal driving characteristics on slippery or snow-covered roads
<b>Off-road</b>	Optimal driving characteristics for easily negotiable off-road terrain
<b>Rocking free</b>	Optimal driving characteristics for off-road terrain with raised vehicle level or if vehicle is stuck
<b>Gradient</b>	Optimal driving characteristics for steep off-road terrain
<b>Trailer</b>	Optimal driving characteristics for towing a trailer

The **Rocking free** off-road program is available only in vehicles with AIR BODY CONTROL.

Each time you start the engine with the Smart-Key or the Start/Stop button, the **C** (Comfort) drive program is activated.



## Off-road program

### Slippery off-road program

You can select the **Slippery** off-road program for snow or rain.

The **Slippery** off-road program has the following characteristics:

- The steering, drive, transmission and suspension are adapted for comfort.
- **Vehicles with AIR BODY CONTROL:** the vehicle is adjusted to normal level.
- The ECO start/stop function is available (▷ page 140).

ESP® and 4ETS programs especially adapted to slippery surfaces are also activated for maximum stability.

For more information on driving with snow chains, see (▷ page 351).

### Off-road off-road program

You can select the **Off-road** off-road program for driving on easily negotiable terrain, e.g. dirt roads, gravel and sand.

The **Off-road** program has the following characteristics:

- The steering, drive and suspension are adapted for comfort
- The transmission is adapted for off-road driving
- **Vehicles with AIR BODY CONTROL:** the vehicle is raised by 0.6 in (15 mm) compared with the normal level

The **Off-road** program assists you when driving in easily negotiable off-road terrain. The engine's performance characteristics and the gearshifting characteristics of the automatic transmission are adapted for this purpose. ABS, ESP® and 4ETS programs especially adapted to off-road driving are also activated.

### Rocking free off-road program

The Rocking free off-road program is available only in vehicles with AIR BODY CONTROL.

You can select the **Rocking free** off-road program to free the vehicle from especially difficult off-road terrain at low speeds.

The **Rocking free** off-road program has the following characteristics:

- The steering, drive and suspension are adapted for comfort
- The transmission is adapted for off-road driving
- The vehicle is raised by 2.0 in (50 mm) compared with the normal level

ABS, ESP® and 4ETS programs especially adapted to off-road driving are also activated.

The **Rocking free** off-road program can be selected up to a speed of 12 mph (20 km/h). If you are driving in the **Rocking free** off-road program at speeds above 12 mph (20 km/h):

- the vehicle switches to the off-road program **Off-road**
- the vehicle is lowered by 1.4 in (35 mm)

Notes on driving off-road (▷ page 165).

### Gradient off-road program

You can use the **Gradient** off-road program to overcome steep terrain.

The **Gradient** off-road program has the following characteristics:

- The steering, drive and suspension are adapted for comfort
- The transmission is adapted for off-road driving
- Manual gearshifting is activated (▷ page 152)
- **Vehicles with AIR BODY CONTROL:** the vehicle is raised by 0.6 in (15 mm) compared with the normal level
- DSR is activated (▷ page 180)

ABS, ESP® and 4ETS programs especially adapted to gradients are also activated.

### Trailer off-road program

Select the **Trailer** off-road program when towing a trailer.

The **Trailer** off-road program has the following characteristics:

- The steering, drive and suspension are adapted for comfort
- The transmission is adapted for off-road driving

- **Vehicles with AIR BODY CONTROL:** the vehicle is adjusted to normal level
- The ECO start/stop function is available (▷ page 140)

ESP® specially adapted for trailer operation is also activated.

## Activating/deactivating off-road programs



Activating the off-road program

- ▶ Press off-road program button ①.  
The multimedia system display shows the off-road menu **Offroad Settings**.
- ▶ Select the off-road program.  
The selected off-road program is activated. The symbol of the active off-road program appears on the multifunction display.

Further information on configuring the off-road programs via the multimedia system can be found in the Digital Operator's Manual.

The off-road program is deactivated if you:

- select the **Off** setting in the off-road menu.
- select a drive program using the DYNAMIC SELECT switch. (▷ page 144)
- switch off the engine. When the engine is restarted, drive program **C** is activated.

## RACE START

### Important safety notes

- ❗ RACE START is only available for the Mercedes-AMG GLC 63 4MATIC+ and Mercedes-AMG GLC 63 S 4MATIC+ models.
- ❗ RACE START must not be used on normal roads. RACE START must only be activated

and used on dedicated road circuits, outside of public road use.

- ❗ RACE START is only available after the vehicle has been run-in (▷ page 135).

RACE START enables optimal acceleration from a standing start. For this, a suitably high-grip road surface is required and the vehicle and tires must be in good working order.

### ⚠ WARNING

If you use RACE START, individual tires may start to spin and the vehicle could skid.

Depending on the selected ESP® mode, there is an increased risk of skidding and having an accident. Make sure that no persons, animals or obstacles are within range of the vehicle.

- ❗ Observe the safety notes on driving safety systems (▷ page 66).  
Be sure to read the safety notes and information on ESP® (▷ page 69).

## Activation conditions

You can activate RACE START if:

- the doors are closed
- the hood is closed
- the tailgate is closed
- the engine is running and the engine and transmission are at operating temperature
- the steering wheel is in the straight-ahead position.
- the vehicle is on a level surface
- the vehicle is stationary, the brake pedal is depressed (left foot) and the parking brake is released
- the transmission is in position **D**
- the drive program **S**, **S+** or **Race** is selected. (▷ page 144)

## Activating RACE START

- ▶ Quickly depress the accelerator pedal fully. The engine speed is increased.
- ❗ If the activation conditions are not fulfilled, RACE START cannot be carried out. The **RACE START Not Possible See Operator's Manual** message appears in the multifunction display.

► The **RACE START Release brake to start** message appears on the multifunction display.

**i** In this phase you can adjust RACE START depending on the road conditions: you can vary the engine speed by pulling on one of the steering wheel paddle shifters. The segments in the multifunction display flicker rapidly.

**i** If you do not release the brake pedal within a short time, RACE START will be canceled. The **RACE START Canceled** message appears in the multifunction display.

► Take your foot off the brake, but keep the accelerator pedal depressed. The vehicle pulls away at maximum acceleration.

The **RACE START Active** message appears on the multifunction display.

RACE START is deactivated when the vehicle reaches a speed of approximately 30 mph (Canada: 50 km/h).

RACE START is deactivated immediately if you release the accelerator pedal during RACE START or if any of the activation conditions are no longer fulfilled. The **RACE START Canceled** message appears in the multifunction display.

**i** If RACE START is used repeatedly within a short period of time, it is only available again after the vehicle has been driven a certain distance.

## AIR BODY CONTROL

### General notes

AIR BODY CONTROL is an air suspension system with variable damping for improved driving comfort. All-round level control ensures the best possible suspension and constant ground clearance, even with a laden vehicle. When you drive fast, the vehicle is lowered automatically to improve driving safety and to reduce fuel consumption. There is also the option to manually adjust the vehicle level.

AIR BODY CONTROL consists of:

- air suspension system with variable spring rate
- automatic level control
- speed-dependent lowering to reduce fuel consumption

- manual level control
- ADS PLUS (Adaptive Damping System with continuous damping adjustment)
- DYNAMIC SELECT switch (► page 144) and level button (► page 185)

## Available suspension settings

<b>C (Comfort)</b>	<ul style="list-style-type: none"> <li>• the suspension setting is comfortable</li> <li>• the vehicle is set to normal level</li> <li>• <b>Mercedes-AMG GLC 43 4MATIC:</b> at speeds above 100 mph (160 km/h), the vehicle level lowers</li> <li>• <b>Mercedes-AMG GLC 63 4MATIC+/GLC 63 S 4MATIC+:</b> at speeds above 112 mph (180 km/h), the vehicle level lowers</li> <li>• <b>All other models:</b> at speeds above 86 mph, (138 km/h) the vehicle level lowers</li> <li>• <b>Mercedes-AMG GLC 43 4MATIC:</b> at speeds less than 87 mph (140 km/h), the vehicle is raised again</li> <li>• <b>Mercedes-AMG GLC 63 4MATIC+/GLC 63 S 4MATIC+:</b> at speeds less than 75 mph (120 km/h), the vehicle is raised again</li> <li>• <b>All other models:</b> at speeds below 50 mph (80 km/h), the vehicle is raised again</li> <li>• <b>Mercedes-AMG GLC 63 4MATIC+/GLC 63 S 4MATIC+:</b> the 4MATIC+ is synchronised dynamically</li> </ul>
<b>E (Economy)</b>	<ul style="list-style-type: none"> <li>• the suspension setting is comfortable</li> <li>• the vehicle is set to low level</li> <li>• at higher speeds, the vehicle level does not continue to lower</li> </ul>

<b>S (Sport)</b>	<ul style="list-style-type: none"> <li>the suspension setting is more taut</li> <li>the vehicle is set to low level</li> <li>at higher speeds, the vehicle level does not continue to lower</li> <li><b>Mercedes-AMG GLC 63 4MATIC+ /GLC 63 S 4MATIC+:</b> the 4MATIC+ is synchronised more dynamically</li> </ul>
<b>S+ (Sport Plus)</b> <b>Mercedes-AMG GLC 63 4MATIC+ /GLC 63 S 4MATIC+:</b> <b>RACE</b>	<ul style="list-style-type: none"> <li>the suspension setting is even more taut</li> <li>the vehicle is set to low level</li> <li>at higher speeds, the vehicle level does not continue to lower</li> <li><b>Mercedes-AMG GLC 63 4MATIC+ /GLC 63 S 4MATIC+:</b> the 4MATIC+ is synchronised more dynamically</li> </ul>

### Important safety notes

#### WARNING

When the vehicle is being lowered, people could become trapped if their limbs are between the vehicle body and the wheels or underneath the vehicle. There is a risk of injury.

Make sure no one is underneath the vehicle or in the immediate vicinity of the wheel arches when the vehicle is being lowered.

- i** If one of the doors is open, the vehicle is not lowered.

## Vehicle level

### Setting the raised vehicle level





**Mercedes-AMG vehicles:** it is possible to choose between the "Normal" and "Raised" vehicle levels below a speed of 30 mph (50 km/h). Select the "Normal" setting for normal road surfaces and "Raised" for driving with snow chains or on particularly poor road surfaces. Your selection remains stored even if you remove the SmartKey from the ignition lock.

**All other models:** it is possible to choose between the "Normal" and "Raised" vehicle levels below a speed of 50 mph (80 km/h). Select the "Normal" setting for normal road surfaces and "Raised" for driving with snow chains or on particularly poor road surfaces. Your selection remains stored even if you remove the SmartKey from the ignition lock.

- ▶ Start the engine.

If indicator lamp  is not lit:

- ▶ Press button .  
Indicator lamp  lights up.  
The vehicle is set to high level.

The **Vehicle Rising** message appears on the multifunction display.

- i** The message disappears after ten seconds, irrespective of the level reached. If necessary, the vehicle is raised further.

**Mercedes-AMG GLC 43 4MATIC:** the "Raised level" setting is canceled if you:

- drive at speeds greater than 44 mph (70 km/h)
- drive for approximately three minutes at speeds greater than 37 mph (60 km/h)

**Mercedes-AMG GLC 63 4MATIC+/GLC 63 S 4MATIC+:** the "Raised level" setting is canceled if you:

- drive at speeds greater than 44 mph (70 km/h)
- drive for approximately three minutes at speeds greater than 37 mph (60 km/h)

**All other models:** the "Raised level" setting is canceled if you:

- drive faster than 75 mph (120 km/h)
- drive for approximately three minutes at a speed above 50 mph (80 km/h)

The "Raised level" remains active when you are not driving within these speed ranges.

### Setting the normal vehicle level

- ▶ Start the engine.

If indicator lamp ② is lit:

- ▶ Press button ①. Indicator lamp ② goes out. The vehicle is adjusted to the height of the currently selected drive program (▷ page 144).

### Lowering the rear of the vehicle (except Mercedes-AMG vehicles)



#### Lowering using the button in the left-hand-side cargo compartment trim

- ▶ Apply the electric parking brake.
- ▶ Shift the transmission to position **P**.
- ▶ Pull switch ① briefly. Indicator lamp ② flashes until the vehicle has been lowered.

The vehicle is lowered.

When the vehicle has been lowered, indicator lamp ② remains lit.

Lowering is interrupted if:

- a vehicle door is opened
- button ① was briefly pulled again
- the vehicle is moving faster than 1 mph (2 km/h)

The vehicle is automatically set to the level of the most recently selected drive program (▷ page 144) if you drive faster than 1 mph (2 km/h).

### Raising the rear of the vehicle (except Mercedes-AMG vehicles)

#### Raising using the button in the left-hand-side cargo compartment trim

- ▶ Pull switch ① briefly. Indicator lamp ② goes out. The vehicle is raised.

The vehicle is automatically set to the level of the most recently selected drive program (▷ page 144) if you drive faster than 1 mph (2 km/h).

- ▶ **If the vehicle can no longer be raised when stationary:** start the engine. The process will then be continued.

If you drive off when the rear of the vehicle has been lowered, the  **Vehicle Rising Please Wait** message may appear on the multifunction display.

### AMG sports suspension based on AIR BODY CONTROL (Mercedes-AMG vehicles)

#### General notes

The electronically controlled damping system works continuously. This improves driving safety and ride comfort.

The damping is tuned individually to each wheel and depends on:

- your driving style, e.g. sporty
- the road surface condition, e.g. bumps
- your individual selection of Sport, Sport+ or Comfort

The suspension setting is adjusted using the corresponding button in the center console.

- ❗ The mode can also be set using the DYNAMIC SELECT switch (▷ page 144).

This is possible only if the same mode is selected for the suspension by pressing the button on the center console for AMG sports suspension based on AIR BODY CONTROL and the DYNAMIC SELECT switch. This is the case, for example, when both are set to Comfort mode.

Each time you start the engine with the Smart-Key or the Start/Stop button, Comfort mode is activated. For further information about starting the engine, see (> page 138).

## Sport mode



"Sport" mode ensures a more taut suspension setting. Select this mode when employing a sporty driving style, e.g. on winding country roads.

- ▶ Press button ①.  
Indicator lamp ③ lights up. You have selected Sport mode.  
The **AMG Suspension System SPORT** message appears in the multifunction display.

## Sport + mode

"Sport +" mode ensures a very taut suspension setting.

If indicator lamps ② and ③ are off:

- ▶ Press button ① twice.  
Indicator lamps ② and ③ light up. You have selected Sport + mode.  
The **AMG Suspension System SPORT +** message appears in the multifunction display.

If indicator lamp ③ lights up:

- ▶ Press button ① once.  
Second indicator lamp ② lights up. You have selected Sport + mode.

The **AMG Suspension System SPORT +** message appears in the multifunction display.

## Comfort mode

In "Comfort" mode, the driving characteristics of your vehicle are comfortable. Select this mode if you favor a more comfortable driving style.

- ▶ Press button ① repeatedly until indicator lamps ② and ③ go out.  
You have selected Comfort mode.

The **AMG Suspension System COMFORT** message appears in the multifunction display.

## 4MATIC (permanent four-wheel drive)

4MATIC ensures permanent drive for all four wheels. Together with ESP®, it improves the traction of your vehicle whenever a drive wheel spins due to insufficient grip.

If you fail to adapt your driving style or if you are inattentive, 4MATIC can neither reduce the risk of an accident nor override the laws of physics.

4MATIC does not take into account

- the road and weather conditions
- the traffic situation

4MATIC is only an aid. You are responsible for the distance to the vehicle in front, for vehicle speed, for braking in good time and for staying in your lane.

If a drive wheel spins due to insufficient grip:

- Only depress the accelerator pedal as far as necessary when pulling away.
- Accelerate less when driving.

**!** Never tow the vehicle with one axle raised. This may damage the transfer case. Damage of this sort is not covered by the Mercedes-Benz Limited Warranty. All wheels must remain either on the ground or be fully raised. Observe the instructions for towing the vehicle with all wheels in full contact with the ground.

**i** In wintry driving conditions, the maximum effect of 4MATIC can only be achieved if you use winter tires (M+S tires), with snow chains if necessary.



## Parking Pilot

### General notes

Parking Pilot is an electronic parking aid with ultrasound. It measures the road on both sides of the vehicle. A parking symbol indicates a suitable parking space. Active steering intervention and brake application can assist you during parking and when exiting a parking space. You can also still use Parking Assist PARKTRONIC (▷ page 191).

### Important safety notes

Parking Pilot is only an aid. It is not a replacement for your attention to your immediate surroundings. You are always responsible for safe maneuvering, parking and exiting a parking space. Make sure that no persons, animals or objects are in the path of your vehicle.

When Parking Assist PARKTRONIC is deactivated, Parking Pilot is also unavailable.

For vehicles with a trailer tow hitch installed, the minimum length for parking spaces is slightly longer.

If you have attached a trailer to your vehicle, you should not use Parking Pilot. Once the electrical connection is established between your vehicle and the trailer, Parking Pilot is no longer available. Parking Assist PARKTRONIC is deactivated for the rear area.

#### WARNING

While parking or pulling out of a parking space, the vehicle swings out and can drive onto areas of the oncoming lane. This could result in a collision with another road user.

There is a risk of an accident.

Pay attention to other road users. Stop the vehicle if necessary or cancel the Parking Pilot parking procedure.

**!** If they cannot be avoided, drive over obstacles such as curbs slowly and at an obtuse angle. Otherwise, you may damage the wheels or tires.

Parking Pilot may also display spaces not suitable for parking, e.g.:

- where parking or stopping is prohibited
- in front of driveways or entrances and exits
- on unsuitable surfaces

### Parking tips:

- On narrow roads, drive as close to the parking space as possible.
- Parking spaces that are littered or overgrown might be identified or measured incorrectly.
- Parking spaces that are partially occupied by trailer drawbars might not be identified as such or be measured incorrectly.
- Snowfall or heavy rain may lead to a parking space being measured inaccurately.
- Pay attention to the warning messages of Parking Assist PARKTRONIC during the parking procedure (▷ page 193).
- You can intervene in the steering procedure to correct it at any time. Parking Pilot is then canceled-
- When transporting a load that protrudes from your vehicle, you should not use Parking Pilot-
- Never use Parking Pilot when snow chains are mounted.
- Always pay attention to the specified tire pressure for your vehicle. This has a direct influence on the parking characteristics of the vehicle.

Use Parking Pilot for parking spaces that are:

- parallel or at right angles to the direction of travel
- on straight roads, not bends
- on the same level as the road, e.g. not on the pavement

### Detecting parking spaces

Objects located above the detection range of Parking Pilot will not be detected when the parking space is measured. These are not taken into account when the parking procedure is calculated, e.g. overhanging loads, tail sections or loading ramps of trucks. Parking Pilot may therefore guide you into the parking space too early.

#### WARNING

If there are objects above the detection range:

- Parking Pilot may steer in too early
- the vehicle may not stop in front of these objects

You may cause a collision as a result. There is a risk of an accident.

If objects are located above the detection range, stop and deactivate Parking Pilot.



Further information about the detection range (▷ page 192).

Parking Pilot does not assist you parking in spaces at a right angle to the direction of travel if:

- two parking spaces are located directly next to one another
- the parking space is directly next to a low obstacle such as a low curb
- you forward-park

Parking Pilot does not assist you parking in spaces parallel with or at a right angle to the direction of travel if:

- the parking space is on a curb
- the system reads the parking space as being blocked, for example by foliage or grass paving blocks
- the area is too small for the vehicle to maneuver into
- the parking space is bordered by an obstacle, e.g. a tree, a post or a trailer

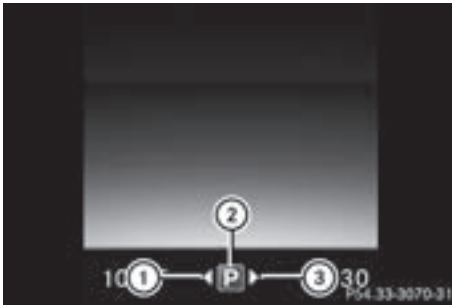

- ① Detected parking space on the left
- ② Parking symbol
- ③ Detected parking space on the right

Parking Pilot is activated automatically when driving forward. The system is operational at speeds of up to approximately 22 mph (35 km/h). While in operation, the system independently locates and measures parking spaces on both sides of the vehicle.

Parking Pilot will only detect parking spaces which are:

- parallel or at right angles to the direction of travel
- that are parallel to the direction of travel and at least 59 in (1.5 m) wide

- that are parallel to the direction of travel and at least 39.5 in (1.0 m) longer than your vehicle
- at right angles to the direction of travel and at least 39.5 in (1.0 m) wider than your vehicle

**i** Note that Parking Pilot cannot measure the length of parking spaces if they are at right angles to the direction of travel. You will need to judge whether your vehicle will fit into the parking space.

When driving at speeds below 19 mph (30 km/h), you will see parking symbol ② as a status indicator on the instrument cluster. When a parking space has been detected, an arrow towards the right or the left also appears. Parking Pilot only displays parking spaces on the front-passenger side as standard. Parking spaces on the driver's side are displayed as soon as the turn signal on the driver's side is activated. When parking on the driver's side, this must remain activated until you confirm the use of Parking Pilot by pressing the **[OK]** button on the multifunction steering wheel. The system automatically determines whether the parking space is parallel or at right angles to the direction of travel.

A parking space is displayed while you are driving past it, and until you are approximately 50 ft (15 m) away from it.

## Parking

### **⚠ WARNING**

If you leave the vehicle when it is only being braked by Parking Pilot, it could roll away if:

- there is a malfunction in the system or in the voltage supply.
- the electrical system in the engine compartment, the battery or the fuses are tampered with.
- the battery is disconnected.
- the vehicle is accelerated, e.g. by a vehicle occupant.

There is a risk of an accident.

Before leaving the vehicle, always secure it against rolling away.

**i** If Parking Assist PARKTRONIC detects obstacles, Parking Pilot brakes automatically

whilst the vehicle is being parked. You are responsible for braking in good time.

- ▶ Stop the vehicle when the parking space symbol shows the desired parking space in the instrument cluster.
- ▶ Shift the transmission to position **R**. The **Start Parking Pilot? Yes: OK No: [OK]** message appears on the multifunction display.
- ▶ **To cancel the procedure:** press the **[OK]** button on the multifunction steering wheel or pull away.

or

- ▶ **Parking using Parking Pilot:** press button **[OK]** on the multifunction steering wheel. The **Parking Pilot Active Accelerate and Brake Observe Surroundings** message appears on the multifunction display.
- ▶ Let go of the multifunction steering wheel.
- ▶ Back up the vehicle, being ready to brake at all times. When backing up, drive at a speed below approximately 6 mph (10 km/h). Otherwise, Parking Pilot is canceled immediately. Parking Pilot brakes the vehicle to a standstill when the vehicle approaches the rear border of the parking space.

Maneuvering may be required in tight parking spaces.

The **Parking Pilot Active Select D Observe Surroundings** message appears on the multifunction display.

- ▶ Shift the transmission to position **D** when the vehicle is stationary. Parking Pilot immediately steers in the other direction.

The **Parking Pilot Active Accelerate and Brake Observe Surroundings** message appears on the multifunction display.

- i** You will achieve the best results by waiting for the steering procedure to complete before pulling away.
- ▶ Drive forwards and be ready to brake at all times. Parking Pilot brakes the vehicle to a standstill when the vehicle approaches the front border of the parking space. Maneuvering may be required in tight parking spaces.

The **Parking Pilot Active Select R Observe Surroundings** message appears on the multifunction display.

As soon as the parking procedure is complete, the **Parking Pilot Finished** message appears and a warning tone sounds. The vehicle is now parked.

The vehicle is kept stationary without the driver having to depress the brake pedal. The braking effect is canceled when you depress the accelerator pedal.

Parking Pilot no longer supports you with steering interventions and brake applications. When Parking Pilot is finished, you must steer and brake again yourself. Parking Assist PARKTRONIC is still available.

Parking tips:

- The way your vehicle is positioned in the parking space after parking is dependent on various factors. These include the position and shape of the vehicles parked in front and behind it and the conditions of the location. It may be the case that Parking Pilot guides you too far into a parking space, or not far enough into it. In some cases, it may also lead you across or onto the curb. Cancel the parking procedure with Parking Pilot if necessary.
- You can also prematurely select transmission position **D**. The vehicle redirects and does not drive as far into the parking space. Should the transmission change take place too early, the parking procedure is canceled. A sensible parking position can no longer be achieved from this position.

## Exiting a parking space



In order for Parking Pilot to support you when exiting the parking space:

- the border of the parking space must be high enough at the front and the rear. A curb stone is too small, for example.
- the border of the parking space must not be too wide. Your vehicle can be maneuvered into the parking space at a maximum angle of 45° to the starting position.
- a maneuvering distance of at least 3.3 ft (1.0 m) must be available.

Parking Pilot can assist you with exiting a parking space only if you have parked the vehicle parallel to the direction of travel using Parking Pilot.

- i** If Parking Assist PARKTRONIC detects obstacles, Parking Pilot brakes automatically

while the vehicle is exiting the parking space. You are responsible for braking in good time.

- ▶ Start the engine.
- ▶ Release the electric parking brake.
- ▶ Switch on the turn signal in the direction you are pulling away.
- ▶ Shift the transmission to position **D** or **R**. The **Start Parking Pilot? Yes: OK No:**  message appears in the multifunction display.
- ▶ **To cancel the procedure:** press the  button on the multifunction steering wheel or pull away.

or

- ▶ **To exit a parking space using Parking Pilot:** press the  button on the multifunction steering wheel. The **Parking Pilot Active Accelerate and Brake Observe Surroundings** message appears in the multifunction display.
- ▶ Let go of the multifunction steering wheel.
- ▶ Pull away, being ready to brake at all times. Do not exceed a maximum speed of approximately 6 mph (10 km/h) when exiting a parking space. Otherwise, Parking Pilot is canceled immediately.
- ▶ Depending on the message or as required, shift the transmission to position **D** or **R**. Parking Pilot immediately steers in the other direction. The **Parking Pilot Active Accelerate and Brake Observe Surroundings** message appears in the multifunction display.

**i** You will achieve the best results by waiting for the steering procedure to complete before pulling away.

If you back up after activation, the steering wheel is moved to the straight-ahead position.

- ▶ Drive forwards and reverse as prompted by Parking Assist PARKTRONIC warning displays, several times if necessary.

Once you have exited the parking space completely, the steering wheel is moved to the straight-ahead position. You hear a tone and the **Parking Pilot Finished** message appears in the multifunction display. You will then have to steer and merge into traffic on your own. Parking Assist PARKTRONIC is still available. You can take over the steering before the vehicle has exited the parking space completely. This is

useful if you recognize that it is already possible to pull out of the parking space.

## Canceling Active Parking Pilot

- ▶ Stop the movement of the multifunction steering wheel or steer yourself. Parking Pilot is canceled immediately. The **Parking Pilot Canceled** message appears on the multifunction display.

or

- ▶ Press the Parking Assist PARKTRONIC button ( page 193). Parking Assist PARKTRONIC is switched off and Parking Pilot is immediately canceled. The **Parking Pilot Canceled** message appears on the multifunction display.

Parking Pilot is canceled automatically when:

- the electric parking brake is engaged
- transmission position **P** is selected
- parking using Parking Pilot is no longer possible
- you are driving faster than 6 mph (10 km/h)
- a wheel spins, ESP<sup>®</sup> intervenes or fails. In such cases the  warning lamp lights up in the instrument cluster

A warning tone sounds. The parking symbol disappears and the multifunction display shows the **Parking Pilot Canceled** message.

When Parking Pilot is canceled, you must steer and brake again yourself.

If a system malfunction occurs, the vehicle is braked to a standstill. To drive on, depress the accelerator again.

## Parking Assist PARKTRONIC

### Important safety notes

Parking Assist PARKTRONIC is an electronic parking aid with ultrasound. It monitors the area around your vehicle using six sensors in the front bumper and six sensors in the rear bumper. Parking Assist PARKTRONIC visually and audibly indicates the distance between your vehicle and an object.

Parking Assist PARKTRONIC is only an aid. It is not a replacement for your attention to your immediate surroundings. You are always responsible for safe maneuvering, parking and exiting a parking space. Make sure that there

are no persons, animals or objects in the maneuvering area while maneuvering and parking in/leaving parking spaces.

**!** When parking, pay particular attention to objects above or below the sensors, such as flower pots or trailer drawbars. Parking Assist PARKTRONIC does not detect such objects when they are in the immediate vicinity of the vehicle. You could damage the vehicle or the objects.

The sensors may not detect snow and other objects that absorb ultrasonic waves.

Ultrasonic sources such as an automatic car wash, the compressed-air brakes of a truck or a pneumatic drill could cause Parking Assist PARKTRONIC to malfunction.

Parking Assist PARKTRONIC may not function correctly on uneven terrain.

**!** If you do not need the trailer tow hitch, remove the detachable ball coupling. Parking Assist PARKTRONIC measures the minimum detection range to an obstacle from the bumper, not the ball coupling.

Parking Assist PARKTRONIC is activated automatically when you:

- switch on the ignition
- shift the transmission to position **D**, **R** or **N**

Parking Assist PARKTRONIC is deactivated at speeds above 11 mph (18 km/h). It is reactivated at lower speeds.

Parking Assist PARKTRONIC is deactivated for the rear area when you establish an electrical connection between your vehicle and a trailer.

### Range of the sensors

Parking Assist PARKTRONIC does not take into account obstacles located:

- below the detection range, such as persons, animals or objects
- above the detection range, e.g. overhanging loads, tail sections or loading ramps of trucks

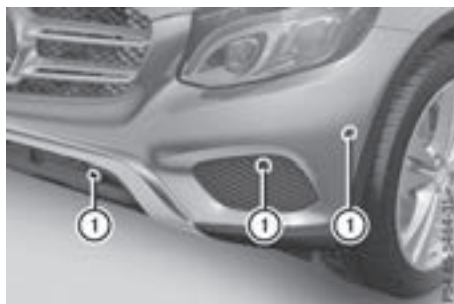

① Sensors in the front bumper, left-hand side (example)

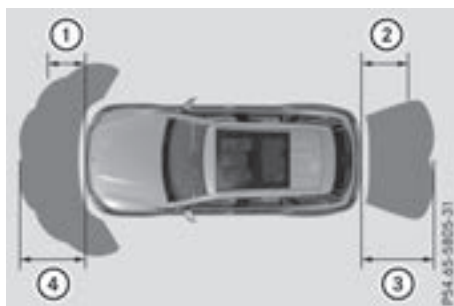
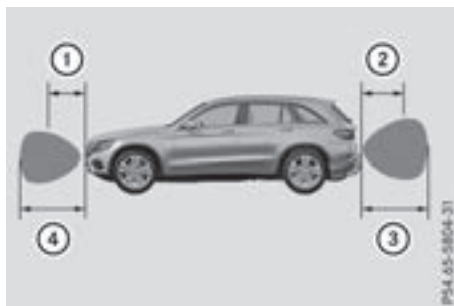

- ① Approx. 24 in (approx. 60 cm) (corners)
- ② Approx. 32 in (approx. 80 cm) (corners)
- ③ Approx. 48 in (approx. 120 cm) (center)
- ④ Approx. 40 in (approx. 100 cm) (center)

The sensors must be free from dirt, ice or slush. They can otherwise not function correctly. Clean the sensors regularly, taking care not to scratch or damage them (▷ page 328).

Minimum distance

Center	Approx. 8 in (approx. 20 cm)
Corners	Approx. 6 in (approx. 15 cm)

If there is an obstacle within this range, the relevant warning displays light up and a warning tone sounds. If the distance falls below the minimum, the distance may no longer be shown.

### Warning displays

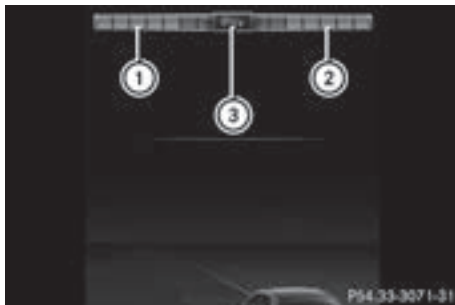

- ① Segments on the left-hand side of the vehicle
- ② Segments on the right-hand side of the vehicle
- ③ Segments showing operational readiness

The warning displays show the distance between the sensors and the obstacle. The warning display for the front area is in the instrument cluster. The warning display for the rear area is located on the headliner in the rear compartment.

The warning display for each side of the vehicle is divided into five yellow and two red segments. Parking Assist PARKTRONIC is operational if operational readiness indicator ③ lights up. The selected transmission position and the direction in which the vehicle is rolling determine which warning display is active when the engine is running.

Transmission position	Warning display
<b>D</b>	Front area activated
<b>R</b> , <b>N</b> or the vehicle is rolling backwards	Rear and front areas activated
<b>P</b>	No areas activated

One or more segments light up as the vehicle approaches an obstacle, depending on the vehicle's distance from the obstacle. In addition, warning tones are issued.

When the distance to the obstacle is sufficient, you will hear an intermittent warning tone. The shorter the distance to the obstacle, the shorter the frequency of the intermittent warning tones becomes. When the minimum distance is reached, you hear a continuous warning tone.

### Deactivating/activating Parking Assist PARKTRONIC

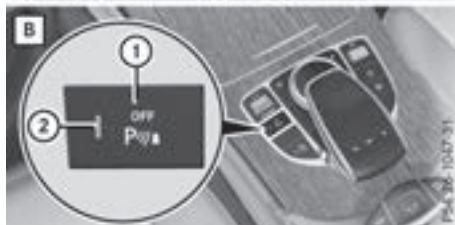
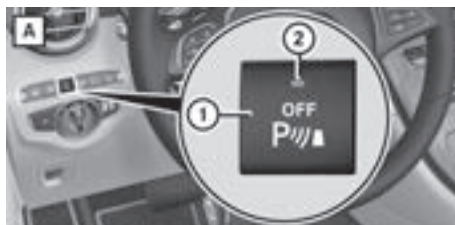

- A** Switch on the dashboard
- B** Switch in the center console
- ① Deactivates or activates Parking Assist PARKTRONIC
- ② Indicator lamp

If indicator lamp ② lights up, Parking Assist PARKTRONIC is deactivated. Parking Pilot is then also deactivated.

- i** Parking Assist PARKTRONIC is automatically activated when you turn the SmartKey to position ② in the ignition lock.

## Problems with Parking Assist PARKTRONIC

Problem	Possible causes/consequences and ► Solutions
<p>Only the red segments in the Parking Assist PARKTRONIC warning displays are lit. You also hear a warning tone for approximately two seconds.</p> <p>Parking Assist PARKTRONIC is then deactivated and the indicator lamp on the PARKTRONIC button lights up.</p>	<p>Parking Assist PARKTRONIC has malfunctioned and has been deactivated.</p> <p>► If problems persist, have Parking Assist PARKTRONIC checked at a qualified specialist workshop.</p>
<p>Only the red segments in the Parking Assist PARKTRONIC warning displays are lit. Parking Assist PARKTRONIC is then deactivated.</p>	<p>The Parking Assist PARKTRONIC sensors are dirty or there is interference.</p> <p>► Clean the Parking Assist PARKTRONIC sensors (▷ page 328).</p> <p>► Switch the ignition back on.</p> <p>The problem may be caused by an external source of radio or ultrasound waves.</p> <p>► Check to see if Parking Assist PARKTRONIC works at a different location.</p>

### Rear view camera

#### General notes



Rear view camera **i** is an optical parking and maneuvering aid. It shows the area behind the vehicle with guide lines in the multimedia system.

The area behind the vehicle is displayed as a mirror image, as in the rear view mirror.

**i** The text shown in the multimedia system depends on the language setting. The follow-

ing are examples of rear view camera displays in the multimedia system.

#### Important safety notes

The rear view camera is only an aid. It is not a replacement for your attention to your immediate surroundings. You are always responsible for safe maneuvering and parking. Make sure that there are no persons, animals or objects in the maneuvering area while maneuvering and parking in parking spaces.

Under the following circumstances, the rear view camera will not function, or will function in a limited manner:

- if the tailgate is open
- in heavy rain, snow or fog
- at night or in very dark places
- if the camera is exposed to very bright light
- if the area is lit by fluorescent bulbs or LED lighting (the display may flicker)



- if there is a sudden change in temperature, e.g. when driving into a heated garage in winter
- if the camera lens is dirty or obstructed. Observe the notes on cleaning (▷ page 328)
- if the rear of your vehicle is damaged. In this case, have the camera position and setting checked at a qualified specialist workshop

The field of vision and other functions of the rear view camera may be restricted due to additional accessories on the rear of the vehicle (e.g. license plate holder, rear bicycle rack).

The rear view camera is protected from rain-drops and dust by means of a flap. When the rear view camera is activated, this flap opens.

The flap closes again when:

- you have finished the maneuvering process
- you switch off the engine
- you open the cargo compartment

Observe the notes on cleaning (▷ page 328).

For technical reasons, the flap may remain open briefly after the rear view camera has been deactivated.

### Activating/deactivating the rear view camera



- ▶ **To activate:** make sure that the **Activation by R gear** function is selected in the multimedia system (see the Digital Operator's Manual).
- ▶ Engage reverse gear. The rear view camera flap opens. The multimedia system shows the area behind the vehicle with guide lines. The image from the rear view camera is available throughout the maneuvering process.

- ▶ **To switch the function mode for vehicles with trailer tow hitch:** using the controller, select symbol ① for the "Reverse parking" function or symbol ② for "Coupling up a trailer". The symbol of the selected function is highlighted.

- ▶ **To deactivate:** shift the transmission to position **P**.

or

- ▶ Drive forwards at a speed greater than 7 mph (12 km/h).

### Multimedia display

The rear view camera may show a distorted view of obstacles, show them incorrectly or not at all. The rear view camera does not show objects in the following positions:

- very close to the rear bumper
- under the rear bumper
- in the area immediately above the tailgate handle

❗ Objects not at ground level may appear to be further away than they actually are, e.g.:

- the bumper of a parked vehicle
- the drawbar of a trailer
- the ball coupling of a trailer tow hitch
- the rear section of an HGV
- a slanted post

Use the guidelines only for orientation.

Approach objects no further than the bottom-most guideline.





- ① Yellow guide line at a distance of approximately 13 ft (4.0 m) from the rear of the vehicle
- ② White guide lines without steering input, vehicle width including the exterior mirrors (static)
- ③ Yellow guide lines for vehicle width including the exterior mirrors, for current steering input (dynamic)
- ④ Yellow lanes marking the course the tires will take at the current steering wheel angle (dynamic)



- ⑤ Yellow guide line at a distance of approximately 3 ft (1.0 m) from the rear of the vehicle
- ⑥ Vehicle center axle (marker assistance)
- ⑦ Bumper
- ⑧ Red guide line at a distance of approximately 12 in (0.30 m) from the rear of the vehicle

When the transmission is shifted to position **R**, guide lines appear in the camera image.

The distance specifications only apply to objects that are at ground level.



- ⑨ Front warning display
- ⑩ Rear warning display
- ⑪ Additional vehicle icon as Parking Assist PARKTRONIC measurement operational readiness indicator

#### Vehicles with Parking Assist PARKTRONIC:

When Parking Assist PARKTRONIC is operational, vehicle icon (▷ page 193), appears on the multimedia system display ⑪. If the Parking Assist PARKTRONIC warning displays are active or light up, warning displays ⑨ and ⑩ are also active or light up correspondingly on the multimedia system display.

#### "Reverse parking" function

##### Backing up straight into a parking space without steering input



- ① White guide line without steering input – vehicle width including the exterior mirrors (static)
- ② Yellow guide lines for vehicle width including the exterior mirrors – dynamic for current steering input

- ③ Yellow guide line at a distance of approximately 3 ft (1.0 m) from the rear of the vehicle
- ④ Red guide line at a distance of approximately 12 in (0.30 m) from the rear of the vehicle
- ▶ Make sure that the rear view camera is switched on (▷ page 195). The lane and the guide lines appear.
- ▶ With the help of white guide line ①, check whether the vehicle will fit into the parking space.
- ▶ Using white guide line ① as a guide, carefully back up until you reach the end position. Red guide line ④ is then at the end of the parking space. The vehicle is almost parallel in the parking space.

### Reverse perpendicular parking with steering input



- ▶ After driving past the parking space, stop the vehicle safely.
- ▶ Make sure that the rear view camera is switched on (▷ page 195). The lane and the guide lines appear in the camera image.
- ▶ While the vehicle is stationary, turn the steering wheel in the direction of the parking space until yellow guide lines ② reach parking space marking ①. Yellow guide lines ② dynamically adapt to the current steering input.
- ▶ Maintain the steering input and reverse carefully.



- ▶ Stop the vehicle when it is almost exactly in front of the parking space.

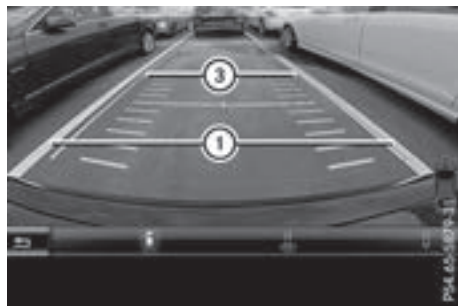

- ① Parking space markings
- ③ White guide lines – for current steering input

White guide lines ③ should be as close to parallel with parking space markings ① as possible.

- ▶ Turn the steering wheel to the center position while the vehicle is stationary.



- ④ Red guide line at a distance of approximately 12 in (0.30 m) from the rear of the vehicle
- ⑤ White guide lines – no steering input
- ⑥ End of parking space

- ▶ Back up carefully until you have reached the final position.

The red guide line ④ is then at the end of the parking space ⑥. The vehicle is almost parallel in the parking space.

### "Coupling up a trailer" function

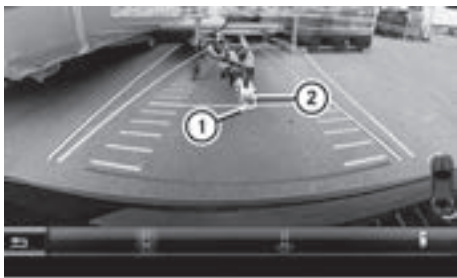

① Vehicle center point on the yellow guide line at a distance of approximately 3 ft (1.0 m) from the rear of the vehicle

② Trailer drawbar

This function is only available on vehicles with a trailer tow hitch.

- ▶ Before coupling up a trailer, set the height of trailer drawbar ② so that it is slightly higher than the ball coupling.
- ▶ Position the vehicle centrally in front of trailer drawbar ②.

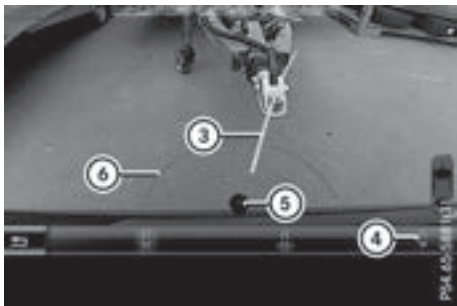

③ Trailer drawbar marker assistant

④ Symbol for the "Coupling up a trailer" function

⑤ Ball coupling

⑥ Red guide line at a distance of approximately 12 in (0.30 m) from the ball coupling

- ▶ Select symbol ④ using the multimedia system controller.

The "Coupling up a trailer" function is selected. The distance specifications now only apply to objects that are at the same level as the ball coupling.

- ▶ Reverse carefully, making sure that trailer drawbar locating aid ③ points approximately in the direction of trailer drawbar ②.
- ▶ Reverse carefully until trailer drawbar ② reaches red guide line ⑥. The distance between trailer drawbar ② and red guide line ⑥ is now approximately 12 in (0.30 m).
- ▶ Couple up the trailer (▷ page 216).

### "Wide-angle" function



① Symbol for the wide-angle view function

② Your vehicle

③ Warning displays for Parking Assist PARKTRONIC

You can also use the rear view camera to select a wide-angle view.

When Parking Assist PARKTRONIC is operational (▷ page 193), a symbol for your own vehicle appears in the multimedia system display. If the Parking Assist PARKTRONIC warning displays are active, warning displays ③ light up on the multimedia system display in yellow or red accordingly.

### Object detection

The rear view camera helps detect moving and stationary objects. If an object (person, vehicle or other obstacle) is detected, this object is marked with a bar. Objects located some distance from the vehicle away are marked with a yellow bar. If the distance to the object is very small, the bar is displayed in red.

Object detection only works in wide-angle view. To ensure that you can use the function, it must be switched on in the multimedia system (see the Digital Operator's Manual).

## 360° Camera

### General notes

The 360° camera is a system consisting of four cameras.

The system processes images from the following cameras:

- Rear view camera
- Front camera
- Two side cameras in the exterior mirrors

The cameras cover the immediate surroundings of the vehicle. The system supports you, for example when parking or if vision is restricted at an exit.

You can show images from the 360° camera in full-screen mode or in seven different split-screen views on the multimedia system. A split-screen view also includes a top view of the vehicle. This view is calculated from the data supplied by the installed cameras (virtual camera).

The seven split-screen views are:

- Top view and picture from the rear view camera (130° viewing angle)
- Top view and image from the front camera (130° viewing angle without displaying the maximum steering wheel angle)
- Top view and enlarged rear view
- Top view and enlarged front view
- Top view and trailer view (vehicles with trailer tow hitch)
- Top view and images from the rear-facing side cameras (rear wheel view)
- Top view and images from the forward-facing side cameras (front wheel view)

When the function is active and you shift the transmission from **D** or **R** to **N**, the guide lines on the multimedia system are hidden.

When you shift between transmission positions **D** and **R**, you see the previously selected front or rear view.

Distances measured by Parking Assist PARKTRONIC will also be optically displayed:

- in split screen view as red or yellow brackets around the vehicle icon in the top view, or
- at the bottom right as red or yellow brackets around the vehicle symbol in full-screen mode

The line thickness and color of the brackets show how far the vehicle is from an object.

- yellow brackets with thin lines: Parking Assist PARKTRONIC is active
- yellow brackets with normal lines: an object is present in close range of the vehicle
- red line: an object is present in the immediate close range of the vehicle

### Important safety notes

The 360° camera is only an aid and may show a distorted view of obstacles, show them incorrectly or not at all. The 360° camera is not a substitute for attentive driving.

You are always responsible for safe maneuvering and parking. Make sure that there are no persons, animals or objects in the maneuvering area while maneuvering and parking in parking spaces.

You are always responsible for safety, and must always pay attention to your surroundings when parking and maneuvering. This applies to the areas behind, in front of and beside the vehicle. You could otherwise endanger yourself and others.

The 360° camera will not function or will function in a limited manner:

- if the doors are open
- if the exterior mirrors are folded in
- if the tailgate is open
- in heavy rain, snow or fog
- at night or in very dark places
- if the cameras are exposed to very bright light
- if the area is lit by fluorescent bulbs or LED lighting (the display may flicker)
- if the camera lenses fog up, e.g. when driving into a heated garage in winter, causing a rapid change in temperature
- if the camera lenses are dirty or covered
- if the vehicle components in which the cameras are installed are damaged. In this case, have the camera position and setting checked at a qualified specialist workshop

Do not use the 360° camera in this case. You can otherwise injure others or cause damage to objects or the vehicle.

The guide lines in the multimedia system display show the distances to your vehicle. The distances only apply to road level.

In trailer mode, the guide lines are shown at the level of the trailer tow hitch.

The camera in the rear area is protected by means of a flap. This flap opens when the 360° camera is activated. Observe the notes on cleaning (> page 328). For technical reasons, the flap may remain open briefly after the 360° camera has been deactivated.

The field of vision and other functions of the camera system may be restricted due to additional attachments (e.g. license plate holder, rear bicycle carrier).

On vehicles with height-adjustable chassis, depending on technical conditions, leaving the standard height can result in:

- inaccuracies in the guide lines
- inaccuracies in the display of generated images (top view)

### Activation conditions

The image from the 360° camera appears if:

- the multimedia system is switched on
- the **360° Camera** function is switched on

If you are driving faster than at a moderate speed and you turn on the 360° camera, a warning message appears.

The warning message disappears if:

- you are again driving at a moderate speed The 360° camera is then activated
- the message is confirmed with the  button

### Switching the 360° camera on and off using the button



- ▶ **To switch on:** press button ①.  
Depending on whether transmission position **D** or **R** is selected, the following appears:
  - a split screen with top view and the image from the front camera or
  - a split screen with top view and the image from the rear view camera
- ▶ **To switch off:** press button ①.

### Activating the 360° camera using reverse gear

The 360° camera images can be automatically displayed by engaging reverse gear.

- ▶ Make sure that the **Activation by R gear** function is selected on the multimedia system (see the Digital Operator's Manual).
- ▶ **To show the 360° camera image:** engage reverse gear.

The multimedia system shows the area behind the vehicle in split-screen mode. You see the top view of the vehicle and the image from the rear view camera.

You cannot stop the 360° camera display if reverse gear is engaged.

### Selecting the split-screen view or full screen mode

Switching between split screen views:

- ▶ To switch to the line with the vehicle icons: slide  the controller.
- ▶ To select a vehicle icon: turn the controller.

Switching to full screen mode:

- ▶ Turn and press **180° View** with the controller.



The full screen option is only available in the following views:

- Top view with picture from the rear view camera
- Top view with picture from the front camera

### Multimedia display

#### Important safety notes

The camera system may show a distorted view of obstacles, show them incorrectly or not at all. Obstacles are not shown by the system in the following locations:

- under the front and rear bumpers
- very close to the front and rear bumpers
- in the area immediately above the tailgate handle
- very close to the exterior mirrors
- in the transitional areas between the various cameras in the virtual top view

**!** Objects not at ground level may appear to be further away than they actually are, e.g.:

- the bumper of a parked vehicle
- the drawbar of a trailer
- the ball coupling of a trailer tow hitch
- the rear section of an HGV
- a slanted post

Use the guidelines only for orientation. Approach objects no further than the bottom-most guideline.

#### Top view with picture from the rear view camera



- ① Yellow guide line at a distance of approximately 13 ft (4.0 m) from the rear of the vehicle
- ② Symbol for the split screen setting with top view and rear view camera image

- ③ Guide lines for the maximum steering input
- ④ Yellow lanes marking the course the tires will take at the current steering wheel angle (dynamic)
- ⑤ Yellow guide lines for vehicle width including the exterior mirrors – dynamic for current steering input



- ⑥ Vehicle center axis (locating aids)
- ⑦ Yellow guide line at a distance of approximately 3 ft (1.0 m) from the rear of the vehicle
- ⑧ Bumper
- ⑨ Red guide line at a distance of approximately 12 in (0.30 m) from the rear of the vehicle

When reverse gear is selected, guide lines appear on the camera image.

The distance specifications only apply to objects that are at ground level.

#### Top view with picture from the front camera



- ① Symbol for the split screen setting with top view and front camera image
- ② Yellow guide line at a distance of approximately 13 ft (4.0 m) from the front of the vehicle

- ③ Yellow guide lines for vehicle width including the exterior mirrors, for current steering input (dynamic)
- ④ Yellow lanes marking the course the tires will take at the current steering wheel angle (dynamic)
- ⑤ Red guide line at a distance of approximately 12 in (0.30 m) from the front of the vehicle
- ⑥ Yellow guide line at a distance of approximately 3 ft (1.0 m) from the front of the vehicle

### Top view and enlarged rear view

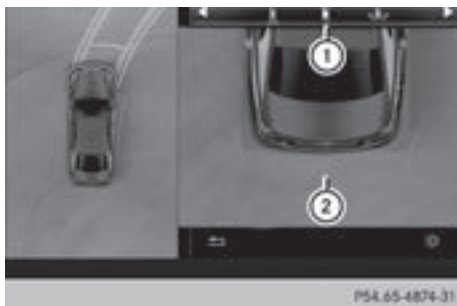

- ① Symbol for the split screen setting with top view and rear view camera image enlarged
- ② Red guide line at a distance of approximately 12 in (0.30 m) from the rear of the vehicle

This view assists you in estimating the distance to the vehicle behind you.

- i** This setting can also be selected as an enlarged front view.

### Top view with image from the side cameras



- ① Symbol for the top view and forward-facing side camera setting
- ② Yellow guide line for the vehicle width including the exterior mirrors (right side of vehicle)
- ③ Yellow guide line for the vehicle width including the exterior mirrors (left side of vehicle)

- i** You can also select the side camera setting for the rear-facing view.

### "Coupling up a trailer" function

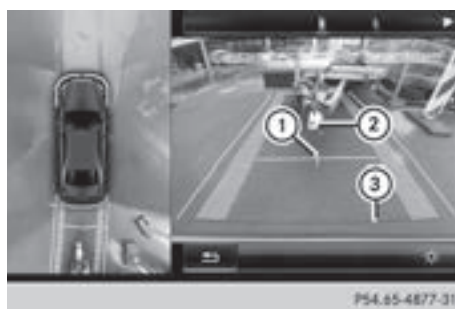

- ① Vehicle center point on the yellow guide line at a distance of approximately 3 ft (1.0 m) from the rear of the vehicle
  - ② Trailer drawbar
  - ③ Red guide line at a distance of approximately 12 in (0.30 m) from the rear of the vehicle
- ▶ Set the height of trailer drawbar ② so that it is slightly higher than the ball coupling.
  - ▶ Position the vehicle centrally in front of trailer drawbar ②.



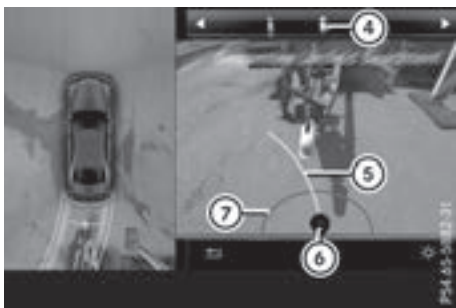

For technical reasons, the ball coupling ⑥ of the trailer tow hitch on the multimedia system display is either only partially visible or not visible at all.

- ▶ Select symbol ④ using the controller. The "Coupling up a trailer" function is selected. The distance specifications now only apply to objects that are at the same level as the ball coupling.
- ▶ Reverse carefully, making sure that trailer drawbar locating aid ⑤ points approximately in the direction of the trailer drawbar.
- ▶ Reverse carefully until the trailer drawbar reaches red guide line ⑦. The distance between the trailer drawbar and red guide line ⑦ is now approximately 12 in (0.30 m).
- ▶ Couple up the trailer (▷ page 216).

The lines are shown at the level of the trailer tow hitch.

## 180° view



- ① Symbol for the full screen setting with rear view camera image
- ② Your vehicle
- ③ Warning displays for Parking Assist PARKTRONIC

- ① 180° view can also be selected as front view.

Select this view when you are driving out of an exit and the view of crossing traffic is restricted, for example.

If you select the  symbol in the display and confirm with the controller, the split-screen view appears.

## Exiting 360° camera display mode

- ▶ Shift the transmission to position **P**.  
or
- ▶ Drive forwards at a speed greater than 6 mph (10 km/h). The 360° camera display is stopped. The view that was active before the 360° camera was displayed appears in the multimedia system display. You can stop the 360° camera from the split-screen view by selecting the  symbol on the display and confirming with the controller. You cannot stop the 360° camera display if transmission position **R** is selected.

## ATTENTION ASSIST

### General notes

ATTENTION ASSIST helps you during long, monotonous journeys, such as on highways. It is active in the 37 mph (60 km/h) to 124 mph (200 km/h) speed range. If ATTENTION ASSIST detects typical indicators of fatigue or increasing lapses in concentration on the part of the driver, it suggests taking a break.

### Important safety notes

ATTENTION ASSIST is only an aid to the driver. It might not always recognize fatigue or increasing inattentiveness in time or fail to recognize them at all. The system is not a substitute for a well-rested and attentive driver.

The functionality of ATTENTION ASSIST is restricted and warnings may be delayed or not occur at all:

- if the length of the journey is less than approximately 30 minutes
- if the road condition is poor, e.g. if the surface is uneven or if there are potholes

- if there is a strong side wind
- if you have adopted a sporty driving style with high cornering speeds or high rates of acceleration
- if you are predominantly driving at a speed below 37 mph (60 km/h) or above 124 mph (200 km/h)
- if you are driving with the Steering Pilot of Distance Pilot DISTRONIC activated
- if the time has been set incorrectly
- in active driving situations, such as when you change lanes or change your speed

The ATTENTION ASSIST tiredness assessment is deleted and restarted when continuing the journey, if:

- you switch off the engine
- you take off your seat belt and open the driver's door, e.g. for a change of drivers or to take a break

### Displaying the attention level



In the Assistance menu (▷ page 232) of the on-board computer, you can call up the current status information.

- ▶ Select the Assistance display for ATTENTION ASSIST using the on-board computer (▷ page 231).

The following information appears:

- The length of the journey since the last break.
- the attention level determined by ATTENTION ASSIST (**Attention Level**), displayed in a bar display in five levels from high to low.
- if ATTENTION ASSIST is unable to calculate the attention level and cannot issue a warning, the **System Suspended** message appears. The bar display then changes the display, e.g. if you are driving at a speed below

37 mph (60 km/h) or above 124 mph (200 km/h).

### Activating ATTENTION ASSIST

- ▶ Activate ATTENTION ASSIST using the on-board computer (▷ page 233).

The system determines the attention level of the driver depending on the setting selected:

Selection **Standard**: the sensitivity with which the system determines the attention level is set to normal.

Selection **Sensitive**: the sensitivity is set higher. The attention level detected by Attention Assist is adapted accordingly and the driver is warned earlier.

When ATTENTION ASSIST is deactivated, the  symbol appears in the multifunction display in the assistance graphic display.

When ATTENTION ASSIST has been deactivated, it is automatically reactivated after the engine has been stopped. The sensitivity selected corresponds to the last selection activated (standard/sensitive).

### Warning in the multifunction display

If fatigue or increasing lapses in concentration are detected, a warning appears in the multifunction display: **ATTENTION ASSIST Take a Break!**

In addition to the message shown in the multifunction display, you will then hear a warning tone.

- ▶ If necessary, take a break.
- ▶ Confirm the message by pressing the  button on the steering wheel.

On long journeys, take regular breaks in good time to allow yourself to rest properly. If you do not take a break and ATTENTION ASSIST continues to detect increasing lapses in concentration, you will be warned again after 15 minutes at the earliest. This will only happen if ATTENTION ASSIST still detects typical indicators of fatigue or increasing lapses in concentration.

### Vehicles with COMAND multimedia system:

if a warning appears in the multifunction display, a service station search is performed in the multimedia system. You can select a service station and navigation to this service station will then begin. This function can be activated and deactivated in the COMAND multimedia system (see the Digital Operator's Manual).

## Traffic Sign Assist

### General notes

Traffic Sign Assist displays the maximum speed permitted to the driver in the instrument cluster. The data and general traffic regulations stored in the navigation system are used to determine the current speed limit.

Traffic Sign Assist is a map-based system, and for this reason, traffic signs put up temporarily (e.g. near roadworks) are not detected. There is also no display for changing traffic signs.

Traffic signs with a restriction indicated by an additional sign (e.g. in wet conditions) are also shown.

The sign indicating the end of a restriction only appears with the restriction in the instrument cluster when:

- The regulation must be observed with the restriction, or
- Traffic Sign Assist is unable to determine whether the restriction applies

If Traffic Sign Assist is unable to determine a maximum permitted speed from any of the available sources, no speed limit appears in the instrument cluster either.



Traffic Sign Assist is not available in all countries. In this case, display ① appears in the assistance graphic (▷ page 231).

### Important safety notes

Traffic Sign Assist is only an aid and is not always able to correctly display speed limits. Traffic signs always have priority over the Traffic Sign Assist display.

The system may be either functionally impaired or temporarily unavailable if the information in the digital street map of the navigation system is incorrect or out of date.

## Instrument cluster display

### Displaying the assistance graphic

- ▶ Call up the assistance graphic display function using the on-board computer (▷ page 231).  
Detected traffic signs appear in the instrument cluster.

### Speed limit with unknown restriction



- ① Maximum permitted speed
- ② Maximum permitted speed for vehicles for which the restriction in the additional sign is relevant
- ③ Additional sign for unknown restriction

A maximum permitted speed of 80 mph (80 km/h) and a speed limit of 60 mph (60 km/h) with an unknown restriction apply.

The unit for the speed limit (km/h or mph) depends on the country in which you are driving. It is generally neither shown on the traffic sign nor on the instrument cluster but must be taken into account when observing the maximum permitted speed.

## Lane Tracking package

### General notes

The Lane Tracking package consists of Blind Spot Assist (▷ page 205) and Lane Keeping Assist (▷ page 207).

### Blind Spot Assist

#### General notes

Blind Spot Assist monitors the areas on either side of the vehicle that are not visible to the driver with two lateral, rear-facing radar sen-

sors. A warning lamp lights up in the exterior mirrors and draws your attention to vehicles detected in the monitored area. If you then switch on the corresponding turn signal to change lane, you will also receive an optical and audible warning.

Blind Spot Assist supports you from a speed of approximately 20 mph (30 km/h).

### Important safety notes

#### WARNING

Blind Spot Assist does not react to:

- vehicles overtaken too closely on the side, placing them in the blind spot area
- vehicles which approach with a large speed differential and overtake your vehicle

As a result, Blind Spot Assist may not give warnings in such situations. There is a risk of an accident.

Always observe the traffic conditions carefully, and maintain a safe lateral distance.

Blind Spot Assist is only an aid. It may fail to detect some vehicles and is no substitute for attentive driving. Always ensure that there is sufficient distance to the side for other road users and obstacles.

#### USA only:

This device has been approved by the FCC as a "Vehicular Radar System". The radar sensor is intended for use in an automotive radar system only. Removing, tampering with, or altering the device will void any warranties, and is not permitted by the FCC. Do not tamper with, alter, or use in any non-approved way.

Any unauthorized modification to this device could void the user's authority to operate the equipment.

### Radar sensors

The radar sensors for Blind Spot Assist are integrated into the rear bumper. Make sure that the bumpers are free from dirt, ice or slush. The sensors must not be covered, for example by cycle racks or overhanging loads. Following a severe impact or in the event of damage to the bumpers, have the function of the radar sensors checked at a qualified specialist workshop. Blind Spot Assist may no longer work properly.

### Monitoring area

In particular, the detection of obstacles can be impaired if:

- there is dirt on the sensors or anything else covering the sensors
- there is poor visibility, e.g. due to fog, heavy rain, snow or spray
- there are narrow vehicles, e.g. motorcycles or bicycles
- the road has very wide lanes
- the road has narrow lanes
- you are not driving in the middle of the lane
- there are barriers or other road boundaries

Vehicles in the monitoring range are then not indicated.

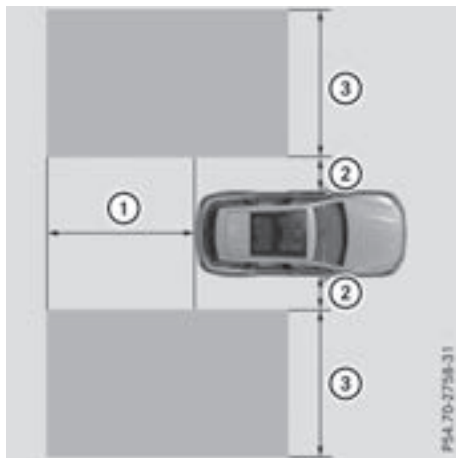

At a distance of around 1.6 ft (0.5 m) ② from the vehicle, Blind Spot Assist monitors the area up to 10 ft (3 m) next to ③ and behind ① your vehicle, as shown in the picture.

If the lanes are narrow, vehicles driving in the lane beyond the lane next to your vehicle may be indicated, especially if the vehicles are not driving in the middle of their lane. This may be the case if the vehicles are driving on the inner side of their lane.

Due to the nature of the system:

- warnings may be issued in error when driving close to crash barriers or similar solid lane borders
- warnings may be interrupted when driving alongside long vehicles, e.g. trucks, for a prolonged time

## Warning lamp



### ① Warning lamp

Blind Spot Assist is not active at speeds below approximately 20 mph (30 km/h). Vehicles in the monitoring range are then not indicated.

If a vehicle is detected within the blind spot monitoring range at speeds above 20 mph (30 km/h), warning lamp ① on the corresponding side lights up red. This warning is always emitted when a vehicle enters the blind spot monitoring range from behind or from the side. When you overtake a vehicle, the warning only occurs if the difference in speed is less than 7 mph (12 km/h).

If you select the reverse gear, Blind Spot Assist is not operational.

The brightness of the warning lamps is automatically adapted to the brightness of the surroundings.

## Collision warning

If a vehicle is detected in the monitoring range of Blind Spot Assist and you switch on the corresponding turn signal, a double warning tone sounds. The red warning lamp flashes on the relevant exterior mirror. If the turn signal remains on, detected vehicles are indicated by the flashing of the red warning lamp on the exterior mirror. There are no further warning tones.

## Activating Blind Spot Assist

- ▶ Make sure that Blind Spot Assist is activated in the on-board computer (> page 232).
- ▶ Turn the SmartKey to position ② in the ignition lock.

The red warning lamps on the exterior mirrors light up until the engine is started.

## Display in the assistance graphic



When Blind Spot Assist is activated, gray radar waves propagating backwards appear next to the vehicle in the assistance display in the multifunction display (> page 231). Above a speed of 20 mph (30 km/h), the color of the radar waves in the assistance graphic changes to green ①. Blind Spot Assist is then ready for use.

## Towing a trailer

When you attach a trailer, make sure you have correctly established the electrical connection. This can be accomplished by checking the trailer lighting. In this event, Blind Spot Assist is deactivated. The **Blind Spot Assist Not Available When Towing a Trailer** See Operator's Manual message appears in the multifunction display.

## Lane Keeping Assist

### General notes

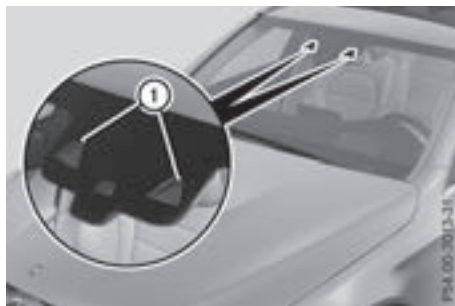

Lane Keeping Assist monitors the area in front of your vehicle by means of multifunction camera ① which is attached behind the top of the windshield. Active Lane Keeping Assist detects lane markings on the road and can warn you before you leave your lane unintentionally.

This function is available in the range between 40 mph and 120 mph (60 km/h and 200 km/h).

A warning may be given if a front wheel passes over a lane marking. It will warn you by means of intermittent vibration in the steering wheel for up to 1.5 seconds.

### Important safety notes

#### WARNING

Lane Keeping Assist cannot always clearly detect lane markings.

In such cases, Lane Keeping Assist can:

- give an unnecessary warning
- not give a warning

There is a risk of an accident.

Always pay particular attention to the traffic situation and keep within the lane, especially if Lane Keeping Assist alerts you.

#### WARNING

The Lane Keeping Assist warning does not return the vehicle to the original lane. There is a risk of an accident.

You should always steer, brake or accelerate yourself, in particular if warned by Lane Keeping Assist.

Lane Keeping Assist can neither reduce the risk of an accident if you fail to adapt your driving style nor override the laws of physics. Lane Keeping Assist cannot take into account the road, traffic and weather conditions. Lane Keeping Assist is merely an aid. You are responsible for the distance to the vehicle in front, for vehicle speed, for braking in good time and for staying in your lane.

The Lane Keeping Assist does not keep the vehicle in the lane.

The system may be impaired or may not function if:

- there is poor visibility, e.g. due to insufficient illumination of the road, or due to snow, rain, fog or spray
- there is glare, e.g. from oncoming traffic, the sun or reflection from other vehicles (e.g. if the road surface is wet)
- the windshield is dirty, fogged up, damaged or covered, for instance by a sticker, in the vicinity of the camera

- there are no, several or unclear lane markings for a lane, e.g. in areas with road construction work
- the lane markings are worn away, dark or covered up, e.g. by dirt or snow
- the distance to the vehicle in front is too small and the lane markings thus cannot be detected
- the lane markings change quickly, e.g. lanes branch off, cross one another or merge
- the road is narrow and winding
- there are highly variable shade conditions on the roadway

### Activating/deactivating Lane Keeping Assist



- **To activate:** press button ②. Indicator lamp ① lights up. The **Lane Keeping Assist On** message appears in the multifunction display. If all conditions have been satisfied, there may be a warning.

If you drive at speeds above 40 mph (60 km/h) and lane markings are detected, the lines in the assistance graphics display (▷ page 231) are shown in green. Lane Keeping Assist is ready for use.

- **To deactivate:** press button ②. Indicator lamp ① goes out. Lane Keeping Assist is deactivated. The **Lane Keeping Assist Off** message appears in the multifunction display.

### Selecting Standard or Adaptive setting

- In the **DriveAssist** menu on the on-board computer, select the **Lane Keeping Assist** function (▷ page 233).
- Select **Standard** or **Adaptive**.

### Standard



When **Standard** is selected, no warning vibration occurs if:

- you switch on the turn signals. In this event, the warnings are suppressed for a certain period of time.
- a driving safety system intervenes, e.g. ABS, BAS or ESP®.

### Adaptive

When **Adaptive** is selected, no warning vibration occurs if:

- you switch on the turn signals. In this event, the warnings are suppressed for a certain period of time.
- a driving safety system intervenes, e.g. ABS, BAS or ESP®.
- you accelerate hard, e.g. kickdown.
- you brake hard.
- you steer actively, e.g. swerve to avoid an obstacle or change lanes quickly.
- you cut the corner on a sharp bend.

In order that you are warned only when necessary and in good time if you cross the lane marking, the system recognizes certain conditions and warns you accordingly.

The warning vibration occurs earlier if:

- you approach the outer lane marking on a bend.
- the road has very wide lanes, e.g. a freeway.
- the system detects solid lane markings.

The warning vibration occurs later if:

- the road has narrow lanes
- you cut the corner on a bend

## Driving Assistance Plus package

### General notes

The Driving Assistance Plus package consists of Distance Pilot DISTRONIC (> page 170), Active Blind Spot Assist (> page 209) and Active Lane Keeping Assist (> page 212).

### Active Blind Spot Assist

#### General notes

Active Blind Spot Assist uses a radar sensor system, pointed toward the rear of the vehicle, to monitor the area to the sides of the vehicle which the driver is unable to see. A warning lamp

lights up in the exterior mirrors and draws your attention to vehicles detected in the monitored area. If you then switch on the corresponding turn signal to change lane, you will also receive an optical and audible warning. If a risk of lateral collision is detected, corrective braking may help you avoid a collision. Before a course-correcting brake application, Active Blind Spot Assist evaluates the space in the direction of travel and at the sides of the vehicle. For this, Active Blind Spot Assist uses the forward-facing radar sensors.

Active Blind Spot Assist supports you from a speed of approximately 20 mph (30 km/h).

### Important safety notes

Active Blind Spot Assist is only an aid and is not a substitute for attentive driving.

#### WARNING

Active Blind Spot Assist does not react to:

- vehicles overtaken too closely on the side, placing them in the blind spot area
- vehicles which approach with a large speed differential and overtake your vehicle

As a result, Active Blind Spot Assist may neither give warnings nor intervene in such situations. There is a risk of an accident.

Always observe the traffic conditions carefully, and maintain a safe lateral distance.

- i** USA only: This device has been approved by the FCC as a "Vehicular Radar System". The radar sensor is intended for use in an automotive radar system only. Removal, tampering, or altering of the device will void any warranties, and is not permitted by the FCC. Do not tamper with, alter, or use in any non-approved way.

Any unauthorized modification to this device could void the user's authority to operate the equipment.

- i** Canada only: This device complies with RSS-210 of Industry Canada. Operation is subject to the following two conditions:
  1. This device may not cause interference, and
  2. This device must accept any interference received, including interference that may cause undesired operation of the device.



Removal, tampering, or altering of the device will void any warranties, and is not permitted. Do not tamper with, alter, or use in any non-approved way.

Any unauthorized modification to this device could void the user's authority to operate the equipment.

### Radar sensors

The Active Blind Spot Assist radar sensors are integrated into the front and rear bumpers and behind a cover in the radiator trim. Make sure that the bumpers and the cover in the radiator grill are free of dirt, ice or slush. The rear sensors must not be covered, for example by cycle racks or overhanging cargo. Following a severe impact or in the event of damage to the bumpers, have the function of the radar sensors checked at a qualified specialist workshop. Active Blind Spot Assist may otherwise no longer work properly.

### Monitoring area

#### WARNING

Active Blind Spot Assist does not detect all traffic situations and road users. There is a risk of an accident.

Always make sure that there is sufficient distance on the side for other traffic or obstacles.

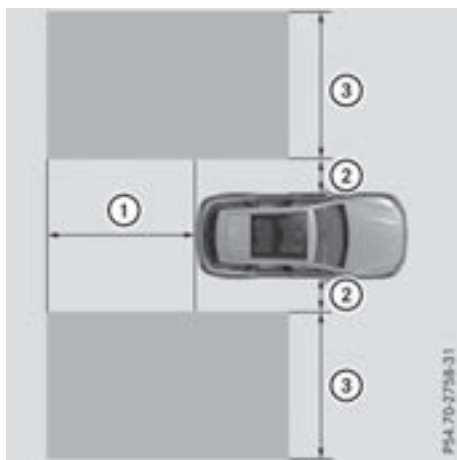

At a distance of approximately 1.6 ft (0.5 m) (2) from the vehicle, Active Blind Spot Assist monitors the area up to 10 ft (3 m) next to (3) and behind (1) your vehicle, as shown in the picture.

The detection of obstacles can be impaired in the case of:

- there is dirt on the sensors or anything else covering the sensors
- poor visibility, e.g. due to rain, snow or spray

Vehicles in the monitoring range are then not indicated.

Active Blind Spot Assist may not detect narrow vehicles, such as motorcycles or bicycles, or may only detect them too late.

If the lanes are narrow, vehicles driving in the lane beyond the lane next to your vehicle may be indicated, especially if the vehicles are not driving in the middle of their lane. This may be the case if there are vehicles at the inner edge of your lane.

Due to the nature of the system:

- warnings may be issued in error when driving close to crash barriers or similar solid lane borders.
- warnings may be interrupted when you are driving alongside particularly long vehicles, such as trucks, for a prolonged time.

### Warning lamp



#### ① Warning lamp

Active Blind Spot Assist is not operational at speeds below approximately 20 mph (30 km/h). Vehicles in the monitoring range are then not indicated.

If a vehicle is detected within the blind spot monitoring range at speeds above 20 mph (30 km/h), warning lamp (1) on the corresponding side lights up red. This warning is always emitted when a vehicle enters the blind spot monitoring range from behind or from the side. When you overtake a vehicle, the warning only occurs if the difference in speed is less than 7 mph (12 km/h).

If you select the reverse gear, Active Blind Spot Assist is not operational.

The brightness of the warning lamps is automatically adapted to the brightness of the surroundings.



When Active Blind Spot Assist is activated, gray radar waves propagating backward appear next to the vehicle in the assistance display in the multifunction display. Above a speed of 20 mph (30 km/h), the color of the radar waves in the assistance display changes to green ②. Active Blind Spot Assist is then ready for use.

### Visual and acoustic collision warning

If you switch on the turn signals to change lanes and a vehicle is detected in the side monitoring range, you receive a visual and acoustic collision warning. You will then hear a double warning tone and red warning lamp ① flashes. If the turn signal remains on, detected vehicles are indicated by the flashing of red warning lamp ①. There are no further warning tones.

### Course-correcting brake application

If Active Blind Spot Assist detects a risk of a lateral collision in the monitoring range, a course-correcting brake application is carried out. This is meant to assist you in avoiding a collision.

#### WARNING

A course-correcting brake application cannot always prevent a collision. There is a risk of an accident.

Always steer, brake or accelerate yourself, especially if Active Blind Spot Assist warns you or makes a course-correcting brake application. Always maintain a safe distance at the sides.

If a course-correcting brake application occurs, red warning lamp ① flashes in the exterior mirror and a double warning tone sounds. In addition, a display underlining the danger of a side collision appears in the multifunction display.

In very rare cases, the system may make an inappropriate brake application. A course-correcting brake application may be interrupted at any time by countersteering slightly or accelerating.

The course-correcting brake application is available in the speed range between 20 mph (30 km/h) and 120 mph (200 km/h).

Either no braking application, or a course-correcting brake application adapted to the driving situation occurs if:

- there are vehicles or obstacles, e.g. crash barriers, located on both sides of your vehicle.
- a vehicle approaches you too closely at the side.
- you have adopted a sporty driving style with high cornering speeds.
- you clearly brake or accelerate.
- a driving safety system intervenes, e.g. ESP® or PRE-SAFE® Brake.
- ESP® is switched off.
- a loss of tire pressure or a defective tire is detected.

### Switching on Active Blind Spot Assist

- ▶ Make sure that Active Blind Spot Assist is activated in the on-board computer (▷ page 232).
- ▶ Switch on the ignition. Warning lamps ① in the exterior mirrors light up red for approximately 1.5 seconds. Gray radar waves propagating backwards appear next to the vehicle in the assistance graphic in the multifunction display ②. Above a speed of 20 mph (30 km/h), the color of the radar waves in the assistance display changes to green ②. Active Blind Spot Assist is then ready for use.

## Active Lane Keeping Assist

### General notes

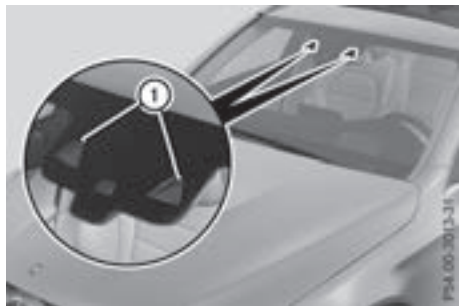

Active Lane Keeping Assist monitors the area in front of your vehicle by means of multifunction camera ① at the top of the windshield. Various different areas to the front, rear and side of your vehicle are also monitored with the aid of the radar sensor system. Active Lane Keeping Assist detects lane markings on the road and can warn you before you leave your lane unintentionally. If you do not react to the warning, a lane-correcting application of the brakes can bring the vehicle back into the original lane.

This function is available in the range between 40 mph and 120 mph (60 km/h and 200 km/h).

### Important safety notes

If you fail to adapt your driving style, Active Lane Keeping Assist can neither reduce the risk of an accident nor override the laws of physics. Active Lane Keeping Assist cannot take account of road and weather conditions. It may not recognize traffic situations. Active Lane Keeping Assist is only an aid. You are responsible for the distance to the vehicle in front, for vehicle speed, for braking in good time and for staying in your lane.

Active Lane Keeping Assist cannot continuously keep your vehicle in its lane.

#### **WARNING**

Active Lane Keeping Assist cannot always clearly detect lane markings.

In such cases, Active Lane Keeping Assist can:

- give an unnecessary warning and then make a course-correcting brake application to the vehicle
- not give a warning or intervene

There is a risk of an accident.

Always pay particular attention to the traffic situation and keep within the lane, especially if Active Lane Keeping Assist alerts you. Terminate the intervention in a non-critical driving situation.

The system may be impaired or may not function if:

- there is poor visibility, e.g. due to insufficient illumination of the road, or due to snow, rain, fog or heavy spray
- there is glare, e.g. from oncoming traffic, the sun or reflection from other vehicles (e.g. if the road surface is wet)
- the windshield is dirty, fogged up, damaged or covered, for instance by a sticker, in the vicinity of the camera
- the radar sensors in the front or rear bumpers or the radiator trim are dirty, e.g. obscured by snow
- there are no or several unclear lane markings for one lane, e.g. roadworks
- the lane markings are worn away, dark or covered up, e.g. by dirt or snow
- the distance to the vehicle in front is too short and thus the lane markings cannot be detected
- the lane markings change quickly, e.g. lanes branch off, cross one another or merge
- the road is narrow and winding
- there are highly variable shade conditions on the roadway

If no vehicle is detected in the adjacent lane and broken lane markings are detected, no lane-correcting brake application is made.

### Warning vibration in the steering wheel

A warning may be given if a front wheel passes over a lane marking. It will warn you by means of intermittent vibration in the steering wheel for up to 1.5 seconds.

## Lane-correcting brake application

If you leave your lane, under certain circumstances the vehicle will brake briefly on one side. This is meant to assist you in bringing the vehicle back to the original lane.

### ⚠ WARNING

A lane-correcting brake application cannot always bring the vehicle back into the original lane. There is a risk of an accident.

Always steer, brake or accelerate yourself, especially if Active Lane Keeping Assist warns you or makes a lane-correcting brake application.



If a lane-correcting brake application occurs, display ① appears in the multifunction display. The brake application also slightly reduces vehicle speed.

A lane-correcting brake application can be made after driving over a lane marking recognized as being solid or broken. Before this, a warning must be given by means of intermittent vibration in the steering wheel. In addition, a lane with lane markings on both sides must have been detected.

In the case of a broken lane marking being detected, a lane-correcting brake application can only be made if a vehicle has been detected in the adjacent lane. Oncoming vehicles, overtaking vehicles and vehicles in adjacent lanes can be detected.

A further lane-correcting brake application can only occur after your vehicle has returned to the original lane.

No lane-correcting brake application occurs if:

- you clearly and actively steer, brake or accelerate.
- you cut the corner on a sharp bend

- you have switched on the turn signal
- a driving safety system intervenes, e.g. ESP®, PRE-SAFE® Brake or Active Blind Spot Assist
- you have adopted a sporty driving style with high cornering speeds or high rates of acceleration
- ESP® is switched off
- the transmission is not in position **D**.
- on vehicles with a trailer tow hitch, the electrical connection to the trailer has been correctly established
- a loss of tire pressure or a defective tire has been detected and displayed.
- an obstacle has been detected in the lane in which you are driving

Active Lane Keeping Assist may not detect other road users or traffic situations. An inappropriate brake application may be interrupted at any time if you:

- steer slightly in the opposite direction
- switch on the turn signal
- you brake or accelerate significantly.

A lane-correcting brake application is interrupted automatically if:

- a driving safety system intervenes, e.g. ESP®, PRE-SAFE® Brake or Active Blind Spot Assist
- lane markings are no longer detected

## Activating/deactivating Active Lane Keeping Assist



► **To activate:** press button ②.

Indicator lamp ① lights up. The **Lane Keeping Assist On** message appears in the multifunction display. If all conditions have been satisfied, a warning or steering intervention may be made.

If you drive at speeds above 40 mph (60 km/h) and lane markings are detected,

the lines on the assistance graphic display are shown in green (▷ page 231). Active Lane Keeping Assist is ready for use.

- ▶ **To deactivate:** press button ②.  
Indicator lamp ① goes out. The Active Lane Keeping Assist is deactivated. The **Lane Keeping Assist Off** message appears in the multifunction display.

### Selecting Standard or Adaptive setting

- ▶ In the **DriveAssist** menu on the on-board computer, select the **Active Lane Keeping Assist** function (▷ page 233).
- ▶ Select setting **Standard** or **Adaptive**.  
When **Standard** is selected, no warning vibration occurs if:
  - you switch on the turn signals. In this event, the warnings are suppressed for a certain period of time
  - a driving safety system intervenes, such as ABS, BAS or ESP®

When **Adaptive** is selected, no warning vibration occurs if:

- you switch on the turn signals. In this event, the warnings are suppressed for a certain period of time.
- a driving safety system intervenes, e.g. ABS, BAS or ESP®
- you accelerate hard, e.g. kickdown.
- you brake hard
- you steer actively, e.g. swerve to avoid an obstacle or change lanes quickly
- you cut the corner on a sharp bend

To ensure that you are warned only when necessary and in good time if you cross the lane markings, the system detects certain conditions and warns you accordingly.

The warning vibration occurs earlier if:

- you approach the outer lane marking on a bend
- the road has very wide lanes, e.g. a freeway
- the system detects solid lane markings

The warning vibration occurs later if:

- the road has narrow lanes
- you cut the corner on a bend

### Towing a trailer

When you attach a trailer, make sure you have correctly established the electrical connection.

This can be accomplished by checking the trailer lighting.

## Towing a trailer

### Important safety notes

#### WARNING

Installing an unsuitable ball coupling may result in overloading of the trailer tow hitch and the rear axle. This applies especially if the ball coupling in question is longer or angled differently. This could seriously impair the driving characteristics and the trailer can come loose. There is a risk of an accident.

You should only ever install a ball coupling that has the permissible dimensions and that is designed to meet your trailer-towing requirements. Do not modify the ball coupling or the trailer tow hitch.

You will find the values approved by the manufacturer on the vehicle identification plates and those for the towing vehicle under "Technical data" (▷ page 384).

#### WARNING

When the vehicle/trailer combination begins to lurch, you could lose control of it. The vehicle/trailer combination could even rollover. There is a risk of an accident.

On no account should you attempt to straighten up the vehicle/trailer combination by increasing the speed. Reduce vehicle speed and do not countersteer. Apply the brake as necessary.

 If you have a trailer tow hitch retrofitted, changes to the engine cooling system may be necessary, depending on the vehicle type.

If you have a trailer tow hitch retrofitted, observe the anchorage points on the chassis frame.

The installation of a trailer tow hitch is only permissible if a towing weight is specified in your vehicle documents. If this is not the case, then the vehicle is not approved for the towing of a trailer.

For more information, please contact a qualified specialist workshop.

Please observe the manufacturer's operating instructions for the trailer coupling if a detachable trailer coupling is used.

Couple and uncouple the trailer carefully. If you do not couple the trailer to the towing vehicle correctly, the trailer could become detached.

Make sure that the following values are not exceeded:

- the permissible trailer drawbar noseweight
- the permissible trailer load
- the permissible rear axle load of the towing vehicle
- the maximum permissible gross vehicle weight of both the towing vehicle and the trailer

The applicable permissible values, which must not be exceeded, can be found:

- in the vehicle documents
- on the type plate for the trailer
- on the vehicle identification plate

If the values differ, the lowest value applies.

When towing a trailer, your vehicle's handling characteristics will be different in comparison with when driving without a trailer.

The vehicle/trailer combination:

- is heavier
- is restricted in its acceleration and gradient-climbing capability
- has an increased braking distance
- is affected more by strong crosswinds
- demands more sensitive steering
- has a larger turning circle

This could impair the handling characteristics.

When towing a trailer, always adjust your speed to the current road and weather conditions. Do not exceed the maximum permissible speed for your vehicle/trailer combination.

## Notes on towing a trailer

### General notes

- Do not exceed the maximum permissible speed for vehicle/trailer combinations in the relevant country.

This lowers the risk of an accident.

- Only install an approved trailer coupling on your vehicle.

Further information on availability and on installation is available from any authorized Mercedes-Benz Center.

- The bumpers of your vehicle are not suitable for installing detachable trailer couplings.
- Do not install hired trailer couplings or other detachable trailer couplings on the bumpers of your vehicle.
- If you no longer need the ball coupling, remove it from the ball coupling recess. This will reduce the risk of damage to the ball coupling.

When towing a trailer, set the tire pressure on the rear axle of the towing vehicle for a maximum load; see the tire pressure table in the fuel filler flap (▷ page 367).

Please note that when towing a trailer, the following driving systems have limited availability or are not available at all:

- PARKTRONIC (▷ page 191)
- Blind Spot Assist (▷ page 205)
- Active Lane Keeping Assist (▷ page 212)

On vehicles without level control, the height of the ball coupling will alter according to the load placed on the vehicle. If necessary, use a trailer with a height-adjustable drawbar.

You will find permissible trailer loads under "Technical data" (▷ page 384).

### Driving tips

Observe the information on ESP® trailer stabilization (▷ page 72) and on pulling away with a trailer (▷ page 140).

The maximum permissible speed for vehicle/trailer combinations depends on the type of trailer. Before beginning the journey, check the trailer's documents to see what the maximum permitted speed is. Observe the maximum permissible speed in the relevant country.

For certain Mercedes-Benz vehicles, the maximum permissible rear axle load is increased when towing a trailer. See the "Technical data" section to find out whether this applies to your vehicle (▷ page 384). In the event of increased rear axle load, the vehicle/trailer combination may not exceed a maximum speed of 60 mph (100 km/h) for reasons concerning the operating permit. This also applies in countries in



which the maximum permissible speed for vehicle/trailer combinations is above 60 mph (100 km/h).

When towing a trailer, your vehicle's handling characteristics will be different in comparison to when driving without a trailer and it will consume more fuel.

Shift to a lower gear on long and steep downhill gradients.

This also applies to:

- activated DISTRONIC PLUS
- activated cruise control

This will use the braking effect of the engine, so that less braking will be required to maintain the speed. This relieves the load on the brake system and prevents the brakes from overheating and wearing too quickly. If you need additional braking, depress the brake pedal repeatedly rather than continuously.

## Driving tips

If the trailer swings from side to side:

- ▶ Do not accelerate.
- ▶ Do not counter-steer.
- ▶ Brake if necessary.
- Maintain a greater distance from the vehicle in front than when driving without a trailer.
- Avoid braking abruptly. If possible, brake gently at first to allow the trailer to run on. Then, increase the braking force rapidly.
- The values given for gradient-climbing capabilities from a standstill refer to sea level. When driving in mountainous areas, note that the power output of the engine and, consequently, the vehicle's gradient-climbing capability, decreases with increasing altitude.

## Installing the ball coupling

### WARNING

If the ball coupling is not correctly installed and secured, it could come loose while driving and endanger other road users. There is a risk of an accident and injury.

Install and secure the ball coupling as described in the ball coupling manufacturer's installation instructions. Make sure that the ball

coupling is correctly installed and secured before every journey.

### WARNING

If the ball coupling is not installed and secured correctly the trailer may come loose. There is a risk of an accident.

Install and secure the ball coupling as described in the ball coupling installation instructions. Make sure that the ball coupling is installed and secured correctly before every journey.

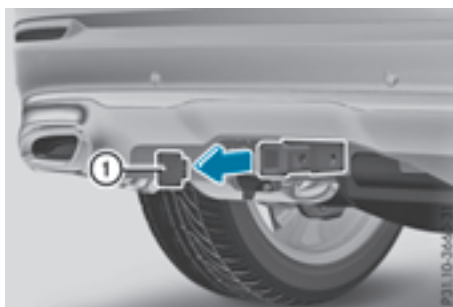

- ▶ Pull protective cap ① in the direction of the arrow, out of the ball coupling recess.
  - ▶ Stow protective cap ① so that it cannot be thrown around.
  - ▶ Observe the manufacturer's installation instructions.
- Observe the loading guidelines (▷ page 290) and the safety notes regarding stowage spaces (▷ page 290).

## Coupling up a trailer

- ⚠ Do not connect the trailer's brake system (if featured) to the hydraulic brake system of the towing vehicle, as the latter is equipped with an anti-lock brake system. Doing so will result in a loss of function of the brake systems of both the vehicle and the trailer.
- ▶ Apply the vehicle's electric parking brake manually.
- ▶ Start the engine.
- ▶ Shift the transmission to position **P**.
- ▶ **Vehicles with AIR BODY CONTROL:** select the **Comfort** drive program.



- ▶ Switch off the engine.
- ▶ Close the doors and tailgate.
- ▶ Couple up the trailer.
- ▶ Establish the electrical connection between the vehicle and the trailer.
- ▶ Check that the trailer lighting system is working.
- ▶ Push the combination switch upwards/downwards and check whether the corresponding turn signal on the trailer flashes.

A trailer that is connected is recognized only when the electrical connection is established correctly and when the lighting system is working properly. The function of other systems also depends on this, for example:

- ESP®
- PARKTRONIC
- Active Parking Assist
- Active Blind Spot Assist
- Active Lane Keeping Assist

Vehicles with AIR BODY CONTROL: if you couple up a trailer, the vehicle always remains at highway level. Observe the following note when coupling up a trailer:

- Unless highway level has been set manually, the vehicle is automatically lowered to highway level. If a speed of 5 mph (8 km/h) has been reached, this may be the case.

These restrictions apply to accessories that are supplied with power via the trailer socket in your vehicle, e.g. a rear bicycle rack.

Observe the maximum permissible trailer dimensions (width and length).

Most U.S. states and all Canadian provinces require by law:

- Safety chains between the towing vehicle and the trailer. The chains should be cross-wound under the trailer drawbar. They must be fastened to the vehicle's trailer coupling, not to the bumper or the axle.

Leave enough play in the chains to make tight cornering possible.

- A separate brake system for certain types of trailer.
- Safety switch for braked trailers. Check the specific legal requirements applicable to your state.

If the trailer becomes detached from the towing vehicle, the safety feature applies the trailer brakes.

## Towing a trailer

There are several legal requirements for towing a trailer, e.g. the maximum permissible speed. Make sure that your car/trailer combination complies with the local regulations:

- in your place of residence
- at your destination

The police and local authorities can provide reliable information.

To accumulate driving experience and accustom yourself to the new handling characteristics, practice the following at a location where there is no traffic:

- Cornering
- Stopping
- Backing up

Check the following before the journey:

- Trailer tow hitch
- Safety switch for braked trailers
- Safety chains
- Electrical connections
- Lighting system
- Wheels and tires
- Load securing

Adjust the exterior mirrors so that you have a clear view of the rear section of the trailer.

If the trailer is equipped with electronically controlled brakes, pull away carefully in the car/trailer combination. Brake manually using the brake controller and check whether the brakes function correctly.

Regularly check that the load is secure.

When towing a trailer, your vehicle's handling characteristics will be different in comparison with when driving without a trailer.

The vehicle/trailer combination:

- is heavier
- is restricted in its acceleration and gradient-climbing capability
- has an increased braking distance
- is affected more by strong crosswinds
- demands more sensitive steering
- has a larger turning circle

Avoid sudden steering movements.

Avoid braking abruptly. If possible, brake gently at first to allow the trailer to run on. Then, increase the braking force rapidly.

When overtaking, pay particular attention to the extended length of your vehicle/trailer combination.

Due to the length of the vehicle/trailer combination, you require additional road space when overtaking before you can change back to the original lane.

If the automatic transmission repeatedly shifts between gears on uphill or downhill gradients, shift to a lower gear.

Driving in a lower gear and at a reduced speed decreases the risk of engine damage.

If the coolant temperature increases significantly when climate control is switched on, switch climate control off.

Coolant heat can also be dissipated by opening the windows and switching the ventilation blower and the interior temperature to the highest level.

### Decoupling a trailer

#### WARNING

If you uncouple a trailer with the overrun brake engaged, you could trap your hand between the vehicle and the trailer drawbar. There is a risk of injury.

Do not uncouple a trailer if the overrun brake is engaged.

#### WARNING

Vehicles with level control:

The vehicle is lowered as soon as you disconnect the trailer cable. This could result in your limbs or those of other people that are between the vehicle body and tires or underneath the vehicle being trapped. There is a risk of injury.

Make sure that nobody is in the immediate vicinity of the wheel housings or under the vehicle when you disconnect the trailer cable.

 Do not disconnect a trailer with an engaged overrun brake. Otherwise, your vehicle could be damaged by the rebounding of the overrun brake.

- ▶ Apply the vehicle's parking brake manually.
- ▶ Shift the transmission to position **P**.

- ▶ Close all doors and the tailgate.
- ▶ Switch off the engine.
- ▶ Secure the vehicle and trailer against rolling away.
- ▶ Remove the trailer cable.
- ▶ Remove the safety chains, if there are any.
- ▶ Uncouple the trailer.

### Removing the ball coupling

- ▶ Observe the manufacturer's installation instructions.
- ▶ Press the protective cap into the ball coupling recess.
- ▶ Make sure that the protective cap is firmly in place.

Observe the loading guidelines (> page 290) and the safety notes regarding stowage spaces (> page 290).

Information on cleaning and care of the trailer tow hitch (> page 329).

### Trailer power supply

 Accessories with a maximum power consumption of 180 W can be connected to the permanent power supply.

You must not charge a trailer battery using the power supply.

The trailer socket of your vehicle is equipped at the factory with a permanent power supply.

The permanent power supply is supplied via trailer socket pin 4.

The trailer's permanent power supply is switched off in the event of low vehicle supply voltage and after six hours at the latest.

A qualified specialist workshop can provide more information about installing the trailer electrics.

### Permissible trailer loads and trailer drawbar noseweights

#### Weight specifications

The gross trailer weight is calculated as the weight of the trailer plus the weight of the load and the trailer's equipment.

You will find permissible trailer loads under "Technical data" (> page 384).

### Loading a trailer

---

- When loading the trailer, make sure that neither the permissible gross trailer weight nor the permissible gross vehicle weight are exceeded. The permissible gross vehicle weight is indicated on the identification plate on the B-pillar on the driver's side of the vehicle.

You can find the maximum permissible values on the type plates of your vehicle and the trailer. When calculating how much weight the vehicle and trailer may carry, pay attention to the respective lowest values.

- The trailer drawbar load on the ball coupling must be added to the rear axle load to avoid exceeding the permissible gross axle weight. The permissible gross vehicle weight is indicated on the identification plate on the B-pillar on the driver's side of the vehicle.

Mercedes-Benz recommends a trailer load where the trailer drawbar noseweight accounts for 8% to 15% of the permissible gross trailer weight.

Additional accessories, passengers and load reduce the permissible trailer load and nose-weight that your vehicle can tow.

### Checking the vehicle and trailer weight

---

- Have the towing vehicle, including the driver, passengers and load, and completely loaded trailer weighed on a suitable weighing machine. This will allow you to ensure that the weights of the towing vehicle and trailer comply with the maximum permissible values.
- Check the gross axle weight rating of the front and rear axles, the gross weight of the trailer and trailer drawbar load.

## Important safety notes

### WARNING

If you operate information systems and communication equipment integrated in the vehicle when driving, you may be distracted from the traffic situation. You could also lose control of the vehicle. There is a risk of an accident.

Only operate this equipment when the traffic situation permits. If you are not sure that this is possible, park the vehicle paying attention to traffic conditions and operate the equipment when the vehicle is stationary.

You must observe the legal requirements for the country in which you are currently driving when operating the on-board computer.

### WARNING

If the instrument cluster has failed or malfunctioned, you may not recognize function restrictions in systems relevant to safety. The operating safety of your vehicle may be impaired. There is a risk of an accident.

Drive on carefully. Have the vehicle checked at a qualified specialist workshop immediately.

If the operating safety of your vehicle is impaired, pull over as soon as it is safe to do so. Contact a qualified specialist workshop.

The on-board computer only shows messages or warnings from certain systems in the multifunction display. You should therefore make sure your vehicle is operating safely at all times.

For an overview, see the instrument panel illustration (> page 37).



**Hybrid vehicles:** make sure that you read the separate operating instructions. Otherwise, you may not recognize dangers.

## Displays and operation

### Instrument cluster lighting



The lighting in the instrument cluster, in the displays and the controls in the vehicle interior can be adjusted using brightness control knob ①.

► Turn brightness control knob ① up or down. If you turn the light switch (> page 112) to the , **AUTO** or  position, the brightness will depend upon the brightness of the ambient light.

**i** The light sensor in the instrument cluster automatically controls the brightness of the multifunction display.

In daylight, the displays in the instrument cluster are illuminated. A dimming function is not possible in daylight.

### Speedometer with segments

The speedometer is divided into segments depending on the equipment.

The segments in the speedometer indicate which speed range is available.

- Cruise control activated (> page 169):  
The segments light up from the stored speed to the end of the scale.
- Distance Pilot DISTRONIC is activated (> page 172):  
One or two segments in the set speed range light up.
- Distance Pilot DISTRONIC detects a vehicle in front moving more slowly than the stored speed:  
The segments between the speed of the vehicle in front and the stored speed light up.

## Tachometer

**!** Do not drive in the overrevving range, as this could damage the engine.

The red band in the tachometer indicates the engine's overrevving range.

The fuel supply is interrupted to protect the engine when the red band is reached.

## Outside temperature display

You should pay special attention to road conditions when temperatures are around freezing point.

Bear in mind that the outside temperature display indicates the temperature measured and does not record the road temperature.

The outside temperature display is in the multi-function display (▷ page 222).

Changes in the outside temperature are displayed after a short delay.

## Coolant temperature gage

### WARNING

Opening the hood when the engine is overheated or when there is a fire in the engine compartment could expose you to hot gases or other service products. There is a risk of injury.

Let an overheated engine cool down before opening the hood. If there is a fire in the engine compartment, keep the hood closed and contact the fire department.

**!** If the coolant temperature is too high, a display message is shown.

If the coolant temperature display is in the area marked in red, do not continue driving. Otherwise, the engine will be damaged.

The coolant temperature gauge is in the lower section of the tachometer (▷ page 37).

Under normal operating conditions and at the correct coolant level, the display may rise to the red mark.

## Operating the on-board computer



- ① Multifunction display
- ② Right control panel
- ③ Left control panel

► **To activate the on-board computer:** switch on the power supply.

You can control the multifunction display and the settings in the on-board computer using the buttons on the multifunction steering wheel.

### Left control panel



- Opens a menu list



#### Press briefly:

- Scrolls in lists
- Selects a menu or function
- In the **Radio** or **Media** menu: opens a track or station list and selects a station, an audio track or a video scene.
- In the **Telephone** menu: switches to the phone book and selects a name or a telephone number







#### Press and hold:

- Scrolls quickly through all lists
- In the **Radio** or **Media** menu: selects a station, audio track or video scene using rapid scrolling
- In the **Telephone** menu: starts rapid scrolling if the phone book is open

OK	<ul style="list-style-type: none"> <li>In all menus: confirms the selected entry in the list</li> <li>In the <b>Radio</b> or <b>Media</b> menu: opens the list of available radio sources or media</li> <li>In the <b>Telephone</b> menu: switches to the phone book and starts dialing the selected number</li> </ul>
OFF / ON	<ul style="list-style-type: none"> <li>Vehicles with multimedia system Audio 20: switches off voice-operated control for navigation (see the manufacturer's operating instructions)</li> <li>Vehicles with multimedia system COMAND: switches off the Voice Control System (see the separate Operator's Manual)</li> </ul>
←	<p><b>Press briefly:</b></p> <ul style="list-style-type: none"> <li>Back</li> <li>In the <b>Radio</b> or <b>Media</b> menu: exits the track or station list or list of available radio sources or media</li> <li>Hides display messages</li> <li>Exits the phone book/redial memory</li> </ul>
←	<p><b>Press and hold:</b></p> <ul style="list-style-type: none"> <li>Calls up the standard display in the <b>Trip</b> menu</li> </ul>

### Right control panel

	<ul style="list-style-type: none"> <li>Rejects or ends a call</li> <li>Exits the phone book/redial memory</li> </ul>
	<ul style="list-style-type: none"> <li>Makes or accepts a call</li> <li>Switches to the redial memory</li> </ul>
+ -	<ul style="list-style-type: none"> <li>Adjusts the volume</li> </ul>

	<ul style="list-style-type: none"> <li>Mute</li> </ul>
	<ul style="list-style-type: none"> <li>Vehicles with multimedia system Audio 20: Switches on voice-operated control for navigation (see the manufacturer's operating instructions)</li> <li>Vehicles with multimedia system COMAND: Switches on the Voice Control System (see the separate Operator's Manual)</li> </ul>

### Multifunction display



- ① Drive program (▷ page 148)
- ② Transmission position (▷ page 148)
- ③ Additional speedometer
- ④ Display
- ⑤ Time
- ⑥ Outside temperature (▷ page 221)





Display panel ④ shows the selected menu or submenu and display messages.

► **To open the menu list:** press  on the steering wheel.

Display panel ④ appears in the menu list.

### Possible displays in the multifunction display:

- ↑ Gearshift recommendation, when shifting manually (▷ page 154)
- P Parking Pilot (▷ page 188)
-  Cruise control (▷ page 169)

-  Distance Pilot DISTRONIC Steering Pilot (▷ page 177)
- **DSR** Downhill Speed Regulation (▷ page 180)
-  Adaptive Highbeam Assist (▷ page 114)
-  ECO start/stop function (▷ page 141)
-  HOLD function (▷ page 178)

## Head-up display

### General notes

The head-up display projects information from the navigation system and the driver assistance system above the dashboard into the driver's field of vision. The head-up display allows the driver to see all of the information without having to take their eyes off the road.

A requirement for the display of the contents is that the following functions are available in the vehicle and are switched on:

- Cruise control
- Distance Pilot DISTRONIC
- Traffic Sign Assist
- Navigation

### Important safety notes

The head-up display is only an aid and is not a substitute for attentive driving.

Speed limits and overtaking restrictions are not always correctly displayed. Traffic signs always have priority over the Traffic Sign Assist display.

The visibility of the head-up display is influenced by the following conditions:

- the driver's seat position
- the positioning of the display image
- the general ambient light
- sunglasses with polarization filters
- wet roads
- blocking of sunlight by objects on the display cover

In the event of extreme sunlight, sections of the display may fade. This can be reversed by switching the head-up display off and on again.

- **i** Vehicles with the head-up display are equipped with a special windshield. Should repairs

be necessary, have the windshield replaced at a qualified specialist workshop.

## Displays and operation

### Switching the head-up display on/off



- ▶ Press button ①.  
When the head-up display is switched on, the display appears in the driver's field of vision.

### Standard displays in the head-up display



- ① Navigation messages
- ② Current speed
- ③ Detected traffic signs
- ④ Set speed for cruise control or Distance Pilot DISTRONIC



## AMG displays in the head-up display



- ① Protection against reaching the overrevving range
- ② RACE TIMER lap
- ③ RACE TIMER lap time
- ④ Current speed
- ⑤ Currently selected gear, gearshift options when shifting manually
- ⑥ Current engine speed

### Setting options

You can adjust the following settings in the head-up display submenu:

- adjust the position of the head-up display on the windshield (▷ page 234)
- adjust the brightness of the displays in the head-up display (▷ page 234)
- select desired displays in the head-up display (▷ page 233)

Using the **Display Content** function, you can, depending on your vehicle's equipment, choose between four standard displays. The selected contents then appear in the head-up display.

In Mercedes-AMG vehicles, you can choose between further AMG displays in addition to the standard displays, depending on your vehicle's equipment.

If you select a display with traffic signs, detected traffic signs from Traffic Sign Assist appear in the head-up display.

## Menus and submenus

### Menu overview

Press the  button on the steering wheel to open the menu list.

Operating the on-board computer (▷ page 221).

Depending on the vehicle equipment, you can select the following menu:

- **Trip** menu (▷ page 224)
- **Navi** menu (navigation instructions) (▷ page 226)
- **Radio** menu (▷ page 228)
- **Media** menu (▷ page 228)
- **Telephone** menu (▷ page 230)
- **Assistance Graphic** menu (▷ page 231)
- **Service** menu (▷ page 231)
- **Settings** menu (▷ page 231)
- **AMG** menu in Mercedes-AMG vehicles (▷ page 235)

### Trip menu

#### Standard display



- ▶ Press and hold the  button on the steering wheel until the **Trip** menu with trip odometer ① and odometer ② appears.

## Displaying the range and current fuel consumption

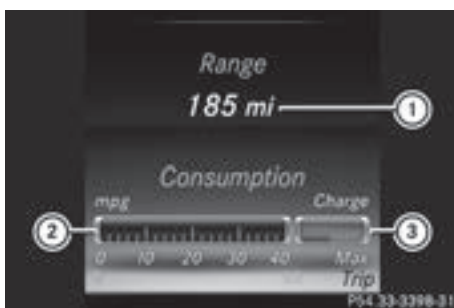

- ① Range of the fuel supply
- ② Current fuel consumption
- ③ Recuperation display

- ▶ Press the button on the steering wheel to open the menu list.
- ▶ Press or on the steering wheel to select the **Trip** menu.
- ▶ Confirm by pressing on the steering wheel.
- ▶ Press or to select the display. Approximate range ① that can be covered is calculated according to your current driving style and the amount of fuel in the tank. If there is only a small amount of fuel left in the fuel tank, a vehicle being refueled appears instead of approximate range ①. Recuperation display ③ shows you if energy has been recuperated from the kinetic energy in overrun mode and saved in the battery. Recuperation display ③ depends on the engine installed and is therefore not available in all vehicles.

## ECO display

- ▶ Press on the steering wheel to open the menu list.
- ▶ Press or on the steering wheel to select the **Trip** menu.
- ▶ Confirm by pressing on the steering wheel.
- ▶ Press the or button to select ECO display.

If the ignition remains switched off for longer than four hours, the ECO display will be automatically reset.

For further information on the ECO display, see (▷ page 161).

## Trip computer "From Start" or "From Reset"



- ① Distance
- ② Driving time
- ③ Average speed
- ④ Average fuel consumption

- ▶ Press the button on the steering wheel to open the menu list.
- ▶ Press or on the steering wheel to select the **Trip** menu.
- ▶ Confirm by pressing on the steering wheel.
- ▶ Press or to select **From Start** or **From Reset**.

The values in the **From Start** submenu are calculated from the start of a journey, while the values in the **From Reset** submenu are calculated from the last time the submenu was reset (▷ page 226).

The trip computer is automatically reset in the following cases **From Start**:

- the ignition has been switched off for more than four hours.
- 999 hours have been exceeded.
- 9,999 miles have been exceeded.

When 9999 hours or 99,999 miles have been exceeded, the trip computer is automatically reset **From Reset**.

## Digital speedometer

- ▶ Press on the steering wheel to open the menu list.
- ▶ Press or on the steering wheel to select the **Trip** menu.

- ▶ Confirm by pressing **[OK]** on the steering wheel.
- ▶ Press the **[▼]** or **[▲]** button to select the digital speedometer.

### Resetting values

- ▶ Press the **[Home]** button on the steering wheel to open the menu list.
- ▶ Press **[▼]** or **[▲]** on the steering wheel to select the **Trip** menu.
- ▶ Confirm by pressing **[OK]** on the steering wheel.
- ▶ Press the **[▼]** or **[▲]** button to select the function that you wish to reset.
- ▶ Press **[OK]** briefly.
- ▶ Press **[▼]** to select **Yes** and press **[OK]** to confirm.

You can reset the values of the following functions:

- Trip odometer
- "From Start" trip computer
- "From Reset" trip computer
- ECO display

If you reset the values in the ECO display, the values in the "From Start" trip computer are also reset. If you reset the values in the "From Start" trip computer, the values in the ECO display are also reset.

## Navigation system menu

### Displaying navigation instructions

In the **Navi** menu, the multifunction display shows navigation instructions. You can find further information on navigation instructions in the multimedia system in the Digital Operator's Manual.

- ▶ Switch on the multimedia system.
- ▶ Press the **[Home]** button on the steering wheel to open the menu list.
- ▶ Press **[▼]** or **[▲]** on the steering wheel to select the **Navi** menu.
- ▶ Confirm by pressing **[OK]** on the steering wheel.

### Route guidance not active

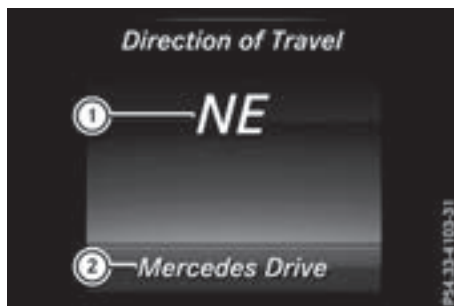

- ① Direction of travel
- ② Current road

### Route guidance active

#### No change of direction announced



- ① Distance to the next destination
- ② Estimated arrival time
- ③ Distance to the next change of direction
- ④ Current road

### Change of direction announced with a lane recommendation



- ① Target of the change of direction
- ② Distance to the change of direction
- ③ Change-of-direction symbol
- ④ Recommended lane and new lane during a change of direction (white)
- ⑤ Possible lane
- ⑥ Lane not recommended (dark gray)

On multilane roads, new lane recommendations can be displayed for the next change of direction if the digital map supports this data. During the change of direction, new lanes may be added.

Lane not recommended ⑥: you will not be able to complete the next change of direction if you stay in this lane.

Possible lane ⑤: you will only be able to complete the next change of direction in this lane.

Recommended lane ④: in this lane you will be able to complete the next change of direction and the one after that.

### Change of direction without lane recommendation

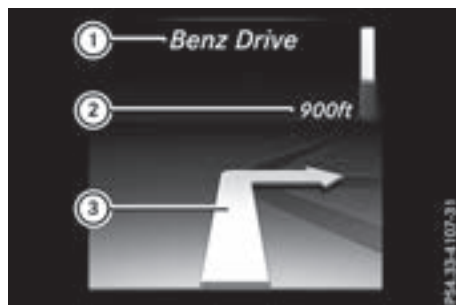

- ① Road into which the change of direction leads
- ② Distance to change of direction and visual distance display
- ③ Change-of-direction symbol

When a change of direction is to be made, you will see symbol ③ for the change of direction and distance graphic ②. The distance indicator shortens towards the top of the display as you approach the point of the announced change of direction. The change of direction starts once the distance display reaches zero.

### Change of direction with lane recommendation

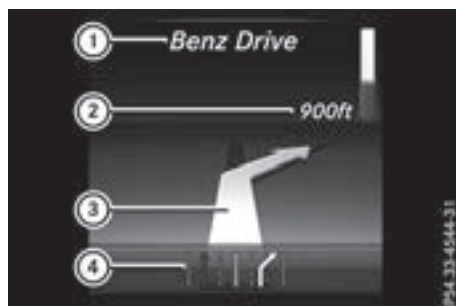

- ① Road into which the change of direction leads
- ② Distance to change of direction and visual distance display
- ③ Change-of-direction symbol
- ④ Lane recommendation

## Other status indicators of the navigation system



- ① Additional information

Other possible additional information:

- **New Route...** or **Calculating Route...**

A new route is calculated.

- **Road Not Mapped**

The vehicle position is inside the area of the digital map but the road is not recognized, e.g. newly built streets, car parks or private land.

- **No Route**

No route could be calculated to the selected destination.

- **Off Map**

The map for the current vehicle position is not available.

- 

You have reached the destination or an intermediate destination.

## Radio menu







- ① Waveband  
② Station frequency with memory position

- ③ Name of artist



- ④ Name of track

The multifunction display shows station ② with station frequency or station name. The preset position is only displayed along with station ② if this has been stored. You can store radio stations in the multimedia system.



- ▶ Switch on the multimedia system.
  - ▶ Press the  button on the steering wheel to open the menu list.
  - ▶ Press  or  on the steering wheel to select the **Radio** menu.
  - ▶ Confirm by pressing  on the steering wheel.
- Currently set station ② appears in the multifunction display.

- ▶ **To open the channel list:** press the  or  button briefly.

- ▶ **To select a station in the station list:** press the  or  button briefly.

- ▶ **To select a station in the station list using rapid scrolling:** press and hold the  or  button.

- ▶ **To select the waveband or station memory:** press  briefly.

- ▶ Press  or  to select the waveband or station memory.

- ▶ Press  to confirm the selection.



- ▶  SIRIUS XM satellite radio functions like a normal radio.

Further information about radio operation can be found in the multimedia system in the Digital Operator's Manual.

## Media menu

### Changing the media source

You can change the media source and playback mode (audio or video) at any time in the **Media** menu.

- ▶ Switch on the multimedia system.
- ▶ Press the  button on the steering wheel to open the menu list.
- ▶ Press  or  on the steering wheel to select the **Media** menu.

- ▶ Confirm by pressing **[OK]** on the steering wheel.
- ▶ **To open the media sources list:** press **[OK]** briefly.  
The list shows the following media sources, for example:
  - CD or DVD (DVD only in the COMAND multimedia system)
  - SD card
  - Media Register (only in the COMAND multimedia system)
  - USB storage device
  - Bluetooth® capable audio device

Please observe further information on media support and media operation in the multimedia system (see the Digital Operator's Manual).

### Operating an audio player or audio media



- ① Media source, e.g. name of USB memory stick
- ② Current title
- ③ Name of artist
- ④ Name of album
- ⑤ Folder name

Audio data from various audio devices or media can be played, depending on the equipment installed in the vehicle.

- ▶ Switch on the multimedia system.
- ▶ Press the **[Home]** button on the steering wheel to open the menu list.
- ▶ Press **[▼]** or **[▲]** on the steering wheel to select the **Media** menu.
- ▶ Confirm by pressing **[OK]** on the steering wheel.

- ▶ **To select an audio player or audio media:** press **[OK]** briefly. The list containing the media sources appears.
- ▶ Press **[▼]** or **[▲]** to select the corresponding audio player or media.
- ▶ Press **[OK]** to confirm.
- ▶ **To open the track list:** press the **[▼]** or **[▲]** button briefly.
- ▶ **To select the next or previous track from the track list:** press the **[▼]** or **[▲]** button briefly.
- ▶ **To select a track from the track list using rapid scrolling:** press and hold **[▼]** or **[▲]** until the desired track is reached.

If you press and hold the button, the speed of rapid scroll increases after a short time. Not all audio drives or data carriers support this function.

If the corresponding track information is stored on the audio player or media, the multifunction display shows the following:











- track number
- the name of the track
- the name of the artist
- album

The track information does not appear in audio AUX mode (**Auxiliary audio mode: external audio source connected**).

### Video DVD operation



- ▶ Switch on the multimedia system.
- ▶ Press the **[Home]** button on the steering wheel to open the menu list.
- ▶ Press **[▼]** or **[▲]** on the steering wheel to select the **Media** menu.
- ▶ Confirm by pressing **[OK]** on the steering wheel.

- ▶ **To select a DVD drive or DVD media:** press  briefly. The list containing the media sources appears.
- ▶ Press  or  to select the corresponding DVD single drive or disc.
- ▶ Press  to confirm.
- ▶ **To open the scene list:** press the  or  button briefly.
- ▶ **To select the next or previous scene in the scene list:** press the  or  button briefly.
- ▶ **To select a scene from the scene list using rapid scrolling:** press and hold  or  until desired scene ① is reached.
- ▶ Press  to confirm your selection.

## Telephone menu





### Introduction

#### WARNING

If you operate information systems and communication equipment integrated in the vehicle when driving, you may be distracted from the traffic situation. You could also lose control of the vehicle. There is a risk of an accident.

Only operate this equipment when the traffic situation permits. If you are not sure that this is possible, park the vehicle paying attention to traffic conditions and operate the equipment when the vehicle is stationary.

When telephoning, you must observe the legal requirements for the country in which you are currently driving.

- ▶ Switch on the mobile phone (see the manufacturer's operating instructions).
- ▶ Switch on the multimedia system.
- ▶ Establish a Bluetooth® connection to the multimedia system (see the Digital Operator's Manual).
- ▶ Press the  button on the steering wheel to open the menu list.
- ▶ Press  or  on the steering wheel to select the **Telephone** menu.
- ▶ Confirm by pressing  on the steering wheel.

You will see one of the following display messages in the multifunction display:

- **Phone READY** or the name of the network provider: the mobile phone has found a network and is ready to receive.
- **Phone No Service:** there is no network available or the mobile phone is searching for a network.

### Accepting a call

If someone calls you when you are in the **Telephone** menu, a display message appears in the multifunction display.









You can accept a call at any time regardless of the menu selected.

- ▶ Press the  button on the steering wheel to accept an incoming call.



### Rejecting or ending a call



- ▶ Press the  button on the steering wheel to reject or end a call.

### Selecting an entry in the phone book

- ▶ Press the  button on the steering wheel to open the menu list.
- ▶ Press the  or  button on the steering wheel to select the **Telephone** menu.
- ▶ Confirm by pressing  on the steering wheel.
- ▶ Press the  or  or  button to switch to the phone book.
- ▶ Press the  or  button to select the names one after the other.

or

- ▶ **To start rapid scrolling:** press and hold  or  for longer than one second. The names are displayed quickly one after the other in the phone book.









If you press and hold the  or  button for longer than five seconds, the name with the next or previous initial letter in the alphabet appears.

Rapid scrolling stops when you release the button or reach the end of the list.

- ▶ **If only one telephone number is stored for a name:** press the  or  button to start dialing.











or



- ▶ **If there is more than one number for a particular name:** press the  or  button to display the numbers.
- ▶ Press the  or  button to select the number you want to dial.
- ▶ Press the  or  button to start dialing.
- ▶ **To exit the telephone book:** press the  or  button briefly.



## Redialing

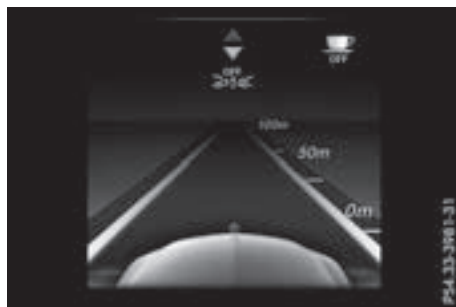

The on-board computer saves the last names or numbers dialed in the redial memory.

- ▶ Press the  button on the steering wheel to open the menu list.
- ▶ Press the  or  button on the steering wheel to select the **Telephone** menu.
- ▶ Confirm by pressing  on the steering wheel.
- ▶ Press the  button to switch to the redial memory.
- ▶ Press the  or  button to select the desired name or number.
- ▶ Press the  or  button to start dialing.
- ▶ **To exit the redial memory:** press the  or  button briefly.

## Assistance graphic menu



- ▶ Press the  button on the steering wheel to open the menu list.
- ▶ Press the  or  button on the steering wheel to select the **Assistance Graphic** menu.

- ▶ Confirm by pressing  on the steering wheel.  
The assistance graphic displays the status of and information from the following driving systems or driving safety systems:
  - Distance Pilot DISTRONIC distance display (▷ page 175)
  - Traffic Sign Assist (▷ page 205)
  - Distance warning function and autonomous brake function of Active Brake Assist (▷ page 67)
  - Active Brake Assist with cross-traffic function (▷ page 73)
  - Blind Spot Assist (▷ page 205) or Active Blind Spot Assist (▷ page 209)
  - ATTENTION ASSIST (▷ page 204)
  - Lane Keeping Assist (▷ page 207) or Active Lane Keeping Assist (▷ page 212)
  - Rear window wiper (▷ page 121)
- ▶ Press  to display the ATTENTION ASSIST assessment.

## Service menu

### Introduction

Depending on the equipment installed in the vehicle, you have the following options in the **Service** menu:

- calling up display messages in message memory (▷ page 239)
- restarting the tire pressure loss warning system (Canada only) (▷ page 356).
- checking the tire pressure electronically (▷ page 358).
- calling up the service due date (▷ page 323).

## Settings menu

### Introduction

Depending on the equipment installed in the vehicle, you have the following options in the **Settings** menu:











- Changing assistance settings (▷ page 232).
- Changing head-up display settings (▷ page 233).
- Changing the light settings (▷ page 234).

- Changing the instrument cluster settings (▷ page 234).
- Restoring the factory settings (▷ page 235).

## Assistance submenu













### Traffic Sign Assist

You can activate or deactivate the warning function of Traffic Sign Assist in the **Traffic Sign Assist** menu. When the function is activated, detected traffic signs and information appear in the multifunction display for five seconds.

- ▶ Press the  button on the steering wheel to open the menu list.
- ▶ Press the  or  button on the steering wheel to select the **Settings** menu.
- ▶ Confirm by pressing  on the steering wheel.
- ▶ Press  or  to select the **DriveAssist** submenu.
- ▶ Press  to confirm.
- ▶ Press  or  to select **Traffic Sign Assist**.
- ▶ Press  to confirm. The current selection appears.
- ▶ **Activate or deactivate the warning function:** press  again.

For further information about Traffic Sign Assist, see (▷ page 205).













### Activating/deactivating Active Brake Assist

- ▶ Press the  button on the steering wheel to open the menu list.
- ▶ Press the  or  button on the steering wheel to select the **Settings** menu.
- ▶ Confirm by pressing  on the steering wheel.
- ▶ Use  or  to select the **DriveAssist** submenu.
- ▶ Press  to confirm.
- ▶ Select **Brake Assist** by pressing  or .
- ▶ Press  to confirm. The current selection appears.
- ▶ **To activate/deactivate:** press  again. When Active Brake Assist is deactivated, the  symbol appears on the **Assistance Graphic** menu of the multifunction display.

Further information on Active Brake Assist (▷ page 67).











### Activating/deactivating Active Brake Assist with cross-traffic function

Active Brake Assist with cross-traffic function is available only in vehicles with the Driving Assistance package.

- ▶ Press the  button on the steering wheel to open the menu list.
- ▶ Press the  or  button on the steering wheel to select the **Settings** menu.
- ▶ Confirm by pressing  on the steering wheel.
- ▶ Use  or  to select the **DriveAssist** submenu.
- ▶ Press  to confirm.
- ▶ Select **Brake Assist** by pressing  or .
- ▶ Press  to confirm. The current selection appears.
- ▶ **To activate/deactivate:** press the  button again. When Active Brake Assist with cross-traffic function is deactivated, the  symbol appears on the **Assistance Graphic** menu of the multifunction display.

Further information about Active Brake Assist with cross-traffic function (▷ page 73).













### Activating/deactivating Blind Spot Assist

- ▶ Press the  button on the steering wheel to open the menu list.
- ▶ Press  or  on the steering wheel to select the **Settings** menu.
- ▶ Confirm by pressing  on the steering wheel.
- ▶ Press  or  to select the **DriveAssist** submenu.
- ▶ Press  to confirm.
- ▶ Press  or  to select **Blind Spot Assist**.
- ▶ Press  to confirm. The current selection appears.
- ▶ **To activate/deactivate:** press the  button again.

For further information about Blind Spot Assist, see (▷ page 205).

For further information about Active Blind Spot Assist, see (▷ page 209).











### Setting ATTENTION ASSIST

- ▶ Press the  button on the steering wheel to open the menu list.
- ▶ Press the  or  button on the steering wheel to select the **Settings** menu.
- ▶ Confirm by pressing  on the steering wheel.
- ▶ Use  or  to select the **DriveAssist** submenu.
- ▶ Press  to confirm.
- ▶ Select **Attention Assist** by pressing  or .
- ▶ Press  to confirm.
- ▶ Press  or  to select **Off**, **Standard** or **Sensitive**.
- ▶ Press the  button to confirm the selection.

When ATTENTION ASSIST is deactivated, the  symbol appears in the **Assistance Graphic** menu in the multifunction display.

For further information about ATTENTION ASSIST, see (▷ page 203).

### Setting Lane Keeping Assist

- ▶ Press the  button on the steering wheel to open the menu list.
  - ▶ Press  or  on the steering wheel to select the **Settings** menu.
  - ▶ Confirm by pressing  on the steering wheel.
  - ▶ Press  or  to select the **DriveAssist** submenu.
  - ▶ Press  to confirm.
  - ▶ Press  or  to select **Lane Keeping Assist**.
  - ▶ Press  to confirm.
- The current selection **Standard** or **Adaptive** appears.
- ▶ **To change the setting:** press  again.

For further information about Lane Keeping Assist, see (▷ page 207).

For further information about Active Lane Keeping Assist, see (▷ page 212).

### Head-up display submenu

#### Selecting other displays

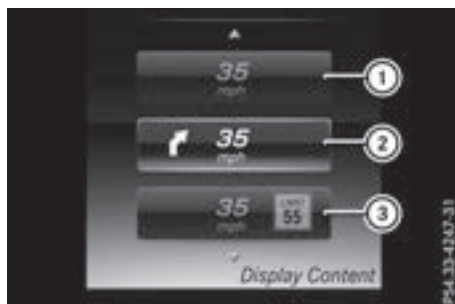













- ① Vehicle speed display
- ② Vehicle speed and navigation instruction display
- ③ Vehicle speed display and Traffic Sign Assist

Using the **Display Content** function, you can choose from up to four display options depending on the vehicle's equipment. The selected contents appear in the head-up display.

In Mercedes-AMG vehicles, you can also choose between two AMG displays. If you select an AMG display, the head-up display shows AMG-specific contents.

If you select a display with traffic signs, detected traffic signs from Traffic Sign Assist appear in the head-up display.















- ▶ Press the  button on the steering wheel to open the menu list.
  - ▶ Press  or  on the steering wheel to select the **Settings** menu.
  - ▶ Confirm by pressing  on the steering wheel.
  - ▶ Press  or  to select the **Head-up Display** submenu.
  - ▶ Press  to confirm.
  - ▶ Select **Display Content** by pressing  or .
  - ▶ Press  to confirm.
- A graphic selection list appears.
- ▶ Press  or  to select the desired display.
  - ▶ Press the  button to confirm the selection.

You can find more information on the navigation displays in the multimedia system (see Digital Operator's Manual).

Information on displays of Traffic Sign Assist (▷ page 205).

### Setting the position











You can adjust the position of the head-up display on the windshield. You can compensate for height differences if the seat positions are changed, for example.





- ▶ Switch on the head-up display (▷ page 223).
- ▶ Press the  button on the steering wheel to open the menu list.
- ▶ Press the  or  button on the steering wheel to select the **Settings** menu.
- ▶ Confirm by pressing  on the steering wheel.
- ▶ Use  or  to select the **Head-up Display** submenu.
- ▶ Press  to confirm.
- ▶ Press  or  to select the **Position** function.
- ▶ Press the  button to save the setting.
- ▶ Press  or  to adjust the position to a level from **Level +5** (up) to **Level -5** (down).
- ▶ Press the  or  button to save the setting.

Using the Memory function, you can save and call up the set position of the head-up display as a single memory preset (▷ page 110).

### Setting the brightness

The brightness of the head-up display is automatically adjusted to the surrounding ambient light. You can also individually adjust the brightness of the head-up display.











- ▶ Switch on the head-up display (▷ page 223).
- ▶ Press the  button on the steering wheel to open the menu list.
- ▶ Press the  or  button on the steering wheel to select the **Settings** menu.
- ▶ Confirm by pressing  on the steering wheel.
- ▶ Use  or  to select the **Head-up Display** submenu.
- ▶ Press  to confirm.
- ▶ Press  or  to select the **Brightness** function.
- ▶ Press the  button to save the setting.

- ▶ Press the  or  button to adjust the brightness to a level from **Level +5** (bright) to **Level -5** (dark).
- ▶ Press the  or  button to save the setting.

### Light submenu

#### Switching the daytime running lamps on/off

This function is not available in Canada.







- ▶ Press  on the steering wheel to open the menu list.
  - ▶ Press  or  on the steering wheel to select the **Settings** menu.
  - ▶ Confirm by pressing  on the steering wheel.
  - ▶ Press  or  to select the **Lights** submenu.
  - ▶ Press  to confirm.
  - ▶ Using  or , select the **Daytime Running Lights** function.
- If the **Daytime Running Lights** function has been switched on, the multifunction display shows the cone of light and the  symbol in yellow.
- ▶ Press the  button to save the setting.

Further information on daytime running lamps **Daytime Running Lights** (▷ page 112).

### Instrument cluster submenu

#### Selecting the distance unit

The **Display Unit Speed-/Odometer** function allows you to choose whether certain displays appear in kilometers or miles in the multifunction display.

- ▶ Press the  button on the steering wheel to open the menu list.
- ▶ Press the  or  button on the steering wheel to select the **Settings** menu.
- ▶ Confirm by pressing  on the steering wheel.
- ▶ Use  or  to select the **Instrument Cluster** submenu.
- ▶ Press  to confirm.

- ▶ Press  or  to select the **Display Unit Speed-/Odometer** function.

The current setting **km** or **Miles** appears.

- ▶ Press the  button to save the setting.

The selected unit of measurement for distance applies to:

- Digital speedometer in the **Trip** menu
- Odometer and the trip odometer
- Trip computer
- Current consumption and the range
- Navigation instructions in the **Navi** menu
- Cruise control
- Distance Pilot DISTRONIC with Steering Pilot
- ASSYST PLUS service interval display

### Switching the additional speedometer on/off

If the additional speedometer is switched on, the speed is shown in the status bar in the multifunction display instead of the outside temperature.

The speed display is inverse to the speedometer.

- ▶ Press the  button on the steering wheel to open the menu list.
- ▶ Press the  or  button on the steering wheel to select the **Settings** menu.
- ▶ Confirm by pressing  on the steering wheel.
- ▶ Use  or  to select the **Instrument Cluster** submenu.
- ▶ Press  to confirm.
- ▶ Using  or , select the **Additional Speedometer [km/h]** function. The current selection appears.
- ▶ **To activate/deactivate:** press the  button again.

### Restoring the factory settings

- ▶ Press the  button on the steering wheel to open the menu list.
- ▶ Press the  or  button on the steering wheel to select the **Settings** menu.
- ▶ Confirm by pressing  on the steering wheel.
- ▶ Use  or  to select the **Factory Settings** submenu.

- ▶ Press  to confirm.

The **Reset All Settings?** function appears.

- ▶ Press  or  to select **No** or **Yes**.

- ▶ Press  to confirm the selection.

If you have selected **Yes**, the multifunction display shows a confirmation message.

For safety reasons, the **Daytime Running Lights** function in the **Lights** submenu is only reset when the vehicle is stationary.

### AMG menu (Mercedes-AMG vehicles)

#### Warm-up



- ① Digital speedometer
- ② Gear indicator
- ③ Charge-air pressure
- ④ Engine oil temperature
- ⑤ Transmission oil temperature

- ▶ Press the  button on the steering wheel to open the menu list.
- ▶ Press the  or  button on the steering wheel to select the **AMG** menu.
- ▶ Confirm by pressing  on the steering wheel.

#### Engine and transmission oil temperatures:

when the engine and transmission are at normal operating temperature, oil temperatures ④ and ⑤ are displayed in white in the multifunction display.

If the multifunction display shows oil temperature ④ or ⑤ in blue, the engine or the transmission are not yet at normal operating temperature. Avoid driving at full engine output during this time.

## Traffic Sign Assist display



- ▶ Switch on the display function for notes and traffic signs (▶ page 232).
- ▶ Press the button on the steering wheel to open the menu list.
- ▶ Press the or button on the steering wheel to select the **AMG** menu.
- ▶ Confirm by pressing on the steering wheel.
- ▶ Press the button repeatedly until the Traffic Sign Assist display appears.

## G-Meter



While the vehicle is in motion, the G-Meter shows the forces that are exerted on the driver both laterally and in the direction of travel.

The maximum values are indicated in red in the guideline system.

- ▶ Press on the steering wheel to open the menu list.
- ▶ Press the or button on the steering wheel to select the **AMG** menu.
- ▶ Confirm by pressing on the steering wheel.
- ▶ Press the button repeatedly until the G-Meter appears.

The maximum values of the G-Meter are saved.

- ▶ **To reset the G-Meter:** press again.
- ▶ Using or select **Yes** on the steering wheel.
- ▶ Press to confirm.  
The maximum values of the G-Meter are deleted.

If the ignition remains switched off for longer than four hours, the G-Meter will be automatically reset.

## SETUP

### Mercedes-AMG GLC 63 4MATIC+



(Example)

- ① Drive system **Comfort/Sport/Sport +**
- ② Suspension **Comfort/Sport/Sport +**
- ③ Transmission **D/M**
- ④ Exhaust system **Comfort/Sport +**
- ⑤ ESP® **On/Off** or SPORT handling mode **Sport**

SETUP shows the following functions and settings:

- the gear indicator
- the digital speedometer
- the drive system setting
- the suspension mode
- the transmission position
- the exhaust flap position
- the ESP® (Electronic Stability Program) status

## Mercedes-AMG GLC 43 4MATIC



(Example)

- ① Drive Eco/Comfort/Sport/Sport +
- ② Suspension Comfort/Sport/Sport +
- ③ Steering Comfort/Sport
- ④ ECO Start/Stop Active/Inactive/Off
- ⑤ ESP® On/Off or SPORT handling mode Sport

SETUP shows the following functions and settings:

- the gear indicator
- the digital speedometer
- the drive system setting
- the suspension mode
- the steering setting
- the setting of the ECO start/stop function
- the ESP® (Electronic Stability Program) status

### Select SETUP

- ▶ Use on the steering wheel to call up the list of menus.
- ▶ Press or on the steering wheel to select the AMG menu.
- ▶ Confirm by pressing on the steering wheel.
- ▶ Press repeatedly until SETUP appears.

## RACE TIMER

### Displaying and starting RACETIMER



- ① Lap
- ② RACETIMER

The RACETIMER is only intended for use on a closed race circuit. Do not use the function on public roads.

You can start the RACETIMER when the engine is running or the ignition is switched on.

- ▶ Use on the steering wheel to call up the list of menus.
- ▶ Press the or button on the steering wheel to select the AMG menu.
- ▶ Confirm by pressing on the steering wheel.
- ▶ Press or repeatedly until the RACETIMER appears.
- ▶ **To start:** press the button to start the RACETIMER.

### Starting a new lap



- ① Lap
- ② RACETIMER
- ③ Quickest lap time



▶ Press the  or  button to select **New Lap**.

▶ Press  to confirm.

A maximum of 32 laps may be stored.

### Stopping the RACETIMER



▶ Press  or  to select **Stop**.

▶ Press  to confirm.

### Continuing the RACETIMER



▶ Press  or  to select **Continue**.

▶ Press  to confirm.

### Resetting the RACETIMER



▶ Press  or  to select **Stop**. The RACETIMER is stopped.

▶ Press  or  to select **Reset**.

▶ Press  to confirm.

All laps are deleted.

### Lap statistics



① Lap

② Lap time

③ Average lap speed

④ Lap length

This function is only available if you have stored at least two laps and have stopped the RACETIMER.

▶ Use  on the steering wheel to call up the list of menus.

▶ Press the  or  button on the steering wheel to select the **AMG** menu.

▶ Confirm by pressing  on the steering wheel.

▶ Press the  or  button to select **Lap List**.

▶ Press  to confirm. The lap evaluation appears.

▶ Press the  or  button to select a different lap evaluation.

The fastest lap is indicated by flashing symbol ①.

## Display messages

### Introduction

#### General notes

Display messages appear in the multifunction display.

Display messages with graphic displays may be shown in simplified form in the Operator's Manual and may therefore differ from the multifunction display.

Please respond in accordance with the display messages and follow the additional notes in this Operator's Manual.

With certain display messages, you will also hear a warning tone.

You can hide the display messages. The display messages are then stored in the message memory. Rectify the cause of a display message as soon as possible.

When you stop and park the vehicle, please observe the notes on:

- HOLD function (▷ page 178)
- Parking (▷ page 158)

#### Hiding display messages









- ▶ Press the  or  button on the steering wheel. The multifunction display hides the display message.

High-priority display messages are shown in red in the multifunction display. Some high-priority display messages cannot be hidden.

The multifunction display shows these messages continuously until the causes for the messages have been remedied.

#### Message memory

The on-board computer saves certain display messages in the **message memory**. You can call up the display messages:

- ▶ Press the  button on the steering wheel to open the menu list.
- ▶ Press  or  on the steering wheel to select the **Service** menu.
- ▶ Confirm by pressing  on the steering wheel.
- ▶ Press the  or  button to select the message memory. If there are no display messages, the **No Messages** display appears in the multifunction display. When there are display messages, the number of stored messages appears.
- ▶ Press  to confirm.
- ▶ Press the  or  button to scroll through the display messages.

## Safety systems

## Display messages





Currently Unavailable See Operator's Manual

## Possible causes/consequences and ► Solutions

ABS (Anti-lock Braking System) and ESP<sup>®</sup> (Electronic Stability Program) are temporarily not available.

Other driving systems and driving safety systems may also malfunction.

In addition, the  and  warning lamps light up in the instrument cluster.

For example, the on-board voltage may be insufficient.

 **WARNING**

The brake system continues to function normally, but without the functions listed above. The wheels could therefore lock if you brake hard, for example.

The steerability and braking characteristics may be severely affected. The braking distance in an emergency braking situation can increase.

If ESP<sup>®</sup> is not operational, ESP<sup>®</sup> is unable to stabilize the vehicle.

There is an increased risk of skidding and an accident.

► Drive on carefully.

Carefully drive a suitable distance, making slight steering movements at a speed above 12 mph (20 km/h).

If the display message disappears, the functions mentioned above are available again.

If the multifunction display still shows the display message:

► Drive on carefully.



► Visit a qualified specialist workshop immediately.



Inoperative See Operator's Manual

ABS and ESP<sup>®</sup> are malfunctioning.

Other driving systems and driving safety systems may also malfunction.

The **BRAKE** (USA only) or  (Canada only),  and  warning lamps in the instrument cluster may also light up.

 **WARNING**

The brake system continues to function normally, but without the functions listed above. The wheels could therefore lock if you brake hard, for example.





The steerability and braking characteristics may be severely affected. The braking distance in an emergency braking situation can increase.



















If ESP<sup>®</sup> is not operational, ESP<sup>®</sup> is unable to stabilize the vehicle.









There is an increased risk of skidding and an accident.









► Drive on carefully.

► Visit a qualified specialist workshop immediately.













Display messages	Possible causes/consequences and ► Solutions
 <p data-bbox="116 220 320 272">Inoperative See Operator's Manual</p>	<p data-bbox="372 172 600 199">ESP® is malfunctioning.</p> <p data-bbox="372 204 1028 256">Other driving systems and driving safety systems may also malfunction.</p> <p data-bbox="372 261 983 288">The  warning lamp also lights up in the instrument cluster.</p> <p data-bbox="384 300 535 327"><b>▲ WARNING</b></p> <p data-bbox="372 343 1003 395">The brake system continues to function normally, but without the functions listed above.</p> <p data-bbox="372 400 997 453">The braking distance in an emergency braking situation can thus increase.</p> <p data-bbox="372 458 1000 510">If ESP® is not operational, ESP® is unable to stabilize the vehicle. There is an increased risk of skidding and an accident.</p> <ul style="list-style-type: none"> <li data-bbox="372 521 568 549">► Drive on carefully.</li> <li data-bbox="372 553 869 580">► Visit a qualified specialist workshop immediately.</li> </ul>
 <p data-bbox="116 646 348 724">Currently Unavailable See Operator's Manual</p>	<p data-bbox="372 598 680 625">ESP® is temporarily unavailable.</p> <p data-bbox="372 630 1028 683">Other driving systems and driving safety systems may also malfunction.</p> <p data-bbox="372 687 983 715">The  warning lamp also lights up in the instrument cluster.</p> <p data-bbox="372 719 986 746">The self-diagnosis function might not be complete, for example.</p> <p data-bbox="384 758 535 785"><b>▲ WARNING</b></p> <p data-bbox="372 801 1025 879">The brake system continues to function normally, but without the functions listed above. The wheels could therefore lock if you brake hard, for example.</p> <p data-bbox="372 884 997 936">The braking distance in an emergency braking situation can thus increase.</p> <p data-bbox="372 941 1000 994">If ESP® is not operational, ESP® is unable to stabilize the vehicle. There is an increased risk of skidding and an accident.</p> <ul style="list-style-type: none"> <li data-bbox="372 1005 1031 1107">► Carefully drive a suitable distance, making slight steering movements at a speed above 12 mph (20 km/h). If the display message disappears, the functions mentioned above are available again.</li> </ul> <p data-bbox="372 1118 944 1145">If the multifunction display still shows the display message:</p> <ul style="list-style-type: none"> <li data-bbox="372 1157 568 1184">► Drive on carefully.</li> <li data-bbox="372 1189 869 1216">► Visit a qualified specialist workshop immediately.</li> </ul>

Display messages	Possible causes/consequences and ► Solutions
   <p>Inoperative See Operator's Manual</p>	<p>EBD (electronic brake force distribution), ABS and ESP<sup>®</sup> are malfunctioning.</p> <p>Other driving systems and driving safety systems may also malfunction.</p> <p>In addition, the  and  warning lamps light up in the instrument cluster and a warning tone sounds.</p> <p><b>▲ WARNING</b></p> <p>The brake system continues to function normally, but without the functions listed above. The front and rear wheels could therefore lock if you brake hard, for example.</p> <p>The steerability and braking characteristics may be severely affected. The braking distance in an emergency braking situation can increase. If ESP<sup>®</sup> is not operational, ESP<sup>®</sup> is unable to stabilize the vehicle. There is an increased risk of skidding and an accident.</p> <ul style="list-style-type: none"> <li>► Drive on carefully.</li> <li>► Visit a qualified specialist workshop immediately.</li> </ul>
<p> (USA only)  (Canada only)</p> <p>Turn On the Ignition to Release the Parking Brake</p>	<p>The red  (USA only) or  (Canada only) indicator lamp lights up.</p> <p>You attempted to release the electric parking brake while the ignition was switched off.</p> <ul style="list-style-type: none"> <li>► Switch on the ignition.</li> </ul>
<p> (USA only)  (Canada only)</p> <p>Please Release Parking Brake</p>	<p>The red  (USA only) or  (Canada only) indicator lamp flashes and a warning tone sounds. A condition for automatic release of the electric parking brake is not fulfilled (► page 160).</p> <p>You are driving with the electric parking brake applied.</p> <ul style="list-style-type: none"> <li>► Release the electric parking brake manually.</li> </ul> <p>The red  (USA only) or  (Canada only) indicator lamp flashes and a warning tone sounds.</p> <p>You are using the electric parking brake for emergency braking (► page 160).</p>
<p> (USA only)  (Canada only)</p> <p>Parking Brake See Operator's Manual</p>	<p>The yellow  warning lamp lights up.</p> <p>The electric parking brake is malfunctioning.</p> <p><b>To apply:</b></p> <ul style="list-style-type: none"> <li>► Switch the ignition off.</li> <li>► Press the electric parking brake handle for at least ten seconds.</li> <li>► Shift the transmission to position .</li> <li>► Consult a qualified specialist workshop.</li> </ul>







Display messages	Possible causes/consequences and ► Solutions
	<p>The yellow  warning lamp and the red  (USA only) or  (Canada only) indicator lamp light up. The electric parking brake is malfunctioning.</p> <p><b>To release:</b></p> <ul style="list-style-type: none"> <li>► Switch off the ignition and turn it back on.</li> <li>► Release the electric parking brake manually.</li> </ul> <p>or</p> <ul style="list-style-type: none"> <li>► Release the electric parking brake automatically (▷ page 160).</li> </ul> <p>If the electric parking brake still cannot be released:</p> <ul style="list-style-type: none"> <li>► Do not drive on.</li> <li>► Consult a qualified specialist workshop.</li> </ul>
	<p>The red  (USA only) or  (Canada only) indicator lamp flashes and the yellow  warning lamp lights up. The electric parking brake is malfunctioning.</p> <p><b>To release:</b></p> <ul style="list-style-type: none"> <li>► Switch off the ignition and turn it back on.</li> <li>► Release the electric parking brake manually.</li> </ul> <p><b>To apply:</b></p> <ul style="list-style-type: none"> <li>► Switch off the ignition and turn it back on.</li> <li>► Apply the electric parking brake manually.</li> </ul> <p>If the red  (USA only) or  (Canada only) indicator lamp continues to flash:</p> <ul style="list-style-type: none"> <li>► Do not drive on.</li> <li>► Secure the vehicle against rolling away (▷ page 370).</li> <li>► Shift the transmission to position .</li> <li>► Turn the front wheels towards the curb.</li> <li>► Consult a qualified specialist workshop.</li> </ul>







Display messages	Possible causes/consequences and ► Solutions
	<p>The yellow  warning lamp lights up. The red  (USA only) or  (Canada only) indicator lamp flashes for about ten seconds after the electric parking brake has been applied or released. It then goes out or remains lit.</p> <p>The electric parking brake is malfunctioning.</p> <ul style="list-style-type: none"> <li>► Switch off the ignition and turn it back on.</li> <li>► Apply the electric parking brake.</li> </ul> <p>If it is not possible to apply the electric parking brake:</p> <ul style="list-style-type: none"> <li>► Shift the transmission to position .</li> <li>► Visit a qualified specialist workshop.</li> </ul> <p>If it is not possible to release the electric parking brake manually:</p> <ul style="list-style-type: none"> <li>► Release the electric parking brake automatically (&gt; page 160).</li> </ul> <p>If the electric parking brake still cannot be released:</p> <ul style="list-style-type: none"> <li>► Consult a qualified specialist workshop.</li> </ul>
<p> (USA only)  (Canada only)</p> <p>Parking Brake Inoperative</p>	<p>The yellow  warning lamp lights up. The red  (USA only) or  (Canada only) indicator lamp flashes for about ten seconds after the electric parking brake has been applied or released. It then goes out or remains lit.</p> <p>The electric parking brake is malfunctioning, e.g. because of overvoltage or undervoltage.</p> <ul style="list-style-type: none"> <li>► Remove the cause for the overvoltage or undervoltage, e.g. by charging the battery or restarting the engine.</li> <li>► Apply or release the electric parking brake.</li> </ul> <p>If it remains impossible to apply or release the electric parking brake:</p> <ul style="list-style-type: none"> <li>► Switch off the ignition and turn it back on.</li> <li>► Apply or release the electric parking brake.</li> </ul> <p>If the electric parking brake still cannot be released:</p> <ul style="list-style-type: none"> <li>► Consult a qualified specialist workshop.</li> </ul> <p>If the electric parking brake still cannot be applied:</p> <ul style="list-style-type: none"> <li>► Visit a qualified specialist workshop.</li> </ul>





Display messages	Possible causes/consequences and ► Solutions
	<p>The yellow  warning lamp lights up and the red  (USA only) or  (Canada only) indicator lamp flashes.</p> <p>It is not possible to apply the electric parking brake manually.</p> <ul style="list-style-type: none"> <li>► Shift the transmission to position .</li> <li>► Visit a qualified specialist workshop.</li> </ul>
<p> (USA only)   (Canada only)  <b>Check Brake Fluid Level</b></p>	<p>There is not enough brake fluid in the brake fluid reservoir. In addition, the  (USA only) or  (Canada only) warning lamp lights up in the instrument cluster and a warning tone sounds.</p> <p> <b>WARNING</b></p> <p>The braking effect may be impaired.          There is a risk of an accident.</p> <ul style="list-style-type: none"> <li>► Pull over and stop the vehicle safely as soon as possible, paying attention to road and traffic conditions. Do not continue driving under any circumstances.</li> <li>► Secure the vehicle against rolling away (▷ page 158).</li> <li>► Consult a qualified specialist workshop.</li> <li>► Do not add brake fluid. This does not correct the malfunction.</li> </ul>
<p>  <b>Check Brake Pad Wear</b></p>	<p>The brake pads/linings have reached their wear limit.          USA only: the red  brake system warning lamp is lit while the engine is running.</p> <ul style="list-style-type: none"> <li>► Visit a qualified specialist workshop.</li> </ul>
<p>  <b>Inoperative</b></p>	<p>One or more main features of the mbrace system are malfunctioning.</p> <ul style="list-style-type: none"> <li>► Visit a qualified specialist workshop.</li> </ul>
<p><b>Active Brake Assist Functions Currently Limited See Operator's Manual</b></p>	<p>Active Brake Assist is temporarily inoperative.          Possible causes are:</p> <ul style="list-style-type: none"> <li>• the radar sensor system is temporarily inoperative, e.g. due to electromagnetic radiation emitted by nearby TV or radio stations or other sources of electromagnetic radiation</li> <li>• the system is outside the operating temperature range</li> <li>• the on-board voltage is too low</li> </ul> <p>When the causes stated above no longer apply, the display message disappears.</p> <p>Active Brake Assist is operational again.</p> <p>If the display message does not disappear:</p> <ul style="list-style-type: none"> <li>► Pull over and stop the vehicle safely as soon as possible, paying attention to road and traffic conditions.</li> <li>► Secure the vehicle against rolling away (▷ page 158).</li> <li>► Restart the engine.</li> </ul>

Display messages	Possible causes/consequences and ► Solutions
Active Brake Assist Functions Limited See Operator's Manual	Active Brake Assist is unavailable due to a malfunction. Adaptive Brake Assist may also have failed. ► Visit a qualified specialist workshop immediately.
PRE-SAFE Inoperative See Operator's Manual	Important functions of PRE-SAFE® have failed. All other occupant safety systems, e.g. air bags, remain available. ► Visit a qualified specialist workshop immediately.
Active Brake Assist Functions Currently Limited See Operator's Manual	Active Brake Assist with cross-traffic function is temporarily inoperative. Possible causes are: <ul style="list-style-type: none"> <li>• function is impaired due to heavy rain or snow</li> <li>• the radar sensor system is temporarily inoperative, e.g. due to electromagnetic radiation emitted by nearby TV or radio stations or other sources of electromagnetic radiation</li> <li>• the system is outside the operating temperature range</li> <li>• the on-board voltage is too low</li> <li>• Mercedes-AMG vehicles: ESP® is deactivated.</li> </ul> When the causes stated above no longer apply, the display message disappears. Active Brake Assist with cross-traffic function is operational again. If the display message does not disappear: <ul style="list-style-type: none"> <li>► Pull over and stop the vehicle safely as soon as possible, paying attention to road and traffic conditions.</li> <li>► Secure the vehicle against rolling away (▷ page 158).</li> <li>► Restart the engine.</li> <li>► Mercedes-AMG vehicles: switch ESP® on again (▷ page 71).</li> </ul>
Active Brake Assist Functions Limited See Operator's Manual	Active Brake Assist with cross-traffic function is unavailable due to a malfunction. ► Visit a qualified specialist workshop immediately.

Display messages	Possible causes/consequences and ► Solutions
<p>Radar Sensors Dirty See Operator's Manual</p>	<p>The radar sensor system is malfunctioning. Possible causes are:</p> <ul style="list-style-type: none"> <li>• dirt on sensors</li> <li>• heavy rain or snow</li> <li>• when driving on inter-urban roads without traffic or infrastructure, e.g. in desert-like areas</li> </ul> <p>At least one driving system or driving safety system is malfunctioning or is temporarily unavailable:</p> <ul style="list-style-type: none"> <li>• Active Brake Assist with cross-traffic function</li> <li>• Active Brake Assist</li> <li>• Active Lane Keeping Assist</li> <li>• Active Blind Spot Assist</li> <li>• Distance Pilot DISTRONIC with Steering Pilot</li> </ul> <p>If the radar sensor system in front is dirty, Active Blind Spot Assist will not perform a course-correcting brake application. Once the cause of the problem is no longer present, the driving and drive safety systems will be available again. The display message disappears.</p> <p>If the display message does not disappear:</p> <ul style="list-style-type: none"> <li>► Pull over and stop the vehicle safely as soon as possible, paying attention to road and traffic conditions.</li> <li>► Secure the vehicle against rolling away (▷ page 158).</li> <li>► Switch off the engine.</li> <li>► Clean all sensors (▷ page 328).</li> <li>► Restart the engine. The display message disappears.</li> </ul>
<p> SRS Malfunction Service Required</p>	<p>The restraint system is malfunctioning. The  warning lamp also lights up in the instrument cluster.</p> <p> <b>WARNING</b></p> <p>The air bags or Emergency Tensioning Devices may either be triggered unintentionally or, in the event of an accident, may not be triggered. There is an increased risk of injury.</p> <ul style="list-style-type: none"> <li>► Visit a qualified specialist workshop immediately.</li> </ul> <p>For further information about the restraint system, see (▷ page 44).</p>
<p> Front Left Malfunction Service Required or Front Right Malfunction Service Required</p>	<p>The restraint system is malfunctioning at the front on the left or right. The  warning lamp also lights up in the instrument cluster.</p> <p> <b>WARNING</b></p> <p>The air bags or Emergency Tensioning Devices may either be triggered unintentionally or, in the event of an accident, may not be triggered. There is an increased risk of injury.</p> <ul style="list-style-type: none"> <li>► Visit a qualified specialist workshop immediately.</li> </ul>







Display messages	Possible causes/consequences and ► Solutions
 <p>Rear Left Malfunction Service Required or Rear Right Malfunction Service Required</p>	<p>The rear left-hand or right-hand restraint system is malfunctioning. The  warning lamp also lights up in the instrument cluster.</p> <p><b>⚠ WARNING</b></p> <p>The air bags or Emergency Tensioning Devices may either be triggered unintentionally or, in the event of an accident, may not be triggered. There is an increased risk of injury.</p> <p>► Visit a qualified specialist workshop immediately.</p>
 <p>Rear Center Malfunction Service Required</p>	<p>The rear center restraint system is malfunctioning. The  warning lamp also lights up in the instrument cluster.</p> <p><b>⚠ WARNING</b></p> <p>The air bags or Emergency Tensioning Devices may either be triggered unintentionally or, in the event of an accident, may not be triggered. There is an increased risk of injury.</p> <p>► Visit a qualified specialist workshop immediately.</p>
 <p>Left Side Curtain Airbag Malfunction Service Required or Right Side Curtain Airbag Malfunction Service Required</p>	<p>The left-hand or right-hand window curtain air bag is malfunctioning. The  warning lamp also lights up in the instrument cluster.</p> <p><b>⚠ WARNING</b></p> <p>The left or right window curtain air bag may either be triggered unintentionally or, in the event of an accident, may not be triggered. There is an increased risk of injury.</p> <p>► Visit a qualified specialist workshop immediately.</p>

Display messages	Possible causes/consequences and ► Solutions
<p>Front Passenger Airbag Disabled See Operator's Manual</p>	<p>The front-passenger front air bag is deactivated during the journey, even though:</p> <ul style="list-style-type: none"> <li>• an adult</li> <li>or</li> <li>• a person of the corresponding stature is on the front-passenger seat</li> </ul> <p>If additional forces are applied to the seat, the system may interpret the occupant's weight as lower than it actually is.</p> <p> <b>WARNING</b></p> <p>The front-passenger front air bag does not deploy during an accident. There is an increased risk of injury.</p> <ul style="list-style-type: none"> <li>► Pull over and stop the vehicle safely as soon as possible, paying attention to road and traffic conditions.</li> <li>► Secure the vehicle against rolling away (► page 158).</li> <li>► Switch the ignition off.</li> <li>► Have the occupant on the front-passenger seat get out of the vehicle.</li> <li>► Keep the seat unoccupied, close the front-passenger door and switch on the ignition.</li> <li>► Observe the PASSENGER AIR BAG indicator lamps in the center console and the multifunction display and check the following: Seat unoccupied and ignition switched on: <ul style="list-style-type: none"> <li>• a self-diagnosis is carried out. The PASSENGER AIR BAG OFF and PASSENGER AIR BAG ON indicator lamps must light up simultaneously for approximately six seconds.</li> <li>• the PASSENGER AIR BAG OFF indicator lamp must then light up and remain lit after the self-diagnosis. If the indicator lamp is on, OCS (Occupant Classification System) has disabled the front-passenger front air bag (► page 52)</li> <li>• the display messages <a href="#">Front Passenger Airbag Enabled See Operator's Manual</a> or <a href="#">Front Passenger Airbag Disabled See Operator's Manual</a> must not appear in the multifunction display</li> </ul> </li> <li>► Wait for a period of at least 60 seconds until the necessary system checks have been completed.</li> <li>► Make sure that the display messages do not appear in the multifunction display.</li> </ul> <p>If these conditions are fulfilled, the front-passenger seat can be occupied again. Whether the PASSENGER AIR BAG OFF indicator lamp remains lit or goes out depends on how OCS classifies the occupant. If the conditions are not fulfilled, the system is not operating correctly.</p> <ul style="list-style-type: none"> <li>► Visit a qualified specialist workshop immediately.</li> </ul> <p>For further information about the Occupant Classification System, see (► page 52).</p>

Display messages	Possible causes/consequences and ► Solutions
<p>Front Passenger Airbag Enabled See Operator's Manual</p>	<p>The front-passenger front air bag is activated during the journey, even though:</p> <ul style="list-style-type: none"> <li>• a child, a small adult or an object weighing less than the system's weight threshold is located on the front-passenger seat or</li> <li>• the front-passenger seat is unoccupied</li> </ul> <p>The system may detect objects or forces applying additional weight on the seat.</p> <p> <b>WARNING</b></p> <p>The front-passenger front air bag may deploy unintentionally. There is an increased risk of injury.</p> <ul style="list-style-type: none"> <li>► Pull over and stop the vehicle safely as soon as possible, paying attention to road and traffic conditions.</li> <li>► Secure the vehicle against rolling away (▷ page 158).</li> <li>► Switch the ignition off.</li> <li>► Open the front-passenger door.</li> <li>► Remove the child and the child restraint system from the front-passenger seat.</li> <li>► Make sure that there are no objects on the seat adding to the weight. The system might otherwise detect the additional weight and interpret the seat occupant's weight as greater than it actually is.</li> <li>► Keep the seat unoccupied, close the front-passenger door and switch on the ignition.</li> <li>► Observe the PASSENGER AIR BAG indicator lamps in the center console and the multifunction display and check the following: Seat unoccupied and ignition switched on: <ul style="list-style-type: none"> <li>• a self-diagnosis is carried out. The PASSENGER AIR BAG OFF and PASSENGER AIR BAG ON indicator lamps must light up simultaneously for approximately six seconds.</li> <li>• the PASSENGER AIR BAG OFF indicator lamp must then light up and remain lit after the self-diagnosis. If the indicator lamp is on, OCS has disabled the front-passenger front air bag (▷ page 52)</li> <li>• the display messages <a href="#">Front Passenger Airbag Enabled See Operator's Manual</a> or <a href="#">Front Passenger Airbag Disabled See Operator's Manual</a> must not appear in the multifunction display</li> </ul> </li> <li>► Wait for a period of at least 60 seconds until the necessary system checks have been completed.</li> <li>► Make sure that the display messages do not appear in the multifunction display.</li> </ul> <p>If these conditions are fulfilled, the front-passenger seat can be occupied again. Whether the PASSENGER AIR BAG OFF indicator lamp remains lit or goes out depends on how OCS classifies the occupant. If the conditions are not fulfilled, the system is not operating correctly.</p> <ul style="list-style-type: none"> <li>► Visit a qualified specialist workshop immediately.</li> </ul>

Display messages	Possible causes/consequences and ► Solutions
	For further information about the Occupant Classification System, see (▷ page 52).



### Lights



Display messages	Possible causes/consequences and ► Solutions
 <p>Check Left Low Beam (Example)</p>	<p>The bulb in question is malfunctioning.</p> <ul style="list-style-type: none"> <li>► Visit a qualified specialist workshop.</li> </ul> <p>or</p> <ul style="list-style-type: none"> <li>► Check whether you are permitted to replace the bulb yourself (▷ page 117).</li> </ul> <p><b>i</b> LED light sources: the display message for the corresponding lamp only appears when all the LEDs in the lamp have failed.</p>
 <p>Active Headlamps Inoperative</p>	<p>The active light function is malfunctioning.</p> <ul style="list-style-type: none"> <li>► Visit a qualified specialist workshop.</li> </ul>
 <p>Malfunction See Operator's Manual</p>	<p>The exterior lighting is malfunctioning.</p> <ul style="list-style-type: none"> <li>► Visit a qualified specialist workshop.</li> </ul> <p>Vehicles with trailer tow hitch: a fuse may have blown.</p> <ul style="list-style-type: none"> <li>► Pull over and stop the vehicle safely as soon as possible, paying attention to road and traffic conditions.</li> <li>► Secure the vehicle against rolling away (▷ page 158).</li> <li>► Check the fuses (▷ page 347).</li> <li>► If necessary, replace the blown fuse. Observe the warning notes.</li> </ul> <p>If the display message remains on show:</p> <ul style="list-style-type: none"> <li>► Visit a qualified specialist workshop.</li> </ul>
 <p>Auto Lamp Function Inoperative</p>	<p>The light sensor is malfunctioning.</p> <ul style="list-style-type: none"> <li>► Visit a qualified specialist workshop.</li> </ul>
 <p>Switch Off Lights</p>	<p>You leave the vehicle and the lights are switched on. A warning tone also sounds.</p> <ul style="list-style-type: none"> <li>► Turn the light switch to the <b>AUTO</b> position.</li> </ul>
 <p>Switch On Headlamps</p>	<p>You are driving with low-beam headlamps switched off.</p> <ul style="list-style-type: none"> <li>► Turn the light switch to the  or <b>AUTO</b> position.</li> </ul>













Display messages	Possible causes/consequences and ► Solutions
Adaptive Highbeam Assist Currently Unavailable See Operator's Manual	<p>Adaptive Highbeam Assist is deactivated and temporarily inoperative. Possible causes are:</p> <ul style="list-style-type: none"> <li>• The windshield in the camera's field of vision is dirty.</li> <li>• Visibility is impaired due to heavy rain, snow or fog.</li> </ul> <p>► Clean the windshield.</p> <p>If the system detects that the camera is fully operational again, the <b>Adaptive Highbeam Assist Now Available</b> message is displayed. Adaptive Highbeam Assist is operational again.</p>
Adaptive Highbeam Assist Inoperative	<p>Adaptive Highbeam Assist is malfunctioning.</p> <p>► Visit a qualified specialist workshop.</p>





## Engine



Display messages	Possible causes/consequences and ► Solutions
 <p>Check Coolant Level See Operator's Manual</p>	<p>The coolant level is too low.</p> <p><b>!</b> Avoid making long journeys with too little coolant in the engine cooling system. The engine will otherwise be damaged.</p> <p>► Add coolant, observing the warning notes before doing so (► page 322).</p> <p><b>If you have to add coolant frequently:</b></p> <p>► Contact a qualified specialist workshop and have the engine cooling system checked.</p>
	<p>The fan motor is malfunctioning.</p> <p>► If the coolant temperature is below the red marking in the coolant temperature gage, drive to the nearest qualified specialist workshop.</p> <p>► Avoid heavy loads on the engine as you do so, e.g. driving in mountainous terrain and stop-and-go traffic.</p>

Display messages	Possible causes/consequences and ► Solutions
 <p data-bbox="116 220 322 296">Coolant Too Hot Stop Vehicle Turn Engine Off</p>	<p data-bbox="372 172 645 228">The coolant is too hot. A warning tone also sounds.</p> <p data-bbox="384 240 535 272"> <b>WARNING</b></p> <p data-bbox="372 284 1028 360">Do not drive when your engine is overheated. This can cause some fluids which may have leaked into the engine compartment to catch fire.</p> <p data-bbox="372 368 1031 419">Steam from the overheated engine can also cause serious burns which can occur just by opening the hood.</p> <p data-bbox="372 424 598 448">There is a risk of injury.</p> <ul style="list-style-type: none"> <li data-bbox="372 456 1031 507">► Pull over and stop the vehicle safely and switch off the engine, paying attention to road and traffic conditions.</li> <li data-bbox="372 512 908 536">► Secure the vehicle against rolling away (▷ page 158).</li> <li data-bbox="372 544 768 568">► Wait until the engine has cooled down.</li> <li data-bbox="372 576 1031 627">► Make sure that the air supply to the engine radiator is not blocked, e.g. by snow, slush or ice.</li> <li data-bbox="372 635 1031 711">► Do not start the engine again until the display message goes out and the coolant temperature gage is below the red marking. Otherwise, the engine could be damaged.</li> <li data-bbox="372 719 846 743">► Pay attention to the coolant temperature gage.</li> </ul> <p data-bbox="372 751 740 775"><b>If the temperature increases again:</b></p> <ul style="list-style-type: none"> <li data-bbox="372 783 869 807">► Visit a qualified specialist workshop immediately.</li> </ul> <p data-bbox="372 823 1014 874">Under normal operating conditions and with the specified coolant level, the coolant temperature display may rise to the red marking.</p>
 <p data-bbox="116 938 344 986">See Operator's Manual</p>	<p data-bbox="372 890 689 914">The battery is not being charged.</p> <p data-bbox="372 922 645 946">A warning tone also sounds.</p> <p data-bbox="372 954 568 978">Possible causes are:</p> <ul style="list-style-type: none"> <li data-bbox="384 986 602 1010">• a defective alternator</li> <li data-bbox="384 1018 563 1042">• a torn poly-V-belt</li> <li data-bbox="384 1050 701 1074">• a malfunction in the electronics</li> </ul> <p data-bbox="372 1090 1009 1114"><b>!</b> Do not continue driving. The engine could otherwise overheat.</p> <ul style="list-style-type: none"> <li data-bbox="372 1121 1031 1173">► Pull over and stop the vehicle safely and switch off the engine, paying attention to road and traffic conditions.</li> <li data-bbox="372 1181 908 1204">► Secure the vehicle against rolling away (▷ page 158).</li> <li data-bbox="372 1212 779 1236">► Consult a qualified specialist workshop.</li> </ul>

Display messages	Possible causes/consequences and ► Solutions
 <p>Stop Vehicle See Operator's Manual</p>	<p>The battery is no longer being charged and the condition of charge is too low. A warning tone also sounds.</p> <ul style="list-style-type: none"> <li>► Pull over and stop the vehicle safely and switch off the engine, paying attention to road and traffic conditions.</li> <li>► Secure the vehicle against rolling away (▷ page 158).</li> <li>► Observe the instructions in the  See Operator's Manual display message.</li> <li>► Consult a qualified specialist workshop.</li> </ul>
 <p>Stop Vehicle Leave Engine Running</p>	<p>The battery condition of charge is too low.</p> <ul style="list-style-type: none"> <li>► Pull over and stop the vehicle safely as soon as possible, paying attention to road and traffic conditions. Do not continue driving under any circumstances.</li> <li>► Leave the engine running.</li> <li>► Wait until the display message disappears before pulling away.</li> </ul>
 <p>Start Engine See Operator's Manual</p>	<p>The engine is switched off and the condition of charge is too low.</p> <ul style="list-style-type: none"> <li>► Switch off electrical consumers that you do not need, such as the rear window defroster and interior lighting.</li> <li>► Leave the engine running for a few minutes or drive a long distance. The battery is being charged.</li> </ul>
 <p>Check Engine Oil At Next Refueling</p>	<p>The engine oil level has dropped to the minimum level. A warning tone also sounds.</p> <p><b>!</b> Avoid long journeys with too little engine oil. The engine will otherwise be damaged.</p> <ul style="list-style-type: none"> <li>► Check the oil level when next refueling, at the latest (▷ page 320).</li> <li>► If necessary, add engine oil (▷ page 320).</li> </ul> <p><b>If you have to add engine oil frequently:</b></p> <ul style="list-style-type: none"> <li>► Contact a qualified specialist workshop and have the engine checked.</li> </ul> <p>Information on approved engine oils can be obtained from a qualified specialist workshop or on the Internet at <a href="http://bevo.mercedes-benz.com">http://bevo.mercedes-benz.com</a>.</p>



Display messages	Possible causes/consequences and ► Solutions
 <p>Check Engine Oil Level (Add 1 quart) (USA) Check Engine Oil Level (Add 1 Liter) (Canada)</p>	<p>Mercedes-AMG GLC 63 vehicles: The engine oil level has dropped to the minimum level.</p> <p><b>!</b> Avoid long journeys with too little engine oil. The engine will otherwise be damaged.</p> <ul style="list-style-type: none"> <li>► Check the oil level when next refueling, at the latest (▷ page 320).</li> <li>► If necessary, add engine oil (▷ page 320).</li> </ul> <p><b>If you have to add engine oil frequently:</b></p> <ul style="list-style-type: none"> <li>► Contact a qualified specialist workshop and have the engine checked.</li> </ul> <p>Information on approved engine oils can be obtained from a qualified specialist workshop or on the Internet at <a href="http://bevo.mercedes-benz.com">http://bevo.mercedes-benz.com</a>.</p>
 <p>Engine Oil Level Low Stop Vehicle Turn Engine Off</p>	<p>Mercedes-AMG GLC 63 vehicles: The engine oil level is too low. There is a risk of engine damage.</p> <ul style="list-style-type: none"> <li>► Pull over and stop the vehicle safely and switch off the engine, paying attention to road and traffic conditions.</li> <li>► Secure the vehicle against rolling away (▷ page 158).</li> <li>► Check the engine oil level (▷ page 320).</li> <li>► If necessary, add engine oil (▷ page 320).</li> </ul>
 <p>Engine Oil Level Cannot Be Measured</p>	<p>Mercedes-AMG GLC 63 vehicles: the measuring system is malfunctioning.</p> <ul style="list-style-type: none"> <li>► Visit a qualified specialist workshop.</li> </ul>
 <p>Fuel Level Low</p>	<p>The fuel level has dropped into the reserve range.</p> <ul style="list-style-type: none"> <li>► Refuel at the nearest gas station.</li> </ul>
	<p>There is only a very small amount of fuel in the fuel tank.</p> <ul style="list-style-type: none"> <li>► Refuel at the nearest gas station without fail.</li> </ul>
 <p>Gas Cap Loose</p>	<p>The fuel filler cap is not closed correctly or the fuel system is leaking.</p> <ul style="list-style-type: none"> <li>► Check that the fuel filler cap is correctly closed.</li> </ul> <p><b>If the fuel filler cap is not correctly closed:</b></p> <ul style="list-style-type: none"> <li>► Close the fuel filler cap.</li> </ul> <p><b>If the fuel filler cap is correctly closed:</b></p> <ul style="list-style-type: none"> <li>► Visit a qualified specialist workshop.</li> </ul>

Driving systems	
Display messages	Possible causes/consequences and ► Solutions
 <b>ATTENTION ASSIST:</b> Take a Break!	<p>Based on certain criteria, ATTENTION ASSIST has detected fatigue or a lack of concentration on the part of the driver. A warning tone also sounds.</p> <ul style="list-style-type: none"> <li>► If necessary, take a break.</li> </ul> <p>During long journeys, take regular breaks in good time so you get enough rest.</p>
 <b>ATTENTION ASSIST</b> Inoperative	<p>ATTENTION ASSIST is inoperative.</p> <ul style="list-style-type: none"> <li>► Visit a qualified specialist workshop.</li> </ul>
 <b>Vehicle Rising</b>	<p>The vehicle is rising to the level you have selected.</p>
 <b>Vehicle Rising</b> Please Wait	<p>The vehicle level is too low when the vehicle is stationary. A warning tone also sounds.</p> <ul style="list-style-type: none"> <li>► Do not pull away. The vehicle level is set when the display message disappears.</li> </ul>
 <b>Stop Vehicle Vehi-</b> <b>cle Too Low</b>	<p>You have pulled away while the vehicle level is still too low. AIR BODY CONTROL sets the vehicle to the selected level after a short period.</p> <p>Mercedes-AMG vehicles: the AMG sports suspension based on AIR BODY CONTROL sets the vehicle to the selected level after a short period.</p> <ul style="list-style-type: none"> <li>► Pull over and stop the vehicle safely as soon as possible, paying attention to road and traffic conditions.</li> <li>► Secure the vehicle against rolling away (► page 158).</li> <li>► Wait until the display message disappears before pulling away.</li> </ul> <p>AIR BODY CONTROL is faulty. A warning tone also sounds.</p> <p>Mercedes-AMG vehicles: the AMG sports suspension based on AIR BODY CONTROL is malfunctioning. A warning tone also sounds.</p> <ul style="list-style-type: none"> <li>► Do not drive at speeds above 50 mph (80 km/h).</li> <li>► Make only slight steering movements. Otherwise, the front fender or the tires could be damaged if the steering movement is too large.</li> <li>► Listen for scraping sounds.</li> <li>► Pull over and stop the vehicle safely, paying attention to road and traffic conditions, and set a higher vehicle level. Depending on the malfunction, it may be possible to raise the vehicle.</li> <li>► Visit a qualified specialist workshop.</li> </ul>

Display messages	Possible causes/consequences and ► Solutions
 <p>Drive More Slowly</p>	<p>You cannot change the vehicle level. Possible causes are:</p> <ul style="list-style-type: none"> <li>• You are driving too fast for the selected vehicle level</li> <li>• You are driving too fast with a trailer or the trailer-coupling socket is being used, e.g. for a bicycle rack</li> </ul> <p>► Drive more slowly and then select the desired vehicle level again (► page 185).</p> <p>► Observe the notes on towing a trailer (► page 215).</p>
 <p>Compressor Is Cooling</p>	<p>You have selected a higher vehicle level. The compressor first needs to cool down because of frequent level changes.</p> <p>► Drive in a manner appropriate for the current vehicle level.</p> <p>► Make sure that there is sufficient ground clearance.</p> <p>► Allow the compressor to cool down. When the compressor has cooled down, the display message disappears. The vehicle then continues rising to the selected level.</p>
 <p>Malfunction</p>	<p>AIR BODY CONTROL is malfunctioning. The vehicle's handling characteristics may be affected.</p> <p>Mercedes-AMG vehicles: the AMG sports suspension based on AIR BODY CONTROL is malfunctioning. The vehicle's handling characteristics may be affected.</p> <p>► Drive as appropriate for the current vehicle level, but do not exceed 50 mph (80 km/h).</p> <p>► Make sure that there is sufficient ground clearance.</p> <p>► Visit a qualified specialist workshop.</p>
<p>Lane Keeping Assist Currently Unavailable See Operator's Manual or Active Lane Keeping Assist Currently Unavailable See Operator's Manual</p>	<p>Lane Keeping Assist or Active Lane Keeping Assist is deactivated and temporarily inoperative.</p> <p>Possible causes are:</p> <ul style="list-style-type: none"> <li>• the windshield in the camera's field of vision is dirty</li> <li>• visibility is impaired due to heavy rain, snow or fog</li> <li>• there have been no lane markings for an extended period</li> <li>• the lane markings are worn away, dark or covered up, e.g. by dirt or snow</li> </ul> <p>When the causes stated above no longer apply, the display message disappears.</p> <p>Lane Keeping Assist or Active Lane Keeping Assist is operational again.</p> <p>If the display message does not disappear:</p> <p>► Pull over and stop the vehicle safely as soon as possible, paying attention to road and traffic conditions.</p> <p>► Secure the vehicle against rolling away (► page 158).</p> <p>► Clean the windshield.</p>

Display messages	Possible causes/consequences and ► Solutions
Lane Keeping Assist Inoperative or Active Lane Keeping Assist Inoperative	Lane Keeping Assist or Active Lane Keeping Assist is malfunctioning. ► Visit a qualified specialist workshop.
Blind Spot Assist Currently Unavailable See Operator's Manual or Active Blind Spot Assist Currently Unavailable See Operator's Manual	Blind Spot Assist or Active Blind Spot Assist is temporarily inoperative. Possible causes are: <ul style="list-style-type: none"> <li>• the radar sensor system is outside the operating temperature range</li> <li>• the radar sensor system is temporarily inoperative, e.g. due to electromagnetic radiation emitted by nearby TV or radio stations or other sources of electromagnetic radiation</li> </ul> When the causes stated above no longer apply, the display message disappears. Blind Spot Assist or Active Blind Spot Assist is operational again. If the display message does not disappear: <ul style="list-style-type: none"> <li>► Pull over and stop the vehicle safely as soon as possible, paying attention to road and traffic conditions.</li> <li>► Secure the vehicle against rolling away (▷ page 158).</li> <li>► Restart the engine.</li> </ul>
Blind Spot Assist Inoperative or Active Blind Spot Assist Inoperative	Blind Spot Assist or Active Blind Spot Assist is malfunctioning. ► Visit a qualified specialist workshop.
Parking Pilot Canceled	The driver's door is open. ► Repeat the parking gap measurement and parking process with the driver's door closed.  You touched the multifunction steering wheel while steering intervention was active. ► While steering intervention is active, make sure that the multifunction steering wheel is not touched unintentionally.  The vehicle has started to skid and ESP® has intervened. ► Use Parking Pilot again later (▷ page 188).
Parking Pilot Inoperative	Parking Pilot is malfunctioning or defective. ► Follow the instructions and helpful hints in the "Problems with Parking Assist PARKTRONIC" section (▷ page 194).  If the multifunction display still shows the display message: ► Visit a qualified specialist workshop.





Display messages	Possible causes/consequences and ► Solutions
	<p>Parking Pilot is unavailable or malfunctioning.</p> <p>► Switch off the ignition and restart the engine.</p> <p>If Parking Pilot continues to be unavailable (the <b>P</b> symbol does not appear in the multifunction display):</p> <p>► Visit a qualified specialist workshop.</p>
Parking Pilot Finished	<p>The vehicle is parked. A warning tone also sounds.</p> <p>The display message disappears automatically.</p>
 Inoperative	<p>DSR (Downhill Speed Regulation) is deactivated due to a malfunction.</p> <p>► Have DSR checked at a qualified specialist workshop.</p>
Traffic Sign Assist Currently Unavailable See Operator's Manual	<p>Traffic Sign Assist is temporarily inoperative.</p> <p>Possible causes are:</p> <ul style="list-style-type: none"> <li>• the windshield in the camera's field of vision is dirty</li> <li>• visibility is impaired due to heavy rain, snow or fog</li> </ul> <p>► Clean the windshield.</p> <p>If the system detects that the camera is fully operational, the display message disappears.</p> <p>Traffic Sign Assist is operational again.</p>
Traffic Sign Assist Inoperative	<p>Traffic Sign Assist is malfunctioning.</p> <p>► Visit a qualified specialist workshop.</p>
 Off	<p>The HOLD function is deactivated. The vehicle is skidding.</p> <p>A warning tone also sounds.</p> <p>► Reactivate the HOLD function later (▷ page 179).</p>
	<p>The HOLD function is deactivated. When the brake pedal is firmly depressed, an activation condition is not fulfilled.</p> <p>A warning tone also sounds.</p> <p>► Check the activation conditions for the HOLD function (▷ page 179).</p>
Distance Pilot Off	<p>Distance Pilot DISTRONIC is deactivated (▷ page 176).</p> <p>If it was not deactivated by the driver, a warning tone also sounds.</p>
Distance Pilot Now Available	<p>Distance Pilot DISTRONIC is operational again after having been temporarily unavailable. You can now reactivate Distance Pilot DISTRONIC (▷ page 172).</p>

Display messages	Possible causes/consequences and ► Solutions
<p>Distance Pilot Currently Unavailable See Operator's Manual</p>	<p>Distance Pilot DISTRONIC is temporarily inoperative. Steering Pilot is also temporarily inoperative.</p> <p>Possible causes are:</p> <ul style="list-style-type: none"> <li>• the radar sensor system is temporarily inoperative, e.g. due to electromagnetic radiation emitted by nearby TV or radio stations or other sources of electromagnetic radiation</li> <li>• the system is outside the operating temperature range</li> <li>• the on-board voltage is too low</li> </ul> <p>A warning tone also sounds.</p> <p>When the causes stated above no longer apply, the display message disappears.</p> <p>Distance Pilot DISTRONIC is operational again.</p> <p>If the display message does not disappear:</p> <ul style="list-style-type: none"> <li>► Pull over and stop the vehicle safely as soon as possible, paying attention to road and traffic conditions.</li> <li>► Secure the vehicle against rolling away (▷ page 158).</li> <li>► Restart the engine.</li> </ul>
<p>Distance Pilot Inoperative</p>	<p>Distance Pilot DISTRONIC is malfunctioning.</p> <p>The following may have also failed:</p> <ul style="list-style-type: none"> <li>• Active Brake Assist with cross-traffic function</li> <li>• Steering Pilot</li> </ul> <p>A warning tone also sounds.</p> <ul style="list-style-type: none"> <li>► Visit a qualified specialist workshop.</li> </ul>
<p>Distance Pilot Suspended</p>	<p>You have depressed the accelerator pedal. Distance Pilot DISTRONIC is no longer controlling the speed of the vehicle.</p> <ul style="list-style-type: none"> <li>► Remove your foot from the accelerator pedal.</li> </ul>
<p>Distance Pilot - - - mph</p>	<p>A condition for activating Distance Pilot DISTRONIC has not been met.</p> <ul style="list-style-type: none"> <li>► Check the activation conditions for Distance Pilot DISTRONIC (▷ page 172).</li> </ul>

Display messages	Possible causes/consequences and ► Solutions
<p>Steering Pilot Currently Unavailable See Operator's Manual</p>	<p>Steering Pilot is temporarily inoperative. Possible causes are:</p> <ul style="list-style-type: none"> <li>• the windshield in the camera's field of vision is dirty</li> <li>• visibility is impaired due to heavy rain, snow or fog</li> <li>• there have been no lane markings for an extended period</li> <li>• the lane markings are worn away, dark or covered up, e.g. by dirt or snow</li> </ul> <p>When the causes stated above no longer apply, the display message disappears. Steering Pilot is operational again. If the display message does not disappear:</p> <ul style="list-style-type: none"> <li>► Pull over and stop the vehicle safely as soon as possible, paying attention to road and traffic conditions.</li> <li>► Secure the vehicle against rolling away (▷ page 158).</li> <li>► Clean the windshield.</li> </ul>
<p>Steering Pilot Inoperative</p>	<p>Steering Pilot is malfunctioning. However, the Distance Pilot DISTRONIC functions are still available. A warning tone also sounds.</p> <ul style="list-style-type: none"> <li>► Visit a qualified specialist workshop.</li> </ul>
<p>Cruise Control Inoperative</p>	<p>Cruise control is malfunctioning. A warning tone also sounds.</p> <ul style="list-style-type: none"> <li>► Visit a qualified specialist workshop.</li> </ul>
<p>Cruise Control - - - mph</p>	<ul style="list-style-type: none"> <li>• A condition for activating cruise control has not been met. You have tried to store a speed below 20 mph (30 km/h), for example.</li> <li>• ESP® is deactivated. The yellow ESP® OFF warning lamp is lit.</li> </ul> <p>► If conditions permit, drive faster than 20 mph (30 km/h) and store the speed.</p> <p>or</p> <p>► Check the activation conditions for cruise control (▷ page 169).</p> <p>or</p> <p>► Reactivate ESP® (▷ page 70).</p> <p>or</p> <p>► Reactivate ESP® in Mercedes-AMG vehicles (▷ page 71).</p>
<p>Cruise Control Off</p>	<p>Cruise control has been deactivated. If a warning tone also sounds, cruise control has deactivated automatically (▷ page 169).</p>

Tires	
Display messages	Possible causes/consequences and ► Solutions
Check Tire Pressure Soon	<p>Canada only:</p> <p>The tire pressure loss warning system has detected a significant loss in pressure.</p> <p>A warning tone also sounds.</p> <p>Possible causes:</p> <ul style="list-style-type: none"> <li>• you have changed the positions of the wheels and tires or installed new wheels and tires</li> <li>• the tire pressure in one or more tires has dropped significantly</li> </ul> <p> <b>WARNING</b></p> <p>Tire pressures that are too low pose the following hazards:</p> <ul style="list-style-type: none"> <li>• they may burst, especially as the load and vehicle speed increase.</li> <li>• they may wear excessively and/or unevenly, which may greatly impair tire traction.</li> <li>• the driving characteristics, as well as steering and braking, may be greatly impaired.</li> </ul> <p>There is a risk of an accident.</p> <ul style="list-style-type: none"> <li>► Stop the vehicle without making any sudden steering or braking maneuvers. Pay attention to the traffic conditions as you do so.</li> <li>► Secure the vehicle against rolling away (▷ page 158).</li> <li>► Check the tires and, if necessary, follow the instructions for a flat tire (▷ page 334).</li> <li>► Check the tire pressures and, if necessary, correct the tire pressure.</li> <li>► Restart the tire pressure loss warning system when the tire pressure is correct (▷ page 356).</li> </ul>
Check Tire Pressure Then Restart Run Flat Indicator	<p>Canada only:</p> <p>The tire pressure loss warning system generated a display message and has not been restarted since.</p> <ul style="list-style-type: none"> <li>► Set the correct tire pressure in all four tires.</li> <li>► Restart the tire pressure loss warning system (▷ page 356).</li> </ul>
Run Flat Indicator Inoperative	<p>Canada only:</p> <p>The tire pressure loss warning system is faulty.</p> <ul style="list-style-type: none"> <li>► Visit a qualified specialist workshop.</li> </ul>
Please Correct Tire Pressure	<p>The tire pressure is too low in at least one of the tires, or the tire pressure difference between the wheels is too great.</p> <ul style="list-style-type: none"> <li>► Check the tire pressures at the next opportunity (▷ page 358).</li> <li>► If necessary, correct the tire pressure.</li> <li>► Restart the tire pressure monitor (▷ page 358).</li> </ul>

Display messages	Possible causes/consequences and ► Solutions
<p>Check Tires</p>	<p>The tire pressure in one or more tires has dropped significantly. The wheel position is displayed in the multifunction display. A warning tone also sounds.</p> <p> <b>WARNING</b></p> <p>Tire pressures that are too low pose the following hazards:</p> <ul style="list-style-type: none"> <li>• they may burst, especially as the load and vehicle speed increase.</li> <li>• they may wear excessively and/or unevenly, which may greatly impair tire traction.</li> <li>• the driving characteristics, as well as steering and braking, may be greatly impaired.</li> </ul> <p>There is a risk of an accident.</p> <ul style="list-style-type: none"> <li>► Stop the vehicle without making any sudden steering or braking maneuvers. Pay attention to the traffic conditions as you do so.</li> <li>► Secure the vehicle against rolling away (▷ page 158).</li> <li>► Check the tires and, if necessary, follow the instructions for a flat tire (▷ page 334).</li> <li>► Check the tire pressure (▷ page 358).</li> <li>► If necessary, correct the tire pressure.</li> </ul>
<p>Warning Tire Malfunction</p>	<p>The tire pressure in one or more tires has dropped suddenly. The wheel position is shown in the multifunction display.</p> <p> <b>WARNING</b></p> <p>Driving with a flat tire poses a risk of the following hazards:</p> <ul style="list-style-type: none"> <li>• a flat tire affects the ability to steer or brake the vehicle</li> <li>• you could lose control of the vehicle</li> <li>• continued driving with a flat tire will cause excessive heat build-up and possibly a fire</li> </ul> <p>There is a risk of an accident.</p> <ul style="list-style-type: none"> <li>► Stop the vehicle without making any sudden steering or braking maneuvers. Pay attention to the traffic conditions as you do so.</li> <li>► Secure the vehicle against rolling away (▷ page 158).</li> <li>► Check the tires and, if necessary, follow the instructions for a flat tire (▷ page 334).</li> </ul>
<p>Tire Press. Monitor Currently Unavailable</p>	<p>Because there is interference from a strong source of radio waves, no signals from the tire pressure sensors are detected. The tire pressure monitor is temporarily malfunctioning.</p> <ul style="list-style-type: none"> <li>► Drive on. The tire pressure monitor restarts automatically as soon as the problem has been resolved.</li> </ul>
<p>TirePress. Sensor(s) Missing</p>	<p>There is no signal from the tire pressure sensor of one or several tires. The pressure of the affected tire is not displayed in the multifunction display.</p> <ul style="list-style-type: none"> <li>► Have the faulty tire pressure sensor replaced at a qualified specialist workshop.</li> </ul>







Display messages	Possible causes/consequences and ► Solutions
Tire Pressure Monitor Inoperative No Wheel Sensors	The wheels mounted do not have a suitable tire pressure sensor. The tire pressure monitor is deactivated. ► Mount wheels with suitable tire pressure sensors. The tire pressure monitor is activated automatically after driving for a few minutes.
Tire Press. Monitor Inoperative	The tire pressure monitor is faulty. ► Visit a qualified specialist workshop.
Tires Overheated	The tire temperature monitoring function is not available in all vehicles. At least one tire has overheated. Affected tires are shown in red. At temperatures close to the limit value, the tires are shown in yellow. ► Drive more slowly.
Tires Overheated Decrease Speed	The tire temperature monitoring function is not available in all vehicles. At least one tire has overheated.  <b>WARNING</b> Overheated tires can burst, particularly at high speeds. ► Drive more slowly so that the tires cool down.



### Vehicle

Display messages	Possible causes/consequences and ► Solutions
Shift to 'P' or 'N' to Start Engine	You have attempted to start the engine with the transmission in position <b>R</b> or <b>D</b> . ► Shift the transmission to position <b>P</b> or <b>N</b> .
Apply Brake to Shift from 'P'	You have attempted to shift the transmission to position <b>D</b> , <b>R</b> or <b>N</b> without depressing the brake pedal. ► Depress the brake pedal.
To Deselect P or N, Depress Brake and Start Engine	With the engine switched off, you have attempted to shift the transmission out of position <b>P</b> or <b>N</b> into another transmission position. ► Depress the brake pedal. ► Start the engine.
To Engage Transmiss. Position R First Depress the Brake	You have attempted to shift from position <b>D</b> to position <b>R</b> . ► Depress the brake pedal. ► Shift the transmission to position <b>R</b> .





Display messages	Possible causes/consequences and ► Solutions
<p>Driver's Door Open &amp; Transmission Not in P Risk of Vehicle Rolling Away</p>	<p>The driver's door is open or not fully closed and the transmission is in position <b>R</b>, <b>N</b> or <b>D</b>. A warning tone also sounds.</p> <p> <b>WARNING</b></p> <p>The vehicle may roll away. There is a risk of an accident.</p> <ul style="list-style-type: none"> <li>► Shift the transmission to position <b>P</b>.</li> <li>► Secure the vehicle against rolling away (▷ page 158).</li> <li>► Close the driver's door completely.</li> </ul>
<p>Only Shift to 'P' when Vehicle is Stationary</p>	<p>The vehicle is moving.</p> <ul style="list-style-type: none"> <li>► Pull over and stop the vehicle safely as soon as possible, paying attention to road and traffic conditions.</li> <li>► Shift the transmission to position <b>P</b>.</li> </ul>
<p>Service Required Do Not Shift Gears Visit Dealer</p>	<p>You cannot change the transmission position due to a malfunction. A warning tone also sounds.</p> <p>If transmission position <b>D</b> is selected:</p> <ul style="list-style-type: none"> <li>► Drive to a qualified specialist workshop without shifting the transmission from position <b>D</b>.</li> </ul> <p>If transmission position <b>R</b>, <b>N</b> or <b>P</b> is selected:</p> <ul style="list-style-type: none"> <li>► Secure the vehicle against rolling away (▷ page 158).</li> <li>► Notify a qualified specialist workshop or breakdown service.</li> </ul>
<p>Reversing Not Possible Service Required</p>	<p>You cannot shift into transmission position <b>R</b> due to a malfunction. The transmission positions <b>P</b>, <b>N</b> or <b>D</b> continue to be available. A warning tone also sounds.</p> <ul style="list-style-type: none"> <li>► Visit a qualified specialist workshop.</li> </ul>
<p>Transmission Malfunction Stop</p>	<p>A malfunction has occurred in the mechanical transmission components. A warning tone also sounds. The transmission automatically shifts to position <b>N</b>.</p> <ul style="list-style-type: none"> <li>► Pull over and stop the vehicle safely as soon as possible, paying attention to road and traffic conditions.</li> <li>► Shift the transmission to position <b>P</b>.</li> <li>► Secure the vehicle against rolling away (▷ page 158).</li> <li>► Notify a qualified specialist workshop or breakdown service.</li> </ul>







Display messages	Possible causes/consequences and ► Solutions
<p>Stop Vehicle Leave Engine Running Wait Transmission Cooling</p>	<p>The transmission has overheated. Pulling away can be temporarily impaired or not possible.</p> <ul style="list-style-type: none"> <li>► Pull over and stop the vehicle safely as soon as possible, paying attention to road and traffic conditions. Do not continue driving under any circumstances.</li> <li>► Leave the engine running.</li> <li>► Wait until the display message disappears before pulling away.</li> </ul>
	<p>The tailgate is open</p> <p> <b>WARNING</b></p> <p>When the engine is running, exhaust gases can enter the vehicle interior if the tailgate is open. There is a risk of poisoning.</p> <ul style="list-style-type: none"> <li>► Close the tailgate.</li> </ul>
	<p>The hood is open. A warning tone also sounds.</p> <p> <b>WARNING</b></p> <p>The open hood may block your view when the vehicle is in motion. There is a risk of an accident.</p> <ul style="list-style-type: none"> <li>► Pull over and stop the vehicle safely as soon as possible, paying attention to road and traffic conditions.</li> <li>► Secure the vehicle against rolling away (► page 158).</li> <li>► Close the hood.</li> </ul>
	<p>At least one door is open. A warning tone also sounds.</p> <ul style="list-style-type: none"> <li>► Close all the doors.</li> </ul>
 <p>Rear Left Backrest Not Latched or Rear Right Backrest Not Latched</p>	<p>Vehicle with through-loading feature in the rear bench seat: The backrest in the rear is not engaged on the left-hand and/or right-hand side.</p> <ul style="list-style-type: none"> <li>► Push the backrest back until it engages.</li> </ul>
 <p>Rear Center Backrest Not Engaged</p>	<p>Vehicle with through-loading facility in the rear compartment: The center rear seat backrest is not engaged.</p> <ul style="list-style-type: none"> <li>► Push the backrest back until it engages.</li> </ul>

Display messages	Possible causes/consequences and ► Solutions
 <p>Power Steering Malfunction See Operator's Manual</p>	<p>The power steering is malfunctioning. A warning tone also sounds.</p> <p> <b>WARNING</b></p> <p>You will need to use more force to steer. There is a risk of an accident.</p> <p>► Check whether you are able to apply the extra force required.</p> <p><b>If you are able to steer safely:</b></p> <ul style="list-style-type: none"> <li>► Drive on carefully.</li> <li>► Visit a qualified specialist workshop immediately.</li> </ul> <p><b>If you are unable to steer safely:</b></p> <ul style="list-style-type: none"> <li>► Do not drive on.</li> <li>► Consult a qualified specialist workshop.</li> </ul>
<p>Phone No Service</p>	<p>Your vehicle is outside the network provider's transmitter/receiver range.</p> <p>► Wait until the mobile phone operational readiness symbol appears in the multifunction display.</p>
 <p>Check Washer Fluid</p>	<p>The washer fluid level in the washer fluid reservoir has dropped below the minimum.</p> <p>► Add washer fluid (&gt; page 322).</p>

## SmartKey

Display messages	Possible causes/consequences and ► Solutions
 <p>Key Does Not Belong to Vehicle</p>	<p>You have put the wrong SmartKey in the ignition lock.</p> <p>► Use the correct SmartKey.</p>
 <p>Take Your Key from Ignition</p>	<p>The SmartKey is in the ignition lock. A warning tone sounds</p> <p>► Remove the SmartKey.</p>
 <p>Obtain a New Key</p>	<p>The SmartKey needs to be replaced.</p> <p>► Visit a qualified specialist workshop.</p>
 <p>Replace Key Battery</p>	<p>The SmartKey battery is discharged.</p> <p>► Change the batteries (&gt; page 81).</p>

Display messages	Possible causes/consequences and ► Solutions
 <p>Don't Forget Your Key</p>	<p>The SmartKey is not in the ignition lock. You have opened the driver's door with the engine switched off. A warning tone sounds</p> <p>This display message is displayed for a maximum of 60 seconds and is simply a reminder.</p> <ul style="list-style-type: none"> <li>► Take the SmartKey with you when you leave the vehicle.</li> </ul>
 <p>Key Not Detected (white display message)</p>	<p>The SmartKey is currently undetected.</p> <ul style="list-style-type: none"> <li>► Change the location of the SmartKey in the vehicle.</li> </ul> <p>If the SmartKey still cannot be detected:</p> <ul style="list-style-type: none"> <li>► Insert the SmartKey into the ignition lock and turn it to the desired position.</li> </ul>
 <p>Key Not Detected (red display message)</p>	<p>The SmartKey is not in the vehicle. A warning tone also sounds.</p> <p>If the engine is switched off, you can no longer lock the vehicle centrally or start the engine.</p> <ul style="list-style-type: none"> <li>► Pull over and stop the vehicle safely as soon as possible, paying attention to road and traffic conditions.</li> <li>► Secure the vehicle against rolling away (▷ page 158).</li> <li>► Locate the SmartKey.</li> <li>► Press <b>OK</b> on the steering wheel to confirm the display message.</li> </ul> <p>Because there is interference from a strong source of radio waves, the SmartKey is not detected whilst the engine is running. A warning tone also sounds.</p> <ul style="list-style-type: none"> <li>► Pull over and stop the vehicle safely as soon as possible, paying attention to road and traffic conditions.</li> <li>► Secure the vehicle against rolling away (▷ page 158).</li> <li>► Insert the SmartKey into the ignition lock and drive in SmartKey mode.</li> </ul>
 <p>Remove 'Start' Button and Insert Key</p>	<p>The SmartKey is continually undetected.</p> <p>The SmartKey detection function has a temporary malfunction or is faulty. A warning tone also sounds.</p> <ul style="list-style-type: none"> <li>► Insert the SmartKey into the ignition lock and turn it to the desired position.</li> <li>► Visit a qualified specialist workshop.</li> </ul>





## Warning and indicator lamps in the instrument cluster

### General notes

Some systems carry out a self-diagnosis when the ignition is switched on. Therefore, some indicator and warning lamps may light up or flash temporarily. This behavior is non-critical. These indicator and warning lamps only indicate a malfunction if they light up or flash after starting the engine or whilst driving.

## Safety

## Seat belts

Warning/ indicator lamp	▷ Signal type Possible causes/consequences and ▶ Solutions
	<p>▷ After starting the engine, the red seat belt warning lamp lights up for six seconds.</p> <p>The seat belt warning lamp reminds the driver and front passenger to fasten their seat belts.</p> <p>▶ Fasten your seat belt (▷ page 48).</p>
	<p>▷ After starting the engine, the red seat belt warning lamp lights up. In addition, a warning tone sounds for up to six seconds.</p> <p>The driver's seat belt is not fastened.</p> <p>▶ Fasten your seat belt (▷ page 48). The warning tone ceases.</p>
	<p>▷ The red seat belt warning lamp lights up after the engine starts, as soon as the driver's or the front-passenger door is closed.</p> <p>The driver or front passenger has not fastened their seat belt.</p> <p>▶ Fasten your seat belt (▷ page 48). The warning lamp goes out.</p> <p>There are objects on the front-passenger seat.</p> <p>▶ Remove the objects from the front-passenger seat and stow them in a secure place. The warning lamp goes out.</p>
	<p>▷ The red seat belt warning lamp flashes and an intermittent audible warning sounds.</p> <p>The driver or front passenger has not fastened their seat belt. The vehicle is being driven faster than 15 mph (25 km/h) or has briefly been driven faster than 15 mph (25 km/h).</p> <p>▶ Fasten your seat belt (▷ page 48). The warning lamp goes out and the intermittent warning tone ceases.</p> <p>There are objects on the front-passenger seat. The vehicle is being driven faster than 15 mph (25 km/h) or has briefly been driven faster than 15 mph (25 km/h).</p> <p>▶ Remove the objects from the front-passenger seat and stow them in a secure place. The warning lamp goes out and the intermittent warning tone ceases.</p>

## Safety systems

Warning/  
indicator  
lamp

## ▷ Signal type

## Possible causes/consequences and ► Solutions



▷ (USA only), (Canada only): the red brake system warning lamp is lit while the engine is running.  
A warning tone also sounds.

**WARNING**

The brake boosting effect is malfunctioning and the braking characteristics may be affected.

There is a risk of an accident.

- Pull over and stop the vehicle safely as soon as possible, paying attention to road and traffic conditions. Do not continue driving under any circumstances.
- Secure the vehicle against rolling away (▷ page 158).
- Consult a qualified specialist workshop.
- Observe the additional display messages in the multifunction display.



▷ (USA only), (Canada only): the red brake system warning lamp lights up while the engine is running.

A warning tone also sounds.

There is not enough brake fluid in the brake fluid reservoir.

**WARNING**

The braking effect may be impaired.







There is a risk of an accident.

- Pull over and stop the vehicle safely as soon as possible, paying attention to road and traffic conditions. Do not continue driving under any circumstances.
- Secure the vehicle against rolling away (▷ page 158).
- Do not add brake fluid. Adding more will not correct the malfunction.
- Consult a qualified specialist workshop.
- Observe the additional display messages in the multifunction display.



▷ USA only: the red brake system warning lamp is lit while the engine is running. The multifunction display also shows a display message with the symbol.  
The brake pads/linings have reached their wear limit.

- Visit a qualified specialist workshop.

Warning/ indicator lamp	▷ Signal type Possible causes/consequences and ▶ Solutions
	<p>▷ The yellow ABS warning lamp is lit while the engine is running. ABS (anti-lock braking system) is malfunctioning. If there is an additional warning tone, the EBD (electronic brake force distribution) is malfunctioning. Other driving systems and driving safety systems may also malfunction.</p> <p> <b>WARNING</b></p> <p>The brake system continues to function normally, but without the functions listed above. The front and rear wheels could therefore lock if you brake hard, for example. The steerability and braking characteristics may be severely affected. The braking distance in an emergency braking situation can increase. If ESP® is not operational, ESP® is unable to stabilize the vehicle. There is an increased risk of skidding and an accident.</p> <ul style="list-style-type: none"> <li>▶ Observe the additional display messages in the multifunction display.</li> <li>▶ Drive on carefully.</li> <li>▶ Visit a qualified specialist workshop immediately.</li> </ul> <p>If the ABS control unit is faulty, there is also a possibility that other systems, such as the navigation system or the automatic transmission, will not be available.</p>
 	<p>▷  (USA only),  (Canada only): the red brake warning lamp and the yellow ESP® and ABS warning lamps are lit while the engine is running. ABS and ESP® are malfunctioning. Other driving systems and driving safety systems may also malfunction.</p> <p> <b>WARNING</b></p> <p>The brake system continues to function normally, but without the functions listed above. The front and rear wheels could therefore lock if you brake hard, for example. The steerability and braking characteristics may be severely affected. The braking distance in an emergency braking situation can increase. If ESP® is not operational, ESP® is unable to stabilize the vehicle. There is an increased risk of skidding and an accident.</p> <ul style="list-style-type: none"> <li>▶ Observe the additional display messages in the multifunction display.</li> <li>▶ Drive on carefully.</li> <li>▶ Visit a qualified specialist workshop immediately.</li> </ul>

Warning/  
indicator  
lamp

## ▷ Signal type

## Possible causes/consequences and ► Solutions



▷ The yellow ESP<sup>®</sup> warning lamp flashes while the vehicle is in motion. ESP<sup>®</sup> or traction control has intervened because there is a risk of skidding or at least one wheel has started to spin.

Cruise control or Distance Pilot DISTRONIC is deactivated.

- ▶ When pulling away, only depress the accelerator pedal as far as necessary.
- ▶ Ease off the accelerator pedal while the vehicle is in motion.
- ▶ Adapt your driving style to suit the road and weather conditions.
- ▶ Do not deactivate ESP<sup>®</sup>.

In exceptional cases, it may be better to deactivate ESP<sup>®</sup>:

- when using snow chains
- in deep snow
- on sand or gravel
- when driving off-road (vehicles without off-road program)

Observe the important safety notes on ESP<sup>®</sup> (▷ page 70).



▷ The yellow ESP<sup>®</sup> warning lamp is lit while the engine is running.

ESP<sup>®</sup> is malfunctioning.

Other driving systems and driving safety systems may also malfunction.

**WARNING**

The brake system continues to function normally, but without the functions listed above.

The braking distance in an emergency braking situation can thus increase.

If ESP<sup>®</sup> is not operational, ESP<sup>®</sup> is unable to stabilize the vehicle.

There is an increased risk of skidding and an accident.

- ▶ Observe the additional display messages in the multifunction display.
- ▶ Drive on carefully.
- ▶ Visit a qualified specialist workshop immediately.



**Warning/  
indicator  
lamp****▷ Signal type  
Possible causes/consequences and ► Solutions**

▷ The yellow ESP® OFF warning lamp is lit while the engine is running or the ECO start/stop function is activated.

ESP® is deactivated.

**⚠ WARNING**

If ESP® is switched off, ESP® is unable to stabilize the vehicle.

Further driving systems or driving safety systems are thus restricted, e.g. Active Blind Spot Assist. The system does not perform braking actions.

There is an increased risk of skidding and an accident.

**► Reactivate ESP®.**

In exceptional cases, it may be better to deactivate ESP®:

- when using snow chains
- in deep snow
- on sand or gravel
- when driving off-road (vehicles without off-road program)

Observe the important safety notes on ESP® (▷ page 70).

**► Adapt your driving style to suit the road and weather conditions.**

If ESP® cannot be activated:

- Drive on carefully.
- Contact a qualified specialist workshop and have ESP® checked.



▷ Mercedes-AMG vehicles:

The yellow SPORT handling mode warning lamp is lit while the engine is running. SPORT handling mode is activated.

**⚠ WARNING**

When SPORT handling mode is switched on, ESP® is unable to stabilize the vehicle. There is an increased risk of skidding and an accident.

- Only activate SPORT handling mode in accordance with the conditions described in the "Activating/deactivating ESP®" section (▷ page 71).

**Warning/  
indicator  
lamp****▷ Signal type****Possible causes/consequences and ► Solutions**

▷ (USA only), (Canada only): the red indicator lamp for the electric parking brake flashes or is lit and/or the yellow warning lamp for the electric parking brake is lit.

► Observe the additional display messages in the multifunction display.



▷ The red restraint system warning lamp is lit while the engine is running. The restraint system is malfunctioning.

**⚠ WARNING**

The air bags or Emergency Tensioning Devices may either be triggered unintentionally or, in the event of an accident, may not be triggered.

There is an increased risk of injury.

- Observe the additional display messages in the multifunction display.
- Drive on carefully.
- Contact a qualified specialist workshop and have the restraint system checked.

For further information about the restraint system, see (▷ page 44).

**Engine****Warning/  
indicator  
lamp****▷ Signal type****Possible causes/consequences and ► Solutions**

▷ The yellow Check Engine warning lamp lights up while the engine is running. There may be a malfunction, for example:

- in the engine management
- in the fuel injection system
- in the exhaust system
- in the ignition system (for vehicles with gasoline engines)
- in the fuel system

The emission limit values may be exceeded and the engine may be in emergency mode.

► Visit a qualified specialist workshop immediately.



In some states, you must immediately visit a qualified specialist workshop as soon as the yellow Check Engine warning lamp lights up. This is due to the legal requirements in effect in these states. If in doubt, check whether such legal regulations apply in the state in which you are currently driving.

► Start the engine three to four times after refueling.  
If the yellow Check Engine warning lamp goes out, emergency running mode is canceled. The vehicle need not be checked.



▷ The yellow reserve fuel warning lamp lights up while the engine is running. The fuel level has dropped into the reserve range.

► Refuel at the nearest gas station.

Warning/ indicator lamp	▷ Signal type Possible causes/consequences and ▶ Solutions
	<p>▷ The yellow reserve fuel warning lamp flashes while the vehicle is in motion. In addition, the  Check Engine warning lamp may light up. The fuel filler cap is not closed correctly or the fuel system is leaking.</p> <ul style="list-style-type: none"><li>▶ Check that the fuel filler cap is correctly closed.</li><li>▶ <b>If the fuel filler cap is not correctly closed:</b> close the fuel filler cap.</li><li>▶ <b>If the fuel filler cap is closed:</b> visit a qualified specialist workshop.</li></ul>
	<p>▷ The red coolant warning lamp lights up while the engine is running and the coolant temperature gage is at the start of the scale. The temperature sensor for the coolant temperature gage is malfunctioning. The coolant temperature is no longer being monitored. There is a risk of engine damage if the coolant temperature is too high.</p> <ul style="list-style-type: none"><li>▶ Pull over and stop the vehicle safely and switch off the engine, paying attention to road and traffic conditions. Do not continue driving under any circumstances.</li><li>▶ Secure the vehicle against rolling away (▷ page 158).</li><li>▶ Consult a qualified specialist workshop.</li></ul>

Warning/  
indicator  
lamp

## ▷ Signal type

## Possible causes/consequences and ► Solutions



▷ The red coolant warning lamp comes on while the engine is running.

The coolant level is too low.

If the coolant level is correct, the airflow to the engine radiator may be blocked or the electric engine radiator fan may be defective.

The coolant is too hot and the engine is no longer being cooled sufficiently.

- ▶ Observe the additional display messages in the multifunction display.
- ▶ Pull over and stop the vehicle safely and switch off the engine, paying attention to road and traffic conditions.
- ▶ Secure the vehicle against rolling away (▷ page 158).
- ▶ Leave the vehicle and keep a safe distance from the vehicle until the engine has cooled down.
- ▶ Check the coolant level and add coolant, observing the warning notes (▷ page 322).
- ▶ If you have to add coolant frequently, have the engine cooling system checked.
- ▶ Make sure that the air supply to the engine radiator is not blocked, e.g. by snow, slush or ice.
- ▶ Do not start the engine again until the coolant temperature gage is below the red marking. Otherwise, the engine could be damaged.
- ▶ Drive to the nearest qualified specialist workshop.
- ▶ Avoid heavy loads on the engine as you do so, e.g. driving in mountainous terrain and stop-and-go traffic.



▷ The red coolant warning lamp comes on while the engine is running. A warning tone also sounds.

The coolant temperature gage has reached the red marking. The airflow to the engine radiator may be blocked or the coolant level may be too low.

**WARNING**

The engine is not being cooled sufficiently and may be damaged.

Do not drive when your engine is overheated. This can cause some fluids which may have leaked into the engine compartment to catch fire.

Steam from the overheated engine can also cause serious burns which can occur just by opening the hood.

There is a risk of injury.

- ▶ Observe the additional display messages in the multifunction display.
- ▶ Pull over and stop the vehicle safely and switch off the engine, paying attention to road and traffic conditions.
- ▶ Secure the vehicle against rolling away (▷ page 158).
- ▶ Leave the vehicle and keep a safe distance from the vehicle until the engine has cooled down.
- ▶ Check the coolant level and add coolant, observing the warning notes (▷ page 322).
- ▶ If you have to add coolant frequently, have the engine cooling system checked.
- ▶ Make sure that the air supply to the engine radiator is not blocked, e.g. by snow, slush or ice.

<b>Warning/ indicator lamp</b>	<p>▷ <b>Signal type</b>  <b>Possible causes/consequences and ▶ Solutions</b></p>
	<ul style="list-style-type: none"> <li>▶ If the coolant temperature is below the red marking, drive to the nearest qualified specialist workshop.</li> <li>▶ Avoid heavy loads on the engine as you do so, e.g. driving in mountainous terrain and stop-and-go traffic.</li> </ul>

## Driving systems

<b>Warning/ indicator lamp</b>	<p>▷ <b>Signal type</b>  <b>Possible causes/consequences and ▶ Solutions</b></p>
	<p>▷ The red distance warning lamp lights up while the vehicle is in motion. A warning tone also sounds.</p> <p>You are approaching a vehicle, a pedestrian or a stationary obstacle in your line of travel at too high a speed.</p> <ul style="list-style-type: none"> <li>▶ Be prepared to brake immediately.</li> <li>▶ Pay careful attention to the traffic situation. You may have to brake or take evasive action.</li> </ul> <p>Further information about Active Brake Assist with cross-traffic function (▷ page 73).</p> <p>Further information on the distance warning function of Active Brake Assist (▷ page 67).</p>

## Tires

Warning/  
indicator  
lamp

## ▷ Signal type

## Possible causes/consequences and ► Solutions



▷ The yellow tire pressure monitor warning lamp (pressure loss/malfunction) is lit. The tire pressure monitor has detected a loss of pressure in at least one of the tires.

 **WARNING**

Tire pressures that are too low pose the following hazards:

- they may burst, especially as the load and vehicle speed increase
  - they may wear excessively and/or unevenly, which may greatly impair tire traction
  - the driving characteristics, as well as steering and braking, may be greatly impaired
- There is a risk of an accident.
- ▶ Stop the vehicle without making any sudden steering or braking maneuvers. Pay attention to the traffic conditions as you do so.
  - ▶ Secure the vehicle against rolling away (▷ page 158).
  - ▶ Observe the additional display messages in the multifunction display.
  - ▶ Check the tires and, if necessary, follow the instructions for a flat tire (▷ page 334).
  - ▶ Check the tire pressure (▷ page 358).
  - ▶ If necessary, correct the tire pressure.





▷ The yellow tire pressure monitor warning lamp (pressure loss/malfunction) flashes for approximately one minute and then remains lit.

The tire pressure monitor is malfunctioning.

 **WARNING**

The system is possibly unable to recognize or register low tire pressure. There is a risk of an accident.

- ▶ Observe the additional display messages in the multifunction display.
- ▶ Visit a qualified specialist workshop immediately.

Vehicle	
Warning/ indicator lamp	▷ Signal type Possible causes/consequences and ▶ Solutions
	<p>▷ The red power steering warning lamp is lit while the engine is running. The power steering is malfunctioning. A warning tone also sounds.</p> <p> <b>WARNING</b></p> <p>You will need to use more force to steer. There is a risk of an accident.</p> <p>▶ Check whether you are able to apply the extra force required.</p> <p><b>If you are able to steer safely:</b></p> <ul style="list-style-type: none"><li>▶ Drive on carefully.</li><li>▶ Visit a qualified specialist workshop immediately.</li></ul> <p><b>If you are unable to steer safely:</b></p> <ul style="list-style-type: none"><li>▶ Do not drive on.</li><li>▶ Consult a qualified specialist workshop.</li></ul>



### General notes

The multimedia system section in this Operator's Manual describes the basic principles for operation. More information can be found in the Digital Operator's Manual.

### Important safety notes

#### WARNING

If you operate information systems and communication equipment integrated in the vehicle when driving, you may be distracted from the traffic situation. You could also lose control of the vehicle. There is a risk of an accident.

Only operate this equipment when the traffic situation permits. If you are not sure that this is possible, park the vehicle paying attention to traffic conditions and operate the equipment when the vehicle is stationary.

You must observe the legal requirements for the country in which you are currently driving when operating the multimedia system.

The multimedia system calculates the route to the destination without taking the following into account, for example:

- traffic lights
- stop and yield signs
- parking or stopping restrictions
- road narrowing
- other road and traffic rules and regulations

The multimedia system may give incorrect navigation recommendations if the actual street/traffic situation does not correspond with the digital map's data.

For example:

- a diverted route
- the road layout or the direction of a one-way street has been changed

For this reason, you must always observe road and traffic rules and regulations during your journey. Road and traffic rules and regulations always have priority over multimedia system driving recommendations.

Navigation announcements are intended to direct you while driving without diverting your attention from the road and driving.

Please always use this feature instead of consulting the map display for directions. Looking at the icons or map display can distract you from traffic conditions and driving, and increase the risk of an accident.

This equipment complies with FCC radiation exposure limits set forth for uncontrolled equipment and meets the FCC radio frequency (RF) Exposure Guidelines in Supplement C to OET65.

This equipment has very low levels of RF energy that is deemed to comply without maximum permissive exposure evaluation (MPE). However, it is recommended to install it at a distance of at least 8 inches (approx. 20 cm) between the radiation source and a person's body (not including limbs such as hands, wrists, feet and legs).

#### WARNING

Modifications to electronic components, their software as well as wiring can impair their function and/or the function of other networked components. In particular, systems relevant to safety could also be affected. As a result, these may no longer function as intended and/or jeopardize the operating safety of the vehicle. There is an increased risk of an accident and injury.

Never tamper with the wiring as well as electronic components or their software. You should have all work to electrical and electronic equipment carried out at a qualified specialist workshop.

### Function restrictions

For safety reasons, some functions are restricted or unavailable while the vehicle is in motion. You will notice this, for example, because either you will not be able to select certain menu items or a message will appear to this effect.

## Operating system

### Overview

#### General notes

Wearing polarized sunglasses may impair your ability to read the display.

The display has an automatic temperature-controlled switch-off feature. The brightness is automatically reduced if the temperature is too high. The display may temporarily switch off completely.

#### Cleaning instructions

**!** Do not touch the display. The display has a very sensitive high-gloss surface; there is a risk of scratching. If you have to clean the screen, however, use a mild cleaning agent and a soft, lint-free cloth.

The display must be switched off and have cooled down before you start cleaning. Do not apply pressure to the display surface when cleaning it, as this could cause irreversible damage to the display.

#### Switching the multimedia system on/off

▶ Press the  button on the center console to the right of the controller.

#### Adjusts the volume

▶ Turn the thumbwheel to the right of the controller.

The volume is adjusted:

- for the currently selected media source
- during traffic or navigation announcements
- in hands-free mode during a phone call

#### Switching the sound on or off

▶ Press the thumbwheel to the right of the controller.

or

▶ Press the  button on the multifunction steering wheel.

If the audio output is switched off, the status line will show the  symbol. If you switch the media source or change the volume, the sound is automatically switched on.

**i** Navigation announcements will be heard even if the sound is muted.

#### Functions

The multimedia system has the following functions:





- Radio mode
- Media mode with media search
- Sound system
- Navigation system
  - COMAND: navigation via the hard drive
  - Audio 20: navigation via SD card
- Communication functions
- SIRIUS Weather (COMAND)
- Vehicle functions with system settings
- Favorites functions

#### Controller

The controller in the center console lets you:

- select menu items on the display
- enter characters
- select a destination on the map
- save entries

The controller can be:

- turned 
- slid left or right 
- slid forwards or back 
- slid diagonally 
- pressed briefly or pressed and held 

#### Back button

You can use the  button to exit a menu or to call up the display of the current operating mode.

▶ **To exit the menu:** briefly press the  button.

The multimedia system changes to the next higher menu level in the current operating mode.

▶ **To call up the highest level menu:** press the  button for longer than two seconds.

## Touchpad

### Switching the touchpad on/off

Multimedia system:

- ▶ Select **Vehicle** → **System Settings** → **Touchpad** → **Activate Touchpad**.

The touchpad is switched on  or off .

### Operating the touchpad



- ① Touch-sensitive surface
- ② Favorites button
- ③ Calls up quick access for audio
- ④ Back button

Navigating in menus and lists can be done via touch-sensitive surface ① by **swiping with your finger**.

- ▶ **To select the menu item:** swipe up, down, to the left or right.
- ▶ Press the touchpad.
- ▶ **To move the digital map:** swipe in all directions.

**Swiping with two fingers**, e.g. using this function:

- ▶ **To show or hide the audio menu:** swipe up or down with two fingers.
- ▶ **To increase or reduce the vehicle and sound settings:** turn two fingers to the right or left.
- ▶ **To zoom in and out of the map:** move two fingers together or apart.

## Character entry with handwriting recognition

### Entering characters

- ▶ Use one finger to write characters on the surface.  
The character is entered in the input line. If the character that you have entered can be interpreted in different ways, these character suggestions are displayed.
- ▶ If character suggestions are shown, turn and press the controller.
- ▶ Resume the character entry on the touchpad.

### Handwriting recognition



Example: COMAND

- ① Active input line
- ② Inserts a space
- ③ Character entered on the touchpad
- ④ Deletes characters

- ▶ **To display the menu:** press the touchpad.



Example: COMAND

- ① To exit the menu
- ② To return to handwriting recognition
- ③ To use the phone book or text templates
- ④ To select the input line or changes the position of the cursor

- ⑤ To switch the language
- ⑥ To finish character entry

- ▶ **To select the input line:** select **[T/]**.
- ▶ Swipe up or down.
- ▶ **To move the cursor within the input line:** select **[T/]**.
- ▶ Swipe to the left or right.
- ▶ **To delete characters:** swipe to the left if an input line is selected.
- ▶ **To confirm the entry:** press the touchpad.

### Switching the text reader function of the handwriting recognition on/off

Multimedia system:

- ▶ Select **Vehicle** → **System Settings** → **Touchpad** → **Read Out Handwriting Recognition**.  
The read-aloud function is switched on  or off .

### Quick access for audio

#### Changing the station/music track



Depending on the audio source that is currently activated, you can use this function to select the next station or music track.

- ▶ Swipe upwards with two fingers on the touchpad.  
The current audio source is displayed.
- ▶ **To select the previous or next station/music track:** glide to the right or left.  
The selected station/music track is played.

### Switching the character entry between touchpad and controller

Requirement: an input line for text, numbers or characters has been selected.

- ▶ **To switch to the controller:** press the controller.  
Character entry using the controller is active.
- ▶ **To switch to the touchpad:** press the touchpad with your finger.  
Handwriting recognition on the touchpad is active.

### Favorites

#### Calling up and exiting favorites

- ▶ **To call up:** press the **[★]** button on the controller or on the touchpad.
- ▶ Select a favorite, e.g. **Vehicle**.  
The favorites are displayed.
- ▶ **To exit:** press the **[★]** button again.

#### Adding favorites

##### Adding predefined favorites



Example: favorites arranged in one row

- ① Adds a new favorite
- ② Renames a selected favorite
- ③ Moves a selected favorite
- ④ Deletes a selected favorite
- ▶ Press the **[★]** button.  
The favorites are displayed.  
These are arranged in either one or two rows, each with five tiles.
- ▶ **Favorites are arranged in one row:** slide **⊙↓** the controller.  
The menu bar is shown.
- ▶ Select **Reassign**.  
The categories are displayed.
- ▶ Select a category.  
The favorites are displayed.
- ▶ Select a favorite.

- ▶ Add a favorite at the desired position.  
If a favorite has already been added at this position, it will be overwritten.
- ▶ **Favorites are arranged in one row:** slide  $\odot\downarrow$  or  $\uparrow\odot$  the controller.
- ▶ To select  $\boxed{+}$  **Add:** turn and press the controller.  
The categories and predefined favorites are displayed.
- ▶ Select a category.  
The favorites are displayed.
- ▶ Select a favorite.
- ▶ Add a favorite at the desired position.  
If a favorite has already been added at this position, it will be overwritten.

### Adding your own favorites

- ▶ Select **Vehicle** → **Climate Control**.
- ▶ Press and hold the  $\boxed{\star}$  button until the favorites are displayed.
- ▶ Add a favorite at the desired position.  
If a favorite has already been added at this position, it will be overwritten.

## Climate control settings

### General notes

You can adjust the climate control settings using the climate control bar or the climate control menu.

Important climate control functions can be set in the climate control bar:

- Temperature
- Airflow
- Air distribution

The climate control bar is visible in most displays.

You can find all available climate control functions in the climate control menu. You can use the climate control bar to switch to the climate control menu.

### Overview



Climate control bar (COMAND)

- ① Adjusts temperature, air distribution on the left and airflow, displays the current settings
- ② Calls up the climate control menu, displays the current cooling and climate mode settings
- ③ Adjusts temperature and air distribution on the right, displays the current settings

There may be fewer settings or none depending on your vehicle's equipment.

### Calling up the climate control bar

Multimedia system:

- ▶ Select **Vehicle**.  
The vehicle menu is displayed.
- ▶ Slide  $\odot\downarrow$  the controller repeatedly until the climate control bar is activated.

### Calling up the climate control menu

Multimedia system:

- ▶ Select **Vehicle**.  
The vehicle menu is displayed.
- ▶ Slide  $\odot\downarrow$  the controller repeatedly until the climate control bar is activated.
- ▶ To select from climate control bar ②: turn and press the controller.  
The menu for selecting the climate control function is activated.
- ▶ To select the climate control function: turn and press the controller.  
The selected climate control function appears.

## Settings in the climate menu

### Adjusting the climate mode settings

The climate mode determines the type of air-flow. The setting is active when the air-conditioning system is set to **Auto** (▷ page 128).

- ▶ Call up the climate control menu (▷ page 284).
- ▶ To select **Climate Mode**: turn and press the controller.
- ▶ To change the setting: turn the controller.
- ▶ **To exit the menu**: press the  button.

The climate mode bar displays the current air-flow setting: **DIFFUSE**, **MEDIUM** or **FOCUS**.

### Starting/stopping the perfume atomizer

The perfume atomizer makes it possible to scent the air in individual compartments in the vehicle interior. Further information (▷ page 132).

- ▶ Call up the climate control menu (▷ page 284).
- ▶ To select **Air Freshener**: turn and press the controller.  
The setting element is active.
- ▶ To start/stop the perfume atomizer: press the controller.
- ▶ To set the intensity: turn the controller when the atomizer is switched on.
- ▶ **To exit the menu**: press the  button.

### Switching the ionization on/off

The ionization has a cleansing effect on the air in the vehicle interior. Further information (▷ page 133).

- ▶ Call up the climate control menu (▷ page 284).
- ▶ To select **Ionization**: turn and press the controller.  
The setting element is active.
- ▶ To switch the ionization on or off: turn the controller.
- ▶ **To exit the menu**: press the  button.

### Activating or deactivating pre-entry climate control via the SmartKey

This function is available for plug-in hybrid vehicles.

Before getting in, the driver's seat area or the whole vehicle interior is briefly warmed or ventilated. The air from the vents is pre-cooled.

- ▶ Call up the climate control menu (▷ page 284).
- ▶ **To select Pre-entry Climate Control via Key**: turn and press the controller.
- ▶ **To activate or deactivate**: turn the controller.
- ▶ **To exit the menu**: press the  button.

### Activating or deactivating pre-entry climate control at departure time

This function is available for plug-in hybrid vehicles.

The driver's seat and the vehicle interior are heated or cooled prior to the set departure time.

- ▶ Call up the climate control menu (▷ page 284).
- ▶ **To select Pre-entry Climate Ctrl. at Depart. Time**: turn and press the controller.  
A rotary menu appears.
- ▶ **To select the setting**: turn the controller.
- ▶ **To exit the menu**: press the  button.

### Settings in the bottom bar of the climate control menu

#### Switching cooling with air dehumidification on/off

- ▶ Call up the climate control menu (▷ page 284).
- ▶ Slide  the controller repeatedly until the bottom bar is activated.
- ▶ To select  **A/C**: turn and press the controller.
- ▶ Switch cooling with air dehumidification on  or off .

**i** The current status of the cooling function is displayed in the climate control bar: A/C ON – activated, A/C OFF – deactivated.

**i** Deactivating the cooling with air dehumidification function reduces fuel consumption.

#### Synchronizing the climate control settings

Use  **Sync** (synchronization) to select the climate control setting for all zones together  or separately .

- ▶ Call up the climate control menu (▷ page 284).
- ▶ Slide  the controller repeatedly until the bottom bar is activated.
- ▶ To select  **Sync**: turn and press the controller.
- ▶ Switch the synchronization function on  or off .

For further information on synchronizing climate control settings, see (▷ page 130).

## Navigation mode

### Important safety notes

#### WARNING

If you operate information systems and communication equipment integrated in the vehicle when driving, you may be distracted from the traffic situation. You could also lose control of the vehicle. There is a risk of an accident.

Only operate this equipment when the traffic situation permits. If you are not sure that this is possible, park the vehicle paying attention to traffic conditions and operate the equipment when the vehicle is stationary.

You must observe the legal requirements for the country in which you are currently driving when operating the navigation system.

### General notes

Among other things, correct functioning of the navigation system depends on GPS reception. In certain situations, GPS reception may be impaired, there may be interference or there may be no reception at all, e.g. in tunnels or parking garages.

Audio 20 is equipped with Garmin® MAP PILOT (see the manufacturer's operating instructions). The Garmin® MAP PILOT operating instructions are stored on the SD card as a PDF file. The SD card box contains a quick guide.

The following descriptions apply to navigation with COMAND. Further information can be found in the Digital Operator's Manual.

## Selecting a route type and route options

Multimedia system:

- ▶ Select **Navi** → **Navigation**.
- ▶ Select  → **Route Settings**.

**i** If route guidance is active, first slide  the controller and show the menu.

- ▶ Select a route type.

Notes for route types:

- **Eco Route**  
Calculates an economic route.
- **Dynamic Traffic Route** (only available in the USA)  
Traffic reports on the route for the route guidance are taken into account.
- **Calculate Alternative Routes**  
Different routes are being calculated. Instead of **Start**, select the **Continue** menu item.

- ▶ **To avoid/use route options**: select **Avoid Options**.

- ▶ Select a route option.

Notes for route options:

- **Use Toll Roads**  
The route calculation includes roads which require you to pay a usage fee (toll).
- **Use Carpool Lanes** (only available in the USA)  
Prerequisite: your vehicle meets the access conditions for carpool lanes.  
Carpool lanes will be included if the carpool lanes option is activated.

## Entering an address

Multimedia system:

- ▶ Select **Navi** → **Navigation**.
- ▶ Select **Destination** → **Address Entry**.



**i** If route guidance is active, first slide  the controller and show the menu.

Enter an address, e.g. as follows:

- City or ZIP code, street, house number
- Country, city or ZIP code
- City or ZIP code, center
- Street, city or ZIP code, intersection
- ▶ Select **City**.  
The city in which the vehicle is currently located (current vehicle position) is at the top.



Below this, you will see locations for which route guidance has already been carried out.

- ▶ Enter the city.  
The  symbol: the location is contained on the digital map multiple times.
- ▶ **To switch to the list:** slide the  controler.
- ▶ Select the location.  
If available, the ZIP code is shown. If there are different ZIP codes available for the location, the corresponding digits are displayed with an **X**.
- ▶ Enter the street and house number.  
The address is in the menu.

#### Further options for destination entry:

- Free destination search  
The free destination search finds destinations using fragments of words.
- select the last destination
- select a contact
- select a POI  
You can search for a POI by location, name or telephone number.
- select destination on the map
- enter intermediate destination  
You can map the route to the destination yourself with up to four intermediate destinations.
- select destinations from Mercedes-Benz Apps
- select geo-coordinates

#### Calculating the route

Prerequisite: the address has been entered and is in the menu.

- ▶ Select **Start** or **Continue**.  
The route is calculated with the selected route type and the selected route options.  
If route guidance has already been activated, a prompt will appear asking whether you wish to end the current route guidance.
- ▶ Select **Yes** or **Set as Intermediate Destination**.  
**Yes** cancels the current route guidance and starts route calculation to the new destination.  
**Set as Intermediate Destination** adds the new destination in addition to the existing

destination and opens the intermediate destinations list.

### Connecting a mobile phone

#### Requirements

For telephony via the Bluetooth® interface, you require at least one Bluetooth®-capable mobile phone depending on use of **one-telephone mode** or **two-telephone mode**. The mobile phone must support Hands-Free Profile 1.0 or above.

In **two-telephone mode** you can use all the functions of the multimedia system with the **main telephone**. With the **additional telephone**, you can receive incoming calls.

Multimedia system:

- ▶ Select **Vehicle** → **System Settings** → **Activate Bluetooth**.
- ▶ Activate Bluetooth® .

Mobile phone:

- ▶ Activate Bluetooth® and, if necessary, Bluetooth® visibility for other devices (see the manufacturer's operating instructions).

The Bluetooth® device names for all of one manufacturer's products might be identical. To make it possible to clearly identify your mobile phone, change the device name (see the manufacturer's operating instructions).

If the mobile phone supports the PBAP (**Phone Book Access Profile**) and MAP (**Message Access Profile**) Bluetooth® profiles, the following information will be transmitted after you connect:

- Phone book
- Call lists
- Messages

**i** Further information on suitable mobile phones can be obtained on the Internet at: <http://www.mercedes-benz.com/connect>

**i** In the USA, you can get in touch with the Mercedes-Benz Customer Assistance Center on 1-800-FOR-MERCEdes (1-800-367-6372).  
In Canada, you can get in touch with the Customer Relations Center on 1-800-387-0100.

## Searching for and authorizing a mobile phone

Before using your mobile phone with the multimedia system for the first time, you will need to search for the phone and then authorize (connect) it. Depending on the mobile phone, authorization either takes place by means of Secure Simple Pairing or by entering a passkey. The multimedia system automatically makes the procedure that is relevant for your mobile phone available. The mobile phone is always connected automatically after authorization. Further information on using a mobile phone with the multimedia system (see the Digital Operator's Manual).

If the multimedia system does not detect your mobile phone, this may be due to particular security settings on your mobile phone (see the manufacturer's operating instructions).

Only one mobile phone can be connected to the multimedia system at any one time.

### Searching for a mobile phone

COMAND:

- ▶ Select **Phone** → **Connect Device** → **Connect Another Device**.
- ▶ **One-telephone mode:** select **Main Phone**.
- ▶ **Two-telephone mode:** select **Additional Phone (Incoming Calls Only)** when a mobile phone is already connected.
- ▶ Select **Start Search**.
- ▶ Select mobile phone.

Audio 20:

- ▶ Select **Tel/🌐** → **Conn. Device** → **Connect New Device** → **Connect via Vehicle**.
- ▶ Select mobile phone.
- ▶ **One-telephone mode:** select **Connect as New Main Phone**.
- ▶ **Two-telephone mode:** select **Connect as Additional Phone**.

### Connecting a mobile phone

Authorization via Secure Simple Pairing

- ▶ **The code on the multimedia system and mobile phone are the same:** if applicable, select **Yes** on the multimedia system.
- ▶ Confirm code on the mobile phone. Depending on the mobile phone used, confirm the connection to the multimedia system and for the PBAP and MAP Bluetooth® profiles. The

prompt to confirm may take up to two minutes to be displayed (see the manufacturer's operating instructions).

- ▶ **If the codes are different:** select **No** on the multimedia system.  
The process is canceled.  
Repeat authorization.

Authorization via passkey entry (access code)

- ▶ Choose a one to sixteen-digit number combination as a passkey.
- ▶ Enter the passkey on the multimedia system.
- ▶ Press **[ok]** to confirm.
- ▶ Enter and confirm the passkey on the mobile phone. Depending on the mobile phone used, confirm the connection to the multimedia system and for the PBAP and MAP Bluetooth® profiles. The prompt to confirm may take up to two minutes to be displayed (see the manufacturer's operating instructions).

## Media mode

### General notes

If you wish to play external media sources, the appropriate media mode must already be turned on. Further information on media mode (see the Digital Operator's Manual).

The following external media sources can be used:

- Apple® devices (e.g. iPhone®)
- USB devices (e.g. USB stick, MP3 player)
- CD
- DVD (COMAND)
- SD cards
- Via devices connected by Bluetooth®

**i** Information on the single DVD drive (see the Digital Operator's Manual).

### Activating media mode

Multimedia system:

- ▶ Select **Media** → **Devices** .  
The available media sources will be shown.
- ▶ Select the media source.  
Playable files are played.

## Inserting and removing an SD card

### Important safety notes

#### WARNING

SD cards are small parts. They can be swallowed and cause choking. This poses an increased risk of injury or even fatal injury. Keep the SD card out of the reach of children. If a SD card is swallowed, seek medical attention immediately.

- ❗ If you are no longer using the SD card, you should remove it and store it outside the vehicle. High temperatures can damage the card.

### Inserting an SD card

The SD card slot is located in the stowage compartment under the armrest.

- ▶ Insert the SD card into the SD card slot until the SD card engages. The side with the contacts must face down.
- ▶ Select the media source (▷ page 288).

### Removing an SD card

- ▶ Press the SD card. The SD card is ejected.
- ▶ Remove the memory card.

## Connecting USB devices



USB ports, e.g. when equipped with a navigation system.

There are two USB ports in the stowage space under the armrest.

- ▶ Connect the USB device to the USB port.
- ▶ Select the media source (▷ page 288).

## Stowage areas

### Loading guidelines

#### WARNING

Combustion engines emit poisonous exhaust gases such as carbon monoxide. If the tailgate is open when the engine is running, particularly if the vehicle is moving, exhaust fumes could enter the passenger compartment. There is a risk of poisoning.

Turn off the engine before opening the tailgate. Never drive with the tailgate open.

#### WARNING

If objects, luggage or loads are not secured or not secured sufficiently, they could slip, tip over or be flung around and thereby hit vehicle occupants. There is a risk of injury, particularly in the event of sudden braking or a sudden change in direction.

Always store objects so that they cannot be flung around. Secure objects, luggage or loads against slipping or tipping before the journey.

#### WARNING

The exhaust tail pipe and tail pipe trim can become very hot. If you come into contact with these parts of the vehicle, you could burn yourself. There is a risk of injury.

Always be particularly careful around the exhaust tail pipe and the tail pipe trim. Allow these components to cool down before touching them.

The handling characteristics of a laden vehicle are dependent on the distribution of the load within the vehicle. For this reason, you should observe the following notes when transporting a load:

- Never exceed the maximum permissible gross vehicle mass or the gross axle weight rating for the vehicle (including occupants). The values are specified on the vehicle identification plate on the B-pillar of the driver's door.
- The cargo compartment is the preferred place to carry objects.

- Position heavy loads as far forwards as possible and as low down in the cargo compartment as possible.
- The load must not protrude above the upper edge of the seat backrests.
- Always place the load behind unoccupied seats if possible.
- Hook in the cargo net when loading.
- Secure the load with sufficiently strong and wear-resistant tie-downs. Pad sharp edges for protection.

### Stowage spaces

#### Important safety notes

#### WARNING

If you transport objects in the vehicle interior and these are not adequately secured, they could slip or be flung around and thereby strike vehicle occupants. In addition, cup holders, open stowage spaces and mobile phone brackets may not always be able to hold the objects placed in them in the event of an accident. There is a risk of injury, particularly in the event of sharp braking or sudden changes of direction.

- Always stow objects in such a way that they cannot be tossed about in these or similar situations.
- Always make sure that objects do not protrude out of the stowage spaces, luggage nets or stowage nets.
- Ensure that closable stowage spaces are shut before beginning your journey.
- Always stow and secure heavy, hard, pointed, sharp-edged, fragile or large objects in the cargo compartment.

Observe the loading guidelines (> page 290).

## Stowage compartments in the front

### Glove compartment



- ▶ **To open:** pull handle ① and open glove box flap ②.
- ▶ **To close:** fold glove box flap ② up until it engages.

Objects in A4 format or an iPad®, for example, can be stored in the glove box. For vehicles with a perfume atomizer (▷ page 132) the storage space of the glove box is restricted.



The glove box can only be locked and unlocked using the mechanical key (▷ page 80).

- ▶ **To lock:** insert the mechanical key into the lock and turn it 90° clockwise to position ②.
- ▶ **To unlock:** insert the mechanical key into the lock and turn it 90° counter-clockwise to position ①.

### Eyeglasses compartment



- ▶ **To open:** press marking ①. The eyeglasses compartment opens down. Make sure that the eyeglasses compartment is always closed while the vehicle is in motion.

### Stowage compartment in the front center console



- ▶ Briefly press trim ② in the direction of the arrow. Cover ① swings up.

### Stowage compartment under the armrest



- ▶ **To open:** press button ① at front. The stowage space opens.

Depending on the vehicle's equipment, the following may be in the stowage space:

- an SD card slot
- a multimedia connector unit with two USB ports, e.g. for iPod®, iPhone® or MP3 player (see the Digital Operator's Manual)
- a mobile phone bracket
- a small stowage space in the upper front section

### Stowage compartment in the doors



You can store items such as a rolled-up fluorescent jacket (driver's door) and the vehicle document wallet (front-passenger door) in stowage space ① in the doors.

In doors ② you can store bottles with a capacity of up to 34 fl. oz. (1.0 liter).

### Stowage compartments in the rear

#### Stowage compartment in the rear armrest

**!** Do not sit on or support your body weight on the rear seat armrest when it is folded down, as you could otherwise damage it.

**!** Close the cover of the stowage compartment before folding the rear seat armrest back into the seat backrest.



- ▶ **To open:** fold down the seat armrest.
- ▶ Press on the front of release catch ① and fold the cover of the armrest upwards.

### Additional stowage space

Depending on the equipment, the following additional stowage areas are available in the vehicle:

- card and coin holder in the dashboard above the light switch (not suitable for holding thin objects such as shopping tokens)
- the open stowage compartment in the center console
- stowage net in the front-passenger footwell
- the map pockets on the back of the driver's and front-passenger seat
- parcel net on the left-hand side in the cargo compartment

Observe the loading guidelines (▷ page 290) and the safety notes regarding stowage spaces (▷ page 290).

### Ski and snowboard bag

#### Important safety notes

##### **⚠ WARNING**

The skibag in conjunction with the lashing straps cannot restrain any objects other than skis.

Vehicle occupants could be struck in the event of sudden braking or an accident, for instance, if you:

- transport other heavy or sharp-edged objects in the skibag
- do not secure the skibag with the lashing straps

There is a risk of accident and injury.

Store only skis in the skibag. Always secure the skibag with the lashing straps so that it cannot move around.

A maximum of four pairs of skis or two snowboards can be transported in the ski and snowboard bag.



## Securing the ski/snowboard bag in the cargo compartment

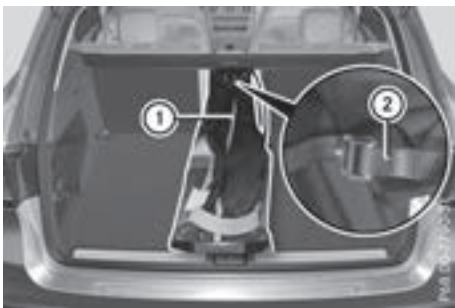

- ▶ Fold the middle rear seat backrest forwards (▷ page 293).
- ▶ Slide the ski and snowboard bag between the two outside rear seat backrests. Ensure that the wheels of the ski/snowboard bag are in the cargo compartment.
- ▶ Open the ski/snowboard bag with zip ① and place the skis or snowboards inside it.
- ▶ Close the ski and snowboard bag.
- ▶ Pull tensioning strap ② tight by the loose end until the skis or snowboards are held firmly inside the ski/snowboard bag.



- ▶ Engage tensioning strap ③ in a diagonal pattern on hooks ④ in cargo tie-down rings ⑤ as shown.

### EASY-PACK quickfold rear bench seat

#### Important safety notes

##### WARNING

If the rear bench seat/rear seat and seat backrest are not engaged they could fold for-

wards, e.g. when braking suddenly or in the event of an accident.

- The vehicle occupant would thereby be pushed into the seat belt by the rear bench seat/rear seat or by the seat backrest. The seat belt can no longer offer the intended level of protection and could even cause injuries.
- Objects or loads in the trunk/cargo compartment cannot be restrained by the seat backrest.

There is an increased risk of injury.

Before every trip, make sure that the seat backrests and the rear bench seat/rear seat are engaged.

- ! When folding the rear seat backrest forwards, ensure that there are no items lying on the seat cushions. These items could otherwise be damaged or could themselves damage the rear seats.

Observe the loading guidelines (▷ page 290). The outside and the middle rear seat backrests can be folded down separately to increase the cargo compartment capacity. The division ratio is 40/20/40.

Both outside seat backrests in the rear compartment are electrically unlocked with the release handles either in the cargo compartment or beside the seat backrests in the rear compartment (vehicles with EASY-PACK tailgate only). The corresponding rear seat backrests then fold forward automatically.

#### Folding the rear seat backrest forwards

##### Preparation

- ▶ Vehicles without memory function: if necessary, move the driver's or front-passenger seat forward.
- ▶ Vehicles with memory function: when one or both parts of the rear seat backrest are folded forward, the respective front seat moves forward slightly, when necessary, in order to avoid contact.

When the engine is running, the driver's seat does not move forward.

- ▶ Fully insert the rear seat backrest head restraints.



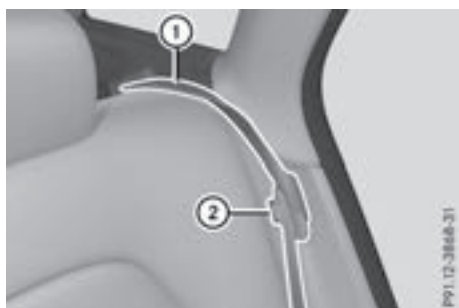

- ▶ Hook seat belt buckle tongue ① through seat belt retainer ②.

### Release handle in the cargo compartment



- ▶ Pull the left or right release handle ①. The corresponding backrest folds forward.
- ▶ Move the driver's or front-passenger seat back if necessary.

### Release handle next to the seat backrest

The release handle beside the seat backrest is only present in vehicles with an EASY-PACK tail-gate.



- ▶ Pull the left or right release handle ① beside the seat backrests. The corresponding backrest folds forward.
- ▶ Move the driver's or front-passenger seat back if necessary.

### Middle rear seat backrest



- ▶ Pull release lever ② forward. Rear seat backrest ① is released.
- ▶ Fold rear seat backrest ① forward.
- ▶ Move the driver's or front-passenger seat back if necessary.

### Folding the rear seat backrest back

- ⚠ Make sure that the seat belt does not become trapped when folding the rear seat backrest back. Otherwise, it could be damaged.



### Left and right seat backrest:

- ▶ Move the driver's or front-passenger seat forward if necessary.
- ▶ Fold rear seat backrest ① back until it engages. If the rear seat backrest is not engaged and locked, this will be shown in the multifunction

display in the instrument cluster. A warning tone also sounds.

- ▶ Adjust the head restraints if necessary (▷ page 102).
- ▶ Move the driver's or front-passenger seat back if necessary.



#### Middle rear seat backrest:

- ▶ Move the driver's or front-passenger seat forward if necessary.
- ▶ Fold seat backrest ① back until it engages. Red lock status indicator ② is no longer visible.
- ▶ Adjust the head restraints if necessary (▷ page 102).
- ▶ Move the driver's or front-passenger seat back if necessary.

#### Locking the center rear seat backrest



In order to prevent the cargo compartment from being accessed by unauthorized persons, the center seat backrest can be locked using a catch. The center seat backrest can only be folded forward together with the left seat backrest.

- ▶ **To lock:** fold the left and center seat backrests forward. Make sure that the center and

left seat backrests are engaged and joined together.

- ▶ Slide catch ① upwards. The release mechanism of the center seat backrest is locked.
- ▶ **To unlock:** fold the left and center seat backrests forward.
- ▶ Slide catch ① downwards.

#### Adjusting the angle of the rear seat backrests (cargo position)



Vehicles with the stowage space package: to enlarge the cargo compartment, you can adjust the rear seat backrests to a 10 degrees steeper angle (cargo position).

- ▶ Fold the seat backrest forward (▷ page 293).
- ▶ Move handle ① in the direction of the arrow.
- ▶ Push back seat backrest ② as far as handle ① until the backrest engages. The cargo position has been reached.

#### Securing loads

##### Cargo tie-down rings

Observe the following notes on securing loads:

- Observe the loading guidelines (▷ page 290).
- Secure the load using the cargo tie-down rings.
- Distribute the load on the cargo tie-down rings evenly.
- Do not use elastic straps or nets to secure a load, as these are only intended as an anti-slip protection for light loads.
- Do not route tie-downs across sharp edges or corners.
- Pad sharp edges for protection.



① Cargo tie-down rings in the rear-compartment footwell (vehicles with cargo net)



① Bag hook



① Cargo tie-down rings in the cargo compartment

## Bag hook

### WARNING

The bag hooks cannot restrain heavy objects or items of luggage. Objects or items of luggage could be flung around and thereby hit vehicle occupants when braking or abruptly changing directions. There is a risk of injury. Only hang light objects on the bag hooks. Never hang hard, sharp-edged or fragile objects on the bag hooks.

**!** The bag hook can bear a maximum load of 6.6lbs (3kg) and should not be used to secure a load.

## Cargo compartment cover

### Important safety notes

#### WARNING

On its own, the cargo compartment cover cannot secure or restrain heavy objects, items of luggage and heavy loads. You could be hit by an unsecured load during sudden changes in direction, braking or in the event of an accident. There is an increased risk of injury or even fatal injury.

Always store objects so that they cannot be flung around. Secure objects, luggage or loads against slipping or tipping over, e.g. by using tie downs, even if you are using the cargo compartment cover.

**!** When loading the vehicle, make sure that you do not stack the load in the cargo compartment higher than the lower edge of the side windows. Do not place heavy objects on top of the cargo compartment cover.

The cargo compartment cover is secured behind the rear bench seat backrest.

## Extending and retracting the cargo compartment cover



- ▶ **To extend:** pull cargo compartment cover back by grab handle ① and clip it into retainers ② on the left and right.
- ▶ **To retract:** unhook the cargo compartment cover from retainers ② on the left and right and guide it forward by grab handle ① until it is fully retracted.

## Installing/removing the cargo compartment cover



- ▶ **To remove:** make sure that cargo compartment cover ① is rolled up.
- ▶ Push in the end cap of cargo compartment cover ① in the direction of the arrow on the right-hand side using the grip ③.
- ▶ Push cargo compartment cover ① into opposite anchorage ②.
- ▶ Remove cargo compartment cover ① up.
- ▶ **To install:** place cargo compartment cover ① into anchorage ② on the left-hand side.
- ▶ Push in the opposite end cap of cargo compartment cover ① in the direction of the arrow and insert the cargo compartment

cover ① into the right-hand anchorage from above ②.

## Cargo net

### Important safety notes

#### ⚠ WARNING

On its own, the cargo net cannot secure or restrain heavy objects, items of luggage and heavy loads. You could be hit by an unsecured load during sudden changes in direction, braking or in the event of an accident. There is an increased risk of injury or even fatal injury. Always store objects so that they cannot be flung around. Secure objects, luggage or loads against slipping or tipping over, e.g. by using tie downs, even if you are using the cargo net.

It is important to use a cargo net if you load the vehicle with small objects above the seat backrests. For safety reasons, always use a cargo net when transporting loads.

Damaged cargo nets can no longer fulfill their protective function and must be replaced. Visit a qualified specialist workshop.

### Using the cargo net

#### Preparing the cargo net



The cargo net can be used in two different positions (behind the B-pillar or the C-pillar):

- The brackets behind B-pillar ① are required for the cargo compartment enlargement (▷ page 293).

The corresponding cargo tie-down rings to tighten the net are located in the footwell of the rear bench seat (▷ page 295).

- The brackets behind C-pillar ② are required for the cargo compartment behind the rear bench seat.

The corresponding cargo tie-down rings to tension the net are located in the cargo compartment (▷ page 295).

The cargo net is located in the stowage space under the cargo compartment floor.

- ▶ Open both Velcro fasteners and remove the cargo net.
- ▶ Unroll and unfold the cargo net.  
The upper and lower guide rods must engage audibly.

### Attaching and tightening the cargo net

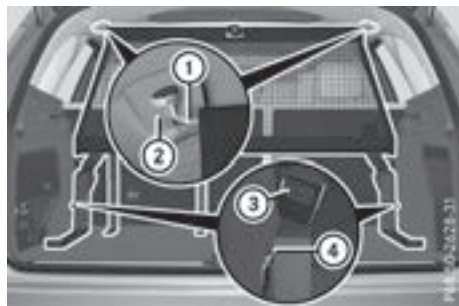

Cargo net installed behind the C-pillar

- ▶ **To attach and tighten:** insert guide rod ① into bracket ② and slide forward.
- ▶ Attach belt hook ④ to the cargo tie-down ring and pull down on the loose end of the lashing strap until the cargo net is taut.
- ▶ After driving a short distance, check the tension of the cargo net and retighten it if necessary.
- ▶ **To release and detach:** pull the belt clamp ③ up.
- ▶ Unhook belt hook ④ from the cargo tie-down ring.
- ▶ Detach guide rod ① from bracket ②.

### Storing the cargo net

- ▶ Press the red button on the upper and lower guide rods.
- ▶ Fold the cargo net and roll it up.

- ▶ Close the two Velcro fasteners on the cargo net holder.
- ▶ Put the cargo net in the stowage space under the cargo compartment floor.

## Parcel net

### Important safety notes

#### ⚠ WARNING

If you transport objects in the vehicle interior and these are not adequately secured, they could slip or be flung around and thereby strike vehicle occupants. In addition, cup holders, open stowage spaces and mobile phone brackets may not always be able to hold the objects placed in them in the event of an accident. There is a risk of injury, particularly in the event of sharp braking or sudden changes of direction.

- Always stow objects in such a way that they cannot be tossed about in these or similar situations.
- Always make sure that objects do not protrude out of the stowage spaces, luggage nets or stowage nets.
- Ensure that closable stowage spaces are shut before beginning your journey.
- Always stow and secure heavy, hard, pointed, sharp-edged, fragile or large objects in the cargo compartment.

Observe the following notes:

- Observe the loading guidelines (▷ page 290).
- To avoid damaging the side trim panels in the cargo compartment, maintain a sufficient distance from the side trim panels in the cargo compartment when removing and inserting the cargo compartment floor.



### Installing the parcel net

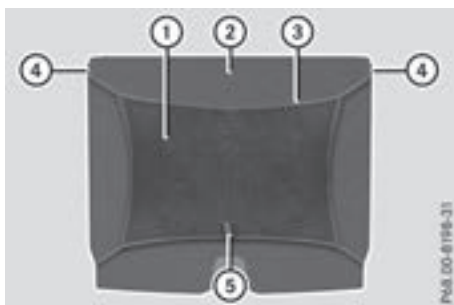

- ▶ Open cargo compartment floor ② (> page 300), raise by approximately 45° and remove to the rear.
- ▶ Place cargo compartment floor ② on a clean surface.
- ▶ Stretch parcel net ① over cargo compartment floor ② as shown.

Make sure that:

- parcel net ① is aligned with the center of cargo compartment floor ②
- rubber band ③ is below mountings ④
- tab ⑤ is facing forward



- ▶ Slide cargo compartment floor ② horizontally into the cargo compartment until mountings ④ are positioned in guides ⑨ on both sides.
- ▶ Raise cargo compartment floor ② by approximately 45° so that mountings ④ engage audibly.

Make sure that:

- rubber band ⑦ is below clasp ⑥. The rubber band must not block the clasp.
- rubber band ③ is below base ⑧.
- ▶ Fold cargo compartment floor ② down and press down until it engages.

### Coat hooks on the tailgate



- ① Coat hook

### Cargo compartment plug-in module (telescope bars)

#### General notes

The cargo compartment plug-in module allows you to use your cargo compartment for a variety of purposes.

The following accessory parts are located under the cargo compartment floor:

- a telescopic rod
- two mounting elements
- two brackets

#### Important safety notes

##### WARNING

If you drive when the cargo compartment floor is open, objects could be flung around, thus striking vehicle occupants. There is a risk of injury, particularly in the event of sudden braking or a sudden change in direction.

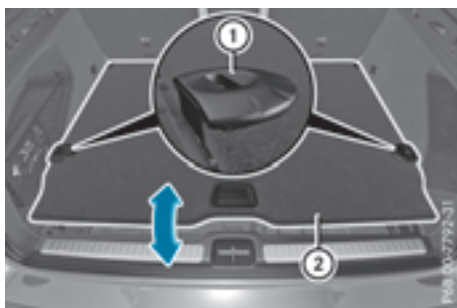

Always close the cargo compartment floor before a journey.

## Installation

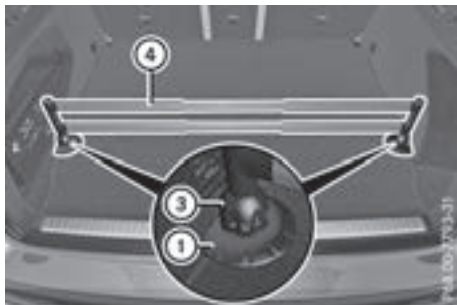

- ▶ Open cargo compartment floor (2) (> page 300).
- ▶ Attach brackets (1) in the desired position on the side of cargo compartment floor (2).
- ▶ Close cargo compartment floor (2).



- ▶ Turn mounting elements (3) to .
- ▶ Insert mounting elements (3) into brackets (1).
- ▶ Pull telescopic rod (4) apart.
- ▶ Insert telescopic rod (4) into mounting elements (3).
- ▶ Turn both mounting elements (3) to  until you feel them engage.

### Stowage well under the cargo compartment floor

## Important safety notes

### WARNING

If you drive when the cargo compartment floor is open, objects could be flung around, thus striking vehicle occupants. There is a risk of

injury, particularly in the event of sudden braking or a sudden change in direction. Always close the cargo compartment floor before a journey.

The following items are located beneath the cargo compartment floor:

- the folding box
- tire-change tool kit
- TIREFIT kit
- the EASY-PACK load-securing kit

## Opening/closing the cargo compartment floor



- ▶ **To open:** open the tailgate.
- ▶ Holding ribbing (2), press handle (1) down. Handle (1) folds up.



- ▶ Fold out hook (3) on the underside of the cargo compartment floor in the direction of the arrow.





- ▶ Attach hook ③ to the cargo compartment's upper seal ④.
- ▶ **To close:** detach hook ③ from the cargo compartment's upper seal ④.
- ▶ Fasten hook ③ to the bracket on the underside of the cargo compartment floor.
- ▶ Fold the cargo compartment floor down.
- ▶ Press the cargo compartment floor down until it engages.

### Locking/unlocking the cargo compartment floor



- 1 Cargo compartment floor unlocked
- 2 Cargo compartment floor locked

The cargo compartment floor can be locked and unlocked using the mechanical key.

### Roof carrier

#### Important safety notes

##### WARNING

When you load the roof, the center of gravity of the vehicle rises and the driving characteristics change. If you exceed the maximum roof

load, the driving characteristics, as well as steering and braking, will be greatly impaired. There is a risk of an accident.

Never exceed the maximum roof load and adjust your driving style.

You will find information on the maximum roof load in the "Technical data" section (▶ page 382).

**!** Mercedes-Benz recommends that you only use roof carriers that have been tested and approved for Mercedes-Benz vehicles. This helps to avoid damage to the vehicle.

Position the load on the roof carrier in such a way that the vehicle will not sustain damage even when it is in motion.

Depending on the vehicle equipment, ensure that when the roof carrier is installed you can:

- fully raise the sliding sunroof/panorama roof with power tilt/sliding panel
- open the tailgate fully

An incorrectly secured roof carrier or roof load may become detached from the vehicle. You must therefore ensure that you observe the roof carrier manufacturer's installation instructions.

**Vehicles with a panorama roof with power tilt/sliding panel:** the panorama roof with power tilt/sliding panel cannot be opened if a roof carrier is installed. The panorama roof with power tilt/sliding panel can still be raised to allow ventilation of the vehicle interior. If the panorama roof with power tilt/sliding panel makes contact with a roof carrier approved by Mercedes-Benz, the sunroof will lower slightly but remain raised at the rear.

### Attaching the roof carrier

- ▶ Secure the roof carrier to the roof rails.
- ▶ Observe the manufacturer's installation instructions.

## Features

## Cup holder

## Important safety notes

**⚠ WARNING**

If you transport objects in the vehicle interior and these are not adequately secured, they could slip or be flung around and thereby strike vehicle occupants. In addition, cup holders, open stowage spaces and mobile phone brackets may not always be able to hold the objects placed in them in the event of an accident. There is a risk of injury, particularly in the event of sharp braking or sudden changes of direction.

- Always stow objects in such a way that they cannot be tossed about in these or similar situations.
- Always make sure that objects do not protrude out of the stowage spaces, luggage nets or stowage nets.
- Ensure that closable stowage spaces are shut before beginning your journey.
- Always stow and secure heavy, hard, pointed, sharp-edged, fragile or large objects in the cargo compartment.

**!** Only use the cup holders for containers of the right size and which have lids. The drinks could otherwise spill.

**!** Do not expose drinks bottles in the cup holder in the center console to continuous, strong and direct sunlight. The passenger compartment in the area of the center console can otherwise be damaged by the concentrated and reflected sunlight.

Observe the loading guidelines (▷ page 290).

## Cup holder in the front center console



- ▶ **To open:** open the stowage compartment (▷ page 291).
- ▶ **To remove:** slide catch (3) forward and pull out cup holder (2).
- ▶ **To insert:** insert cup holder (2) and slide back catch (3).
- ▶ **To close:** push cover (1) of the stowage compartment closed.

If you remove the cup holder insert, you can use the resulting compartment for stowage.

You can remove the cup holder's rubber mat for cleaning. Clean with clear, lukewarm water only.

## Cup holder in the rear seat armrest

**!** Do not sit on or support your body weight on the rear seat armrest when it is folded down, as you could otherwise damage it.

**!** Close the cup holder before folding the rear seat armrest up. Otherwise, the cup holder could be damaged.



- ▶ Fold down the rear seat armrest.
- ▶ **To open:** press the front of cup holder (1) or (2). Cup holder (1) or (2) extends automatically.

- ▶ **To fold out:** place a container in the cup holder. The cup holder ① or ② folds down automatically.
- ▶ **To fold in:** remove the container. The cup holder ① or ② folds in automatically.
- ▶ **To close:** slide cup holder ① or ② back until it engages.

**Sun visors**

**Overview**

**⚠ WARNING**

If the mirror cover of the vanity mirror is folded up when the vehicle is in motion, you could be blinded by incident light. There is a risk of an accident.

Always keep the mirror cover folded down while driving.

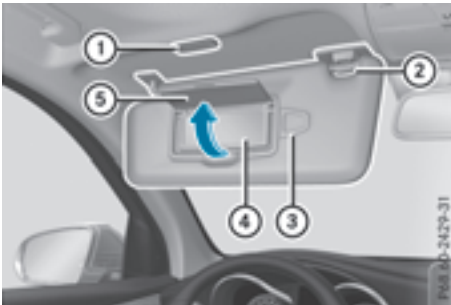

- ① Mirror light
- ② Retainer
- ③ Retaining clip, e.g. for a car park ticket
- ④ Vanity mirror
- ⑤ Mirror cover

**Vanity mirror in the sun visor**

Mirror light ① only functions if the sun visor is clipped into bracket ② and mirror cover ⑤ has been folded up.

**Glare from the side**

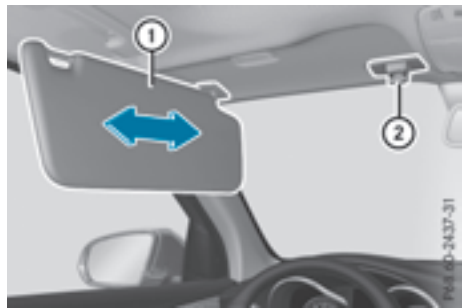

- ▶ Fold down the sun visor.
- ▶ Pull sun visor ① out of retainer ②.
- ▶ Swing sun visor ① to the side.
- ▶ Slide sun visor ① horizontally as required.

**Rear side window roller sunblinds**

**!** Always guide the roller sunblind by hand. Do not let it snap back suddenly as this would damage the automatic roller mechanism.

**!** Do not drive the vehicle with the roller sunblind hooked in and the side windows opened simultaneously. The roller sunblind can jump out of the retainers and spring back suddenly when driving at high speeds, e.g. when driving on the freeway. This could damage the inertia reel. Therefore, either close the side window or retract the roller sunblind before driving at high speeds.

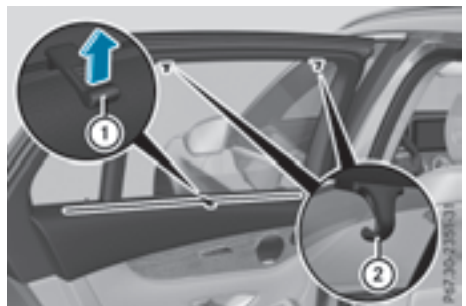

- ▶ **To extend:** pull the roller sunblind out by tab ① and hook it onto retainers ② at the top of the window.

## Ashtray

### Front ashtray

**!** The stowage space under the ashtray is not heat resistant. Before placing lit cigarettes in the ashtray, make sure that the ashtray is properly engaged. Otherwise, the stowage space could be damaged.

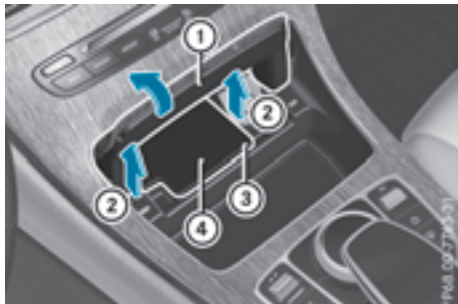

- ▶ **To open:** open the stowage compartment (> page 291).
- ▶ Push the cover of the ashtray upwards at its right side ③.
- ▶ **To remove the insert:** hold the sides of insert ④, push it forward and lift it up ② and out.
- ▶ **To install the insert:** press insert ④ into the holder until it engages.
- ▶ **To close:** close the cover of the ashtray.
- ▶ Push cover ① of the stowage compartment closed.

**i** You can remove the ashtray insert and use the resulting compartment for stowage.

### Rear compartment ashtray



- ▶ **To open:** pull cover ② out by its top edge.
- ▶ **To remove the insert:** push ribbing ③ from the left side and pull insert ① upwards.
- ▶ **To install the insert:** install insert ① from above into the holder and press down into the holder until it engages.

## Cigarette lighter

### ⚠ WARNING

You can burn yourself if you touch the hot heating element or the socket of the cigarette lighter.

In addition, flammable materials can ignite if:

- the hot cigarette lighter falls
- a child holds the hot cigarette lighter to objects, for example

There is a risk of fire and injury.

Always hold the cigarette lighter by the knob. Always make sure that the cigarette lighter is out of reach of children. Never leave children unsupervised in the vehicle.

Your attention must always be focused on the traffic conditions. Only use the cigarette lighter when road and traffic conditions permit.



Cigarette lighter (example)

- ▶ Turn the SmartKey to position ② in the ignition lock (> page 136).
- ▶ **To open:** open the stowage compartment (> page 291).
- ▶ Press in cigarette lighter ②. Cigarette lighter ② will pop out automatically when the heating element is red-hot.
- ▶ **To close:** push cover ① of the stowage compartment closed.

## 12 V sockets

### General notes

- ▶ Turn the SmartKey to position **1** in the ignition lock (▶ page 136).

The sockets can be used for accessories with a maximum draw of 180 W (15 A). Accessories include such items as chargers for mobile phones.

If you use the sockets for long periods when the engine is switched off, the battery may discharge.

An emergency cut-out ensures that the on-board voltage does not drop too low. If the on-board voltage is too low, the power to the sockets is automatically cut. This ensures that there is sufficient power to start the engine.

If you have connected a device to the 12 V socket, leave the cover of the stowage compartment open. This prevents the cover from being blocked.

### Socket in the front center console



12 V socket (example)

- ▶ **To open:** open the stowage compartment (▶ page 291).
- ▶ Lift up the cover of socket **2**.
- ▶ **To close:** push cover **1** of the stowage compartment closed.

### Socket in the rear compartment center console



- ▶ Pull cover **2** out by its top edge.
- ▶ Lift up the cover of socket **1**.

### Socket in the cargo compartment



- ▶ Lift up the cover of socket **1**.

## 115 V socket

### Important safety notes

#### DANGER

When a suitable device is connected, the 115 V power socket will be carrying a high voltage. You could receive an electric shock if the connector cable or the 115 V power socket is pulled out of the trim or is damaged or wet. There is a risk of fatal injury.

- Use only connector cables that are dry and free of damage.
- When the ignition is off, make sure that the 115 V power socket is dry.

- Have the 115 V power socket checked or replaced immediately at a qualified specialized workshop if it is damaged or has been pulled out of the trim.
- Never plug the connector cable into a 115 V power socket that is damaged or has been pulled out of the trim.

### DANGER

If you reach into the power socket or plug inappropriate devices into the power socket, you could receive an electric shock. There is a risk of fatal injury.

Only connect appropriate devices to the power socket.

- ! Note that work and repairs on the 115 V power socket should only be carried out by qualified specialist personnel.

### General notes

The 115 V power socket provides an alternating voltage of 115 V so that small electronic devices can be connected. These devices, such as games consoles, chargers and laptops, must not consume more than a maximum of 150 watts altogether.

Requirements for operation of these devices:

- the electronic device that you connect has a suitable connector and conforms to standards specific to the country you are in.
- the plug of the electronic device is plugged correctly into 115 V power socket.

- the maximum wattage of the device to be connected must not exceed 150 watts.
- the on-board power supply is within a permissible voltage range.
- the 12 V sockets in the rear compartment and the cargo compartment are operational.

### Using the 115 V power socket



- ▶ **To switch on:** switch the ignition on.
- ▶ Open flap ③.
- ▶ Insert the plug of the electronic device into 115 V power socket ①. Indicator lamp ② lights up.
- ▶ **To switch off:** disconnect the plug from 115 V power socket ①. Ensure that you do not pull on the cord.



## Problems with the 115 V power socket

Problem	Possible causes/consequences and ► Solutions
The warning lamp on the 115 V power socket is not lit.	The on-board voltage is too low because the battery is too weak. ► Start the engine. or ► Charge the battery (▷ page 340). If the indicator lamp still does not light up: ► Visit a qualified specialist workshop.
	The temperature of the DC/AC converter is temporarily too high. ► Remove the electronic device connector from the 115 V socket. ► Let the DC/AC converter cool down. If the indicator lamp still does not light up after cooling down the converter: ► Visit a qualified specialist workshop.
	You have connected an electronic device that has a constant nominal power of less than 150 watts, but has a very high switch-on current. This device will not work. If you connect such a device, the 115 V power socket will not supply it with power. ► Connect a suitable electronic device.

### mbrace

#### General notes

The mbrace system is only available in the USA. You must have a license agreement to activate the mbrace service. Make sure that your system is activated and operational. To register, press the  Info call button. If any of the steps mentioned are not carried out, the system may not be activated.

If you have questions about the activation, contact one of the following telephone hotlines:

Mercedes-Benz Customer Assistance Center at 1-800-FOR-MERcedes (1-800-367-6372) or 1-866-990-9007

Shortly after successfully registering with the mbrace service, a user ID and password will be sent to you by mail. You can use this password to log onto the mbrace area under "Owners Online" at <http://www.mbusa.com>.

The system is available if:

- it has been activated and is operational
- the corresponding mobile phone network is available for transmitting data to the Customer Center
- a service subscription is available

Determining the location of the vehicle on a map is only possible if:

- GPS reception is available
- the vehicle position can be forwarded to the Customer Assistance Center

#### The mbrace system

To adjust the volume during a call, proceed as follows:

- Press the  or  button on the multi-function steering wheel.

or

- Use the multimedia system volume control.



The system offers various services, e.g.:





- Automatic and manual emergency call
- Roadside Assistance call
- Info call

You can find information and a description of all available features under "Owners Online" at <http://www.mbusa.com>.

### System self-test

After you have switched on the ignition, the system carries out a self-diagnosis.

A malfunction in the system has been detected if one of the following occurs:

- The indicator lamp in the SOS button does not come on during the system self-test.
- The indicator lamp in the  Roadside Assistance button does not light up during self-diagnosis of the system.
- The indicator lamp in the  Info call button does not light up during the system self-diagnosis
- The indicator lamp in one or more of the following buttons continues to light up red after the system self-diagnosis:
  - SOS button
  -  Roadside Assistance call button
  - Info call button 
- After the system self-diagnosis, the **Inoperative** or **Service Not Activated** message appears in the multifunction display.

If a malfunction is indicated as outlined above, the system may not operate as expected. In the event of an emergency, help will have to be summoned by other means.

Have the system checked at the nearest Mercedes-Benz Service Center or contact the following service hotlines:

Mercedes-Benz Customer Assistance Center at 1-800-FOR-MERCEdes (1-800-367-6372) or 1-866-990-9007

## Emergency call

### Important safety notes

#### WARNING

It can be dangerous to remain in the vehicle, even if you have pressed the SOS button in an emergency if:

- you see smoke inside or outside of the vehicle, e.g. if there is a fire after an accident
- the vehicle is on a dangerous section of road
- the vehicle is not visible or cannot easily be seen by other road users, particularly when dark or in poor visibility conditions

There is a risk of an accident and injury.

Leave the vehicle immediately in this or similar situations as soon as it is safe to do so.

Move to a safe location along with other vehicle occupants. In such situations, secure the vehicle in accordance with national regulations, e.g. with a warning triangle.

### General notes

Observe the notes on system activation (> page 307).

An emergency call is dialed automatically if an air bag or Emergency Tensioning Device is triggered. You cannot end an automatically triggered emergency call yourself.

An emergency call can also be initiated manually.

As soon as the emergency call has been initiated, the indicator lamp in the SOS button flashes. The **Connecting Call** message appears in the multifunction display.

The audio output is muted.

Once the connection has been made, the **Call Connected** message appears in the multifunction display.

All important information on the emergency is transmitted, for example:

- Current location of the vehicle (as determined by the GPS system)
- Vehicle identification number
- Information on the severity of the accident

Shortly after the emergency call has been initiated, a voice connection is automatically estab-

lished between the Customer Assistance Center and the vehicle occupants.

- If the vehicle occupants respond, the Mercedes-Benz Customer Assistance Center attempts to get more information on the emergency.
- if there is no response from the vehicle occupants, an ambulance is immediately sent to the vehicle.

If no voice connection can be established to the Mercedes-Benz Customer Assistance Center, the system has been unable to initiate an emergency call.

This can occur, for example, if the relevant mobile phone network is not available. The indicator lamp in the SOS button flashes continuously.

The **Call Failed** message appears in the multifunction display and must be confirmed.

In this case, summon assistance by other means.

### Making an emergency call

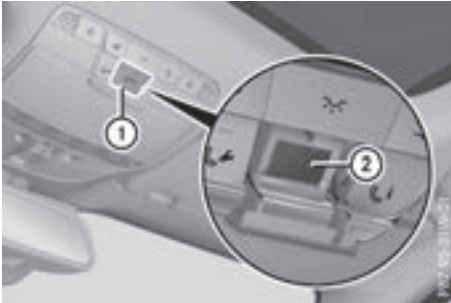

- ▶ **To initiate an emergency call manually:** press cover ① briefly to open.
- ▶ Press and hold the SOS button for at least one second ②. The indicator lamp in SOS button ② flashes until the emergency call is concluded.
- ▶ Wait for a voice connection to the Mercedes-Benz Customer Assistance Center.
- ▶ After the emergency call, close cover ①.

If the mobile phone network is unavailable, mbrace will not be able to make the emergency call. If you leave the vehicle immediately after pressing SOS button ②, you do not know if mbrace has successfully made the emergency call. In this case, always summon assistance by other means.

### Roadside Assistance button



- ▶ **To call:** press roadside assistance button ①. This initiates a call to the Mercedes-Benz Customer Assistance Center.

The indicator lamp in Roadside Assistance button ① flashes while the call is active. The **Connecting Call** message appears in the multifunction display. The audio output is muted.

If a connection can be made, the **Call Connected** message appears in the multifunction display.

If a mobile phone network and GPS reception are available, the system transfers data to the Mercedes-Benz Customer Assistance Center, for example:

- Current location of the vehicle
- Vehicle identification number

The multimedia system display indicates that a call is active. During the call, you can change to the navigation menu by pressing the NAVI button on the multimedia system, for example.

Voice output is not available in this case.

A voice connection is established between the Mercedes-Benz Customer Assistance Center and the vehicle occupants.

From the remote malfunction diagnosis, the Mercedes-Benz Customer Assistance Center can ascertain the nature of the problem (▷ page 312).

The Mercedes-Benz Customer Assistance Center either sends a qualified Mercedes-Benz technician or makes arrangements for your vehicle to be transported to the nearest Mercedes-Benz Service Center.

You may be charged for services such as repair work and/or towing.

The system has not been able to initiate a Roadside Assistance call, if:

- the  indicator lamp for the roadside assistance call button is flashing continuously.
- no voice connection to the Mercedes-Benz Customer Assistance Center was established.

This can occur if the relevant mobile phone network is not available, for example.

The **Call Failed** message appears on the multifunction display.

► **To end a call:** press the  button on the multifunction steering wheel.

or

► Press the corresponding multimedia system button for ending a phone call.

### Info call button



► **To call:** press Info call button ①.

This initiates a call to the Mercedes-Benz Customer Assistance Center.

The indicator lamp in Info call button ① flashes while the connection is being made.

The **Connecting Call** message appears in the multifunction display. The audio output is muted.

If a connection can be made, the **Call Connected** message appears in the multifunction display.

If a mobile phone network and GPS reception are available, the system transfers data to the Mercedes-Benz Customer Assistance Center, for example:

- Current location of the vehicle
- Vehicle identification number

The multimedia system display indicates that a call is active. During the call, you can change to

the navigation menu by pressing the NAVI button on COMAND, for example.

Voice output is not available in this case.

A voice connection is established between the Mercedes-Benz Customer Assistance Center and the vehicle occupants.

You receive information about operating your vehicle, about the nearest Mercedes-Benz Service Center and about other products and services from Mercedes-Benz.

You can find further information on the mbrace system under "Owners Online" at <http://www.mbusa.com>.

The system has not been able to initiate an MB Info call, if:

- the indicator lamp in the  Info call button is flashing continuously.
- no voice connection to the Mercedes-Benz Customer Assistance Center was established.

This can occur if the relevant mobile phone network is not available, for example.

The **Call Failed** message appears in the multifunction display.

► **To end a call:** press the  button on the multifunction steering wheel.

or

► Press the corresponding multimedia system button for ending a phone call.

### Call priority

When service calls are active, e.g. Roadside Assistance or Info calls, an emergency call can still be initiated. In this case, an emergency call will take priority and override all other active calls.

The indicator lamp of the respective button flashes until the call is ended.

An emergency call can only be terminated by the Mercedes-Benz Customer Assistance Center.

All other calls can be ended by pressing:

- the  button on the multifunction steering wheel
- the corresponding button in the multimedia system to end the voice call

When a call is initiated, the audio system is muted.

The mobile phone is no longer connected to the multimedia system.

However, if you want to use your mobile phone, do so only when the vehicle is stationary and in a safe location.



## Downloading destinations

### Downloading destinations

Downloading destinations gives you access to a database with over 15 million points of interest (POIs). These can be downloaded on the navigation system in your vehicle. If you know the destination, the address can be downloaded. Alternatively, you can obtain the location of Points of Interest (POIs)/important destinations in the vicinity.

Furthermore, you can download routes with up to four way points.

You are prompted to confirm route guidance to the address entered.

- ▶ Select **Yes** by turning  or sliding  the controller and confirm with .

The system calculates the route and subsequently starts the route guidance with the address entered.

If you select **No** the address can be stored in the address book.

The destination download function is available if:

- the vehicle is equipped with a navigation system.
- the relevant mobile phone network is available and data transfer is possible.

### Route Assistance

This service is part of the mbrace PLUS Package and cannot be purchased separately.

You can use the Route Assistance function even if the vehicle is not equipped with a navigation system.

Within the framework of this service, you receive a professional and reliable form of navigation support without having to leave your vehicle.

The customer service representative finds a suitable route depending on your vehicle's current position and the desired destination. You will then be guided live through the current route section.

## Search and Send

### General notes

To use "Search & Send", your vehicle must be equipped with mbrace and a navigation system. Additionally, an mbrace service subscription must be completed.

"Search & Send" is a destination entry service. A destination address which is found on Google Maps® can be transferred via mbrace directly to your vehicle's navigation system.

### Specifying and sending the destination address

- ▶ Go to the website <http://maps.google.com> and enter a destination address into the entry field.

- ▶ **To send the destination address to the e-mail address of your mbrace account:** click on the corresponding button on the website.

Example:

If you select 'Send to vehicle' and then 'Mercedes-Benz', the destination address will be sent to your vehicle.

- ▶ When the "Send" dialog window appears:

Enter the e-mail address you specified when setting up your mbrace account into the corresponding field.

- ▶ Click "Send".



Information on specific commands such as "Address entry" or "Send" can be found on the website.

### Calling up a transmitted destination address

- ▶ Turn the SmartKey to position **2** in the ignition lock (> page 136).

The transmitted destination address is loaded into the vehicle's navigation system.

A display message appears, asking whether navigation should be started.

- ▶ Select **Yes** by turning  or sliding  the controller and confirm with .

The system calculates the route and subsequently starts the route guidance with the address entered.

If you select **No** the address can be stored in the address book.

If you have sent more than one destination address, each individual destination must be confirmed separately.

Destination addresses are loaded in the same order as the order in which they were sent.

If you own multiple Mercedes-Benz vehicles with mbrace and activated mbrace accounts:

If multiple vehicles are registered under the same e-mail address, the destination will be sent to all the vehicles.

### Vehicle remote opening

You can use the vehicle remote opening if you have unintentionally locked your vehicle and a replacement SmartKey is not available.

The vehicle can be opened by the Mercedes-Benz Customer Assistance Center.

The vehicle can be immediately opened remotely within four days of the ignition being turned off. After this time, the remote unlocking may be delayed by 15 to 60 minutes. After 30 days, the vehicle can no longer be opened remotely.

The vehicle remote unlocking feature is available if the relevant mobile phone network is available and a data connection is possible.

- ▶ Contact the following service hotlines:  
Mercedes-Benz Customer Assistance Center at 1-800-FOR-MERCEdes (1-800-367-6372) or 1-866-990-9007  
You will be asked for your password.
- ▶ Return to your vehicle at the time agreed upon with the Mercedes-Benz Customer Assistance Center.

Alternatively, the vehicle can be opened via:

- the Internet, under the "Owners Online" section
- telephone applications (e.g. for iPhone®, Android™)

To do this, you will need your identification number and password.

### Vehicle remote closing

The vehicle remote closing feature can be used when you have forgotten to lock the vehicle and you are no longer nearby.

The vehicle can then be locked by the Mercedes-Benz Customer Assistance Center.

The vehicle can be immediately remotely locked within four days of the ignition being turned off. After this time, remote closing may be delayed by 15 to 60 minutes. After 30 days the vehicle can no longer be locked remotely.

The vehicle remote closing feature is available if the relevant mobile phone network is available and a data connection is possible.

- ▶ Contact the following service hotlines:  
Mercedes-Benz Customer Assistance Center at 1-800-FOR-MERCEdes (1-800-367-6372) or 1-866-990-9007  
You will be asked for your password.

The next time you are inside the vehicle and you switch on the ignition, the **Doors Locked Remotely** message appears in the multifunction display.

Alternatively, the vehicle can be locked via:

- the Internet, under the "Owners Online" section
- telephone applications (e.g. for iPhone®, Android™)

To do this, you will need your identification number and password.

### Stolen vehicle recovery service

If your vehicle has been stolen:

- ▶ Notify the police.  
The police will issue a numbered incident report.
- ▶ This number will be forwarded to the Mercedes-Benz Customer Assistance Center together with your PIN.  
The Mercedes-Benz Customer Assistance Center then tries to locate the system. The Mercedes-Benz Customer Assistance Center contacts you and the local law enforcement agency if the vehicle is located.  
However, only the law enforcement agency is informed of the location of the vehicle.

If the anti-theft alarm system is activated for longer than 30 seconds, the Mercedes-Benz Customer Assistance Center is automatically notified.

### Vehicle Health Check

With the Vehicle Health Check, the Customer Assistance Center can provide improved support for problems with your vehicle. During an

existing call, vehicle data is transferred to the Customer Assistance Center.

The customer service representative can use the received data to decide what kind of assistance is required. You are then, for example, guided to the nearest Mercedes-Benz Service Center or a recovery vehicle is called.

If vehicle data need to be transferred during an Info call or a Roadside Assistance call, this is initiated by the Customer Assistance Center.

You will see the **Roadside Assistance Connected** message in the display. If the Vehicle Health Check can be started, the **Request for Vehicle Diagnostics Received Start vehicle diagnostics?** message appears in the display.

- ▶ Press the **Yes** button to confirm the message.
- ▶ If the **Vehicle Diagnostics Please Start Ignition** message appears: turn the SmartKey to position **2** in the ignition lock (▷ page 136).
- ▶ If the **Please follow the instructions received by phone and move your vehicle to a safe position.** message appears: please follow the instructions received by phone and move your vehicle to a safe position.  
The message in the display disappears.  
The vehicle operating state check begins. You will see the **Vehicle Diagnostics Active** message.  
If you select **Cancel**, the Vehicle Health Check is canceled completely.

When the check is complete, the **Sending vehicle diagnostics data. (Voice connection may be interrupted during data transfer)** message appears. The vehicle data can now be sent.

- ▶ Press the **OK** button to confirm the message.  
The voice connection with the Customer Assistance Center is terminated.  
You will see the **Vehicle Diagnostics: Transferring Data...** message.  
The vehicle data is sent to the Customer Assistance Center.

Depending on what the customer service representative agreed with you, the voice connection is re-established after the transfer is complete. If necessary, you will be contacted at a later time by another means, e.g. by e-mail or phone.

Another function of the Vehicle Health Check is the transfer of service data to the Customer Assistance Center. If a service is due, the display shows a message to this effect together with information about any special offers at your workshop.

This information can also be called up under "Owners Online" at <http://www.mbusa.com>. Information on the data stored in the vehicle (▷ page 33).  
Information on Roadside Assistance (▷ page 30).

## Downloading routes

Downloading routes allows you to transfer and save predefined routes in the navigation system.

A route can be prepared and sent by either a customer service representative or under "Owners Online" at <http://www.mbusa.com>.

Each route can include up to four way points.

Once a route has been received by the navigation system, you will see the **Do you want to start route guidance? Destination Received destination has been saved in "Previous destinations"**. message on the multimedia system display.

The route is saved.

- ▶ **To start route guidance:** select **Yes**.  
An overview of the route is shown in the display.  
If you select **No**, the saved route can be called up later in the navigation menu.
- ▶ Select **Start**.  
Route guidance starts.

Downloaded and saved routes can be called up again.

## Speed alert

You can define the upper speed limit, which must not be exceeded by the vehicle.

If this selected speed is exceeded by the vehicle, a message will be sent to the Customer Assistance Center. The Customer Assistance Center then forwards this information to you.

You can select the way in which you receive this information beforehand. Possible options include text message, e-mail or an automated call.



The data you receive contains the following information:

- the location where the speed limit was exceeded
- the time at which the speed limit was exceeded
- the selected speed limit which was exceeded

## Geo fencing

Geo fencing allows you to select areas which the vehicle should not enter or leave. You will be informed if the vehicle crosses the boundaries of the selected areas. You can select the way in which you receive this information beforehand. Possible options include text message, e-mail or an automated call.

The area can be determined as either a circle or a polygon with a maximum of ten corners. You can specify up to ten areas simultaneously. Different settings are possible for each area.

These settings can be called up under "Owners Online" at <http://www.mbusa.com>.

Alternatively, you can trigger an Info call and notify the customer service representative that you wish to activate geo-fencing.

Currently inactive areas can be activated by text message.

## Triggering the vehicle alarm

With this function, you can trigger the vehicle's panic alarm via text message. An alarm sounds and the exterior lighting flashes. Depending on the setting, the panic alarm lasts five or ten seconds. Afterwards, the alarm switches off.

## Garage door opener

### General notes

The HomeLink® garage door opener integrated in the rear-view mirror allows you to operate up to three different door and gate systems.

Use the integrated garage door opener only on garage doors that:

- have safety stop and reverse features and
- meet current U.S. federal safety standards

Once programmed, the integrated garage door opener in the rear-view mirror will assume the function of the garage door system's remote

control. Please also read the operating instructions for the garage door system.

When programming a garage door opener, park the vehicle outside the garage. Do not run the engine while programming.

Certain garage door drives are incompatible with the integrated garage door opener. If you have difficulty programming the integrated garage door opener, contact an authorized Mercedes-Benz Center.

Alternatively, you can call the following telephone assistance services:

- **USA:** Mercedes-Benz Customer Assistance Center at 1-800-FOR-MERcedes
- **Canada:** Customer Service at 1-800-387-0100
- HomeLink® hotline 1-800-355-3515 (free of charge)

More information on HomeLink® and/or compatible products is also available online at <http://www.homelink.com>.

Notes on the declaration of conformity (> page 290).

USA: FCC ID: CB2HMIHL4

Canada: IC: 279B-HMIHL4

## Important safety notes

### WARNING

When you operate or program the garage door with the integrated garage door opener, persons in the range of movement of the garage door can become trapped or struck by the garage door. There is a risk of injury.

When using the integrated garage door opener, always make sure that nobody is within the range of movement of the garage door.

### WARNING

Combustion engines emit poisonous exhaust gases such as carbon monoxide. Inhaling these exhaust gases leads to poisoning. There is a risk of fatal injury. Therefore never leave the engine running in enclosed spaces without sufficient ventilation.



## Programming

### Programming buttons

Pay attention to the "Important safety notes" (▷ page 314).

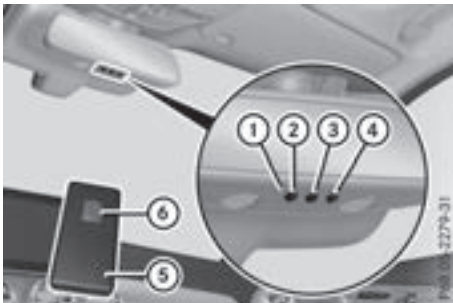

Garage door remote control ⑤ is not included with the integrated garage door opener.

▶ Turn the SmartKey to position ② in the ignition lock (▷ page 136).

▶ Select one of buttons ② to ④ to use to control the garage door drive.

▶ **To start programming mode:** press and hold one of buttons ② to ④ on the integrated garage door opener.

The garage door opener is in programming mode. After a short time, indicator lamp ① lights up yellow.

Indicator lamp ① lights up yellow as soon as button ②, ③ or ④ is stored for the first time. If the selected button has already been programmed, indicator lamp ① will only light up yellow after ten seconds have elapsed.

▶ Release button ②, ③ or ④. Indicator lamp ① flashes yellow.

▶ **To program the remote control:** point garage door remote control ⑤ towards buttons ② to ④ on the rear-view mirror at a distance of 2 to 8 in (5 to 20 cm).

▶ Press and hold button ⑥ on remote control ⑤ until indicator lamp ① lights up green. When indicator lamp ① lights up green: programming is finished.

When indicator lamp ① flashes green: programming was successful. The rolling code must be synchronized (▷ page 315).

▶ Release button ⑥ on remote control ⑤ for the garage door drive system.

If indicator lamp ① lights up red: repeat the programming procedure for the corresponding button on the rear-view mirror. When doing

so, vary the distance between remote control ⑤ and the rear-view mirror.

The required distance between remote control ⑤ and the integrated garage door opener depends on the garage door drive system. Several attempts might be necessary. You should test every position for at least 25 seconds before trying another position.

### Synchronizing the rolling code

Pay attention to the "Important safety notes" (▷ page 314).

If the garage door system uses a rolling code, you will also have to synchronize the garage door system with the integrated garage door opener in the rear-view mirror. To do this you will need to use the programming button on the door drive control panel. The programming button may be located in different places depending on the manufacturer. It is usually located on the door drive unit on the garage ceiling.

Familiarize yourself with the garage door drive operating instructions, for example under "Programming additional remote controls", before carrying out the following steps.

Your vehicle must be within reach of the garage door or gate opener drive. Make sure that neither your vehicle nor any persons/objects are present within the sweep of the door or gate.

▶ Turn the SmartKey to position ② in the ignition lock (▷ page 136).

▶ Get out of the vehicle.

▶ Press the programming button on the door drive unit.

Usually, you now have 30 seconds to initiate the next step.

▶ Get into the vehicle.

▶ Press previously programmed button ②, ③ or ④ on the integrated garage door opener repeatedly and in quick succession until the door closes.

The rolling code synchronization is then complete.

### Notes on programming the remote control

Canadian radio frequency laws require a "break" (or interruption) of the transmission signals after broadcasting for a few seconds. Therefore, these signals may not last long enough for the integrated garage door opener. The signal is not recognized during programming. Comparable

with Canadian law, some U.S. garage door openers also feature a "break".

Proceed as follows:

- if you live in Canada.
- if you have difficulties programming the garage door opener (regardless of where you live) when using the programming steps.
- ▶ Press and hold one of buttons ② to ④ on the integrated garage door opener. After a short time, indicator lamp ① lights up yellow.
- ▶ Release the button. Indicator lamp ① flashes yellow.
- ▶ Press button ⑥ of garage door remote control ⑤ for two seconds, then release it for two seconds.
- ▶ Press button ⑥ of the remote control ⑤ again and hold for two seconds.
- ▶ Repeat this sequence on button ⑥ of remote control ⑤ until indicator lamp ① lights up green. When indicator lamp ① lights up green: programming is finished. When indicator lamp ① flashes green: programming was successful. The next step is to synchronize the rolling code.
- ▶ Release button ⑥ of remote control ⑤ of the garage door drive. If indicator lamp ① lights up red: repeat the programming process for the corresponding button on the rear-view mirror. When doing so, vary the distance between remote control ⑤ and the rear-view mirror. The required distance between remote control ⑤ and the integrated garage door opener depends on the garage door drive system. Several attempts might be necessary. You should test every position for at least 25 seconds before trying another position.

### Problems when programming

If you are experiencing problems programming the integrated garage door opener on the rear-view mirror, take note of the following instructions:

- Check the transmitter frequency used by garage door drive remote control ⑤ and whether it is supported. The transmitter frequency can usually be found on the back of remote control ⑤ for the garage door drive.

The garage door opener is compatible with devices which operate in the frequency range of 280 to 433 MHz.

- Replace the batteries in garage door remote control ⑤. This increases the likelihood that garage door remote control ⑤ will transmit a strong and precise signal to the integrated garage door opener.
- When programming, hold remote control ⑤ at varying distances and angles and from buttons ② to ④ which you are programming. Try various angles at a distance between 2 and 8 inches (5 to 20 cm) or at the same angle but at varying distances.
- If another remote control ⑤ is available for the same garage door drive, repeat the same programming steps with this remote control ⑤. Before performing these steps, make sure that new batteries have been installed in garage door drive remote control ⑤.
- Note that some remote controls only transmit for a limited amount of time (the indicator lamp on the remote control goes out). Press button ⑥ on remote control ⑤ again before transmission ends.
- Align the antenna cable of the garage door opener unit. This can improve signal reception/transmission.

### Opening/closing the garage door

After it has been programmed, the integrated garage door opener performs the function of the garage door system remote control. Please also read the operating instructions for the garage door system.

- ▶ Turn the SmartKey to position ② in the ignition lock (▷ page 136).
- ▶ Press button ②, ③ or ④ which you programmed to operate the garage door. Garage door system with a fixed code: indicator lamp ① lights up green. Garage door system with a rolling code: indicator lamp ① flashes green. The transmitter will transmit a signal as long as the button is pressed. The transmission is halted after a maximum of ten seconds and indicator lamp ① lights up yellow.
- ▶ Press button ②, ③ or ④ again if necessary.

## Clearing the memory

Make sure that you clear the memory of the integrated garage door opener before selling the vehicle.

- ▶ Turn the SmartKey to position **2** in the ignition lock (▶ page 136).
- ▶ Press and hold buttons **2** and **4**.  
The indicator lamp initially lights up yellow and then green.
- ▶ Release buttons **2** and **4**.  
The memory of the integrated garage door opener in the rear-view mirror is cleared.

## Floormats

### WARNING

Objects in the driver's footwell can restrict the pedal travel or obstruct a depressed pedal. The operating and road safety of the vehicle is jeopardized. There is a risk of an accident.

Make sure that all objects in the vehicle are stowed correctly, and that they cannot enter the driver's footwell. Install the floormats securely and as specified in order to ensure sufficient clearance for the pedals. Do not use loose floormats and do not place floormats on top of one another.



- ▶ Slide the relevant seat back.
- ▶ **To install:** place the floormat in the footwell.
- ▶ Press studs **1** onto retainers **2**.
- ▶ **To remove:** pull the floormat off retainers **2**.
- ▶ Remove the floormat.

## Engine compartment

### Hood

#### Important safety notes

##### WARNING

If the hood is unlatched, it may open up when the vehicle is in motion and block your view. There is a risk of an accident.

Never unlatch the hood while driving. Before every trip, ensure that the hood is locked.

##### WARNING

When opening and closing the hood, it may suddenly fall into the closed position. There is a risk of injury to persons within range of movement of the hood.

Open and close the hood only when no one is within its range of movement.

##### WARNING

Opening the hood when the engine is overheated or when there is a fire in the engine compartment could expose you to hot gases or other service products. There is a risk of injury.

Let an overheated engine cool down before opening the hood. If there is a fire in the engine compartment, keep the hood closed and contact the fire department.

##### WARNING

The engine compartment contains moving components. Certain components, such as the radiator fan, may continue to run or start again suddenly when the ignition is off. There is a risk of injury.

If you need to do any work inside the engine compartment:

- switch off the ignition
- never reach into the area where there is a risk of danger from moving components, such as the fan rotation area

- remove jewelry and watches
- keep items of clothing and hair, for example, away from moving parts

**Hybrid vehicles:** be sure to observe the notes in the supplementary instructions. Otherwise, you may not recognize dangers.

#### Opening the hood

##### WARNING

Certain components in the engine compartment, such as the engine, radiator and parts of the exhaust system, can become very hot. Working in the engine compartment poses a risk of injury.

Where possible, let the engine cool down and touch only the components described in the following.

##### WARNING

When the hood is open and the windshield wipers are set in motion, you can be injured by the wiper linkage. There is a risk of injury.

Always switch off the windshield wipers and the ignition before opening the hood.

- ❗ Make sure that the windshield wipers are not folded away from the windshield. You could otherwise damage the windshield wipers or the hood.



- ▶ Make sure that the windshield wipers are turned off.
- ▶ Pull release lever ① on the hood. The hood is released.



- ▶ Reach into the gap, pull hood catch handle ② up and lift the hood.

If you lift the hood by approximately 15 in (40 cm), the hood is opened and held open automatically by the gas-filled strut.

### Closing the hood

- ▶ Lower the hood and let it fall from a height of approximately 8 in (20 cm).
- ▶ Check that the hood has engaged properly. If the hood can be raised slightly, it is not properly engaged. Open it again and close it with a little more force.

### Radiator

Do not cover up the radiator, such as with a thermal mat or insect protection cover. Otherwise, the values of the European on-board diagnostics may be affected. Some of these readings are required by law and must be accurate at all times.

### Engine oil

### Important safety notes

#### WARNING

Certain components in the engine compartment, such as the engine, radiator and parts of the exhaust system, can become very hot. Working in the engine compartment poses a risk of injury.

Where possible, let the engine cool down and touch only the components described in the following.

#### WARNING

The engine compartment contains moving components. Certain components, such as the radiator fan, may continue to run or start again suddenly when the ignition is off. There is a risk of injury.

If you need to do any work inside the engine compartment:

- switch off the ignition
- never reach into the area where there is a risk of danger from moving components, such as the fan rotation area
- remove jewelry and watches
- keep items of clothing and hair, for example, away from moving parts

#### WARNING

If engine oil comes into contact with hot components in the engine compartment, it may ignite. There is a risk of fire and injury.

Make sure that engine oil is not spilled next to the filler neck. Let the engine cool down and thoroughly clean the engine oil off the components before starting the engine.

#### WARNING

Opening the hood when the engine is overheated or when there is a fire in the engine compartment could expose you to hot gases or other service products. There is a risk of injury.

Let an overheated engine cool down before opening the hood. If there is a fire in the engine compartment, keep the hood closed and contact the fire department.

**Hybrid vehicles:** be sure to observe the notes in the supplementary instructions. Otherwise, you may not recognize dangers.

### General notes

Depending on your driving style, the vehicle consumes up to 0.9 US qt (0.8 l) of oil per 600 miles (1,000 km). The oil consumption may be higher than this when the vehicle is new or if you frequently drive at high engine speeds.

Depending on the engine, the oil dipstick may be in a different location.

To check the engine oil level:

- park the vehicle on a level surface
- the engine should be switched off for approximately five minutes if the engine is at normal operating temperature

### Checking the oil level using the oil dipstick



Example: checking the engine oil level using the oil dipstick

- ▶ Pull oil dipstick ① out of the dipstick guide tube.
- ▶ Wipe off oil dipstick ①.
- ▶ Slowly slide oil dipstick ① into the guide tube to the stop and take it out again after approximately three seconds.  
If the level is between MIN mark ③ and MAX mark ②, the oil level is correct.
- ▶ If the engine oil level has dropped to MIN mark ③ or below, top up with 1.1 US qt (1.0 l) of engine oil.

### Checking the oil level using the on-board computer

**Mercedes-AMG GLC 63 4MATIC+ / GLC 63 S 4MATIC+:** the oil level can only be checked using the on-board computer.

- ▶ Make sure that the SmartKey is in position **2** in the ignition lock.
- ▶ Press or on the steering wheel to select the following message: **Measuring Engine Oil Level Accurate Only When Vehicle Is Level**

The measurement takes a few seconds. You will see one of the following messages in the multifunction display:

- **Engine Oil Level OK.**
  - **Add 1.1 Liter Engine Oil at Next Refueling.**
- ▶ Add oil if necessary.

If the engine is at normal operating temperature and the **Reduce Engine Oil Level** message appears, too much oil has been added.

- ▶ Have excess oil siphoned off.

If the **For Engine Oil Level Ignition Must Be On** message appears:

- ▶ Turn the SmartKey to position **2** in the ignition lock (▶ page 136).

If the **Need More Time to Check Engine Oil Level** message appears:

- ▶ **If the engine is at normal operating temperature:** repeat the measurement after approximately five minutes.
- ▶ **If the engine is not at normal operating temperature:** e.g. if the engine was only started briefly, repeat the measurement after approximately 30 minutes.

If the **Engine Oil Level Not Measurable with Engine Running** message appears:

- ▶ Switch off the engine.
- ▶ **If the engine is at normal operating temperature:** wait about five minutes before carrying out the measurement.
- ▶ **If the engine is not at normal operating temperature:** e.g. if the engine was only started briefly, wait approximately 30 minutes before carrying out the measurement.

If you wish to cancel the measurement, press the or button on the multifunction steering wheel.

### Adding engine oil

#### Environmental note

When adding oil, take care not to spill any. If oil enters the soil or waterways, it is harmful to the environment.

- ▶ Use only engine oils and oil filters that are approved for vehicles with a service system. A list of the engine oils and oil filters that have been tested and approved in accordance with



Mercedes-Benz Specifications for Service Products is available at any authorized Mercedes-Benz Center.

The following cause engine failure or damage to the exhaust system:

- Use of engine oils and oil filters that have not been expressly approved for the service system
- Replacement of engine oil and oil filter after the replacement interval specified by the service system has expired
- Use of engine oil additives

**!** Do not add too much oil. adding too much engine oil can result in damage to the engine or to the catalytic converter. Have excess engine oil siphoned off.



Add engine oil (example)

- ▶ Turn cap ① counter-clockwise and remove it.
- ▶ Add engine oil.  
If the oil level is at or below the MIN mark on the oil dipstick, add 1.1 US qt (1.0 l) of engine oil.
- ▶ Replace cap ① on the filler neck and tighten clockwise.  
Ensure that the cap locks into place securely.
- ▶ Check the oil level again with the oil dipstick (> page 320).

Further information on engine oil (> page 379).

### Additional service products

### Important safety notes

#### **!** WARNING

Certain components in the engine compartment, such as the engine, radiator and parts of the exhaust system, can become very hot.

Working in the engine compartment poses a risk of injury.

Where possible, let the engine cool down and touch only the components described in the following.

#### **!** WARNING

The engine compartment contains moving components. Certain components, such as the radiator fan, may continue to run or start again suddenly when the ignition is off. There is a risk of injury.

If you need to do any work inside the engine compartment:

- switch off the ignition
- never reach into the area where there is a risk of danger from moving components, such as the fan rotation area
- remove jewelry and watches
- keep items of clothing and hair, for example, away from moving parts

#### **!** WARNING

The cooling system is pressurized, particularly when the motor is warm. If you open the cap, you could be scalded if hot coolant sprays out. There is a risk of injury.

Let the engine cool down before you open the cap. Wear gloves and eye protection. Slowly open the cap to relieve pressure.

#### **!** WARNING

Opening the hood when the engine is overheated or when there is a fire in the engine compartment could expose you to hot gases or other service products. There is a risk of injury.

Let an overheated engine cool down before opening the hood. If there is a fire in the engine compartment, keep the hood closed and contact the fire department.



## Checking coolant level

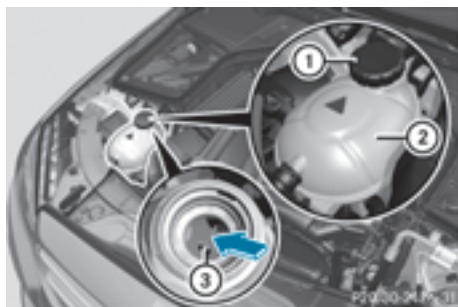

Checking the coolant level (example)

- ▶ Park the vehicle on a level surface.  
Only check the coolant level when the vehicle is on a level surface and the engine has cooled down.
- ▶ Turn the SmartKey to position **2** in the ignition lock (▶ page 136).

or

- ▶ Press the Start/Stop button twice on vehicles with KEYLESS-GO or the KEYLESS-GO start function (▶ page 137).
- ▶ Check the coolant temperature display in the instrument cluster (▶ page 37).  
The coolant temperature must be below 158 °F (70 °C).
- ▶ Turn the SmartKey to position **0** in the ignition lock (▶ page 136).

or

- ▶ Press the Start/Stop button once on vehicles with KEYLESS-GO or the KEYLESS-GO start function (▶ page 137).
- ▶ Slowly turn cap **1** half a turn counter-clockwise and allow excess pressure to escape.
- ▶ Turn cap **1** further counter-clockwise and remove it.  
If the coolant is at the level of marker bar **3** in the filler neck when cold, there is enough coolant in coolant expansion tank **2**.  
If the coolant level is approximately 0.6 in (1.5 cm) above marker bar **3** in the filler neck when warm, there is enough coolant in expansion tank **2**.
- ▶ If necessary, add coolant that has been tested and approved by Mercedes-Benz.
- ▶ Replace cap **1** and turn it clockwise as far as it will go.

For further information on coolant, see (▶ page 380).

## Adding washer fluid to the windshield washer system

### WARNING

Windshield washer concentrate could ignite if it comes into contact with hot engine components or the exhaust system. There is a risk of fire and injury.

Make sure that no windshield washer concentrate is spilled next to the filler neck.



Example: adding liquid to the windshield washer system

- ▶ **To open:** pull cap **1** upwards by the tab and open.
- ▶ Add the premixed washer fluid.
- ▶ **To close:** press cap **1** onto the filler neck until it engages.

If the washer fluid level drops below the recommended minimum fluid level of 1.1 US qt (1.0 l), a message appears in the multifunction display prompting you to add washer fluid (▶ page 267).

Further information on washer fluid (▶ page 381).

## ASSYST PLUS

### Service message

The ASSYST PLUS service interval display informs you of the next service due date. Information on the type of service and service intervals (see the separate Maintenance Booklet).

Further information can be obtained at a qualified specialist workshop, e.g. an authorized Mercedes-Benz Center, or at <http://www.mbusa.com> (USA only).

**i** The ASSYST PLUS service interval display does not show any information on the engine oil level. Observe the notes on the engine oil level (▷ page 319).

The multifunction display shows a service message for several seconds, e.g.:

- Service A in XX Days
- Service A Due
- Service A Overdue by XX Days

Depending on the operating conditions of the vehicle, the remaining time or distance until the next service due date is displayed.

The letter **A** or **B**, possibly in connection with a number or another letter, indicates the type of service. **A** stands for a minor service and **B** for a major service.

You can obtain further information from an authorized Mercedes-Benz Center.

The ASSYST PLUS service interval display does not take into account any periods of time during which the battery is disconnected.

Maintaining the time-dependent service schedule:

- ▶ Note down the service due date displayed in the multifunction display before disconnecting the battery.







or

- ▶ After reconnecting the battery, subtract the battery disconnection periods from the service date shown on the display.

### Hiding a service message

- ▶ Press the  or  button on the steering wheel.

### Displaying service messages

- ▶ Switch on the ignition.
- ▶ Use  on the steering wheel to call up the list of menus.
- ▶ Press  or  on the steering wheel to select the **Service** menu and confirm with .
- ▶ Press  or  on the steering wheel to select the **ASSYST PLUS** submenu and confirm with .

The service due date appears in the multifunction display.

### Information about Service

#### Resetting the ASSYST PLUS service interval display

**!** If the ASSYST PLUS service interval display has been inadvertently reset, this setting can be corrected at a qualified specialist workshop.

Have service work carried out as described in the Maintenance Booklet. This may otherwise lead to increased wear and damage to the major assemblies or the vehicle.

A qualified specialist workshop, e.g. an authorized Mercedes-Benz Center, will reset the ASSYST PLUS service interval display after the service work has been carried out. You can also obtain further information on maintenance work, for example.

#### Special service requirements

The specified maintenance interval takes only the normal operation of the vehicle into account. Under arduous operating conditions or increased load on the vehicle, maintenance work must be carried out more frequently, for example:

- Regular city driving with frequent intermediate stops
- If the vehicle is primarily used to travel short distances
- Use in mountainous terrain or on poor road surfaces
- If the engine is often left idling for long periods

Under these or similar conditions, have, for example, the air filter, engine oil and oil filter replaced or changed more frequently. Under arduous operating conditions, the tires must be checked more often. Further information can be obtained at a qualified specialist workshop, e.g. an authorized Mercedes-Benz Center.

#### Driving abroad

An extensive Mercedes-Benz Service network is also available in other countries. You can obtain further information from any authorized Mercedes-Benz Center.

## Care

### General notes

**!** When cleaning your car, do not use:

- dry, coarse or hard cloths
- abrasive cleaning agents
- solvents
- cleaning agents containing solvents

Do not scrub.

Do not touch the surfaces and films with hard objects, e.g. rings or ice scrapers. Otherwise, you may scratch or damage the surfaces and films.

**!** Do not park your vehicle for a long period of time directly after cleaning, particularly after cleaning the wheel rim with wheel cleaner. Wheel cleaner can lead to the increased corrosion of the brake discs and pads. Therefore, drive for a few minutes after cleaning. By heating up the brakes, the brake discs and pads dry. The vehicle can then be parked for a long period of time.

### Environmental note

Dispose of empty packaging and cleaning cloths in an environmentally responsible manner.

Regular care of your vehicle is a condition for retaining the quality in the long term.

Use care products and cleaning agents recommended and approved by Mercedes-Benz.

### Washing the vehicle and cleaning the paintwork

#### Automatic car wash

#### WARNING

Braking efficiency is reduced after washing the vehicle. There is a risk of an accident.

After the vehicle has been washed, brake carefully while paying attention to the traffic conditions until full braking power is restored.

**!** When Active Brake Assist, Distance Pilot DISTRONIC or the HOLD function is activated, the vehicle brakes automatically in certain situations.

To avoid damage to the vehicle, deactivate these systems in the following or similar situations:

- when towing the vehicle
- in the car wash

**!** Never clean your vehicle in a Touchless Automatic Car Wash as these use special cleaning agents. These cleaning agents can damage the paintwork or plastic parts.

**!** Make sure that:

- the side windows and sliding sunroof are closed completely
- the blower is switched off
- the windshield wiper switch is in position **O**
- the 360° camera or the rear view camera is deactivated

The vehicle may otherwise be damaged.

**!** If the SmartKey is within the rear detection range of KEYLESS-GO, the following situations, for example, could lead to the unintentional opening of the tailgate:

- when using an automatic car wash
- when using a power washer

Make sure that the SmartKey is at least 3 m away from the vehicle.

**!** If the SmartKey is within the rear detection range of KEYLESS-GO, the following situations, for example, could lead to the unintentional opening of the tailgate:

- when using an automatic car wash
- when using a power washer

Make sure that the SmartKey is at least 10 ft (3 m) away from the vehicle.

**!** Make sure that the automatic transmission is in neutral position **N** when washing your vehicle in a tow-through car wash. The vehicle may otherwise be damaged.

- Operating with the SmartKey:
  - Do not remove the SmartKey from the ignition lock. Do not open the driver's door when the engine is switched off or at very low speeds. Otherwise, when in transmission position **D** or **R**, the automatic transmission will automatically switch to park position **P** and block the wheels.
- Operating with the Start/Stop button:

Do not open the driver's door when the engine is switched off or at very low speeds. Otherwise, when in transmission position **D** or **R**, the automatic transmission will automatically switch to park position **P** and block the wheels.

Observe the following to make sure that the automatic transmission stays in neutral **N**:  
Operating with the SmartKey and Start/Stop button:

- ▶ Make sure that the ignition is switched on.
- ▶ Make sure that the vehicle is stationary.
- ▶ Depress and hold the brake pedal.

Operating with the Start/Stop button only:

- ▶ Engage park position **P**.
- ▶ Release the brake pedal.
- ▶ Remove the Start/Stop button from ignition lock (▷ page 137).
- ▶ Insert the SmartKey into the ignition lock.
- ▶ Switch on the ignition.
- ▶ Depress and hold the brake pedal.

Operating with the SmartKey and Start/Stop button:

- ▶ Shift to neutral **N**.
- ▶ Release the brake pedal.
- ▶ Release the electric parking brake, if necessary.
- ▶ Switch off the ignition and leave the SmartKey in the ignition lock.

You can wash the vehicle in an automatic car wash from the very start.

If the vehicle is very dirty, pre-wash it before cleaning it in an automatic car wash.

After using an automatic car wash, wipe off wax from the windshield and the wiper blades. This will prevent smears and reduce wiping noises caused by residue on the windshield.

## Washing by hand

In some countries, washing by hand is only allowed at specially equipped washing bays. Observe the legal requirements in each country.

- ▶ Do not use hot water and do not wash the vehicle in direct sunlight.
- ▶ Use a soft sponge to clean.
- ▶ Use a mild cleaning agent, such as a car shampoo approved by Mercedes-Benz.

- ▶ Thoroughly hose down the vehicle with a gentle jet of water.
- ▶ Do not point the water jet directly towards the air inlet.
- ▶ Use plenty of water and rinse out the sponge frequently.
- ▶ Rinse the vehicle with clean water and dry thoroughly with a chamois.
- ▶ Do not let the cleaning agent dry on the paintwork.

Carefully remove all deposits of road salt as soon as possible when driving in winter.

## Power washers

### WARNING

The water jet from a circular jet nozzle (dirt blasters) can cause invisible exterior damage to the tires or chassis components. Components damaged in this way may fail unexpectedly. There is a risk of an accident.

Do not use power washers with circular jet nozzles to clean the vehicle. Have damaged tires or chassis components replaced immediately.

- ! Always maintain a distance of at least 11.8 in (30 cm) between the vehicle and the power washer nozzle. Information about the correct distance is available from the equipment manufacturer.

Move the power washer nozzle around when cleaning your vehicle.

Do not aim directly at any of the following:

- tires
- door gaps, roof gaps, joints, etc.
- electrical components
- battery
- plug-type couplings
- lights
- seals
- trim
- ventilation slots

Damaged seals or electrical components can lead to leaks or failures.

- ! Vehicles with decorative foil: parts of your vehicle are covered with decorative foil. Maintain a distance of at least 27.5 in (70 cm)

between the foil-wrapped parts of the vehicle and the nozzle of the high pressure cleaner.

Information about the correct distance is available from the equipment manufacturer.

Move the power washer nozzle around when cleaning your vehicle.

The water temperature of the high-pressure cleaner must not exceed 140 °F (60 °C).

**!** If the SmartKey is within the rear detection range of KEYLESS-GO, the following situations, for example, could lead to the unintentional opening of the tailgate:

- when using an automatic car wash
- when using a power washer

Make sure that the SmartKey is at least 10 ft (3 m) away from the vehicle.

## Cleaning the paintwork

**!** Do not affix:

- stickers
- films
- magnetic plates or similar items to painted surfaces. You could otherwise damage the paintwork.

Scratches, corrosive deposits, areas affected by corrosion and damage caused by inadequate care cannot always be completely repaired. In such cases, visit a qualified specialist workshop.

- ▶ Remove dirt immediately, where possible, while avoiding rubbing too hard.
- ▶ Soak insect remains with insect remover and rinse off the treated areas afterwards.
- ▶ Soak bird droppings with water and rinse off the treated areas afterwards.
- ▶ Remove coolant, brake fluid, tree resin, oils, fuels and greases by rubbing gently with a cloth soaked in petroleum ether or lighter fluid.
- ▶ Use tar remover to remove tar stains.
- ▶ Use silicone remover to remove wax.

If water no longer forms "beads" on the paint surface, use the paint care products recommended and approved by Mercedes-Benz. This is the case approximately every three to five months, depending on the climate conditions and the care product used.

The cleaning product Paint Cleaner, which has been recommended and approved by

Mercedes-Benz, should be used when dirt has penetrated the paint surface.

Also use Paint Cleaner on paint that has become dull.

Do not use these care products in the sun or on the hood while the hood is hot.

- ▶ Use a suitable touch-up stick, e.g. MB Touch-Up Stick, to repair slight damage to the paintwork quickly and provisionally.

## Matte finish care

**!** Never polish the vehicle or the light alloy wheels. Polishing causes the finish to shine.

**!** The following can give the paint a glossy appearance and thus reduce the matt effect:

- Rubbing hard with unsuitable agents
- Washing the vehicle in direct sunlight

**!** Never use paint cleaner, buffing or polishing products, or gloss preserver, e.g. wax, for the purpose of paintwork care. These products are only suitable for high-gloss surfaces. Their use on vehicles with matte paintwork leads to considerable surface damage or, more specifically, to shiny, spotted areas.

Always have paintwork repairs carried out at a qualified specialist workshop.

**!** Only use automatic car washes which correspond to the latest technological standards. Never use wash programs which finish by treating the vehicle with hot wax.

Observe these notes if your vehicle has a clear matte finish. This will help you to avoid damage to the paintwork due to incorrect treatment.

These notes also apply to light alloy wheels with a clear matte finish.

Use only insect remover and car shampoo from the range of approved Mercedes-Benz care products.

## Cleaning the vehicle parts

### Cleaning the wheels

#### WARNING

The water jet from a circular jet nozzle (dirt blasters) can cause invisible exterior damage to the tires or chassis components. Compo-

nents damaged in this way may fail unexpectedly. There is a risk of an accident.

Do not use power washers with circular jet nozzles to clean the vehicle. Have damaged tires or chassis components replaced immediately.

- ❗ Do not use acidic wheel cleaning products to remove brake dust. This could damage wheel bolts and brake components.
- ❗ Do not park your vehicle for a long period of time directly after cleaning, particularly after cleaning the wheel rim with wheel cleaner. Wheel cleaner can lead to the increased corrosion of the brake discs and pads. Therefore, drive for a few minutes after cleaning. By heating up the brakes, the brake discs and pads dry. The vehicle can then be parked for a long period of time.

### Cleaning the windows

#### WARNING

You could become trapped by the windshield wipers if they start moving while cleaning the windshield or wiper blades. There is a risk of injury.

Always switch off the windshield wipers and the ignition before cleaning the windshield or wiper blades.

- ❗ Do not use dry cloths, abrasive products, solvents or cleaning agents containing solvents to clean the inside of the windows. Do not touch the insides of the windows with hard objects, e.g. an ice scraper or ring. There is otherwise a risk of damaging the windows.
- ❗ Clean the water drainage channels of the windshield and the rear window at regular intervals. Deposits such as leaves, petals and pollen may under certain circumstances prevent water from draining away. This can lead to corrosion damage and damage to electronic components.
- ▶ Clean the inside and outside of the windows with a damp cloth and a cleaning product that is recommended and approved by Mercedes-Benz.

### Cleaning wiper blades

#### WARNING

You could become trapped by the windshield wipers if they start moving while cleaning the windshield or wiper blades. There is a risk of injury.

Always switch off the windshield wipers and the ignition before cleaning the windshield or wiper blades.

- ❗ Do not pull the wiper blade. Otherwise, the wiper blade could be damaged.
- ❗ Do not clean wiper blades too often and do not rub them too hard. Otherwise, the graphite coating could be damaged. This could cause wiper noise.
- ❗ Hold the wiper arm securely when folding back. The windshield could be damaged if the wiper arm smacks against it suddenly.
- ▶ Move the wiper arms to a vertical position (▷ page 121) and fold away from the windshield.
- ▶ Carefully clean the wiper blades with a damp cloth.
- ▶ Fold the windshield wiper arms back again before switching on the ignition.

### Cleaning the exterior lighting

- ❗ Only use cleaning agents or cleaning cloths which are suitable for plastic light lenses. Unsuitable cleaning agents or cleaning cloths could scratch or damage the plastic light lenses.
- ▶ Clean the plastic lenses of the exterior lighting using a wet sponge and a mild cleaning agent, e.g. Mercedes-Benz car shampoo or cleaning cloths.

### Cleaning the mirror turn signals

- ❗ Only use cleaning agents or cleaning cloths that are suitable for plastic lenses. Unsuitable cleaning agents or cleaning cloths could scratch or damage the plastic lenses of the mirror turn signals.
- ▶ Clean the plastic lenses of the mirror turn signals in the exterior mirror housing using a wet sponge and mild cleaning agent, e.g.



Mercedes-Benz car shampoo or cleaning cloths.

### Cleaning the side running board

**!** Do not clean the aluminum insert of the side running board with alkaline or acid-based cleaning agents, such as wheel cleaner. Do not use acidic wheel cleaners to remove brake dust. The aluminum inserts could otherwise be damaged.

### Cleaning the sensors

**!** If you clean the sensors with a power washer, make sure that you keep a distance of at least 11.8 in (30 cm) between the vehicle and the power washer nozzle. Information about the correct distance is available from the equipment manufacturer.

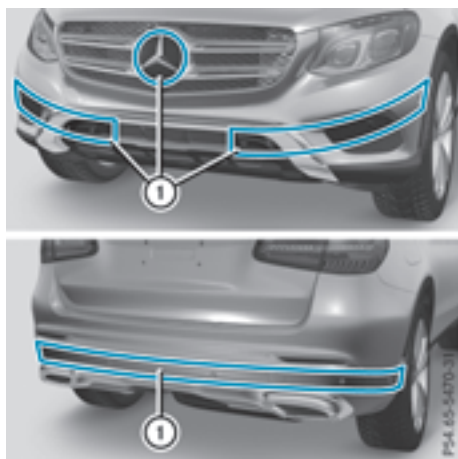

▶ Clean sensors ① of the driving systems with water, car shampoo and a soft cloth.

### Cleaning the rear view camera and 360° Camera

**!** Do not clean the camera lens and the area around the rear view camera or 360° camera with a power washer.



▶ Make sure that the vehicle is stationary.  
▶ Turn the SmartKey to position ① or ② in the ignition lock (▷ page 136).

or

▶ Press the Start/Stop button once or twice on vehicles with KEYLESS-GO or the KEYLESS-GO start function (▷ page 137).  
▶ Open the camera cover for cleaning via the multimedia system (see Digital Operator's Manual).  
▶ **To clean the camera:** use clean water and a soft cloth to clean camera lens ①.

When you switch off the ignition, the camera cover closes automatically.

### Cleaning the exhaust pipes

#### **⚠ WARNING**

The exhaust tail pipe and tail pipe trim can become very hot. If you come into contact with these parts of the vehicle, you could burn yourself. There is a risk of injury.

Always be particularly careful around the exhaust tail pipe and the tail pipe trim. Allow these components to cool down before touching them.

**!** Do not clean the exhaust pipe with acid-based cleaning agents, such as bathroom cleaner or wheel cleaner.

**!** Mercedes-AMG GLC 63 and Mercedes-AMG GLC 63 S with black exhaust pipes: black chrome trims must not be polished with a chrome polish as this will cause them to lose their black shine. For optimal care, the faceplates should be rubbed with a lightly oiled cloth after every car wash. Commercially



available engine and care oils are suitable for this.

For heavier soiling, you can apply a fine paintwork polish with a microfiber cloth. Remove the excess polish residue after polishing.

Impurities combined with the effects of road grit and corrosive environmental factors may cause flash rust to form on the surface. You can restore the original shine of the exhaust pipe by cleaning it regularly, especially in winter and after washing.

- ▶ Clean the exhaust pipe with a care product tested and approved by Mercedes-Benz.

## Cleaning the trailer tow hitch



### Environmental note

Dispose of rags soaked in oil and grease in an environmentally responsible manner.

- ❗ Please note the care instructions in the trailer coupling manufacturer's operating instructions.

The ball coupling must be cleaned if it becomes dirty or corroded.

- ▶ Remove rust on the ball, e.g. with a wire brush.
- ▶ Remove dirt with a clean, lint-free cloth or a brush.
- ▶ After cleaning, lightly oil or grease the ball coupling.
- ▶ Check that the vehicle's trailer tow hitch is working properly.

You can also have the maintenance work on the ball coupling and the trailer tow hitch carried out by a qualified specialist workshop.

## Interior care

### Cleaning the display

- ❗ For cleaning, do not use any of the following:
  - alcohol-based thinner or gasoline
  - abrasive cleaning agents
  - commercially-available household cleaning agents

These may damage the display surface. Do not put pressure on the display surface when

cleaning. This could lead to irreparable damage to the display.

- ▶ Before cleaning the display, make sure that it is switched off and has cooled down.
- ▶ Clean the display surface using a commercially available microfiber cloth and TFT/LCD display cleaner.
- ▶ Dry the display surface using a dry microfiber cloth.

### Cleaning the plastic trim



### WARNING

Care products and cleaning agents containing solvents cause surfaces in the cockpit to become porous. As a result, plastic parts may come loose in the event of air bag deployment. There is a risk of injury.

Do not use any care products and cleaning agents to clean the cockpit.

- ❗ Never attach the following to plastic surfaces:

- stickers
- films
- perfume oil container or similar

You could otherwise damage the plastic.

- ❗ Do not allow cosmetics, insect repellent or sunscreen to come into contact with the plastic trim. This maintains the high-quality look of the surfaces.

- ▶ Wipe the plastic trim with a damp, lint-free cloth, e.g. a microfiber cloth.
- ▶ **Heavy soiling:** use care and cleaning products recommended and approved by Mercedes-Benz. The surface may change color temporarily. Wait until the surface is dry again.

### Cleaning the steering wheel and selector lever

- ▶ Thoroughly wipe with a damp cloth or use leather care agents that have been recommended and approved by Mercedes-Benz.

## Cleaning genuine wood and trim elements

❗ Do not use solvent-based cleaning agents such as tar remover, wheel cleaners, polishes or waxes. There is otherwise a risk of damaging the surface.

❗ Do not use chrome polish on trim pieces. The trim pieces have a chrome look but are mostly made of anodized aluminum and can lose their shine if chrome polish is used. Use a damp, lint-free cloth instead when cleaning the trim pieces.

If the chrome-plated trim pieces are very dirty, you can use a chrome polish. If you are unsure as to whether the trim pieces are chrome-plated or not, consult an authorized Mercedes-Benz Center.

- ▶ Wipe the wooden trim and trim pieces with a damp, lint-free cloth, e.g. a microfiber cloth.
- ▶ **Trim elements with piano black finish:** wipe with a soft, damp cotton cloth. Use clean water.
- ▶ **Heavy soiling:** use care and cleaning products recommended and approved by Mercedes-Benz.

## Cleaning the seat covers

### General notes

❗ Do not use a microfiber cloth to clean covers made out of real leather, artificial leather or DINAMICA. If used often, these can damage the cover.

Note that regular care is essential to ensure that the appearance and comfort of the covers is retained over time.

### Genuine leather seat covers

❗ To retain the natural appearance of the leather, observe the following cleaning instructions:

- Clean genuine leather covers carefully with a damp cloth and then wipe the covers down with a dry cloth.
- Make sure that the leather does not become soaked. It may otherwise become rough and cracked.
- Only use leather care agents that have been tested and approved by Mercedes-

Benz. You can obtain these from a qualified specialist workshop.

Leather is a natural product.

It exhibits natural surface characteristics, for example:

- differences in the texture
- marks caused by growth and injury
- slight nuances of color

These are characteristics of leather and not material defects.

### Seat covers of other materials

❗ Observe the following when cleaning:

- clean artificial leather covers with a cloth moistened with a solution containing 1% detergent (e.g. dish washing liquid).
- clean cloth covers with a microfiber cloth moistened with a solution containing 1% detergent (e.g. dish washing liquid). Rub carefully and always wipe entire seat sections to avoid leaving visible lines. Leave the seat to dry afterwards. Cleaning results depend on the type of dirt and how long it has been there.
- clean DINAMICA covers with a damp cloth. Make sure that you wipe entire seat sections to avoid leaving visible lines.

## Cleaning the seat belts

### WARNING

Seat belts can become severely weakened if bleached or dyed. This could cause the seat belts to tear or fail, for instance, in the event of an accident. This poses an increased risk of injury or fatal injury.

Never bleach or dye the seat belts.

❗ Do not clean the seat belts using chemical cleaning agents. Do not dry the seat belts by heating at temperatures above 176 °F (80 °C) or in direct sunlight.

- ▶ Use clean, lukewarm water and soap solution.

### **Cleaning the headliner and carpets**

---

- ▶ **Headliner:** if it is very dirty, use a soft brush or dry shampoo.
- ▶ **Carpets:** use the carpet and textile cleaning agents recommended and approved by Mercedes-Benz.

## Where will I find...?

## Reflective safety jacket

## Removing/replacing the reflective safety jacket



The reflective safety jackets are located in the safety jacket compartments in the stowage compartments of the front doors. There are also safety jacket compartments in the stowage compartments of the rear doors, in which reflective safety jackets can be stowed.

- ▶ **To remove:** pull out safety jacket bag ① with the reflective safety jacket by loop ②.
  - ▶ Open safety jacket bag ① and pull out the reflective safety jacket.
  - ▶ **To stow:** fold the reflective safety jacket, roll it up and stow it in safety jacket bag ①.
  - ▶ Slide safety jacket bag ① along the lower edge of the armrest into the safety jacket compartment. Meanwhile, ensure that loop ② hangs out well within reach.
  - ▶ Observe the legal requirements in each individual country for the use of safety jackets.
- i** Remove a new reflective safety jacket from its packaging material before sliding it into the safety jacket compartment. The packaging material may otherwise cause it to slip out or make removing it difficult.

## Information on reflective safety jackets



- ① Maximum number of washes
  - ② Maximum wash temperature
  - ③ Do not bleach
  - ④ Do not iron
  - ⑤ Do not use a laundry dryer
  - ⑥ Do not dry-clean
  - ⑦ This is a class 2 jacket
- The safety jackets only meet the requirements defined by the legal standard:
    - if the correct size is used
    - if the reflective safety jackets are correctly fastened
  - Before use, ensure that the reflective safety jackets are clean and intact. The special properties may otherwise be compromised.
  - The reflective safety jackets should be stored in their original packaging in a dry place away from sources of heat and light.
  - The maximum number of washes specified is not the only factor influencing the life span of the reflective safety jackets. Their life span also depends on use, care, storage, etc.
  - The reflective safety jackets should be disposed of and replaced with new ones:
    - after 15 washes, and/or
    - if the reflective strips have become scratched, and/or
    - if the backing material and/or reflective strips have become soiled and cannot be cleaned off, and/or
    - if the fluorescence has faded, for example due to the effects of sunlight
  - Dispose of reflective safety jackets in an environmentally responsible manner. To do so, contact your local waste disposal company.

## Towing eye

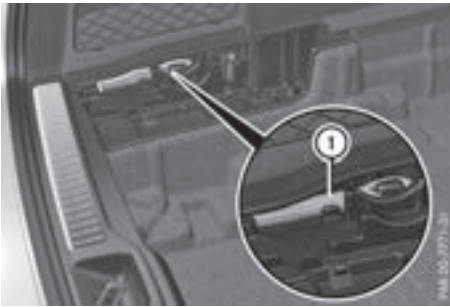

Towing eye ① is located in the left-hand stowage well under the cargo compartment floor.

- ▶ **To remove:** open the tailgate.
- ▶ Open the cargo compartment floor (▷ page 300).
- ▶ Remove towing eye ①.

## Vehicles with a TIREFIT kit

### Removing the TIREFIT kit

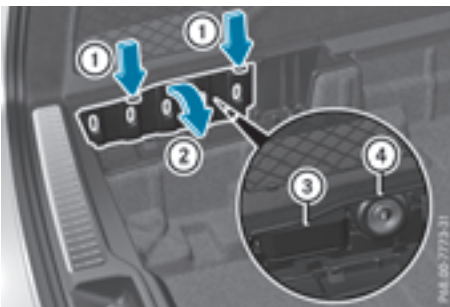

The TIREFIT kit is located in the left-hand stowage compartment.

- ▶ **To remove:** open the tailgate.
- ▶ Open the cargo compartment floor (▷ page 300).
- ▶ Push retaining clamps ① on the cover down so as to release them.
- ▶ Fold up cover in the direction of arrow ②.
- ▶ Remove tire inflation compressor ③ and tire sealant bottle ④.
- ▶ Use the TIREFIT kit (▷ page 335).

## Vehicles with a tire-change tool kit

### General notes

Apart from certain country-specific variations, the vehicles are not equipped with a tire-change tool kit.

Some tools for changing a wheel are specific to the vehicle. For more information on which tire changing tools are required and approved to perform a wheel change on your vehicle, consult a qualified specialist workshop.

Necessary tire-changing tools can include, for example:

- Jack
- Wheel chock
- Lug wrench
- Alignment bolt

### Removing the tire-change tool kit

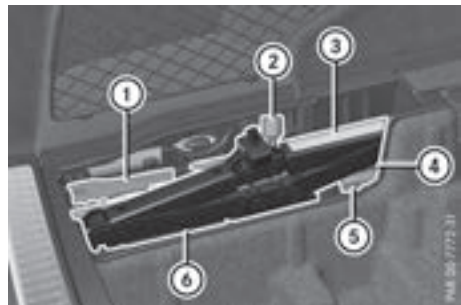

Example

- ① Ratchet for jack
- ② Lug wrench
- ③ Jack
- ④ Alignment bolt
- ⑤ Socket wrench for ratchet
- ⑥ Folding wheel chock

The tire-change tool kit is located in the left-hand stowage well, under the cargo compartment floor.

- ▶ **To remove:** open the tailgate.
- ▶ Open the cargo compartment floor (▷ page 300).

## Flat tire

### Preparing the vehicle

Your vehicle may be equipped with:

- MOExtended tires (tires with run-flat properties) (▷ page 334)

Vehicle preparation is not necessary on vehicles with MOExtended tires

- a TIREFIT kit (▷ page 333)

Vehicles equipped with MOExtended tires are not equipped with a TIREFIT kit at the factory. It is therefore recommended that you additionally equip your vehicle with a TIREFIT kit if you mount tires that do not feature run-flat properties, e.g. winter tires. A TIREFIT kit may be obtained from a qualified specialist workshop.

Vehicles with an mbrace system (USA only) that are not equipped with a TIREFIT kit: in the event of a flat tire, contact the Customer Assistance Center of the mbrace emergency call system (▷ page 308).

Information on changing and mounting wheels (▷ page 370).

- ▶ Stop the vehicle on solid, non-slippery and level ground, as far away as possible from traffic.
- ▶ Switch on the hazard warning lamps.
- ▶ Secure the vehicle against rolling away (▷ page 158).
- ▶ If possible, bring the front wheels into the straight-ahead position.
- ▶ Switch off the engine.
- ▶ Remove the SmartKey from the ignition lock. or, in vehicles with KEYLESS-GO start-function or KEYLESS-GO
- ▶ Open the driver's door.  
The vehicle electronics are now in position . which is the same as the SmartKey having been removed.
- ▶ Remove the Start/Stop button from the ignition lock (▷ page 137).
- ▶ Make sure that the engine cannot be started via your smartphone (▷ page 139).
- ▶ Make sure that the passengers are not endangered as they do so. Make sure that no one is near the danger area while a wheel is being changed. Anyone who is not directly assisting in the wheel change should, for example, stand behind the barrier.

- ▶ Get out of the vehicle. Pay attention to traffic conditions when doing so.
- ▶ Close the driver's door.

### Vehicles with MOExtended tires (tires with run-flat characteristics)

#### General notes

With MOExtended tires (tires with run flat characteristics), you can continue to drive your vehicle even if there is a total loss of pressure in one or more tires. The affected tire must not show any clearly visible damage.

You can recognize a MOExtended tire by the MOExtended marking which appears on the sidewall of the tire. You will find this marking next to the tire size designation, the load-bearing capacity and the speed index (▷ page 364). MOExtended tires may only be used in conjunction with an active tire pressure loss warning system or with an active tire pressure monitor.

#### If a pressure loss warning message appears in the multifunction display:

- observe the instructions in the display messages (▷ page 262)
- check the tire for damage
- if driving on, observe the following notes

The driving distance possible in run-flat mode is approximately 50 miles (80 km) when the vehicle is partially laden. When the vehicle is fully laden it is approximately 19 miles (30 km).

In addition to the vehicle load, the driving distance possible depends upon:

- vehicle speed
- road condition
- outside temperature

The driving distance possible in run-flat mode may be reduced by extreme driving conditions or maneuvers, or it can be increased through a moderate style of driving.

The driving distance possible in run-flat mode is counted from the moment the tire pressure loss warning appears in the multifunction display. You must not exceed a maximum permissible speed of 50 mph (80 km/h).

When replacing one or all tires, please observe the following specifications for your vehicle's tires:

- size
- the type and
- the "MOExtended" marking

If a tire has gone flat and cannot be replaced with a MOExtended tire, a standard tire may be used as a temporary measure. Make sure that you use the proper size and type (summer or winter tires).

Vehicles equipped with MOExtended tires are not equipped with a TIREFIT kit at the factory. It is therefore recommended that you additionally equip your vehicle with a TIREFIT kit if you mount tires that do not feature run-flat properties, e.g. winter tires. A TIREFIT kit may be obtained from a qualified specialist workshop.

### Important safety notes

#### WARNING

When driving in emergency mode, the driving characteristics deteriorate, e.g. when cornering, accelerating quickly and when braking. There is a risk of an accident.

Do not exceed the stated maximum speed. Avoid abrupt steering and driving maneuvers, and driving over obstacles (curbs, potholes, off-road). This applies in particular to a laden vehicle.

Stop driving in emergency mode if:

- you hear banging noises.
- the vehicle starts to shake.
- you see smoke and smell rubber.
- ESP® is intervening constantly.
- there are tears in the sidewalls of the tire.

After driving in emergency mode, have the wheel rims checked at a qualified specialist workshop with regard to their further use. The defective tire must be replaced in every case.

### TIREFIT kit

#### Important safety notes

TIREFIT is a tire sealant.

You can use TIREFIT to seal punctures of up to 0.16 in (4 mm), particularly those in the tire tread. You can use TIREFIT at outside temperatures down to -4 °F (-20 °C).

#### WARNING

In the following situations, the tire sealant is unable to provide sufficient breakdown assistance, as it is unable to seal the tire properly:

- there are cuts or punctures in the tire larger than those mentioned above.
- the wheel rim is damaged.
- you have driven at very low tire pressures or on a flat tire.

There is a risk of an accident.

Do not drive the vehicle. Contact a qualified specialist workshop.

#### WARNING

The tire sealant is harmful and causes irritation. It must not come into contact with your skin, eyes or clothing or be swallowed. Do not inhale TIREFIT fumes. Keep tire sealant away from children. There is a risk of injury.

If you come into contact with the tire sealant, observe the following:

- Rinse off the tire sealant from your skin immediately with water.
- If the tire sealant comes into contact with your eyes, immediately rinse them thoroughly with clean water.
- If tire sealant is swallowed, immediately rinse your mouth out thoroughly and drink plenty of water. Do not induce vomiting, and seek medical attention immediately.
- Immediately change out of clothing which has come into contact with tire sealant.
- If an allergic reaction occurs, seek medical attention immediately.

 After use, excess tire sealant may run out of the filler hose. This could cause stains.



Therefore, place the tire sealant bottle with filler hose in the plastic bag which is contained in the TIREFIT kit.

#### Environmental note

Have the used tire sealant bottle disposed of professionally, e.g. at a qualified specialist workshop.

**!** Do not operate the tire inflation compressor for longer than ten minutes at a time without a break. It may otherwise overheat.

The tire inflation compressor can be operated again once it has cooled down.

Comply with the manufacturer's safety instructions on the sticker on the tire inflation compressor.

### Using the TIREFIT kit

- ▶ Do not remove any foreign objects which have penetrated the tire, e.g. screws or nails.
- ▶ Remove the tire sealant bottle, the accompanying TIREFIT sticker and the tire inflation compressor from the stowage well underneath the cargo compartment floor (> page 333).



- ▶ Affix part ① of the TIREFIT sticker to the instrument cluster within the driver's field of vision.
- ▶ Affix part ② of the TIREFIT sticker near the valve on the wheel with the defective tire.



- ▶ Pull connector ④ with cable and hose ⑤ out of the tire inflation compressor housing.
- ▶ Push connector on hose ⑤ into flange ⑥ on tire sealant bottle ① until the connector engages.
- ▶ Place tire sealant bottle ① head down into recess ② of the tire inflation compressor.



- ▶ Remove the cap from valve ⑦ on the faulty tire.
- ▶ Screw filler hose ⑧ onto valve ⑦.
- ▶ Insert plug ④ into cigarette lighter socket (> page 304) or into another 12 V socket in your vehicle (> page 305).
- ▶ Turn the SmartKey to position ① in the ignition lock (> page 136).
- ▶ Press on and off switch ③ on the tire inflation compressor.  
The tire inflation compressor is switched on. The tire is inflated.  
First, tire sealant is pumped into the tire. The pressure may briefly rise to approximately 500 kPa (5 bar/73 psi).  
**Do not switch off the tire inflation compressor during this phase.**
- ▶ Let the tire inflation compressor run for a maximum of ten minutes. The tire should then

have attained a pressure of at least 200 kPa (2.0 bar/29 psi).

If a pressure of 200 kPa (2.0 bar/29 psi) has been attained after five minutes, see "Tire pressure reached" (▷ page 337).

If a tire pressure of 200 kPa (2.0 bar/29 psi) has not been attained after five minutes, see "Tire pressure not reached" (▷ page 337).

If tire sealant has escaped, clean it off affected areas as quickly as possible. Use plain water if possible.

If your clothes are soiled with tire sealant, have them cleaned with perchloroethylene at a dry cleaner as soon as possible.

### Tire pressure not reached

If a tire pressure of 200 kPa (2.0 bar/29 psi) has not been attained after ten minutes:

- ▶ Switch off the tire inflation compressor.
- ▶ Unscrew the filler hose from the valve of the faulty tire.  
Tire sealant may escape when the filler hose is unscrewed.
- ▶ Very slowly drive forwards or reverse approximately 30 ft (10 m).
- ▶ Pump up the tire again.

After a maximum of ten minutes, the tire pressure must be at least 200 kPa (2.0 bar/29 psi).

#### WARNING

If the required tire pressure is not reached after the specified time, the tire is too badly damaged. The tire sealant cannot repair the tire in this instance. Damaged tires and a tire pressure that is too low can significantly impair the vehicle's braking and driving characteristics. There is a risk of accident.

Do not continue driving. Contact a qualified specialist workshop.

### Tire pressure reached

#### WARNING

A tire temporarily sealed with tire sealant impairs the driving characteristics and is not suitable for higher speeds. There is a risk of accident.

You should therefore adapt your driving style accordingly and drive carefully. Do not exceed the specified maximum speed with a tire that has been repaired using tire sealant.

The maximum permissible speed for a tire sealed with tire sealant is 50 mph (80 km/h). The upper part of the TIREFIT sticker must be affixed to the instrument cluster in the driver's field of vision.

If a tire pressure of 200 kPa (2.0 bar/29 psi) has been attained after ten minutes:

- ▶ Switch off the tire inflation compressor.
- ▶ Unscrew the filler hose from the valve of the faulty tire.  
Tire sealant may escape when the filler hose is unscrewed.
- ▶ Stow the tire sealant bottle and the tire inflation compressor.
- ▶ **Pull away immediately.**
- ▶ Stop after driving for approximately ten minutes and check the tire pressure with the tire inflation compressor.  
The tire pressure must now be at least 130 kPa (1.3 bar/19 psi).

#### WARNING

If the required tire pressure is not reached after driving for a short period, the tire is too badly damaged. The tire sealant cannot repair the tire in this instance. Damaged tires and a tire pressure that is too low can significantly impair the vehicle's braking and driving characteristics. There is a risk of accident.

Do not continue driving. Contact a qualified specialist workshop.

In cases such as the one mentioned above, contact an authorized Mercedes-Benz Center. Or call 1-800-FOR-MERCEDES (in the USA) or 1-800-387-0100 (in Canada).

- ▶ Correct the tire pressure if it is still at least 130 kPa (1.3 bar/19 psi). See the Tire and Loading Information placard on the B-pillar on the driver's side or the tire pressure table in the fuel filler flap for values.
- ▶ **To increase the tire pressure:** switch on the tire inflation compressor.



- ▶ **To reduce the tire pressure:** depress pressure release button ① next to pressure gauge ②.
- ▶ When the tire pressure is correct, unscrew the filler hose from the valve of the sealed tire. Tire sealant may escape when the filler hose is unscrewed.
- ▶ Screw the valve cap onto the tire valve of the sealed tire.
- ▶ Pull the tire sealant bottle out of the tire inflation compressor.  
The filler hose remains attached to the tire sealant bottle.
- ▶ Drive to the nearest qualified specialist workshop and have the tire changed there.
- ▶ Have the tire sealant bottle replaced as soon as possible at a qualified specialist workshop.
- ▶ Have the tire sealant bottle replaced every four years at a qualified specialist workshop.

## Battery (vehicle)

### 12 V battery – important safety notes

**Hybrid vehicles:** make sure that you read the separate Operator's Manual. You could otherwise fail to recognize dangers, e.g. due to high voltage.

Special tools and expert knowledge are required when working on the battery, e.g. removal and installation. You should therefore have all work involving the battery carried out at a qualified specialist workshop.

#### **WARNING**

Work carried out incorrectly on the battery can lead, for example, to a short circuit and thus damage the vehicle electronics. This can lead to function restrictions applying to

safety-relevant systems, e.g. the lighting system, the ABS (anti-lock braking system) or the ESP® (Electronic Stability Program). The operating safety of your vehicle may be restricted. You could lose control of the vehicle, for example:

- when braking
- in the event of abrupt steering maneuvers and/or when the vehicle's speed is not adapted to the road conditions

There is a risk of an accident.

In the event of a short circuit or a similar incident, contact a qualified specialist workshop immediately. Do not drive any further. You should have all work involving the battery carried out at a qualified specialist workshop.

For further information about ABS and ESP®, see (▶ page 66) and (▶ page 69).

**All vehicles except vehicles with a lithium-ion battery:**

#### **WARNING**

Electrostatic build-up can lead to the creation of sparks, which could ignite the highly explosive gases of a battery. There is a risk of an explosion.

Before handling the battery, touch the vehicle body to remove any existing electrostatic build-up.

The highly flammable gas mixture forms when charging the battery as well as when jump-starting.

Always make sure that neither you nor the battery is electrostatically charged. A build-up of electrostatic charge can be caused, for example:

- by wearing clothing made from synthetic fibers
- due to friction between clothing and seats
- if you push or pull the battery across the carpet or other synthetic materials
- if you rub the battery with a cloth

#### **WARNING**

During the charging process, a battery produces hydrogen gas. If a short circuit occurs or

sparks are created, the hydrogen gas can ignite. There is a risk of an explosion.

- Make sure that the positive terminal of a connected battery does not come into contact with vehicle parts.
- Never place metal objects or tools on a battery.
- It is important that you observe the described order of the battery terminals when connecting and disconnecting a battery.
- When jump-starting, make sure that the battery poles with identical polarity are connected.
- It is particularly important to observe the described order when connecting and disconnecting the jumper cables.
- Never connect or disconnect the battery terminals while the engine is running.

 **WARNING**

Battery acid is caustic. There is a risk of injury. Avoid contact with skin, eyes or clothing. Do not inhale any battery gases. Do not lean over the battery. Keep children away from batteries. Wash away battery acid immediately with plenty of clean water and seek medical attention.

**All vehicles:**

 **Environmental note**



Batteries contain dangerous substances. It is against the law to dispose of them with the household rubbish. They must be collected separately and recycled to protect the environment.



Dispose of batteries in an environmentally friendly manner. Take discharged batteries to a qualified specialist workshop or a special collection point for used batteries.

 Have the battery regularly checked at a qualified specialist workshop.

Comply with the service intervals in the Maintenance Booklet, or contact a qualified specialist workshop for more information.

 Always have work on batteries carried out at a qualified specialist workshop.

Should it, in exceptional circumstances, be absolutely necessary to disconnect the 12-volt battery yourself, please observe the following:

- Secure the vehicle to prevent it from rolling away.
- Switch off the ignition.
- Disconnect the negative terminal first and then the positive terminal.

The transmission is locked in position **P** after disconnecting the battery.

After the work has been done, install the battery and replace the cover of the positive terminal clamp firmly.

Comply with safety precautions and take protective measures when handling batteries.



Risk of explosion.



Fire, open flames and smoking are prohibited when handling the battery. Avoid creating sparks.



Electrolyte or battery acid is corrosive. Avoid contact with skin, eyes or clothing. Wear suitable protective clothing, especially gloves, apron and faceguard. Immediately rinse electrolyte or acid splashes off with clean water. Contact a physician if necessary.



Wear eye protection.



Keep children away.



Observe this Operator's Manual.

For safety reasons, Mercedes-Benz recommends that you only use batteries which have been tested and approved for your vehicle by Mercedes-Benz. These batteries provide increased impact protection to prevent vehicle occupants from suffering acid burns should the battery be damaged in the event of an accident.

In order for the battery to achieve the maximum possible service life, it must always be sufficiently charged.

Like other batteries, the vehicle battery may discharge over time if you do not use the vehicle. In this case, have the battery disconnected at a qualified specialist workshop. You can also charge the battery with a charger recommended by Mercedes-Benz. Contact a qualified specialist workshop for further information.

Have the battery charge state checked more frequently if you use the vehicle mainly for short trips or if you leave it standing idle for a lengthy period. Consult a qualified specialist workshop if you wish to leave your vehicle parked for a long period of time.

Remove the SmartKey if you park the vehicle and do not require any electrical consumers. The vehicle will then use very little energy, thus conserving battery power.

### Charging the 12 V battery

#### Vehicles with a lithium-ion battery:

❗ Only use battery chargers with a maximum charging voltage of 14.4 V.

#### All vehicles except vehicles with a lithium-ion battery:

❗ Only use battery chargers with a maximum charging voltage of 14.8 V.

#### ⚠ WARNING

During charging and jump-starting, explosive gases can escape from the battery. There is a risk of an explosion.

Particularly avoid fire, open flames, creating sparks and smoking. Ensure there is sufficient ventilation while charging and jump-starting. Do not lean over a battery.

#### ⚠ WARNING

Battery acid is caustic. There is a risk of injury.

Avoid contact with skin, eyes or clothing. Do not inhale any battery gases. Do not lean over the battery. Keep children away from batteries. Wash away battery acid immediately with plenty of clean water and seek medical attention.

#### ⚠ WARNING

A discharged battery can freeze at temperatures below freezing point. When jump-starting the vehicle or charging the battery, gases can escape from the battery. There is a risk of an explosion.

Allow the frozen battery to thaw out before charging it or jump-starting.

#### All vehicles:

❗ Only charge the battery using the jump-starting connection point.

The jump-starting connection point is in the engine compartment (▷ page 341).

► Open the hood.

► Connect the battery charger to the positive terminal and ground point in the same order as when connecting the donor battery in the jump-starting procedure (▷ page 341).

Keep away from fire and open flames. Do not lean over a battery. Never charge the battery if it is still installed in the vehicle, unless you use a battery charger which has been tested and approved by Mercedes-Benz. A battery charger unit specially adapted for Mercedes-Benz vehicles and tested and approved by Mercedes-Benz is available as an accessory. It permits the charging of the battery in its installed position. Contact an authorized Mercedes-Benz Center for further information and availability. Read the battery charger's operating instructions before charging the battery.

**All vehicles except vehicles with a lithium-ion battery:** if the warning and indicator lamps on the instrument cluster do not light up at low temperatures, it is very likely that the discharged battery has frozen. In this case you may neither jump-start the vehicle nor charge the battery. The service life of a thawed-out battery may be shorter. The starting characteristics can be impaired, particularly at low temperatures. Have the thawed-out battery checked at a qualified specialist workshop.

**Vehicles with a lithium-ion battery:** at low temperatures, do not charge a battery which has been removed using a battery charger. Allow the battery to warm up gently first, if necessary.

Otherwise, the service life can be shortened and the starting characteristics impaired, especially at low temperatures.

## Jump-starting

**Hybrid vehicles:** make sure that you read the separate Operator's Manual. You could otherwise fail to recognize dangers, e.g. due to high voltage.

For the jump-starting procedure, use only the jump-starting connection point in the engine compartment, consisting of a positive terminal and a ground point.

**All vehicles except vehicles with a lithium-ion battery:**

### WARNING

Battery acid is caustic. There is a risk of injury.

Avoid contact with skin, eyes or clothing. Do not inhale any battery gases. Do not lean over the battery. Keep children away from batteries. Wash away battery acid immediately with plenty of clean water and seek medical attention.

### WARNING

During charging and jump-starting, explosive gases can escape from the battery. There is a risk of an explosion.

Particularly avoid fire, open flames, creating sparks and smoking. Ensure there is sufficient ventilation while charging and jump-starting. Do not lean over a battery.

### WARNING

During the charging process, a battery produces hydrogen gas. If a short circuit occurs or sparks are created, the hydrogen gas can ignite. There is a risk of an explosion.

- Make sure that the positive terminal of a connected battery does not come into contact with vehicle parts.
- Never place metal objects or tools on a battery.
- It is important that you observe the described order of the battery terminals when connecting and disconnecting a battery.
- When jump-starting, make sure that the battery poles with identical polarity are connected.
- It is particularly important to observe the described order when connecting and disconnecting the jumper cables.
- Never connect or disconnect the battery terminals while the engine is running.

### WARNING

A discharged battery can freeze at temperatures below freezing point. When jump-starting the vehicle or charging the battery, gases can escape from the battery. There is a risk of an explosion. Allow the frozen battery to thaw out before charging it or jump-starting.

If the warning and indicator lamps do not light up on the instrument cluster when temperatures are low, it is probably because the discharged battery has frozen. In this case, you may neither charge the battery nor jump-start the vehicle. The service life of a thawed-out battery may be shorter. The

starting characteristics can be impaired, particularly at low temperatures. Have the thawed battery checked at a qualified specialist workshop.

#### All vehicles:

**!** Avoid repeated and lengthy starting attempts. Otherwise, the catalytic converter could be damaged by the non-combusted fuel.

Do not start the vehicle using a rapid charging device. If your vehicle's battery is discharged, the engine can be jump-started from another vehicle or from a donor battery using jumper cables. Observe the following points:

- The battery is not accessible in all vehicles. If the other vehicle's battery is not accessible, jump-start the vehicle using a donor battery or a jump-starting device.
- you may only jump-start the vehicle when the engine and exhaust system are cold.
- **All vehicles except vehicles with a lithium-ion battery:** do not start the engine if the battery is frozen. Let the battery thaw first.
- Jump-starting may be performed only using batteries with a nominal voltage of 12 V.
- Only use jumper cables which have a sufficient cross-section and insulated terminal clamps.
- If the battery is fully discharged, leave the battery that is being used to jump-start connected for a few minutes before attempting to start. This charges the battery slightly.
- Make sure that the two vehicles do not touch.

Make sure that:

- The jumper cables are not damaged.
- Bare parts of the terminal clamp do not come into contact with other metal parts while the jumper cables are connected to the battery.
- The jumper cables cannot come into contact with parts that can move when the engine is running, such as the V-belt pulley or the fan.
- ▶ Secure the vehicle by applying the electric parking brake.
- ▶ Shift the transmission to position **P**.
- ▶ Make sure that the ignition is switched off. All indicator lamps in the instrument cluster must be off. When using the SmartKey, turn the SmartKey to position **0** in the ignition lock and remove it (▷ page 136).
- ▶ Switch off all electrical consumers, e.g. rear window defroster, lighting, etc.
- ▶ Open the hood.

**i** **Right-hand-drive vehicle:** the jump-starting connection points may be located on the other side of the vehicle.



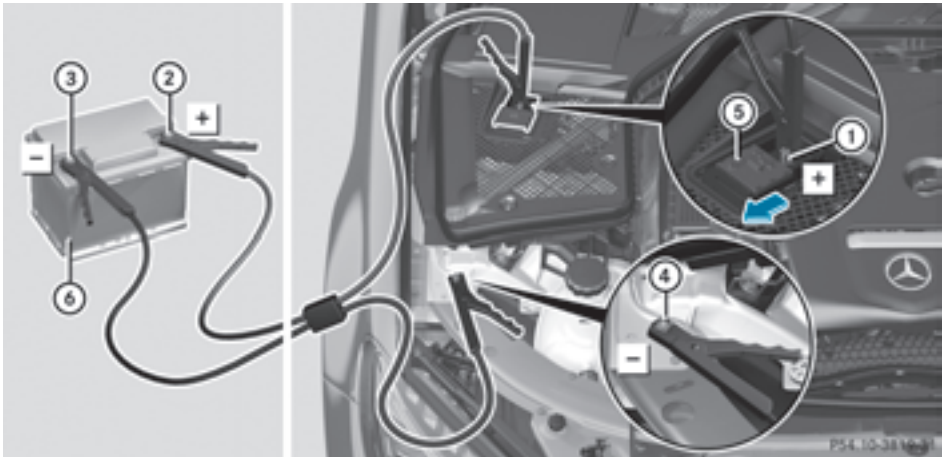

Position number ⑥ identifies the charged battery of the other vehicle or an equivalent jump-starting device.

- ▶ Slide cover ⑤ of positive terminal ① in the direction of the arrow.
- ▶ Connect positive terminal ① on your vehicle to positive terminal ② of donor battery ⑥ using the jumper cable. Always begin with positive terminal ① on your own vehicle first.
- ▶ Start the engine of the donor vehicle and run it at idling speed.
- ▶ Connect negative terminal ③ of donor battery ⑥ to ground point ④ of your vehicle using the jumper cable. beginning with donor battery ⑥ first.
- ▶ Start the engine.
- ▶ Before disconnecting the jumper cables, let the engine run for several minutes.
- ▶ First, remove the jumper cables from ground point ④ and negative terminal ③, then from positive clamp ① and positive terminal ②. Begin each time at the contacts on your own vehicle first.
- ▶ Close cover ⑤ of positive terminal ① after removing jumper cables.
- ▶ Have the battery checked at a qualified specialist workshop.

Jump-starting is not considered to be a normal operating condition.

- ❗ Jumper cables and further information regarding jump-starting can be obtained at any qualified specialist workshop.

## Towing and tow-starting

### Important safety notes

**Hybrid vehicles:** make sure that you read the separate Operator's Manual. You could otherwise fail to recognize dangers, e.g. due to high voltage.

### ⚠ WARNING

Functions relevant to safety are restricted or no longer available if:

- the engine is not running.
- the brake system or the power steering is malfunctioning.
- there is a malfunction in the voltage supply or the vehicle's electrical system.

If your vehicle is being towed, much more force may be necessary to steer or brake. There is a risk of an accident.

In such cases, use a tow bar. Before towing, make sure that the steering moves freely.

### WARNING

You can no longer steer the vehicle if the steering wheel lock has been engaged. There is a risk of an accident.

Always switch off the ignition when towing the vehicle with a tow cable or a tow bar.

### WARNING

When towing or tow-starting another vehicle and its weight is greater than the permissible gross weight of your vehicle, the:

- the towing eye could detach itself
- the vehicle/trailer combination could roll-over.

There is a risk of an accident.

When towing or tow-starting another vehicle, its weight should not be greater than the permissible gross weight of your vehicle.

Details on the permissible gross vehicle weight of your vehicle can be found on the vehicle identification plate (> page 376).

- ❗ When Active Brake Assist, Distance Pilot DISTRONIC or the HOLD function is activated, the vehicle brakes automatically in certain situations.

To avoid damage to the vehicle, deactivate these systems in the following or similar situations:

- when towing the vehicle
- in the car wash

- ❗ Make sure that the electric parking brake is released. If the electric parking brake is faulty, visit a qualified specialist workshop.

- ❗ Only secure the tow rope or tow bar at the towing eyes, or the trailer tow hitch, if available. You could otherwise damage the vehicle.

- ❗ Do not use the trailer tow hitch for recovery or towing. Do not use the towing eye for recovery. This could damage the vehicle. If in doubt, have the vehicle recovered using a crane.

- ❗ When towing, pull away slowly and smoothly. If the tractive power is too high, the vehicles could be damaged.

- ❗ Shift the automatic transmission to position **N** and do not open the driver's or front passenger's door during towing. The automatic transmission may otherwise shift to position **P**, which could damage the transmission.

- ❗ Do not tow with sling-type equipment. This could damage the vehicle.

- ❗ The vehicle can be towed a maximum of 30 miles (50km). The towing speed of 30 mph (50 km/h) must not be exceeded.

If the vehicle has to be towed more than 30 miles (50km), the entire vehicle must be raised and transported.

It is better to have the vehicle transported than to have it towed away.

If the vehicle has suffered transmission damage, have it transported on a transporter or trailer.

The automatic transmission must be in position **N** when the vehicle is being towed. If the automatic transmission cannot be shifted to position **N**, have the vehicle transported on a transporter or trailer.

The battery must be connected and charged. Otherwise, you:

- cannot turn the SmartKey to position **2** in the ignition lock
- cannot release the electric parking brake
- cannot shift the automatic transmission to position **N**

Disarm the automatic locking feature before the vehicle is towed (> page 85). You could otherwise be locked out when pushing or towing the vehicle.

## Installing/removing the towing eye

### Installing the towing eye

#### WARNING

The exhaust tail pipe may be very hot. There is a risk of burns when removing the rear cover.

Do not touch the exhaust pipe. Take particular care when removing the rear cover.



Mercedes-AMG vehicles



All other vehicles

The brackets for the screw-in towing eye are located in the bumpers. They are at the rear and at the front, under covers ①.

- ▶ Remove the towing eye from the retainer (▷ page 333).
- ▶ **Mercedes-AMG vehicles:** use a suitable object, e.g. a screwdriver, to pry off cover ① on the front bumper from underneath. Take the cover from the opening, but do not remove it.

Press the mark on cover ① on the rear bumper inward and remove.

- ▶ **All other vehicles:** press the mark on cover ① inward and remove.
- ▶ Screw in the towing eye clockwise as far as it will go and tighten it.

Vehicles with a trailer tow hitch do not have a bracket for the screw-in towing eye at the back. Connect the towbar to the trailer tow hitch (▷ page 216).

### Removing the towing eye

- ▶ Unscrew and remove the towing eye.
- ▶ Attach cover ① to the bumper and press until it engages.

### Towing a vehicle with both axles on the ground

The automatic transmission automatically shifts to position **P** when you open the driver's or front-passenger door or when you remove the SmartKey from the ignition lock. It is essential to observe the following steps to ensure that the automatic transmission remains in position **N** during towing.

- ▶ Make sure that the vehicle is stationary.
- ▶ Turn the SmartKey to position **2** in the ignition lock.
- ▶ Depress and hold the brake pedal.
- ▶ Shift the automatic transmission to position **N**.
- ▶ Leave the SmartKey in position **2** in the ignition lock.
- ▶ Release the brake pedal.
- ▶ Release the electric parking brake.
- ▶ Switch on the hazard warning lamps (▷ page 114).

In order to signal a change of direction when towing the vehicle with the hazard warning lamps switched on, use the combination switch as usual. In this case, only the indicator lamps for the direction of travel flash. After resetting the combination switch, the hazard warning lamp starts flashing again.

## Transporting the vehicle

### Vehicles with ADS PLUS (Adaptive Damping System PLUS)

#### WARNING

The weaker damping forces of the vehicle to be transported can cause the vehicle/trailer combination to swing.

As a result, when transporting vehicles with Adaptive Damping System PLUS, the vehicle/trailer combination may start to skid. Consequently, you could lose control of the vehicle.

There is a risk of accident and injury.

When transporting, make sure that:

- the vehicle is has been loaded onto the transporter correctly
- the vehicle is secured at all four wheels with suitable tensioning straps
- you do not exceed the maximum permissible speed of 35 mph (60 km/h)

**!** After loading, the vehicle must be secured at all four wheels. Otherwise, the vehicle could be damaged.

A minimum distance of 8 in (20 cm) up and 4 in (10 cm) down must be maintained to the transport platform.

- ▶ Secure all four wheels after loading the vehicle.

### General notes

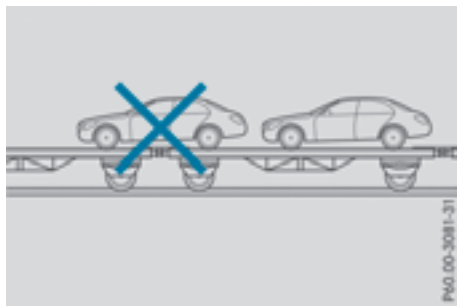

**!** When the vehicle is loaded for transport, the front and rear axles must be stationary and on the same transportation vehicle. Positioning over the connection point of the transport

vehicle is not permitted. The drive train may otherwise be damaged.

**!** You may only secure the vehicle by the wheels, not by parts of the vehicle such as axle or steering components. Otherwise, the vehicle could be damaged.

The towing eye or trailer tow hitch can be used to pull the vehicle onto a trailer or transporter if you wish to transport it.

- ▶ Turn the SmartKey to position **2** in the ignition lock.
- ▶ Shift the automatic transmission to position **N**.

#### As soon as the vehicle has been loaded:

- ▶ Prevent the vehicle from rolling away by applying the electric parking brake.
- ▶ Shift the automatic transmission to position **P**.
- ▶ Turn the SmartKey to position **0** in the ignition lock and remove it.
- ▶ Secure the vehicle.

### Notes on 4MATIC vehicles

**!** Vehicles with 4MATIC must not be towed with either the front or the rear axle raised, as doing so will damage the transmission.

Vehicles with 4MATIC may either be towed away with both axles on the ground or be loaded up and transported.

If the vehicle's transmission, front, or rear axle is damaged, have the vehicle transported on a truck or trailer.

**In the event of damage to the electrical system:** if the battery is defective, the automatic transmission will be locked in position **P**. To shift the automatic transmission to position **N**, you must provide power to the vehicle's electrical system in the same way as when jump-starting (> page 341).

Have the vehicle transported on a transporter or trailer.

## Tow-starting (emergency engine starting)

- ❗ Vehicles with automatic transmission must not be tow-started. You could otherwise damage the automatic transmission.
- i You can find information on "Jump-starting" under (▷ page 341).

## Fuses

### Important safety notes

#### ⚠ WARNING

If you manipulate or bridge a faulty fuse or if you replace it with a fuse with a higher amperage, the electric cables could be overloaded. This could result in a fire. There is a risk of an accident and injury.

Always replace faulty fuses with the specified new fuses having the correct amperage.

Blown fuses must be replaced with fuses of the same rating, which you can recognize by the color and value. The fuse ratings are listed in the fuse allocation chart.

The fuse allocation chart is on the fuse box in the cargo compartment (▷ page 348).

If a newly inserted fuse also blows, have the cause traced and rectified at a qualified specialist workshop, e.g. an authorized Mercedes-Benz Center.

- ❗ Only use fuses that have been approved for Mercedes-Benz vehicles and which have the correct fuse rating for the system concerned. Otherwise, components or systems could be damaged.
- ❗ Make sure that no moisture can enter the fuse box when the cover is open.
- ❗ When closing the cover, make sure that it is lying correctly on the fuse box. Moisture seeping in or dirt could otherwise impair the operation of the fuses.

The fuses in your vehicle serve to close down faulty circuits. If a fuse blows, all the components on the circuit and their functions stop operating.

## Before changing a fuse

Observe the important safety notes (▷ page 347)

- ▶ Switch off the engine.
- ▶ Switch off all electrical consumers.
- ▶ Make sure that the ignition is switched off (▷ page 137).

or

- ▶ When using the SmartKey, turn the SmartKey to position **0** in the ignition lock and remove it (▷ page 136).
- ▶ Secure the vehicle against rolling away (▷ page 158).

All indicator lamps in the instrument cluster must be off.

The fuses are located in various fuse boxes:

- Fuse box on the driver's side of the dashboard
- Fuse box in the front-passenger footwell
- Fuse box in the engine compartment on the driver's side
- Fuse box under the cargo compartment floor on the right-hand side of the vehicle, when viewed in the direction of travel

## Dashboard fuse box

The fuse box is under a cover on the side of the dashboard. You can obtain further information from an authorized Mercedes-Benz Center.

## Fuse box in the front-passenger footwell



- ▶ Open the front-passenger door.
- ▶ **To open:** fold cover ① out towards the rear and remove it.

- ▶ **To close:** clip in cover ① at the rear.
- ▶ Fold cover ① forwards until it engages.

### Fuse box in the engine compartment

#### WARNING

When the hood is open and the windshield wipers are set in motion, you can be injured by the wiper linkage. There is a risk of injury.

Always switch off the windshield wipers and the ignition before opening the hood.



- ▶ Open the hood (▷ page 318).
- ▶ **To open:** turn fasteners ② on cover ① counter-clockwise as far as they will go.
- ▶ Remove fuse box cover ① up.



- ▶ Use a dry cloth to remove any moisture from the fuse box.
- ▶ Loosen screws ③, fold up fuse box lid ④ and remove it.
- ▶ **To close:** check whether the seal is positioned correctly in lid ④.

- ▶ Insert lid ④ into the bracket at the rear of the fuse box.
- ▶ Fold down lid ④ of the fuse box and tighten screws ③.
- ▶ Insert cover ① and turn fasteners ② clockwise as far as they will go.
- ▶ Close the hood.

### Fuse box in the cargo compartment



#### Opening

- ▶ Open the tailgate.
- ▶ Lift the cargo compartment floor upwards (▷ page 300).
- ▶ Release the Velcro fastener and lift up cover ① in the cavity trim of the cargo compartment in the direction of the arrow.

#### Closing

- ▶ Fold back cover ① in the opposite direction to the arrow and close the Velcro fastener.

Make sure that cover ① is in the recess of the cavity trim provided for it.

- ▶ **i** The fuse allocation chart is located in a recess at the side of the fuse box. You can find the corresponding fuse rating and fuse type on the fuse allocation chart.



## Important safety notes

### WARNING

If wheels and tires of the wrong size are used, the wheel brakes or suspension components may be damaged. There is a risk of an accident.

Always replace wheels and tires with those that fulfill the specifications of the original part.

When replacing wheels, make sure to use the correct:

- designation
- model

When replacing tires, make sure to use the correct:

- designation
- manufacturer
- model

### WARNING

A flat tire severely impairs the driving, steering and braking characteristics of the vehicle. There is a risk of accident.

Tires without run-flat characteristics:

- do not drive with a flat tire.
- immediately replace the flat tire with your emergency spare wheel or spare wheel, or consult a qualified specialist workshop.

Tires with run-flat characteristics:

- pay attention to the information and warning notices on MOExtended tires (tires with run-flat characteristics).

Accessories that are not approved for your vehicle by Mercedes-Benz or are not being used correctly can impair the operating safety.

Before purchasing and using non-approved accessories, visit a qualified specialist workshop and inquire about:

- suitability
- legal stipulations
- factory recommendations

Further information regarding wheels and tires can be found under "Wheel/tire combinations" (> page 373).

You can ask for information regarding permitted wheel-tire combinations at an authorized Mercedes-Benz Center.

Information on tire pressure can be found:

- on the Tire and Loading Information placard on the B-pillar on the driver's side (> page 359)
- in the tire pressure table in the fuel filler flap (> page 352)
- under "Tire pressure" (> page 352)

## Operation

### Information on driving

Check the tire pressure when the vehicle is heavily laden and adjust prior to a trip.

While driving, pay attention to vibrations, noises and unusual handling characteristics, e.g. pulling to one side. This may indicate that the wheels or tires are damaged. If you suspect that a tire is defective, reduce your speed immediately. Stop the vehicle as soon as possible to check the wheels and tires for damage. Hidden tire damage could also be causing the unusual handling characteristics. If you find no signs of damage, have the tires and wheels checked at a qualified specialist workshop.

When parking your vehicle, make sure that the tires do not get deformed by the curb or other obstacles. If they cannot be avoided, drive over obstacles such as curbs slowly and at an obtuse angle. Otherwise, you may damage the wheels or tires.

### Regular checking of wheels and tires

#### WARNING

Damaged tires can cause tire inflation pressure loss. As a result, you could lose control of your vehicle. There is a risk of accident.

Check the tires regularly for signs of damage and replace any damaged tires immediately.

Check wheels and tires for damage at least once a month. Check wheels and tires after driving



off-road or on rough roads. Damaged wheels can cause a loss of tire pressure.

Pay particular attention to damage such as:

- Cuts in the tires
- Punctures in the tires
- Tears in the tires
- Bulges on tires
- Deformation or severe corrosion on wheels

Regularly check the tire tread depth and the condition of the tread across the whole width of the tire (> page 350). If necessary, turn the front wheels to full lock in order to inspect the inner side of the tire surface.

All wheels must have a valve cap to protect the valve against dirt and moisture. Do not mount anything onto the valve other than the standard valve cap or other valve caps approved by Mercedes-Benz for your vehicle. Do not use any other valve caps or systems, e.g. tire pressure monitoring systems.

Regularly check the pressure of all the tires particularly prior to long trips. Adjust the tire pressure as necessary (> page 352).

The service life of tires depends, among other things, on the following factors:

- Driving style
- Tire pressure
- Distance covered

### Notes on tire tread

#### WARNING

Insufficient tire tread will reduce tire traction. The tire is no longer able to dissipate water. This means that on wet road surfaces, the risk of hydroplaning increases, in particular where speed is not adapted to suit the driving conditions. There is a risk of accident.

If the tire pressure is too high or too low, tires may exhibit different levels of wear at different locations on the tire tread. Thus, you should regularly check the tread depth and the condition of the tread across the entire width of all tires.

Minimum tire tread depth for:

- Summer tires:  $\frac{1}{8}$  in (3 mm)
- M+S tires:  $\frac{1}{4}$  in (4 mm)

For safety reasons, replace the tires before the legally prescribed limit for the minimum tire tread depth is reached.

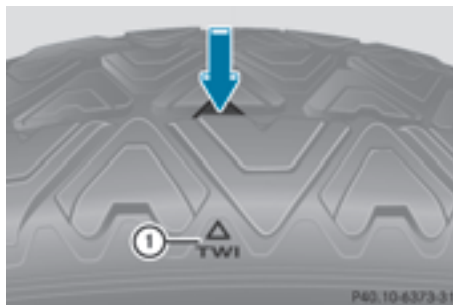

Marking ① shows where the bar indicator (arrow) for tread wear is integrated into the tire tread.

Treadwear indicators (TWI) are required by law. Six indicators are positioned on the tire tread. They are visible once a tread depth of approximately  $\frac{1}{16}$  in (1.6 mm) has been reached. If this is the case, the tire is so worn that it must be replaced.

### Selecting, mounting and replacing tires

- Only mount tires and wheels of the same type and make.  
Exception: it is permissible to install a different type or make in the event of a flat tire. Observe the "MOExtended tires (tires with run-flat characteristics)" section (> page 334).
- Only mount tires of the correct size onto the wheels.
- Break in new tires at moderate speeds for the first 60 miles (100 km). The new tires only reach their full performance after this distance.
- Do not drive with tires which have too little tread depth, as this significantly reduces the traction on wet roads (hydroplaning).
- Replace the tires after six years at the latest, regardless of wear.

## MOExtended tires (tires with run-flat properties)

With MOExtended tires (tires with run flat characteristics), you can continue to drive your vehicle even if there is a total loss of pressure in one or more tires.

MOExtended tires may only be used in conjunction with an active tire pressure loss warning system or with an active tire pressure monitor and on wheels specifically tested by Mercedes-Benz.

Notes on driving with MOExtended tires with a flat tire (▷ page 334).

Vehicles equipped with MOExtended tires are not equipped with a TIREFIT kit at the factory. It is therefore recommended that you additionally equip your vehicle with a TIREFIT kit if you mount tires that do not feature run-flat properties, e.g. winter tires. A TIREFIT kit can be obtained from a qualified specialist workshop.

## Winter operation

### General notes

Have your vehicle winter-proofed at a qualified specialist workshop at the onset of winter.

Observe the notes in the "Changing a wheel" section (▷ page 369).

### Driving with summer tires

At temperatures below 45 °F (+7 °C), summer tires lose elasticity and therefore traction and braking power. Change the tires on your vehicle to M+S tires. Using summer tires at very cold temperatures could cause cracks to form, thereby damaging the tires permanently. Mercedes-Benz cannot accept responsibility for this type of damage.

#### WARNING

Damaged tires can cause tire inflation pressure loss. As a result, you could lose control of your vehicle. There is a risk of accident.

Check the tires regularly for signs of damage and replace any damaged tires immediately.

## M+S tires

#### WARNING

M+S tires with a tire tread depth of less than 1/8 in (4 mm) are not suitable for use in winter and do not provide sufficient traction. There is a risk of an accident.

M+S tires with a tread depth of less than 1/8 in (4 mm) must be replaced immediately.

At temperatures below 45 °F (+7 °C), use winter tires or all-season tires. Both types of tire are identified by the M+S marking.

Only winter tires bearing the  snowflake symbol in addition to the M+S marking provide the best possible grip in wintry road conditions. Only these tires will allow driving safety systems such as ABS and ESP® to function optimally in winter. These tires have been developed specifically for driving in snow.

Use M+S tires of the same make and tread on all wheels to maintain safe handling characteristics.

Always observe the maximum permissible speed specified for the M+S tires you have mounted.

When you have mounted the M+S tires:

- ▶ Check the tire pressures (▷ page 355).
- ▶ **Vehicles for Canada:** restart the tire pressure loss warning system (▷ page 356).
- ▶ Restart the tire pressure monitor (▷ page 358).

## Snow chains

#### WARNING

If snow chains are installed to the front wheels, they may drag against the vehicle body or chassis components. This could cause damage to the vehicle or the tires. There is a risk of an accident.

To avoid hazardous situations:

- never install snow chains to the front wheels
- always install snow chains in pairs to the rear wheels.

For safety reasons, Mercedes-Benz recommends that you only use snow chains that have been specially approved for your vehicle by Mercedes-Benz, or are of a corresponding standard of quality. For more information, please contact a qualified specialist workshop. If you intend to mount snow chains, please bear the following points in mind:

- Snow chains may not be mounted on all wheel/tire combinations. Observe the information regarding permitted wheel/tire combinations (> page 373).
- Only use snow chains when driving on roads completely covered by snow. Remove the snow chains as soon as possible when you come to a road that is not snow-covered.
- Local regulations may restrict the use of snow chains. Observe the appropriate regulations if you wish to mount snow chains.
- Do not exceed the maximum permissible speed of 31 mph (50 km/h).
- On vehicles with AIR BODY CONTROL, you must only drive at raised vehicle level if snow chains have been installed (> page 185).
- You must never use Parking Pilot (> page 188) when snow chains are installed.

You may wish to deactivate ESP® when pulling away with snow chains installed:

- All vehicles (except Mercedes-AMG vehicles) (> page 70)
- Mercedes-AMG vehicles (> page 71)

You can thereby allow the wheels to spin in a controlled manner, achieving an increased driving force (cutting action).

## Tire pressure

### Tire pressure specifications

#### Important safety notes

##### WARNING

Underinflated or overinflated tires pose the following risks:

- the tires may burst, especially as the load and vehicle speed increase.
- the tires may wear excessively and/or unevenly, which may greatly impair tire traction.
- the driving characteristics, as well as steering and braking, may be greatly impaired.

There is a risk of an accident.

Follow recommended tire inflation pressures and check the pressure of all the tires including the spare wheel:

- monthly, at least
- if the load changes
- before beginning a long journey
- under different operating conditions, e.g. off-road driving

If necessary, correct the tire pressure.

The data on the Tire and Loading Information placard and tire pressure table shown here are examples. Tire pressure specifications are vehicle-specific and may deviate from the data shown here. The tire pressure specifications that are valid for your vehicle can be found on the Tire and Loading Information placard and tire pressure table on the vehicle.

#### General notes

The recommended tire pressures for the tires mounted at the factory can be found on the labels described here.

**Operation with a trailer:** the applicable value for the rear axle is the maximum tire pressure value stated in the table inside the fuel filler flap. Further information on tire pressures can be obtained at a qualified specialist workshop.

## Tire and Loading Information placard

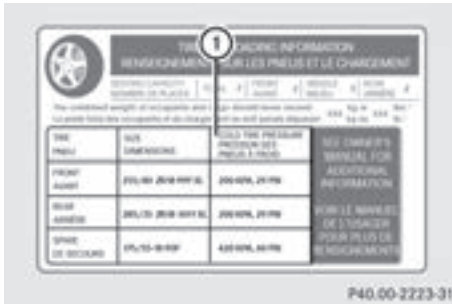

### ① Recommended tire pressures

The Tire and Loading Information placard is on the B-pillar on the driver's side (▷ page 359). The Tire and Loading Information placard contains the recommended tire pressures for cold tires. The recommended tire pressures are valid for the maximum permissible load and up to the maximum permissible vehicle speed.

## Tire pressure table

The tire pressure table is on the inside of the fuel filler flap. It shows the tire pressure for all tires permitted at the factory for this vehicle; see illustration (example).

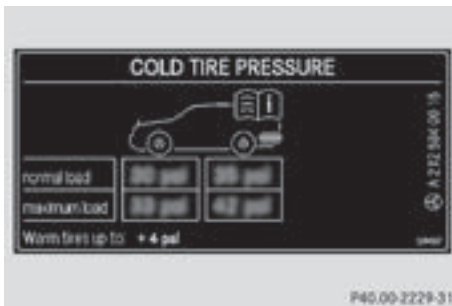

The tire pressure table contains the recommended pressures for cold tires for various operating conditions, i.e. differing load and speed conditions.

If a tire size precedes a tire pressure, the tire pressure information following is only valid for that tire size. If a speed range precedes the tire pressure, the following tire pressure data applies to only this speed range.

The load conditions "partially laden" and "fully laden" are defined in the table for different num-

bers of occupants and amounts of luggage. The actual number of seats may differ.

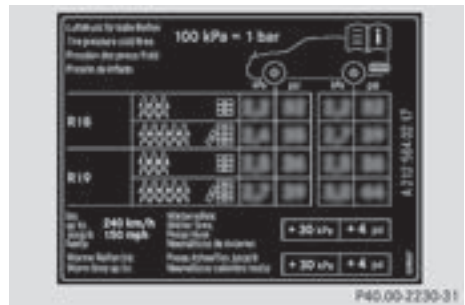

Some tire pressure tables show only the rim diameters instead of the full tire size, e.g. **R18**. Rim diameter is part of the tire size and can be found on the tire sidewall (▷ page 364).

If the tire pressures have been set to the lower values for lighter loads and/or lower road speeds, the pressures should be reset to the higher values:

- if you want to drive with an increased load and/or
- if you want to drive at higher road speeds

The tire pressures for increased loads and/or higher road speeds, shown in the tire pressure table, may have a negative effect on driving comfort.

If the tire pressure is not set correctly, this can lead to an excessive build up of heat and a sudden loss of pressure.

For more information, contact a qualified specialist workshop.

## Important notes on tire pressure

### ⚠ WARNING

If the tire pressure drops repeatedly, the wheel, valve or tire may be damaged. Tire pressure that is too low may result in a tire blow-out. There is a risk of an accident.

- Check the tire for foreign objects.
- Check whether the wheel is losing air or the valve is leaking.

If you are unable to rectify the damage, contact a qualified specialist workshop.

 **WARNING**

If you fit unsuitable accessories onto tire valves, the tire valves may be overloaded and malfunction, which can cause tire pressure loss. Due to their design, retrofitted tire pressure monitors keep the tire valve open. This can also result in tire pressure loss. There is a risk of an accident.

Only screw the standard valve cap or other valve caps approved by Mercedes-Benz for your vehicle onto the tire valve.

Use a suitable pressure gauge to check the tire pressure. The outer appearance of a tire does not permit any reliable conclusion about the tire pressure. On vehicles equipped with the electronic tire pressure monitor, the tire pressure can be checked in the on-board computer.

The tire temperature and pressure increase when the vehicle is in motion. This is dependent on the driving speed and the load.

Therefore, you should only correct tire pressures when the tires are cold.

The tires are cold:

- if the vehicle has been parked with the tires out of direct sunlight for at least three hours and
- if the vehicle has not been driven further than 1 mile (1.6 km)

The tire temperature changes depending on the outside temperature, the vehicle speed and the tire load. If the tire temperature changes by 18 °F (10 °C), the tire pressure changes by approximately 10 kPa (0.1 bar/1.5 psi). Take this into account when checking the pressure of warm tires. Only correct the tire pressure if it is too low for the current operating conditions. If you check the tire pressure when the tires are warm, the resulting value will be higher than if the tires were cold. This is normal. Do not reduce the tire pressure to the value specified for cold tires. The tire pressure would otherwise be too low.

Observe the recommended tire pressures for cold tires:

- on the Tire and Loading Information placard on the B-pillar on the driver's side
- in the tire pressure table on the fuel filler flap (> page 352)

**Underinflated or overinflated tires****Underinflated tires** **WARNING**

Tires with pressure that is too low can overheat and burst as a consequence. In addition, they also suffer from excessive and/or irregular wear, which can severely impair the braking properties and the driving characteristics. There is a risk of an accident.

Avoid tire pressures that are too low in all the tires, including the spare wheel.

Underinflated tires may:

- overheat, leading to tire defects
- adversely affect handling
- wear excessively and/or unevenly
- have an adverse effect on fuel consumption

**Overinflated tires** **WARNING**

Tires with excessively high pressure can burst because they are damaged more easily by road debris, potholes etc. In addition, they also suffer from irregular wear, which can severely impair the braking properties and the driving characteristics. There is a risk of an accident.

Avoid tire pressures that are too high in all the tires, including the spare wheel.

Overinflated tires may:

- increase the braking distance
- adversely affect handling
- wear excessively and/or unevenly
- have an adverse effect on ride comfort
- be more susceptible to damage

## Maximum tire pressures

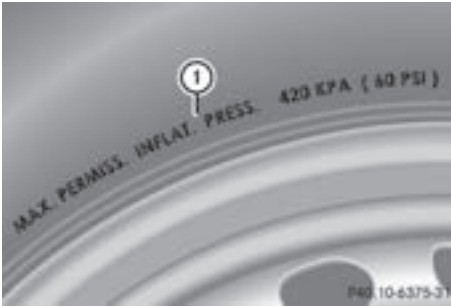

- ① Example: maximum permissible tire pressure

Never exceed the maximum permissible tire inflation pressure. Always observe the recommended tire pressure for your vehicle when adjusting the tire pressure (▷ page 352).

- ❗ The actual values for tires are vehicle-specific and may deviate from the values in the illustration.

## Checking the tire pressures

### Important safety notes

Observe the notes on tire pressure (▷ page 352).

Information on air pressure for the tires on your vehicle can be found:

- on the vehicle's Tire and Loading Information placard on the B-pillar
- in the tire pressure table in the fuel filler flap (▷ page 352)
- in the "Tire pressure" section

### Checking tire pressures manually

To determine and set the correct tire pressure, proceed as follows:

- ▶ Remove the valve cap of the tire that is to be checked.
- ▶ Press the tire pressure gauge securely onto the valve.
- ▶ Read the tire pressure and compare it to the recommended value on the Tire and Loading Information placard or the tire pressure table (▷ page 352).

- ▶ If the tire pressure is too low, increase the tire pressure to the recommended value.
- ▶ If the tire pressure is too high, release air. To do so, press down the metal pin in the valve, using the tip of a pen for example. Then check the tire pressure again using the tire pressure checker.
- ▶ Screw the valve cap onto the valve.
- ▶ Repeat these steps for the other tires.

## Tire pressure loss warning system

### General notes

While the vehicle is in motion, the tire pressure loss warning system monitors the set tire pressure using the rotational speed of the wheels. This enables the system to detect significant pressure loss in a tire. If the speed of rotation of a wheel changes as a result of a loss of pressure, a corresponding warning message will appear in the multifunction display.

You can recognize the tire pressure loss warning by the **Run Flat Indicator Active Press 'OK' to Restart** message which appears in the **Service** menu of the multifunction display. Information on the message display can be found in the "Restarting the tire pressure loss warning system" section (▷ page 356).

### Important safety notes

The tire pressure warning system does not warn you of an incorrectly set tire pressure. Observe the notes on the recommended tire pressure (▷ page 352).

The tire pressure loss warning does not replace the need to regularly check the tire pressure. An even loss of pressure on several tires at the same time cannot be detected by the tire pressure loss warning system.

The tire pressure monitor is not able to warn you of a sudden loss of pressure, e.g. if the tire is penetrated by a foreign object. In the event of a sudden loss of pressure, bring the vehicle to a halt by braking carefully. Avoid abrupt steering movements.







The function of the tire pressure loss warning system is limited or delayed if:

- snow chains are mounted on your vehicle's tires.
- road conditions are wintry.





- you are driving on sand or gravel.
- you adopt a very sporty driving style (cornering at high speeds or driving with high rates of acceleration).
- you are towing a very heavy or large trailer.
- you are driving with a heavy load (in the vehicle or on the roof).

### Restarting the tire pressure loss warning system





Restart the tire pressure loss warning system if you have:

- changed the tire pressure
  - changed the wheels or tires
  - mounted new wheels or tires
- ▶ Before restarting, make sure that the tire pressures are set properly on all four tires for the respective operating conditions.
- The recommended tire pressure can be found on the Tire and Loading Information placard on the B-pillar. Additionally, a tire pressure table is attached to the fuel filler flap. The tire pressure loss warning system can only give reliable warnings if you have set the correct tire pressure. If an incorrect tire pressure is set, these incorrect values will be monitored.
- ▶ Also observe the notes in the section on tire pressures (▷ page 352).
- ▶ Make sure that the SmartKey is in position **2** in the ignition lock (▷ page 136).
- ▶ Press  on the steering wheel to call up the menu list.
- ▶ Press  or  on the steering wheel to select the **Service** menu.
- ▶ Confirm by pressing  on the steering wheel.
- ▶ Press  or  to select **Tire Pressure**.
- ▶ Press  to confirm.
- The **Run Flat Indicator Active Press 'OK' to Restart** message is shown in the multifunction display.

### If you wish to confirm the restart:

- ▶ Press the  button.  
The **Tire Pressure Now OK?** message is shown on the multifunction display.
  - ▶ Press  or  to select **Yes**.
  - ▶ Press  to confirm.  
The **Run Flat Indicator Restarted** message is shown on the multifunction display.
- After a teach-in period, the tire pressure loss warning system will monitor the set tire pressures of all four tires.

### If you wish to cancel the restart:

- ▶ Press the  button.
- or
- ▶ If the **Tire Pressure Now OK?** message appears, press  or  to select **Cancel**.
  - ▶ Press  to confirm.  
The tire pressure values stored at the last restart will continue to be monitored.

## Tire pressure monitor

### General notes

If a tire pressure monitor is installed, the vehicle's wheels have sensors that monitor the tire pressures in all four tires. The tire pressure monitor warns you if the pressure drops in one or more of the tires. The tire pressure monitor only functions if the corresponding sensors are installed in all wheels.

Information on tire pressures is displayed in the multifunction display. After a few minutes of driving, the current tire pressure of each tire is shown in the **Service** menu of the multifunction display; see illustration (example).





Information on the message display can be found in the "Checking the tire pressure electronically" section (▷ page 358).

## Important safety notes

### WARNING

Each tire, including the spare (if provided), should be checked at least once every two weeks when cold and inflated to the pressure recommended by the vehicle manufacturer on the Tire and Loading Information placard on the driver's door B-pillar or the tire pressure label on the inside of the fuel filler flap. If your vehicle has tires of a different size than the size indicated on the Tire and Loading Information placard or, if available, the tire pressure label, you should determine the proper tire pressure for those tires.

As an added safety feature, your vehicle has been equipped with a tire pressure monitoring system (TPMS) that illuminates a low tire pressure telltale when one or more of your tires are significantly underinflated. Accordingly, when the low tire pressure telltale lights up, you should stop and check your tires as soon as possible, and inflate them to the proper pressure. Driving on a significantly underinflated tire causes the tire to overheat and can lead to tire failure.

Underinflation also reduces fuel efficiency and tire tread life, and may affect the vehicle's handling and stopping ability. Please note that the TPMS is not a substitute for proper tire maintenance, and it is the driver's responsibility to maintain correct tire pressure, even if underinflation has not reached the level to trigger illumination of the TPMS low tire pressure telltale.

Your vehicle has also been equipped with a TPMS malfunction indicator to indicate when the system is not operating properly. The TPMS malfunction indicator is combined with the low tire pressure telltale. When the system detects a malfunction, the warning lamp will flash for approximately a minute and then remain continuously illuminated. This

sequence will be repeated every time the vehicle is started as long as the malfunction exists. When the malfunction indicator is illuminated, the system may not be able to detect or signal low tire pressure as intended.

TPMS malfunctions may occur for a variety of reasons, including the installation of incompatible replacement or alternate tires or wheels on the vehicle that prevent the TPMS from functioning properly. Always check the TPMS malfunction telltale after replacing one or more tires or wheels on your vehicle to ensure that the replacement or alternate Tires and wheels allow the TPMS to continue to function properly.

It is the driver's responsibility to set the tire pressure to that recommended for cold tires which is suitable for the operating situation (▷ page 352). Note that the correct tire pressure for the current operating situation must first be taught-in to the tire pressure monitor. If a substantial loss of pressure occurs, the warning threshold for the warning message is aligned to the taught-in reference values. Restart the tire pressure monitor after adjusting the pressure of the cold tires (▷ page 358). The current pressures are saved as new reference values. As a result, a warning message will appear if the tire pressure drops significantly.

The tire pressure monitor does not warn you of an incorrectly set tire pressure. Observe the notes on the recommended tire pressure (▷ page 352).

The tire pressure monitor is not able to warn you of a sudden loss of pressure, e.g. if the tire is penetrated by a foreign object. In the event of a sudden loss of pressure, bring the vehicle to a halt by braking carefully. Avoid abrupt steering movements.

The tire pressure monitor has a yellow warning lamp in the instrument cluster for indicating pressure loss or a malfunction. Whether the warning lamp flashes or lights up indicates whether a tire pressure is too low or the tire pressure monitor is malfunctioning:

- if the warning lamp is lit continuously, the tire pressure on one or more tires is significantly

too low. The tire pressure monitor is not malfunctioning.

- if the warning lamp flashes for around a minute and then remains lit constantly, the tire pressure monitor is malfunctioning.

In addition to the warning lamp, a message appears in the multifunction display. Observe the information on display messages









(▷ page 262).

It may take up to ten minutes for a malfunction of the tire pressure monitor to be indicated. A malfunction will be indicated by the tire pressure warning lamp flashing for approximately one minute and then remaining lit. When the malfunction has been rectified, the tire pressure warning lamp goes out after a few minutes of driving.

The tire pressure values indicated by the on-board computer may differ from those measured at a gas station with a pressure gauge. The tire pressures shown by the on-board computer refer to those measured at sea level. At high altitudes, the tire pressure values indicated by a pressure gauge are higher than those shown by the on-board computer. In this case, do not reduce the tire pressures.

The operation of the tire pressure monitor can be affected by interference from radio transmitting equipment (e.g. radio headphones, two-way radios) that may be being operated in or near the vehicle.

### Checking the tire pressure electronically

- ▶ Make sure that the SmartKey is in position  (▷ page 136) in the ignition lock.
- ▶ Press  on the steering wheel to call up the menu list.
- ▶ Press  or  on the steering wheel to select the **Service** menu.
- ▶ Confirm by pressing  on the steering wheel.
- ▶ Press  or  to select **Tire Pressure**.
- ▶ Press  to confirm.  
The multifunction display shows the current tire pressure of each wheel.

If the vehicle was parked for longer than 20 minutes, the following message appears: **Tire pressure will be displayed after driving a few minutes.**

After a teach-in process, the tire pressure monitor automatically detects new wheels or new sensors. As long as a clear allocation of the tire pressure value to the individual wheels is not possible, the **Tire Pressure Monitor Active** message is shown instead of the tire pressure display. The tire pressures are already being monitored.

### Tire pressure monitor warning messages

If the tire pressure monitor detects a pressure loss in one or more tires, a warning message is shown in the multifunction display. The yellow tire pressure warning lamp then lights up.

- If the **Please Correct Tire Pressure** message appears in the multifunction display, the tire pressure in at least one tire is too low. The tire pressure must be corrected when the opportunity arises.
- If the **Check Tires** message appears in the multifunction display, the tire pressure in one or more tires has dropped significantly. The tires must be checked.
- If the **Warning Tire Malfunction** message appears in the multifunction display, the tire pressure in one or more tires has dropped suddenly. The tires must be checked.

Be sure to observe the instructions and safety notes in the display messages in the "Tires" section (▷ page 262).

If the wheel positions on the vehicle are rotated, the tire pressures may be displayed for the wrong positions for a short time. This is rectified after a few minutes of driving, and the tire pressures are displayed for the correct positions.

### Restarting the tire pressure monitor









When you restart the tire pressure monitor, all existing warning messages are deleted and the warning lamps go out. The monitor uses the currently set tire pressures as the reference values for monitoring. In most cases, the tire pressure monitor will automatically detect the new reference values after you have changed the tire pressure. However, you can also set reference values manually as described here. The tire pressure monitor then monitors the new tire pressure values.

- ▶ Set the tire pressure to the value recommended for the corresponding driving situation on

the Tire and Loading Information placard on the B-pillar on the driver's side.

You can find more tire pressures for various operating conditions in the tire pressure table inside the filler flap.

Observe the information on tire pressure when doing so (▷ page 352).

- ▶ Make sure that the tire pressure is correct on all four wheels.
- ▶ Make sure that the SmartKey is in position  in the ignition lock (▷ page 136).
- ▶ Press  on the steering wheel to call up the menu list.
- ▶ Press  or  on the steering wheel to select the **Service** menu.
- ▶ Confirm by pressing  on the steering wheel.
- ▶ Press  or  to select **Tire Pressure**.
- ▶ Press  to confirm.  
The multifunction display shows the current tire pressure of each wheel or the **Tire pressure will be displayed after driving a few minutes** message.
- ▶ Press the  button.  
The **Use Current Pressures as New Reference Values** message is shown on the multifunction display.

#### If you wish to confirm the restart:

- ▶ Press the  button.  
The **Tire Press. Monitor Restarted** message is shown on the multifunction display.  
After driving for a few minutes, the system checks whether the current tire pressures are within the specified range. The new tire pressures are then accepted as reference values and monitored.

#### If you wish to cancel the restart:

- ▶ Press the  button.  
The tire pressure values stored at the last restart will continue to be monitored.

### Radio type approval for the tire pressure monitor

Country	Radio type approval number
USA	FCC ID: MRXGG4 FCC ID: MRXMC34MA4
Canada	IC: 2546A-GG4

## Loading the vehicle

### Instruction labels for tires and loads

#### WARNING

Overloaded tires can overheat, causing a blowout. Overloaded tires can also impair the steering and driving characteristics and lead to brake failure. There is a risk of accident.

Observe the load rating of the tires. The load rating must be at least half of the GAWR of your vehicle. Never overload the tires by exceeding the maximum load.

Two instruction labels on your vehicle show the maximum possible load.

- (1) The Tire and Loading Information placard is on the B-pillar on the driver's side. The Tire and Loading Information placard shows the maximum permissible number of occupants and the maximum permissible vehicle load. It also contains details of the tire sizes and corresponding pressures for tires mounted at the factory.
- (2) The vehicle identification plate is on the B-pillar on the driver's side. The vehicle identification plate informs you of the gross vehicle weight rating. It is made up of the vehicle weight, all vehicle occupants, the fuel and the cargo. You can also find information about the maximum gross axle weight rating on the front and rear axle.  
The maximum gross axle weight rating is the maximum weight that can be carried by one axle (front or rear axle). Never exceed the maximum load or the maximum gross axle weight rating for the front or rear axle.



① B-pillar, driver's side

### Maximum permissible gross vehicle weight rating

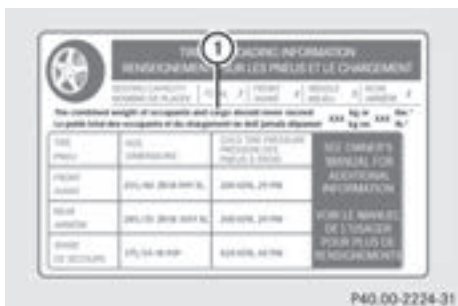

- Specification for maximum gross vehicle weight ① is listed in the Tire and Loading Information placard: "The combined weight of occupants and cargo should never exceed XXX kg or XXX lbs."

The gross weight of all vehicle occupants, load and luggage must not exceed the specified value.

- ① The specifications shown on the Tire and Loading Information placard in the illustration are examples. The maximum permissible gross vehicle weight rating is vehicle-specific and may differ from that in the illustration. You can find the valid maximum permissible gross vehicle weight rating for your vehicle on the Tire and Loading Information placard.

### Number of seats

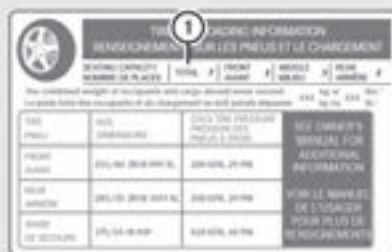

P40.00-2224-31

Maximum number of seats ① indicates the maximum number of occupants allowed to travel in the vehicle. This information can be found on the Tire and Loading Information placard.

- ① The specifications shown on the Tire and Loading Information placard in the illustration are examples. The number of seats is vehicle-specific and can differ from the details shown. The number of seats in your vehicle can be found on the Tire and Loading Information placard.

### Determining the correct load limit

#### Step-by-step instructions

The following steps have been developed as required of all manufacturers under Title 49, Code of U.S. Federal Regulations, Part 575 pursuant to the "National Traffic and Motor Vehicle Safety Act of 1966".

- **Step 1:** Locate the statement "The combined weight of occupants and cargo should never exceed XXX kg or XXX lbs." on your vehicle's Tire and Loading Information placard.
- **Step 2:** Determine the combined weight of the driver and passengers that will be riding in your vehicle.
- **Step 3:** Subtract the combined weight of the driver and passengers from XXX kilograms or XXX lbs.
- **Step 4:** The resulting figure equals the available amount of cargo and luggage load capacity. For example, if the "XXX" amount equals 1400 lbs and there will be five 150-lb passengers in your vehicle, the amount of avail-

able cargo and luggage load capacity is 650 lbs (1400 - 750 (5 x 150) = 650 lbs).

- **Step 5:** Determine the combined weight of luggage and cargo being loaded on the vehi-

cle. That weight may not safely exceed the available cargo and luggage load capacity calculated in step 4.

### Example: steps 1 to 3

The following table shows examples on how to calculate total and cargo load capacities with varying seating configurations and number and size of occupants. The following examples use a load limit of 1500 lbs (680 kg). **This is for illustration purposes only.** Make sure you are using the actual load limit for your vehicle stated on your vehicle's Tire and Loading Information placard (▷ page 359).

The greater the combined weight of the occupants, the lower the maximum luggage load.

#### Step 1

	Example 1	Example 2	Example 3
<b>Combined maximum weight of occupants and load (data from the Tire and Loading Information placard)</b>	1500 lbs (680 kg)	1500 lbs (680 kg)	1500 lbs (680 kg)

#### Step 2

	Example 1	Example 2	Example 3
<b>Number of people in the vehicle (driver and occupants)</b>	5	3	1
<b>Distribution of the occupants</b>	Front: 2 Rear: 3	Front: 1 Rear: 2	Front: 1
<b>Weight of the occupants</b>	Occupant 1: 150 lbs (68 kg) Occupant 2: 180 lbs (82 kg) Occupant 3: 160 lbs (73 kg) Occupant 4: 140 lbs (63 kg) Occupant 5: 120 lbs (54 kg)	Occupant 1: 200 lbs (91 kg) Occupant 2: 190 lbs (86 kg) Occupant 3: 150 lbs (68 kg)	Occupant 1: 150 lbs (68 kg)
<b>Gross weight of all occupants</b>	750 lbs (340 kg)	540 lbs (245 kg)	150 lbs (68 kg)

## Step 3

	Example 1	Example 2	Example 3
<b>Permissible load (maximum gross vehicle weight rating from the Tire and Loading Information placard minus the gross weight of all occupants)</b>	1500 lbs (680 kg) - 750 lbs (340 kg) = 750 lbs (340 kg)	1500 lbs (680 kg) - 540 lbs (245 kg) = 960 lbs (435 kg)	1500 lbs (680 kg) - 150 lbs (68 kg) = 1350 lbs (612 kg)

### Vehicle identification plate

Even if you have calculated the total cargo carefully, you should still make sure that the gross vehicle weight rating and the gross axle weight rating are not exceeded. Details can be found on the vehicle identification plate on the B-pillar on the driver's side of the vehicle (▷ page 359).

**Permissible Gross Vehicle Weight Rating (GVWR):** the gross weight of the vehicle, all passengers, load and trailer load/noseweight (if applicable) must not exceed the permissible gross vehicle weight.

**Gross Axle Weight Rating (GAWR):** the maximum permissible load that can be carried by one axle (front or rear axle).

To ensure that your vehicle does not exceed the maximum permissible values (gross vehicle weight and maximum gross axle weight rating), have your loaded vehicle (including driver, occupants, cargo, and full trailer load if applicable) weighed on a suitable vehicle weighbridge.

## All about wheels and tires

### Uniform Tire Quality Grading Standards

#### Overview of Tire Quality Grading Standards



Uniform Tire Quality Grading Standards are U.S. government specifications. Their purpose is to provide drivers with uniform reliable information on tire performance data. Tire manufacturers have to grade tires using three performance factors: ① tread wear grade, ② traction grade and ③ temperature grade. These regulations do not apply to Canada. Nevertheless, all tires sold in North America are provided with the corresponding quality grading markings on the sidewall of the tire.

Quality grades can be found, where applicable, on the tire sidewall between tread shoulder and maximum section width.

Example:

- **Treadwear grade:** 200
- **Traction grade:** AA
- **Temperature grade:** A

All passenger car tires must conform to the statutory safety requirements in addition to these grades.

**i** The actual values for tires are vehicle-specific and may deviate from the values in the illustration.

### Treadwear

The treadwear grade is a comparative rating based on the wear rate of the tire when tested under controlled conditions on a specified U.S. government course. For example, a tire graded 150 would wear one and one-half times as well on the government course as a tire graded 100. The relative performance of tires depends upon the actual conditions of their use, however, and may depart significantly from the norm due to variations in driving habits, service practices and differences in road characteristics and climate.

### Traction

#### WARNING

The traction grade assigned to this tire is based on straight-ahead braking traction tests, and does not include acceleration, cornering, hydroplaning, or peak traction characteristics.

**!** Avoid wheelspin. This can lead to damage to the drive train.

The traction grades – from highest to lowest – are AA, A, B and C. Those grades represent the tire's ability to stop on wet pavement as measured under controlled conditions on specified government test surfaces of asphalt and concrete. A tire marked C may have poor traction performance.

The safe speed on a wet, snow covered or icy road is always lower than on dry road surfaces. You should pay special attention to road conditions when temperatures are around freezing point.

Mercedes-Benz recommends a minimum tread depth of  $\frac{1}{8}$  in (4 mm) on all four winter tires. Observe the legally required minimum tire tread depth (▷ page 350). Winter tires can reduce the braking distance on snow-covered surfaces in comparison with summer tires. The braking distance is still much further than on surfaces that are not icy or covered with snow. Take appropriate care when driving.

Further information on winter tires (M+S tires) (▷ page 351).

### Temperature

#### WARNING

The temperature grade for this tire is established for a tire that is properly inflated and not overloaded. Excessive speed, underinflation, or excessive loading, either separately or in combination, can cause excessive heat build-up and possible tire failure.

The temperature grades are A (the highest), B, and C, representing the tire's resistance to the generation of heat and its ability to dissipate heat when tested under controlled conditions on a specified indoor laboratory test wheel. Sustained high temperature can cause the material of the tire to degenerate and reduce tire life, and excessive temperature can lead to sudden tire failure. The grade C corresponds to a level of performance which all passenger car tires must meet under the Federal Motor Vehicle Safety Standard No. 109. Grades B and A represent higher levels of performance on the laboratory test wheel than the minimum required by law.



## Tire labeling

### Overview

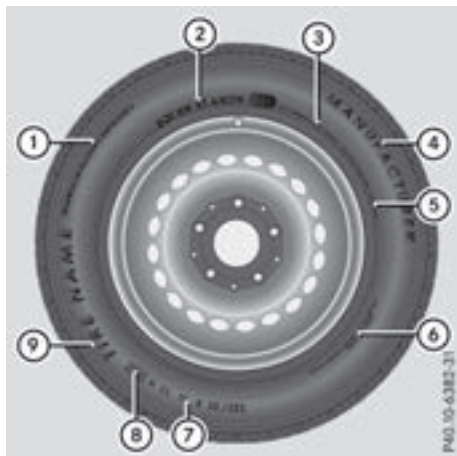

- ① Uniform Tire Quality Grading Standard (▷ page 367)
- ② DOT, Tire Identification Number (▷ page 366)
- ③ Maximum tire load (▷ page 366)
- ④ Manufacturer
- ⑤ Maximum tire pressure (▷ page 355)
- ⑥ Tire material (▷ page 367)
- ⑦ Tire size designation, load-bearing capacity and speed rating (▷ page 364)
- ⑧ Load index (▷ page 366)
- ⑨ Tire name

The markings described above are on the tire in addition to the tire name (sales designation) and the manufacturer's name.

- ⓘ Tire data is vehicle-specific and may deviate from the data in the example.

### Tire size designation, load-bearing capacity and speed rating

#### WARNING

Exceeding the stated tire load-bearing capacity and the approved maximum speed could lead to tire damage or the tire bursting. There is a risk of accident.

Therefore, only use tire types and sizes approved for your vehicle model. Observe the

tire load rating and speed rating required for your vehicle.



- ① Tire width
- ② Nominal aspect ratio in %
- ③ Tire code
- ④ Rim diameter
- ⑤ Load bearing index
- ⑥ Speed rating

**General:** depending on the manufacturer's standards, the size imprinted in the tire wall may not contain any letters or may contain one letter that precedes the size description.

If there is no letter preceding the size description (as shown above): these are passenger vehicle tires according to European manufacturing standards.

If "P" precedes the size description: these are passenger vehicle tires according to U.S. manufacturing standards.

If "LT" precedes the size description: these are light truck tires according to U.S. manufacturing standards.

If "T" precedes the size description: compact emergency wheels with high tire pressure that are only designed for temporary use in an emergency.

**Tire width:** tire width ① shows the nominal tire width in millimeters.

**Height-width ratio:** aspect ratio ② is the size ratio between the tire height and tire width and is shown in percent. The aspect ratio is calculated by dividing the tire width by the tire height.

**Tire code:** tire code ③ specifies the tire type. "R" represents radial tires; "D" represents diagonal tires; "B" represents diagonal radial tires. Optionally, tires with a maximum permissible speed of over 149 mph (240 km/h) may have

"ZR" in the size description, depending on the manufacturer (e.g. 245/40 ZR 18).

**Rim diameter:** rim diameter ④ is the diameter of the bead seat, not the diameter of the rim flange. The rim diameter is specified in inches (in).

**Load-bearing index:** load-bearing index ⑤ is a numerical code that specifies the maximum load-bearing capacity of a tire.

Do not overload the tires by exceeding the specified load limit. The maximum permissible load can be found on the vehicle's Tire and Loading Information placard on the B-pillar on the driver's side (▷ page 359).

Example:

Load-bearing index 91 indicates a maximum load of 1,356 lb (615 kg) that the tires can bear. For further information on the maximum tire load in kilograms and lbs, see (▷ page 366).

For further information on the load bearing index, see "Load index" (▷ page 366).

**Speed rating:** speed rating ⑥ specifies the maximum permissible speed of the tire.

**i** Tire data is vehicle-specific and may deviate from the data in the example.

Regardless of the speed rating, always observe the speed limits. Drive carefully and adapt your driving style to the traffic conditions.

### Summer tires

Index	Speed rating
Q	up to 100 mph (160 km/h)
R	up to 106 mph (170 km/h)
S	up to 112 mph (180 km/h)
T	up to 118 mph (190 km/h)
H	up to 130 mph (210 km/h)
V	up to 149 mph (240 km/h)
W	up to 168 mph (270 km/h)
Y	up to 186 mph (300 km/h)
ZR...Y	up to 186 mph (300 km/h)
ZR...(..Y)	over 186 mph (300 km/h)
ZR	over 149 mph (240 km/h)

- Optionally, tires with a maximum permissible speed of over 149 mph (240 km/h) may have "ZR" in the size description, depending on the manufacturer, e.g. 245/40 ZR 18.

The service specification is made up of load-bearing index ⑤ and speed rating ⑥.

- If the size description of your tire includes "ZR" and there are no service specifications, ask the tire manufacturer in order to find out the maximum permissible speed.

If a service specification is available, the maximum permissible speed is limited according to the speed rating in the service specification. Example: 245/40 ZR18 97 Y. In this example, "97 Y" is the service specification. The letter "Y" represents the speed rating. The maximum permissible speed of the tire is limited to 186 mph (300 km/h).

- The size description for all tires with maximum permissible speeds of over 186 mph (300 km/h) must include "ZR", **and** the service specification must be given in parentheses. Example: 275/40 ZR 18 (99 Y). Speed rating "Y" indicates that the maximum permissible speed of the tire is over 186 mph (300 km/h). To find out the maximum permissible speed, ask the tire manufacturer.

### All-weather tires and winter tires

Index	Speed rating
Q M+S <sup>1</sup>	up to 100 mph (160 km/h)
T M+S <sup>1</sup>	up to 118 mph (190 km/h)
H M+S <sup>1</sup>	up to 130 mph (210 km/h)
V M+S <sup>1</sup>	up to 149 mph (240 km/h)

**i** Not all tires with the M+S marking provide the driving characteristics of winter tires. In addition to the M+S marking, winter tires also have the  snowflake symbol on the tire wall. Tires with this marking fulfill the requirements of the Rubber Manufacturers Association (RMA) and the Rubber Association of Canada (RAC) regarding the tire traction on snow. They have been especially developed for driving on snow.

An electronic speed limiter prevents your vehicle from exceeding a speed of 130 mph (210 km/h).

<sup>1</sup> Or M+S  for winter tires.

The speed rating of tires mounted at the factory may be higher than the maximum permissible speed permitted by the electronic speed limiter. Make sure that your tires have the required speed rating, e.g. when buying new tires. You can find information on this under "Tires" (▷ page 373).

Further information about reading tire data can be obtained from any qualified specialist workshop.

### Load index



In addition to the load-bearing index, load index ① may also be imprinted on the sidewall of the tire. You will find this after the letter that identifies the speed rating (▷ page 364).

- If no specification is given: no text (as in the example above), represents a standard load (SL) tire
- XL or Extra Load: represents a reinforced tire
- Light Load: represents a light load tire
- C, D, E: represents a load range that depends on the maximum load that the tire can carry at a certain pressure

**i** Tire data is vehicle-specific and may deviate from the data in the example.

### Maximum load rating

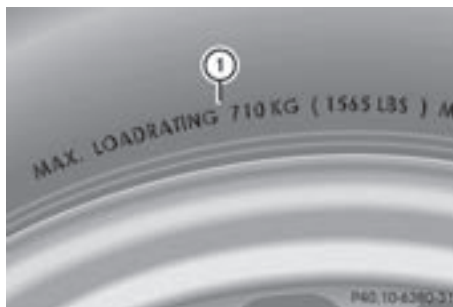

Maximum tire load ① is the maximum permissible weight for which the tire is approved.

Do not overload the tires by exceeding the specified load limit. The maximum permissible load can be found on the vehicle's Tire and Loading Information placard on the B-pillar on the driver's side (▷ page 359).

**i** The actual values for tires are vehicle-specific and may deviate from the values in the illustration.

### DOT, Tire Identification Number (TIN)

US tire regulations stipulate that every tire manufacturer or retreader must imprint a TIN in or on the sidewall of each tire produced.



The TIN is a unique identification number. The TIN enables the tire manufacturers or retreaders to inform purchasers of recalls and other safety-relevant matters. It makes it possible for the purchaser to easily identify the affected tires.

The TIN is made up of manufacturer identification code ②, tire size ③, tire type code ④ and manufacturing date ⑤.

**DOT (Department of Transportation):** tire symbol ① marks that the tire complies with the

requirements of the U.S. Department of Transportation.

**Manufacturer identification code:** manufacturer identification code ② provides details on the tire manufacturer. New tires have a code with two symbols. Retreaded tires have a code with four symbols.

For further information about retreaded tires, see (> page 373).

**Tire size:** identifier ③ describes the tire size.

**Tire type code:** tire type code ④ can be used by the manufacturer as a code to describe specific characteristics of the tire.

**Date of manufacture:** date of manufacture ⑤ provides information about the age of a tire. The first and second positions represent the week of manufacture, starting with "01" for the first calendar week. Positions three and four represent the year of manufacture. For example, a tire that is marked "3214" was manufactured in week 32 in 2014.

- ① Tire data is vehicle-specific and may deviate from the data in the example.

## Tire characteristics



This information describes the type of tire cord and the number of layers in sidewall ① and under tire tread ②.

- ① Tire data is vehicle-specific and may deviate from the data in the example.

## Definition of terms for tires and loading

### Tire ply composition and material used

Describes the number of plies or the number of layers of rubber-coated fabric in the tire tread and sidewall. These are made of steel, nylon, polyester and other materials.

### Bar

Metric unit for tire pressure. 14.5038 pounds per square inch (psi) and 100 kilopascals (kPa) are the equivalent of 1 bar.

### DOT (Department of Transportation)

DOT-marked tires fulfill the requirements of the U S Department of Transportation.

### Normal occupant weight

The number of occupants for which the vehicle is designed multiplied by 68 kilograms (150 lbs).

### Uniform Tire Quality Grading Standards

A uniform standard to grade the quality of tires with regards to tread quality, tire traction and temperature characteristics. The quality grading assessment is made by the manufacturer following specifications from the U.S. government. The ratings are molded into the sidewall of the tire.

### Recommended tire pressures

The recommended tire pressure applies to the tires mounted at the factory.

The Tire and Loading Information placard contains the recommended tire pressures for cold tires on a fully loaded vehicle and for the maximum permissible vehicle speed.

The tire pressure table contains the recommended pressures for cold tires for various operating conditions, i.e. differing load and speed conditions.

### Increased vehicle weight due to optional equipment

The combined weight of all standard and optional equipment available for the vehicle, regardless of whether it is actually installed on the vehicle or not.

### Rim

This is the part of the wheel on which the tire is mounted.

### GAWR (Gross Axle Weight Rating)

The GAWR is the maximum gross axle weight rating. The actual load on an axle must never exceed the gross axle weight rating. The gross axle weight rating can be found on the vehicle identification plate on the B-pillar on the driver's side.

### Speed rating

The speed rating is part of the tire identification. It specifies the speed range for which the tire is approved.

### GVW (Gross Vehicle Weight)

The gross vehicle weight includes the weight of the vehicle including fuel, tools, the spare wheel, accessories installed, occupants, luggage and the drawbar noseweight, if applicable. The gross vehicle weight must not exceed the gross vehicle weight rating GVWR as specified on the vehicle identification plate on the B-pillar on the driver's side.

### GVWR (Gross Vehicle Weight Rating)

The GVWR is the maximum permissible gross weight of a fully loaded vehicle (the weight of the vehicle including all accessories, occupants, fuel, luggage and the drawbar noseweight, if applicable). The gross vehicle weight rating is specified on the vehicle identification plate on the B-pillar on the driver's side.

### Maximum loaded vehicle weight

The maximum weight is the sum of:

- the curb weight of the vehicle
- the weight of the accessories
- the load limit
- the weight of the factory installed optional equipment

### Kilopascal (kPa)

Metric unit for tire pressure. 6.9 kPa corresponds to 1 psi. Another unit for tire pressure is bar. 100 kilopascals (kPa) are the equivalent of 1 bar.

### Load index

In addition to the load-bearing index, the load index may also be imprinted on the sidewall of the tire. This specifies the load-bearing capacity more precisely.

### Curb weight

The weight of a vehicle with standard equipment including the maximum capacity of fuel, oil and coolant. It also includes the air-conditioning system and optional equipment if these are installed in the vehicle, but does not include passengers or luggage.

### Maximum load rating

The maximum tire load is the maximum permissible weight in kilograms or lbs for which a tire is approved.

### Maximum permissible tire pressure

Maximum permissible tire pressure for one tire.

### Maximum load on one tire

Maximum load on one tire. This is calculated by dividing the maximum axle load of one axle by two.

### PSI (pounds per square inch)

A standard unit of measure for tire pressure.

### Aspect ratio

Relationship between tire height and tire width in percent.

### Tire pressure

This is pressure inside the tire applying an outward force to each square inch of the tire's surface. The tire pressure is specified in pounds per square inch (psi), in kilopascal (kPa) or in bar. The tire pressure should only be corrected when the tires are cold.

### Cold tire pressure

The tires are cold:

- if the vehicle has been parked with the tires out of direct sunlight for at least three hours and
- if the vehicle has not been driven further than 1 mile (1.6 km)

### Tread

The part of the tire that comes into contact with the road.

### Bead

The tire bead ensures that the tire sits securely on the wheel. There are several steel wires in the bead to prevent the tire from coming loose from the wheel rim.

### Sidewall

The part of the tire between the tread and the bead.

## Weight of optional extras

The combined weight of those optional extras that weigh more than the replaced standard parts and more than 5 lbs (2.3 kg). These optional extras, such as high-performance brakes, level control, a roof rack or a high-performance battery, are not included in the curb weight and the weight of the accessories.

## TIN (Tire Identification Number)

This is a unique identifier which can be used by a tire manufacturer to identify tires, for example for a product recall, and thus identify the purchasers. The TIN is made up of the manufacturer's identity code, tire size, tire type code and the manufacturing date.

## Load bearing index

The load bearing index (also load index) is a code that contains the maximum load bearing capacity of a tire.

## Traction

Traction is the result of friction between the tires and the road surface.

## Treadwear indicators

Narrow bars (tread wear bars) that are distributed over the tire tread. If the tire tread is level with the bars, the wear limit of  $\frac{1}{16}$  in (1.6 mm) has been reached.

## Occupant distribution

The distribution of occupants in a vehicle at their designated seating positions.

## Total load limit

Nominal load and luggage load plus 68 kg (150 lbs) multiplied by the number of seats in the vehicle.

## Changing a wheel

### Flat tire

The "Breakdown assistance" section (> page 334) contains information and notes on how to deal with a flat tire. Information on driving with MOExtended tires in the event of a flat tire can be found under "MOExtended tires (tires with run-flat characteristics)" (> page 334).

## Rotating the wheels

### WARNING

Interchanging the front and rear wheels may severely impair the driving characteristics if the wheels or tires have different dimensions. The wheel brakes or suspension components may also be damaged. There is a risk of accident.

Rotate front and rear wheels only if the wheels and tires are of the same dimensions.

**!** On vehicles equipped with a tire pressure monitor, electronic components are located in the wheel.

Tire-mounting tools should not be used near the valve. This could damage the electronic components.

Only have tires changed at a qualified specialist workshop.

Always observe the instructions and safety notes in the "Mounting a wheel" section (> page 370).

The wear patterns on the front and rear tires differ, depending on the operating conditions. Rotate the wheels before a clear wear pattern has formed on the tires. Front tires typically wear more on the shoulders and the rear tires in the center.

On vehicles that have the same size front and rear wheels, you can rotate the wheels according to the intervals in the tire manufacturer's warranty book in your vehicle documents. If no warranty book is available, the tires should be rotated every 3,000 to 6,000 miles (5,000 to 10,000 km). Depending on tire wear, this may be required earlier. Do not change the direction of wheel rotation.

Clean the contact surfaces of the wheel and the brake disc thoroughly every time a wheel is rotated. Check the tire pressure and, if necessary, restart the tire pressure loss warning system (> page 356) or the tire pressure monitor (> page 358).

### Direction of rotation

Tires with a specified direction of rotation have additional benefits, e.g. if there is a risk of hydroplaning. These advantages can only be gained if



the tires are installed corresponding to the direction of rotation.

An arrow on the sidewall of the tire indicates its correct direction of rotation.

### Storing wheels

Store wheels that are not being used in a cool, dry and preferably dark place. Protect the tires from oil, grease, gasoline and diesel.

### Mounting a wheel

#### Preparing the vehicle

- ▶ Stop the vehicle on solid, non-slippery and level ground.
- ▶ Apply the electric parking brake manually.
- ▶ Bring the front wheels into the straight-ahead position.
- ▶ Shift the transmission to position **P**.
- ▶ Make sure that the vehicle level is set to "Normal" on vehicles with AIR BODY CONTROL (▷ page 186).
- ▶ Switch off the engine.
- ▶ **Vehicles without KEYLESS-GO:** remove the SmartKey from the ignition lock.
- ▶ **Vehicles with KEYLESS-GO start-function or KEYLESS-GO:** open the driver's door. The vehicle electronics are now in key position **0**. This is the same as the key having been removed.
- ▶ **Vehicles with KEYLESS-GO start-function or KEYLESS-GO:** remove the Start/Stop button from the ignition lock (▷ page 137).
- ▶ Make sure that the engine cannot be started via your smartphone (▷ page 139).
- ▶ If included in the vehicle equipment, remove the tire-change tool kit from the vehicle.
- ▶ Safeguard the vehicle against rolling away.

#### Securing the vehicle to prevent it from rolling away

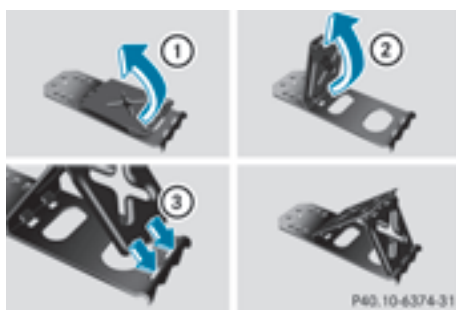

If your vehicle is equipped with a wheel chock, it can be found in the tire-change tool kit (▷ page 333).

The folding wheel chock is an additional safety measure to prevent the vehicle from rolling away, for example when changing a wheel.

- ▶ Fold both plates upwards ①.
- ▶ Fold out lower plate ②.
- ▶ Guide the lugs on the lower plate fully into the openings in base plate ③.



- ▶ Place chocks or other suitable items under the front and rear of the wheel that is diagonally opposite the wheel you wish to change.

#### Raising the vehicle

##### WARNING

If you do not position the jack correctly at the appropriate jacking point of the vehicle, the jack could tip over with the vehicle raised. There is a risk of injury.

Only position the jack at the appropriate jacking point of the vehicle. The base of the jack



must be positioned vertically, directly under the jacking point of the vehicle.

- ❗ Only position the jack at the appropriate jacking point of the vehicle. Otherwise, you could damage the vehicle.

### Observe the following when raising the vehicle:

- To raise the vehicle, only use the vehicle-specific jack that has been tested and approved by Mercedes-Benz. If used incorrectly, the jack could tip over with the vehicle raised.
- The jack is designed only to raise and hold the vehicle for a short time while a wheel is being changed. It must not be used for performing maintenance work under the vehicle.
- Avoid changing the wheel on uphill and downhill slopes.
- Before raising the vehicle, secure it from rolling away by applying the parking brake and inserting wheel chocks. Do not disengage the parking brake while the vehicle is raised.
- The jack must be placed on a firm, flat and non-slip surface. On a loose surface, a large, flat, load-bearing underlay must be used. On a slippery surface, a non-slip underlay must be used, e.g. rubber mats.
- Do not use wooden blocks or similar objects as a jack underlay. Otherwise, the jack will not be able to achieve its load-bearing capacity due to the restricted height.
- Make sure that the distance between the underside of the tires and the ground does not exceed 1.2 in (3 cm).
- Do not place your hands or feet under the raised vehicle.
- Do not lie under the vehicle.
- Do not start the engine when the vehicle is raised.
- Never open or close a door or the tailgate when the vehicle is raised.
- Make sure that no persons are present in the vehicle when the vehicle is raised.



- Using lug wrench ①, loosen the bolts on the wheel you wish to change by about one full turn. Do not unscrew the bolts completely.



The jacking points are located just behind the front wheel housings and just in front of the rear wheel housings (arrows).

- Take the ratchet wrench out of the tire-changing tool kit and place it on the hexagon nut of the jack so that the letters **AUF** are visible.

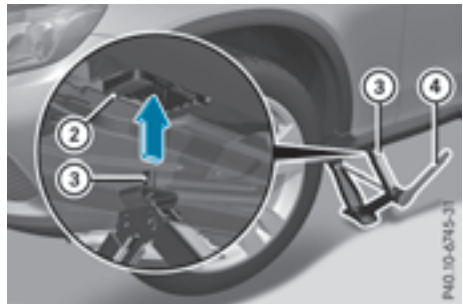

- Position jack ③ at jacking point ②.

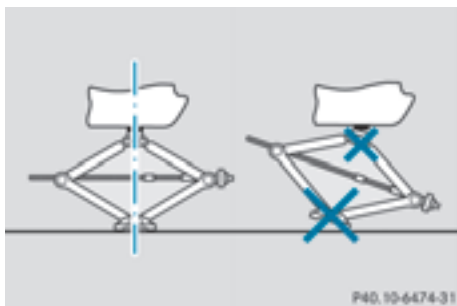

- ▶ Make sure the foot of the jack is directly beneath the jacking point.
- ▶ Turn ratchet wrench ④ until jack ③ sits completely on jacking point ② and the base of the jack lies evenly on the ground.
- ▶ Turn ratchet wrench ④ until the tire is raised a maximum of 1.2 in (3 cm) off the ground.

### Removing a wheel

- ❗ Do not place wheel bolts in sand or on a dirty surface. The bolt and wheel hub threads could otherwise be damaged when you screw them in.



- ▶ Unscrew the uppermost wheel bolt completely.
- ▶ Screw alignment bolt ① into the thread instead of the wheel bolt.
- ▶ Unscrew the remaining wheel bolts fully.
- ▶ Remove the wheel.

### Mounting a new wheel

#### WARNING

Oiled or greased wheel bolts or damaged wheel bolts/hub threads can cause the wheel

bolts to come loose. As a result, you could lose a wheel while driving. There is a risk of accident.

Never oil or grease wheel bolts. In the event of damage to the threads, contact a qualified specialist workshop immediately. Have the damaged wheel bolts or hub threads replaced/renewed. Do not continue driving.

#### WARNING

If you tighten the wheel bolts or wheel nuts when the vehicle is raised, the jack could tip over. There is a risk of injury.

Only tighten the wheel bolts or wheel nuts when the vehicle is on the ground.

Always pay attention to the instructions and safety notes in the "Changing a wheel" section (▷ page 369).

Only use wheel bolts that have been designed for the wheel and the vehicle. For safety reasons, Mercedes-Benz recommends that you only use wheel bolts which have been approved for Mercedes-Benz vehicles and the respective wheel.

- ❗ To prevent damage to the paintwork, hold the wheel securely against the wheel hub while screwing in the first wheel bolt.

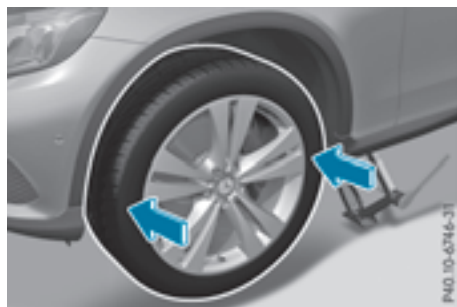

- ▶ Clean the wheel and wheel hub contact surfaces.
- ▶ Slide the wheel to be mounted onto the alignment bolt and push it on.
- ▶ Tighten the wheel bolts until they are finger-tight.
- ▶ Unscrew the alignment bolt.
- ▶ Tighten the last wheel bolt until it is finger-tight.

## Lowering the vehicle

### WARNING

The wheels could work loose if the wheel nuts and bolts are not tightened to the specified tightening torque. There is a risk of accident. Have the tightening torque immediately checked at a qualified specialist workshop after a wheel is changed.

- ▶ Place the ratchet wrench onto the hexagon nut of the jack so that the letters **AB** are visible.
- ▶ Turn the ratchet wrench until the vehicle is once again standing firmly on the ground.
- ▶ Place the jack to one side.



- ▶ Tighten the wheel bolts evenly in a crosswise pattern in the sequence indicated (① to ⑤). The tightening torque must be **111 lb-ft (150 Nm)**.
- ▶ Turn the jack back to its initial position.
- ▶ Stow the jack and the rest of the tire-change tool kit in the cargo compartment again.
- ▶ Check the tire pressure of the newly mounted wheel and adjust it if necessary.  
Observe the recommended tire pressure (▷ page 352).

When you are driving with the collapsible spare wheel mounted, the tire pressure loss warning system or the tire pressure monitor cannot function reliably. Only restart the tire pressure loss warning system or tire pressure monitor when the defective wheel has been replaced with a new wheel.

**Vehicles with a tire pressure control system:** all installed wheels must be equipped with functioning sensors.

## Wheel/tire combination

You can ask for information regarding permitted wheel/tire combinations at an authorized Mercedes-Benz Center.

**!** For safety reasons, Mercedes-Benz recommends that you only use tires and wheels which have been approved by Mercedes-Benz specifically for your vehicle.

These tires have been specially adapted for use with the control systems, such as ABS or ESP®, and are marked as follows:

- MO = Mercedes-Benz Original
- MOE = Mercedes-Benz Original Extended (tires featuring run-flat characteristics)
- MO1 = Mercedes-Benz Original (only certain AMG tires)

Mercedes-Benz Original Extended tires may only be used on wheels that have been specifically approved by Mercedes-Benz.

Only use tires, wheels or accessories tested and approved by Mercedes-Benz. Certain characteristics, e.g. handling, vehicle noise emissions or fuel consumption, may otherwise be adversely affected. In addition, when driving with a load, tire dimension variations could cause the tires to come into contact with the bodywork and axle components. This could result in damage to the tires or the vehicle.

Mercedes-Benz accepts no liability for damage resulting from the use of tires, wheels or accessories other than those tested and approved.

Information on tires, wheels and approved combinations can be obtained from any qualified specialist workshop.

**!** Retreaded tires are neither tested nor recommended by Mercedes-Benz, since previous damage cannot always be detected on retreaded tires. As a result, Mercedes-Benz cannot guarantee vehicle safety if retreaded tires are mounted. Do not mount used tires if you have no information about their previous usage.

The recommended pressures for various operating conditions can be found:

- on the Tire and Loading Information placard on the B-pillar on the driver's side
- in the tire pressure table in the fuel filler flap

Observe the notes on recommended tire pressures under various operating conditions (> page 352).

Check tire pressures regularly, and only when the tires are cold. Comply with the maintenance recommendations of the tire manufacturer in the vehicle document wallet.

Notes on the vehicle equipment – always equip the vehicle:

- with tires of the same size on a given axle (left and right)
- with the same type of tires at a given time (summer tires, winter tires, MOExtended tires)

Exception: it is permissible to install a different type or make in the event of a flat tire.

Observe the "MOExtended tires (tires with run-flat characteristics)" section (> page 334).

Vehicles equipped with MOExtended tires are not equipped with a TIREFIT kit at the factory. It is therefore recommended that you additionally equip your vehicle with a TIREFIT kit if you mount tires that do not feature run-flat properties, e.g. winter tires. A TIREFIT kit may be obtained from a qualified specialist workshop.

## Information regarding technical data

**Hybrid vehicles:** be sure to observe the notes in the supplement. Otherwise, you may not recognize dangers.

- ❗ The data stated here specifically refers to a vehicle with standard equipment. Consult an authorized Mercedes-Benz Center for the data for all vehicle variants and trim levels.

## Vehicle electronics

### Installing wireless devices and mobile phones

#### ⚠ WARNING

The electromagnetic radiation from two-way radios can interfere with the vehicle electronics if two-way radios are manipulated or retrofitted incorrectly. This could jeopardize the operating safety of the vehicle. There is a risk of an accident.

You should have all work on electrical and electronic components carried out at a qualified specialist workshop.

#### ⚠ WARNING

If you incorrectly operate two-way radios in the vehicle, the electromagnetic radiation may interfere with the vehicle electronics, for example if:

- the two-way radio is not connected to an exterior antenna
- the exterior antenna is not correctly mounted or is not low-reflection

This could jeopardize the operating safety of the vehicle. There is a risk of an accident.

Have the low-reflection exterior antenna installed at a qualified specialist workshop. Always connect two-way radios to the low-reflection exterior antenna when operating in the vehicle.

- ❗ The operating permit may be invalidated if the instructions for installation and use of two-way radios are not observed.

In particular, the following conditions must be complied with:

- only approved wavebands may be used.
- observe the maximum permissible output in these wavebands.
- only approved antenna positions may be used.

Excessive levels of electromagnetic radiation may cause damage to your health and the health of others. Using an exterior antenna takes into account current scientific discussions relating to the possible health hazards that may result from electromagnetic fields.

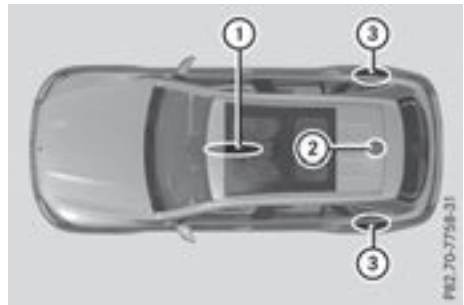

Approved antenna positions

- ① Front roof area
- ② Rear roof area
- ③ Rear fender

**Vehicles with panorama roof with power tilt/sliding panel:** installing an antenna to the front or rear roof area is not permitted.

On the rear fenders, it is recommended to position the antenna on the side of the vehicle closest to the center of the road.

Use Technical Specification ISO/TS 21609 (Road Vehicles - "EMC guidelines for installation of aftermarket radio frequency transmitting equipment") when retrofitting two-way radios. Observe the legal requirements for accessory parts.

If your vehicle has installations for two-way radio equipment, use the power supply or antenna connections intended for use with the basic wiring. Be sure to observe the manufacturer's Supplement when installing.

Deviations with respect to frequency bands, maximum transmission outputs or antenna positions must be approved by Mercedes-Benz.

The maximum transmission output (PEAK) at the base of the antenna must not exceed the following values:

Frequency band	Maximum transmission output
Short wave 3 - 54 MHz	100 W
4 m waveband 74 - 88 MHz	30 W
2 m waveband 144 - 174 MHz	50 W
Trunked radio system/ Tetra 380 - 460 MHz	10 W
70 cm waveband 400 - 460 MHz	35 W
Mobile communications (2G/3G/4G)	10 W

The following can be used in the vehicle without restrictions:

- Two-way radios with a maximum transmission output of up to 100 mW
- Two-way radios with transmitter frequencies in the 380 - 410 MHz waveband and a maximum transmission output of up to 2 W (trunked radio/Tetra)
- Mobile phones (2G/3G/4G)

There is no restriction for antenna positions on the outside of the vehicle for the following frequency bands:

- Trunked radio system/Tetra
- 70 cm waveband
- 2G/3G/4G

## Identification plates

### Vehicle identification plate with vehicle identification number (VIN)



Location of vehicle identification plate (example, left-hand-drive vehicle)

- Open the driver's door.  
You will see vehicle identification plate ①.



Example: vehicle identification plate (USA only)

- ① Paint code
- ② VIN



Example: vehicle identification plate (Canada only)

- ① Paint code
- ② VIN

**i** The data shown on the vehicle identification plate is used only as an example. This data is different for every vehicle and can deviate from the data shown here. You can find the data applicable to your vehicle on the vehicle identification plate.

### Vehicle identification number (VIN)

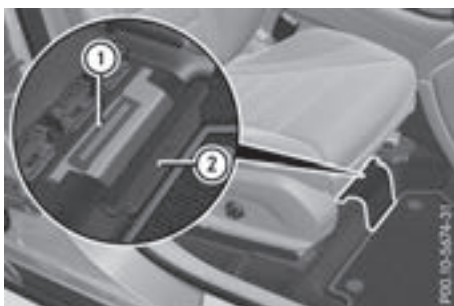

- ▶ Slide the right-hand front seat to its rearmost position.
- ▶ Fold floor covering ② upwards. The VIN is visible ①.

The VIN can also be found on the vehicle identification plate (▷ page 376).

The VIN can also be found at the lower edge of the windshield (▷ page 377).

### Engine number



- ① Engine number (stamped into the crankcase)
- ② VIN (on the lower edge of the windshield)
- ③ Emission control information plate, including the certification of both federal and Californian emissions standards

### Service products and filling capacities

#### Important safety notes

#### **⚠ WARNING**

Service products may be poisonous and hazardous to health. There is a risk of injury.

Comply with instructions on the use, storage and disposal of service products on the labels of the respective original containers. Always store service products sealed in their original containers. Always keep service products out of the reach of children.

#### **♻ Environmental note**

Dispose of service products in an environmentally responsible manner.

Service products include the following:

- Fuels
- Lubricants (e.g. engine oil, transmission oil)
- Coolant
- Brake fluid
- Windshield washer fluid
- Climate control system refrigerant

Components and service products must match. Only use products recommended by Mercedes-



Benz. Damage which is caused by the use of products which have not been recommended is not covered by the Mercedes-Benz warranty or goodwill gestures. Products approved by Mercedes-Benz are listed in this Operator's Manual in the appropriate section.

Information on tested and approved products can be obtained at a Mercedes-Benz Service Center or on the Internet at <http://bevo.mercedes-benz.com>.

You can recognize service products approved by Mercedes-Benz by the following inscription on the containers:

- MB-Freigabe (e.g. MB-Freigabe 229.51)
- MB-Approval (e.g. MB-Approval 229.51)

Other designations or recommendations indicate a level of quality or a specification in accordance with an MB Sheet Number (e.g. MB 229.5). They have not necessarily been approved by Mercedes-Benz.

Other identifications, for example:

- 0W-30
- 5W-30
- 5W-40

## Fuel

### Important safety notes

#### WARNING

Fuel is highly flammable. If you handle fuel incorrectly, there is a risk of fire and explosion.

You must avoid fire, open flames, creating sparks and smoking. Switch off the engine and, if applicable, the auxiliary heating before refueling.

#### WARNING

Fuel is poisonous and hazardous to health. There is a risk of injury.

You must make sure that fuel does not come into contact with your skin, eyes or clothing and that it is not swallowed. Do not inhale fuel vapors. Keep fuel away from children.

If you or others come into contact with fuel, observe the following:

- Wash away fuel from skin immediately using soap and water.
- If fuel comes into contact with your eyes, immediately rinse them thoroughly with clean water. Seek medical assistance without delay.
- If fuel is swallowed, seek medical assistance without delay. Do not induce vomiting.
- Immediately change out of clothing which has come into contact with fuel.

### Tank capacity

Model	Total capacity
All models	17.4 US gal (66.0 l)

Model	Of which reserve
Mercedes-AMG GLC 63 4MATIC+	Approx. 2.6 US gal (10.0 l)
Mercedes-AMG GLC 63 S 4MATIC+	Approx. 2.6 US gal (10.0 l)
All other models	Approx. 1.8 US gal (7.0 l)

### Gasoline

#### Fuel grade

 Do not use diesel to refuel vehicles with a gasoline engine. Do not switch on the ignition if you accidentally refuel with the wrong fuel. Otherwise, the fuel will enter the fuel system. Even small amounts of the wrong fuel could result in damage to the fuel system and the engine. Notify a qualified specialist workshop and have the fuel tank and fuel lines drained completely.

 Only refuel using unleaded premium grade gasoline with at least 91 AKI/95 RON.

 E10 fuel contains up to 10% bioethanol. Your vehicle is E10-compatible. You can refuel your vehicle using E10 fuel.

**!** Only use the fuel recommended. Operating the vehicle with other fuels can lead to damage to the fuel system, engine and exhaust system.

**!** Do not use the following:

- Gasoline with more than 10% ethanol
- E100 (100% ethanol)
- Gasoline with methanol
- M100 (100% methanol)
- Gasoline with metalliferous additives
- Diesel

Do not mix such fuels with the fuel recommended for your vehicle.

**!** To ensure the longevity and full performance of the engine, only premium-grade unleaded gasoline must be used.

If standard unleaded gasoline is unavailable and you have to refuel with unleaded gasoline of a lower grade, observe the following precautions:

- Only fill the fuel tank to half full with regular unleaded gasoline and fill the rest with premium-grade unleaded gasoline as soon as possible.
- Do not drive at the maximum speed.
- Avoid sudden acceleration and engine speeds over 3,000 rpm.

You will usually find information about the fuel grade on the fuel pump. If you cannot find the label on the fuel pump, ask the gas station staff.

**i** For further information, consult a qualified specialist workshop or visit <http://www.mbusa.com> (USA only).

As a temporary measure, if the recommended fuel is not available, you may also use regular unleaded gasoline with an octane rating of 87 AKI/91 RON. This may reduce engine performance and increase fuel consumption. Avoid driving at full throttle and sudden acceleration. Never refuel using gasoline with a lower AKI. Information on refueling .

### Additives

**!** Operating the engine with fuel additives added later can lead to engine failure. Do not mix fuel additives with fuel. This does not include additives for the removal and prevention of residue buildup. Gasoline must only be mixed with additives recommended by

Mercedes-Benz. Comply with the instructions for use on the product label. More information about recommended additives can be obtained from any authorized Mercedes-Benz Center.

Mercedes-Benz recommends that you use branded fuels that have additives.

The fuel quality available in some countries may not be sufficient. Residue could build up in the fuel injection system as a result. In such cases, and in consultation with an authorized Mercedes-Benz Center, the fuel may be mixed with the cleaning additive recommended by Mercedes-Benz. You must observe the notes and mixing ratios specified on the container.

## Engine oil

### General notes



**!** Do not use engine oil or an oil filter with specifications deviating from those expressly required for the prescribed service intervals. Do not change the engine oil or oil filter in order to set replacement intervals longer than those prescribed. This could otherwise cause damage to the engine or exhaust gas after-treatment.

Follow the instructions on the service interval display for changing the engine oil. This could otherwise cause damage to the engine or exhaust gas aftertreatment.

When handling engine oil, observe the important safety notes on service products (> page 377).

The engine oils are matched to the performance of Mercedes-Benz engines and service intervals. You should therefore only use engine oils and oil filters that are approved for vehicles with maintenance systems.

For a list of approved engine oils and oil filters, consult an authorized Mercedes-Benz Center. Or visit the website <http://bevo.mercedes-benz.com>.

The table shows which engine oils have been approved for your vehicle.

Model	MB-Freigabe or MB-Approval
Mercedes-AMG vehicles	229.5
All other models	229.5, 229.6

Use only SAE 0W-40 or SAE 5W-40 engine oils for Mercedes-AMG vehicles.

**i** MB approval is indicated on the oil containers.

### Filling capacities

The following values refer to an oil change including the oil filter.

Model	Capacity
Mercedes-AMG GLC 63 4MATIC+	9.5 US qt (9.0 l)
Mercedes-AMG GLC 63 S 4MATIC+	
All other models	6.9 US qt (6.5 l)

### Additives

**!** Do not use any additives in the engine oil. This could damage the engine.

### Brake fluid

#### **!** WARNING

The brake fluid constantly absorbs moisture from the air. This lowers the boiling point of the brake fluid. If the boiling point of the brake fluid is too low, vapor pockets may form in the brake system when the brakes are applied hard. This would impair braking efficiency. There is a risk of an accident.

You should have the brake fluid renewed at the specified intervals.

When handling brake fluid, observe the important safety notes on service products (> page 377).

The brake fluid change intervals can be found in the Maintenance Booklet.

Only use brake fluid approved by Mercedes-Benz in accordance with MB-Freigabe or MB-Approval 331.0.

Information about approved brake fluid can be obtained at any qualified specialist workshop or on the Internet at <http://bevo.mercedes-benz.com>.

**i** Have the brake fluid regularly replaced at a qualified specialist workshop in accordance with the replacement intervals and the replacement confirmed in the Maintenance Booklet.

### Coolant

### Important safety notes

#### **!** WARNING

If antifreeze comes into contact with hot components in the engine compartment, it may ignite. There is a risk of fire and injury.

Let the engine cool down before you add antifreeze. Make sure that antifreeze is not spilled next to the filler neck. Thoroughly clean the antifreeze from components before starting the engine.

**!** Only add coolant that has been premixed with the desired antifreeze protection. You could otherwise damage the engine.

Further information on coolants can be found in the Mercedes-Benz Specifications for Service Products, MB BeVo 310.1, e.g. on the Internet at

<http://bevo.mercedes-benz.com>. Or contact a qualified specialist workshop.

**!** Always use a suitable coolant mixture, even in countries where high temperatures prevail. Otherwise, the engine cooling system is not sufficiently protected from corrosion and overheating.

**i** Have the coolant regularly replaced at a qualified specialist workshop and the replacement confirmed in the Maintenance Booklet.

Comply with the important safety notes for service products when handling coolant (▷ page 377).

The coolant is a mixture of water and anti-freeze/corrosion inhibitor. It performs the following tasks:

- anti-corrosion protection
- antifreeze protection
- raising the boiling point

If the coolant has antifreeze protection down to -35 °F (-37 °C), the boiling point of the coolant during operation is approximately 266 °F (130 °C).

The antifreeze concentrate/corrosion inhibitor concentration in the engine cooling system should:

- be at least 50%. This will protect the engine cooling system against freezing down to approximately -35 °F (-37 °C).
- not exceed 55% (antifreeze protection down to -49 °F [-45 °C]). Otherwise, heat will not be dissipated as effectively

Mercedes-Benz recommends an antifreeze/corrosion inhibitor concentrate in accordance with MB Specifications for Service Products 310.1.

- i** When the vehicle is first delivered, it is filled with a coolant mixture that ensures adequate antifreeze and anti-corrosion protection.
- i** The coolant is checked with every maintenance interval at a qualified specialist workshop.

## Filling capacities

Model	Capacity
Mercedes-AMG GLC 43 4MATIC	12.2 US qt (11.5 l)
Mercedes-AMG GLC 63 4MATIC+ Mercedes-AMG GLC 63 S 4MATIC+	11.7 US qt (11.1 l)
All other models	12.7 US qt (12.0 l)

## Windshield washer system

### Important safety notes

#### WARNING

Windshield washer concentrate could ignite if it comes into contact with hot engine components or the exhaust system. There is a risk of fire and injury.

Make sure that no windshield washer concentrate is spilled next to the filler neck.

- !** Only use washer fluid that is suitable for plastic lamp lenses, e.g. MB SummerFit or MB WinterFit. Unsuitable washer fluid could damage the plastic lenses of the headlamps.
- !** Only MB SummerFit and MB WinterFit washer fluid should be mixed together. The spray nozzles may otherwise become blocked.

Do not use distilled or de-ionized water. Otherwise, the level sensor may give a false reading. When handling washer fluid, observe the important safety notes on service products (▷ page 377).

At temperatures above freezing:

- ▶ Fill the washer fluid reservoir with a mixture of water and windshield washer fluid, e.g. MB SummerFit.

Add 1 part MB SummerFit to 100 parts water.

At temperatures below freezing:

- ▶ Fill the washer fluid reservoir with a mixture of water and washer fluid, e.g. MB WinterFit.

For the correct mixing ratio refer to the information on the antifreeze reservoir.

- i** Add windshield washer fluid, e.g. MB SummerFit or MB WinterFit, to the washer fluid all year round.

## Climate control system refrigerant

### Important safety notes

The climate control system of your vehicle is filled with refrigerant R-134a.

The instruction label regarding the refrigerant type used can be found on the radiator cross member.

**!** Only the refrigerant R-134a and the PAG oil approved by Mercedes-Benz may be used. The approved PAG oil may not be mixed with any other PAG oil that is not approved for R-134a refrigerant. Otherwise, the climate control system may be damaged.

Service work, such as refilling with refrigerant or replacing component parts, may only be carried out by a qualified specialist workshop. All applicable regulations, as well as SAE standard J639, must be adhered to.

Always have work on the climate control system carried out at a qualified specialist workshop.

### Refrigerant instruction label



Example: refrigerant instruction label

- ① Warning symbol
- ② Refrigerant filling capacity
- ③ Applicable standards
- ④ PAG oil part number
- ⑤ Type of refrigerant

Warning symbol ① advises you about:

- Possible dangers
- Having service work carried out at a qualified specialist workshop

### Filling capacities

All models	
Refrigerant	22.2 ± 0.4 oz (630 ± 10 g)
PAG oil	2.8 oz (80 g)

## Vehicle data

### General notes

Please note that for the specified vehicle data:

- the heights specified may vary as a result of:
  - tires
  - load
  - condition of the suspension
  - optional equipment
- optional equipment reduces the maximum payload

Observe the information relating to level control:

- AIR BODY CONTROL (> page 185)

### Dimensions and weights



Model	① Height when opened	② Maximum headroom
Mercedes-AMG GLC 43 4MATIC	82.9 in (2106 mm)	75.6 in (1920 mm)
Mercedes-AMG GLC 63 4MATIC+	81.1 in (2060 mm)	75.4 in (1916 mm)
Mercedes-AMG GLC 63 S 4MATIC+	82.8 in (2104 mm)	75.6 in (1921 mm)
All other models	84.5 in (2146 mm)	78.4 in (1992 mm)

Missing values were not available at time of going to print.

Mercedes-AMG GLC 43 4MATIC	
Vehicle length	183.5 in (4661 mm)
Vehicle width including exterior mirrors	82.5 in (2096 mm)
Vehicle height	64.1 in (1627 mm)
Wheelbase	113.1 in (2873 mm)
Turning radius	39.7 ft (12.10 m)
Maximum roof load	165 lb (75 kg)

Mercedes-AMG GLC 63 4MATIC+	
Vehicle length	184.2 in (4679 mm)
Vehicle width including exterior mirrors	82.5 in (2096 mm)
Vehicle height	63.8 in (1620 mm)
Wheelbase	113.1 in (2873 mm)
Turning radius	39.7 ft (12.10 m)
Maximum roof load	165 lb (75 kg)

Mercedes-AMG GLC 63 S 4MATIC+	
Vehicle length	184.3 in (4682 mm)
Vehicle width including exterior mirrors	82.5 in (2096 mm)
Vehicle height	64.0 in (1625 mm)
Wheelbase	113.1 in (2873 mm)
Turning radius	39.7 ft (12.10 m)
Maximum roof load	165 lb (75 kg)

All other models	
Vehicle length	183.3 in (4656 mm)
Vehicle width including exterior mirrors	82.5 in (2096 mm)
Vehicle height	65.5 in (1664 mm)
Wheelbase	113.1 in (2873 mm)
Turning radius	38.7 ft (11.80 m)
Maximum roof load	165 lb (75 kg)

## Vehicle data for off-road driving

### Maximum water depth

! The water depth must not exceed the specified value. Note that the permissible water depth is less in flowing water.



Maximum water depth ① when the vehicle is ready to drive can be found in the following table.

When the vehicle is loaded and ready to drive, it has a full tank, all fluids have been refilled and the driver is in the vehicle.

Further information about driving on flooded roads (▷ page 165).

### Approach/departure angle



When the vehicle is loaded and ready to drive, it has a full tank, all fluids have been refilled and the driver is in the vehicle.

On vehicles with AIR BODY CONTROL loads up to the maximum permissible load have no influence on approach and departure angles.

### Maximum gradient-climbing capability

Note that the vehicle's gradient-climbing capability depends on the off-road conditions and the road surface conditions.

If the load on the front axle is reduced when pulling away on a steep uphill slope, the front wheels have a tendency to spin. Accelerate carefully and make sure that the wheels do not spin when driving on steep terrain.

### Trailer tow hitch

#### Trailer loads

**Permissible trailer load, braked (at a minimum gradient-climbing capability of 12% from a standstill)**

Model	
All models	3500 lb (1588 kg)

### Maximum drawbar noseweight

**!** Use a drawbar noseweight as close as possible to the maximum permissible noseweight. Do not use a noseweight of less than 50 kg, otherwise the trailer may come loose.

Note that the payload and the rear axle load are reduced by the actual payload.

The drawbar load reduces the permissible overall load and rear axle load.

The drawbar load acts from above onto the ball head on the trailer tow hitch.

The drawbar noseweight is not included in the trailer load.

Model	Permissible noseweight
All models	280 lbs (127 kg)

The actual noseweight may not be higher than the value which is given. The value can be found on the trailer tow hitch or trailer identification plates. The lowest weight applies.

The maximum permissible trailer drawbar noseweight is the maximum weight with which the trailer drawbar can be loaded. The permissible trailer drawbar noseweight is the limit for Mercedes-Benz-approved trailer couplings.

### Permissible rear axle load when towing a trailer

Missing values were not available at time of going to print.

Model	Permissible axle load
Mercedes-AMG GLC 43 4MATIC	2822 lbs (1280 kg)
Mercedes-AMG GLC 63 4MATIC+/ GLC 63 S 4MATIC+	2910 lbs (1320 kg)
All other models	

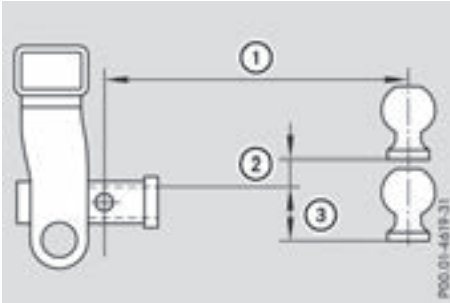

**Ball position of the ball coupling**

When the ball coupling is selected, the following dimensions must not be exceeded:

①	7.0 in
②	0.625 in
③	1.25 in





