



#### Digital – in the vehicle

Familiarize yourself with the contents of the Operator's Manual directly via the vehicle's multimedia system (menu item "Vehicle"). Start with the quick guide, discover your vehicle's highlights or broaden your knowledge with useful tips.



#### Vehicle document wallet

Here you can find comprehensive information about operating your vehicle and about services and guarantees in printed form.



2055844429

Order no. P205 2562 13 Part no. 205 584 44 29  
Edition A-2022

C-Class Coupe

Mercedes-Benz



## C-Class Coupe

Operator's Manual

Mercedes-Benz



## Front passenger airbag warning

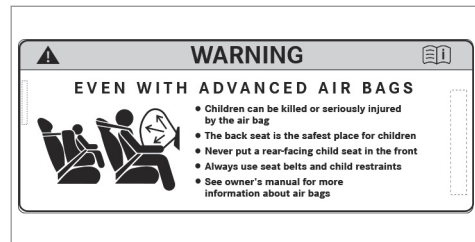

Airbag warning sticker for USA and Canada

**WARNING** Risk of injury or death if the co-driver airbag is enabled

If the co-driver airbag is enabled, a child on the co-driver seat may be struck by the co-driver airbag during an accident.

NEVER use a rearward-facing child restraint system on a seat with an ENABLED FRONT AIRBAG; DEATH or SERIOUS INJURY to the CHILD can occur.

Observe the chapter "Children in the vehicle".

## Publication details

### Internet

Further information about Mercedes-Benz vehicles and about Mercedes-Benz AG can be found on the following websites:

<https://www.mbusa.com> (USA only)

<https://www.mercedes-benz.ca> (Canada only)

### Documentation team

©Mercedes-Benz AG: Not to be reprinted, translated or otherwise reproduced, in whole or in part, without written permission from Mercedes-Benz AG.

### Vehicle manufacturer

Mercedes-Benz AG

Mercedesstraße 120

70372 Stuttgart

Germany

## Thank you for purchasing a Mercedes-Benz

Before you first drive off, read this Operator's Manual carefully and familiarize yourself with your vehicle. For your own safety and a longer operating lifespan of the vehicle, follow the instructions and warning notices in this Operator's Manual. Disregarding them may lead to damage to the vehicle or injury to people.

Damage to the vehicle resulting from the disregard of the instructions is not covered by the Mercedes-Benz Limited Warranty.

The standard equipment and product description of your vehicle may vary and depends on the following factors:

- Model
- Order
- National version
- Availability

Mercedes-Benz reserves the right to introduce changes in the following areas:

- Design
- Equipment

- Technical features

The equipment in your vehicle may therefore differ from that shown in the descriptions and illustrations.

The following documents are integral parts of the vehicle:

- Digital Operator's Manual
- Printed Operator's Manual
- Maintenance Booklet
- Equipment-dependent Supplements

Keep these documents in the vehicle at all times. If you sell the vehicle, always pass all of the documents on to the new owner.

Mercedes-Benz USA, LLC  
Mercedes-Benz Canada, Inc.  
A Daimler Company

2055844429



<b>Symbols</b> .....	5	Qualified specialist workshop .....	27	Side windows .....	76
<b>At a glance</b> .....	6	Correct use of the vehicle .....	27	Sliding sunroof .....	79
Cockpit .....	6	Notes for persons with electronic medi- cal aids .....	27	Anti-theft protection .....	83
Indicator and warning lamps (standard) .....	10	Problems with your vehicle .....	28	<b>Seats and stowing</b> .....	<b>86</b>
Indicator and warning lamps (Wide- screen Cockpit) .....	12	Reporting safety defects .....	28	Notes on the correct driver's seat posi- tion .....	86
Overhead control panel .....	14	Limited Warranty .....	29	Seats .....	87
Door operating unit and seat adjustment .....	16	QR code for rescue card .....	29	Steering wheel .....	95
Emergencies and breakdowns .....	18	Data storage .....	29	Easy entry and exit feature .....	97
<b>Digital Operator's Manual</b> .....	<b>20</b>	Copyright .....	34	Memory function .....	98
Calling up the Digital Operator's Manual .....	20	<b>Occupant safety</b> .....	<b>35</b>	Stowage areas .....	100
<b>General notes</b> .....	<b>21</b>	Restraint system .....	35	Sockets .....	108
Protecting the environment .....	21	Seat belts .....	37	Wireless charging of the mobile phone and connection with the exterior antenna ..	109
Genuine Mercedes-Benz parts .....	21	Airbags .....	42	Installing/removing the floor mats .....	110
Operator's Manual .....	22	PRE-SAFE® system .....	49	<b>Light and visibility</b> .....	<b>112</b>
Service and vehicle operation .....	23	Safely transporting children in the vehi- cle .....	50	Exterior lighting .....	112
Operating safety .....	24	Notes on pets in the vehicle .....	62	Interior lighting .....	117
Declaration of conformity for wireless vehicle components .....	25	<b>Opening and closing</b> .....	<b>63</b>	Windshield wiper and windshield washer system .....	118
Diagnostics connection .....	26	SmartKey .....	63	Mirrors .....	121
		Doors .....	67		
		Trunk .....	70		

<b>Climate control</b> .....	<b>124</b>	Head-up Display .....	208	Cleaning and care .....	329
Overview of climate control systems .....	124				
Operating the climate control system .....	124				
<b>Driving and parking</b> .....	<b>128</b>	<b>Voice Control System</b> .....	<b>211</b>	<b>Breakdown assistance</b> .....	<b>336</b>
Driving .....	128	Notes on operating safety .....	211	Emergency .....	336
DYNAMIC SELECT switch .....	139	Operation .....	211	Flat tire .....	337
Automatic transmission .....	141	Using the Voice Control System effec- tively .....	213	Battery (vehicle) .....	344
Function of the 4MATIC .....	145	Essential voice commands .....	213	Tow starting or towing away .....	349
Refueling .....	145			Electrical fuses .....	354
Parking .....	147	<b>Multimedia system</b> .....	<b>226</b>	<b>Wheels and tires</b> .....	<b>358</b>
Driving and driving safety systems .....	155	Overview and operation .....	226	Notes on noise or unusual handling char- acteristics .....	358
Vehicle towing instructions .....	204	System settings .....	235	Notes on regularly inspecting wheels and tires .....	358
		Fit & Healthy .....	247	Notes on snow chains .....	359
		Navigation .....	248	Tire pressure .....	359
		Telephone .....	273	Loading the vehicle .....	366
		Online and Internet functions .....	296	Tire labeling .....	370
<b>Instrument Display and on-board computer</b> .....	<b>205</b>	Media .....	300	Definition of terms for tires and loading .....	375
Notes on the instrument display and on- board computer .....	205	Radio .....	312	Changing a wheel .....	378
Instrument display overview .....	206	Sound .....	319	Emergency spare wheel .....	387
Overview of buttons on the steering wheel .....	207				
Operating the on-board computer .....	207	<b>Maintenance and care</b> .....	<b>322</b>		
Overview of displays on the multifunc- tion display .....	208	ASSYST PLUS service interval display .....	322		
		Engine compartment .....	323		

## 4 Contents

---

<b>Technical data</b> .....	<b>389</b>
Notes on technical data .....	389
Vehicle electronics .....	389
Regulatory radio identification of small components .....	390
Vehicle identification plate, VIN and engine number overview .....	391
Operating fluids .....	392
Vehicle data .....	399
<hr/>	
<b>Display messages and warning/indi- cator lamps</b> .....	<b>401</b>
Display messages .....	401
Warning and indicator lamps .....	448
<hr/>	
<b>Index</b> .....	<b>463</b>

In this Operator's Manual, you will find the following symbols:

**⚠ DANGER** Danger due to not observing the warning notices

Warning notices draw your attention to hazards that may endanger your health or life, or the health or life of others.

▶ Observe the warning notices.

**🌿 ENVIRONMENTAL NOTE** Environmental damage due to failure to observe environmental notes

Environmental notes include information on environmentally responsible behavior or environmentally responsible disposal.

▶ Observe environmental notes.

**! NOTE** Damage to property due to failure to observe notes on material damage

Notes on material damage inform you of risks which may lead to your vehicle being damaged.

▶ Observe notes on material damage.

**i** These symbols indicate useful instructions or further information that could be helpful to you.

▶ Instruction

(→ page) Further information on a topic

Display Information on the multifunction display/media display

↗▶ Highest menu level, which is to be selected in the multimedia system

▶▶ Relevant submenus, which are to be selected in the multimedia system

\* Indicates a cause

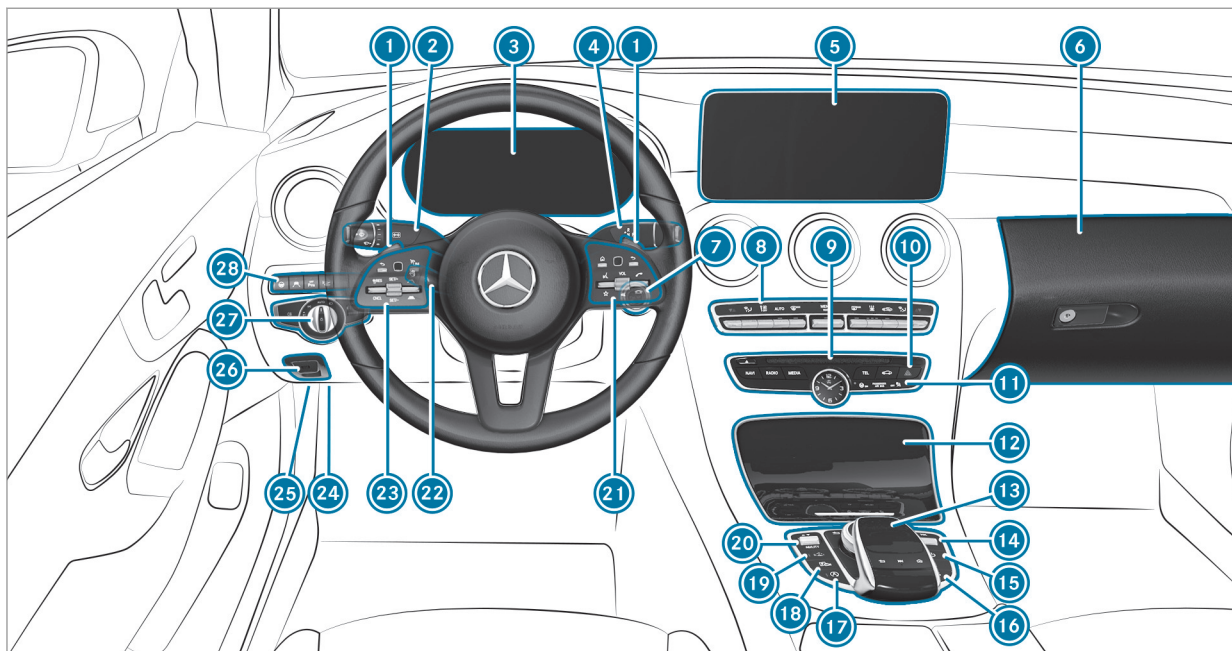

Left-hand-drive vehicles



①	Steering wheel gearshift paddles	→	143	⑩	Hazard warning light system	→	114
②	Combination switch	→	113	⑪	PASSENGER AIR BAG indicator lamps	→	47
③	Instrument display	→	206	⑫	Storage compartment	→	102
④	DIRECT SELECT lever	→	141	⑬	Touchpad	→	227
⑤	Media display	→	226	⑭	Controller for volume and switching sound on/off	→	226
⑥	Glove box	→	102	⑮	Switches the multimedia system on/off	→	226
⑦	Start/stop button	→	129	⑯	Extends/retracts the seat belt extender	→	40
⑧	Climate control systems	→	124	⑰	ECO start/stop function	→	138
⑨	Calls up the main functions of the multimedia system	→	230	⑱	Active Parking Assist	→	200
				⑲	Sets the vehicle level	→	188
				⑳	DYNAMIC SELECT switch	→	140
				㉑	Control panel for the multimedia system	→	207
				㉒	Adjusts the steering wheel electrically	→	96
					Switches the steering wheel heater on/off	→	97
				㉓	Control panel:		
					On-board computer	→	207
					Cruise control	→	163
					Active Distance Assist DISTRONIC	→	167
				㉔	Diagnostics connection	→	26
				㉕	Opens the hood	→	323
				㉖	Electric parking brake	→	151
				㉗	Light switch	→	112
				㉘	Control panel for:		

## 8 At a glance – Cockpit

---

Active Steering Assist → 173

Active Lane Keeping Assist → 186

Parking Assist PARKTRONIC → 198







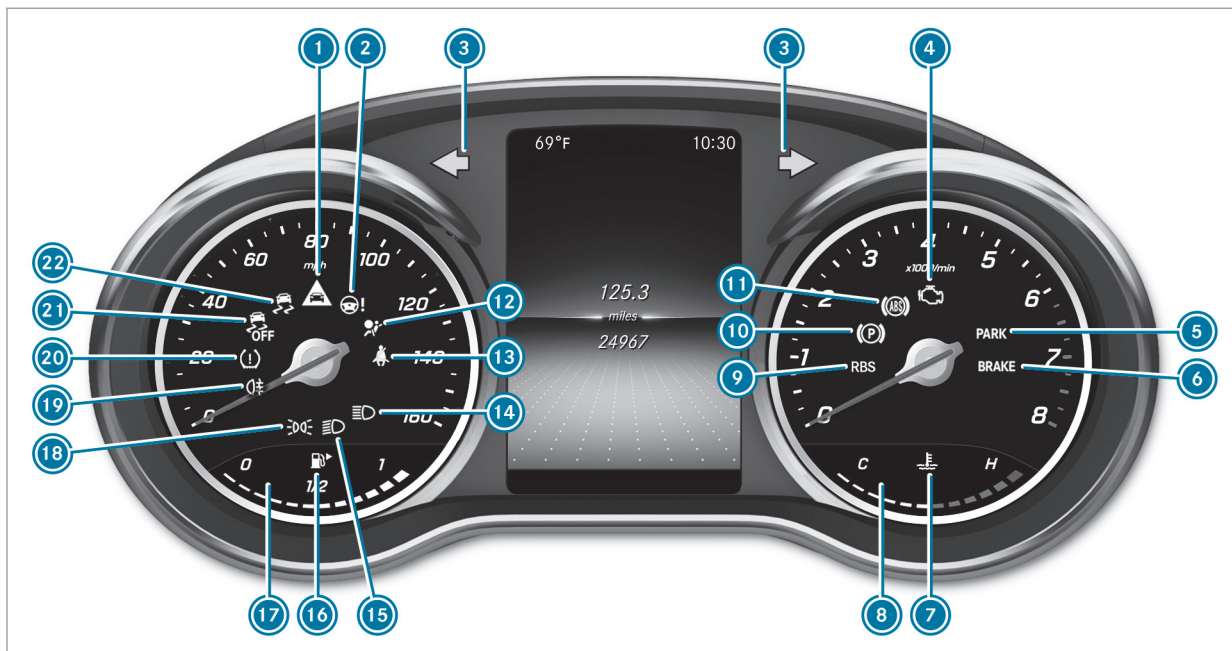















Head-up Display → 210



10 At a glance – Indicator and warning lamps (standard)









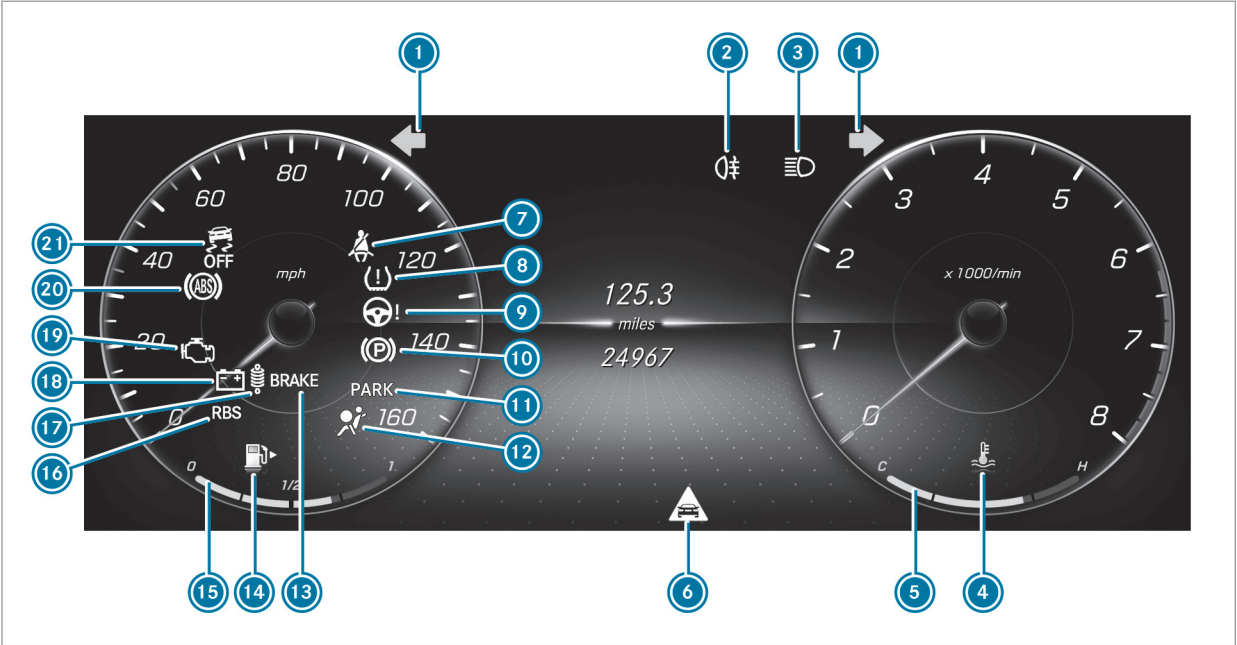





















Instrument Display (standard)

①		Distance warning	→	458	⑩		Electric parking brake (yellow)	→	455
②		Power steering	→	451	⑪		ABS	→	459
③		Turn signal lights	→	113	⑫		Restraint system	→	450
④		Check Engine	→	452	⑬		Seat belt	→	450
⑤		Electric parking brake (red)	→	455	⑭		High beam	→	113
		USA only			⑮		Low beam	→	112
		Canada only			⑯		Reserve fuel with fuel filler flap location indicator	→	452
⑥		Brakes (red)	→	455	⑰		Fuel level	→	206
		USA only			⑱		Parking lamps	→	112
		Canada only			⑲		Rear fog lamp	→	113
⑦		Coolant temperature	→	452	⑳		Tire pressure monitoring system	→	461
⑧		Coolant temperature display	→	206	㉑		ESP® OFF	→	459
⑨		Recuperative Brake System, USA only	→	455	㉒		ESP®	→	459
		Brakes (yellow), Canada only	→	455					

12 At a glance – Indicator and warning lamps (Widescreen Cockpit)









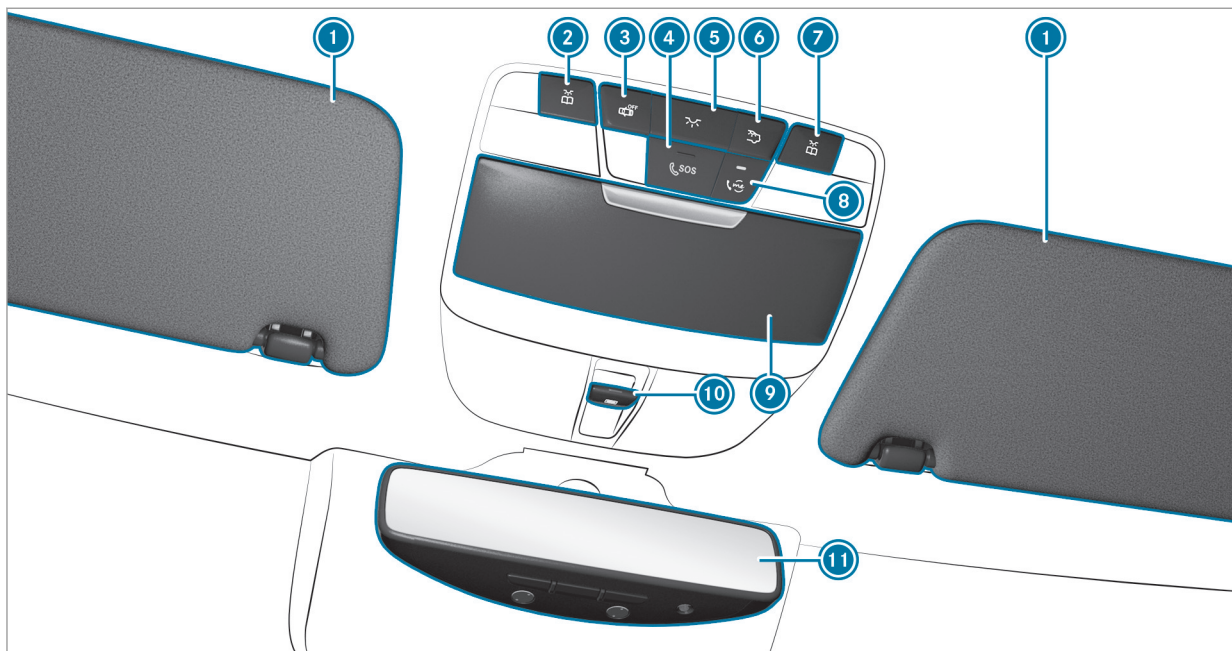

Widescreen Cockpit Instrument Display

1		Turn signal lights	→	113	12		Restraint system	→	450
2		Rear fog lamp	→	113	13		Brakes (red)	→	455
3		High beam	→	113		USA only			
		Low beam	→	112		Canada only			
		Parking lamps	→	112	14		Reserve fuel with fuel filler flap location indicator	→	452
4		Coolant temperature	→	452	15		Fuel level	→	206
5		Coolant temperature display	→	206	16		Recuperative Brake System, USA only	→	455
6		Distance warning	→	458		Brakes (yellow), Canada only	→	455	
7		Seat belt	→	450	17		Suspension	→	458
8		Tire pressure monitoring system	→	461	18		Electrical malfunction	→	452
9		Power steering	→	451	19		Check Engine	→	452
10		Electric parking brake (yellow)	→	455	20		ABS	→	459
11		Electric parking brake (red)	→	455	21		ESP® OFF	→	459
		USA only				ESP®	→	459	
		Canada only							

14 At a glance – Overhead control panel





①	Sun visors		
②	 Switches the left-hand reading lamp on/off	→	117
③	 Switches automatic interior lighting control on/off	→	117
④	 SOS button	→	289
⑤	 Switches the front interior lighting on/off	→	117
⑥	 Switches the rear interior lighting on/off	→	117
⑦	 Switches the right-hand reading lamp on/off	→	117
⑧	 me button	→	289
⑨	Eyeglasses compartment		
⑩	 Opens/closes the panorama roof with power tilt/sliding panel	→	79
	 Opens/closes the roller sunblind	→	79
⑪	Inside rearview mirror	→	122

16 At a glance – Door operating unit and seat adjustment

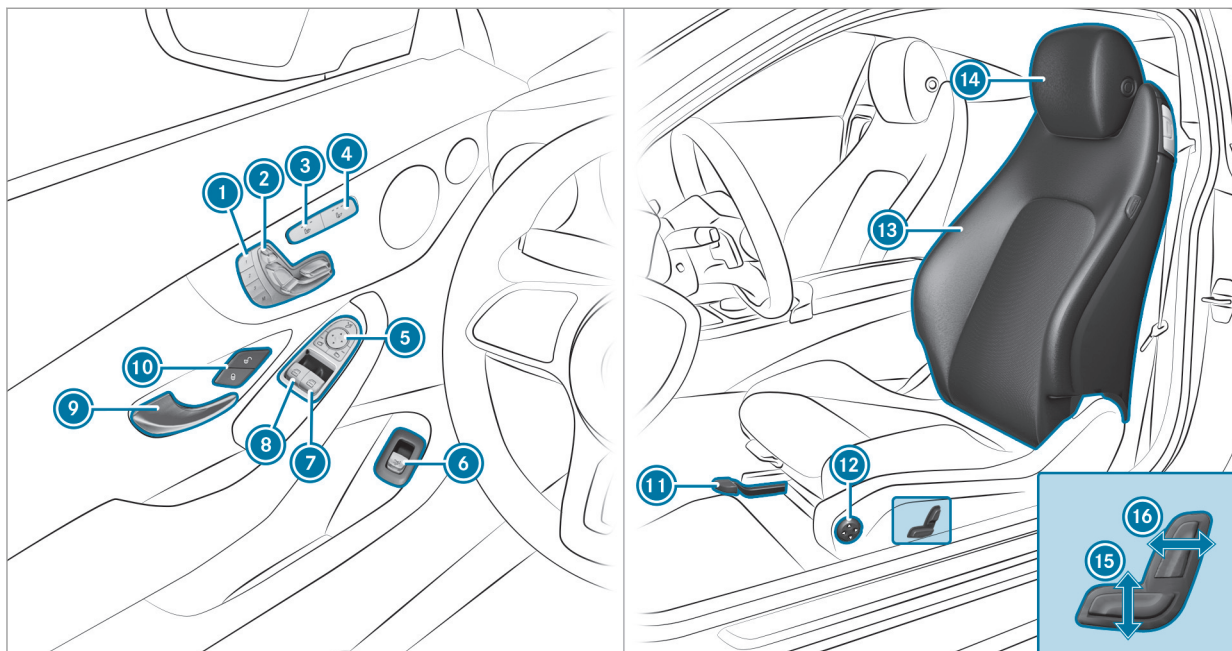

① Operates the memory function	→	99
② Adjusts the seats electrically	→	89
③ Switches the seat heating on/off	→	94
④ Switches the seat ventilation on/off	→	95
⑤ Operates the outside mirrors	→	121
⑥ Opens/closes the trunk lid	→	70
⑦ Opens/closes the right side window	→	76
⑧ Opens/closes the left side window	→	76

⑨ Opens the door	→	67
⑩ Locks/unlocks the vehicle	→	67
⑪ Adjusts the seat fore-and-aft position	→	87
⑫ Adjusts the 4-way lumbar support	→	90
⑬ Seat adjustment using the multimedia system	→	92
⑭ Adjusts the head restraints	→	89
⑮ Adjusts the seat height	→	87
⑯ Adjusts the seat backrest inclination	→	87

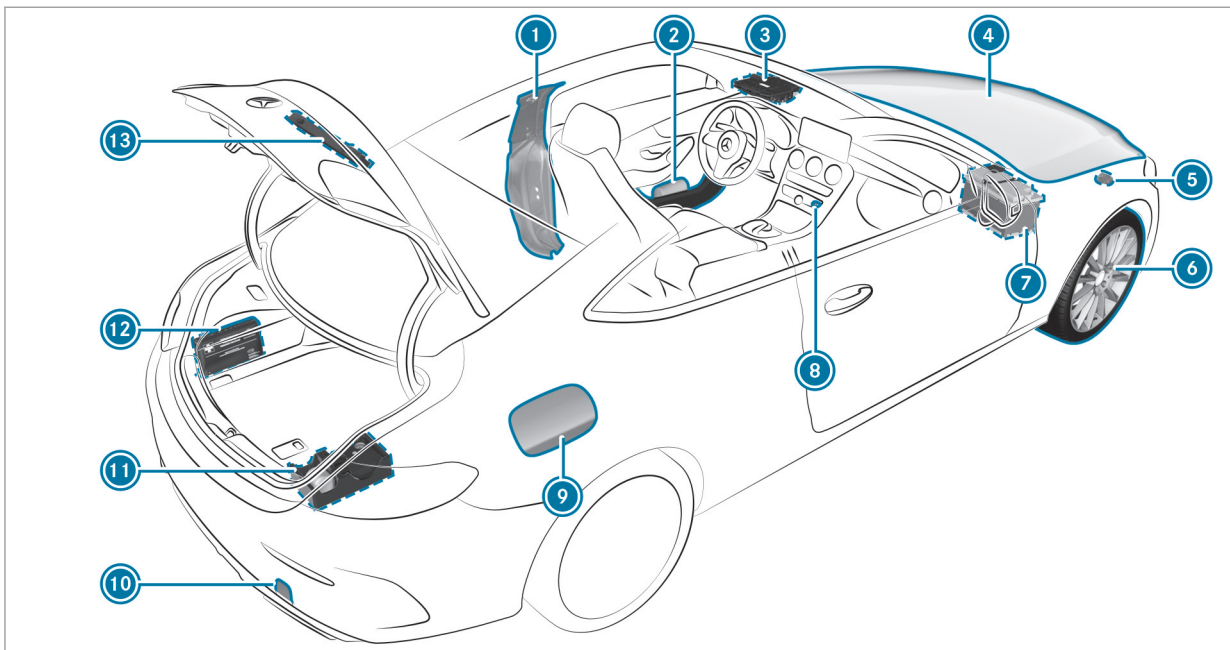

① B-pillar with:		
QR code for accessing the rescue card	→	29
② Safety vests	→	336
③ me button and SOS button	→	289
④ To check and refill operating fluids	→	392
⑤ To tow-start and tow away	→	349
⑥ Flat tire	→	337
⑦ Starting assistance	→	347
⑧ Hazard warning light system	→	114

⑨ Fuel filler flap with:		
information label on fuel type	→	145
Information label on tire pressure	→	361
QR code for accessing the rescue card	→	29
⑩ To tow-start and tow away	→	349
⑪ TIREFIT kit	→	339
⑫ First-aid kit (soft sided)	→	337
⑬ Warning triangle	→	336

### Calling up the Digital Operator's Manual

Multimedia system:

→ Vehicle → ⓘ Operator's Manual

▶ Select a menu item.

In addition, you can also call up the Operator's Manual within a main function (e.g. via [Media Info](#)).

The Digital Operator's Manual describes the function and operation of the vehicle and the multimedia system.

For safety reasons, the Digital Operator's Manual is deactivated while driving.



The Digital Operator's Manual contains the following menu items:

- **Search:** allows you to search precisely for keywords.
- **Quick start:** provides you with important information so that you can start using your vehicle immediately.
- **Tips:** provides tips on how to use your vehicle in certain situations.
- **Messages:** provides you with further information about the messages in the instrument cluster.
- **Bookmarks:** provides you with a list of all the bookmarks you have stored yourself.

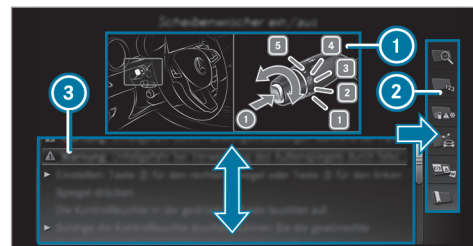

- 1 Picture
- 2 Menu
- 3 Navigation window

Some sections of the Digital Operator's Manual, such as warnings, can be made visible by highlighting and pressing them.

## Protecting the environment

 **ENVIRONMENTAL NOTE** Environmental damage due to operating conditions and personal driving style

The pollutant emission of the vehicle is directly related to the way you operate the vehicle.

Operate your vehicle in an environmentally responsible manner to help protect the environment. Please observe the following recommendations on operating conditions and personal driving style.

### Operating conditions:

- ▶ Make sure that the tire pressure is correct.
- ▶ Do not carry any unnecessary weight (e.g. roof luggage racks once you no longer need them).
- ▶ Adhere to the service intervals. A regularly serviced vehicle will contribute to environmental protection.

- ▶ Always have maintenance work carried out at a qualified specialist workshop.

### Personal driving style:

- ▶ Do not depress the accelerator pedal when starting the engine.
- ▶ Do not warm up the engine while the vehicle is stationary.
- ▶ Drive carefully and maintain a suitable distance from the vehicle in front.
- ▶ Avoid frequent, sudden acceleration and braking.
- ▶ Change gear in good time and use each gear only up to  $\frac{2}{3}$  of its maximum engine speed.
- ▶ Switch off the engine in stationary traffic, e.g. by using the ECO start/stop function.
- ▶ Drive fuel-efficiently. Observe the ECO display for a fuel-efficient driving style.

## Environmental issues and recommendations

It is recommended that you re-use or recycle materials instead of just disposing of them.

The relevant environmental guidelines and regulations serve to protect the environment and must be strictly observed.

## Genuine Mercedes-Benz parts

 **ENVIRONMENTAL NOTE** Environmental damage due to not using recycled reconditioned components

Mercedes-Benz AG offers recycled reconditioned components and parts with the same quality as new parts. The same entitlement from the Limited Warranty is valid as for new parts.

- ▶ Use recycled reconditioned components and parts from Mercedes-Benz AG.

**!** **NOTE** Impairment of the operating efficiency of the restraint systems from installing accessory parts or from repairs or welding

Airbags and Emergency Tensioning Devices, as well as control units and sensors for the restraint systems, may be installed in the following areas of your vehicle:

- Doors
- Door pillars
- Door sills
- Seats
- Cockpit
- Instrument cluster
- Center console
- Lateral roof frame

- ▶ Do not install accessory parts such as audio systems in these areas.
- ▶ Do not carry out repairs or welding.

▶ Have aftermarket installation of accessories carried out at a qualified specialist workshop.

You could jeopardize the operating safety of your vehicle if you use parts, tires and wheels as well as accessories relevant to safety which have not been approved by Mercedes-Benz. Safety-relevant systems, e.g. the brake system, may malfunction. Only use Mercedes-Benz GenuineParts or parts of equal quality. Only use tires, wheels and accessories that have been specifically approved for your vehicle model.

Mercedes-Benz GenuineParts are subject to strict quality inspections. Each part has been specially developed, manufactured or selected for Mercedes-Benz vehicles and adapted to them. Therefore, only Mercedes-Benz GenuineParts should be used.

More than 300,000 different Mercedes-Benz GenuineParts are available for Mercedes-Benz models.

All authorized Mercedes-Benz Centers maintain a supply of Mercedes-Benz GenuineParts for

necessary service and repair work. In addition, strategically located parts delivery centers provide for quick and reliable parts service.

Always specify the vehicle identification number (VIN) (→ page 391) when ordering Mercedes-Benz GenuineParts.

### Operator's Manual

This Operator's Manual describes all models and all standard and optional equipment available for your vehicle at the time of this Operator's Manual going to press. Country-specific differences are possible. Note that your vehicle may not be equipped with all features described. This is also the case for systems and functions relevant to safety. Therefore, the equipment on your vehicle may differ from that in the descriptions and illustrations.

The original purchase agreement for your vehicle contains a list of all of the systems in your vehicle.

Should you have any questions concerning equipment and operation, please consult an authorized Mercedes-Benz Center.



The Operator's Manual and Maintenance Booklet are important documents and should be kept in the vehicle.

### Service and vehicle operation

#### Vehicle operation outside the USA or Canada

When you are abroad with your vehicle, observe the following points:

- Service points or replacement parts may not be available immediately.
- Unleaded fuel may not be available for vehicles with a catalytic converter. Leaded fuel may cause damage to the catalytic converter.
- The fuel may have an extremely low octane number. Unsuitable fuel can cause engine damage.

Some Mercedes-Benz models are available in Europe through our European Delivery Program. For more information, please consult an authorized Mercedes-Benz service center, or write to one of the following address:

#### **In the USA:**

Mercedes-Benz USA, LLC  
European Delivery Department  
One Mercedes-Benz Drive  
Sandy Springs, GA 30328

#### **In Canada:**

Mercedes-Benz Canada, Inc.  
European Delivery Department  
98 Vanderhoof Avenue  
Toronto, Ontario M4G 4C9

#### Maintenance

Your customer advisor confirms the service in the service report.

#### Roadside Assistance

The Mercedes-Benz Roadside Assistance Program offers technical help in the case of a breakdown. Your calls to the toll-free Roadside Assistance Hotline are answered by our agents 24 hours a day, 365 days a year.

1-800-FOR-MERCEdes (1-800-367-6372) (USA)

1-800-387-0100 (Canada)

You can find further information in the Mercedes-Benz Roadside Assistance Program brochure (USA) or the "Roadside Assistance" section in the Service and Warranty booklet (Canada). You will find both in the vehicle document wallet.

#### Change of address or change of ownership

In the event of a change of address, please send us the "Notification of address change" in the Service and Guarantee booklet or simply call the Mercedes-Benz Customer Assistance Center (USA) on the hotline number 1-800-FOR-MERCEdes (1-800-367-6372) or Customer Service (Canada) on 1-800-387-0100. We can then reach you in a timely fashion, if necessary.

If you sell your Mercedes, please leave all literature in the vehicle so that it is available to the next owner. If you have purchased a used vehicle, please send us the "Notice of Purchase of Used Car" in the Service and Guarantee booklet or simply call the Mercedes-Benz Customer

Assistance Center (USA) at the hotline number 1-800-FOR-MERcedes (1-800-367-6372) or Customer Service (Canada) at 1-800-387-0100.

### Possible danger due to substances hazardous to health

In compliance with Proposition 65 ("Prop65"), the following detachable label has been added to each vehicle sold in California:

	<b>WARNING</b>	
<p>Operating, servicing and maintaining a passenger vehicle, pickup truck, van or off-road motor vehicle can expose you to chemicals including engine exhaust, carbon monoxide, phthalates, and lead, which are known to the State of California to cause cancer and birth defects or other reproductive harm. To minimize exposure, avoid breathing exhaust, do not idle the engine except as necessary, service your vehicle in a well-ventilated area and wear gloves or wash your hands frequently when servicing your vehicle. For more information go to <a href="http://www.P65Warnings.ca.gov/passenger-vehicle">www.P65Warnings.ca.gov/passenger-vehicle</a></p> <p style="text-align: center;"><small>A 000 817 82 02</small></p>		

### Operating safety

**⚠ WARNING** Risk of accident due to malfunctions or system failures

To avoid malfunctions or system failures:

- ▶ Always have the prescribed service and maintenance work as well any required repairs carried out at a qualified specialist workshop.

**⚠ WARNING** Risk of accident or injury due to incorrect modifications on electronic component parts

Modification of electronic components, their software or wiring could impair their function and/or the function of other networked component parts or safety-relevant systems.

This can endanger the operating safety of the vehicle.

- ▶ Never tamper with the wiring and electronic component parts or their software.

- ▶ You should have all work on electrical and electronic components carried out at a qualified specialist workshop.

Observe the "On-board electronics" section in "Technical data".

**⚠ WARNING** Risk of fire due to flammable materials on hot parts of the exhaust system

Flammable material such as leaves, grass or twigs may ignite if they come into contact with hot parts of the exhaust system.

- ▶ When driving on unpaved roads or off-road, regularly check the vehicle underside.
- ▶ Remove trapped plants or other flammable material, in particular.
- ▶ If there is damage, consult a qualified specialist workshop immediately.

**!** **NOTE** Damage to the vehicle due to driving too fast and due to impacts to the vehicle underbody or suspension components

In the following situations, in particular, there is a risk of damage to the vehicle:

- The vehicle becomes grounded, e.g. on a high curb or an unpaved road
- The vehicle is driven too fast over an obstacle, e.g. a curb, speed bump or pothole
- A heavy object strikes the underbody or suspension components

In situations such as these, damage to the body, underbody, suspension components, wheels or tires may not be visible. Components damaged in this way can unexpectedly fail or, in the case of an accident, may no longer absorb the resulting force as intended.

If the underbody paneling is damaged, flammable materials such as leaves, grass or twigs can collect between the underbody and

the underbody paneling. These materials may ignite if they come into contact with hot parts of the exhaust system.

▶ Have the vehicle checked and repaired immediately at a qualified specialist workshop.

or

▶ If driving safety is impaired while continuing your journey, pull over and stop the vehicle immediately, while paying attention to road and traffic conditions, and contact a qualified specialist workshop.

#### Declaration of conformity for wireless vehicle components

**USA:** "Radio based devices of this vehicle comply with Part 15 of the FCC Rules. Operation is subject to the following two conditions: 1) These devices may not cause harmful interference, and 2) These devices must accept any interference received, including interference that may cause undesired operation. Changes or modifications

not expressly approved by the party responsible for compliance could void the user's authority to operate the equipment."

**Canada:** "This vehicle contains license-exempt transmitter(s)/receiver(s) that comply with Innovation, Science and Economic Development Canada's RSS(s). Operation is subject to the following two conditions: (1) These devices may not cause interference, and (2) These devices must accept any interference, including interference that may cause undesired operation of the device."

**USA:** "Wireless charging system for mobile devices (model: WMI2 Wireless Mobile Interface): this device complies with Part 18 of the FCC Rules."

The name and address of the party responsible is:

peiker acustic GmbH  
Max-Planck-Str. 28-32  
61381 Friedrichsdorf  
Germany

### Diagnostics connection

The diagnostics connection is a technical interface in the vehicle. It is used, for example, within the scope of repair and maintenance work or for reading out vehicle data by a specialist workshop. Diagnostic devices should therefore only be connected by a qualified specialist workshop.

**⚠ WARNING** Risk of accident due to connecting devices to the diagnostics connection

If you connect devices to the diagnostics connection of the vehicle, the function of vehicle systems and operating safety may be impaired.

- ▶ For safety reasons, we recommend that you only use and connect products approved by your authorized Mercedes-Benz Center.

**⚠ WARNING** Risk of accident due to objects in the driver's footwell

Objects in the driver's footwell may impede pedal travel or block a depressed pedal.

This jeopardizes the operating and road safety of the vehicle.

- ▶ Stow all objects in the vehicle securely so that they cannot get into the driver's footwell.
- ▶ Always install the floor mats securely and as prescribed in order to ensure that there is always sufficient room for the pedals.
- ▶ Do not use loose floor mats and do not place floor mats on top of one another.

**! NOTE** Battery discharging from using devices connected to the diagnostics connection

Using devices at the diagnostics connection drains the battery.

- ▶ Check the charge level of the battery.

- ▶ If the charge level is low, charge the battery, e.g. by driving a considerable distance.

Please also note the information about the 12 V battery and short-distance trips in the "Driving and Parking" chapter (→ page 133).

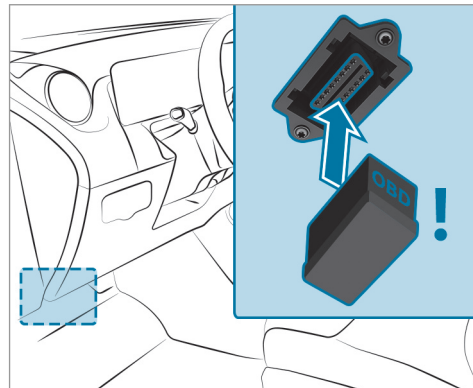

Connecting and using another device with the diagnostics connection can have the following effects:

- Malfunctions in the vehicle system
- Permanent damage to vehicle components

Please refer to the warranty terms and conditions for this matter.

Moreover, connecting equipment to the diagnostics connection can lead to emissions monitoring information being reset, for example. This may lead to the vehicle failing to meet the requirements of the next emissions inspection during the main inspection.

### Qualified specialist workshop

An authorized Mercedes-Benz Center is a qualified specialist workshop. It has the necessary special skills, tools and qualifications to correctly carry out the work required on your vehicle. This particularly applies to safety-relevant works.

For the following, always have your vehicle checked at an authorized Mercedes-Benz Center:

- safety-relevant works
- service and maintenance work
- repair work
- modifications as well as installations and conversions
- work on electronic components

Mercedes-Benz recommends a Mercedes-Benz service center.

### Correct use of the vehicle

If you remove any warning stickers, you or others could fail to recognize certain dangers. Leave warning stickers in position.

Observe the following information in particular when driving your vehicle:

- the safety notes in this manual
- technical data for the vehicle
- traffic rules and regulations

- laws and safety standards pertaining to motor vehicles

### Notes for persons with electronic medical aids

Mercedes-Benz AG cannot, despite carefully developing vehicle systems, completely rule out the interaction of vehicle systems with electronic medical aids such as cardiac pacemakers.

In addition, there are components installed in the vehicle that, regardless of the operating status of the vehicle, can generate magnetic fields on a par with permanent magnets. These fields can be found, for example, in the area around the multimedia and sound system or also in the area of the seats, depending on the vehicle equipment.

For this reason, the following can occur in isolated cases, depending on the aids used:

- Medical aids malfunctioning
- Adverse health effects

Observe the notes and warnings of the manufacturer of the medical aids; if in doubt, contact the

device manufacturer and/or your doctor. If there is continuing uncertainty concerning the possibility of medical aids malfunctioning, Mercedes-Benz AG recommends using only few electrical vehicle systems and/or maintaining a distance from the components.

Only have repairs and maintenance work in the area of the following components carried out by a qualified specialist workshop:

- Vehicle components carrying live voltage
- Transmission antenna
- Multimedia system and sound system

If you have any queries or suggestions, consult a qualified specialist workshop.

### Problems with your vehicle

If you should experience a problem with your vehicle, particularly one that you believe may affect its safe operation, we urge you to contact an authorized Mercedes-Benz Center immediately to have the problem diagnosed and rectified. If the problem is not resolved to your satisfaction, please discuss the problem again with

an authorized Mercedes-Benz Center or, if necessary, contact us at one of the following addresses:

#### In the USA:

Mercedes-Benz USA, LLC  
Customer Assistance Center  
One Mercedes-Benz Drive  
Sandy Springs, GA 30328

#### In Canada:

Mercedes-Benz Canada, Inc.  
Customer Relations Department  
98 Vanderhoof Avenue  
Toronto, Ontario M4G 4C9

### Reporting safety defects

#### USA only:

The following text is published as required of manufacturers under Title 49, Code of U.S. Federal Regulations, Part 575 pursuant to the "National Traffic and Motor Vehicle Safety Act of 1966".

If you believe that your vehicle has a defect which could cause a crash or could cause injury or death, you should immediately inform the National Highway Traffic Safety Administration (NHTSA) in addition to notifying Mercedes-Benz USA, LLC.

If NHTSA receives similar complaints, it may open an investigation, and if it finds that a safety defect exists in a group of vehicles, it may order a recall and remedy campaign. However, NHTSA cannot become involved in individual problems between you, your dealer, or Mercedes-Benz USA, LLC.

To contact NHTSA, you may call the Vehicle Safety Hotline toll-free at 1-888-327-4236 (TTY: 1-800-424-9153); go to the <https://www.safercar.gov/>; or write to: Administrator, NHTSA, 400 Seventh Street, SW., Washington, DC 20590.; USA.

You can also obtain other information about motor vehicle safety from: <https://www.safercar.gov>

**Canada only:**

The following text is published as required of manufacturers under subsection 18.4 (4) of the Motor Vehicle Safety Regulations.

If you believe that your vehicle has a defect which could cause a crash or could cause injury or death, you should immediately inform Transport Canada in addition to notifying Mercedes-Benz Canada Inc.

If Transport Canada received similar complaints, it may open an investigation, and if it finds that a safety defect exists in a group of vehicles, it may order a recall and remedy campaign. However, Transport Canada cannot become involved in individual problems between you, your dealer or Mercedes-Benz Canada Inc.

To contact Transport Canada, you may call the Defect Investigations and Recalls Division toll-free in Canada at 1-800-333-0510 or 819-994-3328 in the Gatineau-Ottawa area or internationally; you may also go to the following websites for more information:

- English: <https://www.tc.gc.ca/recalls>
- French: <https://www.tc.gc.ca/rappels>

**Limited Warranty**

**!** **NOTE** Damage to the vehicle arising from violation of these operating instructions.

Damage to the vehicle can arise from violation of these operating instructions.

This damage is not covered either by the Mercedes-Benz implied warranty or by the New- or Used-Vehicle Warranty.

- ▶ Follow the instructions in these operating instructions on proper operation of your vehicle as well as on possible vehicle damage.

**QR code for rescue card**

QR codes are attached in the fuel filler flap and on the opposite side on the B-pillar. In the event of an accident, rescue services can use the QR code to quickly find the appropriate rescue card for your vehicle. The current rescue card contains the most important information about your

vehicle in a compact form, e.g. the routing of the electric lines.

Further information can be obtained at <https://www.mercedes-benz.de/qr-code>.

**Data storage****Data processing in the vehicle****Electronic control units**

Electronic control units are installed in your vehicle. Control units process data which, for example, they receive from vehicle sensors, generate themselves or exchange between themselves. Some control units are required for the safe operation of your vehicle, some assist you when driving, such as driver assistance systems, while others enable convenience or infotainment functions.

The following provides you with general information regarding data processing in the vehicle. Additional information regarding exactly which data in your vehicle are collected, saved and transmitted to third parties, and for what purpose, can be found in the information directly

related to the functional characteristics in question in their respective operating instructions. This information is also available online and, depending on the vehicle equipment, digitally.

#### **Personal data**

Every vehicle is identified by a unique vehicle identification number. Depending on the country, this vehicle identification number can be used by, for example, governmental authorities to determine the identity of the owner. There are other possibilities to use data collected from the vehicle to identify the owner or driver, such as the license plate number.

Therefore, data generated or processed by control units may be attributable to a person or, under certain conditions, become attributable to a person. Depending on which vehicle data are available, it may be possible to make inferences about, for example, your driving behavior, your location, your route or your use patterns.

#### **Legal requirements regarding the disclosure of data**

If legally required to do so, manufacturers are, in individual cases, legally obliged to provide gov-

ernmental entities, upon request and to the extent required, data stored by the manufacturer. For example, this may be the case during the investigation of a criminal offense.

Governmental entities are themselves, in individual cases and within the applicable legal framework, authorized to read out data from the vehicle. In the case of an accident, information that can help with an investigation can, therefore, be taken from the airbag control unit, for example.

#### **Operational data in the vehicle**

This is data regarding the operation of the vehicle, which have been processed by control units.

This includes the following data, for example:

- Vehicle status information such as the speed, longitudinal acceleration, lateral acceleration, number of wheel revolutions or the fastened seat belts display
- Ambient conditions, such as temperature, rain sensor or distance sensor

Generally, the use of these data is temporary; they will not be stored beyond the period of operation and will only be processed within the

vehicle itself. Control units often contain data memories for vehicle keys, for example. Their use permits the temporary or permanent documentation of technical information about the vehicle's operating state, component loads, maintenance requirements and technical events or malfunctions.

Depending on the vehicle equipment, the following data are stored:

- Operating status of system components, such as fill levels, tire pressure or battery status
- Malfunctions or faults in important system components, such as lights or brakes
- System reactions in special driving situations, such as airbag deployment or the intervention of stability control systems
- Information on events leading to vehicle damage

In certain cases, it may be required to store data that would have otherwise been used only temporarily. This may be the case if the vehicle has detected a malfunction, for example.



If you use services, such as repair services and maintenance work, stored operational data as well as the vehicle identification number can be read out and used. They can be read out by service network employees, such as workshops and manufacturers or third parties, such as breakdown services. The same is true in the case of warranty claims and quality assurance measures.

In general, the readout is performed via the legally prescribed port for the diagnostics connection in the vehicle. The operational data that are read out document technical states of the vehicle or of individual components and assist in the diagnosis of malfunctions, compliance with warranty obligations and quality improvement. To that end, these data, in particular information about component loads, technical events, malfunctions and other faults may be transmitted along with the vehicle identification number to the manufacturer. Furthermore, the manufacturer is subject to product liability. For this reason the manufacturer also uses operational data from the vehicle, for example, for recalls. These

data can also be used to examine the customer's warranty and guarantee claims.

Fault memories in the vehicle can be reset by a service outlet or at your request as part of repair or maintenance work.

### Convenience and infotainment functions

You can store convenience settings and individual settings in the vehicle and change or reset them at any time.

Depending on the vehicle equipment, this includes the following settings, for example:

- Seat and steering wheel positions
- Suspension and climate control settings
- Individual settings, such as interior lighting

Depending on the selected equipment, you can import data into vehicle infotainment functions yourself.

Depending on the vehicle equipment, this includes the following data, for example:

- Multimedia data, such as music, films or photos for playback in an integrated multimedia system

- Address book data for use in connection with an integrated hands-free system or an integrated navigation system
- Entered navigation destinations
- Data about the use of Internet services

These data for convenience and infotainment functions may be saved locally in the vehicle or they may be located on a device which you have connected to the vehicle, such as a smartphone, USB flash drive or MP3 player. If you have entered these data yourself, you can delete them at any time.

This data is transmitted from the vehicle to third parties only at your request. This applies, in particular, when you use online services in accordance with the settings that you have selected.

### Smartphone integration (e.g. Android Auto or Apple CarPlay®)

If your vehicle is accordingly equipped, you can connect your smartphone or another mobile end device to the vehicle. You can then control them by means of the control elements integrated in the vehicle. Images and audio from the smart-

phone can be output via the multimedia system. Certain information is simultaneously transferred to your smartphone. Depending on the type and integration, this includes position data, day/night mode and other general vehicle statuses. For more information please consult the Operator's Manual of the vehicle/infotainment system.

This integration allows the use of selected smartphone apps, such as navigation or music player apps. There is no further interaction between the smartphone and the vehicle; in particular, vehicle data is not directly accessible. The type of additional data processing is determined by the provider of the app being used. Which settings you can make, if any, depends on the specific app and the operating system of your smartphone.

### Online services

---

#### Wireless network connection

If your vehicle has a wireless network connection, it enables data to be exchanged between your vehicle and additional systems. The wireless network connection is made possible by the

vehicle's own transmitter and receiver or by a mobile end device that you have brought into the vehicle, for example, a smartphone. Online functions can be used via the wireless network connection. This includes online services and applications/apps provided to you by the manufacturer or by other providers.

#### Manufacturer's services

Regarding the manufacturer's online services, the individual functions are described by the manufacturer in a suitable place, for example, in the Operator's Manual or on the manufacturer's website, where the relevant data protection information is also given. Personal data may be used for the provision of online services. Data are exchanged via a secure connection, such as the manufacturer's designated IT systems. Any personal data which are collected, processed and used, other than for the provision of services, is done so exclusively on the basis of legal permission. This is the case, for example, for a legally prescribed emergency call system, a contractual agreement or when consent has been given.

You can have services and functions, some of which are subject to a fee, activated or deactivated. This excludes legally prescribed functions and services, such as an emergency call system.

#### Third party services

If you use online services from other providers (third parties), these services are the responsibility of the provider in question and subject to that provider's data protection conditions and terms of use. As a general rule, the manufacturer has no influence on the content exchanged.

For this reason, when services are provided by third parties, please ask the service provider in question for information about the type, extent and purpose of the collection and use of personal data.

### Data protection rights

---

Depending on your country or the equipment and range of functions of your vehicle as well as the services you use and the services on offer, you are entitled to different data protection rights. Further information on data protection

and your data protection rights can either be found on the manufacturer's website or you will receive this information as part of the various services and service offers. There you will also find the contact information for the manufacturer and its data protection officers.

At a workshop, for example, with the support of a specialist and possibly for a fee, you can have data read out which is stored only locally in the vehicle.

### Multimedia system/Mercedes me connect

If the vehicle is equipped with the multimedia system or Mercedes me connect, additional data about the vehicle's operation, the use of the vehicle in certain situations, and the location of the vehicle may be compiled by the multimedia system or Mercedes me connect.

For additional information please refer to the chapter "Multimedia system" and/or the Mercedes me connect Terms and Conditions.

### Event data recorders

#### **USA only:**

This vehicle is equipped with an event data recorder (EDR). The main purpose of an EDR is to record, in certain crash or near crash-like situations, such as an airbag deployment or hitting a road obstacle, data that will assist in understanding how a vehicle's systems performed. The EDR is designed to record data related to vehicle dynamics and safety systems for a short period of time, typically 30 seconds or less.

The EDR in this vehicle is designed to record such data as:

- How various systems in your vehicle were operating
- Whether or not the driver and front passenger seat belts were buckled/fastened
- How far (if at all) the driver was depressing the accelerator and/or brake pedal and
- How fast the vehicle was traveling

This data can help provide a better understanding of the circumstances in which accidents and injuries occur. NOTE: EDR data is recorded by

your vehicle only if a non-trivial crash situation occurs; no data is recorded by the EDR under normal driving conditions and no personal data (e.g. name, gender, age and accident location) is recorded. However, other parties, such as law enforcement, could combine EDR data with the type of personally identifying data routinely acquired during a crash investigation.

To read data recorded by an EDR, special equipment is required, and access to the vehicle or the EDR is needed. In addition to the vehicle manufacturer, other parties that have the special equipment, such as law enforcement, can read the information by accessing the vehicle or the EDR.

EDR data may be used in civil and criminal matters as a tool in accident reconstruction, accident claims and vehicle safety. Since the Crash Data Retrieval (CDR) tool that is used to extract data from the EDR is commercially available, Mercedes-Benz USA, LLC ("MBUSA") expressly disclaims any and all liability arising from the extraction of this information by unauthorized Mercedes-Benz personnel.

MBUSA will not share EDR data with others without the consent of the vehicle owner or, if the vehicle is leased, without the consent of the lessee. Exceptions to this representation include responses to subpoenas by law enforcement; by federal, state or local government; in connection with or arising out of litigation involving MBUSA or its subsidiaries and affiliates; or, as required by law.

**Warning:** The EDR is a component of the Restraint System Module. Tampering with, altering, modifying or removing the EDR component may result in a malfunction of the Restraint System Module and other systems.

State laws or regulations regarding EDRs that conflict with federal regulation are pre-empted. This means that in the event of such conflict, the federal regulation governs. As of December 2016, 17 states have enacted laws relating to EDRs.

### Copyright

#### Free and open source software

Information on license for free and open-source software used in your vehicle can be found on the data carrier in your vehicle document wallet and with updates on the following website:

<https://www.mercedes-benz.com/opensource>

#### Registered trademarks

- Bluetooth® is a registered trademark of Bluetooth SIG, Inc.
- DTS™ is a registered trademark of DTS, Inc.
- Dolby® and MLP™ are registered trademarks of DOLBY Laboratories.
- ESP® and PRE-SAFE® are registered trademarks of Daimler AG.
- HomeLink® is a registered trademark of Genex Corporation.
- iPod® and iTunes® are registered trademarks of Apple Inc.
- Burmester® is a registered trademark of Burmester Audiosysteme GmbH.
- Microsoft® and Windows Media® are registered trademarks of Microsoft Corporation.
- SIRIUS® is a registered trademark of Sirius XM Radio Inc.
- HD Radio™ is a registered trademark of iBiquity Digital Corporation.
- Gracenote® is a registered trademark of Gracenote, Inc.
- ZAGAT Survey® and related brands are registered trademarks of Zagat Survey, LLC.

## Restraint system

### Protection provided by the restraint system

The restraint system includes the following components:

- Seat belt system
- Airbags
- Child restraint system
- Child seat securing systems

The restraint system can help prevent the vehicle occupants from coming into contact with parts of the vehicle interior in the event of an accident. In the event of an accident, the restraint system can also reduce the forces to which the vehicle occupants are subjected.

A seat belt can only provide the best level of protection if it is worn correctly. Depending on the detected accident situation, Emergency Tensioning Devices and/or airbags supplement the protection offered by a correctly worn seat belt. Emergency Tensioning Devices and/or airbags are not deployed in every accident.

In order for the restraint system to provide the intended level of protection, each vehicle occupant must observe the following information:

- Fasten seat belts correctly.
- Sit in an almost upright seat position with their back against the seat backrest.
- Sit with their feet resting on the floor, if possible.
- Always secure persons under 5 ft (1.50 m) tall in an additional restraint system suitable for Mercedes-Benz vehicles.

However, no system available today can completely eliminate injuries and fatalities in every accident situation. In particular, the seat belt and airbag generally do not protect against objects penetrating the vehicle from the outside. It is also not possible to completely rule out the risk of injury caused by the airbag deploying.

### Reduced restraint system protection

**⚠ WARNING** Risk of injury or death due to modifications to the restraint system

Vehicle occupants may no longer be protected as intended if alterations are made to the restraint system.

- ▶ Never alter the parts of the restraint system.
- ▶ Never tamper with the wiring or any electronic component parts or their software.

If it is necessary to modify the vehicle to accommodate a person with disabilities, contact an authorized Mercedes-Benz Center for details.

USA only: for details, contact our Customer Assistance Center on 1-800-FOR-MERCEdes (1-800-367-6372).



### Restraint system functionality

When the ignition is switched on, a self-test is performed, during which the  restraint sys-

tem warning lamp lights up. It goes out no later than a few seconds after the vehicle is started. The components of the restraint system are then functional.

### Malfunctioning restraint system

A malfunction has occurred in the restraint system if:

- The  restraint system warning lamp does not light up when the ignition is switched on
- The  restraint system warning lamp lights up continuously or repeatedly during a journey

**⚠ WARNING** Risk of injury due to malfunctions in the restraint system

Components in the restraint system may be activated unintentionally or not deploy as planned in an accident.

- ▶ Have the restraint system checked and repaired immediately at a qualified specialist workshop.

### Function of the restraint system in an accident

How the restraint system works is determined by the severity of the impact detected and the type of accident anticipated:

- Frontal impact
- Rear impact
- Side impact
- Rollover

The activation thresholds for the components of the restraint system are determined based on the evaluation of the sensor values measured at various points in the vehicle. This process is preemptive in nature. The triggering/deployment of the components of the restraint system must take place in good time at the start of the collision.

Factors which can only be seen and measured after a collision has occurred do not play a decisive role in the deployment of an airbag. Nor do they provide an indication of airbag deployment.

The vehicle may be deformed significantly without an airbag being deployed. This is the case if

only parts which are relatively easily deformed are affected and the rate of vehicle deceleration is not high. Conversely, an airbag may be deployed even though the vehicle suffers only minor deformation. If very rigid vehicle parts such as longitudinal members are hit, this may result in sufficiently high levels of vehicle deceleration.

Depending on the detected deployment situation, the components of the restraint system can be activated or deployed independently of each other:

- Emergency Tensioning Device: frontal impact, rear impact, side impact, rollover
- Driver's airbag, front passenger airbag: frontal impact
- Knee airbag: frontal impact
- Side airbag: side impact
- Window curtain airbag: side impact, rollover, frontal impact

The front passenger airbag can only be deployed in an accident if the PASSENGER AIR BAG OFF indicator lamp is off. If the front passenger seat

is occupied, make sure, both before and during the journey, that the status of the front passenger airbag is correct (→ page 47).

**⚠ WARNING** Risk of burns from hot air bag components

The air bag parts are hot after an air bag has been deployed.

- ▶ Do not touch the air bag parts.
- ▶ Have a deployed air bag replaced at a qualified specialist workshop as soon as possible.

Mercedes-Benz recommends that you have the vehicle towed to a qualified specialist workshop after an accident. Take this into account, particularly if an Emergency Tensioning Device is triggered or an airbag deployed.

If the Emergency Tensioning Devices are triggered or an airbag is deployed, you will hear a bang, and a small amount of powder may also be released:

- The bang will not generally affect your hearing.

- In general, the powder released is not hazardous to health but may cause short-term breathing difficulties to persons suffering from asthma or other pulmonary conditions. Provided it is safe to do so, leave the vehicle immediately or open the window in order to prevent breathing difficulties.

Airbags and pyrotechnic Emergency Tensioning Devices contain perchlorate material, which may require special handling or environmental protection measures. National guidelines regarding waste disposal must be observed. In California, see <https://dtsc.ca.gov/>. Using the search function, you will find information on perchlorate, for example.

## Seat belts

### Protection provided by the seat belt

Always fasten your seat belt correctly before starting a journey. A seat belt can only provide the best level of protection if it is worn correctly.

**⚠ WARNING** Risk of injury or death due to incorrectly fastened seat belt

If the seat belt is not worn correctly, it cannot perform its intended protective function. In addition, an incorrectly fastened seat belt can also cause injuries, for example, in the event of an accident or when braking or changing direction suddenly.

- ▶ Always ensure that all vehicle occupants have their seat belts fastened correctly and are sitting properly.

Always observe the instructions about the correct driver's seat position and adjusting the seat (→ page 86).

In order for the correctly worn seat belt to provide the intended level of protection, each vehicle occupant must observe the following information:

- The seat belt must not be twisted and must fit tightly and snugly across the body.

- The seat belt must be routed across the center of the shoulder and as low down across the hips as possible.
- The shoulder section of the seat belt should not touch your neck nor be routed under your arm or behind your back.
- Avoid wearing bulky clothing, e.g. a winter coat.
- Push the lap belt down as far as possible across your hips and pull tight with the shoulder section of the belt. Never route the lap belt across your abdomen.

Pregnant women must also take particular care with this.

- Never route the seat belt across sharp, pointed, abrasive or fragile objects.
- Only one person should use each seat belt at any one time. Never allow babies and children to travel sitting on the lap of another vehicle occupant.
- Never secure objects with a seat belt if the seat belt is also being used by one of the vehicle's occupants. Always observe the instructions for loading the vehicle when

securing objects, luggage or loads (→ page 100).

Also ensure that no objects, e.g. a cushion, are ever placed between a person and the seat.

The seat belts on the following seats are equipped with a special seat belt retractor:

- Front passenger seat
- Rear seats

Activate or deactivate the special seatbelt retractor (→ page 55).

If children are traveling in the vehicle, be sure to observe the instructions and safety notes on "Children in the vehicle" (→ page 51).

### Limitations of the protection provided by the seat belt

**⚠ WARNING** Risk of injury or death due to an incorrect seat position

The seat belt does not offer the intended level of protection if you have not moved the seat backrest to an almost vertical position.

In particular, you could slip beneath the seat-belt and become injured.

- ▶ Adjust the seat properly before beginning your journey.
- ▶ Always ensure that the seat backrest is in an almost vertical position and that the shoulder belt is routed across the center of your shoulder.

**⚠ WARNING** Risk of injury or death due to an extended seat belt extender while the vehicle is in motion

If the seat belt does not sit correctly on the body, it cannot perform its intended protective function.



- ▶ Always ensure that the seat belt extender is retracted while the vehicle is in motion.

If the seat belt extender does not retract automatically, it can be retracted manually. To do so, press the seat belt extender back as far as it will go before starting the vehicle. Pressing the seat belt extender back into place requires force.

- ⚠ WARNING** Risk of injury or death when additional restraint systems are not used for persons with a smaller stature

Persons under 5 ft (1.50 m) tall cannot wear the seat belt correctly without a suitable additional restraint system.

- ▶ Always secure persons under 5 ft (1.50 m) tall in a suitable restraint system.

- ⚠ WARNING** Risk of injury or death due to damaged or modified seat belts

Seat belts cannot provide protection in the following situations:

- The seat belt is damaged, has been modified, is extremely dirty, bleached or dyed
- The seat belt buckle is damaged or extremely dirty
- Modifications have been made to the Emergency Tensioning Device, seat belt anchorage or seat belt retractor

Seat belts may sustain non-visible damage in an accident, e.g. due to glass splinters.

Modified or damaged seat belts could tear or fail in the event of an accident, for example.

Modified Emergency Tensioning Devices could accidentally trigger or fail to function as intended.

- ▶ Never modify the seat belt system, for example the seat belt, seat belt buckle, Emergency Tensioning Device, seat belt anchorage and seat belt retractor.

- ▶ Make sure that the seat belts are undamaged, not worn and clean.
- ▶ Always have the seat belts checked immediately after an accident at a qualified specialist workshop.

Only use seat belts which have been approved for your vehicle by Mercedes-Benz.

- ⚠ WARNING** Risk of injury or death from deployed pyrotechnic Emergency Tensioning Devices

Pyrotechnic Emergency Tensioning Devices that have been deployed are no longer operational and are unable to perform their intended protective function.

- ▶ Therefore, have deployed pyrotechnic Emergency Tensioning Devices immediately replaced at a qualified specialist workshop.

Mercedes-Benz recommends that you have the vehicle towed to a qualified specialist workshop after an accident.

**NOTE** Damage caused by trapping the seat belt

If an unused seat belt is not fully retracted, it may become trapped in the door or in the seat mechanism.

- ▶ Always ensure that an unused seat belt is fully retracted.

### Extending/retracting the seat belt extender

When the door is closed, the seat belt extender extends.

You can also extend the seat-belt extender by using the  seat-belt extender button in the center console.

The  seat belt extender button may also be located in the switch panel above the light switch in Mercedes-AMG vehicles.

- ▶ Switch on the ignition.
- ▶ Press the  seat belt extender button. The seat belt extender extends.

The seat belt extender retracts again in the following cases:

- The seat belt tongue is engaged in the seat belt buckle
- The seat belt tongue is not engaged in the seat belt buckle within 60 seconds

If you press the  seat belt extender button again in this case, the seat belt extender will extend again.



- The respective door is opened
  - You fold the seat backrest forwards
  - Nobody is sitting in the front passenger seat
- If you press the  seat belt extender button again in this case, the seat belt extender will no longer extend.

The seat belt extender must always be retracted while the vehicle is in motion.

### Fastening seat belts

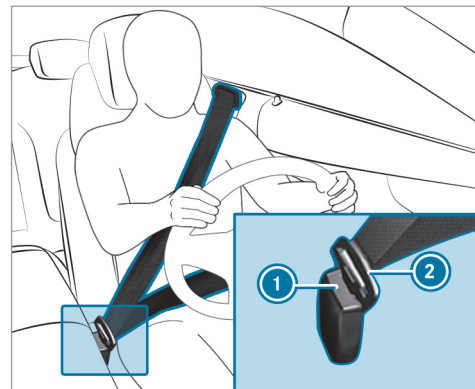
If the seat belt is pulled quickly or sharply, the seat belt retractor locks. The seat belt strap cannot be pulled out any further.



- ▶ Always engage seat belt tongue  of the seat belt into seat belt buckle  of the corresponding seat.

**Vehicles with automatic front passenger air-bag shutoff:**

**!** **NOTE** Deployment of the Emergency Tensioning Device and side air bag when the front passenger seat is unoccupied

If the seat belt tongue is engaged in the seat belt buckle of the unoccupied front passenger seat, the Emergency Tensioning Device and the side air bag may also deploy in the event of an accident along with other systems.

- ▶ Only one person should use each seat belt at any one time.

#### Vehicles without automatic front passenger airbag shutoff:

**!** **NOTE** Deployment of the Emergency Tensioning Device when the front-passenger seat is unoccupied

If the seat belt tongue is engaged in the seat belt buckle of the unoccupied front-passenger seat, the Emergency Tensioning Device may also deploy in the event of an accident along with other systems.

- ▶ Only one person should use each seat belt at any one time.

#### Seat belt adjustment function

**Vehicles with PRE-SAFE®:** After a front seat belt has been fastened, the automatic seat belt adjustment may apply a certain tightening force. Do not hold the seat belt tightly while it is adjusting.

You can activate and deactivate the seat belt adjustment function using the multimedia system (→ page 41).

#### Activating/deactivating seat belt adjustment via the multimedia system

Multimedia system:

↳ **Vehicle** ▶  **Vehicle Settings**  
 ▶ **Belt Adjustment**

- ▶ Activate  or deactivate  the function.

#### Releasing seat belts

- ▶ Press the release button in the seat belt buckle and guide the seat belt back with the seat belt tongue.

#### Seat belt warning function for the driver and front passenger

The  seat belt warning lamp in the instrument display is a reminder that all vehicle occupants must wear their seat belts correctly.

The  seat belt warning lamp lights up for six seconds every time the vehicle is started.

In addition, a warning tone may sound.

When the driver's and front passenger's doors are closed and the driver and front passenger have fastened their seat belts, the seat belt warning goes out.

In the following cases, the seat belt warning lights up during a journey if:

- The vehicle speed exceeds 15 mph (25 km/h) and the driver's or front passenger seat belt is not fastened.

## 42 Occupant safety

- The driver or front passenger unfastens their seat belt while the vehicle is in motion.

### Airbags

#### Overview of airbags

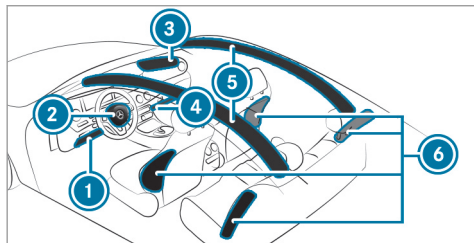

- ① Driver's knee airbag
- ② Driver's airbag
- ③ Front passenger airbag
- ④ Front passenger knee airbag
- ⑤ Window curtain airbag
- ⑥ Side airbag

The installation location of an airbag is identified by the AIRBAG symbol.

When enabled, an airbag can provide additional protection for the respective vehicle occupant.

Potential protection provided by each airbag:

- Knee airbag: thigh, knee and lower leg
- Driver's airbag, front passenger airbag: head and ribcage
- Window curtain airbag: head
- Side airbag: ribcage, also pelvis for front seat occupants

#### **I** NOTE Mercedes-AMG vehicles

▶ Observe the notes in the Supplement. You could otherwise fail to recognize dangers.

#### **A** WARNING Risk of injury or death if the co-driver airbag is enabled

If the co-driver airbag is enabled, a child on the co-driver seat may be struck by the co-driver airbag during an accident.

NEVER use a rearward-facing child restraint system on a seat with an ENABLED FRONT AIRBAG; DEATH or SERIOUS INJURY to the CHILD can occur.

When installing a child restraint system on the front passenger seat, observe the vehicle-specific information (→ page 60). Also, always observe the notes on rearward-facing or forward-facing child restraint systems on the front passenger seat.

#### **Information on automatic front passenger airbag shutoff**

The front passenger airbag can only be deployed in an accident if the PASSENGER AIR BAG OFF indicator lamp is off. If the front passenger seat is occupied, make sure, both before and during the journey, that the status of the front passenger airbag is correct (→ page 47).

**!** **NOTE** Deployment of components of the restraint system when the front passenger seat is unoccupied

In an accident, the components of the restraint system may deploy unnecessarily on the front passenger side if:

- There are heavy objects on the front passenger seat.
- The seat belt tongue is engaged in the seat belt buckle of the front passenger seat and the front passenger seat is unoccupied.

- ▶ Store objects in a suitable place.
- ▶ Only one person should use each seat belt at any one time.

Depending on the detected accident situation, the window curtain airbag on the front passenger side may deploy. The airbag is deployed regardless of whether the front passenger seat is occupied.

### Protective capacity of the airbags

Depending on the accident situation, an airbag may supplement the protection offered by a correctly fastened seat belt.

**!** **WARNING** Risk of injury or death due to an incorrect seat position

If you deviate from the correct seat position, the airbag cannot perform its intended protective function.

Each vehicle occupant must make sure of the following:

- Fasten seat belts correctly. Pregnant women must take particular care to ensure that the lap belt never lies across the abdomen.
  - Adopt the correct seat position and keep as far away as possible from the airbags.
  - Observe the following information.
- ▶ Always make sure that there are no objects between the airbag and vehicle occupant.

To avoid the risks resulting from the deployment of an airbag, each vehicle occupant must observe the following information in particular:

- Before starting your journey, adjust your seat correctly; the driver's seat and front passenger seat should be moved as far back as possible.

When doing so, always observe the information on the correct driver's seat position (→ page 86).

- Only hold the steering wheel by the steering wheel rim. This allows the airbag to be fully deployed.
- Always lean against the seat backrest when the vehicle is in motion. Do not lean forwards or against the door or side window. You may otherwise be in the deployment area of the airbags.
- The occupants must always keep their feet on the floor. Do not put your feet on the cockpit, for example. Your feet may otherwise be in the deployment area of the airbag.
- If children are traveling in the vehicle, observe the additional notes (→ page 51).

## 44 Occupant safety

- Always store and secure objects correctly.

Objects in the vehicle interior may prevent an airbag from functioning correctly. Each vehicle occupant must always make sure of the following in particular:

- There are no people, animals or objects between the vehicle occupants and an airbag.
- There are no objects between the seat, door and door pillar (B-pillar).
- There are no hard objects, e.g. coat hangers, hanging on the grab handles or coat hooks.
- There are no accessory parts, such as mobile navigation devices, mobile phones or cup holders, within the deployment area of an airbag, e.g. on the cockpit, on the door, on the side window or on the side trim.

In addition, no connecting cables, tensioning straps or retaining straps must be routed or attached to the vehicle within the deployment area of an airbag. Always comply with the accessory manufacturer's installation instructions and, in particular, the notes on suitable places for installation.

- There are no heavy, sharp-edged or fragile objects in the pockets of your clothing. Store such objects in a suitable place.

### Limited protection provided by airbags

**⚠ WARNING** Risk of injury due to modifications to the cover of an airbag

If you modify the cover of an airbag or affix objects such as stickers to it, the airbag may no longer function correctly.

- ▶ Never modify the cover of an airbag and do not affix objects to it.

The installation location of an airbag is identified by the AIRBAG symbol (→ page 42).

**⚠ WARNING** Risk of injury or death due to the use of unsuitable seat covers

Due to unsuitable seat covers, the airbags cannot protect vehicle occupants as intended.

In addition, the operation of the automatic front passenger airbag shutoff could be restricted.

- ▶ You should only use seat covers that have been approved for the corresponding seats by Mercedes-Benz.

**⚠ WARNING** Risk of injury due to malfunctioning sensors in the door

The function of the airbags can be impaired due to modifications or incorrect work performed on the doors or door trim, or if the doors are damaged.

- ▶ Never modify the doors or parts of the doors.
- ▶ Always have work on the doors or door trim carried out at a qualified specialist workshop.

**⚠ WARNING** Risk of injury due to deployed airbag

A deployed airbag no longer offers any protection.

- ▶ Have the vehicle towed to a qualified specialist workshop in order to have the deployed airbag replaced.

Have deployed airbags replaced immediately.

### Status of the front passenger front airbag

#### Function of the automatic front passenger airbag shutoff

The automatic front passenger airbag shutoff is able to detect whether the front passenger seat is occupied by a person or a child restraint system. The front passenger airbag and front passenger knee airbag are enabled or disabled accordingly.

#### **▲ WARNING** Risk of injury or death due to objects under the co-driver seat

Objects trapped under the co-driver seat can interfere with the function of the automatic co-driver airbag shutoff or damage the system.

- ▶ Do not store any objects under the co-driver seat.
- ▶ When the co-driver seat is occupied, make sure that no objects are trapped under the co-driver seat.

When installing a child restraint system on the front passenger seat, always make sure of the following:

- Ensure that the child restraint system is positioned correctly (→ page 50).
- Always comply with the child restraint system manufacturer's installation instructions.
- Never place objects (e.g. cushions) under or behind the child restraint system.
- Fully retract the seat cushion length adjustment.
- The entire base of the child restraint system must always rest on the sitting surface of the front passenger seat.
- The backrest of the forward-facing child restraint system must, as far as possible, be

resting on the seat backrest of the front passenger seat.

- The child restraint system must not touch the roof or be put under strain by the head restraints. Adjust the seat backrest inclination and the head restraint setting accordingly.

#### **▲ WARNING** Risk of injury or death due to objects between the seat surface and the child restraint system

Objects between the sitting surface and the child restraint system could affect the function of the automatic co-driver airbag shutoff.

- ▶ Do not place any objects between the sitting surface and the child restraint system.
- ▶ The entire base of the child restraint system must always rest on the sitting surface of the co-driver seat.
- ▶ The backrest of the forward-facing child restraint system must, as far as possible,

ble, be resting on the seat backrest of the co-driver seat.

- ▶ Always comply with the child restraint system manufacturer's installation instructions.

A person on the front passenger seat must observe the following information:

- Fasten seat belts correctly (→ page 37).
- Sit in an almost upright seat position with their back against the seat backrest.
- Sit with their feet resting on the floor, if possible.

The front passenger airbag may otherwise be disabled by mistake, for example, in the following situations:

- The front passenger transfers their weight by supporting themselves on a vehicle armrest.
- The front passenger sits in such a way that their weight is raised from the sitting surface.

**⚠ WARNING** Risk of injury or death due to a disabled front passenger airbag

The front passenger airbag is disabled when the PASSENGER AIR BAG OFF indicator lamp is lit.

A person in the front passenger seat could then, for example, come into contact with the vehicle interior, especially if the person is sitting too close to the cockpit.

If the front passenger seat is occupied, always ensure that:

- The classification of the person in the front passenger seat is correct and the front passenger airbag is enabled or disabled in accordance with the person in the front passenger seat.
- The front passenger seat has been moved as far back as possible.
- The person is seated correctly.

- ▶ Both before and during the journey, ensure that the status of the front passenger airbag is correct.

If the front passenger seat is occupied, the classification of the person or child restraint system on the front passenger seat takes place after the front passenger airbag shutoff self-test. The PASSENGER AIR BAG indicator lamps display the status of the front passenger airbag.

Always observe the notes on the function of the PASSENGER AIR BAG indicator lamps (→ page 47).



### Function of the PASSENGER AIR BAG indicator lamps

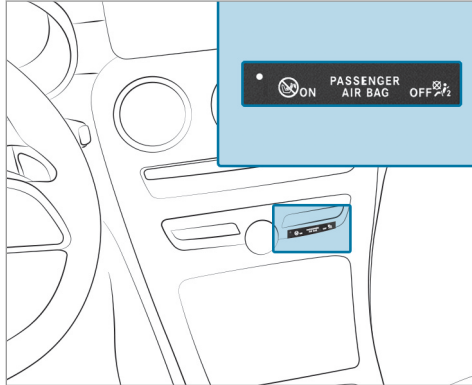

### Self-test of automatic front passenger airbag shutoff

When the ignition is switched on, a self-test is performed during which the two PASSENGER AIR BAG ON and OFF indicator lamps light up simultaneously.

The status of the front passenger airbag is displayed via the PASSENGER AIR BAG indicator lamps after the self-test:

- **ON is lit:** the front passenger airbag may deploy during an accident.  
The indicator lamp goes out after approximately 60 seconds.
- **ON and OFF are not lit:** the front passenger airbag may deploy during an accident.
- **OFF is lit:** the front passenger airbag is disabled. It will then not be deployed in the event of an accident.

If the PASSENGER AIR BAG ON indicator lamp is off, only the PASSENGER AIR BAG OFF indicator lamp shows the status of the front passenger airbag. The PASSENGER AIR BAG OFF indicator lamp may be lit continuously or be off.

If the PASSENGER AIR BAG OFF indicator lamp and the  restraint system warning lamp light up simultaneously, the front passenger seat may not be used. Also in this case, do not install a child restraint system on the front passenger seat. Have the automatic front passenger airbag

shutoff checked and repaired immediately at a qualified specialist workshop.

### Status display

If the front passenger seat is occupied, ensure, both before and during the journey, that the status of the front passenger airbag is correct for the current situation.

**After installing a rearward-facing child restraint system on the front passenger seat:** PASSENGER AIR BAG OFF must be lit continuously.

**⚠ WARNING** Risk of injury or death when using a rearward-facing child restraint system while the front passenger airbag is enabled

If you secure a child in a rearward-facing child restraint system on the front passenger seat and the PASSENGER AIR BAG OFF indicator lamp is off, the front passenger airbag can deploy in the event of an accident.

The child could be struck by the airbag.

Always ensure that the front passenger airbag is disabled. The PASSENGER AIR BAG OFF indicator lamp must be lit.

NEVER use a rearward-facing child restraint system on a seat with an ENABLED FRONT AIRBAG. This can result in the DEATH of or SERIOUS INJURY to the CHILD.

When installing a child restraint system on the front passenger seat, observe the vehicle-specific information (→ page 60).

Depending on the child restraint system and the stature of the child, the PASSENGER AIR BAG OFF indicator lamp may be off. In this case, do not install the rearward-facing child restraint system on the front passenger seat.

Instead, install the rearward-facing child restraint system on a suitable rear seat.

**After installing a forward-facing child restraint system on the front passenger seat:**

depending on the child restraint system and the stature of the child, PASSENGER AIR BAG OFF may be lit continuously or be off. Always observe the following information.

**⚠ WARNING** Risk of injury or death due to incorrect positioning of the forward-facing child restraint system

If you secure a child in a forward-facing child restraint system on the front passenger seat that is positioned too close to the cockpit, in the event of an accident, the child could:

- come into contact with parts of the vehicle's interior if the PASSENGER AIR BAG OFF indicator lamp is lit, for example
- be struck by the airbag if the PASSENGER AIR BAG OFF indicator lamp is off

▶ Always move the front passenger seat as far back as possible and fully retract the seat cushion length adjustment. While doing so, always make sure that the shoulder belt strap is correctly routed from the seat belt outlet of the vehicle to the shoulder belt guide on the child restraint system. The shoulder belt strap must be routed forwards and downwards from the seat belt outlet. If

necessary, adjust the front passenger seat accordingly.

- ▶ Always comply with the child restraint system manufacturer's installation instructions.

When installing a child restraint system on the front passenger seat, observe the vehicle-specific information (→ page 60).

**If a person is sitting on the front passenger seat:** PASSENGER AIR BAG OFF may be lit continuously or be off, depending on the person's stature.

A person on the front passenger seat must always observe the following information:

- If the front passenger seat is occupied by an adult or a person with a stature corresponding to that of an adult, the PASSENGER AIR BAG OFF indicator lamp must be off. This indicates that the front passenger airbag is enabled.

If the PASSENGER AIR BAG OFF indicator lamp is lit continuously, an adult or person

with a build corresponding to that of an adult must not use the front passenger seat.

Instead, they should use a rear seat.

- If the front passenger seat is occupied by a person of smaller stature (e.g. a teenager or small adult), the PASSENGER AIR BAG OFF indicator lamp is either lit continuously or remains off, depending on the classification.
  - If the PASSENGER AIR BAG OFF indicator lamp is off: move the front passenger seat as far back as possible, or the person of smaller stature should use a rear seat.
  - If the PASSENGER AIR BAG OFF indicator lamp is lit continuously: the person of smaller stature should not use the front passenger seat.

**▲ WARNING** Risk of injury or death when the PASSENGER AIR BAG OFF indicator lamp is lit

If the PASSENGER AIR BAG OFF indicator lamp remains lit after the self-test, the front passenger airbag is disabled.

If the front passenger seat is occupied, always ensure that:

- The classification of the person in the front passenger seat is correct and the front passenger airbag is enabled or disabled in accordance with the person in the front passenger seat.
- The person is seated properly with a correctly fastened seat belt.
- The front passenger seat has been moved as far back as possible.

Be sure to also observe the following further related subjects:

- Child restraint system on the front passenger seat (→ page 60)

### PRE-SAFE® system

#### PRE-SAFE® (anticipatory occupant protection)

PRE-SAFE® is able to detect certain critical driving situations and implement pre-emptive measures to protect the vehicle occupants.

PRE-SAFE® can implement the following measures independently of each other:

- Tightening the seat belts on the driver's seat and front passenger seat.
- Closing the side windows.
- **Vehicles with sliding sunroof:** Close the sliding sunroof.
- **Vehicles with memory function:** Move the front passenger seat to a more favorable seat position.
- **Vehicles with multicontour seat:** Increase the air pressure in the seat side bolsters of the seat backrest.
- PRE-SAFE® Sound: provided that the multimedia system is switched on, generates a

brief noise signal to stimulate the innate protective mechanism of a person's hearing.

**!** **NOTE** Damage caused by objects in the footwell or behind the seat

The automatic adjustment of the seat position may result in damage to the seat and/or the object.

▶ Stow objects in a suitable place.

### Reversing the PRE-SAFE® system measures

If an accident did not occur, the pre-emptive measures that were taken are reversed.

You will need to perform certain settings yourself.

▶ If the seat belt pre-tensioning is not reduced, move the seat backrest back slightly. The locking mechanism releases.

### Function of PRE-SAFE® PLUS (anticipatory occupant protection plus)

PRE-SAFE® PLUS can detect certain impacts, particularly an imminent rear impact, and take pre-emptive measures to protect the vehicle occupants. These measures cannot necessarily prevent an imminent impact.

PRE-SAFE® PLUS can implement the following measures independently of each other:

- Tightening the seat belts on the driver's seat and front passenger seat.
- Increasing brake pressure when the vehicle is stationary. This brake application is canceled automatically when the vehicle pulls away.

If an accident did not occur, the pre-emptive measures that were taken are reversed.

### System limits

The system will not initiate any action in the following situations:

- When backing up

The system will not initiate any braking application in the following situations:

- Whilst driving  
or
- When entering or exiting a parking space while using Active Parking Assist

### Safely transporting children in the vehicle

#### Always observe when children are traveling in the vehicle

- ⓘ Also strictly observe the safety notes for the specific situation. In this way you can recognize potential risks and avoid dangers if children are traveling in the vehicle (→ page 51).

#### Be diligent

Bear in mind that negligence when securing a child in the child restraint system may have serious consequences. Always be diligent in securing a child carefully before every journey.

To improve protection for children younger than 12 years old or under 5 ft (1.50 m) in height, Mercedes-Benz recommends you observe the following information:

- Always secure the child in a child restraint system suitable for this Mercedes-Benz vehicle.
- The child restraint system must be appropriate to the age, weight and size of the child.
- The vehicle seat must be suitable for installing a child restraint system.

Accident statistics show that children secured on the rear seats are generally safer than children secured on the front seats. For this reason, Mercedes-Benz strongly advises that you install a child restraint system on a rear seat.

### The generic term child restraint system

The generic term child restraint system is used in this Operator's Manual. A child restraint system is, for example:

- a baby car seat
- a rearward-facing child seat

- a forward-facing child seat
- a child booster seat with a backrest and seat belt guide

Mercedes-Benz recommends using a child booster seat with a backrest.

The child restraint system must be appropriate to the age, weight and size of the child.

### Observe laws and legal requirements

Always observe the legal requirements when using a child restraint system in the vehicle.

### Observe standards for child restraint systems

All child restraint systems must meet the following standards:

- U.S. Federal Motor Vehicle Safety Standards 213 and 225
- Canadian Motor Vehicle Safety Standards 213 and 210.2

Confirmation that the child restraint system complies with the standards can be found on an instruction label on the child restraint system. This confirmation can also be found in the instal-

lation instructions that are included with the child restraint system.

### Detecting risks, avoiding danger

#### Securing systems for child restraint systems in the vehicle

Only use the following securing systems for child restraint systems:

- The LATCH-type (ISOFIX) securing rings
- The vehicle's seat belt system
- The Top Tether anchorages

Installing a LATCH-type (ISOFIX) child restraint system is preferred.

Simply attaching to the securing rings on the vehicle can reduce the risk of installing the child restraint system incorrectly.

When securing a child with the integrated seat belt of the LATCH-type (ISOFIX) child restraint system, always comply with the permissible gross weight for the child and child restraint system (→ page 55).

A booster seat may be necessary to achieve proper seat belt positioning for children over 40 lbs (18 kg) in weight or until they reach a height where a three-point seat belt can be installed properly without a booster seat.

Mercedes-Benz recommends a suitable child booster seat with a backrest and seat belt guide.

#### Advantage of a rearward-facing child restraint system

It is preferable to transport a baby or a small child in a suitable rearward-facing child restraint system. In this case, the child sits in the opposite direction to the direction of travel and faces backwards.

Babies and small children have comparatively weak neck muscles in relation to the size and weight of their head. The risk of injury to the cervical spine during an accident can be reduced in a rearward-facing child restraint system.

#### Always secure a child restraint system correctly

**⚠ WARNING** Risk of injury or death due to incorrect installation of the child restraint system

The child can then not be protected or restrained as intended.

- ▶ Be sure to comply with the manufacturer's installation instructions for the child restraint system and its correct use.
- ▶ Make sure that the entire base of the child restraint system always rests on the sitting surface of the seat.
- ▶ Never place objects (e.g. cushions) under or behind the child restraint system.
- ▶ Use child restraint systems only with the original cover designed for them.
- ▶ Always replace damaged covers with genuine covers.

**⚠ WARNING** Risk of injury or death due to unsecured child restraint systems in the vehicle

If the child restraint system is incorrectly installed or not secured, it can come loose.

The child restraint system could be flung around and hit vehicle occupants.

- ▶ Always install child restraint systems correctly, even when not in use.
- ▶ Always comply with the child restraint system manufacturer's installation instructions.

- Always observe the child restraint system manufacturer's installation and operating instructions as well as the vehicle-specific information:
  - Installing the LATCH-type (ISOFIX) child restraint system on the rear seat (→ page 55).
  - Securing the child restraint system with the seat belt on the rear seat (→ page 58).

- Securing the child restraint system with the seat belt on the front passenger seat (→ page 61). Observe the specific instructions for the rearward-facing and forward-facing child restraint systems (→ page 60).

If the front passenger seat is occupied, ensure, both before and during the journey, that the status of the front passenger airbag is correct for the current situation (→ page 47).

- Observe the warning labels in the vehicle interior and on the child restraint system.
- Also secure Top Tether if present.

#### Do not modify the child restraint system

**⚠ WARNING** Risk of injury due to modifications to the child restraint system

The child restraint system can no longer function properly. This poses an increased risk of injury.

- ▶ Never modify a child restraint system.

- ▶ Only affix accessories which have been specially approved for this child restraint system by the child restraint system's manufacturer.

#### Only use child restraint systems which are in proper working condition

**⚠ WARNING** Risk of injury or death caused by the use of damaged child restraint systems

Child restraint systems or their retaining systems that have been subjected to stress in an accident may not be able to perform their intended protective function.

It may be the case that the child cannot be properly restrained.

- ▶ Always immediately replace child restraint systems that have been damaged or involved in an accident.
- ▶ Have the securing systems for the child restraint systems checked at a qualified specialist workshop before installing a child restraint system again.

#### Avoid direct sunlight

**⚠ WARNING** Risk of burns when the child seat is exposed to direct sunlight

If the child restraint system is exposed to direct sunlight or heat, parts could heat up. Children could suffer burns from these parts, particularly on the metallic parts of the child restraint system.

- ▶ Always make sure that the child restraint system is not exposed to direct sunlight.
- ▶ Protect the child restraint system, e.g. with a blanket.
- ▶ If the child restraint system has been exposed to direct sunlight, allow it to cool before securing a child in it.
- ▶ Never leave children unattended in the vehicle.

**Observe when stopping or parking**

**▲ WARNING** Risk of accident and injury due to children left unattended in the vehicle

If children are left unsupervised in the vehicle, they could, in particular:

- open doors, thereby endangering other persons or road users.
- get out and be struck by oncoming traffic.
- operate vehicle equipment and become trapped, for example.

In addition, the children could also set the vehicle in motion, for example by:

- releasing the parking brake.
- changing the transmission position.
- starting the vehicle.

▶ Never leave children unattended in the vehicle.

- ▶ When leaving the vehicle, always take the SmartKey with you and lock the vehicle.
- ▶ Keep the vehicle SmartKey out of reach of children.

**▲ WARNING** Danger to life due to exposure to extreme heat or cold in the vehicle

If people, particularly children, are exposed to extreme temperatures over an extended period of time, there is a risk of serious injury or danger to life.

- ▶ Never leave persons, children in particular, unattended in the vehicle.

### **Overview of suitable seats in the vehicle for installing a child restraint system**

#### **Left/right rear seat**

Preferred securing system:



LATCH-type (ISOFIX) child seat anchor



Also secure Top Tether if present (→ page 57).

Alternative securing system:



Vehicle seat belt

#### **Front passenger seat**

Securing system:



Vehicle seat belt

Be sure to observe:

- If the front passenger seat is occupied, ensure, both before and during the journey, that the status of the front passenger airbag is correct for the current situation (→ page 47).
- Observe the notes on automatic front passenger airbag shutoff (→ page 45)



### Activating or deactivating the special seat belt retractor of the seat belt

**⚠ WARNING** Risk of injury or death if a seat belt is unfastened while the vehicle is in motion

If the seat belt is released while the vehicle is in motion, the child safety lock is deactivated and the child restraint system is no longer correctly secured. The seat belt is drawn in slightly by the inertia reel and cannot be immediately closed again.

- ▶ Stop the vehicle immediately in accordance with the traffic conditions.
- ▶ Activate the special seat belt retractor again and correctly secure the child restraint system.

When enabled, the special seat belt retractor ensures that the seat belts of the front passenger seat and rear seats do not slacken once the child restraint system is secured.

The seat belts on the following seats are equipped with a special seat belt retractor:

- Front passenger seat
- Rear seats

#### Installing a child restraint system:

- ▶ When installing a child restraint system, always observe the manufacturer's installation and operating instructions as well as the information in this Operator's Manual.
- ▶ Pull the seat belt smoothly from the seat belt outlet.
- ▶ Engage the seat belt tongue in the seat belt buckle.

#### Activating the special seat belt retractor:

- ▶ Pull the seat belt out fully and let the inertia reel retract it again. When the special seat belt retractor is activated, you will hear a ratcheting sound.
- ▶ Push the child restraint system down until the seat belt sits tightly.

#### Deactivating the special seat belt retractor:

- ▶ Press the release button of the seat belt buckle.
- ▶ Hold the seat belt tongue and guide back to the seat belt outlet.

### Installing a LATCH-type (ISOFIX) child restraint system on the rear seat

#### Installing a LATCH-type (ISOFIX) child restraint system on the rear seat

**⚠ WARNING** Risk of accident if the rear bench seat, rear seat and seat backrest are not engaged

The rear bench seat, rear seat and seat backrest may fold forwards, even when you are driving.

- As a result, the vehicle occupant will be pushed into the seat belt with increased force. The seat belt will not be able to protect as intended and could cause additional injury.

- Objects or loads in the trunk or cargo compartment will not be restrained by the seat backrest.
- ▶ Make sure that the rear bench seat, the rear seat and the seat backrest are engaged before every trip.

If the left and right seat backrests are not engaged and locked in place, this will be shown on the multifunction display on the instrument cluster.

If the center seat backrest is not engaged and locked in place, the red lock verification indicator will be visible.

**▲ WARNING** Risk of injury or death if the permissible gross mass of the child and child restraint system together is exceeded.

Too much load may be placed on the LATCH-type (ISOFIX) child restraint system and the child may not be restrained correctly in the event of an accident, for example.

- ▶ If the child and the child restraint system together weigh more than the permissible gross mass of 73 lb (33 kg), only use a LATCH-type (ISOFIX) child restraint system with which the child is secured with the vehicle seat belt.
- ▶ Also secure the child restraint system with the Top Tether belt, if available.

Always comply with the information about the mass of the child restraint system:

- in the manufacturer's installation and operating instructions for the child restraint system used
- on a label on the child restraint system, if present

Regularly check that the permissible gross mass of the child and child restraint system is still complied with.

When installing a child restraint system, observe the following:

- ✓ Always observe the correct use of the seats and consider their suitability for attaching a child restraint system.
- ✓ Always comply with the manufacturer's installation and operating instructions for the child restraint system used.
- ✓ Make sure that the child's feet do not touch the front seat. If necessary, move the front seat slightly forwards.
- 🌀 When installing a LATCH-type (ISOFIX) child restraint system, also observe the following:
  - ✓ **When using a baby car seat in weight group 0/0+ and a rearward-facing child restraint system in weight group I on a rear seat:** adjust the front seat so that the seat does not touch the child restraint system.
  - ✓ **When using a forward-facing child restraint system in weight group I:** remove the head restraint from the respec-

tive seat, if possible. In addition, the backrest of the child restraint system must lie as flat as possible against the backrest of the vehicle seat.

After the child restraint system has been removed, replace the head restraints again immediately and adjust them correctly.

- ☑ If the head restraint of the child seat cannot be fully extended when it is installed in the vehicle, this will result in restrictions on the maximum size setting for child restraint systems in weight group 2 or 3.

Contact with the roof when the head restraint is fully extended and locked in place will not result in any restrictions on use.

- ☑ The child restraint system must not be put under strain between the roof and the seat cushion and/or be installed facing the wrong direction. Where possible, adjust the seat cushion inclination accordingly.
- ☑ The child restraint system must not be put under strain by the head restraint. Adjust the head restraints as appropriate.

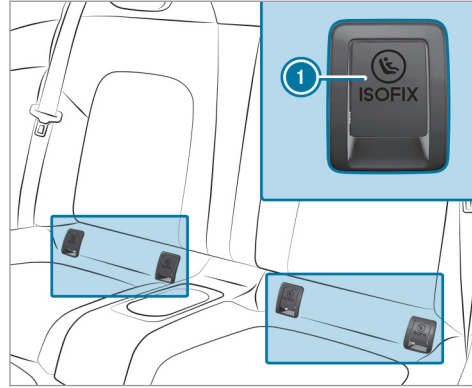

#### ① LATCH-type (ISOFIX) mounting bracket

Before every journey, make sure that the LATCH-type (ISOFIX) child restraint system is engaged correctly in both mounting brackets in the vehicle.

- ▶ Attach the LATCH-type (ISOFIX) child restraint system to both mounting brackets in the vehicle.

## Securing Top Tether

- ⚠ **WARNING** Risk of injury or death if the rear seat backrests are not locked after Top Tether belts are installed

The rear seat backrests may fold forwards when you are driving.

As a result, child restraint systems will no longer be able to perform their intended protective function. This may also cause additional injuries.

- ▶ Always lock rear seat backrests after installing Top Tether belts.
- ▶ Observe the lock verification indicator.

If the left and right seat backrests are not engaged and locked in place, this will be shown on the multifunction display on the instrument cluster.

If the center seat backrest is not engaged and locked in place, the red lock verification indicator will be visible.

- 🚗 If the child restraint system is equipped with a Top Tether belt:

The risk of injury may be reduced by Top Tether. The Top Tether belt enables an additional connection between the child restraint system attached with LATCH-type (ISOFIX) and the vehicle.

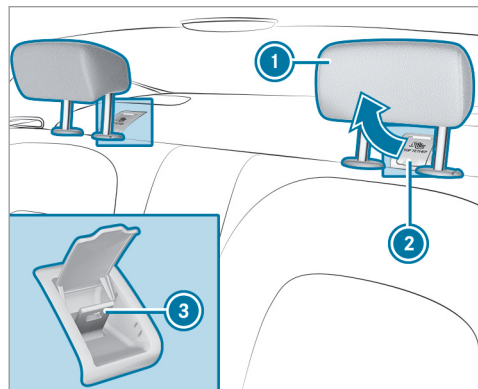

- ▶ If necessary, slide head restraint ① upwards (→ page 91).

- ▶ Fold up cover ② of Top Tether anchorage ③.
- ▶ Install the LATCH-type (ISOFIX) child restraint system with Top Tether. In doing so, comply with the child restraint system manufacturer's installation instructions.

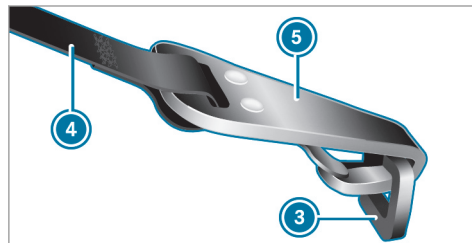

- ▶ Guide Top Tether belt ④ under head restraint ① between the two head restraint bars.
- ▶ Hook Top Tether hook ⑤ of Top Tether belt ④ into Top Tether anchorage ③ without twisting.

- ▶ Tension Top Tether belt ④. In doing so, comply with the child restraint system manufacturer's installation instructions.
- ▶ Fold down cover ② of Top Tether anchorage ③.
- ▶ If necessary, slide head restraint ① downwards (→ page 91). Make sure that you do not interfere with the correct routing of Top Tether belt ④.

#### Securing the child restraint system with the seat belt

#### Securing the child restraint system with the seat belt on the rear seat

**⚠ WARNING** Risk of accident if the rear bench seat, rear seat and seat backrest are not engaged

The rear bench seat, rear seat and seat backrest may fold forwards, even when you are driving.

- As a result, the vehicle occupant will be pushed into the seat belt with increased force. The seat belt will not be able to protect as intended and could cause additional injury.
  - Objects or loads in the trunk or cargo compartment will not be restrained by the seat backrest.
- ▶ Make sure that the rear bench seat, the rear seat and the seat backrest are engaged before every trip.

If the left and right seat backrests are not engaged and locked in place, this will be shown on the multifunction display on the instrument cluster.

If the center seat backrest is not engaged and locked in place, the red lock verification indicator will be visible.

**When installing a belt-secured child restraint system, observe the following:**

- ☑ Always comply with the manufacturer's installation and operating instructions for the child restraint system used.
- ☑ **When using a weight category 0/0+ baby car seat and a weight category I rearward-facing child restraint system on a rear seat:** adjust the front seat so that the seat does not touch the child restraint system.
- ☑ **When using a weight category I forward-facing child restraint system:** remove the head restraint from the respective seat, if possible.  
After the child restraint system has been removed, replace the head restraints again immediately and adjust them correctly.
- ☑ The backrest of the forward-facing child restraint system must, as far as possible, be resting on the seat backrest of the rear seat.
- ☑ If the head restraint of the child seat cannot be fully extended when it is installed in the

vehicle, this will result in restrictions on the maximum size setting for child restraint systems in weight category II or III.

Contact with the roof when the head restraint is fully extended and locked in place will not result in any restrictions on use.

- ☑ The child restraint system must not be put under strain between the roof and the seat cushion and/or be installed facing the wrong direction. Where possible, adjust the seat cushion inclination accordingly.
- ☑ The child restraint system must not be put under strain by the head restraint. Adjust the head restraints as appropriate.
- ☑ Make sure that the child's feet do not touch the front seat. If necessary, move the front seat slightly forwards.

The seat belts on the following seats are equipped with a child seat safety feature:

- Front passenger seat
- Rear seats

When enabled, the child seat safety feature ensures that the seat belts of the front passenger seat and rear seats do not slacken once the child restraint system is secured (→ page 55).

- ▶ Install the child restraint system. The entire base of the child restraint system must always rest on the sitting surface of the rear seat.
- ▶ Always make sure that the shoulder belt strap is correctly routed from the seat belt outlet of the vehicle to the shoulder belt guide on the child restraint system. The shoulder belt strap must be routed forward from the seat belt outlet.

### Notes on rearward-facing and forward-facing child restraint systems on the front passenger seat

**⚠ WARNING** Risk of injury or death when using a rearward-facing child restraint system while the front passenger airbag is enabled

If you secure a child in a rearward-facing child restraint system on the front passenger seat and the PASSENGER AIR BAG OFF indicator lamp is off, the front passenger airbag can deploy in the event of an accident.

The child could be struck by the airbag.

Always ensure that the front passenger airbag is disabled. The PASSENGER AIR BAG OFF indicator lamp must be lit.

NEVER use a rearward-facing child restraint system on a seat with an ENABLED FRONT AIRBAG. This can result in the DEATH of or SERIOUS INJURY to the CHILD.

Observe the specific instructions for the rearward-facing and forward-facing child restraint systems (→ page 61).

Always observe the status of the front passenger airbag on the PASSENGER AIR BAG OFF indicator lamp:

- When using a rearward-facing child restraint system on the front passenger seat, the front passenger airbag must always be disabled. This is only the case if the PASSENGER AIR BAG OFF indicator lamp is lit continuously (→ page 47).
- If the PASSENGER AIR BAG OFF indicator lamp is off, the front passenger airbag is enabled. The front passenger airbag may deploy during an accident.

### Securing the child restraint system with the seat belt on the front passenger seat

When installing a belt-secured child restraint system on the front passenger seat, always observe the following:

- ☑ Observe the notes on rearward-facing and forward-facing child restraint systems on the front passenger seat (→ page 60).
- ☑ Observe the child restraint system manufacturer's installation and operating instructions.
- ☑ When using a forward-facing child restraint system in weight category I: remove the head restraint from the respective seat, if possible.  
After the child restraint system has been removed, replace the head restraints again immediately and adjust them correctly.
- ☑ The backrest of the forward-facing child restraint system must, as far as possible, be resting on the seat backrest of the front passenger seat.
- ☑ If the head restraint of the child seat cannot be fully extended when it is installed in the

vehicle, this will result in restrictions on the maximum size setting for child restraint systems in weight category II or III.

Contact with the roof when the head restraint is fully extended and locked in place will not result in any restrictions on use.

- ☑ The child restraint system must not be put under strain between the roof and the seat cushion and/or be installed facing the wrong direction.
- ☑ The child restraint system must not be put under strain by the head restraint. Adjust the head restraints as appropriate.
- ☑ Never place objects (e.g. cushions) under or behind the child restraint system.

The seat belt on the front passenger side is equipped with a child seat safety feature.

When enabled, the child seat safety feature ensures that the seat belt does not slacken once the child seat is secured (→ page 55).

- ▶ Set the front passenger seat as far back as possible and move the seat into the highest position if possible.
- ▶ Fully retract the seat cushion length adjustment.
- ▶ Adjust the seat cushion inclination so that the front edge of the seat cushion is in the highest position and the rear edge of the seat cushion is in the lowest position.
- ▶ Set the seat backrest to the most vertical position possible.
- ▶ Install the child restraint system.  
The entire base of the child restraint system must always rest on the sitting surface of the front passenger seat.
- ▶ Always make sure that the shoulder belt strap is correctly routed from the seat belt outlet of the vehicle to the shoulder belt guide on the child restraint system.  
The shoulder belt strap must be routed forwards and downwards from the seat belt outlet.
- ▶ If necessary, adjust the seat belt outlet and the front passenger seat accordingly.

### Notes on pets in the vehicle

**⚠ WARNING** Risk of accident and injury due to animals left unsecured or unattended in the vehicle

If you leave animals in the vehicle unattended or unsecured, they could possibly press buttons or switches.

An animal may:

- Activate vehicle equipment and become trapped, for example
- Switch systems on or off and endanger other road users

Unsecured animals may be thrown around in the vehicle in the event of an accident or sudden steering and braking maneuvers and injure vehicle occupants in the process.

- ▶ Never leave animals in the vehicle unattended.
- ▶ Always correctly secure animals while driving, e.g. using a suitable animal carrier.



## SmartKey

### Function overview

**⚠ WARNING** Risk of accident and injury due to children left unattended in the vehicle

If children are left unsupervised in the vehicle, they could, in particular:

- open doors, thereby endangering other persons or road users.
- get out and be struck by oncoming traffic.
- operate vehicle equipment and become trapped, for example.

In addition, the children could also set the vehicle in motion, for example by:

- releasing the parking brake.
- changing the transmission position.
- starting the vehicle.

▶ Never leave children unattended in the vehicle.

- ▶ When leaving the vehicle, always take the SmartKey with you and lock the vehicle.
- ▶ Keep the vehicle SmartKey out of reach of children.

**! NOTE** Damage to the SmartKey caused by magnetic fields

- ▶ Keep the SmartKey away from strong magnetic fields.

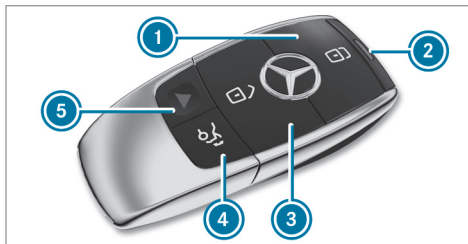

Vehicle SmartKey with panic alarm

① Locks

- ② Indicator lamp
- ③ Unlocks
- ④ Opens/closes the trunk lid
- ⑤ Panic alarm

ⓘ If indicator lamp ② does not light up after pressing the or button, the battery is weak or possibly discharged. Replace the battery as soon as possible.

Replace the SmartKey battery (→ page 65).

The SmartKey locks and unlocks the following components:

- Doors
- Fuel filler flap
- Trunk lid

If the vehicle is not opened within approximately 40 seconds after unlocking, it locks again. Anti-theft protection is armed again.

Do not keep the SmartKey together with electronic devices or metal objects. This can affect the SmartKey's functionality.

### Activating/deactivating the acoustic locking verification signal

Multimedia system:

→ Vehicle →  Vehicle Settings

→ Acoustic Lock

▶ Activate  or deactivate  the function.

### Activating/deactivating the panic alarm

#### Requirements:

- The ignition is switched off.





- ▶ **To activate:** press button ① for approximately one second. A visual and audible alarm is triggered.
  - ▶ **To deactivate:** briefly press button ① again.
- or
- ▶ Press the start/stop button on the cockpit, with the SmartKey inside the vehicle.

### Changing the unlocking settings

Possible unlocking functions of the SmartKey:

- Central unlocking
- Unlocking the driver's door and fuel filler flap

▶ **To switch between settings:** press the  and  buttons simultaneously for approximately six seconds until the indicator lamp flashes twice.

Options if the unlocking function for the driver's door and fuel filler flap has been selected:

- **To unlock the vehicle centrally:** press the  button twice.
- **Vehicles with KEYLESS-GO:** if you touch the inner surface of the door handle on the

driver's door, only the driver's door and fuel filler flap are unlocked.

### Deactivating the function of the SmartKey

**Vehicles with KEYLESS-GO:** If you deactivate the function of the SmartKey, the KEYLESS-GO functions are also deactivated. Access or drive authorization by KEYLESS-GO is then no longer possible with that particular SmartKey. Activate the function of the SmartKey so that all its functions will again be available.

You can also deactivate the function of the SmartKey to reduce the energy consumption of the SmartKey if you do not use the vehicle or a SmartKey for an extended period of time.

- ▶ **To deactivate:** press the  button on the SmartKey twice in quick succession. The SmartKey indicator lamp flashes twice briefly and lights up once.
- ▶ **To activate:** press any button on the SmartKey.

- i** When the vehicle is started with the SmartKey in the marked space of the center console, the function of the SmartKey is automatically activated (→ page 130).

### Removing/inserting the emergency key

#### Removing the emergency key

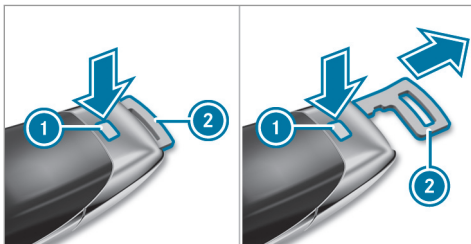

- ▶ Press release button **1**. Emergency key **2** is pushed out slightly.
- ▶ Pull out emergency key **2** until it engages in the intermediate position.
- ▶ Press release button **1** again and fully remove emergency key **2**.

#### Inserting the emergency key

- ▶ Press release button **1**.
  - ▶ Insert emergency key **2** to the intermediate position or fully until it engages.
- i** You can use the intermediate position of emergency key **2** to attach the SmartKey to a key ring.

#### Replacing the SmartKey battery

**⚠ DANGER** Risk of fatal injuries due to swallowing batteries

Batteries contain toxic and corrosive substances. Swallowing batteries may cause severe internal burns to occur within two hours.

There is a risk of fatal injury.

- ▶ Keep batteries out of the reach of children.
- ▶ If the cap and/or the battery compartment does not close securely, do not

use the SmartKey any longer and keep out of the reach of children.

- ▶ If batteries are swallowed, seek medical attention immediately.

**🔥 ENVIRONMENTAL NOTE** Environmental damage due to improper disposal of batteries



Batteries contain pollutants. It is illegal to dispose of them with the household rubbish.



Dispose of batteries in an environmentally responsible manner. Take discharged batteries to a qualified specialist workshop or to a collection point for used batteries.

**Requirements:**

- You require a CR 2032 3 V cell battery.

Mercedes-Benz recommends that you have the battery replaced at a qualified specialist workshop.

- ▶ Remove the emergency key (→ page 65).

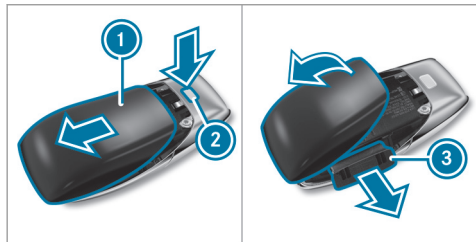

- ▶ Press release knob ② down fully and slide cover ① in the direction of the arrow.
- ▶ Fold out cover ① in the direction of the arrow and remove.
- ▶ Remove battery compartment ③ and take out the discharged battery.

- ▶ Insert the new battery into battery compartment ③. Observe the positive pole marking in the battery compartment and on the battery when doing this.
- ▶ Push in battery compartment ③.
- ▶ Re-attach cover ① and push it until it engages.

**Problems with the SmartKey, troubleshooting**

**You can no longer lock or unlock the vehicle**

Possible causes:

- The SmartKey battery is weak or discharged.
- ▶ Check the battery using the indicator lamp (→ page 63).
- ▶ Replace the SmartKey battery, if necessary (→ page 65).
- ▶ Use the replacement SmartKey.
- ▶ Use the emergency key to lock or unlock (→ page 69).

- ▶ Have the SmartKey checked at a qualified specialist workshop.

**There is interference from a powerful radio signal source**

Possible causes if the function of the SmartKey is impaired:

- High voltage power lines
- Mobile phones
- Electronic devices (notebooks, tablets)
- Shielding due to metal objects or induction loops for electrical gate systems or automatic barriers

- ▶ Make sure that there is sufficient distance between the SmartKey and the potential source of interference.

**You have lost a SmartKey**

- ▶ Have the SmartKey deactivated at a qualified specialist workshop.
- ▶ If necessary, have the mechanical lock replaced as well.

## Doors

## Unlocking/opening the doors from the inside

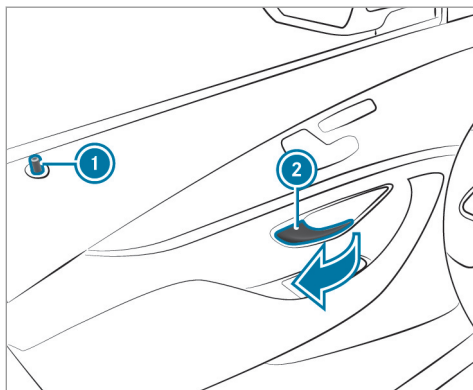

- ▶ Pull door handle (2).
- ▶ Locking pin (1) pops up when the door is unlocked.

## Centrally locking and unlocking the vehicle from the inside

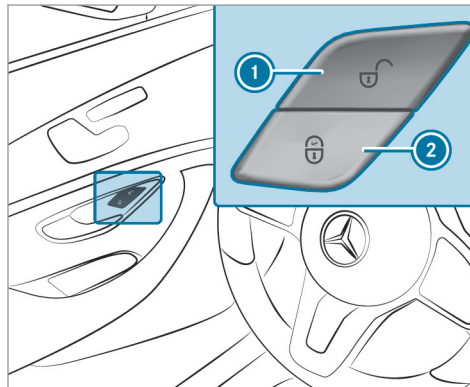

▶ **To unlock:** press button (1).

▶ **To lock:** press button (2).

- ⓘ The buttons are also on the front passenger door.

This does not lock or unlock the fuel filler flap.

The vehicle is not unlocked:

- If you have locked the vehicle using the SmartKey.
- If you have locked the vehicle using KEY-LESS-GO.

## Locking/unlocking the vehicle with KEY-LESS-GO

## Requirements:

- The SmartKey is outside the vehicle.
- The distance between the SmartKey and the vehicle does not exceed 3 ft (1 m).
- The driver's door and the door on which the door handle is used are closed.

**!** **NOTE** Damage to the vehicle caused by unintentionally opening the trunk lid

- When using an automatic car wash
- When using a high pressure cleaner

▶ Deactivate the function of the SmartKey in these situations.

or

- ▶ Make sure that the SmartKey is at a minimum distance of 10 ft (3 m) away from the vehicle.

Observe the following information:

- Information on washing the vehicle in a car wash (→ page 329)
- Notes on using a power washer (→ page 330)

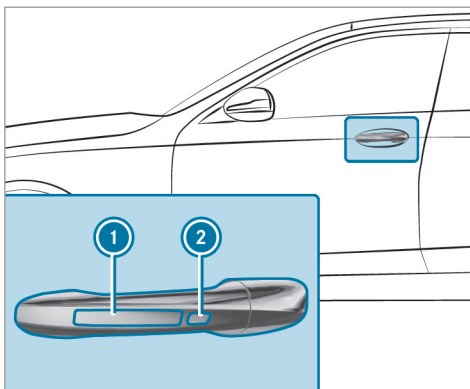

- ▶ **To unlock the vehicle:** touch the inner surface of the door handle.
- ▶ **To lock the vehicle:** touch sensor surface ① or ②.
- ▶ **Convenience closing:** touch recessed sensor surface ② until the closing process has been completed.

❗ Further information on convenience closing (→ page 78).

If you open the trunk lid from outside, the trunk lid is automatically unlocked.

### **Problems with KEYLESS-GO, troubleshooting**

#### **You can no longer lock or unlock the vehicle using KEYLESS-GO**

Possible causes:

- The function of the SmartKey has been deactivated.
  - The SmartKey battery is weak or discharged.
- ▶ Activate the function of the SmartKey (→ page 64).
  - ▶ Check the battery using the indicator lamp (→ page 63).
  - ▶ Replace the SmartKey battery, if necessary (→ page 65).
  - ▶ Use the replacement SmartKey.
  - ▶ Use the emergency key to lock or unlock (→ page 69).
  - ▶ Have the vehicle and SmartKey checked at a qualified specialist workshop.

### There is interference from a powerful radio signal source

Possible causes if the function of KEYLESS-GO is impaired:

- High voltage power lines
- Mobile phones
- Electronic devices (notebooks, tablets)
- Shielding due to metal objects or induction loops for electrical gate systems or automatic barriers

▶ Make sure that there is sufficient distance between the SmartKey and the potential source of interference.

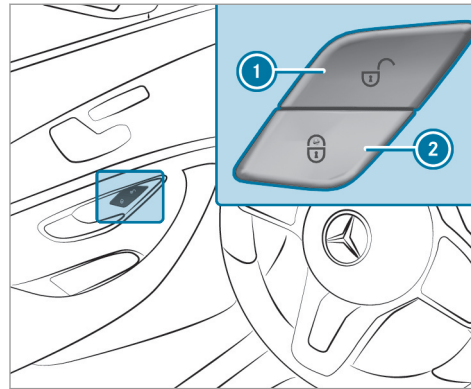

### Activating/deactivating the automatic locking feature

The vehicle is locked automatically when the ignition is switched on and the wheels are turning faster than walking pace.

- ▶ **To activate:** press and hold button ② for approximately five seconds until an acoustic signal sounds.
- ▶ **To deactivate:** press and hold button ① for approximately five seconds until an acoustic signal sounds.

In the following situations, there is a danger of being locked out when the function is activated:

- While the vehicle is being tow-started or pushed
- If the vehicle is being tested on a roller dynamometer

### Locking/unlocking the driver's door with the emergency key

- ① If you wish to lock the vehicle entirely using the emergency key, first press the button for locking from the inside while the driver's door is open. Then proceed to lock the driver's door using the emergency key.

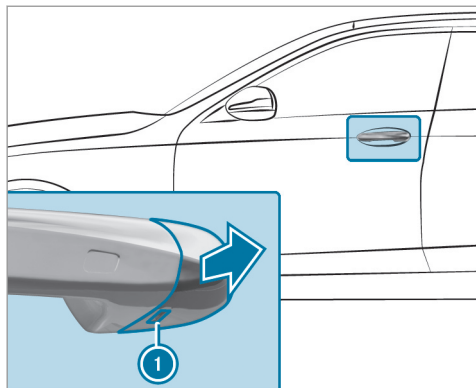

- ▶ Remove the emergency key (→ page 65).
- ▶ Insert the emergency key as far as it will go into opening ① in the cover.
- ▶ Pull and hold the door handle.
- ▶ Pull the cover on the emergency key as straight as possible away from the vehicle until it releases.
- ▶ Release the door handle.

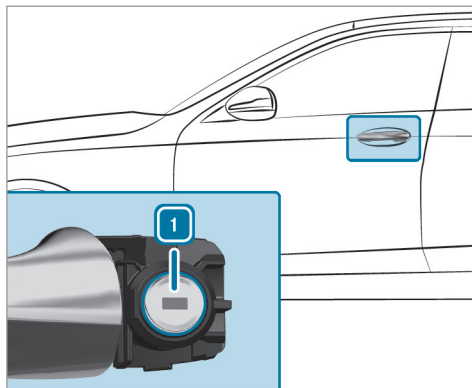

- ▶ **To unlock:** turn the emergency key counter-clockwise to position ①.
- ▶ **To lock:** turn the emergency key clockwise to position ①.
- ▶ Carefully press the cover onto the lock cylinder until it engages and is seated firmly.

## Trunk

### Opening the trunk lid

#### ⚠ DANGER Risk of exhaust gas poisoning

Combustion engines emit poisonous exhaust gases such as carbon monoxide. Exhaust gases can enter the vehicle interior if the trunk lid is open when the engine is running, especially if the vehicle is in motion.

- ▶ Always switch off the engine before opening the trunk lid.
- ▶ Never drive with the trunk lid open.

#### ! NOTE Damage to the trunk lid by obstacles above the vehicle

The trunk lid swings upwards when it is opened.

- ▶ Therefore, make sure that there is sufficient clearance above the trunk lid.

- ▶ **Vehicles with HANDS-FREE ACCESS:** Make a kicking movement with your foot below the bumper (→ page 73).



### Vehicles with trunk lid convenience closing

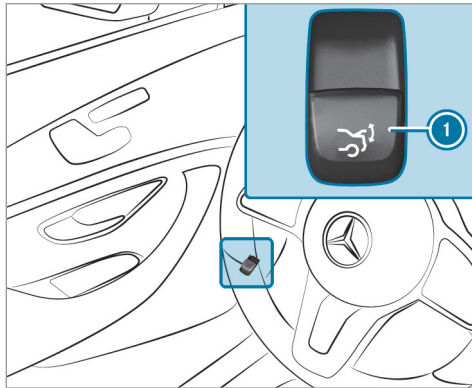

- ▶ Pull trunk lid remote operating switch ①.
- ▶ Press and hold the  button on the SmartKey.

- ▶ If the trunk lid is stopped in an intermediate position, pull it upwards. Release it as soon as it begins to open. With the trunk lid opening height restriction activated, manually pull the stopped trunk lid upwards.

If an obstacle obstructs the trunk lid during the automatic opening process, blockage detection will stop the trunk lid. The automatic blockage detection function is only an aid and is not a substitute for your attentiveness.

### Closing the trunk lid

**⚠ WARNING** Risk of injury from unsecured items in the vehicle

If objects, luggage or loads are not secured or not secured sufficiently, they could slip, tip over or be thrown around and thereby hit vehicle occupants.

There is a risk of injury, particularly in the event of sudden braking or a sudden change in direction.

- ▶ Always stow objects in such a way that they cannot be thrown around.
- ▶ Before the journey, secure objects, luggage or loads against slipping or tipping over.

Observe the notes on loading the vehicle.

**Notes on closing the trunk lid:** your vehicle is equipped with automatic SmartKey recognition. If a SmartKey belonging to the vehicle is detected in the vehicle, the trunk lid will not be locked and will pop open again.

Note that the trunk lid will not be locked if the following situation occurs:

- You have locked the vehicle and close the trunk lid while a SmartKey belonging to the vehicle is inside the vehicle.
- and
- A second SmartKey belonging to the vehicle is not detected outside the vehicle.

Automatic SmartKey recognition is only an aid and is not a substitute for your attentiveness.

- ▶ Before locking, ensure that at least one SmartKey belonging to the vehicle is outside the vehicle.
- ▶ **To close the trunk lid:** pull the trunk lid down using the handle recess and push it closed.

### Vehicles with trunk lid convenience closing

**⚠ WARNING** Risk of becoming trapped during automatic closing of the trunk lid

Parts of the body could become trapped. There may be people in the closing area.

- ▶ Make sure that nobody is in the vicinity of the closing area during the closing process.
- ▶ Use one of the following options to stop the closing process:
  - Press the  button on the SmartKey.
  - Press or pull the remote operating switch on the driver's door.
  - Press the closing or locking button on the trunk lid.

- ▶ **Vehicles with HANDS-FREE ACCESS:** it is also possible to stop the closing process by making a kicking movement below the rear bumper.
- ▶ Pull the trunk lid down using the handle recess and push it closed.
- ▶ If the trunk lid is stopped in an intermediate position, push it downwards. The trunk lid continues to close.

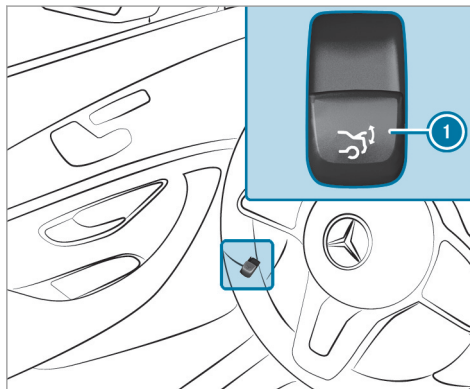

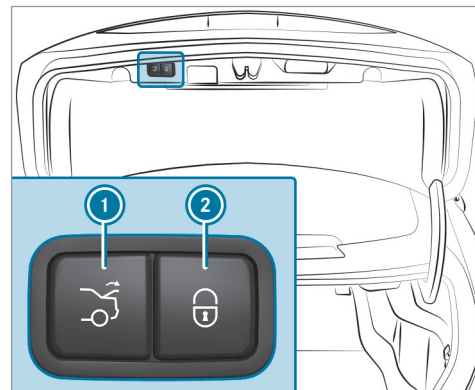

- ▶ Press trunk lid remote operating switch .



- ▶ Press closing button  on the trunk lid.

### Vehicles with KEYLESS-GO

- ▶ Press locking button  on the trunk lid. If a SmartKey is detected outside the vehicle, the trunk lid will close and the vehicle will be locked.

- ▶ With the trunk lid completely open, press and hold the  button on the SmartKey. The SmartKey must be in the vicinity of the vehicle.

### Vehicles with HANDS-FREE ACCESS

- ▶ With the trunk lid completely open, make a kicking movement with your foot below the bumper (→ page 73).

### Trunk lid automatic reversing function

The trunk lid is equipped with automatic blockage detection with a reversing function. If an obstacle obstructs the trunk lid during the automatic closing process, it will automatically open again. The automatic reversing function is only an aid and is not a substitute for your attentiveness.

- ▶ During the closing process, make sure that no body parts are in the closing area.

### **⚠ WARNING** Risk of becoming trapped despite reversing function

The reversing function will not react:

- to soft, light and thin objects, e.g. fingers
- towards the end of the closing procedure

In these situations in particular, the reversing function cannot prevent someone being trapped.

- ▶ Ensure that no body parts are in the closing area.

If someone is trapped:

- press the  button on the SmartKey, or
- press or pull the remote operating switch on the driver's door, or
- press the closing or locking button on the trunk lid.

### HANDS-FREE ACCESS function

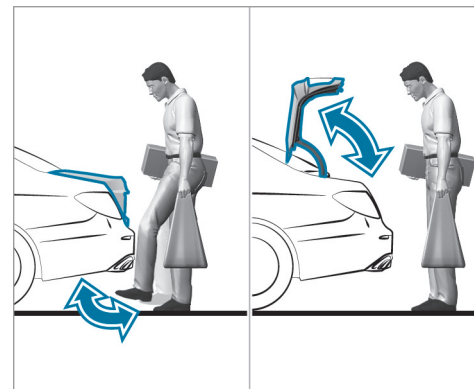

With HANDS-FREE ACCESS you can open, close or interrupt trunk lid movement by performing a kicking movement under the rear bumper.

The kicking movement triggers the opening or closing process alternately.

Observe the notes when opening (→ page 70) and closing (→ page 71) the trunk lid.

## 74 Opening and closing

- ① A warning tone sounds while the trunk lid is opening or closing.

### **⚠ WARNING** Risk of burns caused by a hot exhaust system

The vehicle exhaust system can become very hot. If you use HANDS-FREE ACCESS, you could burn yourself by touching the exhaust system.

- ▶ Always ensure that you only make a kicking movement within the detection range of the sensors.

### **! NOTE** Damage to the vehicle caused by unintentionally opening the trunk lid

- When using an automatic car wash
- When using a high pressure cleaner

- ▶ Deactivate the function of the SmartKey in these situations.

or

- ▶ Make sure that the SmartKey is at a minimum distance of 10 ft (3 m) away from the vehicle.

When making the kicking movement, make sure that you are standing firmly on the ground. You could otherwise lose your balance, e.g. on ice.

Observe the following notes:

- The SmartKey is behind the vehicle.
- Stand at least 12 in (30 cm) away from the vehicle while performing the kicking movement.
- Do not come into contact with the bumper while making the kicking movement.
- Do not carry out the kicking movement too slowly.
- The kicking movement must be towards the vehicle and back again.

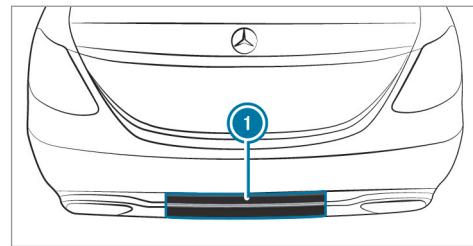

### ① Detection range of the sensors

If several consecutive kicking movements are not successful, wait ten seconds.

### System limits

The system may be impaired or may not function in the following cases:

- The sensors are dirty, e.g. due to road salt or snow.
- The kicking movement is made using a prosthetic leg.

The trunk lid could be opened or closed unintentionally, in the following situations:

- A person's arms or legs are moving in the sensor detection range, e.g. when polishing the vehicle or picking up objects.
- Objects are moved or placed behind the vehicle, e.g. tensioning straps or luggage.
- Clamping straps, tarps or other coverings are pulled over the bumper.
- A protective mat with a length reaching over the trunk sill down into the detection range of the sensors is used.
- The protective mat is not secured correctly.

Deactivate the function of the SmartKey (→ page 64) or do not carry the SmartKey about your person in such situations.

### Switching separate trunk locking on or off

If you centrally unlock the vehicle while separate locking is activated, the trunk will remain locked.

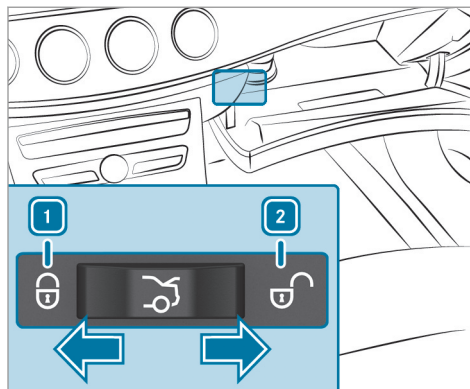

▶ **To switch on:** slide the switch to position **1**.

▶ **To switch off:** slide the switch to position **2**.

ⓘ If an accident has been detected, the trunk will unlock even if separate locking is switched on.

### Unlocking and opening the trunk from inside with the emergency release

#### Requirements:

- The 12 V vehicle battery is connected and charged.

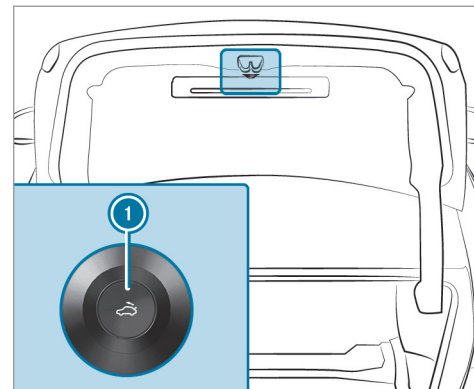

▶ Press emergency release button **1** briefly.

## Activating/deactivating the trunk lid opening height restriction

Multimedia system:

- ▶ Vehicle ▶  Vehicle Settings
- ▶▶ Trunk Lid Restriction

This function allows you to avoid bumping the trunk lid on a low garage ceiling, for example.

- ▶ Activate  or deactivate  the function.

## Side windows

### Opening and closing the side windows

**⚠ WARNING** Risk of entrapment when opening a side window

When opening a side window, parts of the body could be drawn in or become trapped between the side window and window frame.

- ▶ When opening, make sure that nobody is touching the side window.

- ▶ If someone is trapped, release the button immediately or pull it in order to close the side window again.

**⚠ WARNING** Risk of becoming trapped when closing a side window

When closing a side window, body parts could be trapped in the closing area in the process.

- ▶ When closing, make sure that no body parts are in the closing area.
- ▶ If someone is trapped, release the button immediately or press the button in order to reopen the side window.

**⚠ WARNING** Risk of becoming trapped when children operate the side windows

Children could become trapped if they operate the side windows, particularly when unattended.

- ▶ Never leave children unattended in the vehicle.

- ▶ When leaving the vehicle, always take the SmartKey with you and lock the vehicle.

### Requirements:

- The power supply or the ignition is switched on.

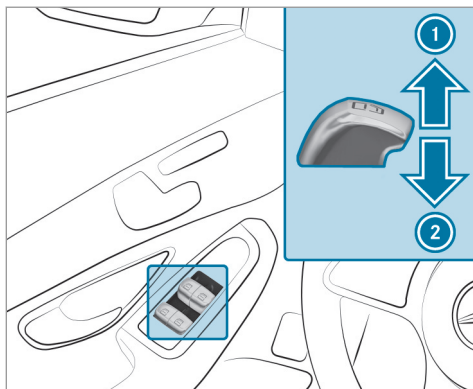

- ① Closing
- ② Opening

The buttons on the driver's door take precedence.

- ▶ **To start automatic operation:** press the  button beyond the point of resistance or pull and release it.

- ▶ **To interrupt automatic operation:** press or pull the  button again.

When the vehicle is switched off, you can continue to operate the side windows.

This function is available for around four minutes or until a door is opened.

#### Automatic reversing function of the side windows

If an obstacle impedes a side window during the closing process, the side window will open again automatically. The automatic reversing function is only an aid and is not a substitute for your attentiveness.

- ▶ During the closing process, make sure that no body parts are in the closing area.

**⚠ WARNING** Risk of becoming trapped despite there being reversing protection on the side window

The reversing function does not react:

- To soft, light and thin objects, e.g. fingers.

- During resetting.

The reversing function cannot prevent someone from becoming trapped in these situations.

- ▶ During the closing process, make sure that no body parts are in the closing area.
- ▶ If someone becomes trapped, press the  button to open the side window again.

#### Convenience opening (ventilating the vehicle before starting a journey)

**⚠ WARNING** Risk of entrapment when opening a side window

When opening a side window, parts of the body could be drawn in or become trapped between the side window and window frame.

- ▶ When opening, make sure that nobody is touching the side window.

- ▶ Release the button immediately if somebody becomes trapped.

▶ Press and hold the  button on the SmartKey.

The following functions are performed:

- The vehicle is unlocked.
- The side windows are opened.
- The panoramic sliding roof is opened.
- The seat ventilation of the driver's seat is switched on.

ⓘ If the roller sunblind of the panoramic sliding sunroof is closed, the roller sunblind is opened first.

▶ **To interrupt convenience opening:** release the  button.

▶ **To continue convenience opening:** press and hold the  button again.

### Convenience closing (closing the vehicle from outside)

**⚠ WARNING** Risk of entrapment due to not paying attention during convenience closing

When the convenience closing feature is operating, parts of the body could become trapped in the closing area of the side window and the sliding sunroof.

- ▶ When the convenience closing feature is operating, monitor the entire closing process and make sure that no body parts are in the closing area.

▶ Press and hold the  button on the SmartKey.

The following functions are performed:

- The vehicle is locked.
- The side windows are closed.
- The panoramic sliding roof is closed.

▶ **To interrupt convenience closing:** release the  button.

▶ **To continue convenience closing:** press and hold the  button again.

ⓘ Convenience closing also functions with KEYLESS-GO (→ page 67).

### Resolving problems with the side windows

**⚠ WARNING** Risk of becoming trapped or fatally injured if reversing protection is not activated

If you close a side window again immediately after it has been blocked, the side window will close with increased or maximum force. The reversing function is then not active and body parts may become trapped.

- ▶ Make sure that no parts of the body are in the closing area.
- ▶ To stop the closing process, release the button or press the button again to reopen the side window.



**A side window cannot be closed and you cannot see the cause.**

- ▶ Check to see whether any objects are in the window guide.
- ▶ Adjust the side windows.

**Adjusting the side windows**

If a side window is obstructed during closing and reopens again immediately:

- ▶ Immediately after this, pull and hold the corresponding button again until the side window has closed and hold the button for at least one more second (re-adjustment). The side window will be closed without the automatic reversing function.

If the side window is obstructed again and reopens again immediately:

- ▶ Immediately after this, pull and hold the corresponding button again until the side window has closed and hold the button for at

least one more second (follow-up adjustment).  
The side window will be closed without the automatic reversing function.

**The side windows cannot be opened or closed using the convenience opening feature.**

Possible causes:

- The SmartKey battery is weak or discharged.
- ▶ Check the battery using the indicator lamp (→ page 63).
- ▶ Replace the SmartKey battery, if necessary (→ page 65).

**Sliding sunroof**

**Opening and closing the sliding sunroof**

- ⓘ The term "sliding sunroof" also refers to the panorama roof with power tilt/sliding panel.

**⚠ WARNING** Risk of becoming trapped when the sliding sunroof is being opened and closed

Body parts may become trapped in the range of movement.

- ▶ During opening and closing, make sure that no body parts are in the range of movement.
- ▶ Release the button immediately if somebody becomes trapped.

or

- ▶ Briefly press the button in any direction during automatic operation.  
The opening or closing process will be stopped.

**⚠ WARNING** Risk of becoming trapped if the sliding sunroof is operated by children

Children operating the sliding sunroof could get caught in the moving parts, particularly if unattended.

- ▶ Never leave children unattended in the vehicle.
- ▶ When leaving the vehicle, always take the key with you and lock the vehicle.

**⚠ WARNING** Risk of becoming trapped when the roller sunblind is being opened and closed

Body parts may become trapped between the roller sunblind and frame or sliding roof.

- ▶ When opening or closing, make sure that no body parts are in the roller sunblind's range of movement.
- ▶ Release the button immediately if somebody becomes trapped.

or

- ▶ Briefly press the button in any direction during automatic operation. The opening or closing process will be stopped.

**! NOTE** Malfunction due to snow and ice

Snow and ice may cause the sliding sunroof to malfunction.

- ▶ Open the sliding sunroof only if it is free of snow and ice.

**! NOTE** Damage caused by protruding objects

Objects that protrude from the sliding sunroof may damage the sealing strips.

- ▶ Do not allow anything to protrude from the sliding sunroof.

**! NOTE** Important points to remember when a roof luggage rack is installed

When a roof luggage rack is installed, raising or opening the sliding sunroof may be limited.

- ▶ Check whether the sliding sunroof can be raised or opened when a roof luggage rack is installed.

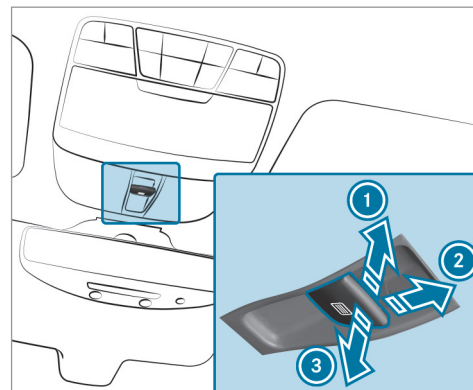

- ▶ If in doubt, do not raise or open the sliding sunroof.



- ① To raise
- ② To open
- ③ To close/lower

Use the  button to operate the panorama roof with power tilt/sliding panel and the roller sunblind.

The panorama roof with power tilt/sliding panel can be operated only when the roller sunblind is open.

- ▶ Check whether the sliding sunroof can be raised or opened when a roof luggage rack is installed.
- ▶ **To start automatic operation:** press the  button beyond the point of resistance or pull and release it.
- ▶ **To interrupt automatic operation:** briefly press the  button in any direction. The opening/closing process will be stopped.

**Vehicles with a panorama roof with power tilt/sliding panel:** The automatic raising feature is available only when the sliding sunroof is closed or raised.

### Automatic reversing function of the sliding sunroof

If an obstacle obstructs the sliding sunroof during the closing process, the sliding sunroof will open again automatically. The automatic reversing function is only an aid and is not a substitute for your attentiveness.

- ▶ During the closing process, make sure that no body parts are in the closing area.

**⚠ WARNING** Risk of becoming trapped despite the reversing function being active

In particular, the reversing function does not react:

- To soft, light and thin objects, e.g. fingers.
- Towards the end of the closing procedure.
- During resetting.

- ▶ During the closing process, make sure that no body parts are in the closing area.

- ▶ Release the button immediately if somebody becomes trapped.

or

- ▶ Briefly press the button in any direction during automatic operation. The closing process will be stopped.

### Automatic reversing function of the roller sunblind

If an obstacle obstructs the roller sunblind during the closing process, the roller sunblind will open again automatically. The automatic reversing function is only an aid and is not a substitute for your attentiveness.

- ▶ When closing the roller sunblind, make sure that no body parts are in the range of movement.

**⚠ WARNING** Risk of becoming trapped despite reversing function

In particular, the reversing function does not react to soft, light and thin objects, e.g. fingers.

- ▶ When closing the roller sunblind, make sure that no body parts are in the range of movement.
- ▶ Release the button immediately if somebody becomes trapped.

or

- ▶ Briefly press the button in any direction during the automatic closing process. The closing process will be stopped.

### Automatic functions of the sliding sunroof

- ① The term "sliding sunroof" also refers to the panorama roof with power tilt/sliding panel.

#### Rain closing function when driving

**Vehicles with a panorama roof with power tilt/sliding panel:** If it starts to rain, the raised sliding sunroof will automatically be lowered while the vehicle is in motion.

#### Automatic lowering function

**Vehicles with a panorama roof with power tilt/sliding panel:** If the sliding sunroof is raised at the rear, it will automatically be lowered

slightly at higher speeds. At low speeds, it will be raised again automatically.

**⚠ WARNING** Risk of becoming trapped by automatic lowering of the sliding sunroof

At higher speeds, the raised sliding sunroof will automatically be lowered slightly at the rear.

- ▶ Make sure that nobody reaches into the sliding sunroof's range of movement while the vehicle is in motion.
- ▶ If somebody becomes trapped, briefly push the sliding sunroof button forwards or backwards.

- ① By pushing or pulling the  button, you can interrupt the automatic functions: "Rain closing function when driving" and "Automatic lowering".

### Rectifying problems with the sliding sunroof

**⚠ WARNING** Risk of becoming trapped or fatal injuries when the sliding sunroof is closed again

If the sliding sunroof is closed again immediately after it has been blocked or reset, it will close with increased force.

- ▶ Make sure that no parts of the body are in the closing area.
- ▶ Release the button immediately if somebody becomes trapped.

or

- ▶ Briefly press the button in any direction during the automatic closing process. The closing process will be stopped.

**The sliding sunroof cannot be closed and you cannot see the cause.**

- ① The term "sliding sunroof" also refers to the panorama roof with power tilt/sliding panel.

If the sliding sunroof is obstructed during closing and reopens again slightly:

- ▶ Immediately after automatic reversing, pull and hold the  button down again to the point of resistance until the sliding sunroof is closed.  
The sliding sunroof will be closed with increased force.



If the sliding sunroof is obstructed again and opens again slightly:

- ▶ Repeat the previous step.  
The sliding sunroof will be closed again with increased force.

**Vehicles with a panorama roof with power tilt/sliding panel: The sliding sunroof or the roller sunblind is not operating smoothly.**

- ▶ Reset the sliding sunroof and the roller sunblind.

**Resetting the sliding sunroof and the roller sunblind**

- ▶ Pull and hold the  button little by little until the sliding sunroof is fully closed.
- ▶ Pull and hold the  button little by little until the roller sunblind is fully closed.

- ▶ Use automatic operation to fully open and then close the sliding sunroof.

### Anti-theft protection

#### Function of the immobilizer

The immobilizer prevents your vehicle from being started without the correct SmartKey.

The immobilizer is automatically activated when the ignition is switched off and deactivated when the ignition is switched on.

When leaving the vehicle, always take the SmartKey with you and lock the vehicle. Anyone can start the engine if a valid SmartKey has been left inside the vehicle.

- ⓘ In the event the engine cannot be started (yet the vehicle's battery is charged), the system is not operational. Contact an authorized Mercedes-Benz Center or call 1-800-FOR-MERCEdes (in the USA) or 1-800-387-0100 (in Canada).

### ATA (anti-theft alarm system)

#### Function of the ATA system

If the ATA system is armed, a visual and audible alarm is triggered in the following situations:

- When a door is opened
- When the trunk lid is opened
- When the hood is opened
- When the interior motion sensor is triggered (→ page 85)
- When the tow-away alarm is triggered (→ page 84)

The ATA system is armed automatically after approximately ten seconds in the following situations:

- After locking the vehicle with the SmartKey
- After locking the vehicle using KEYLESS-GO

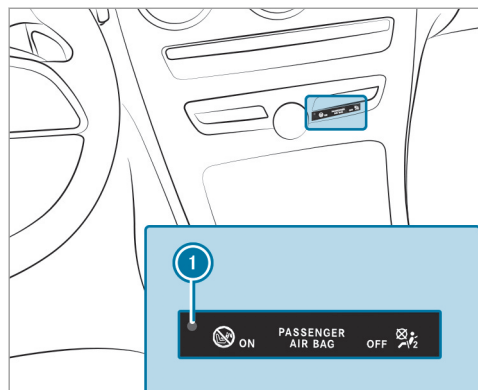

Indicator lamp ① flashes when the ATA system is armed.

The ATA system is deactivated automatically in the following situations:

- After unlocking the vehicle with the SmartKey
- After unlocking the vehicle using KEYLESS-GO

- After pressing the start/stop button with the SmartKey in the marked space (→ page 130)

- ① When the Mercedes-Benz emergency call system is active and the alarm stays on for more than 30 seconds, a message is automatically sent to the Customer Assistance Center (→ page 295).
- ① In the case of severe battery discharging, the anti-theft alarm system is automatically deactivated to facilitate the next engine start.

#### Deactivating the ATA

- ▶ Press the , or button on the SmartKey.

or

- ▶ Press the start/stop button with the SmartKey in the stowage compartment (→ page 130)

#### Deactivating the alarm using KEYLESS-GO

- ▶ Grasp the outside door handle with the SmartKey outside the vehicle.

#### Function of the tow-away alarm

- ① This function may not be available in all countries.

An audible and visual alarm is triggered if an alteration to your vehicle's angle of inclination is detected while the tow-away alarm is armed.

The tow-away alarm is automatically armed after approximately 60 seconds:

- After locking the vehicle with the SmartKey
- After locking the vehicle using KEYLESS-GO

The tow-away alarm is only armed when the following components are closed:

- Doors
- Trunk lid

The tow-away alarm is automatically deactivated:

- After pressing the or button on the SmartKey
- After pressing the start/stop button with the SmartKey in the storage compartment (→ page 130)

- After unlocking the vehicle using KEYLESS-GO
- When using HANDS-FREE ACCESS

Information on collision detection on a parked vehicle (→ page 153).

### Arming/disarming the tow-away alarm

Multimedia system:

↳ Vehicle ▶  Vehicle Settings  
 ▶▶ Tow-away Protection

▶ Activate  or deactivate  the function.

The tow-away alarm is armed again in the following cases:

- The vehicle is unlocked again.
- A door is opened.
- The vehicle is locked again.

### Function of the interior motion sensor

 This function may not be available in all countries.

When the interior motion sensor is activated, a visual and audible alarm is triggered if movement is detected in the vehicle interior.



The interior motion sensor is activated automatically after approximately ten seconds:

- After locking the vehicle with the SmartKey
- After locking the vehicle using KEYLESS-GO

The interior motion sensor is only activated when the following components are closed:

- Doors
- Trunk lid

The interior motion sensor is automatically deactivated:

- After pressing the  or  button on the SmartKey
- After pressing the start/stop button with the SmartKey in the marked space (→ page 130)
- After unlocking the vehicle using KEYLESS-GO
- When using HANDS-FREE ACCESS

The following situations can lead to a false alarm:

- Moving objects such as mascots in the vehicle interior
- When a side window is open
- When a panoramic sliding sunroof is open

### Activating/deactivating the interior motion sensor

Multimedia system:

↳ Vehicle ▶  Vehicle Settings  
 ▶▶ Interior Motion Sensor

▶ Activate  or deactivate  the function.

The interior motion sensor is activated again in the following cases:

- The vehicle is unlocked again.
- A door is opened.
- The vehicle is locked again.

### Notes on the correct driver's seat position

**⚠ WARNING** Risk of accident due to adjusting the vehicle settings while the vehicle is in motion

You could lose control of the vehicle in the following situations in particular:

- If you adjust the driver's seat, the head restraint, the steering wheel or the mirror while the vehicle is in motion
  - If you fasten your seat belt while the vehicle is in motion
- Before starting the engine: In particular, adjust the driver's seat, head restraint, steering wheel and mirror, and fasten your seat belt.

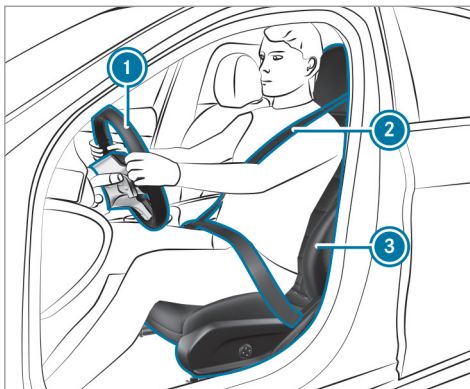

Ensure the following when adjusting steering wheel ①, seat belt ② and driver's seat ③:

- You are sitting as far away from the driver's airbag as possible, taking the following points into consideration:
- You are sitting in an upright position
- Your thighs are slightly supported by the seat cushion

- Your legs are not fully extended and you can depress the pedals properly
- The back of your head is supported at eye level by the center of the head restraint
- You can hold the steering wheel with your arms slightly bent
- You can move your legs freely
- You can see all the displays on the instrument cluster clearly
- You have a good overview of the traffic conditions
- Your seat belt sits snugly against your body and passes across the center of your shoulder and across your hips in the pelvic area



## Seats

### Adjusting the front seat manually and electrically (without Seat Comfort Package)

**⚠ WARNING** Risk of becoming trapped if the seats are adjusted by children

Children could become trapped if they adjust the seats, particularly when unattended.

- ▶ When leaving the vehicle, always take the SmartKey with you and lock the vehicle.
- ▶ Never leave children unattended in the vehicle.

You can adjust the seats when the ignition is switched off.

**⚠ WARNING** Risk of becoming trapped when adjusting the seat

When you adjust a seat, you or other vehicle occupants could become trapped, e.g. on the seat guide rail.

- ▶ When adjusting a seat, make sure that no one has any part of their body within the sweep of the seat.

Observe the safety notes on "Airbags" and "Children in the vehicle".

**⚠ WARNING** Risk of accident due to the driver's seat not being engaged

The driver's seat may move unexpectedly while driving.

This could cause you to lose control of the vehicle.

- ▶ Always make sure that the driver's seat is engaged before starting the vehicle.

**⚠ WARNING** Risk of accident due to adjusting the vehicle settings while the vehicle is in motion

You could lose control of the vehicle in the following situations in particular:

- If you adjust the driver's seat, the head restraint, the steering wheel or the mirror while the vehicle is in motion
- If you fasten your seat belt while the vehicle is in motion

- ▶ Before starting the engine: In particular, adjust the driver's seat, head restraint, steering wheel and mirror, and fasten your seat belt.

**⚠ WARNING** Risk of becoming trapped if the seat height is adjusted carelessly

If you adjust the seat height carelessly, you or other vehicle occupants could be trapped and thereby injured.

Children in particular could accidentally press the electrical seat adjustment buttons and become trapped.

- ▶ While moving the seats, make sure that hands or other body parts do not get under the lever assembly of the seat adjustment system.

**⚠ WARNING** Risk of injury due to head restraints not being installed or being adjusted incorrectly

If head restraints have not been installed or have not been adjusted correctly, there is an increased risk of injury in the head and neck area, e.g. in the event of an accident or when braking.

- ▶ Always drive with the head restraints installed.
- ▶ Before driving off, make sure for every vehicle occupant that the center of the head restraint supports the back of the head at about eye level.

Do not interchange the head restraints of the front and rear seats. Otherwise, you will not be able to adjust the height and angle of the head restraints correctly.

Adjust the head restraint fore-and-aft position so that it is as close as possible to the back of your head.

**⚠ WARNING** Risk of injury or death due to an incorrect seat position

The seat belt does not offer the intended level of protection if you have not moved the seat backrest to an almost vertical position.

In particular, you could slip beneath the seat-belt and become injured.

- ▶ Adjust the seat properly before beginning your journey.
- ▶ Always ensure that the seat backrest is in an almost vertical position and that the shoulder belt is routed across the center of your shoulder.

**⚠ WARNING** Risk of injury due to excessive strain on the grab handle

If you apply your full body weight to the grab handle or pull it abruptly, the grab handle may be damaged or become loose from its anchorage.

- ▶ Use the grab handles only to stabilize the seating position or to assist in getting in and out of the seat.

**⚠ WARNING** Risk of injury or death due to objects under the co-driver seat

Objects trapped under the co-driver seat can interfere with the function of the automatic co-driver airbag shutoff or damage the system.

- ▶ Do not store any objects under the co-driver seat.
- ▶ When the co-driver seat is occupied, make sure that no objects are trapped under the co-driver seat.

**!** **NOTE** Damage to the seats when moving the seats back

The seats may be damaged by objects when moving the seats back.

- ▶ When moving the seats back, make sure that there are no objects in the footwell, under or behind the seats.

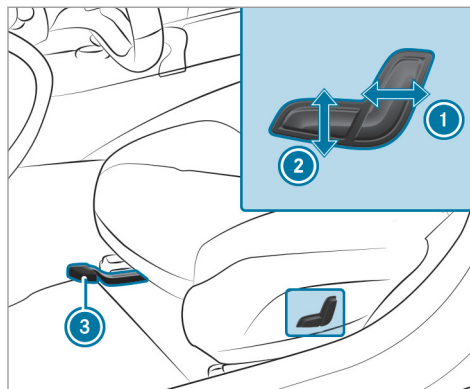

- ① Seat backrest inclination
- ② Seat height
- ③ Seat fore-and-aft position

▶ **To adjust the seat fore-and-aft position:** lift lever ③ and slide the seat into the desired position.

▶ Make sure that the seat is engaged.

### Adjusting the front seat electrically

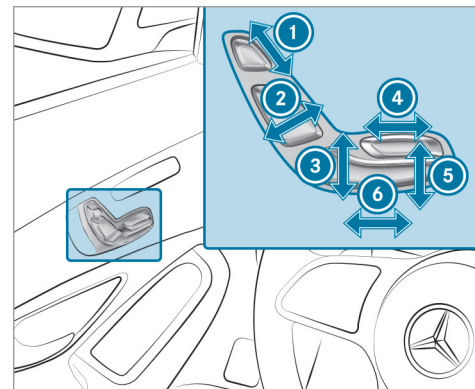

- ① Head restraint height
- ② Seat backrest inclination
- ③ Seat height
- ④ Seat cushion length
- ⑤ Seat cushion inclination
- ⑥ Seat fore-and-aft position

- ▶ Save the settings with the memory function (→ page 99).

### Adjusting the 4-way lumbar support

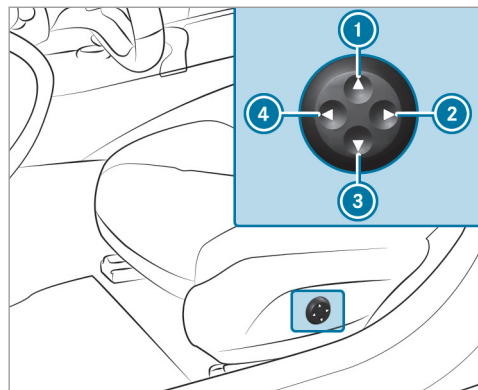

- ① Higher
- ② Softer
- ③ Lower
- ④ Firmer

- ▶ Using buttons ① to ④, adjust the contour of the backrest individually to suit your back.

### Head restraints

#### Adjusting the front seat head restraints manually

- ⚠ **WARNING** Risk of accident due to adjusting vehicle settings while the vehicle is in motion

You could lose control of the vehicle in the following situations in particular:

- If you adjust the driver's seat, the head restraints, the steering wheel or the mirror while the vehicle is in motion.
- If you fasten your seat belt while the vehicle is in motion.

- ▶ Before starting the engine: adjust the driver's seat, the head restraints, the steering wheel and the mirror and fasten your seat belt.

- ⚠ **WARNING** Risk of injury due to head restraints not being installed or being adjusted incorrectly

If head restraints have not been installed or have not been adjusted correctly, there is an increased risk of injury in the head and neck area, e.g. in the event of an accident or when braking.

- ▶ Always drive with the head restraints installed.
- ▶ Before driving off, make sure for every vehicle occupant that the center of the head restraint supports the back of the head at about eye level.

Do not interchange the head restraints of the front and rear seats. Otherwise, you will not be able to adjust the height and angle of the head restraints correctly.

Adjust the head restraint fore-and-aft position so that it is as close as possible to the back of your head.

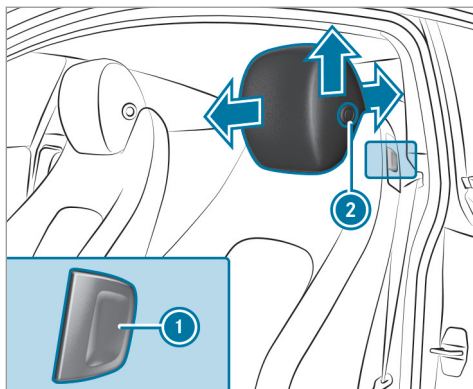

- ▶ **To raise:** pull the head restraint up.
- ▶ **To lower:** press release knob ① in the direction of the arrow and push the head restraint down.
- ▶ **To move forwards:** pull the head restraint forwards.
- ▶ **To move backwards:** press and hold release knob ②.

- ▶ Push the head restraint backwards and let go of release knob ②.

#### Adjusting the head restraints of the rear seats mechanically

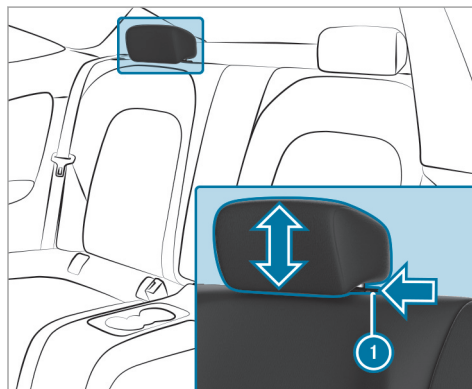

- ▶ **To raise:** pull the head restraint up.
- ▶ **To lower:** press release knob ① in the direction of the arrow and push the head restraint down.

#### Installing/removing the rear seat head restraints

##### Removing

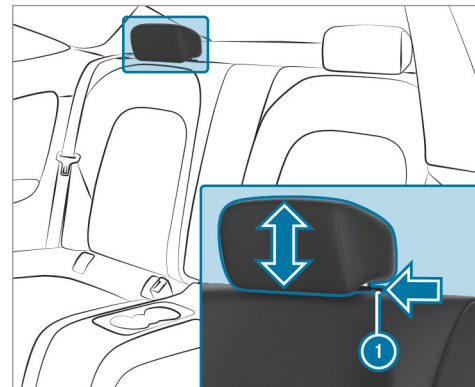

- ▶ Release the rear seat backrest and fold it forwards slightly (→ page 102).
- ▶ Pull the head restraint upwards as far as it will go.

- ▶ Push release knob  in the direction of the arrow and pull out the head restraint.

### Installing

- ▶ Insert the head restraint such that the notches on the bar are on the left when viewed in the direction of travel.
- ▶ Push the head restraint down until it engages.
- ▶ Fold the rear seat backrest back until it engages.

### Configuring the seat settings

---

Multimedia system:

  ▶▶ Comfort ▶▶ Seat Comfort

- ▶ Select a seat.

### Adjusting the backrest side bolsters

- ▶ Select **Side Bolsters**.
- ▶ Adjust the air cushions.

### Adjusting the backrest contour in the lumbar region of the seat backrest (lumbar)

- ▶ Select **Lumbar**.
- ▶ Adjust the air cushions.

### Selecting the massage program for the front seats

---

Multimedia system:

 **Vehicle** ▶▶  **Seats**

- ▶ Select **Driver's Seat** or **Passenger**.
- ▶ Select **Massage**.
- ▶ Select a massage program.  
The massage program runs for approximately 9 to 15 minutes, depending on the setting.
- ▶ **To set the massage intensity:** switch **High Intensity** on  or off .

### Resetting seat settings

---

Multimedia system:

 **Vehicle** ▶▶  **Seats** ▶▶ **Reset**

- ▶ Select **Yes** or **No**.

Depending on whether the settings for the driver's or front passenger seat are selected, only the selected seat can be reset.

### Folding the front seat backrest forwards/back (vehicles with memory function)

---

If you fold the seat backrest forwards, the seat will move forwards with the EASY-ENTRY function. This allows passengers to get into and out of the rear passenger compartment comfortably.



- ▶ **To fold forward:** pull seat release handle ❶ and fold the seat backrest forwards as far as it will go. The seat will automatically move to the foremost position.
- ▶ **To fold back:** swing the seat backrest back horizontally. If the seat backrest is not engaged, this will be shown on the multifunction display on the

instrument cluster. A warning tone will also sound.

The seat will automatically move to the stored position.

### Folding the front seat backrest forwards/backwards (vehicles without memory function)

#### Folding forwards

If you fold the seat backrest forwards, the seat will move forwards with the EASY-ENTRY function. This allows passengers to get into and out of the rear passenger compartment comfortably.

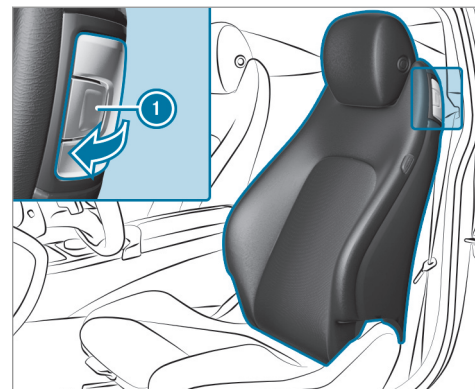

- ▶ If necessary, release the head restraint and push it down.
- ▶ Pull seat release handle ❶ and fold the seat backrest forwards until the seat backrest engages.
- ▶ Push the seat as far forwards as it will go.

### Folding back

- ▶ Push the seat back horizontally by the seat backrest until it reaches the seat position that was previously set.
- ▶ Fold the seat backrest back until it engages. Do so as smoothly as possible. If the seat backrest is not engaged, this will be shown on the multifunction display or the instrument cluster. A warning tone will also sound.
- ▶ After the seat backrest has been folded back, check the position of the head restraint and set it to the correct position.

If the set seat position can no longer be reached, e.g. because of luggage in the rear footwell or because occupants have entered the rear of the vehicle:

- ▶ Pull seat release handle ① again and return the seat backrest to an upright position. The seat will lock in the new fore-and-aft position.

### Switching the seat heating on/off

**⚠ WARNING** Risk of burns due to repeatedly switching on the seat heating

Repeatedly switching on the seat heating can cause the seat cushion and seat backrest padding to become very hot.

In particular, the health of persons with limited temperature sensitivity or a limited ability to react to high temperatures may be affected or they may even suffer burn-like injuries.

- ▶ Do not repeatedly switch on the seat heating.

To protect against overheating, the seat heating may be temporarily deactivated after it is switched on repeatedly.

**! NOTE** Damage to the seats caused by objects or documents when the seat heating is switched on

When the seat heating is switched on, overheating may occur due to objects or docu-

ments placed on the seats, e.g. seat cushions or child seats. This could cause damage to the seat surface.

- ▶ Make sure that no objects or documents are on the seats when the seat heating is switched on.

### Requirements:

- The power supply is switched on.

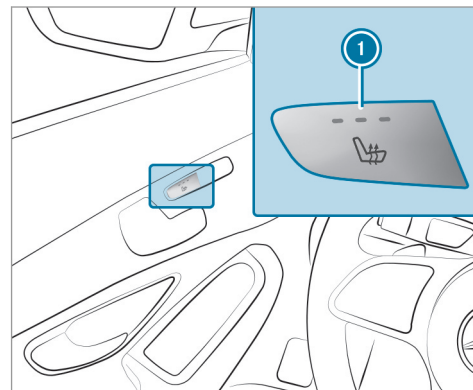



- ▶ Press button ❶ repeatedly until the desired heating level is set. Depending on the heating level, up to three indicator lamps will light up. If all indicator lamps are off, the seat heating is switched off.
- ❶ The seat heating will automatically switch down from the three heating levels after 8, 10 and 20 minutes until the seat heating is switched off.

### Switching the seat ventilation on/off

#### Requirements:

- The power supply is switched on.

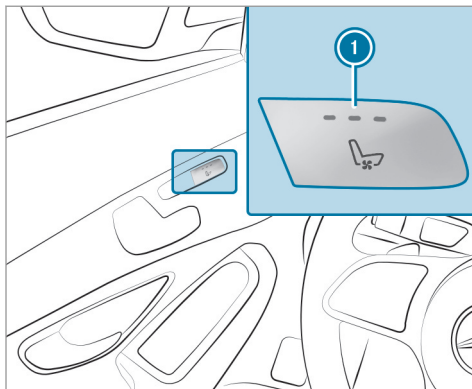

- ▶ Press button ❶ repeatedly until the desired blower setting has been reached. Depending on the blower setting, up to three indicator lamps will light up. If all indicator lamps are off, the seat ventilation is switched off.

### Steering wheel

#### Adjusting the steering wheel mechanically

- ⚠ **WARNING** Risk of accident due to adjusting the vehicle settings while the vehicle is in motion

You could lose control of the vehicle in the following situations in particular:

- If you adjust the driver's seat, the head restraint, the steering wheel or the mirror while the vehicle is in motion
- If you fasten your seat belt while the vehicle is in motion

- ▶ Before starting the engine: In particular, adjust the driver's seat, head restraint, steering wheel and mirror, and fasten your seat belt.

- ⚠ **WARNING** Risk of entrapment for children when adjusting the steering wheel

Children could injure themselves if they adjust the steering wheel.

- ▶ Never leave children unattended in the vehicle.
- ▶ When leaving the vehicle, always take the SmartKey with you and lock the vehicle.

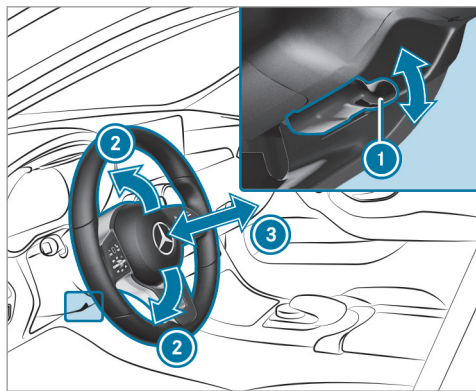

- ▶ **To unlock:** push release lever ① down as far as it will go.

- ▶ Adjust height ② and distance ③ to the steering wheel.
- ▶ **To lock:** push release lever ① up as far as it will go.
- ▶ Check and make sure that the steering column is locked by moving the steering wheel.

#### Adjusting the steering wheel electrically

The steering wheel can be adjusted when the power supply is disconnected.

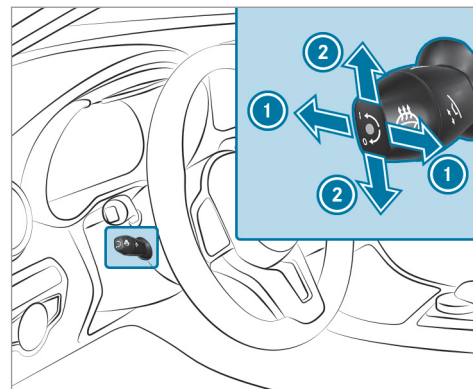

- ① To adjust the distance to the steering wheel
- ② To adjust the height
- ▶ Save the settings with the memory function (→ page 99).

### Switching the steering wheel heater on/off

#### Requirements:

- The ignition is switched on.

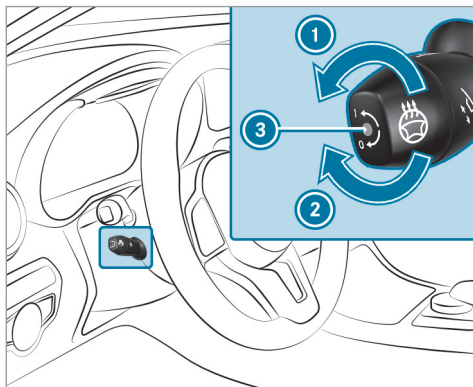

- Turn the lever in the direction of arrow ① or ②. If indicator lamp ③ lights up, the steering wheel heater is switched on.

When you switch the ignition off, the steering wheel heater will switch off.

### Easy entry and exit feature

#### Using the easy entry and exit feature

**⚠ WARNING** Risk of accident when pulling away during the adjustment process for the easy exit feature

You could lose control of the vehicle.

- Always wait until the adjustment process is complete before pulling away.

**⚠ WARNING** Risk of becoming trapped during adjustment of the easy entry and exit feature

You and other vehicle occupants – particularly children – could become trapped.

- Ensure that no one has a body part in the sweep of the steering wheel or driver's seat.

If there is a risk of becoming trapped by the steering wheel:

- Move the adjustment lever of the steering wheel. The adjustment process will be stopped.

If there is a risk of becoming trapped by the driver's seat:

- Press the seat adjustment switch. The adjustment process will be stopped.
- Never leave children unattended in the vehicle.
- When leaving the vehicle, always take the SmartKey with you and lock the vehicle.

You can stop the adjustment process by pressing one of the memory function position switches.

**⚠ WARNING** Risk of becoming trapped if children activate the easy entry and exit feature-

Children could become trapped if they activate the easy entry- and exit feature, particularly when unattended.

- ▶ Never leave children unattended in the vehicle.
- ▶ When leaving the vehicle, always take the SmartKey with you and lock the vehicle.

If the easy entry and exit feature is active, the steering wheel will move upwards and the driver's seat will move back in the following situations:

- You switch the ignition off with the driver's door open
- You open the driver's door with the ignition switched off

**i** The steering wheel will then move upwards only if it is not already as high as it will go. The driver's seat will then move backwards

only if it is not already at the rear of the seat adjustment range.

The steering wheel and the driver's seat will move back to the last drive position in the following cases:

- You switch the power supply or the ignition on when the driver's door is closed
- You close the driver's door with the ignition switched on

The last drive position will be saved when:

- You switch the ignition off.
- you save the seat settings via the memory function.

If you press one of the memory function memory position switches, the adjustment process will be stopped.

### Setting the easy entry and exit feature

Multimedia system:

▶ Vehicle ▶  Vehicle Settings

▶ Easy Entry/Exit

▶ Select **Steering Wheel & Seat, Steering Wheel Only** or **Off**.

### Memory function

#### Function of the memory function

**⚠ WARNING** Risk of an accident if the memory function is used while driving

If you use the memory function on the driver's side while driving, you could lose control of the vehicle as a result of the adjustments being made.

- ▶ Only use the memory function on the driver's side when the vehicle is stationary.

- ⚠ WARNING** Risk of entrapment when adjusting the seat with the memory function

When the memory function adjusts the seat or steering wheel, you and other vehicle occupants – particularly children – could become trapped.

- ▶ During the adjusting process of the memory function, ensure that no body parts are in the sweep of the seat or the steering wheel.
- ▶ If somebody becomes trapped, immediately release the memory function position button. The adjustment process is stopped.

- ⚠ WARNING** Risk of entrapment if the memory function is activated by children

Children could become trapped if they activate the memory function, particularly when unattended.

- ▶ Never leave children unattended in the vehicle.
- ▶ When leaving the vehicle, always take the SmartKey with you and lock the vehicle.

You can use the memory function when the ignition is switched off.

Seat adjustments for up to three people can be stored and called up using the memory function.

You can save settings for the following systems:

- Seat, backrest and head restraint
- Steering wheel
- Outside mirrors
- Head-up Display

## Operating the memory function

### Storing

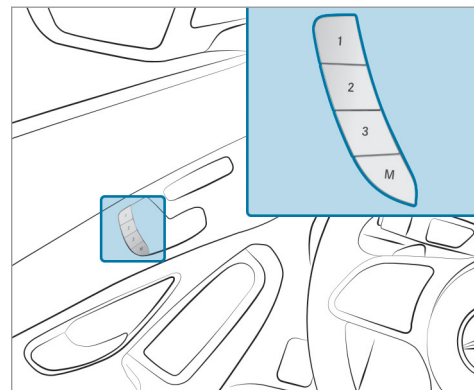

- ▶ Set the desired position for all systems.
- ▶ Briefly press memory button **M** and then press preset position **1**, **2** or **3** within three seconds. An acoustic signal sounds. The settings are stored.

▶ **To call up:** press and hold preset position button **1**, **2** or **3** until all the systems are in the stored position.

ⓘ When you release the preset position button, steering wheel, the seat and mirror setting functions stop immediately. The Head-up Display continues to be adjusted.

### Stowage areas

#### Notes on loading the vehicle

**⚠ DANGER** Risk of exhaust gas poisoning

Combustion engines emit poisonous exhaust gases such as carbon monoxide. Exhaust gases can enter the vehicle interior if the trunk lid is open when the engine is running, especially if the vehicle is in motion.

- ▶ Always switch off the engine before opening the trunk lid.
- ▶ Never drive with the trunk lid open.

**⚠ WARNING** Risk of injury from unsecured items in the vehicle

If objects, luggage or loads are not secured or not secured sufficiently, they could slip, tip over or be thrown around and thereby hit vehicle occupants.

There is a risk of injury, particularly in the event of sudden braking or a sudden change in direction.

- ▶ Always stow objects in such a way that they cannot be thrown around.
- ▶ Before the journey, secure objects, luggage or loads against slipping or tipping over.

**⚠ WARNING** Risk of injury due to objects being stowed incorrectly

If objects in the vehicle interior are stowed incorrectly, they can slide or be thrown around and hit vehicle occupants. In addition, cup holders, open storage spaces and mobile phone brackets cannot always retain all objects they contain.

There is a risk of injury, particularly in the event of sudden braking or a sudden change in direction.

- ▶ Always stow objects in such a way that they cannot be thrown around in such situations.
- ▶ Always make sure that objects do not protrude from storage spaces, parcel nets or storage nets.
- ▶ Close the lockable storage spaces before starting a journey.
- ▶ Always stow and secure heavy, hard, pointed, sharp-edged, fragile or bulky objects in the trunk.

#### Vehicles with automatic front passenger airbag shutoff

**Objects trapped under the front passenger seat may interfere with the function of the automatic front passenger airbag shutoff or damage the system. Please observe the notes on the function of the automatic front passenger airbag shutoff (→ page 45).**

**⚠ WARNING** - Risk of accident or injury when using the cup holder while the vehicle is moving

The cup holder cannot secure containers while the vehicle is moving.

If you use a cup holder while the vehicle is moving, the container may be flung around and liquids may be spilled. The vehicle occupants may come into contact with the liquid and if it is hot, they could be scalded. You could be distracted from traffic conditions and you may lose control of the vehicle.

- ▶ Only use the cup holder when the vehicle is stationary.
- ▶ Only use the cup holder for containers of the right size.
- ▶ Close the container, particularly if the liquid is hot.

**! NOTE** Damage to the handle in the trunk floor

If the handle in the trunk is left protruding, the handle may be damaged.

- ▶ Before closing the trunk lid, detach the handle and press it down closed again.

**! NOTE** Damage to the stowage compartment under the ashtray due to intense heat

The stowage compartment under the ashtray is not heat resistant and could be damaged if you rest a lit cigarette on it.

- ▶ Make sure that the ashtray is fully engaged.

**⚠ WARNING** - Risk of fire and injury from hot cigarette lighter

You can burn yourself if you touch the hot heating element or the socket of the cigarette lighter.

In addition, flammable materials may ignite if:

- you drop the hot cigarette lighter
- a child holds the hot cigarette lighter to objects, for example
- ▶ Always hold the cigarette lighter by the knob.
- ▶ Always make sure that the cigarette lighter is out of reach of children.
- ▶ Never leave children unattended in the vehicle.

**⚠ WARNING** Risk of burns from the tailpipe and tailpipe trims

The exhaust tailpipe and tailpipe trims can become very hot. If you come into contact with these parts of the vehicle, you could burn yourself.

- ▶ Always be particularly careful around the tailpipe and the tailpipe trims and supervise children especially closely in this area.

- ▶ Allow vehicle parts to cool down before touching them.

The driving characteristics of your vehicle are dependent on the distribution of the load within the vehicle. You should bear the following in mind when loading the vehicle:

- Never exceed the permissible gross mass or the gross axle weight rating for the vehicle (including occupants). The values are specified on the vehicle identification plate on the vehicle's B-pillar.
- The load must not protrude above the upper edge of the seat backrests.
- Always place the load behind unoccupied seats if possible.
- Secure the load using the tie-down eyes and distribute the load evenly.

### Stowage spaces in the vehicle interior

#### Overview of the front storage compartments

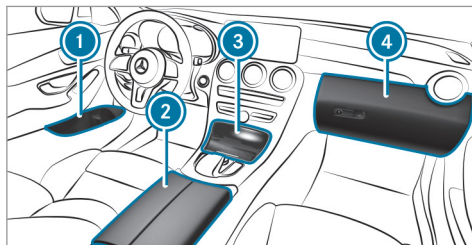

- ① Storage spaces in the doors
- ② Storage compartment in the armrest with a multimedia and USB connection
- ③ Storage compartment in the front center console with a USB port
- ④ Glove box

### Through-loading feature in the rear bench seat (EASY-PACK Quickfold)

#### Folding the rear seat backrest forwards

**⚠ WARNING** Risk of accident if the rear bench seat, rear seat and seat backrest are not engaged

The rear bench seat, rear seat and seat backrest may fold forwards, even when you are driving.

- As a result, the vehicle occupant will be pushed into the seat belt with increased force. The seat belt will not be able to protect as intended and could cause additional injury.
  - Objects or loads in the trunk or cargo compartment will not be restrained by the seat backrest.
- ▶ Make sure that the rear bench seat, the rear seat and the seat backrest are engaged before every trip.



If the left and right seat backrests are not engaged and locked in place, this will be shown on the multifunction display on the instrument cluster. A warning tone will also sound.

If the center seat backrest is not engaged and locked in place, the lock verification indicator will be red.

**Requirements:**

- To fold the center seat backrest forwards: the center seat backrest has been unlocked.

You can fold the center and outer seat backrests forwards separately.

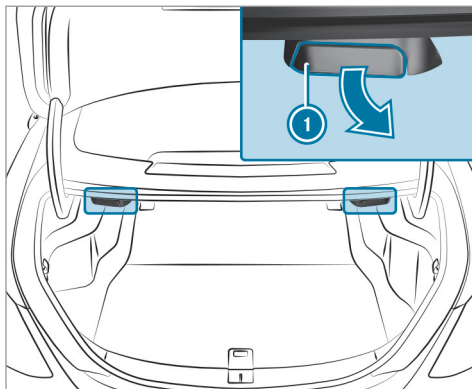

- Vehicles without a memory function:** Move the driver's or front passenger seat forwards, if necessary.

**Vehicles with a memory function:** If necessary, when the seat backrest in the rear passenger compartment is folded forward, the corresponding front seat will move forwards slightly to avoid a collision.

- If necessary, fully insert the head restraints into the rear seat backrest.
- To fold the left and right seat backrests forward:** pull right or left release handle ①.

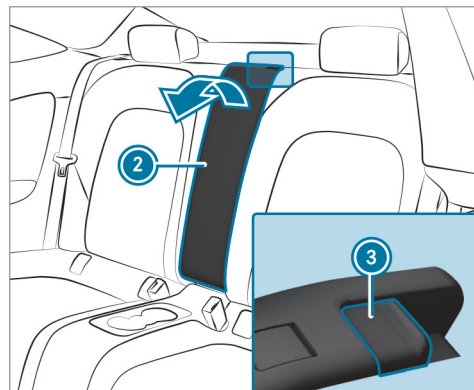

- To fold the center seat backrest forwards:** pull release catch ③ of seat backrest ② forwards.
- Fold seat backrest ② forwards.

- ▶ If necessary, reset the driver's or front passenger seat.

### Folding back the rear seat backrest

**⚠ WARNING** Risk of becoming trapped when adjusting the seats

When you adjust a seat, you may trap yourself or a vehicle occupant.

- ▶ When adjusting a seat, make sure that no one has any body parts in the sweep of the seat.

**❗ NOTE** Damage caused by trapping the seat belt when folding back the seat backrest

The seat belt could become trapped and thus damaged when the seat backrest is folded back.

- ▶ Make sure that the seat belt is not trapped when folding back the seat backrest.

- ▶ Move the driver's or front passenger seat forwards, if necessary.



- ▶ Fold the corresponding seat backrest ① back until it engages.

**Left and right seat backrests:** if the seat backrest is not engaged and locked in place, this will be shown on the multifunction display on the instrument cluster.

A warning tone will also sound.

**Center seat backrest:** if the seat backrest is not engaged and locked in place, the red lock verification indicator ② will be visible.

### Locking the release catch of the center rear seat backrest

#### Requirements:

- The left and center seat backrests are engaged and joined together.

You can lock the center seat backrest release catch if you want to secure the trunk against unauthorized access. The center seat backrest can then be folded forwards only together with the left seat backrest.

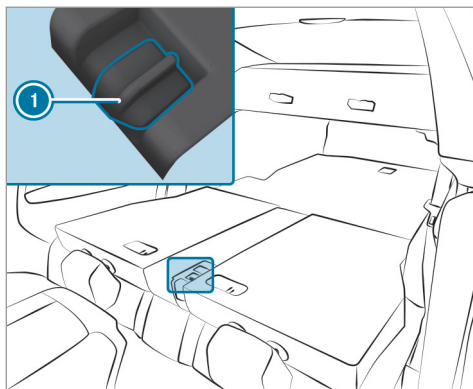

- ▶ Fold the center and left seat backrests forwards.
- ▶ **To lock or unlock:** slide catch ① upwards or downwards.

### Overview of the tie-down eyes

Observe the notes on loading the vehicle  
(→ page 100).

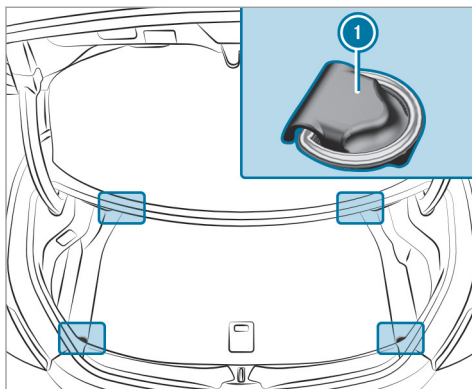

- ① Tie-down eyes (vehicles with through-loading feature in the rear bench seat)

### Using the bag hooks

**⚠ WARNING** Risk of injury when using bag hooks with heavy objects

The bag hooks cannot restrain heavy objects or items of luggage.

Objects or items of luggage may be flung around and hit vehicle occupants.

- ▶ Only hang light objects on the bag hooks.
- ▶ Never hang hard, sharp-edged or fragile objects on the bag hooks.

Subject the bag hooks to a maximum load of 6.6 lbs (3 kg) and do not attach any goods to them.

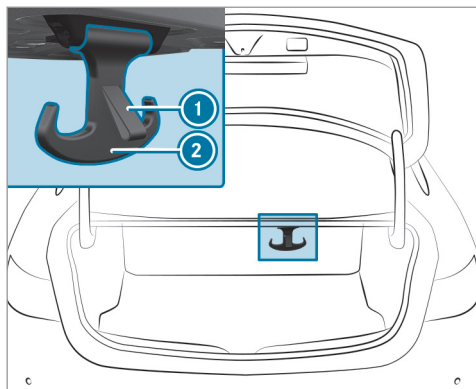

- ▶ Pull bag hook ② down by tab ①.
- ⓘ Observe the notes on loading the vehicle (→ page 100).

### Attaching the parcel net

**⚠ WARNING** Risk of injury due to objects being stowed incorrectly

If objects in the vehicle interior are stowed incorrectly, they can slide or be thrown around and hit vehicle occupants. In addition, cup holders, open storage spaces and mobile phone brackets cannot always retain all objects they contain.

There is a risk of injury, particularly in the event of sudden braking or a sudden change in direction.

- ▶ Always stow objects in such a way that they cannot be thrown around in such situations.
- ▶ Always make sure that objects do not protrude from storage spaces, parcel nets or storage nets.
- ▶ Close the lockable storage spaces before starting a journey.

- ▶ Always stow and secure heavy, hard, pointed, sharp-edged, fragile or bulky objects in the trunk.

Observe the notes on loading the vehicle.

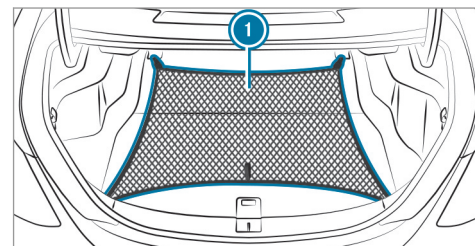

- ▶ Vehicles with through-loading feature in the rear bench seat: fold up the tie-down eyes.
- ▶ Hook parcel net ① into the front and rear tie-down eyes.
- ▶ Vehicles without a through-loading feature in the rear bench seat: hook the rings into the parcel net hooks ①.

- ▶ Place the rings into the hooks on the trunk floor.

### Attaching a roof luggage rack

**⚠ WARNING** Risk of accident due to exceeding the maximum roof load

The vehicle center of gravity and the usual driving characteristics as well as the steering and braking characteristics alter.

If you exceed the maximum roof load, the driving characteristics, as well as steering and braking, will be greatly impaired.

- ▶ Never exceed the maximum roof load and adjust your driving style.

You will find information on the maximum roof load in the "Technical data" section.

**! NOTE** Vehicle damage from non-approved roof luggage racks

The vehicle could be damaged by roof luggage racks that have not been tested and approved for Mercedes-Benz.

- ▶ Use only roof luggage racks tested and approved for Mercedes-Benz.
- ▶ Depending on the vehicle equipment, ensure that the sliding sunroof can be fully raised when the roof luggage rack is installed.
- ▶ Depending on the vehicle equipment, ensure that the trunk lid can be fully opened when the roof luggage rack is installed.
- ▶ Position the load on the roof luggage rack in such a way that the vehicle will not sustain damage even when it is in motion.

**! NOTE** Damage to the panorama roof with power tilt/sliding panel due to non-approved roof luggage racks

The panorama roof with power tilt/sliding panel may be damaged by the roof luggage rack if you attempt to open it when using a roof luggage rack not tested and approved for Mercedes-Benz.

- ▶ When a roof luggage rack is installed, open the panorama roof with power tilt/sliding panel only if this has been tested and approved for Mercedes-Benz.

The panorama roof with power tilt/sliding panel may be raised to allow ventilation of the vehicle interior.

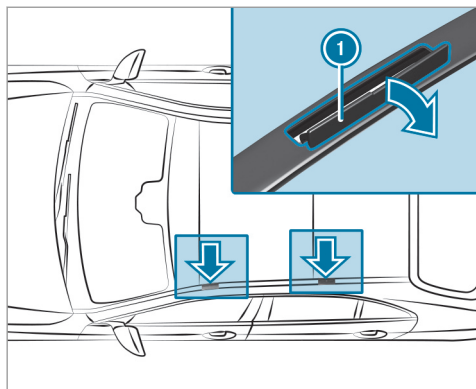

- ▶ Secure the roof luggage rack to the fastening points beneath covers ①.
- ▶ Comply with the installation instructions of the roof luggage rack manufacturer.
- ▶ Secure the load on the roof luggage rack.

### Sockets

#### Using the 12 V socket

##### Requirements:

- Only devices up to a maximum of 180 W (15 A) are permissible.

Depending on the vehicle equipment, the vehicle has the following 12 V sockets:

- In the storage compartment in the front center console
- In the front passenger footwell
- In the storage compartment in the center console of the rear passenger compartment

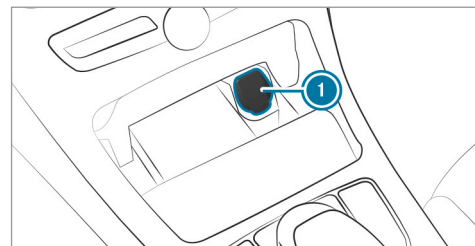

Example: 12 V socket in the storage compartment in the front center console

- ▶ Fold up socket cap ①.
- ▶ Insert the plug of the device.

If you have connected a device to the 12 V socket, leave the cover of the storage compartment open.

#### ! NOTE Damage to the covers

The covers may be damaged and scratched when being opened.

- ▶ Do not use metallic or hard objects.

- ▶ Carefully fold covers ① upwards in the direction of the arrow.

### Wireless charging of the mobile phone and connection with the exterior antenna

#### Notes on wirelessly charging the mobile phone

**⚠ WARNING** Risk of injury due to objects being stowed incorrectly

If objects in the vehicle interior are stowed incorrectly, they can slide or be thrown around and hit vehicle occupants. In addition, cup holders, open stowage spaces and mobile phone receptacles cannot always retain all objects within.

There is a risk of injury, particularly in the event of sudden braking or a sudden change in direction.

- ▶ Always stow objects so that they cannot be thrown around in such situations.
- ▶ Always make sure that objects do not protrude from stowage spaces, parcel nets or stowage nets.

- ▶ Close the lockable stowage spaces before starting a journey.
- ▶ Always stow and secure heavy, hard, pointed, sharp-edged, fragile or bulky objects in the trunk/cargo compartment.

Observe the notes on loading the vehicle.

**⚠ WARNING** Risk of fire from placing objects in the mobile phone storage compartment

Placing other objects in the mobile phone storage compartment could constitute a fire hazard.

- ▶ Apart from a mobile phone, do not place any other objects in the mobile phone storage compartment, especially those made of metal.

**! NOTE** Damage to objects caused by placing them in the mobile phone storage compartment

If objects are placed in the mobile phone storage compartment, they may be damaged by electromagnetic fields.

- ▶ Do not place credit cards, data storage devices, ski passes or other objects sensitive to electromagnetic fields in the mobile phone storage compartment.

**! NOTE** Damage to the mobile phone storage compartment caused by liquids

If liquids enter the mobile phone storage compartment, the compartment may be damaged.

- ▶ Ensure that no liquids enter the mobile phone storage compartment.

The following notes on wirelessly charging the mobile phone must be observed:

- Depending on the vehicle equipment, the mobile phone is connected to the vehicle's exterior antenna via the charging module.
- The charging function and wireless connection of the mobile phone to the vehicle's exterior antenna are only available if the ignition is switched on.
- Small mobile phones may not be able to be charged in every position of the mobile phone storage compartment.
- Large mobile phones which do not rest flat in the mobile phone storage compartment may not be able to be charged or connected with the vehicle's exterior antenna.
- The mobile phone may heat up during the charging process. This may particularly depend on the applications (apps) currently open in the background.
- To ensure more efficient charging and connection with the vehicle's exterior antenna, remove the protective cover from the mobile

phone. Protective covers which are necessary for wireless charging are an exception.

### Wirelessly charging a mobile phone

#### Requirements:

- The mobile phone is suitable for wireless charging.

A list of compatible mobile phones can be found at: <https://www.mercedes-benz-mobile.com/>.

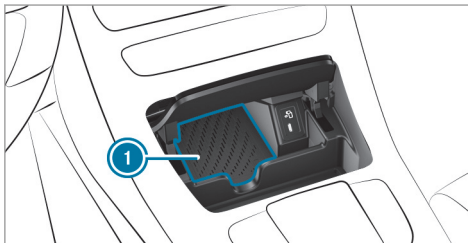

- ▶ Place the mobile phone as close to the center of mat ① as possible with the display facing upwards.

When the charging symbol is shown in the multimedia system, the mobile phone is being charged.

Malfunctions during the charging process are shown in the media display.

- ① The mat can be removed by the tab for cleaning, e.g. using clean, lukewarm water.

### Installing/removing the floor mats

**⚠ WARNING** Risk of accident due to objects in the driver's footwell

Objects in the driver's footwell may impede pedal travel or block a depressed pedal.

This jeopardizes the operating and road safety of the vehicle.

- ▶ Stow all objects in the vehicle securely so that they cannot get into the driver's footwell.



- ▶ Always install the floor mats securely and as prescribed in order to ensure that there is always sufficient room for the pedals.
- ▶ Do not use loose floor mats and do not place floor mats on top of one another.

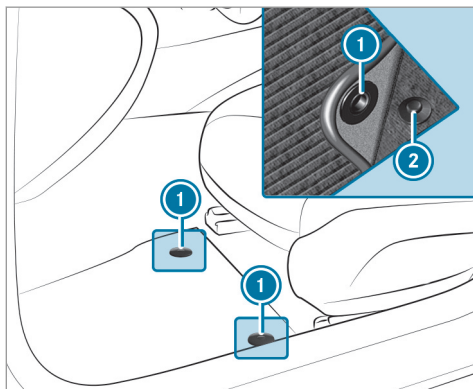

- ▶ **To install:** slide the corresponding seat backwards and lay the floor mat in the footwell.
- ▶ Press studs ① onto holders ②.
- ▶ Adjust the corresponding seat.
- ▶ **To remove:** pull the floor mat off the holders ②.
- ▶ Remove the floor mat.

## Exterior lighting

### Information about lighting systems and your responsibility

The various lighting systems of the vehicle are only aids. The driver of the vehicle is responsible for correct vehicle illumination in accordance with the prevailing light and visibility conditions, legal requirements and traffic situation.

## Light switch

### Operating the light switch

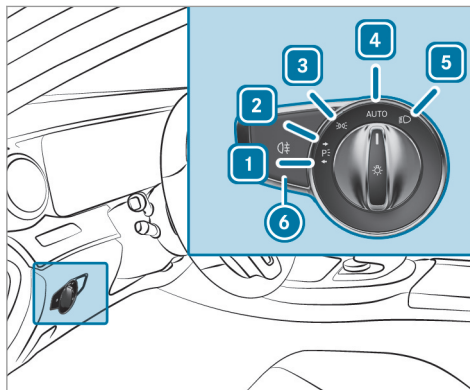

- 1 Left-hand standing lamps
- 2 Right-hand standing lamps
- 3 Parking lamps and license plate lamp
- 4 **AUTO** Automatic driving lights (preferred light switch position)

- 5 Low beam/high beam
- 6 Switches the rear fog light on/off

When low beam is activated, the indicator lamp for the parking lamps will be deactivated and replaced by the low beam indicator lamp.

▶ Always park your vehicle safely using sufficient lighting, in accordance with the relevant legal stipulations.

**!** **NOTE** Battery discharging by operating the standing lights

Operating the standing lights over a period of hours puts a strain on the battery.

▶ Where possible, switch on the right or left parking light.

If the battery is insufficiently charged, the standing lamps or parking lamps will be switched off automatically to facilitate the next engine start.

The exterior lighting (except standing and parking lamps) will switch off automatically when the driver's door is opened.

- Observe the notes on surround lighting (→ page 117).

### Automatic driving lights function

The parking lamps, low beam and daytime running lamps are switched on automatically depending on the ignition status and the ambient light.

**⚠ WARNING** Risk of accident when the low beam is switched off in poor visibility



When the light switch is set to **AUTO**, the low beam may not be switched on automatically if there is fog, snow or other causes of poor visibility such as spray.

- ▶ In such cases, turn the light switch to .

The automatic driving lights are only an aid. You are responsible for vehicle lighting.

### Switching the rear fog lights on or off

#### Requirements:

- The light switch is in the  or **AUTO** position.
- ▶ Press the  button.

Please observe the country-specific laws on the use of rear fog lamps.

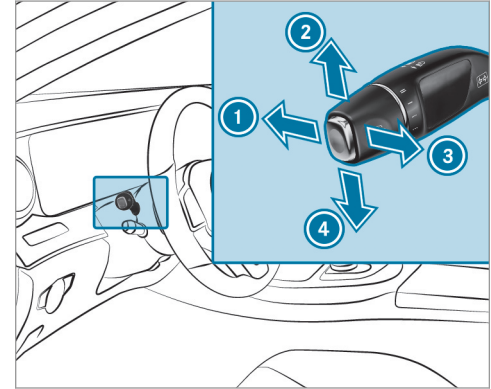

### Operating the combination switch for the lights



- 1 High beam
- 2 Turn signal light, right
- 3 High-beam flasher
- 4 Turn signal light, left

- ▶ Use the combination switch to activate the desired function.

### Switching on high beam

- ▶ Turn the light switch to the  or **AUTO** position.
- ▶ Push the combination switch beyond the point of resistance in the direction of arrow ①.  
When the high beam is activated, the  indicator lamp for low beam will be deactivated and replaced by the  indicator lamp for high beam.

### Switching off high beam

- ▶ Move the combination switch back to its starting position.

### High-beam flasher

- ▶ Pull the combination switch in the direction of arrow ③.

### Turn signal light

- ▶ **To indicate briefly:** push the combination switch briefly to the point of resistance in the direction of arrow ② or ④.  
The corresponding turn signal light will flash three times.

**To indicate permanently:** push the combination switch beyond the point of resistance in the direction of arrow ② or ④.

Vehicles with Active Lane Change Assist:

- A turn signal indicator activated by the driver may continue to operate for the duration of the lane change.
- If the driver indicated directly beforehand but a lane change was not immediately possible, the turn signal indicator may activate automatically.

### Activating/deactivating the hazard warning lights

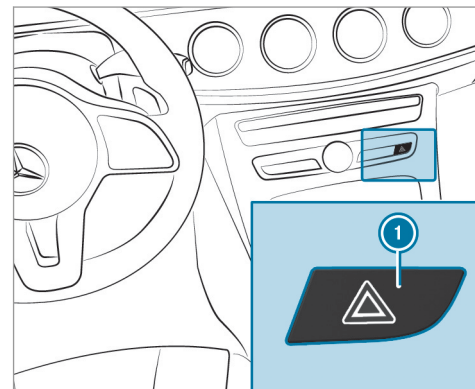

- ▶ Press button ①.

The hazard warning lights will switch on automatically if:

- The airbag has been deployed.

## Cornering light

### Cornering light function

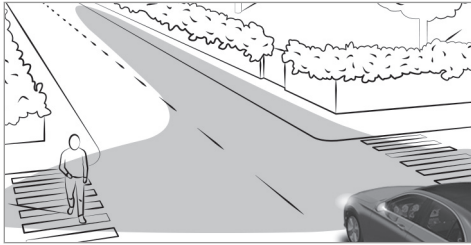

The cornering light improves the illumination of the road over a wide angle in the turning direction, enabling better visibility on tight curves, for example. It can be activated only when the low beam is switched on.

The function is active in the following cases:

- At speeds below 25 mph (40 km/h) when the turn signal light is switched on or the steering wheel is turned

- At speeds between 25 mph (40 km/h) and 43 mph (70 km/h) and when the steering wheel is turned

**Roundabout and intersection function:** the cornering light will be activated on both sides based on an evaluation of the vehicle's current GPS position. It will remain active until after the vehicle has left the roundabout or the intersection.

## Active headlamps

### Active headlamps function

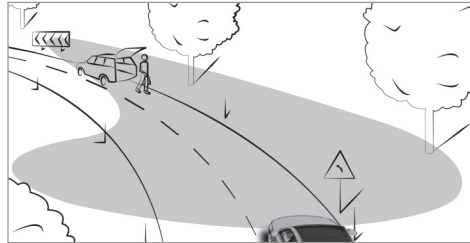

- The headlamps follow the steering movements.
- Relevant areas are better illuminated during a journey.

The functions are active when the low beam is switched on.

Depending on the vehicle's equipment, the course of the lane in which you are driving will also be evaluated and the active headlamps function will adjust the light in advance.

## Adaptive Highbeam Assist

### Adaptive Highbeam Assist function

**⚠ WARNING** Risk of accident despite Adaptive Highbeam Assist

Adaptive Highbeam Assist does not react to:

- Road users without lights, e.g. pedestrians
- Road users with poor lighting, e.g. cyclists

- Road users whose lighting is obstructed, e.g. by a barrier

On very rare occasions, Adaptive Highbeam Assist may fail to recognize other road users with their own lighting, or may recognize them too late.

In these, or in similar situations, the automatic high beam will not be deactivated or will be activated despite the presence of other road users.

- ▶ Always observe the road and traffic conditions carefully and switch off the high beam in good time.

Adaptive Highbeam Assist cannot take into account road, weather or traffic conditions.

Detection may be restricted in the following cases:

- In poor visibility, e.g. fog, heavy rain or snow
- If there is dirt on the sensors or the sensors are obscured

Adaptive Highbeam Assist is only an aid. You are responsible for adjusting the vehicle's lighting to

the prevailing light, visibility and traffic conditions.

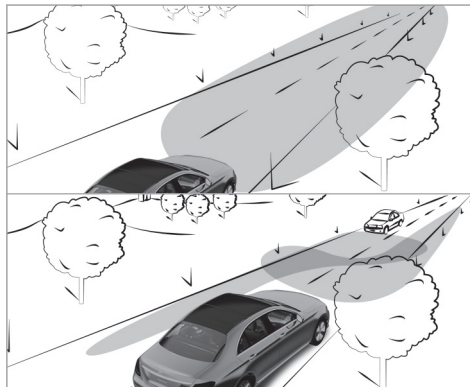

Adaptive Highbeam Assist automatically switches between the following types of light:

- Low beam
- High beam

At speeds greater than 19 mph (30 km/h):

- If no other road users are detected, the high beam will switch on automatically.

The high beam will switch off automatically in the following cases:

- At speeds below 16 mph (25 km/h)
- If other road users are detected
- If street lighting is sufficient

- ❗ The system's optical sensor is located behind the windshield near the overhead control panel.

### Switching Adaptive Highbeam Assist on/off

#### Switching on

- ▶ Turn the light switch to the **AUTO** position.
- ▶ Switch on the high beam using the combination switch.  
If Adaptive Highbeam Assist is activated, the  indicator lamp will light up on the multifunction display.

### Switching off

- ▶ Switch off the high beam using the combination switch.

### Switching the daytime running lamps on/off

Multimedia system:

- ↳ Vehicle ▶  Light Settings
- ▶▶ Daytime Run. Lights

- ▶ Activate  or deactivate  the function.

### Setting the exterior lighting switch-off delay time

Multimedia system:

- ↳ Vehicle ▶  Light Settings
- ▶▶ Ext. Light Switch Off

- ▶ Set the switch-off delay time.

### Setting the surround lighting

Multimedia system:

- ↳ Vehicle ▶  Light Settings
- ▶▶ Locator Lighting





- ▶ Activate  or deactivate  the function.

If the surround lighting is switched on, the exterior lighting remains lit for 40 seconds after the vehicle is unlocked. When you start the vehicle, the surround lighting is deactivated and the automatic driving lights are activated.

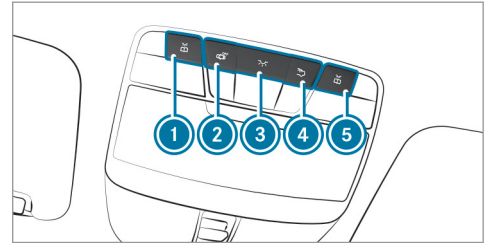
### Interior lighting

#### Adjusting the interior lighting



- ①  Front left reading lamp
- ②  Automatic interior lighting control
- ③  Front interior lighting
- ④  Rear interior lighting
- ⑤  Front right reading lamp

- ▶ **To switch on/off:** press the corresponding button ① – ⑤.

### Adjusting the ambient lighting

Multimedia system:

- Vehicle ► Light Settings
- Ambient Light

#### Setting the color

- Select **Color**.
- Set a color.

#### Adjusting the brightness

- Select **Brightness**.
- Set a brightness value.

#### Activating the brightness for zones

- Select **Brightness Zones**.
- Activate  or deactivate  the function.  
The **Display**, **Front** and **Rear** zones can be set separately.

### Setting the interior lighting switch-off delay time

Multimedia system:

- Vehicle ► Light Settings
- Int. Light Switch Off
- Set the switch-off delay time.

### Windshield wiper and windshield washer system

#### Switching the windshield wipers on/off

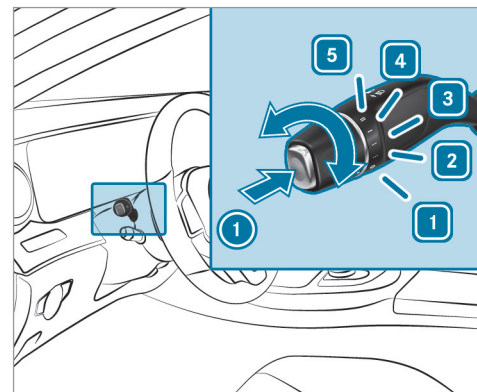



- 1 0 Windshield wiper off
- 2 ... Intermittent wiping, normal
- 3 .... Intermittent wiping, frequent



4  Continuous wiping, slow

5  Continuous wiping, fast

- ▶ Turn the combination switch to the corresponding position **1** - **5**.
- ▶ **Single wipe/washing:** push the button on the combination switch in the direction of arrow **1**.
  -  Single wipe
  -  Wipes with washer fluid

### Replacing the windshield wiper blades

**⚠ WARNING** Risk of becoming trapped if the windshield wipers are switched on while wiper blades are being replaced

If the windshield wipers begin to move while you are changing the wiper blades, you can be trapped by the wiper arm.

- ▶ Always switch off the windshield wipers and the ignition before changing the wiper blades.

### Moving the wiper arms into the replacement position

- ▶ Switch the ignition on and then off again immediately.
- ▶ Within around 15 seconds, press and hold the  button on the combination switch for approximately three seconds (→ page 118). The wiper arms will move into the replacement position.

### Removing the wiper blades

- ▶ Fold the wiper arms away from the windshield.

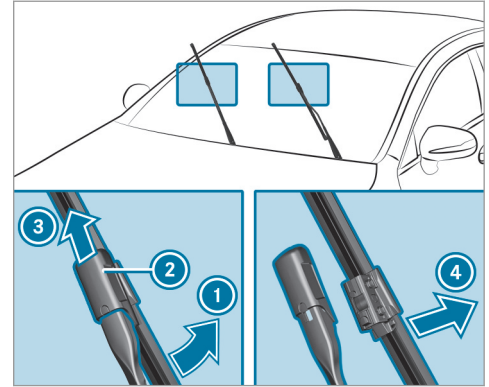

- ▶ Hold the wiper arm with one hand. With the other hand, turn the wiper blade away from the wiper arm in the direction of arrow **1** as far as it will go.
- ▶ Slide catch **2** in the direction of arrow **3** until it engages in the removal position.
- ▶ Remove the wiper blade from the wiper arm in the direction of arrow **4**.

### Installing the wiper blades

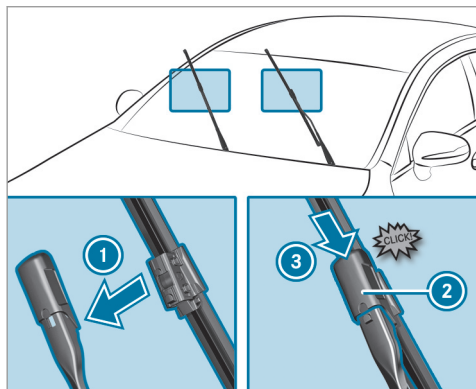

- ▶ Insert the new wiper blade into the wiper arm in the direction of arrow ①.
- ▶ Slide catch ② in the direction of arrow ③ until it engages in the locking position.
- ▶ Make sure that the wiper blade is seated correctly.

- ▶ Fold the wiper arms back onto the windshield.
- ▶ Switch on the ignition.
- ▶ Press the  button on the combination switch (→ page 118). The wiper arms will return to the original position.
- ▶ Switch the ignition off.

### Maintenance display

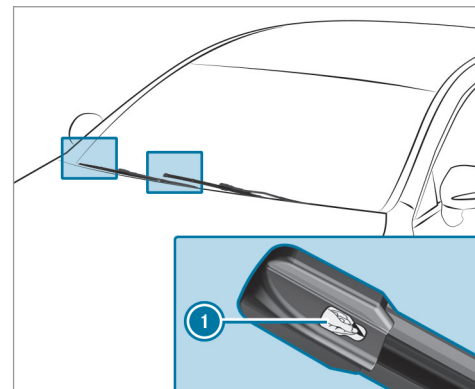

- ▶ Remove protective film ① from the maintenance display on the tip of the newly installed wiper blades.

When the color of the maintenance display changes from black to yellow, the wiper blades should be replaced.

- ⓘ The duration until the color changes varies depending on the usage conditions.

## Mirrors

### Operating the outside mirrors

**⚠ WARNING** Risk of accident due to adjusting the vehicle settings while the vehicle is in motion

You could lose control of the vehicle in the following situations in particular:

- If you adjust the driver's seat, the head restraint, the steering wheel or the mirror while the vehicle is in motion
  - If you fasten your seat belt while the vehicle is in motion
- ▶ Before starting the engine: In particular, adjust the driver's seat, head restraint, steering wheel and mirror, and fasten your seat belt.

**⚠ WARNING** Risk of accident due to misjudgment of distance when using the front-passenger mirror

The outside mirror on the front passenger side reflects objects on a smaller scale. The objects in view are in fact closer than they appear.

- ▶ Therefore, always look over your shoulder in order to ensure that you are aware of the actual distance between you and the road users driving behind you.

### Folding the outside mirrors in/out

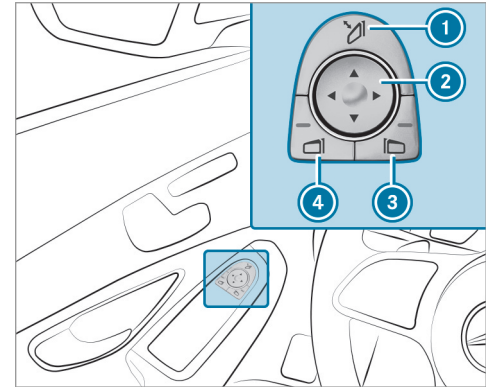

- ▶ Briefly press button ①.

### Resetting the outside mirrors

- ⓘ If the battery has been disconnected or completely discharged, the outside mirrors must be reset. Only then will the automatic mirror folding function work properly.
- ▶ Briefly press button ①.

### Adjusting the outside mirrors

- ▶ Press button ③ or ④ to select the outside mirror to be adjusted.
- ▶ Press button ② to adjust the position of the mirror glass.

### Engaging the outside mirrors

- ▶ **Vehicles without electrically folding outside mirrors:** manually move the outside mirror into the correct position.
- ▶ **Vehicles with electrically folding outside mirrors:** press and hold button ①. You will hear a click and the mirror will audibly click into place. The outside mirror will now be set to the correct position.

### Automatic anti-glare mirrors function

**⚠ WARNING** Risk of acid burns and poisoning due to the anti-glare mirror electrolyte

Electrolyte may escape if the glass in an automatic anti-glare mirror breaks.

The electrolyte is hazardous to health and causes irritation. It must not come into contact with your skin, eyes, respiratory organs or clothing or be swallowed.

- ▶ If you come into contact with electrolyte, observe the following:
  - Immediately rinse the electrolyte from your skin with water and seek medical attention.
  - If electrolyte comes into contact with your eyes, immediately rinse them thoroughly with clean water and seek medical attention.
  - If the electrolyte is swallowed, immediately rinse your mouth out thoroughly. Do not induce vomiting. Seek medical attention immediately.
  - Immediately change out of clothing which has been contaminated with electrolyte.
  - If an allergic reaction occurs, seek medical attention immediately.

The inside rearview mirror and the outside mirror on the driver's side will automatically go into anti-glare mode if light from a headlamp hits the sensor on the inside rearview mirror.

### System limits

The system will not go into anti-glare mode if:

- The engine is switched off.
- Reverse gear is engaged.
- The interior lighting is switched on.

### Front-passenger outside mirror parking position function

The parking position makes parking easier.

The front-passenger outside mirror will swivel downwards in the direction of the rear wheel on the front passenger's side when:

- The parking position is stored (→ page 123).
- The front-passenger mirror is selected.
- Reverse gear is engaged.

The front-passenger outside mirror will move back to its original position when:

- You shift the transmission to another transmission position.
- You are traveling at a speed greater than 9 mph (15 km/h).
- You press the button for the outside mirror on the driver's side.

### Storing the parking position of the front-passenger outside mirror using reverse gear

#### Storing

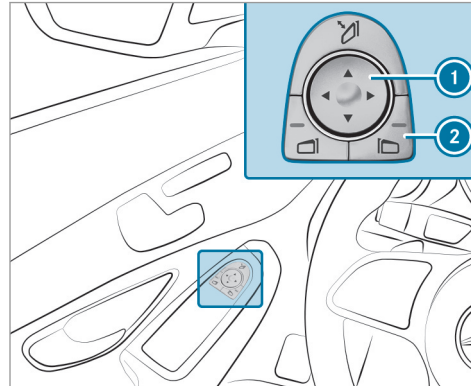

- ▶ Select the front-passenger outside mirror using button ②.
- ▶ Engage reverse gear.
- ▶ Move the front-passenger outside mirror into the desired parking position using button ①.

#### Calling up

- ▶ Select the front-passenger outside mirror using button ②.
- ▶ Engage reverse gear. The front-passenger outside mirror will move into the stored parking position.

### Activating/deactivating the automatic mirror folding function

Multimedia system:

- ▶ Vehicle ▶ Vehicle Settings
- ▶ Autom. Mirror Folding
- ▶ Activate  or deactivate  the function.

## Overview of climate control systems

### Notes on climate control

An interior air filter in combination with the pre-filter in the engine compartment must always be used so that the air conditioning system, pollution level monitoring and the air filtration work correctly. Use filters recommended and approved by Mercedes-Benz. Always have maintenance work carried out at a qualified specialist workshop.

### Overview of the air conditioning control panel

The indicator lamps on the buttons indicate that the corresponding function is activated.

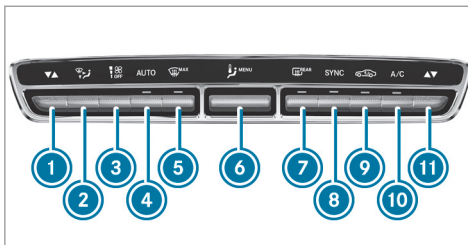

Example: Control panel for dual-zone automatic climate control without stationary heater

- ① Sets the temperature on the driver's side
- ② Sets the air distribution
- ③ Sets the airflow or switches off climate control
- ④ **AUTO** Sets climate control to automatic (→ page 125)
- ⑤ Defrosts the windshield
- ⑥ Vehicles without a stationary heater: calls up the air conditioning menu

Vehicles with a stationary heater: calls up the air conditioning menu, switches residual heat on/off

- ⑦ Switches the rear window heater on/off
- ⑧ Vehicles without a stationary heater: **SYNC** switches synchronization on/off (→ page 125)
- Vehicles with a stationary heater: switches the stationary heater on/off
- ⑨ Switches air-recirculation mode on/off (→ page 125)
- ⑩ **A/C** Switches the A/C function on/off (→ page 125)
- ⑪ Sets the temperature on the front passenger side

## Operating the climate control system

### Switching climate control on/off

- ▶ **To switch on:** set the airflow to level 1 or higher using the button.

- ▶ **To switch off:** set the airflow to level 0 using the  button.

If climate control is switched off, the windows may fog up more quickly. Switch climate control off only briefly.

### Switching the A/C function on/off using the air conditioning control panel

The A/C function heats, cools and dehumidifies the vehicle's interior air.



- ▶ Press the  button.

Switch off the A/C function only briefly; otherwise, the windows may fog up more quickly.

Condensation may drip from the underside of the vehicle when cooling mode is active. This is not indicative of a malfunction.

### Setting climate control to automatic mode

In automatic mode, the set temperature is controlled and maintained at a constant level by the air supply.

- ▶ Press the  button.
- ▶ **To switch to manual mode:** press the  or  button.

### Activating/deactivating the climate control synchronization function via the air conditioning control panel



Climate control can be set centrally using the synchronization function. The temperature and air distribution settings for the driver's side will be adopted automatically for the front passenger side.

- ▶ Press the  button.

The synchronization function will be deactivated if the settings for one of the other climate control zones are changed.

### Removing condensation from the windows

#### Windows fogged up on the inside

- ▶ Press the  button.
- ▶ If the windows continue to fog up: press the  button.

#### Windows fogged up on the outside

- ▶ Switch on the windshield wipers.
- ▶ Press the  button.

### Switching air-recirculation mode on/off

- ▶ Press the  button.  
The interior air will be recirculated.

Air-recirculation mode automatically switches to fresh air mode after some time.

- ▶  If air-recirculation mode is switched on, the windows may fog up more quickly. Switch on air-recirculation mode only briefly.

### Activating/deactivating ionization

Multimedia system:

- ▶  Vehicle ▶  Climate Control
- ▶ Ionization

Ionization cleans and refreshes the interior air of the vehicle. Ionization of the interior air is odorless.

- ▶ Activate  or deactivate  the function.

## Fragrance system

### Setting the fragrance system

#### Requirements:

- Automatic climate control is activated.
- The glove box is closed.

Multimedia system:

→ [Vehicle](#) →  [Climate Control](#)

→ [Air Freshener](#)

The fragrance system distributes a pleasant fragrance throughout the vehicle interior from a flacon located in the glove box.

▶ **To set the intensity:** select [High](#), [Medium](#), [Low](#) or [Off](#).

### Inserting or removing the flacon of the fragrance system

**⚠ WARNING** Risk of injury from liquid perfume

If children open the flacon, they could drink the liquid perfume or it could come into contact with their eyes.

- ▶ Do not leave children unattended in the vehicle.
- ▶ Consult a doctor immediately if liquid perfume has been drunk.
- ▶ If liquid perfume comes into contact with your eyes or skin, rinse your eyes with clean water.
- ▶ If symptoms continue, consult a doctor.

 **ENVIRONMENTAL NOTE** Environmental damage due to improper disposal of full flacons



Full flacons must not be disposed of with household waste.



Full flacons must be taken to a harmful substance collection point.

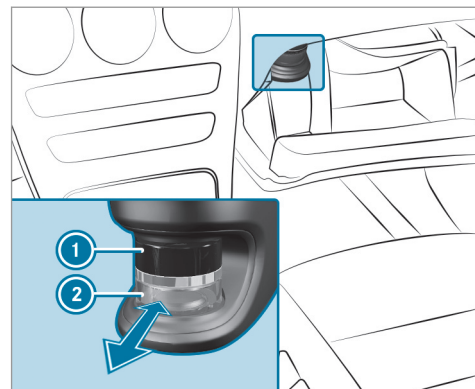

▶ **To insert:** slide flacon ② into the holder as far as it will go.

▶ **To remove:** pull out flacon ②.

If you do not use genuine Mercedes-Benz interior perfumes, observe the manufacturers' safety notices on the perfume packaging.



Dispose of the genuine Mercedes-Benz interior perfume flacon when it is empty and do not refill it.

### Refillable flacon

- ▶ Unscrew cap ① of empty flacon ②.
- ▶ Fill flacon ② with a maximum of 0.5 fl. oz. (15 ml).
- ▶ Screw cap ① back onto flacon ②.

Always refill the empty refillable flacon with the same perfume. Observe the separate information sheet attached to the flacon.

### Air vents

#### Adjusting the front air vents

**▲ WARNING** Risk of burns and frostbite due to being too close to the air vents

Very hot or very cold air can flow from the air vents.

- ▶ Make sure that all vehicle occupants always maintain a sufficient distance from the air vents.
- ▶ If necessary, direct the airflow to another area of the vehicle interior.

To guarantee the flow of fresh air through the air vents into the vehicle interior, comply with the following:

- Always keep the vents and ventilation grilles in the vehicle interior free.
- Keep the air inlet free of residue build-up (→ page 329).

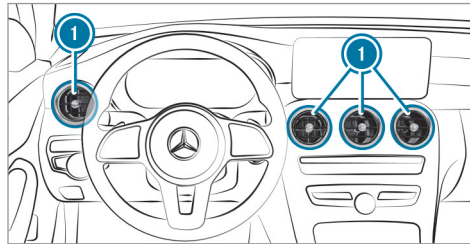

- ▶ **To open or close:** hold air vent ① in the center and turn it to the left (open) or right (closed) as far as it will go.
- ▶ **To set the airflow direction:** hold air vent ① in the center and move it up or down or to the left or right.

#### Adjusting the rear air vents

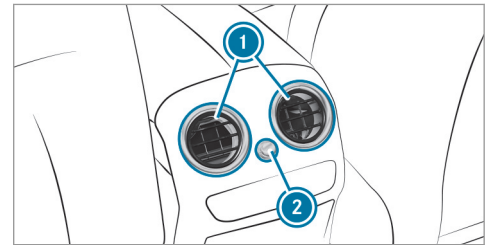

- ▶ **To open or close:** turn controller ② to the left or right as far as it will go.
- ▶ **To set the airflow direction:** hold air vent ① in the center and move it up or down or to the left or right.

## Driving

### Notes on Mercedes-AMG vehicles

Observe the notes on the following topics in the Supplement, otherwise you may fail to recognize dangers.

- ① The availability of certain functions depends on the equipment and model of the vehicle.
- Emotion Start
- Rear axle locking differential
- AMG Performance exhaust system
- AMG ceramic high-performance composite brake system
- Traction control
- RACE START
- AMG adaptive sport suspension system
- AMG steering-wheel buttons

### Switching on the power supply or ignition

**⚠ WARNING** Risk of accident and injury due to children left unattended in the vehicle

If children are left unsupervised in the vehicle, they could, in particular:

- open doors, thereby endangering other persons or road users.
- get out and be struck by oncoming traffic.
- operate vehicle equipment and become trapped, for example.

In addition, the children could also set the vehicle in motion, for example by:

- releasing the parking brake.
- changing the transmission position.
- starting the vehicle.

▶ Never leave children unattended in the vehicle.

- ▶ When leaving the vehicle, always take the SmartKey with you and lock the vehicle.
- ▶ Keep the vehicle SmartKey out of reach of children.

#### Requirements:

- The SmartKey is in the vehicle and is recognized.
- The brake pedal is not depressed.

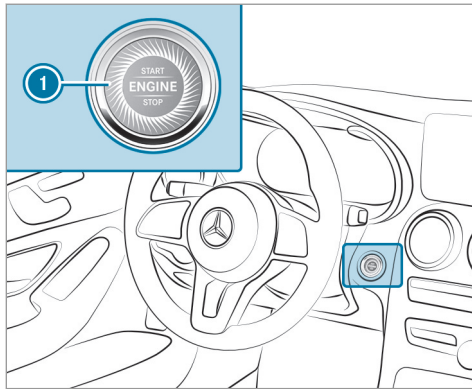

- ▶ **To switch on the power supply:** press button ❶ once.  
You can, for example, activate the windshield wipers.

The power supply is switched off again if the following conditions are met:

- You open the driver's door.
- You press button ❶ twice more.

- ▶ **To switch on the ignition:** press button ❶ twice.  
Indicator and warning lamps appear in the instrument cluster.

The ignition is switched off again if one of the following conditions is met:

- You do not start the vehicle within 15 minutes and the transmission is in position **P** or the electric parking brake is applied.
- You press button ❶ once.

### Starting the vehicle

#### Starting the vehicle with the start/stop button

- ⚠ **DANGER** Risk of death caused by exhaust gases

Combustion engines emit poisonous exhaust gases such as carbon monoxide. Inhaling these exhaust gases is hazardous to health and leads to poisoning.

- ▶ Never leave the engine or, if present, the auxiliary heating running in an enclosed space without sufficient ventilation.

- ⚠ **WARNING** Risk of fire due to flammable material in the engine compartment or the exhaust system

Flammable materials may ignite.

- ▶ Therefore, check regularly that there are no flammable materials in the engine compartment or on the exhaust system.

#### Requirements:

- The SmartKey is in the vehicle and is recognized.
- ▶ Shift the transmission to position **P** or **N**.
- ▶ Depress the brake pedal and press button ❶ once.
- ▶ If the vehicle does not start: switch off non-essential consumers and press button ❶ once.

▶ If the vehicle still does not start and the display message **Place the Key in the Marked Space See Operator's Manual** also appears in the multifunction display: start the vehicle with the SmartKey in the marked space (emergency operation mode) (→ page 130).

- ⓘ You can switch off the engine while driving. By pressing button ❶ for about three seconds or by pressing button ❶ three times within three seconds. Be sure to observe the safety notes under "Driving tips" (→ page 133).

Observe any information regarding display messages that can be displayed in the multifunction display.

### Starting the vehicle with the SmartKey in the marked space (emergency operation mode)

If the vehicle does not start and the **Place the Key in the Marked Space See Operator's Manual** message appears in the multifunction display, you can start the vehicle in emergency operation mode.

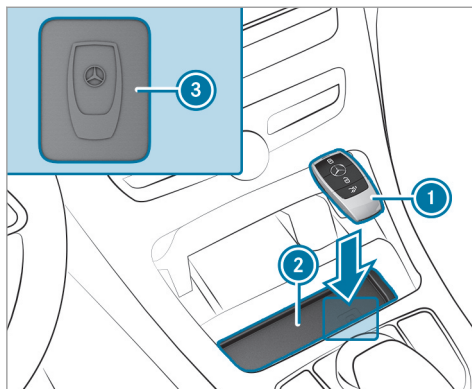

- ▶ Make sure that the marked space ❷ is empty.
- ▶ Remove SmartKey ❶ from the key ring.
- ▶ Place SmartKey ❶ in marked space ❷ on symbol ❸.  
The vehicle will start after a short time.  
If you remove SmartKey ❶ from marked space ❷, the engine continues running. For further engine starts however, SmartKey ❶

must be located in marked space ❷ on symbol ❸ during the entire journey.

- ▶ Have SmartKey ❶ checked at a qualified specialist workshop.

### If the vehicle does not start:

- ▶ Place SmartKey ❶ in marked space ❷ and leave it there.
- ▶ Depress the brake pedal and start the vehicle using the start/stop button.
- ⓘ You can also switch on the power supply or the ignition with the start/stop button.

Observe any information regarding display messages that can be displayed on the multifunction display.

## Starting the vehicle via Remote Online Services

### Cooling or heating the vehicle interior before starting the journey

Ensure the following before starting the engine:

- the legal stipulations in the area where your vehicle is parked allow engine starting via smartphone.
- it is safe to start and run the engine where your vehicle is parked.
- the fuel tank is sufficiently full.
- the starter battery is sufficiently charged.

### Charging the starter battery before starting the journey

If the vehicle battery is discharged, you can receive a message on your smartphone. You can then start the vehicle with the smartphone to charge the battery. The vehicle is automatically switched off after ten minutes.

Ensure the following before starting the engine:

- The legal stipulations in the area where your vehicle is parked allow engine starting via smartphone.
- It is safe to start and run the engine where your vehicle is parked.
- The fuel tank is sufficiently full.

### Starting the vehicle (Remote Online)

**⚠ WARNING** Risk of crushing or entrapment due to unintentional starting of the engine

Limbs could be crushed or trapped if the engine is started unintentionally during service or maintenance work.

- ▶ Always secure the engine against unintentional starting before carrying out maintenance or repair work.

### Requirements:

- Park position **P** is selected.
- The anti-theft alarm system is not activated.
- The panic alarm is not activated.

- The hazard warning light system is switched off.
- The hood is closed.
- The doors are closed and locked.
- The windows and sliding sunroof are closed.

- ▶ Start the vehicle using the smartphone. After every engine start, the engine runs for ten minutes.

You can carry out a maximum of two consecutive starting attempts. You must start the vehicle once with the SmartKey before trying to start the engine again with the smartphone. You can stop the vehicle again at any time.

- ⓘ Further information can be found in the smartphone app.

### Securing the engine against starting before carrying out maintenance or repair work:

- ▶ Switch on the hazard warning light system.

or

- ▶ Unlock the doors.

or

## 132 Driving and parking

- ▶ Open a side window or the sliding sunroof.

### Breaking-in notes

To preserve the engine during the first 1,000 miles (1,500 km):

- Drive at varying road speeds and engine speeds.
- Do not drive at speeds greater than 85 mph (140 km/h).
- Drive the vehicle in drive program **C** or **E**.
- Shift to the next highest gear at the very latest when the needle reaches the last third before the red area in the tachometer.
- Do not shift down a gear manually in order to brake.
- Avoid overstraining the vehicle, e.g. driving at full throttle.
- Do not depress the accelerator pedal past the pressure point (kickdown).

- Only increase the engine speed gradually and accelerate the vehicle to full speed after 1,000 miles (1,500 km).

This also applies when the engine or parts of the drivetrain have been replaced.

Please also observe the following breaking-in notes:

- In certain driving and driving safety systems, the sensors adjust automatically while a certain distance is being driven after the vehicle has been delivered or after repairs. Full system effectiveness is not reached until the end of this teach-in process.
- Brakepads, brake discs and tires that are either new or have been replaced only achieve optimum braking effect and grip after several hundred kilometers of driving. Compensate for the reduced braking effect by applying greater force to the brake pedal.

### Notes on optimized acceleration

If all necessary requirements and activation conditions are fulfilled, the best possible acceleration can be achieved from a standstill.

Do not use the optimized acceleration on public roads. Individual wheels could spin and you could lose control of the vehicle. There is an increased risk of skidding and/or accident.

Be sure to observe the safety notes and information on ESP® (→ page 158).

### Pulling away with optimized acceleration

**⚠ WARNING** Risk of skidding and having an accident from wheels spinning

When you use optimized acceleration, individual wheels could spin and you could lose control of the vehicle.

If ESP® is deactivated, there is a risk of skidding and accident.

- ▶ Make sure that no persons or obstacles are in the close vicinity of your vehicle.

**Requirements:**

- The vehicle has been broken in (→ page 132).
- The vehicle and tires are in good condition.
- You are on a high-grip roadway.
- The engine and transmission are at normal operating temperature.

**!** **NOTE** Increased wear due to optimized acceleration

When pulling away with optimized acceleration, all components of the drivetrain are subjected to a very high load.

This can lead to increased component wear.

- ▶ Do not always pull away with optimized acceleration.

- ▶ Engage the **D** drive position (→ page 142).
- ▶ Move the steering wheel to the straight-ahead position.
- ▶ Select the sportiest available drive program **S** or **S** (→ page 140).

- ▶ Deactivate ESP® (→ page 159).
- ▶ Depress and hold the brake pedal firmly with your left foot.
- ▶ With your right foot, fully depress the accelerator pedal.
- ▶ After no more than five seconds, take your left foot quickly off the brake, but keep the accelerator pedal depressed. The vehicle pulls away at maximum acceleration.
- ▶ Switch on ESP® once the acceleration procedure is complete.

**Ending optimized acceleration**

- ▶ Remove your foot from the accelerator pedal.
- ▶ Reactivate the ESP®.
- ⓘ After you pull away with optimized acceleration, components of the drivetrain can become very hot, which means that optimized acceleration values may be reached again only after a few minutes.

**Notes on driving**

**!** **WARNING** Risk of accident due to objects in the driver's footwell

Objects in the driver's footwell may impede pedal travel or block a depressed pedal.

This jeopardizes the operating and road safety of the vehicle.

- ▶ Stow all objects in the vehicle securely so that they cannot get into the driver's footwell.
- ▶ Always install the floor mats securely and as prescribed in order to ensure that there is always sufficient room for the pedals.
- ▶ Do not use loose floor mats and do not place floor mats on top of one another.

**⚠ WARNING** Risk of accident due to incorrect footwear

Incorrect footwear includes, for example:

- Shoes with platform soles
- Shoes with high heels
- Slippers

There is a risk of an accident.

- ▶ Always wear suitable footwear so that you can operate the pedals safely.

**⚠ WARNING** Risk of accident if the ignition is switched off while driving

If you switch off the ignition while driving, safety functions are restricted or no longer available.

This may affect the power steering system and the brake force boosting, for example.

You will need to use considerably more force to steer and brake, for example.

- ▶ Do not switch off the ignition while driving.

**⚠ DANGER** Risk of death caused by exhaust gases

Combustion engines emit poisonous exhaust gases such as carbon monoxide. Inhaling these exhaust gases is hazardous to health and leads to poisoning.

- ▶ Never leave the engine or, if present, the auxiliary heating running in an enclosed space without sufficient ventilation.

**⚠ WARNING** Risk of skidding and of an accident due to shifting down on slippery road surfaces

If you shift down on slippery road surfaces to increase the engine braking effect, the drive wheels may lose traction.

- ▶ Do not shift down on slippery road surfaces to increase the engine braking effect.

**⚠ DANGER** Risk of fatal injury due to poisonous exhaust gases

If the tailpipe is blocked or sufficient ventilation is not possible, poisonous exhaust gases such as carbon monoxide may enter the vehicle. This is the case when the vehicle becomes stuck in snow, for example.

- ▶ Keep the tailpipe and the area around the vehicle free from snow when the engine or the stationary heater are running.
- ▶ Open a window on the side of the vehicle facing away from the wind to ensure an adequate supply of fresh air.

**⚠ WARNING** Risk of accident and injury due to being under the influence of alcohol and drugs while driving

Drinking and driving and/or taking drugs and driving are very dangerous combinations. Even a small amount of alcohol or drugs can affect your reflexes, perceptions and judgment.



The possibility of a serious or even fatal accident are greatly increased when you drink or take drugs and drive.

- ▶ Do not drink or take drugs and drive or allow anyone to drive who has been drinking or taking drugs.

**⚠ WARNING** Risk of accident due to the brake system overheating

If you leave your foot on the brake pedal when driving, the brake system may overheat.

This increases the braking distance and the brake system may even fail.

- ▶ Never use the brake pedal as a footrest.
- ▶ Do not depress the brake pedal and the accelerator pedal at the same time while driving.

**! NOTE** Engine damage due to excessively high engine speeds

The engine will be damaged if you drive with the engine in the overrevving range.

- ▶ Do not drive with the engine in the overrevving range.

**! NOTE** Wearing out the brake linings by continuously depressing the brake pedal

- ▶ Do not depress the brake pedal continuously whilst driving.
- ▶ To use the braking effect of the engine, shift to a lower gear in good time.

**! NOTE** Damage to the drivetrain and engine when pulling away

- ▶ Do not warm up the engine while the vehicle is stationary. Pull away immediately.
- ▶ Avoid high engine speeds and driving at full throttle until the engine has reached its operating temperature.

**! NOTE** Damage to the catalytic converter due to non-combusted fuel

The engine is not running smoothly and is misfiring.

Non-combusted fuel may get into the catalytic converter.

- ▶ Only depress the accelerator pedal slightly.
- ▶ Have the cause rectified immediately at a qualified specialist workshop.

**! NOTE** Reduced battery life due to frequent short-distance trips

The 12 V battery may not be sufficiently charged when the vehicle is used only for short-distance trips. This reduces the life of the battery.

- ▶ Drive longer distances regularly to charge the battery.

### Notes on driving with a roof load, trailer or fully laden vehicle

When driving with a loaded roof luggage rack or trailer as well as with a fully laden or fully occupied vehicle, the vehicle's driving and steering characteristics change.

You should bear the following in mind:

- Do not exceed the permissible roof load and towing capacity. Also observe the technical data in the printed Operator's Manual.
- Evenly distribute the roof load, and place heavy objects at the bottom. Also comply with the notes on loading the vehicle (→ page 100).
- Drive attentively, and avoid suddenly pulling away, braking and steering as well as rapid cornering.

### Notes on driving on salt-treated roads

The braking effect is limited on salt-treated roads.

Therefore, observe the following notes:

- Due to salt build-up on the brake discs and brakepads, the braking distance can increase

considerably or result in braking only on one side

- Maintain a much greater safe distance to the vehicle in front

To remove salt build-up:

- Brake occasionally while paying attention to the traffic conditions
- Carefully depress the brake pedal at the end of the journey and when starting the next journey

### Notes on hydroplaning

Hydroplaning can take place once a certain amount of water has accumulated on the road surface.

Observe the following notes during heavy precipitation or in conditions in which hydroplaning may occur:

- Reduce speed
- Avoid tire ruts
- Avoid sudden steering movements
- Brake carefully

- ⓘ Also observe the notes on regularly checking wheels and tires (→ page 358).

### Notes on driving through water on the road surface

Water which has entered into the vehicle can damage the engine, electrics and transmission.

Water can also enter the air intake of the engine and cause engine damage.

Observe the following if you must drive through water:

- The water, when calm, may only reach the lower edge of the vehicle body.
- Drive at a maximum speed of 6 mph (10 km/h); water can otherwise enter the vehicle interior or engine compartment.
- Vehicles traveling in front, or oncoming vehicles, can create waves which may exceed the maximum permissible depth of the water.

The braking effect of the brakes is reduced after fording. Brake carefully while paying attention to the traffic conditions until braking power has been fully restored.

## ECO start/stop function

### Operation of the ECO start/stop function

- ① Depending on the engine, the ECO start/stop function is not available in all drive programs. Observe the status display in the multifunction display for this.

The engine is switched off automatically in the following situations if all vehicle conditions for an automatic engine stop are met:

- You brake the vehicle to a standstill in transmission position **D** or **N**.
- **Vehicles with a 48 V on-board electrical system:** You depress the brake pedal when traveling at a low speed.

If the system has detected one of the following situations, the engine will not stop:





- You stop at a stop sign and there is no vehicle in front of you.
- The vehicle that stopped in front of you starts up again.
- You maneuver, turn the steering wheel sharply or engage reverse gear.

- ① If the system detects an intelligent stop inhibitor, for example, a stop sign, the engine will not stop.  
If you activate the HOLD function or engage the park position **P**, the engine can be switched off in spite of an intelligent stop inhibitor.

The engine is restarted automatically if:

- You engage transmission position **D** or **R**.
- You depress the accelerator pedal.
- An automatic engine start is required by the vehicle.
- You release the brake pedal.
- **Vehicles with a 48 V on-board electrical system:**
  - You release the brake pedal on a downhill gradient and the vehicle does not roll.
  - The vehicle rolls on a downhill gradient and does not automatically enter glide mode at 15 mph (20 km/h).

ECO start/stop function symbols in the multifunction display:

- The  symbol (green) appears when the vehicle is at a standstill: The engine was switched off by the ECO start/stop function.
- The  symbol (yellow) appears when the vehicle is at a standstill: Not all vehicle conditions for an engine stop have been met.
- Neither the  nor  symbol appears when the vehicle is at a standstill: An intelligent stop inhibitor was detected, for example, a stop sign.

If the engine was switched off by the ECO start/stop function and you leave the vehicle, a warning tone sounds and the engine is not restarted. In addition, the following display message appears in the multifunction display:

**Vehicle Ready to Drive Switch the Ignition Off Before Exiting**

If you do not switch off the ignition, it is automatically switched off after three minutes.

### Deactivating or activating the ECO start/stop function

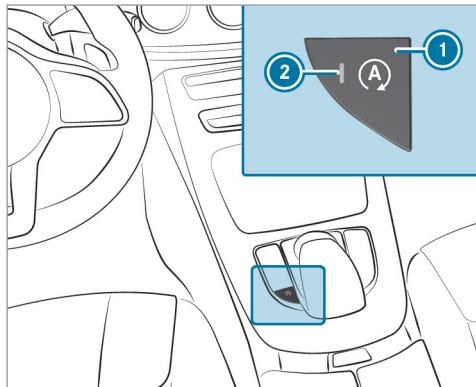

- ▶ Press button ①.  
If indicator lamp ② lights up, the ECO start/stop function is activated.
- ① Depending on the model and the vehicle equipment, the button may also be located at a different position in the center console.

### ECO display function

The ECO display summarizes your driving characteristics from the start of the journey to its completion and assists you in achieving the most economical driving style.

You can influence consumption by doing the following:

- Driving with particular care
- Driving the vehicle in drive program **E**
- Observing the gearshift recommendations



The inner segment will light up and the outer segment will fill up when the following driving style is adopted:

- ① Moderate acceleration
- ② Gentle deceleration and rolling
- ③ Consistent speed

The inner segment will not light up and the outer segment will empty when the following driving style is adopted:

- ① Sporty acceleration
- ② Heavy braking
- ③ Fluctuations in speed

The ECO display will show you when you have driven economically:

- The three outer segments are completely filled simultaneously.
- The ECO display lights up.

The additional range achieved as a result of your driving style in comparison with a driver with a very sporty driving style is shown under **Bonus**

fr. Start. The range displayed does not indicate a fixed reduction in consumption.

## DYNAMIC SELECT switch

### Function of the DYNAMIC SELECT switch

#### **!** NOTE Mercedes-AMG vehicles

- ▶ Observe the notes in the Supplement. You could otherwise fail to recognize dangers.

**i** Depending on the engine and equipment, the vehicle has different drive programs.

Use the DYNAMIC SELECT switch to change between the following drive programs.

The drive program selected appears in the multi-function display of the on-board computer.

#### **I\*** Individual

- Individual settings

#### **S\*** Sport+

- Particularly sporty driving

- Emphasizes the vehicle's own oversteering and understeering characteristics for a more active driving style
- Only suitable for good road conditions, a dry road surface and a clear stretch of road

#### **S** Sports

- Continues to offer stability but with a sporty setup
- Allows the sporty driver a more active driving style
- Only suitable for good road conditions, a dry road surface and a clear stretch of road

#### **C** Comfort

- Comfortable and economical driving
- Balance between traction and stability
- Recommended for all road conditions

#### **E** Eco

- Particularly economical driving
- Balance between traction and stability
- Recommended for all road conditions

**i** The ESP® settings in the drive programs **E** and **C** are designed for stability. Therefore, choose one of these driving programs, especially when transporting roof loads, in trailer operation and when the vehicle is fully loaded or fully occupied.

Depending on the drive program, the following systems change their characteristics:

- Drive:
  - Engine and transmission management
  - Active Distance Assist DISTRONIC
- ESP®
- **Vehicles with AIRMATIC or DYNAMIC BODY CONTROL:** suspension
- Electric power steering

## Selecting the drive program

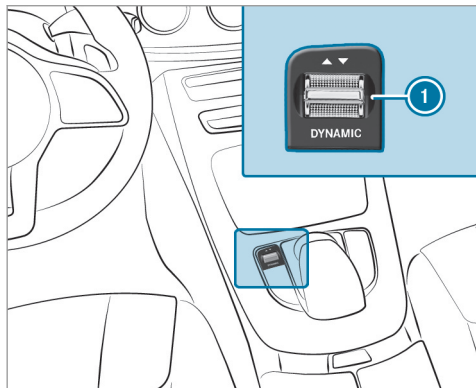

- ▶ Press DYNAMIC SELECT switch ① forwards or backwards.  
The drive program selected appears in the multifunction display.

## Configuring drive program I

Multimedia system:

- ↳ Vehicle ▶  DYNAMIC SELECT
- ▶▶ Individual
- ▶ Select the individual setting.

## Switching the operation feedback for drive programs on or off

Multimedia system:

- ↳ Vehicle ▶  DYNAMIC SELECT
- ▶ Switch **Notification for User** on  or off .  
When this function is active, a corresponding message is shown in the media display when a drive program is selected with the DYNAMIC SELECT switch.

## Displaying vehicle data

Multimedia system:

- ↳ Vehicle ▶  DYNAMIC SELECT
- ▶ Select **Vehicle Data**.  
The vehicle data is displayed.

## Displaying engine data

Multimedia system:

- ↳ Vehicle ▶  DYNAMIC SELECT
- ▶ Select **Engine Data**.

- ⓘ The actual (maximum) values that can be achieved for engine output and engine torque may deviate from the certified values within the country-specific guidelines for permissible tolerances (basis: UN-ECE No. 85 or country-specific guidelines).

Factors that can influence this are, for example:

- Sea level
- Fuel grade
- Outside temperature
- Operating temperature of the engine

- ⓘ The values displayed serve only as orientation. The values for engine output and engine torque shown in the media display may deviate from the actual values.

## Automatic transmission

### DIRECT SELECT lever

#### Function of the DIRECT SELECT lever

**⚠ WARNING** Risk of accident due to incorrect gearshifting

If the engine speed is higher than the idle speed and you engage the transmission position **D** or **R**, the vehicle may accelerate sharply.

▶ If you engage the transmission position **D** or **R** when the vehicle is at a standstill, always depress the brake pedal firmly and do not accelerate at the same time.

**⚠ WARNING** Risk of accident and injury due to children left unattended in the vehicle

If children are left unsupervised in the vehicle, they could, in particular:

- open doors, thereby endangering other persons or road users.
- get out and be struck by oncoming traffic.
- operate vehicle equipment and become trapped, for example.

In addition, the children could also set the vehicle in motion, for example by:

- releasing the parking brake.
- changing the transmission position.
- starting the vehicle.

▶ Never leave children unattended in the vehicle.

▶ When leaving the vehicle, always take the SmartKey with you and lock the vehicle.

▶ Keep the vehicle SmartKey out of reach of children.

Use the DIRECT SELECT lever to switch the transmission position. The current transmission position is displayed in the multifunction display.

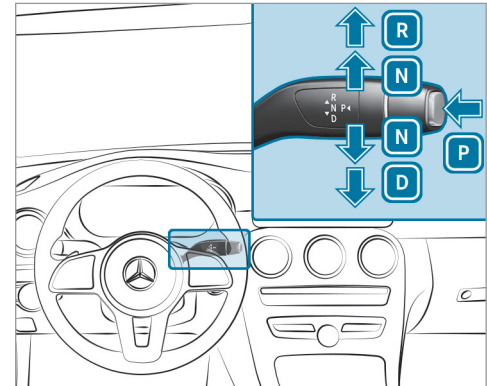

**P** Park position

**R** Reverse gear

**N** Neutral

**D** Drive position

### Engaging reverse gear R

- ▶ Depress the brake pedal and push the DIRECT SELECT lever upwards past the first point of resistance.

### Engaging neutral N

- ▶ Depress the brake pedal and push the DIRECT SELECT lever up or down to the first point of resistance.
- ⓘ To shift into neutral **N** with the ignition on, push the selector lever up or down for several seconds to the first point of resistance.

Subsequently releasing the brake pedal will allow you to move the vehicle freely, e.g. to push it or tow it away.

### Proceed as follows if you want the automatic transmission to remain in neutral **N**, even if the ignition is switched off or the driver's door is opened:

- ▶ Depress the brake pedal and engage neutral **N** when the car is stationary.

- ▶ Release the brake pedal.

- ▶ Switch the ignition off.

- ⓘ If you then exit the vehicle leaving the SmartKey in the vehicle, the automatic transmission remains in neutral **N**.

### Engaging park position P

- ▶ Observe the notes on parking the vehicle (→ page 147).
- ▶ Depress the brake pedal until the vehicle comes to a standstill.
- ▶ When the vehicle is at a standstill, press button **P**.  
When the transmission position display shows **P**, the park position is engaged. If no transmission position display **P** appears, secure the vehicle to prevent it from rolling away.

- ⓘ Depending on the situation, it may take a short time until **P** is engaged. Therefore, always pay attention to the transmission position display.

Park position **P** is engaged automatically if one of the following conditions is met:

- You switch off the ignition when the vehicle is stationary and the transmission position is **D** or **R**.
- You open the driver's door when the vehicle is at a standstill or when driving at a very low speed and the transmission position is **D** or **R**.
- ⓘ To maneuver with an open driver's door, open the driver's door while at a standstill and engage transmission position **D** or **R** again.

### Engaging drive position D

- ▶ Depress the brake pedal and push the DIRECT SELECT lever down past the first point of resistance.

When the automatic transmission is in transmission position **D**, it shifts the gears automatically. This depends, among other things, on the following factors:

- The selected drive program
- The position of the accelerator pedal



- The driving speed

### Problems with the transmission

#### The transmission has a faulty gear shift

Possible cause:

- The transmission is losing oil.
- ▶ Have the transmission checked at a qualified specialist workshop immediately.

#### The acceleration characteristics get worse, and the transmission no longer shifts.

Possible cause:

- The transmission is in emergency operation mode: it is only possible to shift to one gear and reverse gear.
- ▶ Pull over and stop the vehicle safely as soon as possible, paying attention to road and traffic conditions.
- ▶ Shift the transmission to position **P**.
- ▶ Switch off the engine.
- ▶ Wait at least ten seconds.

- ▶ Try to start the engine again.
- ▶ Shift the transmission to position **D** or **R**. If **D** is selected, the transmission only shifts to one gear; if **R** is selected, the transmission shifts to reverse gear.
- ▶ Have the transmission checked at a qualified specialist workshop immediately.

### Manual gearshifting

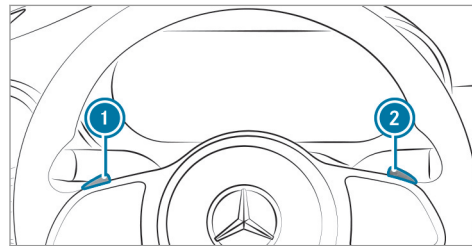

When the automatic transmission is shifted to position **D**, you can manually shift it with the steering wheel gearshift paddle. If permitted, the automatic transmission shifts to a higher or

lower gear depending on the steering wheel gearshift paddle being pulled.

You have two options to manually shift the automatic transmission:

- Temporary setting
- Permanent setting

The gears shift automatically when manual shifting is deactivated.

#### Temporary setting:

- ▶ **To activate:** pull steering wheel gearshift paddle **1** or **2**. Manual shifting is activated for a short time. The transmission position display shows **M** and the current gear.

- i** How long the manual shifting stays activated is dependent on various factors.

Manual shifting can be automatically deactivated in the following cases:

- Changing the drive program
- Restarting the vehicle
- When the transmission position **D** is engaged again

- Driving style

- ▶ **To shift up:** pull steering wheel gearshift paddle ②.
- ▶ **To shift down:** pull steering wheel gearshift paddle ①.
- ▶ **To deactivate:** pull steering wheel gearshift paddle ② and hold it in place. The transmission position display shows **D**.

**Permanent setting:**

- ▶ Change to drive program **I\*** (→ page 140).
- ▶ Select drive setting **M** (→ page 140).

### Gearshift recommendation

The gearshift recommendation assists you in adopting an economical driving style.

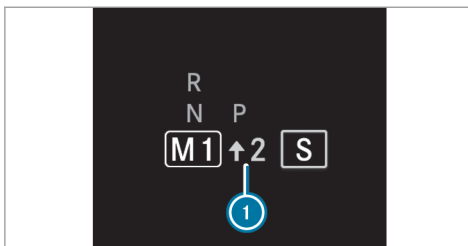

- ▶ If gearshift recommendation ① appears next to the transmission position display, shift to the recommended gear.

### Using kickdown

- ▶ **Maximum acceleration:** depress the accelerator pedal beyond the pressure point.

To protect against engine overrev, the automatic transmission shifts up to the next gear when maximum engine speed has been reached.

### Glide mode function

**!** **NOTE** Mercedes-AMG vehicles

- ▶ Observe the notes in the Supplement. You could otherwise fail to recognize dangers.

With an anticipatory driving style, Glide mode helps you to reduce fuel consumption.

Glide mode is characterized by the following:

- The combustion engine is disconnected from the drivetrain and continues to run in neutral.
- The transmission position display **D** is shown in green.

Glide mode is activated if the following conditions are met:

- Drive program **E** is selected.
- The speed is within a suitable range.
- The road's course is suitable, e.g. no steep uphill or downhill inclines or tight curves.
- You do not depress the accelerator or brake pedal (except for light brake applications).

- i** Glide mode can also be activated if you have selected the "Eco" setting for the drive in the drive program .

Glide mode is deactivated again if one of the conditions is no longer met.

Glide mode can also be prevented by the following parameters:

- Incline
- Downhill gradient
- Temperature
- Height
- Speed
- Operating status of the engine
- Traffic situation

- i** Glide mode can be ended by pressing a steering wheel gearshift paddle (→ page 143).

### Function of the 4MATIC

4MATIC ensures that all four wheels are driven. Together with ESP® and 4ETS, 4MATIC improves

the traction of your vehicle whenever a driven wheel spins due to insufficient traction.

If you fail to adapt your driving style, 4MATIC can neither reduce the risk of an accident nor override the laws of physics. 4MATIC cannot take account of road, weather and traffic conditions. 4MATIC is only an aid. You are responsible especially for maintaining a safe distance from the vehicle in front, for vehicle speed, for braking in good time and for staying in lane.

- i** In wintry road conditions, the maximum effect of 4MATIC can be achieved only if you use winter tires (M+S tires), with snow chains if necessary.

### Refueling

#### Refueling the vehicle

**⚠ WARNING** Risk of fire or explosion from fuel

Fuels are highly flammable.

- ▶ Fire, open flames, smoking and creation of sparks must be avoided.
- ▶ Switch off the ignition and, if available, the stationary heater, before and while refueling the vehicle.

#### **⚠ WARNING** Risk of injury from fuels

Fuels are poisonous and hazardous to your health.

- ▶ Do not swallow fuel or let it come into contact with skin, eyes or clothing.
- ▶ Do not inhale fuel vapor.
- ▶ Keep children away from fuel.
- ▶ Keep doors and windows closed during the refueling process.

If you or other people come into contact with fuel, observe the following:

- ▶ Immediately rinse fuel off your skin with soap and water.
- ▶ If fuel comes into contact with your eyes, immediately rinse them thor-

oroughly with clean water. Seek medical attention immediately.

- ▶ If you swallow fuel, seek medical attention immediately. Do not induce vomiting.
- ▶ Change immediately out of clothing that has come into contact with fuel.

**⚠ WARNING** Risk of fire and explosion due to electrostatic charge

Electrostatic charge can ignite fuel vapor.

- ▶ Before you open the fuel filler cap or take hold of the pump nozzle, touch the metallic vehicle body.
- ▶ To avoid creating another electrostatic charge, do not get into the vehicle again during the refueling process.

**! NOTE** Damage caused by the wrong fuel

Vehicles with a gasoline engine:

Even small amounts of the wrong fuel could result in damage to the fuel system, the engine and the emission control system.

- ▶ Only refuel with low-sulfur gasoline.

This fuel may contain up to 10% ethanol. Your vehicle is suitable for use with E10 fuel.

Never refuel with one of the following fuels:

- Diesel
- Gasoline with more than 10% ethanol by volume, e.g. E15, E85, E100
- Gasoline with more than 3% methanol by volume, e.g. M15, M30, M85, M100
- Gasoline with additives containing metal

If you have accidentally refueled with the wrong fuel:

- ▶ Do not switch the ignition on.
- ▶ Consult a qualified specialist workshop.

**! NOTE** Do not use diesel to refuel vehicles with a gasoline engine

If you have accidentally refueled with the wrong fuel:

- Do not switch the ignition on. Otherwise fuel can enter the engine.

Even small amounts of the wrong fuel could result in damage to the fuel system and the engine. The repair costs are high.

- ▶ Consult a qualified specialist workshop.
- ▶ Have the fuel tank and fuel lines drained completely.

**! NOTE** Damage to the fuel system caused by overfilled fuel tanks

- ▶ Only fill the fuel tank until the pump nozzle switches off.

**!** **NOTE** Fuel may spray out when you remove the fuel pump nozzle

- ▶ Only fill the fuel tank until the pump nozzle switches off.

#### Requirements:

- The vehicle is unlocked.
- ① Do not get into the vehicle again during the refueling process. Otherwise, electrostatic charge could build up again.

Observe the notes on operating fluids and fuel. Only refuel with fuel that has at least the octane number specified in the information label in the fuel filler flap. Otherwise, engine output can be reduced and fuel consumption increased.

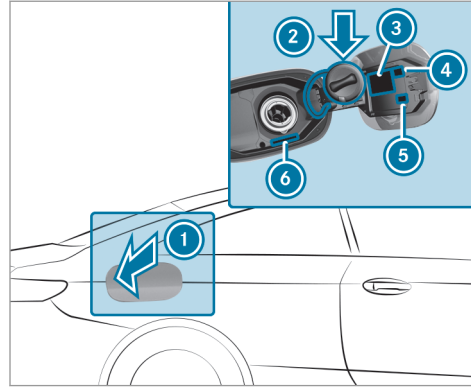

- ① Fuel filler flap
- ② Bracket for fuel filler cap
- ③ Tire pressure table
- ④ QR code for rescue card
- ⑤ Stationary heater indication
- ⑥ Fuel type
- ▶ Press on the back area of fuel filler flap ①.

- ▶ Turn the fuel filler cap counter-clockwise and remove it.
- ▶ Insert fuel filler cap from above into bracket ②.
- ▶ Completely insert the pump nozzle into the tank filler neck, hook in place and refuel.
- ▶ Only fill the fuel tank until the pump nozzle switches off.
- ▶ Replace the cap on the filler neck and turn clockwise until it engages audibly.
- ▶ Close fuel filler flap ①.

## Parking

### Parking the vehicle

**!** **WARNING** Risk of accident and injury caused by an insufficiently secured vehicle rolling away

If the vehicle is not securely parked sufficiently, it can roll away in an uncontrolled way even at a slight downhill gradient.

- ▶ On uphill or downhill gradients, turn the front wheels so that the vehicle rolls towards the curb if it starts moving.
- ▶ Apply the parking brake.
- ▶ Switch the transmission to position **P**.

**⚠ WARNING** Risk of fire caused by hot exhaust system parts

Flammable materials such as leaves, grass or twigs may ignite.

- ▶ Park the vehicle so that no flammable material can come into contact with hot vehicle components.
- ▶ In particular, do not park on dry grass-land or harvested grain fields.

**⚠ WARNING** Risk of accident and injury due to children left unattended in the vehicle

If children are left unsupervised in the vehicle, they could, in particular:

- open doors, thereby endangering other persons or road users.
- get out and be struck by oncoming traffic.
- operate vehicle equipment and become trapped, for example.

In addition, the children could also set the vehicle in motion, for example by:

- releasing the parking brake.
- changing the transmission position.
- starting the vehicle.

- ▶ Never leave children unattended in the vehicle.
- ▶ When leaving the vehicle, always take the SmartKey with you and lock the vehicle.

- ▶ Keep the vehicle SmartKey out of reach of children.

**! NOTE** Damage to the vehicle due to it rolling away

- ▶ Always secure the vehicle against rolling away.

**! NOTE** Damage due to the vehicle lowering

**Vehicles with AIRMATIC or level control:**

The vehicle can lower because of temperature differences or longer non-operational times. This can cause damage to parts of the body.

- ▶ When stopping the vehicle and when driving off, make sure that there are no obstacles such as curbs under or in the immediate vicinity of the body.

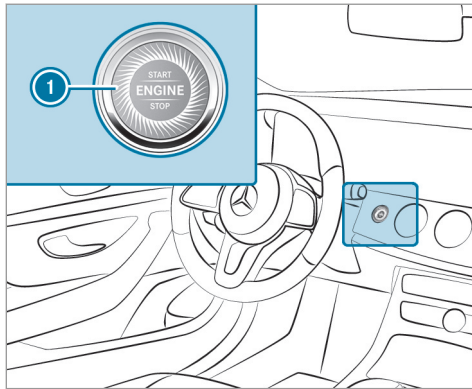

- ▶ Bring the vehicle to a standstill by pressing the brake pedal.
- ▶ On gradients, turn the front wheels so that the vehicle will roll towards the curb if it starts moving.
- ▶ Apply the electric parking brake.

- ▶ Engage transmission position **P** in a stationary vehicle with the brake pedal applied (→ page 142).
  - ▶ Switch off the engine and the ignition by pressing button **1**.
  - ▶ Release the service brake slowly.
  - ▶ Get out of the vehicle and lock it.
- i** When you park the vehicle, you can still operate the side windows and the panoramic sliding sunroof for approximately four minutes if the driver's door is closed.

### Garage door opener

#### Programming buttons for the garage door opener

**⚠ DANGER** Risk of death caused by exhaust gases

Combustion engines emit poisonous exhaust gases such as carbon monoxide. Inhaling these exhaust gases is hazardous to health and leads to poisoning.

- ▶ Never leave the engine or, if present, the auxiliary heating running in an enclosed space without sufficient ventilation.

**⚠ WARNING** Risk of injury when opening or closing a door with the garage door opener

When you operate or program the door with the integrated garage door opener, persons in the range of movement of the door may become trapped or be struck by the door.

- ▶ Always make sure that nobody is within the range of movement of the door.

Only operate the following doors using the garage door opener:

- Doors with a safety stop and reversing feature
- Doors which conform to the current U.S. safety standards

**Requirements:**

- The vehicle has been parked outside the garage or outside the range of movement of the door.
  - The engine is switched off.
  - The ignition is switched on.
- i** The garage door opener function is always available when the ignition is switched on.

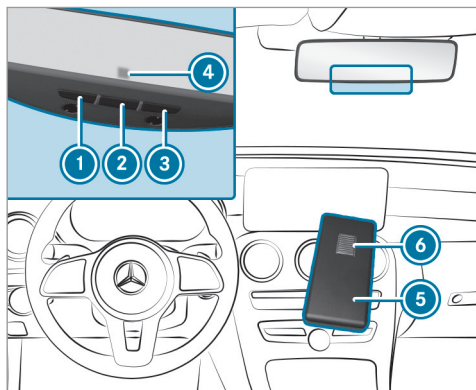

- ▶ Check if the transmitter frequency of the remote control has the frequency range of 280 to 868 MHz.  
Radio equipment approval number:
  - NZLMUAHL5 (USA)
  - 4112A-MUAHL5 (Canada)
- ▶ Press and hold button **1**, **2** or **3** that you wish to program.  
Indicator lamp **4** flashes yellow.
- i** It can take up to 20 seconds before the indicator lamp flashes yellow.
- ▶ Release the previously pressed button.  
Indicator lamp **4** continues to flash yellow.
- ▶ Point remote control **5** from a distance of 0.4 in (1 cm) to 3 in (8 cm) towards button **1**, **2** or **3**.
- ▶ Press and hold button **6** of remote control **5** until one of the following signals appears:
  - Indicator lamp **4** lights up green continuously. Programming is complete.
  - Indicator lamp **4** flashes green. Programming was successful. Additionally,

synchronization of the rolling code with the door system must also be carried out.

- ▶ If indicator lamp **4** does not light up or flash green: repeat the procedure.
- ▶ Release all of the buttons.
- i** The remote control for the door drive is not included in the scope of delivery of the garage door opener.

**Synchronizing the rolling code**

**Requirements:**

- The door system uses a rolling code.
- The vehicle must be within range of the garage door or door drive.
- The vehicle as well as persons and objects are located outside the range of movement of the door.
- ▶ Press the programming button on the door drive unit.  
Initiate the next step within approximately 30 seconds.



- ▶ Press previously programmed button ①, ② or ③ repeatedly until the door closes. When the door closes, programming is completed.
- ⓘ Please also read the operating instructions for the door drive.

### Troubleshooting when programming the remote control

- ▶ Check if the transmitter frequency of remote control ⑤ is supported.
- ▶ Replace the batteries in remote control ⑤.
- ▶ Hold remote control ⑤ at various angles from a distance of 0.4 in (1 cm) to 3 in (8 cm) front of the inside rearview mirror. You should test every position for at least 25 seconds before trying another position.
- ▶ Hold remote control ⑤ at the same angles at various distances in front of the inside rear view mirror. You should test every position for at least 25 seconds before trying another position.

- ▶ On remote controls that transmit only for a limited period, press button ⑥ on remote control ⑤ again before transmission ends.
- ▶ Align the antenna line of the door opener unit with the remote control.
- ⓘ Support and additional information on programming:
  - On the toll free HomeLink® Hotline on 1-800-355-3515
  - On the Internet at <https://www.homelink.com/mercedes>

### Opening or closing the garage door

#### Requirements:

- The corresponding button is programmed to operate the door.
- ▶ Press and hold buttons ①, ② or ③ until the door opens or closes.
- ▶ If indicator lamp ④ flashes yellow after approximately 20 seconds: press and hold the previously pressed button again until the door opens or closes.

### Clearing the garage door opener memory

- ▶ Press and hold buttons ① and ③. Indicator lamp ④ lights up yellow.
- ▶ If indicator lamp ④ flashes green: release buttons ① and ③. The entire memory has been deleted.

### Electric parking brake

#### Function of the electric parking brake (applying automatically)

**⚠ WARNING** Risk of accident and injury due to children left unattended in the vehicle

If children are left unsupervised in the vehicle, they could, in particular:

- open doors, thereby endangering other persons or road users.
- get out and be struck by oncoming traffic.
- operate vehicle equipment and become trapped, for example.

In addition, the children could also set the vehicle in motion, for example by:

- releasing the parking brake.
  - changing the transmission position.
  - starting the vehicle.
- ▶ Never leave children unattended in the vehicle.
  - ▶ When leaving the vehicle, always take the SmartKey with you and lock the vehicle.
  - ▶ Keep the vehicle SmartKey out of reach of children.

**The electric parking brake is applied if the transmission is in position **P** and one of the following conditions is fulfilled:**

- The engine is switched off.
- The seat belt tongue is not inserted in the seat belt buckle of the driver's seat and the driver's door is opened.

**i** To prevent application: pull the handle of the electric parking brake (→ page 153).

**In the following situations, the electric parking brake is also applied:**

- The HOLD function is keeping the vehicle stationary.
- Active Parking Assist is keeping the vehicle stationary.
- Active Distance Assist DISTRONIC is bringing the vehicle to a standstill.
- **In addition, one of the following conditions must be fulfilled:**
  - The engine is switched off.
  - The seat belt tongue is not inserted in the seat belt buckle of the driver's seat and the driver's door is opened.
  - There is a system malfunction.
  - The power supply is insufficient.
  - The vehicle is stationary for a lengthy period.

When the electric parking brake is applied, the red **PARK** (USA) or **P** (Canada) indicator lamp lights up in the instrument cluster.

**i** The electric parking brake is not automatically applied if the engine is switched off by the ECO start/stop function.

**Function of the electric parking brake (releasing automatically)**

**The electric parking brake is released when the following conditions are fulfilled:**

- The driver's door is closed.
- The engine is running.
- The transmission is in position **D** or **R** and you depress the accelerator pedal or you shift from transmission position **P** to **D** or **R** when on level ground.
- If the transmission is in position **R**, the trunk lid must be closed.
- The seat belt tongue is inserted into the seat belt buckle of the driver's seat.

When the electric parking brake is released, the red **PARK** (USA) or **P** (Canada) indicator lamp in the instrument cluster goes out.

## Applying/releasing the electric parking brake manually

### Applying

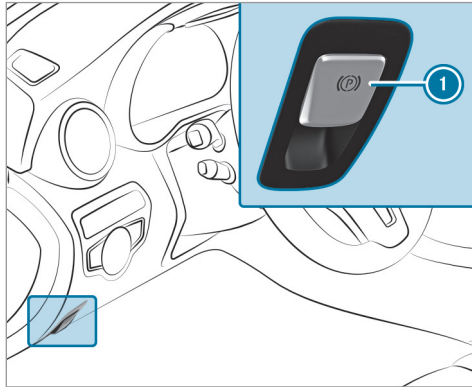

- ▶ Push handle ①.  
The red **PARK** (USA) or **(P)** (Canada) indicator lamp lights up in the instrument cluster.

- ① The electric parking brake is only securely applied if the indicator lamp is lit continuously.

### Releasing

- ▶ Switch on the ignition.
- ▶ Pull handle ①.  
The red **PARK** (USA) or **(P)** (Canada) indicator lamp in the instrument cluster goes out.

### Emergency braking

- ▶ Press and hold handle ①.  
As long as the vehicle is driving, the **Please Release Parking Brake** message is displayed and the red **(P)** indicator lamp flashes.  
When the vehicle has been braked to a standstill, the electric parking brake is applied. The red **PARK** (USA) or **(P)** (Canada) indicator lamp lights up in the instrument cluster.

## Information on collision detection on a parked vehicle

If a collision is detected when the tow-away alarm is armed on a locked vehicle, you will receive a notification in the multimedia system when you switch on the ignition.

You will receive information about the following points:

- The area of the vehicle that may have been damaged.
- The force of the impact.

The following situations can lead to inadvertent activation:

- The parked vehicle is moved, e.g. in a two-story garage.
- ① Deactivate tow-away alarm in order to prevent inadvertent activation. If you deactivate tow-away alarm, collision detection will also be deactivated.

- ❶ If the battery is severely discharged, the function for detecting a collision on a parked vehicle is automatically deactivated to facilitate the next engine start.

### System limits

Detection may be restricted in the following situations:

- The vehicle is damaged without impact, e.g. if an outside mirror is torn off or the paint is damaged by a key
- An impact occurs at low speed
- The electric parking brake is not applied

### Notes on parking the vehicle for an extended period

If you leave the vehicle parked for longer than six weeks, it may suffer damage through disuse.

The 12 V battery may also be impaired or damaged by heavy discharging.

- ❶ Further information can be obtained at a qualified specialist workshop.

### Standby mode (extension of the starter battery's period out of use)

#### Standby mode function

- ❶ This function is not available for all models. If standby mode is activated, energy loss will be minimized during extended periods of non-operation.

Standby mode is characterized by the following:

- The starter battery is preserved.
- The maximum non-operational time appears in the media display.
- The connection to online services is interrupted.
- The ATA (anti-theft alarm system) is unavailable.
- The interior motion sensor and tow-away alarm functions are not available.
- The function for detecting collisions on a parked vehicle is not available.

If the following conditions are fulfilled, standby mode can be activated or deactivated using the multimedia system:

- The engine is switched off.
- The ignition is switched on.

Exceeding the vehicle's displayed non-operational time may cause inconvenience, i.e. it cannot be guaranteed that the starter battery will reliably start the engine.

The starter battery must be charged first in the following situations:

- The vehicle's non-operational time must be extended.
- The **Battery Charge Insufficient for Standby Mode** message appears in the media display.

- ❶ Standby mode is automatically deactivated when the ignition is switched on.

#### Activating/deactivating standby mode

Multimedia system:

➔ **Vehicle** ➔  **Vehicle Settings**  
➔ **Standby Mode**

- ❶ This function is not available for all models.

- ▶ Activate  or deactivate  the function. When you activate the function, a prompt appears.
- ▶ Select **Yes**. Standby mode is activated.

### Driving and driving safety systems

#### Driving systems and your responsibility

Your vehicle is equipped with driving systems which assist you in driving, parking and maneuvering the vehicle. The driving systems are only aids. They are not a substitute for your attention to the surroundings and do not relieve you of your responsibility pertaining to road traffic law. The driver is always responsible for maintaining a safe distance to the vehicle in front, for vehicle speed, for braking in good time and for staying in lane. Pay attention to the traffic conditions at all times and intervene when necessary. Be aware of the limitations regarding the safe use of these systems.

Driving systems can neither reduce the risk of accident if you fail to adapt your driving style nor

override the laws of physics. They cannot always take into account road, weather or traffic conditions.

#### Information on vehicle sensors and cameras

Some driving and driving safety systems use cameras as well as radar or ultrasonic sensors to monitor the area in front of, behind or next to the vehicle.

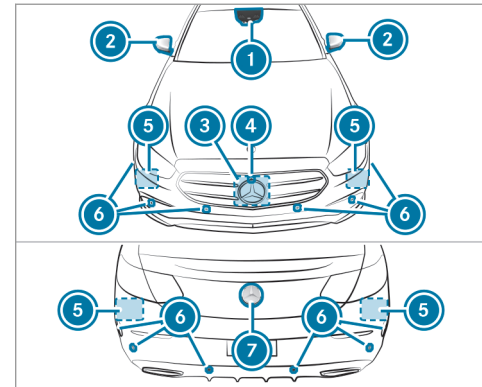

- ① Cameras in the outside mirrors
- ② Multifunction camera
- ③ Front radar
- ④ Front camera
- ⑤ Front camera
- ⑥ Corner radars
- ⑦ Front radar

- 6 Ultrasonic sensors
- 7 Rear view camera

**⚠ WARNING** Risk of accident due to restricted detection performance of vehicle sensors and cameras

If the area around vehicle sensors or cameras is covered, damaged or dirty, certain driving and safety systems cannot function correctly. There is a risk of an accident.

- ▶ Keep the area around vehicle sensors or cameras clear of any obstructions and clean.
- ▶ Have damage to the bumper, radiator grille or stone chipping in the area of the front and rear windows repaired at a qualified specialist workshop.

Particularly, keep the areas around the sensors and cameras free of dirt, ice or slush (→ page 333). The sensors and cameras must not be covered and the detection ranges around them must be kept free. Do not attach additional license plate bracket, advertisements, stickers,

foils or foils to protect against stone chippings in the detection range of the sensors and cameras. Make sure that there are no overhanging loads protruding into the detection range.

If there is damage to a bumper or the radiator grille, or after an impact, have the function of the sensors checked at a qualified specialist workshop. Have damage or stone chipping in the area of the cameras on the windshield and rear window repaired at a qualified specialist workshop.

### Overview of driving systems and driving safety systems

- ABS (**A**nti-lock **B**raking **S**ystem) (→ page 157)
- BAS (**B**rake **A**ssist **S**ystem) (→ page 157)
- ESP® (**E**lectronic **S**tability **P**rogram) (→ page 158)
- ESP® Crosswind Assist (→ page 159)
- EBD (**E**lectronic **B**rakeforce **D**istribution) (→ page 159)

- STEER CONTROL (→ page 159)
- HOLD function (→ page 160)
- Hill Start Assist (→ page 161)
- ATTENTION ASSIST (→ page 161)
- Cruise control (→ page 163)
- Traffic Sign Assist (→ page 180)
- DYNAMIC BODY CONTROL (→ page 187)
- AIRMATIC (→ page 188)

### Driving Assistance package

The following functions are part of the Driving Assistance Package. Certain functions are only available in some countries. Some functions are also available without the Driving Assistance Package, albeit with restricted functionality.

- Active Distance Assist DISTRONIC (→ page 165)
- Active Speed Limit Assist (country-dependent) (→ page 169)
- Route-based speed adaptation (country-dependent) (→ page 169)
- Active Brake Assist (→ page 175)

- Active Steering Assist (country-dependent) (→ page 171)
- Active Emergency Stop Assist (country-dependent) (→ page 173)
- Active Lane Change Assist (country-dependent) (→ page 174)
- Blind Spot Assist and Active Blind Spot Assist with exit warning (→ page 182)
- Active Lane Keeping Assist (→ page 185)

#### Parking Package

- Rear view camera (→ page 190)
- Surround view camera (→ page 192)
- Parking Assist PARKTRONIC (→ page 195)
- Active Parking Assist (→ page 199)

#### Functions of ABS (Anti-lock Braking System)

ABS regulates the brake pressure in critical driving situations:

- During braking, e.g. at maximum full-stop braking or insufficient tire traction, the wheels are prevented from locking.

- Vehicle steerability while braking is ensured.

If ABS intervenes when braking, you will feel a pulsing in the brake pedal. The pulsating brake pedal can be an indication of hazardous road conditions and can serve as a reminder to take extra care while driving.

#### System limits

- ABS is active from speeds of approx. 3 mph (5 km/h).
- ABS may be impaired or may not function if a malfunction has occurred and the yellow  ABS warning lamp lights up continuously in the instrument cluster after the engine is started.

#### Function of BAS

**⚠ WARNING** Risk of an accident caused by a malfunction in BAS (Brake Assist System)

If BAS is malfunctioning, the braking distance in an emergency braking situation is increased.

▶ Depress the brake pedal with full force in emergency braking situations. ABS prevents the wheels from locking.

The Brake Assist System (BAS) supports your emergency braking situation with additional brake force.

If you depress the brake pedal quickly, BAS is activated:

- BAS automatically boosts the brake pressure.
- BAS can shorten the braking distance.
- ABS prevents the wheels from locking.

The brakes will function as usual once you release the brake pedal. BAS is deactivated.

### Function of ESP® (Electronic Stability Program)

**⚠ WARNING** Risk of skidding if ESP® is deactivated

If you deactivate ESP®, ESP® cannot carry out vehicle stabilization.

▶ ESP® should only be deactivated in the following situations.

**! NOTE** Mercedes-AMG vehicles

▶ Observe the notes in the Supplement. You could otherwise fail to recognize dangers.

ESP® can monitor and improve driving stability and traction in the following situations, within physical limits:

- When pulling away on a wet or slippery road.
- When braking.

If the vehicle deviates from the direction desired by the driver, ESP® can stabilize the vehicle by intervening in the following ways:

- One or more wheels are braked.
- The engine output is adapted according to the situation.

When ESP® is deactivated, the  warning lamp lights up continuously:

- Driving stability will no longer be improved.
- The drive wheels could spin.
- ETS/4ETS traction control is still active.

**i** When ESP® is deactivated, you are still assisted by ESP® when braking.

When the  warning lamp flashes, one or several wheels has reached its grip limit:

- Adapt your driving style to suit the current road and weather conditions.
- Do not deactivate ESP®.
- Only depress the accelerator pedal as far as is necessary when pulling away.

Deactivate ESP® in the following situations to improve traction:

- When using snow chains.
- In deep snow.
- On sand or gravel.

**i** Spinning the wheels results in a cutting action, which enhances traction.

If the  ESP® warning lamp lights up continuously, ESP® is not available due to a malfunction.

Observe the following information:

- Warning and indicator lamps (→ page 448)
- Display messages (→ page 401)

### ETS/4ETS (Electronic Traction System)

ETS/4ETS traction control is part of ESP® and makes it possible to pull away and accelerate on a slippery road.

ETS/4ETS can improve the vehicle's traction by intervening in the following ways:

- The drive wheels are braked individually if they spin.



- More drive torque is transferred to the wheel or wheels with traction.

### Influence of drive programs on ESP®

The drive programs enable ESP® to adapt to different weather and road conditions as well as the driver's preferred driving style. Depending on the selected drive program, the appropriate ESP® mode will be activated. You can select the drive programs using the DYNAMIC SELECT switch (→ page 140).

### Function of ESP® Crosswind Assist

ESP® Crosswind Assist detects sudden gusts of side wind and helps the driver to keep the vehicle in the lane:

- ESP® Crosswind Assist is active at vehicle speeds between approx. 47 mph (75 km/h) and 125 mph (200 km/h) when driving straight ahead or cornering slightly.
- The vehicle is stabilized by means of individual brake application on one side.

### Activating/deactivating ESP® (Electronic Stability Program)

Multimedia system:

→ Vehicle ▶  Assistance ▶ ESP

**Mercedes-AMG vehicles:** observe the notes in the Supplement. Otherwise, you may not recognize dangers.

▶ Activate  or deactivate  the function.

ESP® is deactivated if the  ESP® OFF warning lamp lights up continuously in the instrument cluster.

Observe the information on warning lamps and display messages which may be shown in the instrument cluster.

### Function of EBD

Electronic Brakeforce Distribution (EBD) is characterized by the following:

- Monitoring and regulating the brake pressure on the rear wheels.

- Improved driving stability when braking, especially on bends.

### Function of STEER CONTROL

STEER CONTROL assists you by transmitting a noticeable steering force to the steering wheel in the direction required for vehicle stabilization.

This steering recommendation is given in the following situations:

- Both right wheels or both left wheels are on a wet or slippery road surface when you brake
- The vehicle starts to skid

### System limits

STEER CONTROL may be impaired or may not function in the following situations:

- ESP® is deactivated.
- ESP® is malfunctioning.
- The steering is malfunctioning.

If ESP® is malfunctioning, you will be assisted further by the electric power steering.

## HOLD function

### HOLD function

The HOLD function holds the vehicle at a standstill without requiring you to depress the brake pedal, e.g. while waiting in traffic.

The HOLD function is only an aid. The responsibility for the vehicle safely standing still remains with the driver.

### System limits

The HOLD function is only intended to provide assistance when driving and is not a sufficient means of safeguarding the vehicle against rolling away when stationary.

- The incline must not be greater than 30%.

## Activating/deactivating the HOLD function

**⚠ WARNING** Risk of an accident due to the HOLD function being active when you leave the vehicle

If the vehicle is only braked with the HOLD function it could, in the following situations, roll away:

- If there is a malfunction in the system or in the power supply.
- If the HOLD function is deactivated by depressing the accelerator pedal or brake pedal, e.g. by a vehicle occupant.

▶ Always secure the vehicle against rolling away before you leave it.

### Requirements:

- The vehicle is stationary.
- The driver's door is closed or the seat belt on the driver's side is fastened.
- The engine is running or has been automatically switched off by the ECO start/stop function.

- The electric parking brake is released.
- Active Distance Assist DISTRONIC is deactivated.
- The transmission is in position **D**, **R** or **N**.

### Activating the HOLD function

- ▶ Depress the brake pedal, and after a short time quickly depress further until the **HOLD** display appears in the multifunction display.
- ▶ Release the brake pedal.

### Deactivating the HOLD function

- ▶ Depress the accelerator pedal to pull away.
- or
- ▶ Depress the brake pedal until the **HOLD** display disappears from the multifunction display.

The HOLD function is deactivated in the following situations:

- Active Distance Assist DISTRONIC is activated.
- The transmission is shifted to position **P**.

- The vehicle is secured with the electric parking brake.

In the following situations, the vehicle is held by transmission position **P** and/or by the electric parking brake:

- The seat belt is unfastened and the driver's door is opened.
- The vehicle is switched off.
- There is a malfunction in the system or the power supply is insufficient.

### Function of Hill Start Assist

Hill Start Assist holds the vehicle for a short time when pulling away on a hill under the following conditions:

- The transmission is in position **D** or **R**.
- The electric parking brake is released.

This gives you enough time to move your foot from the brake pedal to the accelerator pedal and depress it before the vehicle begins to roll away.

**⚠ WARNING** Risk of accident and injury due to the vehicle rolling away

After a short time, Hill Start Assist no longer holds the vehicle.

- ▶ Swiftly move your foot from the brake pedal to the accelerator pedal. Do not leave the vehicle when it is being held by Hill Start Assist.

### ATTENTION ASSIST

#### Function of ATTENTION ASSIST

ATTENTION ASSIST assists you on long, monotonous journeys, e.g. on highways and trunk roads. If ATTENTION ASSIST detects indicators of fatigue or increasing lapses in concentration on the part of the driver, it suggests taking a break.

ATTENTION ASSIST is only an aid. It cannot always detect fatigue or lapses in concentration in time. The system is not a substitute for a well-rested and attentive driver. On long journeys, take regular breaks in good time that allow for adequate recuperation.

You can choose between two settings:

- **Standard:** normal system sensitivity.
- **Sensitive:** higher system sensitivity. The driver is warned earlier and the attention level detected by ATTENTION ASSIST is adapted accordingly.

If drowsiness or increasing lapses in concentration are detected, the **ATTENTION ASSIST: Take a Break!** warning appears in the Instrument Display. You can acknowledge the message and take a break where necessary. If you do not take a break and ATTENTION ASSIST continues to detect increasing lapses in concentration, you will be warned again after a minimum of 15 minutes.

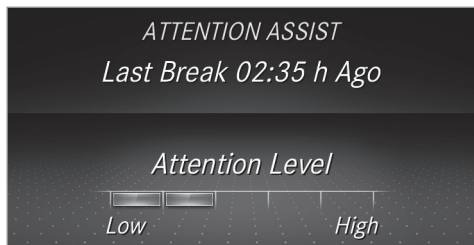

You can have the following status information for ATTENTION ASSIST displayed in the assistance menu of the on-board computer:

- The length of the journey since the last break.
- The attention level determined by ATTENTION ASSIST.

If ATTENTION ASSIST is unable to calculate the attention level and cannot issue a warning, the **System Suspended** message appears.

If a warning is given in the Instrument Display, the multimedia system offers to search for a rest area. You can select a rest area and start naviga-

tion to this rest area. This function can be activated and deactivated in the multimedia system.

If ATTENTION ASSIST is deactivated, the  symbol appears in the assistance graphic in the Instrument Display when the engine is running. ATTENTION ASSIST is activated automatically when the engine is re-started. The last selected sensitivity level remains stored.

#### System limits

ATTENTION ASSIST is active in the 37 mph (60 km/h) to 124 mph (200 km/h) speed range.

Particularly in the following situations, ATTENTION ASSIST only functions in a restricted manner and warnings may be delayed or not occur:

- If you have been driving for less than approximately 30 minutes.
- If the road condition is poor (uneven road surface or potholes).
- If there is a strong side wind.
- If you adopt a sporty driving style (high cornering speeds or high rates of acceleration).
- If Active Steering Assist is activated and active .

- If the time has been set incorrectly.
- If you change lanes and vary your speed frequently In active driving situations.

The ATTENTION ASSIST drowsiness or alertness assessment is reset and restarted when continuing the journey in the following situations:

- If you switch off the engine.
- If you unfasten your seat belt and open the driver's door (e.g. to change drivers or take a break).

#### Setting ATTENTION ASSIST

Multimedia system:

 Vehicle  Assistance  
 ATTENTION ASSIST

#### Setting options

 Select **Standard**, **Sensitive** or **Off**.

#### Suggesting a rest area

 Select **Suggest Rest Area**.

- ▶ Activate  or deactivate the function . If ATTENTION ASSIST detects fatigue or increasing lack of attention, it suggests a rest area in the vicinity.
- ▶ **Select a suggested rest area:** you are guided to the selected rest area.

### Speed control cruise control

#### Function of cruise control

Cruise control regulates the speed to the value selected by the driver.



If you accelerate to overtake, for example, the stored speed is not deleted. If you remove your foot from the accelerator pedal after overtaking, cruise control will resume speed regulation back to the stored speed.

You can store any speed above 15 mph (20 km/h) up to the maximum design speed.

Observe the notes on driving systems and your responsibility; you may otherwise fail to recognize dangers (→ page 155).

**Mercedes-AMG vehicles:** Cruise control is available up to a maximum speed of 155 mph (250 km/h).

#### Displays on the multifunction display

-  (gray): cruise control is selected but not yet activated.
-  (green): cruise control is active.

A stored speed appears along with the  display.

- ⓘ The segments between the stored speed and the end of the segment display light up in the speedometer.

#### System limits

Cruise control may be unable to maintain the stored speed on uphill gradients. The stored speed is resumed when the gradient evens out.

Change into a lower gear in good time on long and steep downhill gradients. Take particular note of this when driving a laden vehicle. By doing so, you will make use of the engine's braking effect. This relieves the load on the brake system and prevents the brakes from overheating and wearing too quickly.

Do not use cruise control in the following situations:

- In traffic situations which require frequent changes of speed, e.g. in heavy traffic, on winding roads.
- On slippery roads. Accelerating can cause the drive wheels to lose traction and the vehicle could then skid.
- If you are driving when visibility is poor.

#### Operating cruise control

**⚠ WARNING** Risk of accident due to stored speed

If you call up the stored speed and this is lower than your current speed, the vehicle decelerates.

- ▶ Take into account the traffic situation before calling up the stored speed.

#### Requirements:

- ESP® must be activated, but not intervening.
- The vehicle speed is at least 15 mph (20 km/h).

- The transmission is in position **D**.

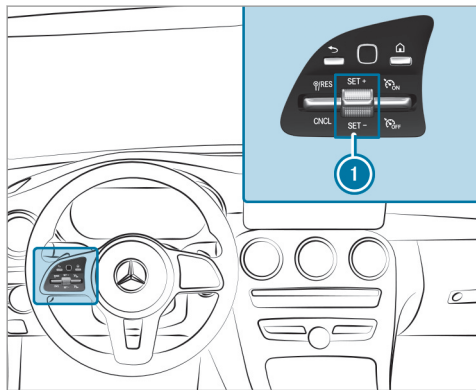

### Operating cruise control

- ▶ Press the rocker switches on the steering wheel control panel up or down to the desired position.

### Activating cruise control

- ▶ Select **ON** with the right rocker switch.

### Activating cruise control

- ▶ Press rocker switch **1** up **SET+ / RES** or down **SET- / RES**.  
The current speed is stored and maintained by the vehicle.

or

- ▶ Select **RES/SP** with the left rocker switch.  
The last stored speed is called up and maintained by the vehicle.

If the last stored speed has previously been deleted, the current vehicle speed is stored.

- i** When you switch off the vehicle, the last speed stored is deleted.

### Increasing or decreasing the stored speed

- ▶ 1 mph (1 km/h): press rocker switch **1** up **SET+ / RES** or down **SET- / RES** to the pressure point.

or

- ▶ 5 mph (10 km/h): press rocker switch **1** up **SET+ / RES** or down **SET- / RES** beyond the pressure point.

or

- ▶ Accelerate the vehicle to the desired speed and press rocker switch **1** up **SET+ / RES**.

### Adopting a detected speed

- ▶ Activate cruise control.
- ▶ If a traffic sign has been detected and is displayed in the instrument cluster: select **RES/SP** with the left rocker switch.  
The maximum permissible speed shown by the traffic sign is stored and the vehicle maintains or does not exceed this speed.

### Deactivating cruise control

- ▶ Select **CNCL** with the left rocker switch.

### Deactivating cruise control

- ▶ Select **OFF** with the right rocker switch.
- i** If you brake, deactivate ESP® or if ESP® intervenes, cruise control is deactivated.

## Active Distance Assist DISTRONIC

### Function of Active Distance Assist DISTRONIC

Active Distance Assist DISTRONIC maintains the set speed on free-flowing roads. If vehicles in front are detected, the set distance is maintained, if necessary, until the vehicle comes to a halt. The vehicle accelerates or brakes depending on the distance to the vehicle in front and the set speed. The speed and distance to the vehicle in front are set and saved using the steering wheel.

Available speed range:

- **Vehicles without Driving Assistance Package:** 15 mph (20 km/h) - 120 mph (200 km/h)
- **Vehicles with Driving Assistance Package:** 15 mph (20 km/h) - 130 mph (210 km/h)

Other features of Active Distance Assist DISTRONIC:

- Adjusts the driving style depending on the selected drive program (fuel-saving, comfortable or dynamic)
- Initiates acceleration to the stored speed if the turn signal indicator is switched on to change to the overtaking lane
- **Vehicles with Driving Assistance Package:**
  - Reacts to stationary vehicles detected in urban speed ranges (except bicycles and motorcycles)
  - Takes one-sided overtaking restrictions into account on highways or on multi-lane roads with separate roadways (country-dependent)

**Vehicles with Driving Assistance Package and Parking Package:** if the vehicle has been braked to a standstill on multi-lane, separate roadways by Active Distance Assist DISTRONIC, it can automatically follow the vehicle in front when driving off again within 30 seconds. If a

critical situation is detected when driving off, a visual and acoustic warning is given indicating that the driver must now take control of the vehicle. The vehicle is not accelerated any further. Observe the notes on driving systems and your responsibility; you may otherwise fail to recognize dangers (→ page 155).

### Active Distance Assist DISTRONIC displays in the instrument cluster

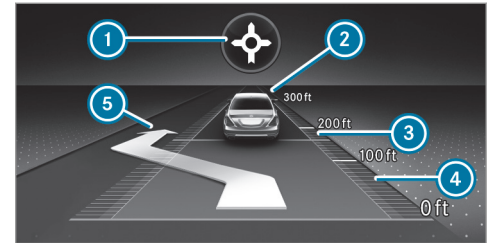





Assistant display

- ① Route-based speed adaptation: type of route event (→ page 169)
- ② Vehicle in front

- ③ Distance indicator
- ④ Set specified distance
- ⑤ Active Lane Change Assist lane change display

### Permanent status display of Active Distance Assist DISTRONIC

-  (white): Active Distance Assist DISTRONIC selected, specified distance set
-  (white vehicle, green speedometer): Active Distance Assist DISTRONIC active, specified distance set and vehicle detected
-  (green): Active Distance Assist DISTRONIC active, specified distance set and vehicle detected
- : Route-based speed adaptation active (→ page 169).

The stored speed is shown along with the permanent status display and highlighted on the speedometer. When Active Distance Assist DISTRONIC is passive, the speed is grayed out.

- ① On highways or high-speed major roads, the green  vehicle symbol is displayed cyclically when the vehicle is ready to pull away.

- ① If you depress the accelerator pedal beyond the setting of the Active Distance Assist DISTRONIC, the system is switched to passive mode. The  **Suspended** message appears in the multifunction display.

### Display on the speedometer

The stored speed is highlighted on the speedometer. If the speed of the vehicle in front or the speed adjustment for the route event ahead is less than the stored speed, the segments in the speedometer light up. The multifunction display shows the deactivation of Active Distance Assist DISTRONIC, as well as alterations to the speed due to manual or automatic adoption of the maximum permissible speed.

### System limits

The system may be impaired or may not function in the following situations, for example:

- In snow, rain, fog, heavy spray, if there is glare, in direct sunlight or in greatly varying ambient light.
- The windshield in the area of the camera is dirty, fogged up, damaged or covered.
- If the radar sensors are dirty or covered.
- In parking garages or on roads with steep uphill or downhill gradients.
- If there are narrow vehicles in front, such as bicycles or motorcycles.

In addition, on slippery roads, braking or accelerating can cause one or several wheels to lose traction and the vehicle could then skid.

Do not use Active Distance Assist DISTRONIC in these situations.

**⚠ WARNING** Risk of accident from acceleration or braking by Active Distance Assist DISTRONIC

Active Distance Assist DISTRONIC may accelerate or brake in the following cases, for example:

- If the vehicle pulls away using Active Distance Assist DISTRONIC.
- If the stored speed is called up and is considerably faster or slower than the currently driven speed.



- If Active Distance Assist DISTRONIC no longer detects a vehicle in front or does not react to relevant objects.

- ▶ Always carefully observe the traffic conditions and be ready to brake at all times.
- ▶ Take into account the traffic situation before calling up the stored speed.

**⚠ WARNING** Risk of accident due to insufficient deceleration by Active Distance Assist DISTRONIC

Active Distance Assist DISTRONIC brakes your vehicle with up to 50% of the possible deceleration. If this deceleration is not sufficient, Active Distance Assist DISTRONIC alerts you with a visual and acoustic warning.

- ▶ Adjust your speed and maintain a suitable distance from the vehicle in front.
- ▶ Brake the vehicle yourself and/or take evasive action.

**⚠ WARNING** Risk of accident if detection function of Active Distance Assist DISTRONIC is impaired

Active Distance Assist DISTRONIC does not react or has a limited reaction:

- when driving on a different lane or when changing lanes
- to pedestrians, animals, bicycles or stationary vehicles, or unexpected obstacles
- to complex traffic conditions
- to oncoming vehicles and crossing traffic

As a result, Active Distance Assist DISTRONIC may neither give warnings nor intervene in such situations.

- ▶ Always observe the traffic conditions carefully and react accordingly.

### Operating Active Distance Assist DISTRONIC

#### Requirements:

- The electric parking brake is released.
- ESP® is activated and is not intervening.

- The transmission is in position **D**.
- The driver's door is closed.
- Check of the radar sensor system has been successfully completed.
- Parking Assist PARKTRONIC is not being used to park the vehicle or to exit from a parking space.

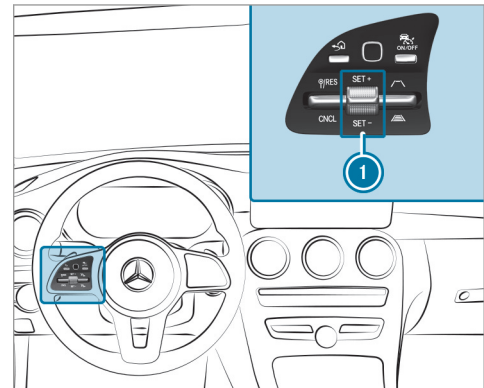





▶ **To operate Active Distance Assist**

**DISTRONIC:** press the rocker switches on the steering wheel control unit up or down to the desired position.

**Activating/deactivating Active Distance Assist DISTRONIC**

▶ Press the  button.

**Activating Active Distance Assist DISTRONIC**

▶ **To activate without a stored speed:** press rocker switch  up  or down , or select  with the left rocker switch.

or

▶ **To activate with a stored speed:** select  with the left rocker switch.

▶ Remove your foot from the accelerator pedal. The current speed is stored and maintained by the vehicle.

**Adopting a detected speed limit**

▶ Activate Active Distance Assist DISTRONIC.

▶ If a traffic sign has been detected and is displayed in the instrument cluster: select  with the left rocker switch.

The maximum permissible speed on the traffic sign is adopted as the stored speed. The vehicle adapts its speed to that of the vehicle in front, but only up to the stored speed.

**Pulling away with Active Distance Assist DISTRONIC**

▶ Activate Active Distance Assist DISTRONIC and remove your foot from the brake pedal.

▶ Select  with the left rocker switch.

or

▶ Depress the accelerator pedal briefly and firmly.

The functions of Active Distance Assist DISTRONIC continue to be carried out.

**Deactivating Active Distance Assist DISTRONIC**

**⚠ WARNING** Risk of an accident due to Active Distance Assist DISTRONIC being active when you leave the driver's seat



If you leave the driver's seat while the vehicle is being braked by Active Distance Assist DISTRONIC only, the vehicle can roll away.

▶ Always deactivate Active Distance Assist DISTRONIC and secure the vehicle to prevent it from rolling away before you leave the driver's seat.



▶ Select  with the left rocker switch.

 If you brake, deactivate ESP® or if ESP® intervenes, Active Distance Assist DISTRONIC is deactivated.



**Increasing or decreasing the speed**

▶ 1 mph (1 km/h): press rocker switch  up  or down  to the pressure point.



or

▶ 5 mph (10 km/h): press rocker switch  up  or down  beyond the pressure point.

or

- ▶ Accelerate the vehicle to the desired speed and press rocker switch  up .

#### Changing the specified distance to the vehicle in front

- ▶ **To reduce the specified distance:** press the right rocker switch up .
- ▶ **To increase the specified distance:** press the right rocker switch down .

#### Function of Active Speed Limit Assist

If a change in the speed limit of 12 mph (20 km/h) or more is detected and automatic adoption of speed limits is activated, the new speed limit is automatically adopted as the stored speed (→ page 181).

The driven speed is adjusted when the vehicle is level with the traffic sign at the latest. In the case of signs indicating entry into an urban area, the speed is adapted according to the speed permitted within the urban area. The speed limit display in the Instrument Display is always updated when the vehicle is level with the traffic sign.

If there is no speed restriction on an unlimited stretch of road (e.g. on a freeway), the recommended speed is automatically adopted as the stored speed. The system uses the speed stored on an unlimited stretch of road as the recommended speed. If you do not alter the stored speed on an unlimited stretch of road, the recommended speed is 80 mph (130 km/h).

If Active Distance Assist DISTRONIC has been put into passive mode by pressing the accelerator pedal, only speed limits which are higher than the set speed are adopted.

Observe the notes on driving systems and your responsibility; you may otherwise fail to recognize dangers (→ page 155).

#### System limits

The system limits of Traffic Sign Assist apply to the detection of traffic signs (→ page 180).

Speed limits below 12 mph (20 km/h) are not automatically adopted by the system as the stored speed. Temporary speed restrictions (e.g. for a certain time or due to weather conditions) cannot be properly detected by the system. The

maximum permissible speed applying to a vehicle with a trailer is not detected by the system.

Adjust the speed in these situations.

**⚠ WARNING** Risk of accident due to Active Speed Limit Assist adapting the vehicle's speed

The speed adopted by Active Speed Limit Assist may be too high or incorrect in some individual cases, such as:

- at speed limits below 12 mph (20 km/h)
  - in wet conditions or in fog
  - when towing a trailer
- ▶ Ensure that the driven speed complies with traffic regulations.
  - ▶ Adjust the driving speed to suit current traffic and weather conditions.

#### Function of route-based speed adaptation

When Active Distance Assist DISTRONIC is activated, the vehicle speed will be adapted accordingly to the route events ahead. Depending on the drive program selected, the vehicle negoti-

ates a route event ahead in an economical, comfortable or dynamic manner. When the route event has been passed, the vehicle accelerates again to the stored speed. The set distance to the vehicle in front, vehicles detected ahead and speed restrictions ahead are taken into account.

You can activate and deactivate route-based speed adaptation in the multimedia system (→ page 171).

The following route events are taken into account:

- Curves
- T-intersections, roundabouts and toll plazas
- Turns and exits
- Traffic jams ahead (only with Live Traffic Information (→ page 265))

**i** When the toll station is reached, Active Distance Assist DISTRONIC adopts the speed as the stored speed.

Also, the speed is reduced if the turn signal indicator to change lanes is switched on and one of the following situations is detected:

- Turning off at intersections

- Driving on slowing-down lanes
- Driving on lanes adjacent to slowing-down lanes

The driver is responsible for choosing the right speed and observing other road users. This applies in particular to intersections, roundabouts and traffic lights, as route-based speed adaptation does not brake the vehicle to a standstill.

When route guidance is active, the first speed adjustment is carried out automatically. If the turn signal indicator is switched on, the selected route is confirmed and further speed adjustment is activated.

Speed adaptation is canceled in the following cases:

- If the turn signal indicator is switched off before the route event.
- If the driver depresses the accelerator or brake pedal during the process.

### System limits

Route-based speed adaptation does not take right of way regulations into account. The driver

is responsible for complying with road traffic regulations and driving at a suitable speed.

The speed adaptation made by the system may not always be suitable, particularly in the following situations:

- The road's course not clearly visible
- Road narrowing
- Varying maximum permissible speeds in individual lanes, for example at toll plazas
- Wet road surfaces, snow or ice

In these situations the driver must intervene accordingly.

**⚠ WARNING** Risk of accident in spite of route-based speed adaptation

Route-based speed adaptation can malfunction or be temporarily unavailable in the following situations:

- If the driver does not follow the calculated route
- If map data is not up-to-date or available

- In the event of roadworks
  - In bad weather or road conditions
  - If the accelerator pedal is depressed
  - In the event of electronically displayed speed limitations
- ▶ Adapt the speed to the traffic situation.

### Setting route-based speed adjustment

#### Requirements:

- Active Distance Assist DISTRONIC is activated.

Multimedia system:

→ Vehicle → Assistance  
→ Speed Adjustment

- ▶ Activate  or deactivate  the function.

### Active Steering Assist

#### Function of Active Steering Assist





Active Steering Assist is only available up to a speed of 130 mph (210 km/h). The system helps you to stay in the center of the lane by means of



moderate steering interventions. Depending on the speed driven, Active Steering Assist uses the vehicles ahead and lane markings as a reference.

- ① Depending on the country, in the lower speed range Active Steering Assist can use the surrounding traffic as a reference. If necessary, Active Steering Assist can then also provide assistance when driving outside the center of the lane, for example, to form a rescue lane.

If the detection of lane markings and vehicles ahead is impaired, Active Steering Assist switches to passive mode. The system provides no support in this case.

#### Status display of Active Steering Assist in the multifunction display

-  (gray): activated and passive
-  (green): activated and active
-  (red): system limits detected
-  (white, red hands): "hands on the steering wheel" prompt

- ① During the transition from active to passive status, the  symbol is shown as enlarged and flashing. Once the system is passive, the  symbol is shown as gray in the multifunction display.
- ① Depending on the selected vehicle settings, Active Steering Assist may be unavailable.

#### Steering and touch detection

The driver is required to keep their hands on the steering wheel at all times and be able to intervene at any time to correct the course of the vehicle and keep it in lane. The driver must expect a change from active to passive mode or vice versa at any time.



If the system detects that the driver has not steered the vehicle for a considerable period of time or has removed their hands from the steering wheel, display  appears. If the driver still does not steer the vehicle, a warning tone sounds in addition to the visual warning message.

If the driver does not react to the warning for a considerable period, the system can initiate an emergency stop (→ page 173).

The warning is not issued or is stopped when the driver gives confirmation to the system:

- The driver steers the vehicle.
- **Depending on the country:** the driver presses a steering wheel button or operates Touch Control

If Active Steering Assist detects that a system limit has been reached, a visual warning is issued and a warning tone sounds.

Observe the notes on driving systems and your responsibility; you may otherwise fail to recognize dangers (→ page 155).

### System limits

Active Steering Assist has a limited steering torque for lateral guidance. In some cases, the steering intervention is not sufficient to keep the vehicle in the lane or to drive through exits.

The system may be impaired or may not function in the following instances:

- There is poor visibility, e.g. due to snow, rain, fog, heavy spray, greatly varying ambient light or strong shadows on the road.
- There is glare, e.g. from oncoming traffic, direct sunlight or reflections.
- Insufficient road illumination.
- The windshield is dirty, fogged up, damaged or covered in the vicinity of the camera, e.g. by a sticker.
- No, or several, unclear lane markings are present for one lane, or the markings change quickly, for example, in a construction area or intersections.
- The lane markings are worn away, dark or covered up, e.g. by dirt or snow.

- If the distance to the vehicle in front is too short and thus the lane markings cannot be detected.
- The road is narrow and winding.
- There are obstacles on the lane or projecting out into the lane, such as object markers.

The system does not provide assistance in the following conditions:

- On tight curves and when turning.
- When crossing intersections.
- At roundabouts or toll plazas.
- When the tire pressure is too low.

 **WARNING** Risk of accident if Active Steering Assist unexpectedly stops functioning

If the system limits of Active Steering Assist are reached there is no guarantee that the system will remain active or will keep the vehicle in lane.

- ▶ Always keep your hands on the steering wheel and observe the traffic carefully.

- ▶ Always steer the vehicle paying attention to traffic conditions.

**⚠ WARNING** Risk of accident if Active Steering Assist unexpectedly intervenes

The detection of lane markings and objects may malfunction and cause unexpected steering interventions.

- ▶ Steer according to traffic conditions.

### Activating Active Steering Assist

#### Requirements:

- ESP® must be activated, but not intervening.
- Active Distance Assist DISTRONIC is activated.

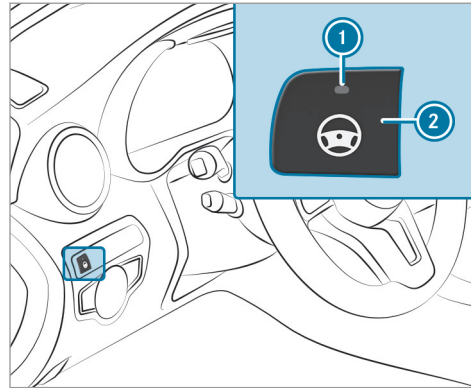

- ▶ If indicator lamp ① is off: press button ②.

### Function of Active Emergency Stop Assist

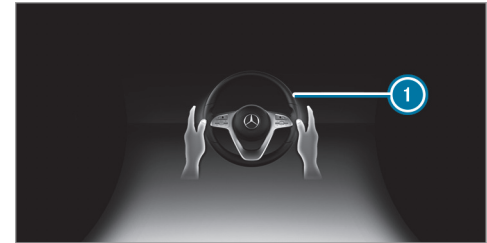

If the system detects that the driver has not steered the vehicle for a considerable period of time or has removed their hands from the steering wheel, display ① appears in the multifunction display. If the driver still does not steer the vehicle, or gives no confirmation to the system, a warning tone sounds in addition to the visual warning message.

If the driver still does not respond to the warning, the **Beginning Emergency Stop** message appears in the multifunction display. If the driver still does not respond, Active Distance Assist

DISTRONIC reduces the speed. The vehicle is decelerated in stages to a standstill.

Depending on the country, at speeds below 40 mph (60 km/h) the hazard warning lights switch on automatically.

When the vehicle is stationary, the following actions are carried out:

- The vehicle is secured with the electric parking brake.
- Active Distance Assist DISTRONIC is ended
- The vehicle is unlocked.
- If possible, an emergency call is placed to the Mercedes-Benz emergency call center

The driver can cancel the deceleration at any time by performing one of the following actions:

- Steering
- Braking or accelerating
- Deactivating Active Distance Assist DISTRONIC

### Active Lane Change Assist

#### Function of Active Lane Change Assist



Active Lane Change Assist supports the driver when changing lanes by applying steering torque if the driver operates a turn signal indicator.

Observe the notes on driving systems and your responsibility; you may otherwise fail to recognize dangers (→ page 155).

Assistance when changing lanes is provided if all the following conditions are met:

- You are driving on a freeway or road with multiple lanes in the direction of travel.
- The neighboring lane is separated by a broken lane marking.
- No vehicle is detected in the adjacent lane.
- The vehicle speed is between 50 mph (80 km/h) and 110 mph (180 km/h).
- Active Lane Change Assist is switched on in the multimedia system.
- Active Steering Assist is activated and active.

If no vehicle is detected in the adjacent lane and a lane change is permitted, the lane change

begins after the driver has activated the turn signal indicator. This is shown to the driver with a green arrow next to the  steering wheel symbol. The message, for example, also appears. If Active Lane Change Assist has been activated with the turn signal indicator but a lane change is not immediately possible, a gray arrow appears next to the  steering wheel symbol, which remains green.

When the lane change assistance starts, the turn signal indicator is automatically activated along with the display in the multifunction display.

If the assistance graphic is shown when changing lanes, an additional arrow appears in it pointing towards the adjacent lane (→ page 165).

If a lane change is not possible, the arrow is faded out after a few seconds and a new lane change must be initiated. An immediate lane change is only possible on freeway sections without speed limits.

If the system is impaired, Active Lane Change Assist may be canceled. If it is canceled, the message appears in the multifunction display.



In addition, a warning tone may sound, depending on the situation.

**⚠ WARNING** Risk of accident when changing lane to an occupied adjacent lane

Lane Change Assist cannot always clearly detect if the adjacent lane is free.

The lane change might be initiated although the adjacent lane is not free.

- ▶ Before changing lanes, make sure that the neighboring lane is free and there is no danger to other road users.
- ▶ Monitor the lane change.

**⚠ WARNING** Risk of accident if Lane Change Assist unexpectedly stops functioning

If the system limitations for Lane Change Assist have been reached, there is no guarantee that the system will remain active.

Lane Change Assist cannot then assist you by applying steering torque.

- ▶ Always monitor the lane change and keep your hands on the steering wheel. Observe the traffic conditions and steer and/or brake if necessary.

### System limits

The system limitations of Active Steering Assist apply to Active Lane Change Assist (→ page 171).

The system may also be impaired or may not function in the following situations:

- The sensors in the rear bumper are dirty, damaged or covered by a sticker or ice and snow, for example.
- The exterior lighting shows a malfunction.
- ⓘ The Active Lane Change Assist sensors adjust automatically while a certain distance is being driven after the vehicle has been delivered. Active Lane Change Assist is unavailable or only partially available during this teach-in process; no arrow appears next to the  Active Steering Assist symbol when the turn signal indicator is activated.

### Activating/deactivating Active Lane Change Assist

Multimedia system:

▶  Vehicle ▶  Assistance

▶ Select Lane Change Assist.

▶ Activate  or deactivate  the function.

### Active Brake Assist

#### Function of Active Brake Assist

Active Brake Assist consists of the following functions:

- Distance warning function
- Autonomous braking function
- Situation-dependent braking assistance
- **Vehicles with Driving Assistance Package:** Evasive Steering Assist and cornering function

Active Brake Assist can help you to minimize the risk of a collision with vehicles, cyclists or pedestrians or to reduce the effects of such a collision.

If Active Brake Assist has detected a risk of collision, a warning tone sounds and the  distance warning lamp lights up in the instrument cluster.

If you do not react to the warning, autonomous braking can be initiated in critical situations.

In especially critical situations, Active Brake Assist can initiate autonomous braking directly. In this case, the warning lamp and warning tone occur simultaneously with the braking application.

If you apply the brake yourself in a critical situation or apply the brake during autonomous braking, situation-dependent braking assistance occurs. The brake pressure increases up to maximum full-stop braking if necessary.

Observe the notes on driving systems and your responsibility; you may otherwise fail to recognize dangers (→ page 155).

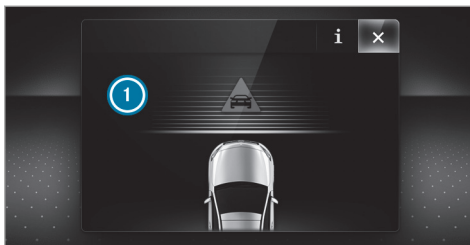

If autonomous braking or situation-dependent braking assistance has occurred, display ① appears in the multifunction display and then automatically goes out after a short time.

**⚠ WARNING** Risk of an accident caused by limited detection performance of Active Brake Assist

Active Brake Assist cannot always clearly identify objects and complex traffic situations.

Active Brake Assist is only an aid. The driver is responsible for maintaining a sufficiently

safe distance to the vehicle in front, vehicle speed and for braking in good time.

- ▶ Always pay careful attention to the traffic situation; do not rely on Active Brake Assist alone.
- ▶ Be prepared to brake or swerve if necessary.

Also observe the system limits of Active Brake Assist.

**The individual subfunctions are available in various speed ranges:**

The distance warning function can issue a warning in the following situations:

- From approximately 4 mph (7 km/h), if your vehicle is critically close to a vehicle, cyclist or pedestrian, you will hear an intermittent warning tone and the  distance warning lamp lights up in the instrument cluster.

Brake immediately or take evasive action, provided it is safe to do so and the traffic situation allows this.

**Distance warning function (vehicles without Driving Assistance Package)**

The distance warning function can aid you in the following situations with an intermittent warning tone and a warning lamp:

- At speeds up to approximately 155 mph (250 km/h) when approaching vehicles ahead
- At speeds up to approximately 50 mph (80 km/h) when approaching stationary vehicles, moving pedestrians, and cyclists ahead.
- At speeds up to approximately 37 mph (60 km/h) when approaching crossing cyclists

**Distance warning function (vehicles with Driving Assistance Package)**

The distance warning function can aid you in the following situations with an intermittent warning tone and a warning lamp:

- At speeds up to approximately 155 mph (250 km/h) when approaching vehicles ahead

- At speeds up to approximately 62 mph (100 km/h) when approaching stationary vehicles
- At speeds up to approximately 50 mph (80 km/h) when approaching moving pedestrians and cyclists ahead
- At speeds up to approximately 43 mph (70 km/h) when approaching stationary pedestrians, crossing vehicles and stationary and crossing cyclists

**Autonomous braking function (vehicles without Driving Assistance Package)**

If the vehicle is traveling at speeds above approximately 4 mph (7 km/h), the autonomous braking function may intervene in the following situations:

- At speeds up to approximately 124 mph (200 km/h) when approaching vehicles ahead
- At speeds up to approximately 50 mph (80 km/h) when approaching cyclists ahead

- At speeds up to approximately 37 mph (60 km/h) when approaching moving pedestrians and crossing cyclists
- At speeds up to approximately 31 mph (50 km/h) when approaching stationary vehicles

**Autonomous braking function (vehicles with Driving Assistance Package)**

If the vehicle is traveling at speeds above approximately 4 mph (7 km/h), the autonomous braking function may intervene in the following situations:

- At speeds up to approximately 155 mph (250 km/h) when approaching vehicles ahead
- At speeds up to approximately 62 mph (100 km/h) when approaching stationary vehicles
- At speeds up to approximately 50 mph (80 km/h) when approaching cyclists ahead
- At speeds up to approximately 43 mph (70 km/h) when approaching stationary and

moving pedestrians, crossing vehicles and stationary and crossing cyclists

**Situation-dependent braking assistance (vehicles without Driving Assistance Package)**

The situation-dependent braking assistance can intervene from a speed of approximately 4 mph (7 km/h) in the following situations:

- At speeds up to approximately 155 mph (250 km/h) when approaching vehicles ahead
- At speeds up to approximately 50 mph (80 km/h) when approaching stationary vehicles and vehicles ahead
- At speeds up to approximately 37 mph (60 km/h) when approaching moving pedestrians and crossing cyclists

**Situation-dependent braking assistance (vehicles with Driving Assistance Package)**

The situation-dependent braking assistance can intervene from a speed of approximately 4 mph (7 km/h) in the following situations:

- At speeds up to approximately 155 mph (250 km/h) when approaching vehicles ahead
- At speeds up to approximately 62 mph (100 km/h) when approaching stationary vehicles
- At speeds up to approximately 50 mph (80 km/h) when approaching cyclists ahead
- At speeds up to approximately 37 mph (60 km/h) when approaching stationary and moving pedestrians, crossing vehicles, and stationary and crossing cyclists

**Canceling a brake application of Active Brake Assist**

You can cancel a brake application of Active Brake Assist at any time by:

- Sharply depressing the accelerator pedal or with kickdown

- Releasing the brake pedal

Active Brake Assist may cancel the brake application when one of the following conditions is fulfilled:

- You maneuver to avoid the obstacle
- There is no longer a risk of collision
- An obstacle is no longer detected in front of your vehicle

**Evasive Steering Assist (only vehicles with Driving Assistance Package)**

Evasive Steering Assist has the following characteristics:

- The ability to detect stationary or moving pedestrians.
- Assistance through power-assisted steering if it detects a swerving maneuver.
- Activation by an abrupt steering movement during a swerving maneuver.
- Assistance during swerving and straightening of the vehicle.

- Reaction from a speed of approximately 12 mph (20 km/h) up to a speed of approximately 43 mph (70 km/h).

You can prevent the assistance at any time by actively steering.

### Cornering function (only vehicles with Driving Assistance Package)

If the system detects a risk of a collision with an oncoming vehicle when turning across an oncoming lane, autonomous braking can be initiated at speeds below 9 mph (15 km/h) before you have left the lane in which you are driving.

**⚠ WARNING** Risk of accident despite Evasive Steering Assist

Evasive Steering Assist cannot always recognize objects or complex traffic situations clearly.

Moreover, the steering support provided by Evasive Steering Assist is not sufficient to avoid a collision.

- ▶ Always pay careful attention to the traffic situation; do not rely on Evasive Steering Assist alone.
- ▶ Be prepared to brake or swerve if necessary.
- ▶ End the support by actively steering in non-critical situations.
- ▶ Drive at an appropriate speed if there are pedestrians close to the path of your vehicle.

### System limits

Full system performance is not available for a few seconds after switching on the ignition or after driving off.

If Active Brake Assist is impaired or inoperative due to a malfunction, the  warning lamp appears in the multifunction display.

The system may be impaired or may not function, particularly in the following situations:

- In snow, rain, fog, heavy spray, if there is glare, in direct sunlight or in greatly varying ambient light.
- If the sensors are dirty, fogged up, damaged or covered.
- If the sensors are impaired due to interference from other radar sources, e.g. strong radar reflections in parking garages.
- If a loss of tire pressure or a faulty tire has been detected and displayed.
- In complex traffic situations where objects cannot always be clearly identified.
- If pedestrians or vehicles move quickly into the sensor detection range.
- If pedestrians are hidden by other objects.
- If the typical outline of a pedestrian cannot be distinguished from the background.
- If a pedestrian is not detected as such, e.g. due to special clothing or other objects.
- If the driver's seat belt is not fastened.
- On curves with a tight radius.

- ① The Active Brake Assist sensors adjust automatically while a certain distance is being driven after the vehicle has been delivered. Active Brake Assist is unavailable or only partially available during the teach-in process.

### Setting Active Brake Assist

Multimedia system:

- ➔ Vehicle ➔  Assistance
- ➔ Active Brake Assist

The settings can be adjusted when the ignition is switched on.

- ▶ Select **Early**, **Medium** or **Late**.

- ① Your selection is retained when the vehicle is next started.

### Deactivating Active Brake Assist

- ① It is recommended that you always leave Active Brake Assist activated.

- ▶ Select **Off**.  
The distance warning function and the autonomous braking function are deactivated.

**Vehicles without Driving Assistance Package:** When the vehicle is next started, the medium setting is automatically selected.

**Vehicles with Driving Assistance Package:** Evasive Steering Assist is not available. When the ignition is next started, the medium setting is selected automatically and Evasive Steering Assist is available.

- ① If Active Brake Assist is deactivated, the  symbol appears in the status bar of the multifunction display.

### Traffic Sign Assist

#### Function of Traffic Sign Assist

Traffic Sign Assist detects traffic signs with the multifunction camera (→ page 155). It assists you by displaying detected speed limits and overtaking restrictions in the instrument cluster. Observe the notes on driving systems and your responsibility; you may otherwise fail to recognize dangers (→ page 155).

Since Traffic Sign Assist also uses the data stored in the navigation system, it can update

the display in the following situations without detecting traffic signs.

The camera also detects traffic signs with a restriction indicated by an additional sign (e.g. when wet). These are only displayed if a restriction applies or if the system cannot clearly determine whether the restriction applies.

#### Warning when the maximum permissible speed is exceeded

The system can warn you if you unintentionally exceed the maximum permissible speed. To do this, you can specify in the multimedia system by how much the maximum permissible speed can be exceeded before a warning is issued. You can specify whether the warning is to be just a visual warning or an acoustic one as well.

## Display in the Instrument Display



Instrument Display in the widescreen cockpit

- ① Maximum permissible speed
  - ② Maximum permissible speed when there is a restriction
  - ③ Additional sign with restriction
- ① **Vehicles with a standard Instrument Display:** a + symbol next to a traffic sign in the Instrument Display indicates that additional traffic signs have been detected. These can also be displayed in the media display and optionally in the Head-up Display.

If Traffic Sign Assist cannot determine the maximum permissible speed (e.g. due to missing signs), the following display appears in the Instrument Display:



This is displayed continuously if the vehicle is in a country where Traffic Sign Assist is not supported. Traffic Sign Assist is not available in all countries.

① Also observe the information on display messages in Traffic Sign Assist (→ page 401).

### System limits

The system may be impaired or may not function particularly in the following situations:

- If there is poor visibility, e.g. due to insufficient illumination of the road, if there are highly variable shade conditions or in rain, snow, fog or heavy spray.
- If there is glare, e.g. from oncoming traffic, direct sunlight or reflections.

- If the windshield in the area of the multifunction camera is dirty, or if the camera is fogged up, damaged or covered.
- If the traffic signs are hard to detect, e.g. due to dirt, snow or insufficient lighting, or because they are covered.
- If the information in the navigation system's digital map is incorrect or out-of-date.
- If the signs are ambiguous, e.g. road signs in roadworks or in adjacent lanes.
- If you turn sharply when passing traffic signs outside the camera's field of vision.

### Setting Traffic Sign Assist

#### Requirements:

- **For automatic adoption of speed limits:** Active Distance Assist DISTRONIC is activated.

Multimedia system:

- Vehicle →  Assistance
- Traffic Sign Assist

### Activating or deactivating automatic adoption of speed limits

- ▶ Select **Limit Adoption**.
- ▶ Activate  or deactivate  the function. The speed limits detected by Traffic Sign Assist are automatically adopted by Active Distance Assist DISTRONIC.

### Displaying detected traffic signs in the media display

- ▶ Select **Display in COMAND**.
- ▶ Activate  or deactivate  the function.
- ① If one of the following systems is activated, the detected speed can be manually adopted as the speed limit:
  - Active Distance Assist DISTRONIC
  - Cruise control

Further information (→ page 167).

### Adjusting the type of warning

- ▶ Select **Visual & Audible**, **Visual** or **None**.

### Adjusting the warning threshold

This value determines the speed at which a warning is issued when exceeded.

- ▶ Select **Warning Threshold**.
- ▶ Set the desired speed.



### Blind Spot Assist and Active Blind Spot Assist with exit warning

#### Function of Blind Spot Assist and Active Blind Spot Assist with exit warning

Blind Spot Assist and Active Blind Spot Assist use two lateral, rear-facing radar sensors to monitor the area up to 130 ft (40 m) behind and 10 ft (3 m) next to your vehicle.

If a vehicle is detected at speeds above approximately 8 mph (12 km/h) and this vehicle subsequently enters the monitoring range directly next to your vehicle, the warning lamp in the outside mirror lights up red.

Permanent status display in the instrument cluster:

-  (gray): system is activated but inoperative
-  (green): system is activated and operational

If a vehicle is detected close to your vehicle and you switch on the turn signal indicator in the corresponding direction, a double warning tone sounds and the red warning lamp in the outside mirror flashes. If the turn signal indicator remains switched on, all other detected vehicles are indicated only by the flashing of the red warning lamp.

If you overtake a vehicle quickly, no warning is given.

#### **WARNING** Risk of accident despite Blind Spot Assist

Blind Spot Assist does not react to vehicles approaching and overtaking you at a greatly different speed.



Blind Spot Assist cannot warn drivers in this situation.

- ▶ Always pay careful attention to the traffic situation and maintain a safe distance at the side of the vehicle.

Observe the notes on driving systems and your responsibility; you may otherwise fail to recognize dangers (→ page 155).

### Exit warning

The exit warning is an additional function of Blind Spot Assist and can warn vehicle occupants about approaching vehicles when leaving the vehicle when stationary.

#### **▲ WARNING** Risk of accident despite exit warning

The exit warning neither reacts to stationary objects nor to vehicles approaching you at a greatly differing speed.

The exit warning cannot warn drivers in these situations.

- ▶ Always pay particular attention to the traffic situation when opening the doors and make sure there is sufficient clearance.

If there is a vehicle in the monitoring range, this is indicated in the outside mirror. If a vehicle occupant opens the door on the side with the warning, a warning tone sounds and the warning lamp in the outside mirror starts to flash.

This additional function is only available when Blind Spot Assist is active. When the exit warning is activated, it can warn vehicle occupants for up to three minutes after switching the ignition off. The exit warning is no longer available once the warning lamp in the outside mirror flashes three times.

The exit warning is only an aid and not a substitute for the attention of vehicle occupants. The responsibility for opening and closing the doors and for leaving the vehicle remains with the vehicle occupants.

### System limits

Blind Spot Assist and Active Blind Spot Assist may be limited in the following situations, in particular:

- If there is dirt on the sensors or the sensors are obscured
- In poor visibility, e.g. due to fog, heavy rain or snow
- If there are narrow vehicles, e.g. bicycles or motorbikes
- If the road has very wide or narrow lanes
- If vehicles are not driving in the middle of their lane

Warnings may be issued in error when driving close to crash barriers or similar continuous lane borders. Always make sure that there is sufficient distance to the side for other traffic or obstacles.

Warnings may be interrupted when driving alongside long vehicles, for example trucks, for a prolonged time.

Blind Spot Assist is not operational when reverse gear is engaged.

The exit warning may be limited in the following situations:

- When the sensors are covered by adjacent vehicles in narrow parking spaces
- When people approach the vehicle
- In the event of stationary or slowly moving objects

#### Function of brake application (Active Blind Spot Assist)

If Active Blind Spot Assist detects a risk of a side impact in the monitoring range, a course-correcting brake application is carried out. This is designed to help you avoid a collision.

The course-correcting brake application is available in the speed range between approximately 20 mph (30 km/h) and 125 mph (200 km/h).

**⚠ WARNING** Risk of accident despite brake application of Active Blind Spot Assist

A course-correcting brake application cannot always prevent a collision.

- ▶ Always steer, brake or accelerate yourself, especially if Active Blind Spot Assist warns you or makes a course-correcting brake application.
- ▶ Always maintain a safe distance at the sides.

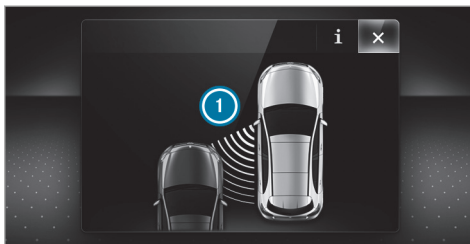

If a course-correcting brake application occurs, the red warning lamp flashes in the outside mirror and a warning tone sounds. In addition, a display ① indicating the danger of a side collision appears in the multifunction display.

In rare cases, the system may make an inappropriate brake application. This brake application

may be interrupted at any time if you steer slightly in the opposite direction or accelerate.

#### System limits

Note the system limitations of Active Blind Spot Assist; you may otherwise not recognize the dangers (→ page 182).

Either a course-correcting brake application appropriate to the driving situation, or none at all, may occur in the following situations:

- Vehicles or obstacles, e.g. crash barriers, are located on both sides of your vehicle.
- A vehicle approaches too closely on the side.
- You have adopted a sporty driving style with high cornering speeds.
- You brake or accelerate significantly.
- A driving safety system intervenes, e.g. ESP® or Active Brake Assist.
- ESP® is deactivated.
- A loss of tire pressure or a faulty tire is detected.

### Activating/deactivating Blind Spot Assist or Active Blind Spot Assist

Multimedia system:

→ Vehicle → Assistance  
 → Blind Spot Assist

▶ Activate  or deactivate  the function.

### Active Lane Keeping Assist

#### Function of Active Lane Keeping Assist

Active Lane Keeping Assist monitors the area in front of your vehicle by means of the multifunction camera (→ page 155). It serves to protect you against unintentionally leaving your lane. You will be warned by vibration pulses in the steering wheel and guided by a course-correcting brake application back into your lane.

Active Lane Keeping Assist is available in the speed range between 37 mph (60 km/h) and 124 mph (200 km/h).

Active Lane Keeping Assist can neither reduce the risk of an accident if you fail to adapt your driving style nor override the laws of physics. It cannot take into account road, weather or traffic

conditions. Active Lane Keeping Assist is only an aid. You are responsible for maintaining a safe distance to the vehicle in front, for vehicle speed, for braking in good time and for staying in lane.



If a lane-correcting brake application occurs, display ① appears in the multifunction display.

The system does not apply the brake if you activate the turn signal indicator.

**Vehicles with Driving Assistance Package:** if the system detects an obstacle, such as another vehicle in the adjacent lane, it will apply the brake regardless of the turn signal indicator.

You are warned by vibrations in the steering wheel in the following circumstances:

- Active Lane Keeping Assist detects a lane marking.
- A front wheel drives over this lane marking.

#### Conditions for a course-correcting brake application (vehicles without Driving Assistance Package)

Lane markings were detected on both sides of the lane. The front wheel drives over a continuous lane marking.

- ① A brake application may be interrupted at any time if you steer slightly in the opposite direction.

#### Conditions for a course-correcting brake application (vehicles with Driving Assistance Package)

- A continuous lane marking was detected and driven over with the front wheel.
- A lane marking and an approaching vehicle, an overtaking vehicle or vehicles driving parallel to your vehicle were detected in the

adjacent lane. The front wheel drives over the lane marking.

- ❗ A brake application may be interrupted at any time if you steer slightly in the opposite direction.

### System limits

No lane-correcting brake application occurs in the following situations:

- You clearly and actively steer, brake or accelerate.
- If a driving safety system intervenes, such as ESP®, Active Brake Assist or Active Blind Spot Assist.
- You have adopted a sporty driving style with high cornering speeds or high rates of acceleration.
- When ESP® is deactivated.
- If a loss of tire pressure or a faulty tire is detected and displayed.

If you deactivate the Active Lane Keeping Assist warning and the lane markings cannot be clearly

detected, it is possible that no lane-correcting brake application takes place (→ page 187).

The system may be impaired or may not function particularly in the following situations:

- If there is poor visibility, e.g. due to insufficient illumination of the road, if there are highly variable shade conditions or in rain, snow, fog or heavy spray.
- If there is glare, e.g. from oncoming traffic, the sun or reflections.
- If the windshield in the area of the multifunction camera is dirty, or if the camera is fogged up, damaged or covered.
- If there are no lane markings, or several unclear lane markings are present for one lane, e.g. around roadworks.
- If the lane markings are worn, dark or covered.
- If the distance to the vehicle in front is too short and thus the lane markings cannot be detected.

- If the lane markings change quickly, e.g. lanes branch off, cross one another or merge.
- If the road is very narrow and winding.
- **Vehicles with Driving Assistance Package:** if the radar sensors in the rear bumper are dirty or covered in snow and an obstacle is detected in your lane, no lane-correcting brake application takes place.

### Activating/deactivating Active Lane Keeping Assist

**⚠ WARNING** Risk of accident despite Active Lane Keeping Assist warning

A lane-correcting brake application cannot always bring the vehicle back into the original lane.

▶ Always steer, brake or accelerate yourself, especially if Active Lane Keeping Assist warns you or makes a lane-correcting brake application.

**⚠ WARNING** Risk of accident despite intervention of Active Lane Keeping Assist

Active Lane Keeping Assist does not detect traffic conditions or road users. The system may make an inappropriate brake application.

The brake application can be interrupted at any time, for example, by steering slightly in the opposite direction.

- ▶ Always make sure that there is sufficient distance to the side for other traffic or obstacles.

**⚠ WARNING** Risk of accident despite Lane Keeping Assist

Lane Keeping Assist cannot always clearly detect lane markings.

In such cases, Lane Keeping Assist can:

- give an unnecessary warning
  - not give a warning
- ▶ Always pay particular attention to the traffic situation and keep within the

lane, especially if Active Lane Keeping Assist alerts you.

Be sure to observe the system limitations of Active Lane Keeping Assist.

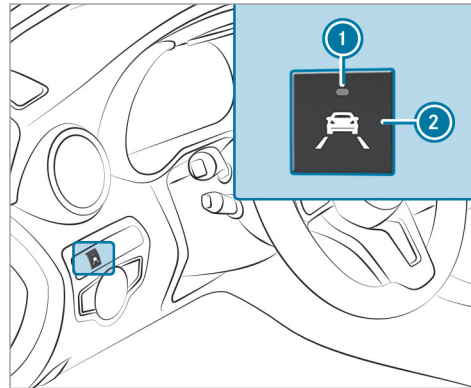

- ▶ Press button (2). If indicator lamp (1) lights up, Active Lane Keeping Assist is activated, the lane markings are shown as light in the assistance

graphic. When Active Lane Keeping Assist is active, the lane markings are shown in green in the assistance graphic.

### Setting Active Lane Keeping Assist

Multimedia system:

- ➔ Vehicle ➔ Assistance
- ➔ Act. Lane Keep. Assist

### Activating/deactivating the warning

- ▶ Activate  or deactivate  Lane Depart. Warning.  
You do not receive any warning when leaving a lane if the lane keeping warning system is deactivated.

### DYNAMIC BODY CONTROL function

DYNAMIC BODY CONTROL continuously adjusts the characteristics of the suspension dampers to the current operating and driving conditions.

The damping is tuned individually for each wheel and is affected by the following factors:

- The road surface conditions
- Vehicle load

- The drive program selected
- The driving style

The drive program can be adjusted using the DYNAMIC SELECT switch.

## AIRMATIC

### Function of AIRMATIC

AIRMATIC is an air suspension system with variable damping for improved driving comfort. The all-round level control system ensures the best possible suspension and constant ground clearance, even with a laden vehicle. When driving at speed, the vehicle is lowered automatically to improve driving safety and to reduce fuel consumption. You also have the option of manually adjusting the vehicle level.

AIRMATIC includes the following components and functions:

- Air suspension with automatic level control
- Speed-dependent lowering to reduce fuel consumption
- Manually selectable high level setting for greater ground clearance

- ADS PLUS (Adaptive Damping System with constant damping force adjustment)
- DYNAMIC SELECT switch and level button

### Available suspension settings

#### **C** (Comfort)

- The suspension setting is comfortable.
- The vehicle is set to the normal level.
- When driving at speeds above 77 mph (125 km/h) the vehicle is lowered.
- When driving at speeds below 50 mph (80 km/h), the vehicle is raised again.

#### **E** (Economy)

- The suspension setting is comfortable.
- The vehicle is set to the low level.
- The vehicle is not lowered any further if you are traveling at higher speeds.

#### **S** (Sport)

- The suspension setting is firmer.
- The vehicle is set to the low level.

- The vehicle is not lowered any further if you are traveling at higher speeds.

#### **S<sup>+</sup>** (Sport Plus)

- The suspension setting is even firmer.
- The vehicle is set to the low level.
- The vehicle is not lowered any further if you are traveling at higher speeds.

**i** **Operation with a trailer or bicycle rack:** if transport equipment, such as a trailer or a bicycle rack, is attached to the trailer hitch and the electrical connection has been correctly established, the vehicle remains at normal level irrespective of speed or the drive program selected.

### Setting the vehicle level

**⚠ WARNING** Risk of accident because vehicle level is too high

Driving characteristics may be impaired. The vehicle can drift outwards, for example, when steering or cornering.

- ▶ Choose a vehicle level which is suited to the driving style and the road surface conditions.

**⚠ WARNING** Risk of entrapment from vehicle lowering

When lowering the vehicle, people could become trapped if their limbs are between the vehicle body and the tires or underneath the vehicle.

- ▶ Make sure no one is underneath the vehicle or in the immediate vicinity of the wheel arches when the vehicle is being lowered.

**⚠ WARNING** Risk of becoming trapped due to the vehicle lowering

**Vehicles with AIRMATIC or level control:** when you unload luggage or leave the vehicle, the vehicle first rises slightly and then returns to the set level shortly afterwards.

You or anyone else in the vicinity of the wheel arches or the underbody could thus become trapped.

The vehicle can also be lowered after being locked.

- ▶ When leaving the vehicle, make sure that nobody is in the vicinity of the wheel arches or the underbody.

**! NOTE** Damage due to vehicle lowering

Parts of the body could be damaged when the vehicle is lowered.

- ▶ Make sure that there are no obstacles such as curbs underneath or in the immediate vicinity of the body when the vehicle is being lowered.

**Requirements:**

- The vehicle has been started.
- The vehicle must not be moving faster than 37 mph (60 km/h).

**Raising the vehicle**

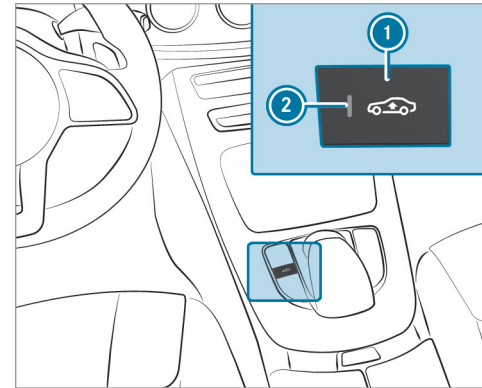

- ▶ Press button ①.  
Indicator lamp ② lights up.  
The vehicle is set to the high level.

Your selection is saved.

## 190 Driving and parking

The vehicle is lowered again in the following situations:

- When driving faster than 50 mph (80 km/h).
- When driving between 37 mph (60 km/h) and 50 mph (80 km/h) for approximately three minutes.
- After selecting a drive program using the DYNAMIC SELECT switch.

The vehicle is adjusted to the height of the active drive program.

### Lowering the vehicle

- ▶ Press button ①.
- Indicator lamp ② goes out. The vehicle is adjusted to the height of the active drive program.

### Rear view camera

#### Function of the rear view camera

When you engage reverse gear, the image from the rear view camera is shown in the media display. Dynamic guide lines show the path the vehicle will take with the current steering angle.

This helps you to orient yourself and to avoid obstacles when backing up.

The rear view camera is only an aid. It is not a substitute for your attention to the surroundings. The responsibility for safe maneuvering and parking remains with you. Make sure that there are no persons, animals or objects etc., in the maneuvering area while maneuvering and parking.

The guide lines in the media display show the distances to your vehicle. The distances displayed only apply to road level.

You can select from the following views:

- Normal view
- Wide-angle view

The area behind the vehicle is displayed as a mirror image, as in the inside rearview mirror.

#### Vehicles without Parking Assist PARKTRONIC

The following camera views are available in the multimedia system:

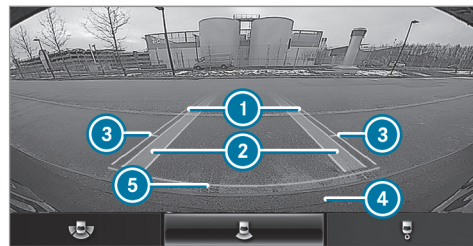

Normal view

- ① Yellow guide line, vehicle width (driven surface) depending on the current steering angle (dynamic)
- ② Yellow lanes marking the course the tires will take with the current steering angle (dynamic)
- ③ Yellow guide line at a distance of approximately 3.3 ft (1.0 m) from the rear area
- ④ Bumper
- ⑤ Red guide line at a distance of approximately 1.0 in (0.3 m) from the rear area



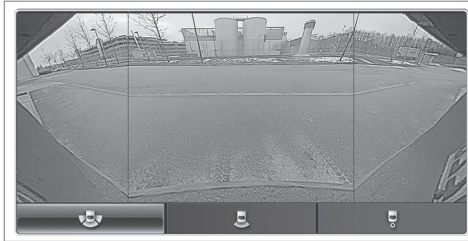

Wide-angle view

**Vehicles with Parking Assist PARKTRONIC**

The following camera views are available in the multimedia system:

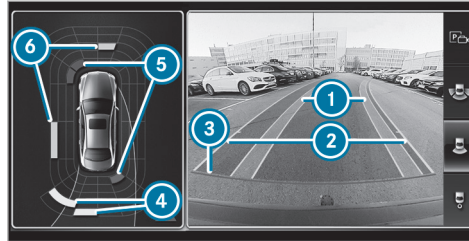

Normal view

- ① Yellow lanes marking the course the tires will take with the current steering angle (dynamic)
- ② Yellow guide line, vehicle width (driven surface) depending on the current steering angle (dynamic)
- ③ Red guide line at a distance of approximately 1.0 in (0.3 m) from the rear area
- ④ Yellow warning indicator of Parking Assist PARKTRONIC: obstacles at a distance between approximately 2.0 ft (0.6 m) and 3.3 ft (1.0 m)
- ⑤ Red warning display of Parking Assist PARKTRONIC: obstacles are very close (approximately 1.0 ft (0.3 m) or less)
- ⑥ Orange warning display of Parking Assist PARKTRONIC: obstacles are a medium distance away (between approximately 1.0 ft (0.3 m) and 2.0 ft (0.6 m))



Wide-angle view

**System failure**

If the rear view camera is not ready for operation, the  display appears in the media display.

### System limits

The rear view camera will not function or will only partially function in the following situations:

- The trunk lid is open.
- There is heavy rain, snow or fog.
- The ambient light conditions are poor, e.g. at night.
- Cameras, or vehicle components in which the cameras are installed, are damaged, dirty or covered. Observe the information on vehicle sensors and cameras (→ page 155).

- ⓘ Do not use the rear view camera in these types of situations. You could otherwise injure others or collide with objects when parking the vehicle.

For technical reasons, the standard height of the vehicle may be altered if the vehicle is carrying a heavy load and can result in inaccuracies in the guide lines and in the display of the generated images.

- ⓘ The display contrast may be impaired due to incident sunlight or other light sources. In this case, pay particular attention.

- ⓘ Have the display repaired or replaced if, for example, pixel errors considerably restrict its use.

### 360° camera

#### Function of the surround view camera

The surround view camera is a system that consists of four cameras. The cameras cover the immediate vehicle surroundings. The system assists you when you are parking or at exits with reduced visibility, for example.

The views of the surround view camera are always available when driving forwards up to a speed of approx. 10 mph (16 km/h) and when backing up.

The surround view camera is only an aid. It is not a substitute for your attention to the surroundings. The responsibility for safe maneuvering and parking remains with you. Make sure that there are no persons, animals or objects etc., in the maneuvering area while maneuvering and parking.

The system evaluates images from the following cameras:

- Rear view camera
- Front camera
- Two side cameras in the outside mirrors

#### Views of the surround view camera

You can select from different views:

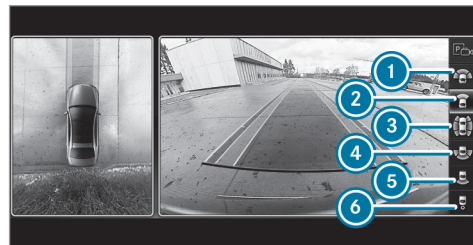

- ① Wide-angle view, front
- ② Top view with image from the front camera
- ③ Top view with images from the side cameras in the outside mirrors
- ④ Wide-angle view, rear

- ⑤ Top view with image from the rear view camera
- ⑥ Top view with trailer view (vehicles with a trailer hitch)

### Top view

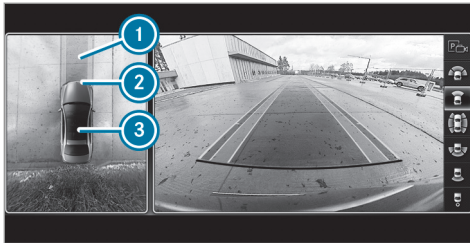

- ① Lane indicating the route the vehicle will take at the current steering wheel angle
- ② Yellow warning display of Parking Assist PARKTRONIC: obstacles at a distance of approximately 3.3 ft (1.0 m) or less
- ③ Your vehicle from above

If the distance to the object lessens, the color of warning display ② changes. From a distance of

approximately 2.0 ft (0.6 m) the warning display is shown in orange. From a distance of approximately 1.0 ft (0.3 m) the warning display is shown in red.

When Parking Assist PARKTRONIC is operational and no object is detected, the segments of the warning display are shown in gray.

### Guide lines

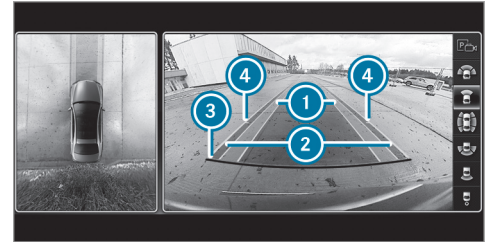

- ① Yellow lane marking the course the tires will take at the current steering wheel angle (dynamic)
- ② Yellow guide line, vehicle width (driven surface) depending on the current steering wheel angle (dynamic)
- ③ Red guide line at a distance of approximately 1.0 in (0.3 m) from the rear area
- ④ Mark at a distance of approx. 3.3 ft (1.0 m)
- i When Active Parking Assist is active, the lane markings are displayed in green.

The guide lines show the distances to your vehicle. The distances only apply to road level.

### Side view of the mirror cameras

The sides of the vehicle can be seen in this view.

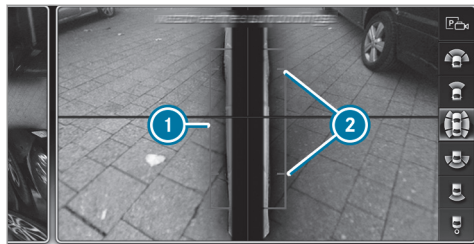

- 1 Guide line of external vehicle dimensions with outside mirrors folded out
- 2 Marker of the wheel contact points

### System failure

If the rear view camera is not operational, the following message appears in the media display:



### System limits

The surround view camera will not function or will only partially function in the following situations:

- The doors are open.
- The side mirrors are folded in.
- The trunk lid is open.
- There is heavy rain, snow or fog.
- The ambient light conditions are poor, e.g. at night.
- Cameras, or vehicle components in which the cameras are installed, are damaged, dirty or covered. Observe the information on vehicle sensors and cameras (→ page 155).

Do not use the surround view camera under such circumstances. You could otherwise injure others or collide with objects when parking or maneuvering the vehicle.

On vehicles with height-adjustable suspension or if the vehicle is carrying a heavy load, leaving the standard height can result in inaccuracies in the guide lines and in the display of the generated images, depending on technical conditions.

- ⓘ The contrast of the display may be impaired by abrupt, direct sunlight or by other light sources, e.g. when driving out of a garage. In this case, pay particular attention.
- ⓘ Have the display repaired or replaced if, for example, pixel errors considerably restrict its use.

See the notes on cleaning the surround view camera (→ page 333).

### Selecting a view for the 360° Camera

#### Requirements:

- The [Auto. Rear View Cam.](#) function is selected in the multimedia system.
- ▶ Engage reverse gear.
  - ▶ In the multimedia system, select the desired view.

### Opening the camera cover of the rear view camera

Multimedia system:

➔ Vehicle ➔  Assistance

➔ Camera & Parking

▶ Select **Open Camera Cover**.

ⓘ The camera cover closes automatically after some time or after an ignition cycle.

### Setting the camera as a favorite

You can call up the camera view directly in the multimedia system by setting it as a favorite.

- ▶ Press the  button on the control element. The main functions are displayed.
- ▶ Navigate downwards twice. The Favorites menu appears.
- ▶ Select **New Favorite**.
- ▶ Select **Vehicle**.
- ▶ Select **Camera**.

### Parking Assist PARKTRONIC

#### Function of Parking Assist PARKTRONIC

Parking Assist PARKTRONIC is an electronic parking assistance system with ultrasound. It monitors the area around your vehicle using multiple sensors on the front bumper and on the rear bumper. Parking Assist PARKTRONIC shows you the distance between your vehicle and a detected obstacle visually and audibly.

Parking Assist PARKTRONIC is only an aid. It is not a substitute for your attention to the surroundings. The responsibility for safe maneuvering and parking remains with you. Make sure that there are no persons, animals or objects in the maneuvering area while maneuvering and parking in/exiting parking spaces.

In the standard setting, an intermittent warning tone sounds from a distance of approximately 1.0 ft (0.3 m) to an obstacle in front and approximately 3.3 ft (1.0 m) to an obstacle behind. A continuous warning tone sounds from a distance of approximately 0.7 ft (0.2 m). Using the **Warn Early** setting in the multimedia system, the warning tones for front and side impact protection

can be set to sound at a greater distance of approximately 3.3 ft (1.0 m) in front and 2.0 ft (0.6 m) on the sides (→ page 198).

ⓘ The **Warn Early** setting is always active at the rear of the vehicle.

#### Parking Assist PARKTRONIC display in the multimedia system



Vehicles without surround view camera

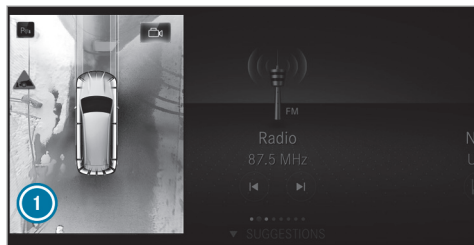

Vehicles with surround view camera

If you have not selected the [Camera & Parking](#) menu and an obstacle is detected in the path of the vehicle, a pop-up window for Parking Assist PARKTRONIC ❶ appears in the multimedia system at speeds below 6 mph (10 km/h).

The color of the individual segments of the warning display is based on the distance to the detected obstacle:

- **Yellow segments:** obstacles at a distance between approx. 2.0 ft (0.6 m) and 3.3 ft (1.0 m)

- **Orange segments:** obstacles at a distance between approx. 1.0 ft (0.3 m) and 2.0 ft (0.6 m)
- **Red segments:** obstacles at a very short distance of approx. 1.0 ft (0.3 m) or less

### System limits

Parking Assist PARKTRONIC does not necessarily take into account the following obstacles:

- Obstacles below the detection range, e.g. persons, animals or objects.
- Obstacles above the detection range, e.g. overhanging loads, overhangs or loading ramps of trucks.

The sensors must be free of dirt, ice and slush. Otherwise, they may not function correctly. Clean the sensors regularly, taking care not to scratch or damage them (→ page 155).

### Problems with Parking Assist PARKTRONIC

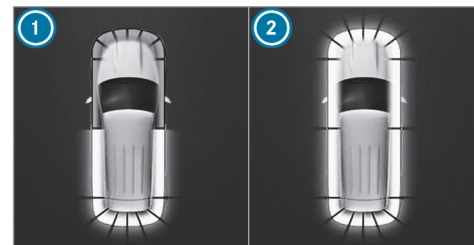

Example: vehicles with surround view camera

When rear segments ❶ or all-around segments ❷ light up red and the  symbol appears in the multifunction display, Parking Assist PARKTRONIC may have been deactivated due to signal interference. Start the vehicle again and check if Parking Assist PARKTRONIC is working at a different location.

If a warning tone also sounds for approximately two seconds every time the vehicle is started, it may be due to one of the following causes:

- **The sensors are dirty:** clean the sensors and observe the notes on care of vehicle parts (→ page 333).
- **Parking Assist PARKTRONIC has been deactivated due to a malfunction:** restart the vehicle. If the problem persists, consult a qualified specialist workshop.

#### Function of the passive side impact protection

Passive side impact protection is an additional Parking Assist PARKTRONIC function which warns the driver about obstacles at the side of the vehicle. A warning is issued when obstacles are detected between the front and rear detection range. In order for an object on the side to be detected, the sensors in the front and rear bumper must first detect the object while you are driving past it.

During the parking procedure or when maneuvering, objects are detected as the vehicle drives past. If you steer in the direction of a detected

obstacle and there is a risk of a lateral collision, a warning is issued and the segments light up in color in the display.

The segment color changes depending on the distance to the detected obstacle:

- **Yellow:** approximately 1.0 - 2.0 ft (30 - 60 cm)
- **Red:** less than approximately 1.0 ft (30 cm)

In order for lateral front or rear segments to be displayed, the vehicle must first travel a distance of at least half of the vehicle length. Once the vehicle has traveled the length of the vehicle, all of the lateral front and rear segments can be displayed.

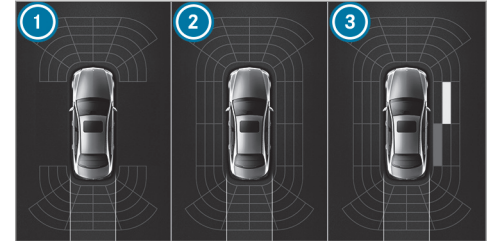

Parking Assist PARKTRONIC display: vehicles without a surround view camera

- ① Operational front and rear
- ② Operational front, rear and sides
- ③ Obstacle detected at the front right (yellow) and rear (red)

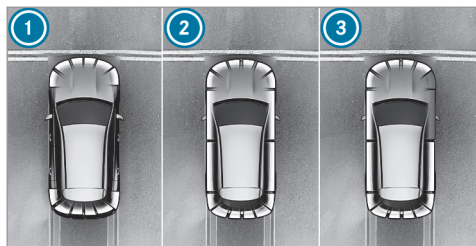

Parking Assist PARKTRONIC display: vehicles with a surround view camera

- 1 Operational front and rear
- 2 Operational front, rear and sides
- 3 Obstacles detected at the front right (red)

Saved obstacles on the sides are deleted in the following situations, for example:

- You park the vehicle and switch off the ignition.
- You open the doors.

After the engine is restarted, obstacles on the sides must be detected again before a new warning can be issued.

### System limits

The system limits for Parking Assist PARKTRONIC apply to passive side impact protection.

The following objects are not detected, for example:

- Pedestrians who approach the vehicle from the side
- Objects placed next to the vehicle

### Activating/deactivating Parking Assist PARKTRONIC

**!** **NOTE** Risk of an accident from objects at close range

Parking Assist PARKTRONIC may not detect certain objects at close range.

- ▶ When parking or maneuvering the vehicle, pay particular attention to any objects which are above or below the sensors, e.g. flower pots or drawbars. The vehicle or other objects could otherwise be damaged.

- ▶ Press the button in the center console.

If the indicator lamp in the button is not lit, Parking Assist PARKTRONIC is active. If the indicator lamp is lit or the symbol appears in the instrument cluster, Parking Assist PARKTRONIC is not active.

- i** Parking Assist PARKTRONIC is automatically activated when the vehicle is started.

### Adjusting the warning tones of Parking Assist PARKTRONIC

Multimedia system:

- ▶ Vehicle ▶ Assistance
- ▶ Camera & Parking ▶ Set Warning Tones

### Adjusting the volume of the warning tones

- ▶ Select [Warning Tone Volume](#).
- ▶ Set a value.

### Adjusting the pitch of the warning tones

- ▶ Select [Warning Tone Pitch](#).
- ▶ Set a value.



### Specifying the starting point for the warning tones

You can specify whether the Parking Assist PARKTRONIC warning tones should commence when the vehicle is further away from an obstacle.

- ▶ Select **Warn Early**.
- ▶ Activate  or deactivate  the function.

### Activating/deactivating audio fadeout

You can specify whether the volume of a media source in the multimedia system is to be reduced when Parking Assist PARKTRONIC gives an audible warning.

- ▶ Select **Audio Fadeout During Warning Tones**.
- ▶ Activate  or deactivate  the function.

## Active Parking Assist

### Function of Active Parking Assist

Active Parking Assist is an electronic parking assistance system, which uses ultrasound with the assistance of the rear view camera and surround view camera. When you are driving forwards up to approximately 22 mph (35 km/h),

the system automatically measures parking spaces on both sides of the vehicle.

As soon as all requirements are met for searching for parking spaces, the  display appears in the multifunction display.

When Active Parking Assist has detected parking spaces, the  display appears in the multifunction display. The arrows show on which side of the road detected parking spaces are located. They are then shown on the media display.

The parking space can be selected as desired. Depending on the location of the parking space, the parking direction (rearwards or forwards) can also be selected as desired.

When Active Parking Assist is activated, the turn signal indicators are activated based on the calculated path of your vehicle.

When you are entering or exiting a parking space, the procedure is assisted by acceleration, braking, steering and gear changes.

Active Parking Assist is only an aid. It is not a substitute for your attention to the surroundings. The responsibility for safe maneuvering and parking remains with you. Make sure that no

persons, animals or objects etc. are in the maneuvering range.

Active Parking Assist will be canceled in the following situations:

- Parking Assist PARKTRONIC is deactivated.
- You begin steering.
- You apply the parking brake.
- You engage transmission position .
- ESP® intervenes.
- You open the doors or the trunk lid while driving.

### System limits

If the exterior lighting is malfunctioning, Active Parking Assist is not available.

Objects located above or below the detection range of the sensors, e.g. overhanging loads, overhangs or loading ramps of trucks, or the borders of parking spaces, are not detected during measurement of the parking space. These are also then not taken into account when calculating the parking procedure. In some circumstances, Active Parking Assist may therefore guide you into the parking space incorrectly.

**⚠ WARNING** Risk of accident due to objects located above or below the detection range of Active Parking Assist

If there are objects above or below the detection range, the following situations may arise:

- Active Parking Assist may steer too early.
- The vehicle may not stop in front of these objects.

This could cause a collision.

- ▶ In these situations, do not use Active Parking Assist.

Extreme weather conditions, such as snow or heavy rain, may lead to a parking space being measured inaccurately. Parking spaces that are partially occupied by trailer drawbars might not be identified as such or be measured incorrectly. Only use Active Parking Assist on level, high-grip ground.

Do not use Active Parking Assist in the following situations:

- In extreme weather conditions such as ice, packed snow or in heavy rain.
- When transporting a load that protrudes beyond the vehicle.
- On steep uphill or downhill gradients of more than approximately 15%.
- When snow chains are installed.
- Directly after a tire change or when spare tires are installed.
- If the tire pressure is too low or too high.
- If the suspension is out of alignment, e.g. after bottoming out on a curb.

Active Parking Assist may also display parking spaces that are not suitable for parking, such as:

- Parking spaces where parking is prohibited.
- Parking spaces on unsuitable surfaces.

### Parking with Active Parking Assist

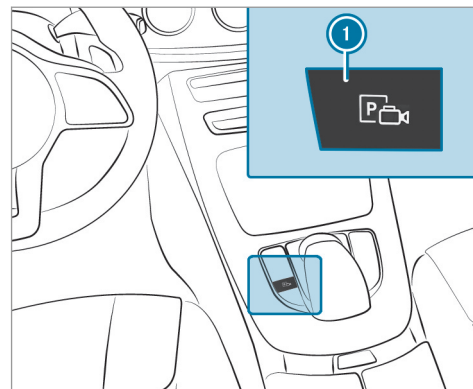

- ▶ Press button ①.

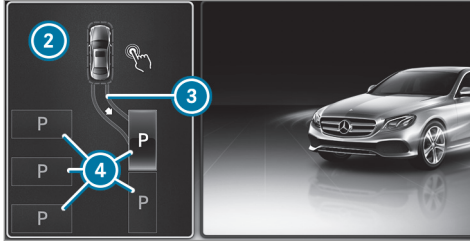

The media display shows the view of Active Parking Assist. Area ② displays detected parking spaces ④ and vehicle path ③.

- ① Vehicle path ③ shown on the media display may differ from the actual vehicle path.
- ▶ If a parking space is displayed: stop the vehicle.
- ▶ Select desired parking space ④ and confirm.
- ▶ If necessary, select the parking direction (forwards or reverse), and confirm. Vehicle path ③ is shown, depending on selected parking space ④ and the parking direction.

- ① The turn signal indicator is switched on automatically when the parking procedure begins.

You are responsible for selecting the turn signal indicator in accordance with the traffic conditions. If necessary, select the turn signal indicator accordingly.

**⚠ WARNING** Risk of accident due to vehicle swinging out while parking or pulling out of a parking space

While parking or exiting a parking space, the vehicle swings out and can drive onto areas of the oncoming lane.

This could cause you to collide with objects or other road users.

- ▶ Pay attention to objects and other road users.
- ▶ Where necessary, stop the vehicle or cancel the parking procedure with Active Parking Assist.

- ▶ If, for example, the **Please Engage Reverse Gear** message appears in the media display:

select the corresponding transmission position.

The vehicle drives into the selected parking space.

- ① During the parking procedure with Active Parking Assist, the lane markings are displayed in green in the camera image.

On completion of the parking procedure, the  **Parking Assist Finished, Take Control of Vehicle** display message appears. Further maneuvering may still be necessary.

- ▶ After completion of the parking procedure, safeguard the vehicle against rolling away. When required by legal requirements or local conditions: turn the wheels towards the curb.
- ① You can stop the vehicle and change the transmission position during the parking procedure. The system then calculates a new vehicle path. If no new vehicle path is available, the system can change the transmission position again or cancel the parking procedure.

### Exiting a parking space with Active Parking Assist

#### Requirements:

- The vehicle has been parked with Active Parking Assist.

Please note that you are responsible for the vehicle and surroundings during the entire parking procedure.

- ▶ Start the vehicle.

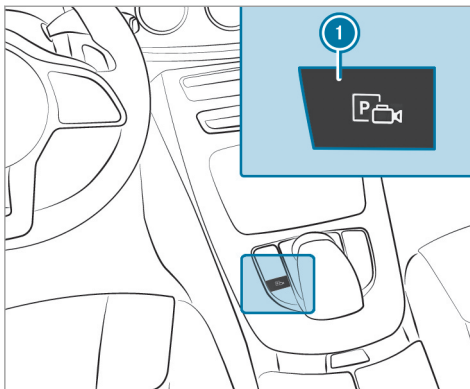

- ▶ Press button ①. The media display shows the view of Active Parking Assist.



- ▶ If the vehicle has been parked perpendicular to the direction of travel: in area ②, select direction of travel ③ **Left** or **Right**.
- ⓘ The vehicle path shown on the media display may differ from the actual vehicle path.
- ▶ Confirm direction of exit ③ to drive out of the parking space.
- ⓘ The turn signal indicator is switched on automatically when the exiting procedure begins.

You are responsible for selecting the turn signal indicator in accordance with the traffic conditions. If necessary, select the turn signal indicator accordingly.

**⚠ WARNING** Risk of accident due to vehicle swinging out while parking or pulling out of a parking space

While parking or exiting a parking space, the vehicle swings out and can drive onto areas of the oncoming lane.

This could cause you to collide with objects or other road users.

- ▶ Pay attention to objects and other road users.
- ▶ Where necessary, stop the vehicle or cancel the parking procedure with Active Parking Assist.

- ▶ If, for example, the **Please Engage Forward Gear** message appears in the media display: select the corresponding transmission position.

The vehicle moves out of the parking space. The turn signal indicator is switched off automatically.

After the parking space has been exited, a warning tone and the  **Parking Assist Finished**,

**Take Control of Vehicle** message prompt you to take control of the vehicle.

The vehicle is not automatically braked and can roll away. You have to accelerate, brake, steer and change gear yourself again.

### Maneuvering assistance

#### Function of Drive Away Assist

Drive Away Assist can reduce the severity of an impact when pulling away. If an obstacle is detected in the direction of travel, the vehicle's speed is briefly reduced to approx. 1 mph (2 km/h). If a critical situation is detected, the  symbol appears in the media display.

- ⓘ You can cancel an intervention by Drive Away Assist at any time by deactivating Parking Assist PARKTRONIC (→ page 198).

**⚠ WARNING** Risk of accident caused by limited detection performance of Drive Away Assist

Drive Away Assist cannot always clearly identify objects and traffic situations.

- ▶ Always pay careful attention to the traffic situation; do not rely on Drive Away Assist alone.
- ▶ Be prepared to brake or swerve as necessary, provided the traffic situation permits and that it is safe to take evasive action.

Drive Away Assist is only an aid. It is not a substitute for your attention to the surroundings. The responsibility for safe maneuvering and parking remains with you. Make sure that no persons, animals or objects etc. are in the maneuvering range.

A risk of a collision may arise in the following situations, for example:

- If the accelerator and brake pedals are interchanged.
- If an incorrect transmission position is engaged.

Drive Away Assist is active under the following conditions:

- If Parking Assist PARKTRONIC is activated.

- If you shift the transmission position to **R** or **D** when the vehicle is stationary.
- If the detected obstacle is less than approx. 3.3 ft (1.0 m) away.
- If the maneuvering assistance function is activated in the multimedia system.

### System limits

The performance of Drive Away Assist is limited on inclines.

- ① Also observe the system limits of Parking Assist PARKTRONIC (→ page 195).

### Function of Cross Traffic Alert

- ① Cross Traffic Alert is only available for vehicles with Blind Spot Assist or Active Blind Spot Assist.

Cross Traffic Alert can warn drivers of any crossing traffic when backing up and maneuvering out of a parking space. The radar sensors in the bumper also monitor the area adjacent to the vehicle. If a critical situation is detected, the  symbol appears in the media display and the vehicle can be braked automatically.

If the radar sensors are obstructed by vehicles or other objects, detection is not possible.

Cross Traffic Alert is active under the following conditions:

- If the vehicle is backing up at walking pace.
- Maneuvering assistance is activated (→ page 204).
- ① Also observe the instructions on Blind Spot Assist and Active Blind Spot Assist (→ page 182).

### System limits

Cross Traffic Alert is not available on inclines.

### Activating or deactivating maneuvering assistance

Multimedia system:

- ➔ Vehicle ➔  Assistance
- ➔➔ Camera & Parking ➔➔ Maneuvering Assist.
- ▶ Activate  or deactivate  the function.
- ① Maneuvering assistance must be active for the function of Drive Away Assist (→ page 203) and Cross Traffic Alert (→ page 204).

### Vehicle towing instructions

The vehicle is not suitable for the use of tow bar systems that are used for flat towing or dinghy towing, for example. Attaching and using tow bar systems can lead to damage on the vehicle. When you are towing a vehicle with tow bar systems, safe driving characteristics cannot be guaranteed for the towing vehicle or the towed vehicle. The vehicle-trailer combination may swerve from side to side. Comply with the permitted towing methods (→ page 349) and the instructions for towing with both axles on the ground (→ page 350).

### Notes on the instrument display and on-board computer

#### **⚠ WARNING** Risk of accident due to an Instrument Display malfunction

If the Instrument Display has failed or malfunctioned, the function restrictions applying to safety relevant systems are not visible.

The operating safety of your vehicle may be impaired.

- ▶ Drive on carefully.
- ▶ Have the vehicle checked immediately at a qualified specialist workshop.

#### **⚠ WARNING** Risk of distraction from information systems and communications equipment

If you operate information and communication equipment integrated in the vehicle when driving, you will be distracted from the traffic situation. This could also cause you to lose control of the vehicle.

- ▶ Only operate this equipment when the traffic situation permits.
- ▶ If you cannot be sure of this, stop the vehicle whilst paying attention to road and traffic conditions and operate the equipment with the vehicle stationary.

#### **! NOTE** Mercedes-AMG vehicles

- ▶ Observe the notes in the Supplement. You could otherwise fail to recognize dangers.

You must observe the legal requirements for the country in which you are currently driving when operating the on-board computer.

The on-board computer shows only display messages and warnings from specific systems on the multifunction display. You must therefore ensure that your vehicle is always reliable.

If the operating safety of your vehicle is impaired, park the vehicle immediately and in accordance with the traffic conditions. Contact a qualified specialist workshop.

### Instrument display overview

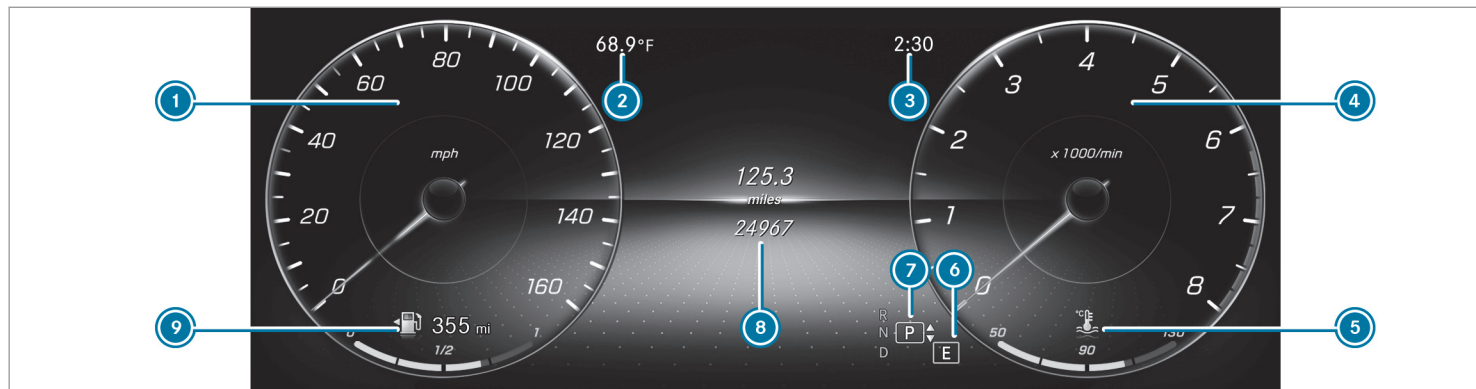





- ① Speedometer  
The segments on the speedometer indicate the status of the following systems: cruise control/limiter/Active Distance Assist DISTRONIC
- ② Outside temperature
- ③ Time
- ④ Area for additional values (example: tachometer/navigation/ECO display/consumption/G-meter/date)
- ⑤ Coolant temperature display  
During normal operation, the coolant temperature display is permitted to rise to 248°F (120°C).
- ⑥ Selected drive program
- ⑦ Selected transmission position
- ⑧ Multifunction display (example: standard display for a trip): assistance/telephone/navigation/trip/media/radio/styles and displays/service/possible settings for Head-up Display
- ⑨ Fuel level and fuel filler flap location indicator

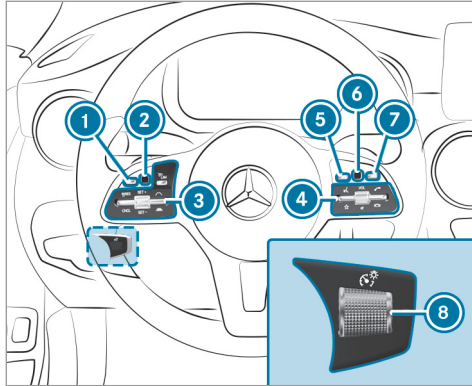

### Overview of buttons on the steering wheel



- ①  Back/Home button (press and hold), on-board computer
- ② Touch Control, on-board computer
- ③ Control panel for cruise control or Active Distance Assist DISTRONIC
- ④ Control panel for the multimedia system  
 Voice Control System (→ page 211)

- ⑤  To call up the home screen of the multimedia system
- ⑥ Touch Control multimedia system
- ⑦  Back button (multimedia system)
- ⑧ Brightness control to adjust the lighting in the Instrument Display and in the control elements of the vehicle interior

### Operating the on-board computer

Observe the legal requirements for the country in which you are currently driving when operating the on-board computer.



The on-board computer is operated using the left-hand Touch Control and the left-hand back/home button.

When the on-board computer is being operated, different acoustic signals will sound as operating feedback, e.g. when the end of a list is reached or when you are scrolling through a list.

The following menus are available:

- [Service](#)
- [DriveAssist](#)
- [Trip](#)
- [Navigation](#)
- [Radio](#)
- [Media](#)
- [Phone](#)
- [Head-up Disp.](#)
- **Vehicles with an instrument display in the widescreen cockpit:** [Designs](#)

- ① You can find information about the possible settings and selections on the menus in the Digital Operator's Manual.

- ▶ **To call up the menu bar:** press the left-hand back button until the menu bar is displayed.
- ① Press the  button to call up the menu bar of the on-board computer.
- ▶ **To scroll on the menu bar:** swipe left or right on the left-hand Touch Control.
- ▶ **To call up a menu, submenu or possible settings on the menu, or confirm a selection or setting:** press the left-hand Touch Control.
- ▶ **To scroll through displays or lists on the menu, or select display content, a function, an entry or a display:** swipe upwards or downwards on the left-hand Touch Control.
- ▶ **To switch between displays:** swipe upwards or downwards on the left-hand Touch Control.
- ▶ **To exit a submenu:** press the left-hand back button.







#### Full-screen menus





You can display the following menus full-screen on the instrument display:

- **DriveAssist**
- **Trip**
- ▶ On the corresponding menu, use the left-hand Touch Control to scroll to the end of the list.
- ▶ Press the left-hand Touch Control. The selected menu will be displayed full-screen.

#### Overview of displays on the multifunction display

Displays on the multifunction display:

-  Active Parking Assist activated (→ page 200)
-  Parking Assist PARKTRONIC deactivated (→ page 198)
-  Cruise control (→ page 163)
-  Active Distance Assist DISTRONIC (→ page 165)
-  Active Brake Assist (→ page 180)
-  Active Steering Assist (→ page 171)

-  Active Lane Keeping Assist (→ page 185)
-  Active Lane Change Assist (→ page 174)
-  ECO start/stop function (→ page 137)
-  HOLD function (→ page 160)
-  Adaptive Highbeam Assist (→ page 115)

**Vehicles with Traffic Sign Assist:** Detected instructions and traffic signs (→ page 180).

#### Head-up Display

##### Function of the Head-up Display

#### ! NOTE Mercedes-AMG vehicles

- ▶ Observe the notes in the Supplement. You could otherwise fail to recognize dangers.

The Head-up Display projects the following into the driver's field of vision:

- Information from the navigation system
- Information from the driver assistance systems

- Some warning messages

### Display content

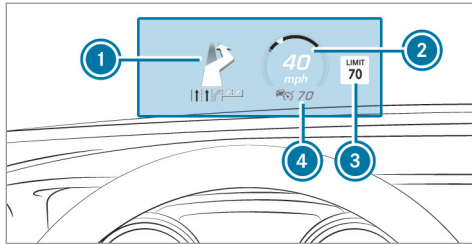

- 1 Navigation instructions
- 2 Current speed
- 3 Detected instructions and traffic signs
- 4 Set speed in the driver assistance system (e.g. cruise control)

When you receive a call, the  **Incoming Call** message will appear on the Head-up Display.

In audio mode, the station name or track will be shown temporarily when the audio source is being actively operated.

### System limits

The visibility is influenced by the following conditions:

- Seat position
  - Image position setting
  - Ambient light
  - Wet road surfaces
  - Objects on the display cover
  - Polarization in sunglasses
- i** In extreme sunlight, sections of the display may appear washed out. You can correct this by switching the Head-up Display off and on again.

### Adjusting the Head-up Display settings on the on-board computer

On-board computer:

 Head-up Disp.



- 1 Setting currently selected
- 2 Digital speedometer
- 3 Traffic Sign Assist
- 4 Navigation displays

The following can be adjusted for the Head-up Display:

- **Position**
- **Brightness**

- Display Content

- ▶ **To select a setting:** swipe upwards or downwards on the left-hand Touch Control.
- ▶ Press the left-hand Touch Control.
- ▶ **To adjust a value:** swipe upwards or downwards on the left-hand Touch Control.
- ▶ Press the left-hand Touch Control.

### Switching the Head-up Display on/off

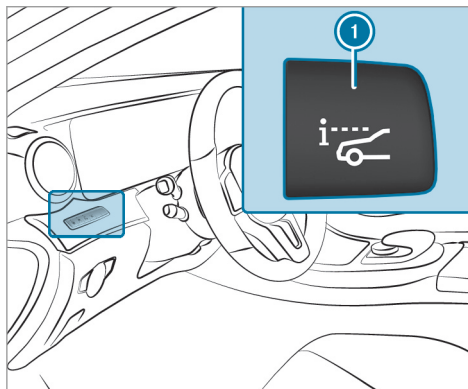

- ▶ Press button ①.

### Notes on operating safety

**⚠ WARNING** Risk of distraction from information systems and communications equipment

If you operate information and communication equipment integrated in the vehicle when driving, you will be distracted from the traffic situation. This could also cause you to lose control of the vehicle.

- ▶ Only operate this equipment when the traffic situation permits.
- ▶ If you cannot be sure of this, stop the vehicle whilst paying attention to road and traffic conditions and operate the equipment with the vehicle stationary.

**⚠ WARNING** Risk of an accident from operating mobile communication equipment while the vehicle is in motion

Mobile communications devices distract the driver from the traffic situation. This could

also cause the driver to lose control of the vehicle.

- ▶ As the driver, only operate mobile communications devices when the vehicle is stationary.
- ▶ As a vehicle occupant, only use mobile communications devices in the areas intended for this purpose, e.g. in the rear passenger compartment.

For your own safety, always observe the following points when operating mobile communications equipment and especially your voice control system:



- Observe the legal requirements for the country in which you are driving.
- If you use the voice control system in an emergency your voice can change and your telephone call, e.g. an emergency call, can thereby be unnecessarily delayed.
- Familiarize yourself with the voice control system functions before starting the journey.

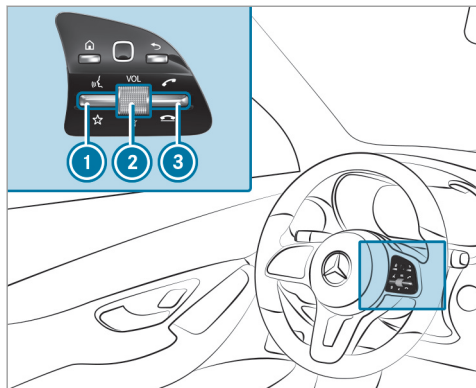

### Operation

#### Overview of operation of the Voice Control System on the multifunction steering wheel

The Voice Control System is operational approximately thirty seconds after the ignition is switched on.



- ➊ Press the rocker switch up:  starts the Voice Control System
- ➋ Press the control:  switches the sound off or on (ends the Voice Control System)  
Turn the control up/down: increases/decreases the volume

- ➌ Press the rocker switch up:  makes/accepts a call  
Press the rocker switch down:  rejects/ends a call (ends the Voice Control System)

### Conducting a dialog with the Voice Control System

- ▶ **To start or continue a dialog:** on the multi-function steering wheel, press the  rocker switch up.  
You can say a voice command after an acoustic signal.
- ▶ **To correct an entry:** say the Correction voice command.
- ▶ **To select an entry from the selection list:** say the line number or the contents.
- ▶ **To browse the selection list:** say the Next or Back voice command.
- ▶ **To interrupt the dialog:** say the Pause voice command.
- ▶ **To cancel the dialog:** say the Cancel voice command.

### Operable functions

You can use the Voice Control System to operate the following equipment depending on the features:

- Telephone
- Text messages
- Navigation
- Address book
- Radio
- Audio (memory card, Media Interface, USB and Bluetooth® audio)
- Vehicle

### Overview of types of voice command

A distinction is made between the following voice commands:

- **Global voice commands** can be said at any time and regardless of the current application, e.g. the voice commands Navigate to, Call or Text message to.

- **Application-specific voice commands** are only available for the active application.

Once the Voice Control System is started an autocue is shown. Apart from the available voice commands for the application currently active, this also cites example voice commands for other applications which are not active. In this way, you will be familiar more quickly with the available voice commands. The list can be scrolled or it can be operated by speech or the controller/touchpad.

### Information on the language setting

You can change the language of the Voice Control System via the system language settings. If the set system language is not supported by the Voice Control System, English will be selected.

The Voice Control System is available in English, French, Portuguese and Spanish.

## Using the Voice Control System effectively

### Features of audible help functions

You receive information and help for the following topics:

- **Optimum operation:** say the brief instruction voice command.
- **Current application:** on the multifunction steering wheel, press the  rocker switch up and say the Help voice command.
- **Continued dialog:** say the Help voice command during a voice dialog.
- **Specific function:** say voice commands for the desired function, e.g. Help telephone.

### Notes on how to improve speech quality

If the Voice Control System does not understand you:

- only operate the Voice Control System from the driver's seat.

- say the voice commands coherently and clearly, but do not exaggerate the words.
- avoid loud noises that cause interference while making a voice command entry, e.g. the blower.

A voice tag in the address book is not recognized:

- only create sensible address book entries in the system/mobile phone, e.g. enter surname and first name in the correct field.
- do not use any abbreviations, unnecessary spaces or special characters.

If a station list entry is not recognized:

- say the Read out station list voice command.

## Essential voice commands

### Overview of switch voice commands

Switch voice commands can be used to open certain applications. The voice command selection can be used regardless of the application that is currently active.

**Switch voice commands**

<b>Voice command</b>	<b>Function</b>
Navigation	To switch to navigation mode
Map	To switch to map display
Address book	To switch to address book
Telephone	To switch to telephone mode
Text message	To switch to text messages
Radio	To switch to radio mode
Media	To switch to media mode
USB	To switch to USB
Memory card	To switch to memory card
Internet application <Name>	To start a Mercedes-Benz online application. The application must be called up once using the multimedia system prior to use.
Mercedes-Benz Apps	To switch to Mercedes-Benz Apps
Connect	To switch to Internet mode



Voice command	Function
Vehicle menu	To switch to vehicle settings
System settings menu	To switch to system settings

### Overview of navigation voice commands

Using navigation voice commands, you can enter POIs or conventional addresses and make important navigation settings directly.

#### Navigation voice commands

Voice command	Function
Navigate to <Address/POI/Contact>	Universal search for all types of destinations. A search is conducted in the address book contacts, the navigation database and on the Internet (POIs). The order of the details, e.g. city, street or house number, can be changed.
Address in <Country>	Destination entry in a desired country, e.g. address in France
Home	Starts navigation to home address
Work	Starts navigation to your workspace

Voice command	Function
POI <POI>	Destination entry for a POI, e.g. the POI Brandenburg Gate. A search is performed in the navigation database and on the Internet.
POI online search <POI>	Conducts a POI search on the Internet only
Navigate to contact <Name>	Destination entry to a contact in the address book
Enter country Enter city Enter district Enter street Enter intersection Enter house number Enter ZIP code	Enters a country/city/district/street/intersection/house number/ZIP code
Nearest restaurant Nearest parking lot Nearest rest area with restrooms Nearest gas station	Searches for nearby restaurants, parking options, rest areas with restrooms and gas stations

Voice command	Function
Restaurant along the route Parking along the route Rest area with restrooms along the route Gas stations along the route	Searches for restaurants, parking options, rest areas with restrooms and gas stations along the route
Restaurant at destination Parking at destination Rest area with restrooms at destination Gas station at destination	Searches for restaurants, parking options, rest areas with restrooms and gas stations at the destination
Last destinations	Selects a destination from the list of last entered destinations
Alternative routes	Switches route guidance to another route
Start route guidance	Starts route guidance after entering a valid destination
Cancel route guidance	Cancels route guidance
Guidance instructions on Guidance instructions off	Switches the route guidance voice output on/off

Voice command	Function
Show traffic map Hide traffic map	Switches the traffic map on/off
Switch on POI symbols Switch off POI symbols	Switches the POI symbols display on the map on/off

### Overview of telephone voice commands

You can use the telephone voice commands to make phone calls or search through the address book.

### Telephone voice commands

Voice command	Function
Call <Name>	Makes a phone call. All address book names are available.
Search for contact <Name>	Searches for and displays a contact. All address book names are available.
Outgoing calls	Displays the last call
Redial	Selects the last phone number dialed

### Overview of radio voice commands

Radio voice commands can also be used when the radio application is running in the background.

#### Radio voice commands

Voice command	Function
Station <Name>	To call up receivable or saved stations
<Frequency>	To enter a frequency directly
Next station	To switch to the next available station
Previous station	To switch to the previous station
Save station	To save a station in the station list
Show station list	To display the names of all receivable stations
Read out station list	To listen to the names of all receivable stations

## 220 Voice Control System

---

Voice command	Function
Traffic information on Traffic information off	To switch the traffic information service on/off
Radio info on Radio info off	To switch information about the current station on/off

### Overview of media player voice commands

Media player voice commands can also be used when the media player runs in the background.

**Media player voice commands**

Voice command	Function
Play <Tracks> Play <Albums> Play <Artists> Play<Composers> Play <Genres> Play <Playlists>	The names of all available tracks, albums, artists, composers, genres or playlists are accepted during the search.
Media search <Track> Media search <Albums> Media search <Artists> Media search <Composers> Media search <Genres> Media search <Playlists>	The names of all available tracks, albums, artists, composers, genres or playlists are accepted during the search.

Voice command	Function
Show all albums Show all artists Show all composers Show all genres Show all tracks Show all playlists	Available albums, artists, composers, genres, tracks or playlists are searched for.
Next track	To select the next track
Previous track	To select the previous track
Random playback on Random track list off	To switch the random track list on/off

### Overview of message voice commands

Text messages can be created, edited and listened to using the message voice commands.



### Message voice commands

Voice command	Function
Text message to <Name>	To create a message. All address book names are available.
Reply	To reply to a message
Forward text message	To forward a message

### Overview of vehicle voice commands

You can use the vehicle voice commands to directly call up the corresponding menus for the vehicle settings.

### Vehicle voice commands

Voice command	Function
Ambient light menu	To display ambient light settings
Ambient light "blue"	To switch ambient light to blue
Display and styles menu	To show display settings
Assistance menu	To display assistance settings

## 224 Voice Control System

---

<b>Voice command</b>	<b>Function</b>
Scent menu	To display fragrance settings
Energy flow	To display energy flow settings
Ionization menu	To display ionization settings
Climate control menu	To display climate control settings
Automatic climate control driver on	To switch on the automatic climate control settings on the driver's side
Light menu	To display light settings
Massage menu	To display massage settings
Massage driver's seat on	To switch on the massage function for the driver's seat
Massage driver's seat off	To switch off the massage function for the driver's seat
Outside temperature	To display the outside temperature
Engine data	To display engine data
Seats menu	To display seat adjustment settings
Seat heating front passenger level "2"	To set the seat heating for the front passenger seat to level 2

Voice command	Function
Consumption menu	To display consumption
Vehicle data	To display vehicle data

## Overview and operation

### Overview of the multimedia system

**⚠ WARNING** Risk of distraction from information systems and communications equipment

If you operate information and communication equipment integrated in the vehicle when driving, you will be distracted from the traffic situation. This could also cause you to lose control of the vehicle.

- ▶ Only operate this equipment when the traffic situation permits.
- ▶ If you cannot be sure of this, stop the vehicle whilst paying attention to road and traffic conditions and operate the equipment with the vehicle stationary.

You must observe the legal requirements for the country in which you are currently driving when operating the multimedia system.

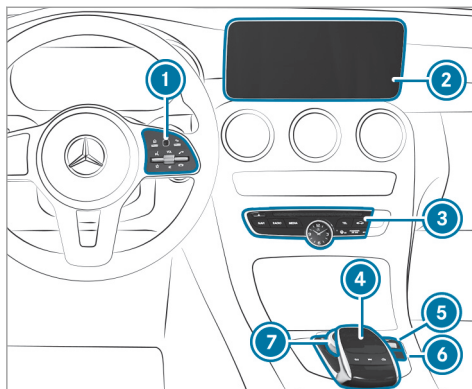

- ① Touch Control  
Multimedia system button group on the steering wheel (→ page 207)
- ② Media display
- ③ Main function button group (→ page 230)
- ④ Touchpad
- ⑤ Controller
  - Adjusts the volume (→ page 233)

- Switches the sound on/off (→ page 232)

For Mercedes-AMG vehicles with AMG Performance exhaust system:

- Turn: adjusts the volume
- Press: switches the multimedia system on/off

⑥  button

- Switches multimedia system on/off

For Mercedes-AMG vehicles with AMG Performance exhaust system:

- Sets the volume of the AMG Performance exhaust system

⑦ Controller

### Notes on the media display

**!** **NOTE** Scratches on the display

The display has a highly sensitive, high-gloss surface. There is a risk of it becoming scratched.

- ▶ Avoid touching the display.
- ▶ Observe the notes on cleaning.

Observe the notes on caring for the interior (→ page 334).

**Automatic temperature-controlled switch-off feature:** if the temperature is too high, the brightness is initially reduced automatically. The display may then switch off completely for a while.

- ❗ If you are wearing polarized sunglasses, it may be difficult to read the display.

### Central control elements overview

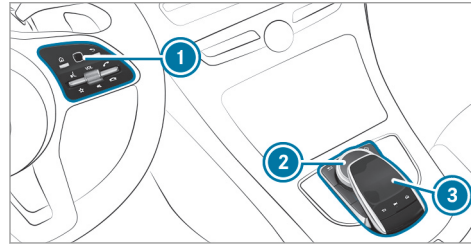

- ❶ Touch Control
- ❷ Controller
- ❸ Touchpad

### Touch Control

#### Operating Touch Control

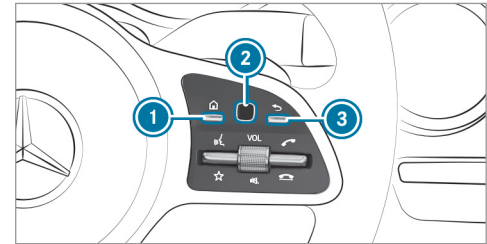

- ▶ Operate the multimedia system with Touch Control ❷ and associated buttons ❶ and ❸.

#### Calling up the main functions

- ▶ Press button ❶.

or

- ▶ Press button ❸ repeatedly until the main functions are shown.

#### Calling up favorites

- ▶ Press button ❶.

- ▶ Swipe down on Touch Control ②.

### Opening and closing a list

- ▶ **To open:** press Touch Control ②.
- ▶ **To close:** press button ③.

or

- ▶ Swipe right on Touch Control ②.

### Selecting a menu item

- ▶ Swipe up, down, left or right on Touch Control ②.
- ▶ Press Touch Control ②.

### Moving the digital map

- ▶ Swipe in any direction.

### Setting the sensitivity for the Touch Control

Multimedia system:

- ▶ System ▶ Input
- ▶ Touch Control Sensitivity
- ▶ Select **Fast**, **Medium** or **Slow**.

### Operating the controller

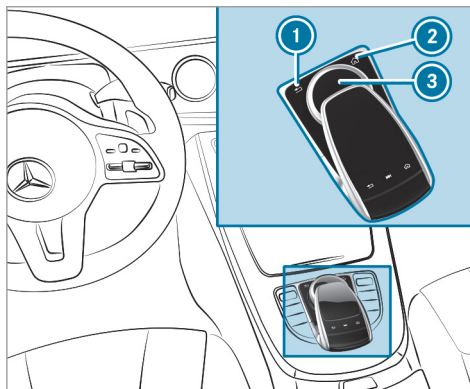

- ① button  
Press briefly: returns to the previous display  
Press and hold: calls up main functions
- ② button  
Calls up the main functions

To call up favorites: when the main functions are displayed, slide controller ③ down.

- ③ Controller

Controller operating options:

- ▶ Turn counter-clockwise or clockwise.
- ▶ Slide left or right.
- ▶ Slide up or down.
- ▶ Slide diagonally.
- ▶ Press briefly or press and hold.

### Touchpad

#### Activating/deactivating the touchpad

Multimedia system:



- ▶ System ▶ Input
- ▶ Activate  or deactivate  the **Touchpad**.

#### Operating the touchpad

##### Requirements:

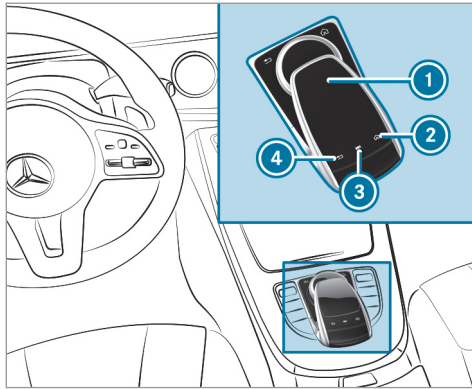
- The touchpad is switched on (→ page 228).



- ① Touchpad
- ②  button  
Calls up main functions and favorites
- ③  button  
Calls up the control menu of the last active audio source
- ④  button  
Press briefly: returns to the previous display

You can navigate in menus and lists via touch-sensitive surface ① by using a **single-finger swipe**:

- ▶ **To open or close lists:** swipe left or right.
- ▶ **To select the menu item:** swipe up, down, left or right.
- ▶ Press touchpad ①.
- ▶ **To move the digital map:** swipe in any direction.

**Use the following functions with a two-finger swipe:**

- ▶ **To call up main functions and favorites:** swipe down with two fingers. The swipe must start in the upper area of the touchpad.
- ▶ **To zoom in and out of the map:** move two fingers together or apart.
- ▶ **To call up the control menu of the last active audio source:** swipe up with two fingers. The swipe must start in the lower area of the touchpad.

### Setting the sensitivity for the touchpad

Multimedia system:

↳ System ▶  Input

- ▶ Select **Touchpad Sensitivity**.
- ▶ Select **Fast**, **Medium** or **Slow**.
- ▶ **To set the pressure sensitivity:** switch **Touchpad Tap** on  or off .  
If the function is switched on , a tap on the touchpad is enough to select a menu item.

### Handwriting recognition: switching the read-aloud function on/off

Multimedia system:

↳ System ▶  Audio

▶ System Feedback

- ▶ Switch **Read Out Handwriting Recognition** on  or off .

### Activating/deactivating haptic operating feedback on the touchpad

Multimedia system:

→ System →  Input

The function supports you when making entries on the touchpad and when selecting menus.

- ▶ Switch **Haptic Operating Feedback** on  or off .  
When the function is activated, a tactile feedback in the form of a vibration is effected when the touchpad is operated.

### Selecting a station and track using the touchpad





- ▶ Press the  button on the touchpad.  
or
- ▶ Swipe up with two fingers. The swipe must start in the lower area of the touchpad. The control menu appears for the audio source that was last selected.
- ▶ Use one finger to swipe up or down.  
Radio: the previous or the next station is set.  
Media source: the previous or the next music track is selected.

- ▶ **To hide the control menu:** swipe down with two fingers. The swipe must start in the upper area of the touchpad.

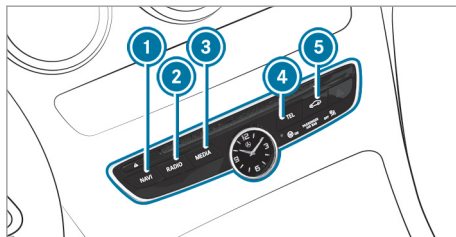
### Main functions

#### Calling up the main functions



- 1  **NAVI** button  
Calls up navigation
- 2  **RADIO** button  
Calls up the radio
- 3  **MEDIA** button  
Calls up media
- 4  **TEL** button

- 5  button  
Sets vehicle functions

- ▶ Alternatively: press the  button on the Touch Control, controller or the touchpad. The main functions are displayed.
- ▶ Select the main function.

### Favorites

#### Overview of favorites

Favorites offer you quick access to frequently used applications. It is possible to create 20 favorites in total.

The following functions are available:

- add **pre-defined favorites** from the following categories (→ page 231):
  - **Navigation**
  - **Entertainment**
  - **Phone**
  - **Connect**
  - **Vehicle**



### - System Settings

- add **your own favorites** (→ page 231)
- rename favorites (→ page 231).
- move favorites (→ page 231).
- delete favorites (→ page 231).
- reset all favorites (→ page 231)

#### Calling up favorites

- ▶ Press the  button.  
The main functions are displayed.
- ▶ Navigate downwards once.  
Navigating means:
  - Swiping on the Touch Control or the touchpad
  - Sliding the controller

#### Leaving the favorites menu

- ▶ Press the  button.

#### Adding favorites

##### Adding predefined favorites

- ▶ Press the  button.  
The main functions are displayed.

- ▶ Navigate downwards twice.  
The Favorites menu appears.
- ▶ Select **New Favorite**.  
The categories are displayed.
- ▶ Select a category.  
The favorites are displayed.
- ▶ Select a favorite.
- ▶ Store the favorite at the desired position.  
If a favorite has already been added at this position, it will be overwritten.

#### Example: adding your own favorites

- ▶ Select **Vehicle**.
- ▶ Select **Full Screen: Consumption**.
- ▶ Press and hold the  button until the favorites are displayed.
- ▶ Store the favorite at the desired position.

If **No function available for saving** is shown, the selected function cannot be added.

#### Renaming favorites

- ▶ Press the  button.  
The main functions are displayed.

- ▶ Navigate downwards once.
- ▶ Select a favorite.
- ▶ Navigate downwards once.  
The Favorites menu appears.
- ▶ Select **Rename**.
- ▶ Enter the characters.
- ▶ **To confirm the entry:** select .

#### Moving favorites

- ▶ Press the  button.  
The main functions are displayed.
- ▶ Navigate downwards once.
- ▶ Select a favorite.
- ▶ Navigate downwards once.  
The Favorites menu appears.
- ▶ Select **Move**.
- ▶ Move the favorite to the desired position.  
If a favorite has already been added at this position, it will be overwritten.

#### Deleting favorites

- ▶ Press the  button.  
The main functions are displayed.

- ▶ Navigate downwards once.
- ▶ Select a favorite.
- ▶ Navigate downwards once.  
The Favorites menu appears.
- ▶ **To delete:** select **Delete**.
- ▶ Select **Yes**.
- ▶ **To restore all favorites:** select **Reset All**.  
A prompt appears.
- ▶ Select **Yes**.  
The favorites are reset to the factory settings.

### Switching the sound on/off

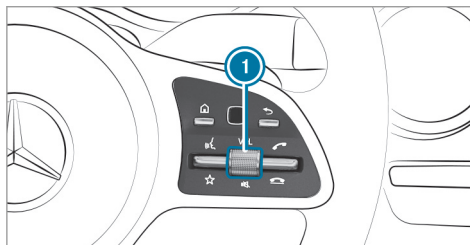

On the multifunction steering wheel

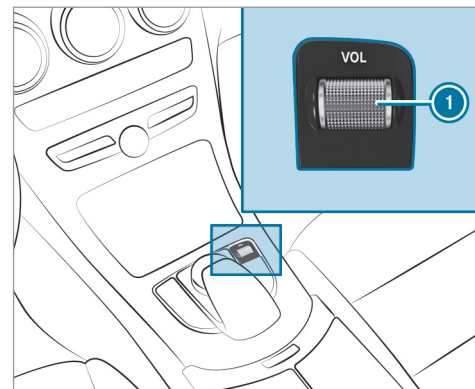

On the multimedia system

- ▶ **To mute:** press volume control ①.  
The  symbol appears in the status line of the display.  
You will also hear traffic announcements and navigation announcements even when the sound is muted.

- ▶ **To switch on:** change the media source or turn volume control ①.

## Adjusting the volume

### Setting with the volume control

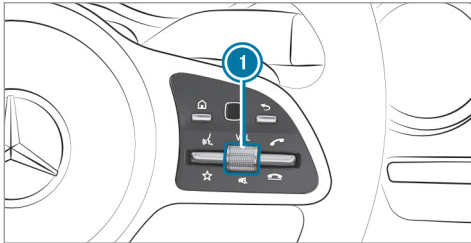

On the multifunction steering wheel

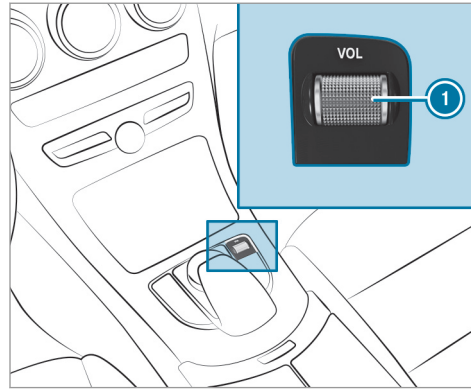

On the multimedia system

- ▶ Turn volume control ①.  
The volume of the current radio or media source is set. The volume of other audio sources can be adjusted separately.
- Adjust this in the following situations:
- During a traffic announcement
  - During a navigation announcement

The volume of the navigation announcement changes in accordance with the volume of the current media source.

- During a telephone call
- When entering or exiting a parking space while using Active Parking Assist

### Setting in the menu

- ▶ Select **System** in the multimedia system.
- ▶ Select **Audio**.
- ▶ Select a volume setting.
- ▶ Set the volume.

## Entering characters

### Using the character input function

**⚠ WARNING** Risk of distraction from information systems and communications equipment

If you operate information and communication equipment integrated in the vehicle when driving, you will be distracted from the

traffic situation. This could also cause you to lose control of the vehicle.

- ▶ Only operate this equipment when the traffic situation permits.
- ▶ If you cannot be sure of this, stop the vehicle whilst paying attention to road and traffic conditions and operate the equipment with the vehicle stationary.

You must observe the legal requirements for the country in which you are currently driving when operating the multimedia system.

Use the character input function in the following situations, for example:

- Renaming a favorite
- Entering a POI or address
- Making a phone call

The following functions are available:

- Selecting a character in the character bar
- Writing a character on the touchpad

Character input can be started with a control element and resumed with another.

- ▶ **On the Touch Control and controller:** select the characters in the character bar. Depending on the target entry, the following characters are available:
  - The full set of characters is shown
  - Only those characters which are useful for the current input string are shown
 Other characters are grayed out.
- ▶ **On the touchpad:** select the characters in the character bar.

or

- ▶ Write the characters on the touch-sensitive surface of the touchpad. Handwriting recognition supports you by means of character suggestions and a read-aloud function.

Examples of character entry:

- Renaming a favorite
- Entering a POI or an address using free or step-by-step search
- Entering a web address

## Entering characters using the controller

### Example: renaming favorites







- ▶ Call up the "Renaming favorites" function (→ page 231).
- ▶ **To enter a character:** turn **[⊙]**, slide **↑⊙↓** and press the controller. The character is entered in the input line.

Use the following entry functions:

- [<X]** To delete a character: press the controller.

To delete an entry: press and hold the controller until the entire entry is deleted.

-  To switch to special characters and symbols.
-  To switch to upper-case or lower-case letters.
-  To switch the language.
-  To switch to character entry on the touchpad.

 The available editing functions depend on the editing task, the language set and the character level.

- ▶ **To confirm the entry:** select .

#### Example: entering a destination (navigation)

- ▶ Enter the POI or address (→ page 249).

#### Entering characters on the touchpad

##### Requirements:

- The touchpad is switched on (→ page 228).
- The entered or selected character should be read out: the handwriting recognition read-aloud function is switched on (→ page 229).

#### Example: renaming favorites

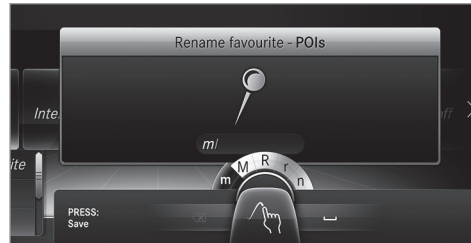

- ▶ Call up the "Renaming favorites" function (→ page 231).
- ▶ **To enter a character:** use your finger to write characters on the touchpad. The character is entered in the input line. If different interpretations are possible, character suggestions are displayed.
- ▶ **To select a character suggestion:** swipe up or down on the touchpad.
- ▶ Resume character input.
- ▶ **To enter a space:** swipe right when the cursor is located in the input line.

- ▶ **To delete a character:** swipe left when the cursor is located in the input line.
- ▶ **To confirm the entry:** press the touchpad.
- ▶ **To finish character entry:** swipe upwards.

or

- ▶ Press the  button.

#### Example: entering a destination (navigation)

- ▶ Enter the POI or address (→ page 249).

### System settings

#### Display

#### Configuring display settings

Multimedia system:

- ↳ [System](#) ▶  [Display and Designs](#)

#### Styles

- ▶ Select [Designs](#).
- ▶ Select [Sport](#), [Classic](#) or [Progressive](#).

#### Adapting the ambient lighting for the style

- ▶ Select [Adjust Amb. Lighting](#).
- ▶ Activate  or deactivate  the function.

This function adjusts the ambient lighting for the selected display style.

### Setting the display brightness

- ▶ Select [Display Brightness](#).
- ▶ Select a brightness value.

### Switching the display off/on

- ▶ **To switch off:** select [Display Off](#).
- ▶ **To switch on:** press a button, , for example.

### Display design

- ▶ Select [Day/Night Design](#).
- ▶ Select [Automatic](#), [Day Design](#) or [Night Design](#).

### Additional display area

Depending on the vehicle, various items of additional information can be shown. The additional display area comprises the left-hand or right-hand third of the display.

- ▶ Select [Additional Disp. Area](#).

The following display content can be selected:

- [Dynamic](#)
- [Navigation Map](#)
- [Consumption](#)
- [Time and Date](#)

### Time and date

#### Setting the time and date automatically

Multimedia system:

 [System](#) ▶▶  [Time and Date](#)

- ▶ Deactivate  [Manual Time Adjustment](#).  
The time and date are set automatically for the selected time zone and summer time option.

 The correct time is required for the following functions:

- Route guidance with time-dependent traffic guidance.
- Calculation of expected time of arrival.

### Setting the time zone

Multimedia system:

 [System](#) ▶▶  [Time and Date](#)

▶▶ [Time Zone](#):

The list of countries is displayed.

- ▶ Select a country ●.  
Depending on the country, time zones are displayed.
- ▶ Select a time zone.  
The time zone set is displayed after [Time Zone](#):

### Setting summer time

The [Automatic Daylight Saving Time](#) and [Daylight Saving Time](#) options cannot be selected in all countries.

Multimedia system:

 [System](#) ▶▶  [Time and Date](#)

### Automatically

- ▶ Switch [Automatic Daylight Saving Time](#) on  or off .

**Manually**

- ▶ Deactivate  Automatic Daylight Saving Time.
- ▶ Select Daylight Saving Time.
- ▶ Select On or Off.

**Setting the time and date format**

Multimedia system:

- ↳ System ▶  Time and Date
- ▶▶ Set Format
- ▶ Set the date and time format •.

**Setting the time manually****Requirements:**

- The Manual Time Adjustment function is switched on.

Multimedia system:

- ↳ System ▶  Time and Date
- ▶▶ Set Time
- ▶ Set the hours.
- ▶ Navigate to the right to set the minutes.
- ▶ Set the minutes.

- ▶ Confirm changes when exiting the menu.

The date is set automatically via GPS.

**Connectivity****Switching transmission of the vehicle position on/off**

Multimedia system:

- ↳ System ▶  Connectivity
- ▶ Select Transmit Vehicle Pos..
- ▶ Activate  or deactivate  the function.

**Bluetooth®****Information about Bluetooth®**

Bluetooth® technology is a standard for short-range wireless data transfer up to approximately 32.8 ft (10 m).

You can use Bluetooth® to connect your mobile phone to the multimedia system and use the following functions, for example:

- Hands-free system with access to the following options:

- contacts (→ page 280)
- call lists (→ page 282)
- text message (→ page 283)
- Internet connection (→ page 296)
- Listening to music via Bluetooth® audio
- Transferring business cards (vCards) into the vehicle

Bluetooth® is a registered trademark of Bluetooth Special Interest Group (SIG) Inc.

- ⓘ Internet connection via Bluetooth® is not available in all countries.

**Activating/deactivating Bluetooth®****Requirements:**

- Deactivate Bluetooth®: Apple CarPlay® is not active.

Multimedia system:

- ↳ System ▶  Connectivity
- ▶ Activate  or deactivate  Bluetooth®.

If Android Auto is active, a prompt appears asking whether Bluetooth® should be deactivated.

▶ Select **Yes**.

Android Auto is closed and Bluetooth® is deactivated.

## Wi-Fi

### Wi-Fi connection overview

You can use Wi-Fi to establish a connection with a Wi-Fi network and to access the Internet or other network devices.

The following connection options are available:

- Wi-Fi connection

The Wi-Fi connection to a Wi-Fi-capable device, e.g. the customer's mobile phone or a tablet PC is established.

- Multimedia system as a Wi-Fi hotspot

Using this function, a tablet PC or notebook can be connected, for example.

To establish a connection, you can use the following methods:

- WPS PIN

The connection to a secure Wi-Fi network is made via a PIN.

- WPS PBC

The connection to a secure Wi-Fi network is made by pressing a button (push button).

- Security key

The connection to a secure Wi-Fi network is made via a security key.

### Setting up Wi-Fi

#### Requirements:

- The device to be connected supports one of the three means of connection described (→ page 238).

Multimedia system:

↳ System ▶  Connectivity

#### Activating/deactivating Wi-Fi

▶ Switch **Wi-Fi** on  or off .

If **Wi-Fi** is deactivated , communication via Wi-Fi to all devices is interrupted. This also means that a connection to the HERMES communication module cannot be estab-

lished. Then functions such as dynamic route guidance with Live Traffic Information are not available.

### Connecting the multimedia system with a device via Wi-Fi

This function is not available if a HERMES communication module is installed.

The type of connection established must be selected on the multimedia system and on the device to be connected.

**i** The connection procedure may differ depending on the device. Follow the instructions that are shown in the display. Further information (see the manufacturer's operating instructions).

▶ Select **Internet Settings**.

▶ Select **Search for Wi-Fi Networks**.

#### Using a security key

▶ Select a Wi-Fi network in the list.

▶ Have the security key displayed on the device to be connected (see the manufacturer's operating instructions).



- ▶ Enter this security key on the multimedia system.
- ▶ Confirm the entry with **OK**.
- ⓘ All devices support a security key as a means of connection.

### Using a WPS PIN



- ▶ Highlight a Wi-Fi network in the list.
- ▶ Select  **Connect via WPS PIN Input**. The multimedia system generates an eight-digit PIN.
- ▶ Enter this PIN on the device to be connected.
- ▶ Confirm the entry.

### Using a button

- ⓘ This function is only available in a Wi-Fi frequency of 2.4 GHz.
- ▶ Highlight a Wi-Fi network in the list.
- ▶ Select  **Connect via WPS PBC**.
- ▶ Select "Connect via WPS PBC" in the options on the device to be connected.
- ▶ Press the WPS button on the device to be connected.

- ▶ Select **Continue** in the multimedia system.

### Device has already been connected:

- ▶ **To automatically connect:** highlight a Wi-Fi network in the list.
- ▶ Activate  **Connect Automatically** .
- ▶ **To connect:** highlight a Wi-Fi network in the list.
- ▶ Select  **Connect**. The connection is established again. These functions are possible when the device has already been connected to the Wi-Fi network.

### Setting up a Wi-Fi hotspot

#### Requirements:

- **For connection by pressing a button:** this function is only available in a Wi-Fi frequency of 2.4 GHz.

Multimedia system:

 **System** ▶  **Connectivity**

### Configuring the multimedia system as a Wi-Fi hotspot

The type of connection established depends on the device to be connected. The function must be supported by the multimedia system and by the device to be connected. The type of connection established must be selected on the multimedia system and on the device to be connected.

- ▶ Select **Set Up Hotspot**.
- ▶ Highlight **Connect Device to Vehicle Hotspot**.

### Generating a WPS PIN

- ▶ Select  **Connect via WPS PIN Generation**.
- ▶ Enter the PIN shown in the media display on the device to be connected and confirm.

### Connecting using a WPS PIN

- ▶ Select  **Connect via WPS PIN Input**.
- ▶ Select **Enter WPS PIN**.

- ▶ Enter the PIN that is shown on the external device's display on the multimedia system.
- ▶ Select **Continue**.

#### Connecting using a button

- ▶ Select  **Connect via WPS PBC**.
- ▶ Press the WPS button on the device to be connected or select **Connect**.
- ▶ Select **Continue** in the multimedia system.

#### Connecting using a security key

- ▶ Select **Connect Device to Vehicle Hotspot**. A security key is displayed.
- ▶ Select the vehicle from the device to be connected. The vehicle is displayed with the SSID **MB Hotspot XXXXX**.
- ▶ Enter the security key which is shown in the media display on the device to be connected.
- ▶ Confirm the entry.

#### Connecting using NFC

- ▶ Select **Connection via NFC**.

- ▶ Activate NFC on the mobile device (see the manufacturer's operating instructions).
- ▶ Bring the mobile device into the NFC area of the vehicle (→ page 278).
- ▶ Select **Done**.  
The mobile device is now connected to the multimedia system hotspot via NFC.

#### Generating a new security key:

- ▶ Select **Set Up Hotspot**.
- ▶ Select **Generate Security Key**.  
A connection will be established with the newly created security key.
- ▶ **To save a security key:** select **Save**.  
When a new security key is saved, all existing Wi-Fi connections are then disconnected. If the Wi-Fi connections are being re-established, the new security key must be entered.

#### Managing COMAND Touch devices

##### Requirements:

- The COMAND Touch app is installed on the external device (e.g. tablet or smartphone).

- Wi-Fi is activated (→ page 238) and the multimedia system is configured as a Wi-Fi hotspot (→ page 239).

Multimedia system:

↳ **System** ▶ **COMAND Touch**

#### Connecting and authorizing a new device

- ▶ Select **Authorize a New Device**.
- ▶ Select **Connect New Device**.
- ▶ Enter the security key in the external device. The **Please start COMAND Touch on your device and follow the instructions** message appears.
- ▶ Select **Continue**.
- ▶ The connection request from the device **Accept**.
- ▶ Enter the PIN shown on the external device. The device is authorized.

#### Authorising a connected device

- ▶ Select **Authorize a New Device**.  
The devices already connected are displayed.

- ▶ Select **Continue Using Connected Devices**. The **Please start COMAND Touch on your device and follow the instructions.** message appears.
- ▶ Select **Continue**.
- ▶ The connection request from the device **Accept**.
- ▶ Enter the PIN shown on the external device. The device is authorized.

#### De-authorizing the device

- ▶ Select an authorized device from the list. A prompt will appear asking whether you would like to de-authorize the selected device.
- ▶ Select **Yes**. The device is de-authorized.

#### Activating/deactivating child safety lock

Multimedia system:

↳ System ▶ Parental Control

#### Locking or unlocking an external device

- ▶ Select an external device.
- ▶ Select **Lock**. The device connected via the COMAND Touch app is locked  or unlocked .

#### System language

##### Notes on the system language

This function allows you to determine the language for the menu displays and the navigation announcements. The selected language affects the characters available for entry. The navigation announcements are not available in all languages. If a language is not available, the navigation announcements will be in English.

#### Setting the system language

Multimedia system:

↳ System ▶ Language

- ▶ Set the language.
- ⓘ If you are using Arabic map data, the text information can also be shown in Arabic on the navigation map. To do so, select العربية as the language from the language list. Navigation announcements are then also made in Arabic.

#### Setting the distance unit

Multimedia system:

↳ System ▶  Units

- ▶ Select **km** or **mi**.
- ▶ In the multifunction display of the Instrument Display, switch the **Additional Speedometer** display on .

## Data import and export

### Data import/export function

The following functions are possible:

- Transferring data from one system or vehicle to another system or vehicle.
- Creating a backup copy of your personal data and loading it again.
- Protecting your personal data against unwanted export with PIN protection.

 Please note that the NTFS file system is not supported. The FAT32 file system is recommended.

### Importing/exporting data

 **NOTE** Loss of data due to premature removal

 Do not remove the data storage medium when data is being exported.

Mercedes-Benz is not liable for any loss of data.

### Requirements:

- The vehicle is stationary.
- The ignition is switched on or the vehicle has been started.
- The SD card is inserted (→ page 302) or the USB device is connected (→ page 303).

Multimedia system:

 [System](#)  [System Backup](#)

 Select [Import Data](#) or [Export Data](#).

### Importing



 Select a data storage medium. A prompt appears asking whether you really wish to overwrite the current data. If data originates from another vehicle, this is recognized during data reading.

The multimedia system is restarted once the data has been imported.

 Current vehicle settings can be edited after the import.

### Exporting

If PIN protection is activated, your PIN is requested.

-  Enter the four-digit PIN.
-  Select a data storage medium. The data is exported. The data export may take several minutes.

## Activating/deactivating PIN protection

### Requirements:



To unlock the PIN:

- There is an Internet connection.
- A Mercedes me account exists at <https://me.secure.mercedes-benz.com>.
- The [Personalization](#) service is active (→ page 243).

Multimedia system:

 [System](#)  [PIN Protection](#)

### Setting the PIN

-  Select [Set PIN](#).
-  Enter a four-digit PIN.
-  Enter the four-digit PIN again. If both PINs match, PIN protection is active.

### Changing the PIN

- ▶ Select [Change Settings](#).
- ▶ Enter the current PIN.
- ▶ Select [Change PIN](#).
- ▶ Set a new PIN.

### Activating PIN protection for data export

- ▶ Select [Change Settings](#).  
Confirm with the PIN.
- ▶ Select [Protect Data Export](#).  
Activate  or deactivate  the function.

### Unblocking the PIN

If the PIN has been entered incorrectly three times, the PIN will be blocked. You can have a single-use password sent to you via the Mercedes me connect online portal to reset the PIN protection.

- ▶ Select [Unblock PIN](#).
- ▶ Enter the single-use password.  
PIN protection is reset, and you can set a new PIN.

- ⓘ The availability of this function is country dependent and may not be available in your country.  
Alternatively, you can have PIN protection reset at an authorized Mercedes-Benz Center.

### User profile

#### Setting a user profile

Multimedia system:

↳ System ▶  Personalization

#### Displaying a user profile when starting

If this function is active, a prompt appears when starting the system asking which user profile to use.

- ▶ Select [Display Profile Selection after Start](#).
- ▶ Activate  or deactivate  the function.

#### Selecting a user profile

- ▶ Select [Guest Profile](#) or individual profile ●.
- ⓘ Some settings from the user profile are only loaded when the vehicle is stationary or when the ignition is switched on.

### Automatic synchronization

Each time the ignition is switched off or on, the individual user profiles are synchronized on the multimedia system and on the server. This ensures that the latest user profiles are available.

- ▶ Select [Automatic Synchronization](#).
- ▶ Activate  or deactivate  the function.
- ⓘ For more information about importing/exporting user profiles (→ page 244).

### Creating a user profile

Multimedia system:

↳ System ▶  Personalization

▶ Create Profile

- ▶ Enter a name.
- ▶ Select  **OK**.

The following information is saved in the user profile, for example:

- System settings
- Navigation and traffic information

The settings differ depending on the vehicle equipment.

## Importing/exporting a user profile

### Requirements:

- There is an Internet connection .
- A Mercedes me account exists at <https://me.secure.mercedes-benz.com>.
- The [Personalization](#) service is active.
- The function is available in your country.

Multimedia system:

↳ System »  Personalization  
 ↳ Manual Export/Import

### Importing a user profile

- ▶ Select [Import Profiles from Server](#).  
The [The profile data import overwrites all existing profile data. Do you want to continue?](#) message appears.
- ▶ Select [Yes](#).  
User profiles are imported.

### Exporting a user profile

- ▶ Select [Export Profiles to the Server](#).  
User profiles are exported.

- ⓘ Only individual profiles can be imported or exported. The individual profiles are always collectively imported or exported.
- ⓘ Certain settings, such as address book entries or previous destinations from the navigation system, are not exported.

### Setting user profile options

Multimedia system:

↳ System »  Personalization

- ▶ Highlight a profile.
- ▶ Select  options.

The following options are available:

- [Rename](#)
- [Delete](#)
- [Reset](#)
- ⓘ The guest profile cannot be deleted or renamed.

## Software updates

### Information on software updates

The multimedia system displays a corresponding message when a software update is available.

The availability of this function is dependent on the country.

### Depending on the source, you can perform various updates:

Source of the update	Update type
Updates via mobile phone	Navigation map, system updates, Digital Operator's Manual
Updates via an external storage medium, e.g. a USB flash drive	Navigation maps

- ⓘ Software updates via mobile phone require an active Internet connection for the vehicle. This is not available in all countries. For further information on connecting to the Internet, see (→ page 296).

### Advantages of software updates

Software updates ensure your vehicle's technology is up-to-date.

In order to constantly improve the quality of our services you will receive future software updates for your multimedia system, the Mercedes me connect services and your vehicle's communication module. These will be sent to you via the mobile phone connection in your vehicle and, as an option, installed automatically. You can monitor the status of your software updates on the Mercedes me Portal and find information about potential innovations.

Your advantages at a glance:

- Conveniently receive software updates via the mobile phone network
- Improves the quality and availability of Mercedes me connect services
- Keeps your multimedia system and communication module up-to-date

Further information about software updates can be found at <https://me.secure.mercedes-benz.com>

### Carrying out software updates

#### Requirements:

- There is an Internet connection (→ page 296).
- **For automatic software updates:** your vehicle has a permanently installed communication module.

Multimedia system:

↳ System » Software Update

#### Automatic software updates

- ▶ Activate  **Automatic Online Update.**  
The software updates will be downloaded and installed automatically.  
The current status of the software update is displayed.

#### Manual software updates

- ▶ Switch off  **Automatic Online Update.**
- ▶ Select a software update from the list and start the update.

### Activating a software update

- ▶ Restart the system.

#### Function of important system updates

Important system updates may be necessary for the security of your multimedia system's data. Please install these updates, otherwise the security of your multimedia system cannot be ensured.

- ⓘ If automatic online updates are activated, the system updates will be downloaded automatically (→ page 245).

As soon as a system update is available for download, a corresponding message appears on the media display.

You have the following selection options:

- **Download**  
The system update will be downloaded in the background.
- **Details**  
Information about the pending system update is displayed.
- **Later**

The system update can be downloaded manually at a later time (→ page 245).

You will be informed when the download is complete and the system update is ready for installation.

- ① Park the vehicle safely in a suitable location before starting the installation.

Requirements for the installation:

- The ignition is switched on.
- The engine is not running.
- Notes and warnings have been read and accepted.
- The parking brake is applied.

If all requirements are met, the system update is installed. The multimedia system cannot be operated during the installation and vehicle functions are restricted.

If errors should occur during the installation, the multimedia system automatically attempts to restore the previous version. If restoration of the previous version is not possible, a symbol appears on the multimedia system display. Con-

sult a qualified specialist workshop to resolve the problem.

### Reset function

**⚠ WARNING** Risk of accidents due to failure of multimedia display functions

While the multimedia system is being reset, its functions such as the rear view camera are not available.

- ▶ Only reset the multimedia system when the vehicle is stationary.

Multimedia system:

↪ System ▶▶ Reset

Personal data is deleted, for example:

- Station presets
- Connected mobile phones

- ▶ Select **Yes**.

If PIN protection is activated, a prompt appears asking if you also wish to restore this to the factory settings during a reset.

- ▶ Select **Yes**.
- ▶ Enter the current PIN.  
The PIN is reset.

or

- ▶ Select **No**.  
The current PIN stays the same after resetting.

- ① If you have forgotten your PIN, an authorized Mercedes-Benz Center can deactivate the PIN protection for you.

A prompt appears again asking whether you really wish to reset.

- ▶ Select **Yes**.  
The multimedia system is reset to the factory settings.



## Fit & Healthy

### ENERGIZING COMFORT

#### Overview of the ENERGIZING COMFORT program

##### Program overview

- **Refresh:** Can make targeted changes to the interior climate to refresh vehicle occupants. Cooling airflow and ionization purify the air. The vehicle interior is illuminated with cool colors and the seat is ventilated.
  - **Warmth:** Can increase the comfort level of the vehicle occupants. The vehicle's panel, seat and steering wheel heating provide cozy warmth. The air is purified using ionization and a pleasant fragrance is released. The vehicle interior is illuminated with warm lighting.
  - **Vitality:** Can counteract diminishing attentiveness in monotonous driving situations. Fast-paced music and a vitalizing massage provide invigorating stimulation for the vehicle occupants. The air is purified using ionization and a pleasant fragrance is released.
- The vehicle interior is illuminated with a stimulating hue and the seat is ventilated.
- **Enjoyment:** Can promote a positive mood in the vehicle occupants as well as mental and physical regeneration. Moderately fast music is played and a massage program is activated. The air is purified using ionization and a pleasant fragrance is released. The vehicle interior is illuminated with amicable lighting.
  - **Well being:** Can aid the physical and mental relaxation of vehicle occupants. A back massage combined with local warmth provide relaxation. The air is purified using ionization and a pleasant fragrance is released. The audio player plays selections of calming music and the vehicle interior is illuminated with pleasant lighting.
  - **Training:** Can counteract the onset of muscle tension, limbs falling asleep or stress with targeted relaxation or stimulation exercises. The exercises are demonstrated in short videos. The air is purified using ionization and a pleasant fragrance is released. The vehicle interior is illuminated with lighting appropriate to the exercise.
- ⓘ Please note that the available programs and the associated functions depend on your vehicle equipment. Depending on your equipment, fewer functions may be available.

#### Starting the ENERGIZING Comfort program

##### Requirements:

- The ignition is switched on.
- ⓘ ENERGIZING Comfort is available approximately five minutes after starting the multimedia system.

Multimedia system:

↳ Vehicle ▶ ENERGIZING Comfort

##### Selecting a seat

- ▶ Select **Seat Selection**.
- ▶ Select the desired seat or **All Seats** .

##### Starting a program

- ▶ Select **Refresh**, **Warmth**, **Vitality**, **Enjoyment** or **Well-being**.

The selected program will run for ten minutes.

### Configuring a program

- ▶ Call up further options  for the desired program.
- ▶ Switch the functions included in the program on  or off .

### Starting training

- ▶ Select **Training**.
  - ▶ Select **Muscle Relaxation**, **Muscle Stimulation** or **Balance**.  
The selected training video starts and is displayed in the media display.
  - ▶ Select **Full Screen: Video**.  
The training video is displayed in full screen.
- i** For more information on pausing or skipping through videos, see (→ page 304).

If, during an active program, a function requirement is no longer met, a corresponding message appears. The active program is canceled.

### Navigation

#### Switching navigation on

Multimedia system:

 **Navigation**

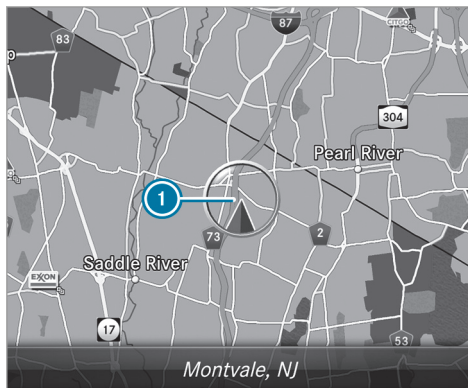

- ▶ Alternatively: press the **NAVI** button.  
The map appears and shows current vehicle position **1**.

- i** If a climate control setting is changed, a climate bar appears briefly.

#### Showing/hiding the navigation menu

##### Requirements:

- The map shows the vehicle's current position.

Multimedia system:

→ Navigation

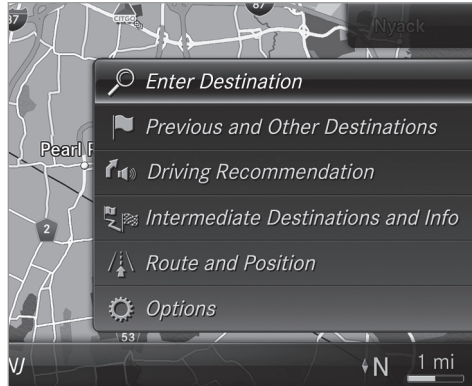

▶ **To show:** swipe left on the touchpad or the Touch Control.

or

▶ Slide the controller to the left.

▶ **To hide:** swipe right on the touchpad or the Touch Control.

or

▶ Slide the controller to the right.

ⓘ To show or hide lower menu levels, swipe or slide to the left or right as many times as necessary.

### Destination entry

#### Entering a POI or address

**⚠ WARNING** Risk of distraction from information systems and communications equipment

If you operate information and communication equipment integrated in the vehicle when driving, you will be distracted from the traffic situation. This could also cause you to lose control of the vehicle.

- ▶ Only operate this equipment when the traffic situation permits.
- ▶ If you cannot be sure of this, stop the vehicle whilst paying attention to road

and traffic conditions and operate the equipment with the vehicle stationary.

You must observe the legal requirements for the country in which you are currently driving when operating the multimedia system.

#### Requirements:

- **For the online search:** Mercedes me connect is available.
- You have a user account for the Mercedes me Portal.
- The service is available.
- The service has been activated at an authorized Mercedes-Benz Center.

Further information can be found at: <https://www.mercedes.me>

Multimedia system:

→ Navigation

▶ Show the navigation menu.

▶ Select  **Enter Destination** .

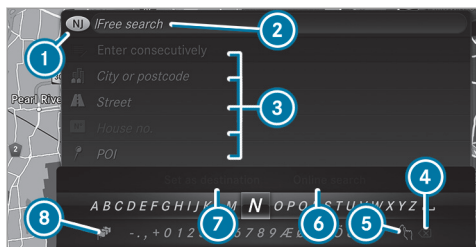

The state or province in which the vehicle is located is set ①.

There are two available methods of destination entry:

- Free search ②
- Search step-by-step ③

#### Method 1: free search

- ▶ Enter the POI or address in ②. The entries can be made in any order. During destination entry, suggestions are made by the multimedia system. A selection of destinations appears in a list.

Enter these address elements, for example:

- City, street, house number
- Street, city
- ZIP code
- POI name
- POI category, e.g. [Gas Station](#)
- City, POI name

- ▶ **To switch to handwriting recognition:** select ⑤.

- ▶ Write the character on the touchpad.

- ▶ **To switch to character selection:** press the button.

or

- ▶ Press the touchpad.

- ▶ **To delete an entry:** select ④ (if available).

Use the following options:

- Press briefly: deletes the last character entered or the last suggestion adopted.
- Press and hold: deletes the entire entry.

- ▶ **To set the language:** select ⑧.

- ▶ Select the language.

- ① This function is useful for countries in which several character sets are supported. An example is Russia, which uses Cyrillic and Latin characters.

- ▶ **To call up the online search function:** select [Online Search](#) ⑥.

Once an Internet connection is established, a list appears. It shows online destinations related to the previous entry.

The online destination is supplied by an Internet provider.

- ▶ Select the online destination.

or

- ▶ Enter the online destination or a 3 word address in the input line.

- ① Enter a 3 word address (→ page 254). Online search is not available in all countries.

- ▶ **To call up the list:** press the button.

or

- ▶ If the top line of the character bar is highlighted, navigate upwards.
- ▶ Select the destination in the list.
- ▶ **To adopt a destination:** select  **Select Destination** .  
If there are several listings for a destination, a list appears.
- ▶ Select the destination.  
The destination address is shown.

#### Method 2: search step-by-step

- ▶ Press  button.  
or
- ▶ If the top line of the character bar is highlighted, navigate upwards.  
The character bar is hidden. **City or ZIP** is highlighted. Additional entry fields, e.g. for **POI**, are available.
- ▶ Select **City or ZIP**.  
The character bar appears.
- ▶ Enter the city or the ZIP code.  
During destination entry, suggestions are made by the multimedia system. A selection of destinations appears in a list.

The address entries can be made in any order, for example:

- **City or ZIP, Street, House No.**  
Enter an intersecting street, if available.
- **Street, City or ZIP**
- **POI**, e.g. **Gas Station, City or ZIP**

 During destination entry, use the following functions:

- Switch to handwriting recognition.
- Switch to character selection.
- Delete an entry.

An entry, e.g. **POI**, can be deleted with  in a step-by-step search. Navigate to the left to do so.

- Call up the online search function (if available).
- Call up a list.



The functions are described in the free search.

- ▶ **To change the state/province:** select the state or the province.

- ▶ Enter the state or the province. You only need to enter the first character.
- ▶ Select the state or the province in the list.
- ▶ **To change the country:** select the country.
- ▶ Enter the country. You only need to enter the first character.
- ▶ Select the country on the list.
- ▶ **To adopt a destination:** select **Select Destination**.  
If there are several listings for a destination, a distance-orientated list appears.
- ▶ Select the destination.  
The destination address is shown.

#### Selecting previous destinations

Multimedia system:

- ▶  **Navigation**
- ▶  **Previous and Other Destinations**
- ▶ Select **Previous Destinations**.
- ▶ Select the destination.  
The destination address is shown.

or

- ▶ If favourites have been saved already (→ page 264), select [From My Favorites](#).
- ▶ Select the favourite.  
The destination address is shown.

### Selecting a POI

Multimedia system:

↳ [Navigation](#)

▶ [Previous and Other Destinations](#)

▶ [POIs](#)

- ▶ Select the category.

or

- ▶ Select [All Categories](#) and the category.

**If route guidance is not active:** the search begins in the vicinity of the current vehicle position. The list is sorted by distance in ascending order.

The POIs show the following information:

- Name of POI
- Linear distance to the POI
- The direction of the linear distance to the POI (arrow) is displayed when searching for the vehicle's current position

- ▶ Select the POI.
- ▶ **Route guidance is active:** select the search position prior to choosing a POI (see example).
- ▶ If intermediate destinations are set, these can also be selected as the search position after selecting [Near Destination](#).

### Filtering displays for POIs

- ▶ Enter the search term in  [Search:](#).  
The results list shows relevant POIs.
- ▶ Select  [ok](#).  
The first POI in the list is highlighted.
- ▶ Select the POI.

### Example: setting the search position for the parking category during active route guidance

- ▶ Select [In the Vicinity, Near Destination or Along the Route](#).  
The list shows the located POIs or opens an overview of the route destination after selecting [Near Destination](#).
- ▶ Select the POI.

- ▶ Select [Near Destination](#): select the intermediate destination or the destination.

### Starting an automatic gas station search

#### Requirements:

- The automatic gas station search is activated  (→ page 258).

#### Driving situation

Route guidance is active. The fuel level in the fuel tank reaches the reserve fuel level.

The [Reserve Fuel Do you want to start a search for surrounding gas stations?](#) message is shown.

- ▶ Select [Yes](#).  
The automatic gas station search begins. The available gas stations along the route or in the vicinity of the vehicle's current position are displayed.
- ▶ Select the gas station.  
The address of the gas station is displayed.
- ▶ If route guidance is not active, select [Start Route Guidance](#).  
The selected gas station is set as the destination. Route guidance begins.

or

- ▶ If route guidance is active, select **Start New Route Guidance** or **Set as Next Way Point**.  
**Start New Route Guidance:** the selected gas station is set as a new destination. The previous destinations and intermediate destinations are deleted. Route guidance to the gas station begins.

**Set as Next Way Point:** the selected gas station is set as the next intermediate destination. Route guidance begins.

- ▶ **If there are already four intermediate destinations:** select **Yes** in the prompt. The selected gas station is entered into position 1 of the intermediate destinations menu. Intermediate destination 4 is deleted. Route guidance begins.

### Entering an intermediate destination

#### Requirements:

- A destination is entered.

Multimedia system:

→ **Navigation** ▶ **Way Points and Info**

- ▶ Select **Search for Way Point**.
- ▶ Enter the intermediate destination as a POI or address (→ page 249).
- ▶ Select the intermediate destination.
- ▶ Select **Set as Destination**.

or

- ▶ Select an intermediate destination using  **Enter Destination** during route guidance.
- ▶ Select **Set as Next Way Point** after entering the destination.

### Editing intermediate destinations



#### Requirements:

- The destination and at least one intermediate destination have been entered.

Multimedia system:

→ **Navigation** ▶ **Way Points and Info**

- ▶ **To call up the map:** highlight the destination or the intermediate destination.

- ▶ Select  **Map**.
- ▶ Move the map (→ page 268).
- ▶ Select destination on the map (→ page 255).
- ▶ **To change the order of destinations:** highlight the destination or the intermediate destination.
- ▶ Select  **Move**.
- ▶ Move the intermediate destination to the desired position.
- ▶ Press the Touch Control, the controller or the touchpad.
- ▶ **To delete a destination:** highlight the destination or the intermediate destination.
- ▶ Select  **Delete**.

### Calculating a route with intermediate destinations

#### Requirements:

- The destination and at least one intermediate destination have been entered.

Multimedia system:

↳ [Navigation](#) ▶▶ [Way Points and Info](#)

- ▶ Select [Start New Route Guidance](#).  
The route is calculated with the set intermediate destinations.

### Selecting a contact for destination entry

#### Requirements:

- A mobile phone is connected to the multimedia system (→ page 275).
- The "Navigate to contact" online service is available and activated.

Multimedia system:

↳ [Navigation](#)

▶▶ [Previous and Other Destinations](#)

▶▶ [Contacts](#)

- ▶ Select the contact.  
The contact details are displayed.
- ▶ Select the address.  
The [Please Wait...](#) message appears. The search is carried out online.
- ▶ Select the destination.

### Filtering displays for contacts

- ▶ Enter a name or telephone number, for example, into the search field.
- ▶ Select [OK](#).  
The first contact in the list is highlighted.
- ▶ Select the contact.
- ▶ Select the address.

### Entering geo-coordinates

Multimedia system:

↳ [Navigation](#)

▶▶ [Previous and Other Destinations](#)

▶▶ [Geo-coordinates](#)

- ▶ Enter geo-coordinates as latitude and longitude coordinates in degrees, minutes and seconds.  
The map shows the position.
- ▶ Confirm the entry.
- ▶ **To calculate a route:** select [Start Route Guidance](#).
- ▶ If a route has already been created, select [Start New Route Guidance](#) or [Set as Way Point](#).

### Entering the destination as a 3 word address

#### Requirements:

- Searching for a destination using 3 word addresses is possible in the online search (→ page 249).
  - There is an Internet connection.
- ⓘ Searching for a destination using 3 word addresses is not possible in all countries.

Multimedia system:

↳ [Navigation](#) ▶▶ [Enter Destination](#)

- ▶ Select [Online Search](#).
- ▶ Enter the destination address as a 3 word address. Separate each of the words with a full stop.  
The search results are displayed.
- ▶ Select the destination in the list.  
The destination address is shown. The route can be calculated.



**i** 3 word addresses from what3words are an alternative addressing system for multilingual georeferencing of global locations with a resolution of three meters. Using this grid, locations on the Earth's surface are included which do not have a building address such as a street and house number, for example. The Empire State Building has this language dependent 3 word address:

- English: **parade.help.bleat**
- French: **commun.verbe.bisquer**
- Spanish: **suertes.diga.pesca**

3 word addresses are unique, easy to remember and suffice for most routine applications.

You can convert addresses to 3 word addresses and back again:

- At the website <https://what3words.com>
- In the what3words apps

### Selecting a destination on the map

Multimedia system:

→ **Navigation** →  **Options**

▶ Select **Map Menu**.

or

▶ If the map is displayed in full screen mode, press the central control element.

The map menu appears.

▶ Select "move map" in map menu **2** (→ page 267).

▶ Swipe in any direction on the Touch Control or touchpad.

or

▶ Slide the controller in any direction.

The map moves in the corresponding direction under the crosshair. The more you move your finger away from the starting position on the touchpad, the faster the map moves.

▶ Press the Touch Control, the controller or the touchpad.

If several destinations are located around the crosshair, a list shows the available POIs and roads.

If a destination is located exactly on the crosshair, the destination address is displayed.

▶ Select the destination in the list. The destination address is shown.

### Setting the map orientation to 2D or 3D

▶ Highlight **Map Orientation: 2D/3D**.

▶ Press the Touch Control, the touchpad or the controller.

The map will be displayed in the selected map orientation.

### Showing traffic messages in the vicinity of the map

▶ Select **Traffic Messages for the Vicinity**. The map appears.

▶ Swipe left or right on the touchpad.

or

▶ Slide the controller to the left or right. The previous or next traffic incident is highlighted on the map. Information on the traffic incident is displayed.

- ❗ Traffic reports are not available in all countries.

### Showing POIs in the vicinity of the map

- ▶ Select [POIs in the Vicinity](#).
  - ▶ Swipe left or right on the touchpad.
- or
- ▶ Slide the controller to the left or right. The previous or next POI is highlighted on the map. The name or the address is shown.
  - ▶ **To filter the display by POI category:** swipe down on the Touch Control or the touchpad.
- or
- ▶ Slide the controller down.
  - ▶ Select the POI category.
- ❗ [User Defined](#) allows personal POI symbols to be selected (→ page 269).

## Route

### Calculating a route





#### Requirements:

- The destination has been entered.
  - The destination address is shown.
- ▶ If route guidance is not active, select [Start Route Guidance](#). The route to the destination is calculated. The map shows the route. Route guidance then begins.
- or
- ▶ If route guidance is active, select [Start New Route Guidance](#) or [Set as Next Way Point](#). [Start New Route Guidance](#): the selected destination address is set as a new destination. The previous destinations and intermediate destinations are deleted. Route guidance to the new destination begins. [Set as Next Way Point](#): the selected destination address is set as the next intermediate destination. Route guidance begins.

### Taking alternative routes into consideration

- ▶ Select an alternative route (→ page 258).

### Other menu functions

- ▶ **To save the destination:** select  [Store in "Previous Destinations"](#).
- ▶ **To display on the map:** select  [Map](#).
- ▶ **To call a telephone number:** select  [Call](#) (if available).
- ▶ **To call up an Internet address:** select  [www](#) (if available).

### Selecting a route type

Multimedia system:

↳ [Navigation](#) ▶  [Route and Position](#)

- ▶ Select [Route Settings](#).
- ▶ Select the route type. If route guidance is active, the new route is calculated with the new route type. If route guidance is not active, the next route is calculated with the new route type.

You can choose from the following route types:

- [Eco Route](#)

An economical route is calculated. The journey time may be somewhat longer than for quicker routes.

The symbol for the current vehicle position is displayed in green.

- **Fast Route**

A route with a quick journey time is calculated.

- **Short Route**

A route with a short driving distance is calculated.

**Automatic Traffic Jam Avoidance** can be switched on  or off  for these route types. If **Automatic Traffic Jam Avoidance** is switched on, **Ask in the Event of Traffic Jam Avoidance** can be selected.

The **Automatic Traffic Jam Avoidance** and **Ask in the Event of Traffic Jam Avoidance** settings are not available in every country.

The settings enable the following:

- **Automatic Traffic Jam Avoidance**

The route is calculated with the currently set route type.

Traffic reports via Live Traffic Information are taken into account.

Live Traffic Information is not available in all countries.

- **Ask in the Event of Traffic Jam Avoidance**

A prompt appears when a new route is detected with a shorter journey time based on traffic reports. You can continue to use the current route or use the dynamic route instead.

### Selecting route options

Multimedia system:

- ↳ **Navigation** ▶  **Route and Position**
- ▶▶ **Avoid Options**

### Avoiding areas

- ▶ Select **Areas** (→ page 270).

### Avoiding highways, ferries, motorail trains, tunnels, unpaved roads

- ▶ Select  or deselect  avoid option.

### Using toll roads

- ▶ Select **Use Toll Roads**.
- ▶ Select **Cash** or **Electronic Billing** or **Off**. The route takes into account roads that require the payment of a usage fee (toll). If **Off** is selected, toll roads are not taken into account.

The selected route options cannot always be implemented. Therefore, a route may include a ferry, for instance, even though the avoid **Ferries** option is enabled. A message appears and you will hear a corresponding message.

### Using carpool lanes

- ▶ Select **Number of Occupants in the Vehicle**.
- ▶ Select number. When using carpool lanes, observe the applicable legal requirements as well as any conditions pertaining to when and where such lanes may be used. Carpool lanes may only be used if certain conditions are met.

These route options are not available in every country.

### Selecting notifications for the route

Multimedia system:

Navigation ► Options

► Announcements

► Switch an announcement on  or off .

You can choose from the following announcements:

- **Announce Traffic Warnings**

This function is not available in all countries.

- **Announce Street Names**

The multimedia system announces the names of the roads that will follow the upcoming change of direction.

This function is not available in all countries and languages.

### Displaying destination information

#### Requirements:

- A destination is entered.

Multimedia system:

Navigation

► Select **Way Points and Info.**

The following information is displayed:

- Intermediate destinations and destination  
The route can also include up to four intermediate destinations.
- Name, address
- Remaining driving distance
- Time of arrival

### Selecting an alternative route

Multimedia system:

Navigation ► Route and Position

► Select **Alternative Route.**

The routes are displayed in accordance with the setting made in the route settings.

The currently selected route is shown with a dark blue line.

► Select the alternative route.

### Switching the automatic gas station search on or off

Multimedia system:

Navigation ► Options

► Switch **Reserve Fuel** on  or off .

Switched on : when the fuel reserve level is reached, a prompt appears asking whether you want to start searching for gas stations.

### Using automatic gas station search

#### Requirements:

The automatic gas station search is activated  (→ page 258).

The prompt **Reserve Fuel Do you want to start a search for surrounding gas stations?** appears.

► Select **Yes.**

The automatic gas station search begins. The available gas stations along the route or in the vicinity are displayed.

► Select the gas station.

► When there is no route, the gas station is set as the destination.

or

- ▶ When there is a route, the gas station is set as the next intermediate destination.

### Starting the automatic service station search

#### Requirements:

- ATTENTION ASSIST and the [Suggest Rest Area](#) function are activated (→ page 162).

#### Driving situation

The [ATTENTION ASSIST Do you want to search for a rest area?](#) message is shown.

- ▶ Select [Yes](#).  
The service station search starts. The available service stations along the route or in the vicinity of the vehicle's current position are displayed.
- ▶ Select the service station.  
The service station address is displayed.
- ▶ If route guidance is not active, select [Start Route Guidance](#).  
The selected service station is set as a destination. Route guidance begins.

or

- ▶ If route guidance is active, select [Start New Route Guidance](#) or [Set as Next Way Point](#).  
**Start New Route Guidance:** the selected service station is set as a new destination. The previous destination and all intermediate destinations are deleted. Route guidance to the service station begins.

**Set as Next Way Point:** the selected service station is set as the next intermediate destination. Route guidance begins.

### Route guidance

#### Notes on route guidance

**⚠ WARNING** Risk of distraction from operating integrated communication equipment while the vehicle is in motion

If you operate communication equipment integrated in the vehicle when driving, you will be distracted from the traffic situation. This could also cause you to lose control of the vehicle.

- ▶ Only operate this equipment when the traffic situation permits.
- ▶ If you cannot be sure of this, stop the vehicle whilst paying attention to road and traffic conditions and operate the equipment with the vehicle stationary.

You must observe the legal requirements for the country in which you are currently driving when operating the multimedia system.

Route guidance begins once a route has been calculated.

The road and traffic rules and regulations always have priority over multimedia system driving instructions.

The following driving instructions can be used:

- Navigation announcements
- Route guidance displays
- Lane recommendations

If you do not follow the driving instructions or if you leave the calculated route, a new route is calculated automatically.

Driving instructions may differ from the actual road and traffic conditions if:

- The route is diverted
- The direction of a one-way street has been changed

For this reason, you must always observe road and traffic rules and regulations during your journey as well as the prevailing traffic conditions.

The route may differ from the ideal route due to the following:

- Roadworks
- Incomplete digital map data

#### Notes on GPS reception

The correct function of the navigation system depends amongst other things on GPS reception. In certain situations GPS reception can be impaired, defective or even not possible, e.g. in tunnels or in parking garages.

#### Changing direction overview

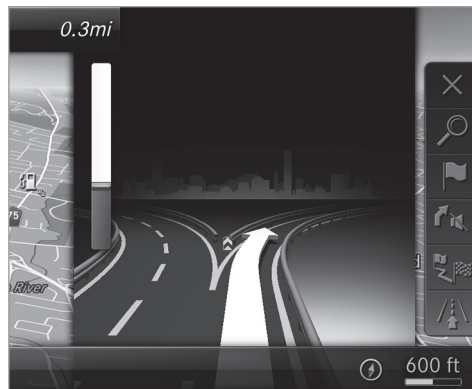

There are three phases when changing direction:

- Preparation phase

If there is enough time between the changes of direction, the multimedia system prepares you for the upcoming change of direction. A navigation announcement is issued, e.g. "Prepare to turn right".

The map appears in full-screen mode.

- Announcement phase

The multimedia system announces the upcoming change of direction, e.g. by announcing "Turn right in 300 ft (100 m)".

The display is split into two parts. The map is displayed on the left; on the right, there is a detailed image of the intersection or a 3D image of the upcoming change of direction.

- Change-of-direction phase

The multimedia system announces the imminent change of direction, e.g. by announcing "Now turn right".

The display is split into two parts.

The vehicle has successfully changed direction when the light-color bar on the right drops down to 0 feet (0 m) and the current vehicle position symbol has reached the highlighted change-of-direction point.

When the change of direction is complete, the map appears in full-screen mode.

- Changes of direction are also shown in the Instrument Display.

### Lane recommendations overview

This display appears for multi-lane roads.

If the digital map contains the relevant data, the multimedia system can display lane recommendations for the next two changes of direction.

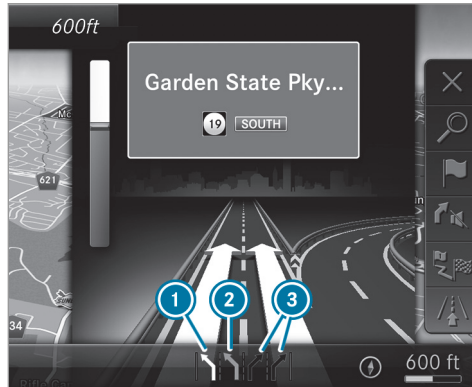

- ① Recommended lane
- ② Possible lane
- ③ Lanes not recommended

The following lanes are displayed:

- Recommended lane ①  
In this lane, you will be able to complete both the next change of direction and the one after that.
- Possible lane ②  
In this lane, you will only be able to complete the next change of direction.
- Lane not recommended ③  
In this lane, you will not be able to complete the next change of direction without changing lane.

During the change of direction, new lanes may be added.

- ① Lane recommendations can also be displayed in the Instrument Display and in the Head-up Display.

### Overview of destination reached

Once the destination is reached, you will see the  checked flag. Route guidance is finished.

When an intermediate destination has been reached, you will see the intermediate destina-

tion flag with the number of your  intermediate destination. After this, route guidance is continued.

### Switching navigation announcements on/off

#### Requirements:

- Route guidance is active.

▶ **To switch off:** press the volume control on the multifunction steering wheel during a navigation announcement (→ page 232).



or

▶ Press the volume control on the center console during a navigation announcement (→ page 232).

The **Voice Guidance has been deactivated.** message appears.

or

▶ Show the navigation menu (→ page 248).

▶ Select  **Voice Guidance** .  
The symbol changes to .

▶ **To activate:** select  **Voice Guidance** .  
The current navigation announcement is played.

- ❶ In the following situations, navigation announcements are switched on automatically:
  - A new route guidance is started.
  - The route is recalculated.
- ❷ You can add and call up this function as a favorite under [Voice Guidance On/Off](#).

### Switching navigation announcements on/off during a phone call

- ▶ Select [System](#).
- ▶ Select  [Audio](#).
- ▶ Select [Navigation and Traffic Announcements](#).
- ▶ Switch [Voice Guidance During Call](#) on  or off .



### Adjusting the volume of navigation announcements

#### Requirements:

- Route guidance is active.
- ▶ **On the multifunction steering wheel or on the multimedia system:** turn the volume

control on the multifunction steering wheel during a navigation announcement.

or

- ▶ Turn the volume control on the center console during a navigation announcement (→ page 233).
- ❶ In the following situations, the volume is raised to the maximum volume or lowered to the minimum volume:
  - A new route guidance is started.
  - The route is recalculated.
- ❷ The minimum volume can be individually set at an authorized Mercedes-Benz Center.
- ▶ **Via system settings:** select [System](#).
- ▶ Select  [Audio](#).
- ▶ Select [Navigation and Traffic Announcements](#).
- ▶ Select [Voice Guidance Volume](#).
- ▶ Set the volume.
- ▶ **To switch audio fadeout on/off during navigation announcements:** select [System](#).
- ▶ Select  [Audio](#).

- ▶ Select [Navigation and Traffic Announcements](#).
- ▶ Switch [Audio Fadeout During Voice Guidance](#) on  or off .



### Repeating navigation announcements

#### Requirements:

- A route has already been created.
- Route guidance is active.

Multimedia system:

↳ [Navigation](#)

- ▶ Select  [Voice Guidance](#).
- ▶ Select  [Voice Guidance](#).  
The current navigation announcement is repeated.
- ❶ You can add and call up this function as a favorite under [Repeat Voice Guidance](#).

### Canceling route guidance

#### Requirements:

- A route has already been created.
- Route guidance is active.



Multimedia system:

↳ Navigation

▶ Select  Cancel Route Guidance.

### Overview of route guidance to an off-road destination

An off-road destination is within the digital map. The map contains no roads that lead to the destination.

You can enter geo-coordinates or a three word address for off-road destinations on the map. Route guidance guides you for as long as possible with navigation announcements and displays on roads that are known to the multimedia system.

Shortly before you reach the last known position on the map, you will hear the "Please follow the direction arrow" announcement. The display shows a direction arrow and the linear distance to the destination.

### Overview of route guidance from an off-road location to a destination

Off-road position: the current vehicle position is located within the digital map on roads that are not available.

When route guidance begins the following displays appear:

- The **Road Not Mapped** message is shown.
- A direction arrow showing the linear direction to the POI.

When the vehicle is back on a road known to the multimedia system, route guidance continues as normal.

### Overview of off-road status during route guidance

Due to roadworks, for example, there may be differences between the data on the digital map and the actual course of the road. In such cases, the multimedia system will temporarily be unable to locate the vehicle's current position on the digital map. The vehicle is off-road.

If the vehicle is displayed as being offroad, the following displays appear:

- The **Road Not Mapped** message
- A direction arrow showing the linear direction to the POI

When the vehicle is back on a road known to the multimedia system, route guidance continues as normal.

## Destination

### Saving the current vehicle position

Multimedia system:

↳ Navigation

- ▶ If the map is displayed in full screen mode, press the central control element. The map menu appears.
- ▶ Select **1** on the map menu (→ page 267). The current vehicle position is saved to the "Previous destinations" memory.

### Storing a map position

Multimedia system:

#### Navigation

The map is in full-screen mode.





- ▶ Press the Touch Control, the controller or the touchpad.
- ▶ Select "move map" in map menu ② (→ page 267).
- ▶ Select a position on the map. If multiple entries are available for a map position, a list appears.
- ▶ Highlight an entry.
- ▶ Select  **Save My Favorite** .  
The map position is saved to the "Previous destinations" memory.

### Managing the previous destinations

Multimedia system:

#### Navigation

- ▶▶  **Previous and Other Destinations**
- ▶▶ **Previous Destinations**
- ▶ Highlight one of the previous destinations.

- ▶ **To save as a favorite:** select  **Save My Favorite** .  
The favorites are displayed.
- ▶ Move the favorite to the desired position. If a favorite has already been added at this position, it will be overwritten.
- ▶ **To save as "Home" address:** select  **Save as "Home"** .
- ▶ **To save as "Work" address:** select  **Save as "Work"** .
- ▶ **To delete a single or all destinations:** select  **Delete** or **Delete All** .  
A prompt appears.
- ▶ Select **Yes** .
- ▶ **To display destination information:** select  **Details** .

### Using external destinations

External destinations can be received from the following sources:

- Mercedes-Benz Apps
- Door-to-door navigation with Companion app (USA)

- ① Received destinations are saved in the previous destinations.

A prompt appears on the media display.

- ▶ **A destination has been received without picture information:** select **Yes** .
- ▶ If route guidance is not active, select **Start Route Guidance** .  
The route to the destination is calculated. The map shows the route. Route guidance then begins.

or

- ▶ If route guidance is active, select **Start New Route Guidance** or **Set as Next Way Point** .  
**Start New Route Guidance:** the received destination address is set as a new destination. The previous destinations and intermediate destinations are deleted. Route guidance to the new destination begins.  
**Set as Next Way Point:** the received destination address is set as the next intermediate destination. Route guidance begins.

- ▶ **A destination has been received with picture information:** select [Start Route Guidance](#).  
Route guidance starts.

### [Route guidance with current traffic reports](#)

#### Traffic information overview

Traffic reports are received using Live Traffic Information and are used for route guidance. This service is unavailable in some countries.

There may be differences between the traffic reports received and the actual road and traffic conditions.

Important information on Live Traffic Information:

- Current traffic reports are received via the Internet connection.
- The traffic situation is updated at short, regular intervals.
- The subscription information shows the status (→ page 265).

Information on the vehicle's position is regularly sent to Mercedes-Benz AG. The data is immediately rendered anonymous by Mercedes-Benz AG and forwarded to the traffic data provider. Using this data, traffic reports relevant to the vehicle's position are sent to the vehicle. The vehicle acts as a sensor for the flow of traffic and helps to improve the quality of the traffic reports.

If you do not wish to transmit your vehicle position, you can have this service deactivated at an authorized Mercedes-Benz Center.

#### Displaying subscription information

##### Requirements:

- The vehicle is equipped with Live Traffic Information.

Multimedia system:

↳ [Navigation](#) ▶  [Options](#)

The subscription expiration date is automatically displayed:

- one month before the expiration date.
- one week before the expiration date.
- on the expiration date.

- ▶ **To display manually:** select [Live Traffic Subscription Info](#).

Depending on the status, one of the following messages appears:

- the period of validity for the subscription is displayed.
- the subscription has expired.
- ① The subscription can be extended:
  - At an authorized Mercedes-Benz Center
  - Via an MB Info call to the Mercedes-Benz Customer Assistance Center

#### Displaying the traffic map

##### Requirements:

- For Live Traffic Information: the vehicle is equipped with a communication module featuring an activated, integrated SIM card.
- When the vehicle is started, the communication module automatically establishes an Internet connection. Traffic information is made available shortly afterwards.

Multimedia system:

→ [Navigation](#) ▶  [Options](#)  
▶ [Map Menu](#)

▶ Alternatively: if the map is displayed in full screen mode, press the Touch Control, the controller or the touchpad. The map menu appears.

▶ Activate  .

The traffic map shows the following information, for example:

- Traffic incidents, for example:
  - Roadworks
  - Road blocks
  - Warning messages

The symbols for traffic incidents are displayed in color (on the route) or gray (off the route).

- Traffic flow information:
  - Traffic jam (red line)
  - Slow-moving traffic (orange line)
  - Heavy traffic (yellow line)

- Free-flowing traffic (green line)
- Display for traffic delays on the route lasting at least one minute
- Warning message symbols:
  - Symbol 
  - Additional road safety notes when approaching a traffic incident, e.g. the end of a traffic jam

If the vehicle approaches a danger area on the route, a warning message is displayed on the map. A warning message may also be issued (→ page 267).

### Displaying traffic incidents

Multimedia system:

→ [Navigation](#) ▶  [Options](#)  
▶ [Map Content](#)

▶ Activate [Traffic Incidents](#) .  
Roadworks, road blocks, local area reports (e.g. fog) and warning messages are displayed.

### Activating free flow and traffic display

▶ Activate [Free Flowing Traffic](#) and [Traffic Delays](#) .

 The traffic delay is displayed for the current route. Traffic delays lasting one minute or longer are taken into consideration.

### Displaying details

▶ Displaying the traffic map (→ page 265).  
▶ Move the map (→ page 268).  
▶ When a traffic report symbol is under the crosshair, press on the central control element. The traffic report details are displayed.

or

▶ Press on the central control element.  
▶ Select [Information on Traffic Reports](#). The map shows the traffic report symbols in the vicinity.

Traffic report information is displayed in the status line:

- Traffic report symbol

- Reason for the traffic report, e.g. traffic congestion
  - Warning message (highlighted in red)
- ▶ **To select a traffic report symbol:** select **Next** or **Previous**.
- ▶ Press on the central control element. The traffic report details are displayed.

### Issuing hazard warnings

Multimedia system:

- ▶ **Navigation** ▶  **Options**
- ▶ **Announcements**

- ▶ Activate  **Announce Traffic Warnings**. Warning messages are issued and tailbacks which pose a risk are announced.

### Map and compass

#### Map and compass overview

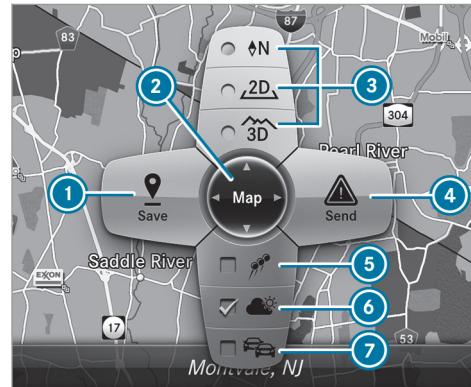

- Saves the current vehicle position
- Moves the map
- Selects the map orientation and map view
- Selects the function depending on the equipment:
  - Sends a hazard warning via Car-to-X.

- Filters the display of POIs in the vicinity according to POI category
- Switches the display of personal POI symbols on the map on or off
  - Switches one of the following displays on or off depending on the equipment:
    - Weather information
    - Satellite map
    - Traffic incidents
  - Switches the traffic map display on or off

The map and satellite images are shown in globe projection. This allows for a realistic map display in all map scales. The map uses elevation modeling.

Depending on the map data, important buildings in many cities are depicted realistically on the map in small map scales (e.g. 1/32 mi (20 m), 1/16 mi (50 m)). Other buildings are shown as models.

- i** You can set the unit of measurement of the map scale (→ page 241).

If available, online information is displayed, e.g. parking garage occupancy.

**i** Requirements:

- Mercedes me connect is available.
- You have a user account for the Mercedes me Portal.
- The service has been activated at an authorized Mercedes-Benz Center.

Further information can be found at:  
<https://www.mercedes.me>

**i** The online information is not available in all countries.

If **Display in COMAND** is activated in Traffic Sign Assist (→ page 181), speed limits and overtaking restrictions are displayed on the map.

**i** Company logos displayed on the map are trademarks of the respective companies and used solely for the purpose of indicating the locations of these companies. The use of such logos on the map does not indicate approval of, support of or advertising by these companies for the navigation system itself.

### Setting the map scale

**Requirements:**

- The map is shown.

Multimedia system:

→ [Navigation](#)

▶ **To zoom in:** swipe down on the Touch Control.

or

▶ Turn the controller counter-clockwise.

or

▶ Move two fingers apart on the touchpad.

▶ **To zoom out:** swipe up on the Touch Control.

or

▶ Turn the controller clockwise.

or

▶ Move two fingers together on the touchpad.

### Moving the map

Multimedia system:

→ [Navigation](#) ▶  [Options](#)

▶ [Map Menu](#)

▶ Alternatively, if the map is displayed in full screen mode, press the central control element.

The map menu appears.

▶ Select "Move map" in map menu  (→ page 267).

▶ Swipe in any direction on the Touch Control or touchpad.

or

▶ Slide the controller in any direction.

The map moves in the corresponding direction under the crosshair. The further you move your finger away from the starting position on the touchpad, the faster the map moves.

### Selecting the map orientation

Multimedia system:

Navigation  Options  
 ▶▶ Map Menu

- ▶ Alternatively, if the map is displayed in full screen mode, press the central control element. The map menu appears.
- ▶ In map menu , select **N**, **2D** or **3D** (→ page 267).
  - **N**: the 2D map view is displayed so that north is always at the top.
  - **2D**: the 2D map view is aligned to the direction of travel.
  - **3D**: the 3D map view is aligned to the direction of travel.

### Selecting POI symbols

Multimedia system:

Navigation  Options  
 ▶▶ Map Content

POIs include gas stations and hotels which can be displayed as symbols on the map, for example. Not all POIs are available everywhere.

- ▶ Select **POI Symbols**. The • dot indicates the current setting. **Standard** displays symbols of predefined categories on the map. **User Defined** allows you to personally select the symbols for the available categories. **None** switches the display off.
- ▶ Select a setting.
- ▶ **User Defined**: select categories. The POI symbols of the selected categories are displayed  or not displayed .

### Selecting the display of text information in the map

Multimedia system:

Navigation  Options  
 ▶▶ Text Information

- ▶ Select text information. **Current Street** shows the street you are currently driving on at the bottom of the display. When the map is moved, the following information appears under the crosshair:
  - Street name

- POI name
- Area name

**Geo-coordinates** displays the following information:

- Longitude and latitude
- Elevation  
The elevation shown may deviate from the actual elevation.
- Number of satellites from which a signal can be received  
When the map is moved, this information does not appear.

**Climate Control** displays the current climate control settings.

**None** switches the display off.

### Displaying the next intersecting street

#### Requirements:

- Route guidance is not active.

Multimedia system:

↳ [Navigation](#) ▶▶  [Options](#)

- ▶ Activate  [Next Intersecting Street](#).  
The name of the next intersecting street will be displayed at the upper edge of the display.

### Displaying the map version

Multimedia system:

↳ [Navigation](#) ▶▶  [Options](#)

- ▶ Select [Map Version](#).
- ▶ Select [Details](#).
- ① Information about new versions of the digital map can be obtained from an authorized Mercedes-Benz Center.

### Overview of avoiding an area

You can define areas along a route that you would like to avoid.

The route can include an area that is to be avoided in the following situations:

- the destination is located in an area that is to be avoided
- if freeways are located within the area that is to be avoided

Freeways are always taken into account for the route.

- there is no sensible alternative route

### Avoiding a new area

Multimedia system:

↳ [Navigation](#) ▶▶  [Route and Position](#)  
▶▶ [Avoid Options](#) ▶▶ [Areas](#)

- ▶ Select [Avoid New Area](#).
- ▶ **To search for an area via the map:** select [Using Map](#).
- ▶ Move the map.

or

- ▶ **To search for an area using an address:** select [Address Entry](#).
- ▶ Enter the address.
- ▶ Select [Select Destination](#).  
The map appears.
- ▶ **To display an area:** press the Touch Control, the touchpad or the controller.  
A red rectangle appears. This designates the area that should be avoided.

- ▶ **To change the size of the area:** swipe up or down on the Touch Control or the touchpad.

or

- ▶ Slide the controller up or down.  
The map scale is enlarged or reduced and changes the size of the area.
- ▶ **To set the area:** press the Touch Control, the touchpad or the controller.  
The area is entered into the list.

### Changing an area

Multimedia system:

↳ [Navigation](#) ▶▶  [Route and Position](#)  
▶▶ [Avoid Options](#) ▶▶ [Areas](#)

- ▶ Highlight an area in the list.
- ▶ Select  [Edit](#).

### Moving the area on the map

- ▶ Swipe in any direction on the Touch Control or touchpad.

or

- ▶ Slide the controller in any direction.



### Changing the size of the area

- ▶ **To start:** press the Touch Control, the touchpad or the controller.
- ▶ **To change:** swipe up or down on the Touch Control or the touchpad.

or



- ▶ Slide the controller up or down.
- ▶ **To stop:** press the Touch Control, the touchpad or the controller.

### Taking the area for the route into account

- ▶ Avoid  an area in the list.  
If route guidance is active, a new route is calculated.
- If there is no route yet, the setting is carried over to the next route guidance.

### Deleting one or all areas

Multimedia system:

- ▶ Navigation ▶  Route and Position
- ▶ Avoid Options ▶ Areas
- ▶ Highlight an area in the list.
- ▶ Select  Delete or  Delete All.

- ▶ Confirm the prompt with **Yes**.  
One or all areas are deleted.

### Map data update overview

#### Updating at the authorized Mercedes-Benz Center

The digital maps generated by the map software become outdated in the same way as conventional road maps. Optimal route guidance can only be provided by the navigation system in conjunction with up-to-date map data. Information about new versions of the digital map can be obtained from an authorized Mercedes-Benz Center.

You can have updates to the digital map implemented there.

- ⓘ Additional costs can be incurred in this process.

#### Online map update

The online map update service from Mercedes me connect can be used to update map data.

- ⓘ The online map update service is not available in all countries.

The following options are available for the update:

- The automatic map update updates map data for one region.  
For automatic map updates **Automatic Online Update** must be activated in the system settings (→ page 245).
- The manual map update updates map data for several or all regions.

Further information on the online map update is available at an authorized Mercedes-Benz Center or at <https://www.mercedes.me>.

#### Overview of map data

Your vehicle is supplied with map data at the factory. Depending on the country, map data for your region is either pre-installed or the map data is supplied on a data storage medium.

If the map data on your vehicle has been installed at the factory and you wish to reinstall it, you do not need to enter the activation code.

For map data that you have purchased in the form of a data storage medium, you must enter the accompanying activation code.

- i** If you save the map data on a data storage medium with the online map update service, no entry is required. The activation code is stored on the data storage medium during the downloading process.

Observe the following when entering the activation code:

- The activation code can be used for one vehicle
- The activation code is not transferable
- The activation code has six digits

In the event of the following problems, please contact an authorized Mercedes-Benz Center:

- The multimedia system does not accept the activation code
- You have lost the activation code

### Displaying the compass

Multimedia system:

Navigation ▶  Route and Position

▶ Select **Compass**.

The compass display shows the following information:

- the current direction of travel with bearing (360° format) and compass direction
- longitude and latitude coordinates in degrees, minutes and seconds
- height (rounded)
- number of GPS satellites from which a signal can be received

### Setting the map scale automatically

Multimedia system:

Navigation ▶  Options

The map scale is set automatically depending on your driving speed.

For journeys in cities with detailed city models, a map view from the driver's perspective is used.

▶ Switch **Auto Zoom** on  or off .

- i** The automatically selected map scale can be changed manually for a short time. The setting is reset automatically after a few seconds.

### Displaying the satellite map

Multimedia system:

Navigation ▶  Options

▶ **Map Content**

▶ Switch **Satellite Map** on  or off .

or

▶ If satellite map display **6** is available in the map menu, switch it on  or off  (→ page 267).

Switched on : satellite maps are displayed in map scales of 2 mi (2 km) or less.

Switched off : no satellite maps are displayed.

- i** Satellite maps for these map scales are not available in all countries.

### Displaying weather information

#### Requirements:

- Mercedes me connect is available.

- You have a user account for the Mercedes me Portal.
- The service is available.
- The service has been activated at an authorized Mercedes-Benz Center.

Further information can be found at: <https://www.mercedes.me>

Multimedia system:

→ Navigation →  Options

→ Map Content

▶ Activate **Weather Information** .

or

▶ If weather information display  is available in the map menu, activate  (→ page 267) it.

Current weather information is displayed on the navigation map, e.g. temperature or cloud cover.

 Weather information is not available in all countries.

## Telephone

### Telephony

#### Notes on telephony

 **WARNING** Risk of distraction from operating integrated communication equipment while the vehicle is in motion

If you operate communication equipment integrated in the vehicle when driving, you could be distracted from the traffic situation. This could also cause you to lose control of the vehicle.

- ▶ Only operate this equipment when the traffic situation permits.
- ▶ If you cannot be sure of this, stop the vehicle whilst paying attention to road and traffic conditions and operate the equipment with the vehicle stationary.

 **WARNING** Risk of an accident from operating mobile communication equipment while the vehicle is in motion

Mobile communications devices distract the driver from the traffic situation. This could also cause the driver to lose control of the vehicle.



- ▶ As the driver, only operate mobile communications devices when the vehicle is stationary.
- ▶ As a vehicle occupant, only use mobile communications devices in the areas intended for this purpose, e.g. in the rear passenger compartment.

You must observe the legal requirements for the country in which you are currently driving when operating mobile communication equipment in the vehicle.

Further information can be obtained from an authorized Mercedes-Benz Center or at: <https://www.mercedes-benz-mobile.com/>

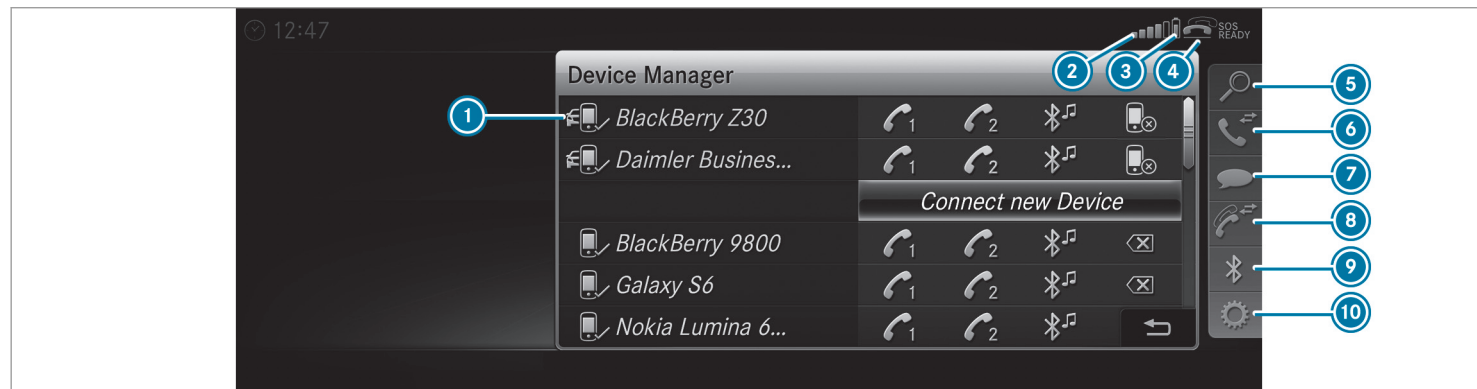
## Telephone menu overview



- ① Bluetooth® device name of the currently connected mobile phone
- ② Signal strength of the mobile phone network for the currently connected and selected mobile phone
- ③ Battery status of the currently connected and selected mobile phone
- ④  (telephone ready) or  (call active)

- ⑤ [Contacts](#) (→ page 280)
- ⑥ [Recent Calls](#) (→ page 282)
- ⑦ [Text Message](#)
- ⑧ One mobile phone connected: [Active Call](#).  
Two mobile phones connected: changes view between telephone 1 and 2 or [Active Call](#)
- ⑨ [Devices](#) (→ page 275)

- ⑩ [Options](#)  
Symbols ① to ④ are not shown until after a mobile phone has been connected to the multimedia system. The symbols depend on your mobile phone and your mobile phone network provider.

### Bluetooth® profile overview

Bluetooth® profile of the mobile phone	Function
PBAP (Phone Book Access Profile)	Contacts are automatically displayed in the multimedia system
MAP (Message Access Profile)	Message functions can be used

### Telephony operating modes overview

Depending on your equipment, the following telephony operating modes are available:

- A mobile phone is connected to the multimedia system via Bluetooth® (→ page 275).
- Two mobile phones are connected with the multimedia system via Bluetooth® (two phone mode) (→ page 276).

### Information on telephony

The following situations can lead to the call being disconnected while the vehicle is in motion:

- There is insufficient network coverage in the area
- You move from one GSM or UMTS transmitter/receiver area (cell) into another and no communication channels are free
- The SIM card used is not compatible with the network available
- A mobile phone with "Twincard" is logged into the network with the second SIM card at the same time

The multimedia system supports calls in HD Voice® for improved speech quality. A requirement for this is that the mobile phone and the mobile phone network provider of the person you are calling support HD Voice®.

Depending on the quality of the connection, the voice quality may fluctuate.

### Connecting a mobile phone (Bluetooth® telephony)

#### Requirements:

- Bluetooth® is activated on the mobile phone (see the manufacturer's operating instructions).
- Bluetooth® is activated on the multimedia system (→ page 237).

Multimedia system:

☞ Phone ☞ Bluetooth® Devices

#### Searching for a mobile phone

▶ Select **Connect New Device**.

▶ Select **Start Search on System**.

The available mobile phones are displayed. If a new mobile phone is found, it is indicated by the  symbol.

#### Connecting a mobile phone (authorization using Secure Simple Pairing)

▶ Select the mobile phone.

A code is displayed in the multimedia system and on the mobile phone.

- ▶ **If the codes match:** confirm the code on the mobile phone.

### Connecting a mobile phone (authorization by entering a passkey)

- ▶ Select the mobile phone.
- ▶ Choose a one to sixteen-digit number combination as a passkey.
- ▶ **On the multimedia system:** enter the passkey and select .
- ▶ **On the mobile phone:** enter the passkey again and confirm.

- ⓘ Up to 15 mobile phones can be authorized on the multimedia system. Authorized mobile phones are reconnected automatically.

### Connecting a second mobile phone (two phone mode)

#### Requirements:

- At least one mobile phone is already connected to the multimedia system via Bluetooth®.

Multimedia system:

↳ Phone ▶▶ ⌘ Devices

- ▶ Select **Connect New Device**.
- ▶ Select **Start Search on System**. The available mobile phones are displayed.
- ▶ Select the mobile phone.
- ▶ Answer the **How would you like to connect the new device?** prompt.
- ▶ **To replace the currently connected mobile phone:** select **Phone 1**. The currently connected mobile phone is replaced by the new mobile phone.

or

- ▶ **To connect the second mobile phone:** select **Phone 2**. The new mobile phone is connected as **Phone 2**. If two mobile phones have already been connected, the second telephone is replaced by the new mobile phone.

or

- ▶ **To use the mobile phone as an audio source:** select **Audio Source** (→ page 309).

- ⓘ A mobile phone can be operated both as an audio source as well as telephone in parallel.
- ⓘ The type of connection for the connected mobile phone, for example as **Phone 1**, **Phone 2** or as **Audio Source**, can be redefined at any time. (→ page 276).

### Functions of the mobile phone in two phone mode

#### Functions overview

Mobile phone in the foreground	Mobile phone in the background
Full range of functions	Incoming calls

### Interchanging mobile phones (two phone mode)

#### Requirements:

- The mobile phones are authorized (→ page 275).

Multimedia system:

→ Phone ▶▶ ⌘ Devices

- ▶ In the device overview, select a mobile phone which has already been authorized and set as **Phone 1** or **Phone 2**.

After interchanging the mobile phones, the mobile phone in the foreground is replaced by the mobile phone in the background.

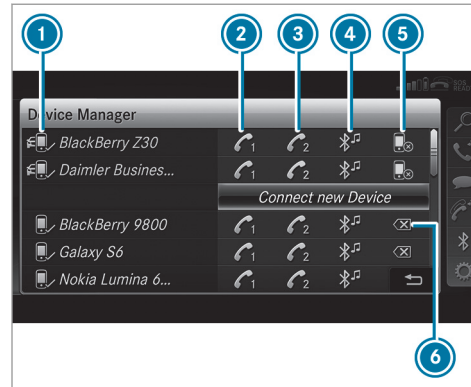

- 1 Bluetooth® device name of the currently connected mobile phone
- 2 Connects a mobile phone as **Phone 1**
- 3 Connects a mobile phone as **Phone 2**
- 4 Connects a mobile phone as **Audio Source**
- 5 Disconnects a mobile phone(→ page 277)
- 6 De-authorizes a mobile phone(→ page 277)

- ⓘ If a new mobile phone is connected and defined as **Phone 1**, for example, this overwrites the previously connected mobile phone in the foreground of the system.

### Disconnecting a mobile phone

Multimedia system:

→ Phone ▶▶ ⌘ Devices

- ▶ Select the symbol in the line of the mobile phone.  
The disconnection of the mobile phone takes place without a confirmation prompt. The mobile phone remains authorized in the system.

### De-authorizing a mobile phone

Multimedia system:

→ Phone ▶▶ ⌘ Devices

- ▶ Select the symbol in the line of the mobile phone.
- ▶ Answer the confirmation prompt with **Yes**.  
The mobile phone is de-authorized and deleted from the system.

### Information on Near Field Communication (NFC)

NFC enables short-range wireless data transfer or (re)connection of a mobile phone with the multimedia system.

The following functions are available without having authorized a mobile phone:

- Transferring a URL to be viewed in the multimedia system (see the manufacturer's operating instructions).
- Setting up the vehicle's Wi-Fi access data via the system settings (→ page 239).

Further information can be found at: <https://www.mercedes-benz-mobile.com/>

### Using a mobile phone with Near-Field Communication (NFC)

#### Requirements:

- NFC is activated on the mobile phone (see the manufacturer's operating instructions)
- The mobile phone's screen is switched on and unlocked (see the manufacturer's operating instructions)

### Connecting a mobile phone

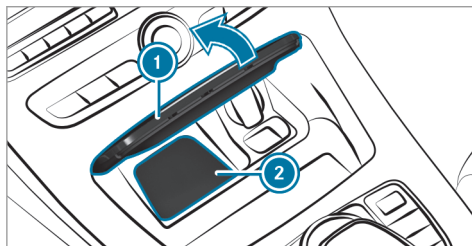

- ▶ Open storage compartment cover ①.
- ▶ Hold the NFC interface of the mobile phone (see manufacturer's operating instructions) on mat ② or place the mobile phone on mat ② with the display facing upwards. The mobile phone is connected to the multimedia system.
- ▶ Follow the additional prompts on the media display to connect the mobile phone.

### Replacing a mobile phone

- ▶ Hold the NFC interface of the mobile phone (see manufacturer's operating instructions)

on mat ② or place the mobile phone on mat ② with the display facing upwards.

Further information can be found at: <https://www.mercedes-benz-mobile.com/>

### Setting the reception and transmission volume

#### Requirements:

- The mobile phone is authorized (→ page 275).

Multimedia system:

☛ Phone ▶ ⚙️ Options ▶ Phone

This function ensures optimal language quality.

- ▶ Select **Reception Volume** or **Transmission Volume**.
- ▶ Set the volume.

Further information on the recommended reception and transmission volume: <https://www.mercedes-benz-mobile.com/>



## Adjusting the call and ringtone volume

Multimedia system:

↳ System ▶  Audio ▶ Phone

- ▶ Select **Call Volume** or **Ringtone Volume**.
- ▶ Set the volume.

## Starting or stopping mobile phone voice recognition

### Requirements:

- The mobile phone is connected to the multimedia system (→ page 275).

### Starting mobile phone voice recognition

- ▶ Press and hold the  button on the multi-function steering wheel for more than one second.  
You can use mobile phone voice recognition.

### Stopping mobile phone voice recognition

- ▶ Press the  or  button on the multi-function steering wheel.

## Calls

### Using the telephone

Multimedia system:

↳ Phone ▶  Contacts

### Making a call

- ▶ Select **Numerical Keypad**.
- ▶ Enter the number.
- ▶ Select .  
The call is made.

### Accepting a call

- ▶ Select **Accept**.

### Rejecting a call

- ▶ Select **Reject**.

### Ending a call

- ▶ Select .

### Activating functions during a call

- ▶ To show all functions, navigate down.

The following functions are available during a call:

- **End Call**
- **Make Additional Call**
- **Keyboard** (show to send DTMF tones)
- Switch **Mute Mic** on  or off .
- **Private Mode** (an active call in hands-free mode is transferred over to the telephone)

### Conducting calls with several participants

#### Requirements:

- There is an active call (→ page 279).
- Another call is being made.

### Switching between calls

- ▶ Select call ●.  
The selected call is active. The other call is on hold.

### Activating or ending a call on hold

- ▶ Select **Continue Call** or **End Call**.

### Conducting a conference call

- ▶ Select [Create Conference Call](#) in the telephone menu.  
The new participant is included in the conference call.

### Ending an active call

- ▶ Select .
- ⓘ On some mobile phones, the call on hold is activated as soon as the active call is ended.

### Accepting/rejecting a waiting call

#### Requirements:

- There is an active call (→ page 279).

If you receive a call while already in a call, a message is displayed. An acoustic signal also sounds.

- ▶ Select [Accept](#).  
The incoming call is active.  
If only one mobile phone is connected with the multimedia system, the previous call will be put on hold.

- ▶ If during a call you accept a call with the other mobile phone when in two phone mode then the existing call is ended.
- ▶ Select [Reject](#).
- ⓘ This function and behavior depends on your mobile phone network provider and the mobile phone (see the manufacturer's operating instructions).

### Contacts

#### Information about the contacts menu

The contacts menu contains all contacts from existing data sources, e.g. mobile phone or memory card. You can store up to 6,000 contacts.

Depending on the data source, you have the following number of contacts:

- Permanently saved contacts: 3,000 entries
- Contacts loaded from the mobile phone: 3,000 entries

From the contacts menu, you can perform the following actions:

- Using the telephone:
  - Calling a contact (→ page 282)
  - Calling a new number (→ page 279)
- Navigation (→ page 254)
- Compose messages (→ page 283)

If a mobile phone is connected to the multimedia system (→ page 275) and automatic calling up (→ page 280) is activated, the mobile phone's contacts are displayed in the address book.

#### Downloading mobile phone contacts

Multimedia system:

↳ [Phone](#) ▶  [Options](#) ▶ [Contacts](#)

#### Automatically

- ▶ Switch [Synchronize Contacts Automatically](#) on .

#### Manually

- ▶ Deactivate  [Synchronize Contacts Automatically](#).

- ▶ Select [Synchronize Contacts](#).

### Calling up contacts

Multimedia system:

▶ Phone ▶  Contacts

Depending on the character set, the following options can be used to search for contacts:

- searching by initials
- searching by name
- searching by phone number

▶ Enter characters into the search field. A selection of possible contacts appears. Entering more characters into the search field narrows down the number of possible selections.

▶ Select the contact.

A contact can contain the following details:

- phone numbers
- navigation addresses
- geo-coordinates
- Internet address

### Editing the format of a contact's name

Multimedia system:

▶ Phone ▶  Options ▶ Contacts ▶ Name Format



The following options are available:



- [Last Name, First Name](#)
- [Last Name First Name](#)
- [First Name Last Name](#)

▶ Select an option.

### Overview of importing contacts

#### Contacts from various sources

Source	Requirements
 Memory card	The SD memory card is inserted.
 USB device	The USB device is inserted in the USB port.

Source	Requirements
 Bluetooth® connection	Bluetooth® is activated in the multimedia system and on the respective device (see the manufacturer's operating instructions).
 Mobile phone	The mobile phone is connected to the multimedia system.

 If the sending of vCards via Bluetooth® is supported, vCards can be received on mobile phones or netbooks, for example.

### Importing contacts into the contacts menu

Multimedia system:



▶ Phone ▶  Options ▶ Contacts

- ▶ Select [Import](#).
- ▶ Select an option.

### Saving a mobile phone contact

Multimedia system:

→ Phone » 🔍 Contacts

- ▶ Select the mobile phone contact .
- ▶ Select .
- ▶ Select **Save to Vehicle**.  
The contact saved in the multimedia system is identified by the  symbol.

### Calling a contact

Multimedia system:

→ Phone » 🔍 Contacts

- ▶ Enter characters into the search field.
- ▶ Select the contact.
- ▶ Select the telephone number.  
The number is dialed.

### Selecting further options in the contacts menu

Multimedia system:

→ Phone » 🔍 Contacts

- ▶ Select a contact.
- ▶ Select .

Depending on the stored data, the following options are available:

- **Call**
  - **Send Text Message**
  - **Show Website** (if an Internet address has been stored)
  - **Navigate** (if an address has been stored)
  - **Save My Favorite**
  - **Send DTMF Tones** (for a number with DTMF tones)
- ▶ Select an option.

### Deleting a contact

Multimedia system:

→ Phone » 🔍 Contacts

You can delete contacts stored in the vehicle.

- ▶ Search for the contact.
- ▶ Select the contact.
- ▶ Select .
- ▶ Select **Delete Contact**.
- ▶ Select **Yes**.

### Call list

#### Call list overview

Depending on whether your mobile phone supports the PBAP Bluetooth® profile or not, this can have different effects on the presentation and functions of the call list.

If the PBAP Bluetooth® profile is supported, the effects are as follows:

- The call lists from the mobile phone are displayed in the multimedia system.
- When connecting the mobile phone, you may have to confirm the connection for the PBAP Bluetooth® profile.

If the PBAP Bluetooth® profile is not supported, the effects are as follows:

- The multimedia system generates its own call lists.
- The call list is not synchronized with the call lists in the mobile phone.

### Making a call from the call list

Multimedia system:

☞ Phone ☞  Recent Calls

- ▶ Select a number.  
The call is made.

### Text messages

#### Overview of text message functions

If the connected mobile phone supports the MAP Bluetooth® profile, the text message functions can be used on the multimedia system.

You can obtain further information about settings and supported functions of Bluetooth®-capable mobile phones at an authorized Mercedes-Benz Center or at: <https://www.mercedes-benz-mobile.com/>

Some mobile phones require further settings after being connected to the multimedia system (see manufacturer's operating instructions).

New messages are identified by the  symbol in the media display and an audible signal.

Depending on the mobile phone, the multimedia system only displays new incoming text messages or the 100 newest text messages.

#### Configuring the text messages displayed

Multimedia system:

☞ Phone ☞  Options ☞ Text Message

☞ Message Display

- ▶ Select .

A menu with the following options is shown:

- All Messages
- New and Unread Messages
- New Messages
- Off (The text messages are not displayed automatically.)

- ▶ Select an option.

- ⓘ The setting may not be active until the mobile phone is reconnected.

#### Reading text messages

Multimedia system:

☞ Phone ☞  Text Message

#### Reading a text message

- ▶ Select a text message.  
The message text is displayed.

#### Using the read-aloud function

- ▶ Select a text message.
- ▶ Select **Read Aloud**.  
The text message is read aloud.

#### Composing and sending a text message

Multimedia system:

☞ Phone ☞  Text Message

- ▶ Select **Write New Text Message**.

#### Adding a recipient

- ▶ Select **Press to Add Recipient**.
- ▶ Select the contact.

#### Dictating text

- ▶ Select **Press to Dictate**.

- ▶ **To start the dictation function:** press on the central control element.  
The app for the dictation function is loaded.

If there was no prior Internet connection, a connection is now established.

- ▶ Say the message.  
The dictation ends automatically after you have finished speaking.  
After the voice message has been processed, it is shown as text.

- ▶ **To replace a message:** select [Replace message](#).  
The text that has been dictated and shown on the display is reset and can be dictated again.

#### Editing text

- ▶ Select the word.
- ▶ **To call up the correction menu:** press on the central control element.  
The following options are available:
  - Adjusting the capitalization of words (if supported by the character set)

- Expanding the choice of words
- Deleting the selection
- Recording a new dictation

- ▶ **To leave the menu:** select [Done](#).

#### Sending text messages

- ▶ Select [Send Text Message](#).

#### Replying to a text message

Multimedia system:

- ▶ [Phone](#) ▶ [Text Message](#)

- ▶ Open the text message.
- ▶ Select [Text Message](#).
- ▶ Select [Reply](#).

#### Calling a text message sender

Multimedia system:

- ▶ [Phone](#) ▶ [Text Message](#)

- ▶ Open the text message.
- ▶ Select [Text Message](#).
- ▶ Select [Call Sender](#).

#### Deleting text messages

Multimedia system:

- ▶ [Phone](#) ▶ [Text Message](#)

- ▶ Select [Text Message](#).

- ▶ **To delete a text message:** select [Delete](#).
- ▶ [Outbox](#)

or

- ▶ Select [Drafts](#).

#### Mercedes-Benz link

##### Overview of Mercedes-Benz Link

**⚠ WARNING** Risk of distraction from information systems and communications equipment

If you operate information and communication equipment integrated in the vehicle when driving, you will be distracted from the traffic situation. This could also cause you to lose control of the vehicle.

- ▶ Only operate this equipment when the traffic situation permits.

- ▶ If you cannot be sure of this, stop the vehicle whilst paying attention to road and traffic conditions and operate the equipment with the vehicle stationary.

Using Mercedes-Benz Link, various functions and selected mobile phone apps can be transferred to the media display.

The Mercedes-Benz Link control box supplementary equipment is required for this. You can obtain this at an authorized Mercedes-Benz Center.

- ⓘ The Mercedes-Benz Link control box uses the Android operating system.
- ⓘ The service provider is responsible for these apps and the services and content connected to it.

### Connecting Mercedes-Benz Link with the multimedia system

- ▶ Connect the Mercedes-Benz Link control box with the  USB port of the multimedia connection unit using a suitable connecting cable.

- ⓘ A suitable connecting cable is available separately at an authorized Mercedes-Benz Center.

### Using Mercedes-Benz Link

#### Requirements:

- The Mercedes-Benz Link control box is connected with the multimedia system using the  USB port.

Multimedia system:

➔ [Connect](#) ➔ [Mercedes-Benz Link](#)

- ▶ Select **MB Link**.  
The mobile phone functions and apps are available and shown on the media display.

You can find more information in the Mercedes-Benz Link control box operating instructions.

### Ending Mercedes-Benz Link

Multimedia system:

➔ [Connect](#) ➔ [Mercedes-Benz Link](#)

- ▶ Select **Disconnect**.  
The connection is ended.

The mobile phone continues to be supplied with electricity.

or

- ▶ Disconnect the connecting cable between the Mercedes-Benz Link control box and the multimedia system.

- ⓘ Mercedes-Benz recommends disconnecting the connecting cable only when the vehicle is stationary.

### Apple CarPlay®

#### Overview of Apple CarPlay®

**⚠ WARNING** Risk of distraction from information systems and communications equipment

If you operate information and communication equipment integrated in the vehicle when driving, you will be distracted from the traffic situation. This could also cause you to lose control of the vehicle.

- ▶ Only operate this equipment when the traffic situation permits.
- ▶ If you cannot be sure of this, stop the vehicle whilst paying attention to road and traffic conditions and operate the equipment with the vehicle stationary.

You must observe the legal requirements for the country in which you are currently driving when operating the multimedia system.

iPhone® functions can be used via the multimedia system using Apple CarPlay®. They are operated using the central control element or the Siri® voice control system. You can activate the voice control system by pressing and holding the  button on the multifunction steering wheel.

Only one mobile phone at a time can be connected via Apple CarPlay® to the multimedia system.

The availability of Apple CarPlay® may vary according to the country.

The service provider is responsible for this application and the services and content connected to it.

Apple CarPlay® is a registered trademark of Apple Inc.

#### Information on Apple CarPlay®

While using Apple CarPlay® various functions of the multimedia system, e.g. telephony or the media sources Bluetooth® audio and iPod®, are unavailable.

Only one route guidance can be active at a time. If route guidance is active on the multimedia system, it is closed when route guidance is started on the mobile phone.

#### Connecting an iPhone® via Apple CarPlay®

##### Requirements:

- Apple® operating system version iOS 8.3 or above is installed on the iPhone®.
- An Internet connection is required for the full range of functions for Apple CarPlay®.
- The iPhone® is connected to the multimedia system via the USB port  using a suitable cable (→ page 303).

Multimedia system:

 **Connect**  **Apple CarPlay**

#### Setting automatic or manual start

A message appears when connected for the first time.

- ▶ **Automatic start:** select **Automatically**. **Start Automatically** is activated .

Apple CarPlay® will now start immediately after the iPhone® is connected to the multimedia system using a USB cable.

- ▶ **Manual start:** select **Manually**.
- ▶ Select the iPhone® in the device list.

#### Accepting/rejecting the data protection regulations

A message with the data protection regulations appears.

- ▶ Select **Accept & Start**.

or

- ▶ Select **Decline & End**.



**Exiting Apple CarPlay®**

▶ Press the  button on the multifunction steering wheel, for example.

❶ If Apple CarPlay® was not displayed in the foreground before disconnecting, the application starts in the background when reconnected. You can call up Apple CarPlay® in the main menu.

**Calling up Apple CarPlay® sound settings**

Multimedia system:

↳ Connect ▶▶ Apple CarPlay ▶▶ Sound

▶ Select the sound menu (→ page 319).

**Ending Apple CarPlay®**

Multimedia system:

↳ Connect ▶▶ Apple CarPlay

▶ Select **Disconnect**.  
The connection is ended.

The mobile phone continues to be supplied with electricity.

or

▶ Disconnect the connecting cable between the mobile phone and multimedia system. Mercedes-Benz recommends disconnecting the connecting cable only when the vehicle is stationary.

**Android Auto****Android Auto overview**

**⚠ WARNING** Risk of distraction from information systems and communications equipment

If you operate information and communication equipment integrated in the vehicle when driving, you will be distracted from the traffic situation. This could also cause you to lose control of the vehicle.

- ▶ Only operate this equipment when the traffic situation permits.
- ▶ If you cannot be sure of this, stop the vehicle whilst paying attention to road and traffic conditions and operate the equipment with the vehicle stationary.

You must observe the legal requirements for the country in which you are currently driving when operating the multimedia system.

Mobile phone functions can be used with Android Auto using the Android operating system on the multimedia system. It is operated using the central control element or voice control system. You can activate the voice control system by pressing and holding the  button on the multifunction steering wheel.

Only one mobile phone at a time can be connected via Android Auto with the multimedia system.

The availability of Android Auto and Android Auto apps may vary according to the country.

The service provider is responsible for this application and the services and content connected to it.

**Information on Android Auto**

While using Android Auto, various functions of the multimedia system, for example the media source Bluetooth® audio, are not available.

Only one route guidance can be active at a time. If route guidance is active on the multimedia system,

tem, it is closed when route guidance is started on the mobile phone.

### Connecting a mobile phone via Android Auto

#### Requirements:

- The first activation of Android Auto on the multimedia system must be carried out when the vehicle is stationary for safety reasons.
- The mobile phone supports Android Auto from Android 5.0.
- The Android Auto app is installed on the mobile phone.
- In order to use the telephone functions, the mobile phone must be connected to the multimedia system via Bluetooth® (→ page 275). If there was no prior Internet connection, this is established with the use of the mobile phone with Android Auto.
- The mobile phone is connected to the multimedia system via the USB port  using a suitable cable (→ page 303).
- An Internet connection is required for the full range of functions for Android Auto.

Multimedia system:

↪ [Connect](#) ▶▶ [Android Auto](#)

- ▶ Select the mobile phone from the device list.

#### Accepting/rejecting the data protection regulations

A message with the data protection regulations appears.

- ▶ Select [Accept & Start](#).

or

- ▶ Select [Decline & End](#).

#### Activating automatic start

- ▶ Select [Start Automatically](#) .

#### Starting manually

- ▶ Select the mobile phone from the device list.

#### Exiting Android Auto

- ▶ Press the  button on the multifunction steering wheel, for example.

- ⓘ If Android Auto was not displayed in the foreground before disconnecting, the application starts in the background when reconnected.

You can call up Android Auto in the main menu.

### Calling up the Android Auto sound settings

Multimedia system:

↪ [Connect](#) ▶▶ [Android Auto](#) ▶▶ [Sound](#)

- ▶ Select the tone menu (→ page 319).

### Ending Android Auto

Multimedia system:

↪ [Connect](#) ▶▶ [Android Auto](#)

- ▶ Select [Disconnect](#).

The connection is ended.

The mobile phone continues to be supplied with electricity.

or

- ▶ Disconnect the connecting cable between the mobile phone and multimedia system. Mercedes-Benz recommends disconnecting the connecting cable only when the vehicle is stationary.

## Transferred vehicle data with Android Auto and Apple CarPlay®

### Overview of transferred vehicle data

When using Android Auto or Apple CarPlay®, certain vehicle data is transferred to the mobile phone. This enables you to get the best out of selected mobile phone services. Vehicle data is not directly accessible.

The following system information is transmitted:

- Software release of the multimedia system
- System ID (anonymized)

The transfer of this data is used to optimize communication between the vehicle and the mobile phone.

To do this, and to assign several vehicles to the mobile phone, a vehicle identifier is randomly generated.

This has no connection to the vehicle identification number (VIN) and is deleted when the multimedia system is reset (→ page 246).

The following driving status data is transmitted:

- Transmission position engaged

- Distinction between parked, standstill, rolling and driving
- Day/night mode of the instrument cluster

The transfer of this data is used to alter how content is displayed to correspond to the driving situation.

The following position data is transmitted:

- Coordinates
- Speed
- Compass direction
- Acceleration direction

This data is only transferred while the navigation system is active in order to improve it (e.g. so it can continue functioning when in a tunnel).

## Mercedes me calls

### Making a call via the overhead control panel

#### Requirements:

- You have access to a GSM network.
- The contract partner's GSM network coverage is available in the respective region.

- The ignition is switched on so that vehicle data can be transferred automatically.

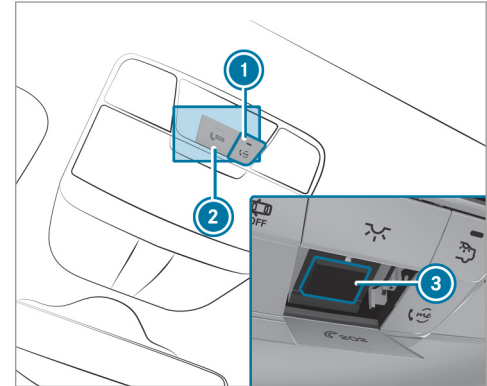

- ① me button for service or information calls
- ② SOS button cover
- ③ SOS button

### Making a Mercedes me call

- ▶ Press button ①.

### Making an emergency call

- ▶ To open the cover of SOS button ②, press it briefly.
- ▶ Press and hold SOS button ③ for at least one second.

If a Mercedes me call is active, an emergency call can still be triggered. This has priority over all other active calls.

### Information about the Mercedes me call using the me button

A call to the Mercedes-Benz Customer Center has been initiated via the me button in the overhead control panel or the multimedia system.

Using the voice control system, you can select one of the following services:

- Accident and breakdown management (→ page 293)
- Mercedes-Benz Customer Center for general information about the vehicle

You can find information on the following topics:

- Activation of Mercedes me connect
- Operating the vehicle

- Nearest authorized Mercedes-Benz Center
- Other products and services from Mercedes-Benz

Data is transferred during the connection to the Mercedes-Benz Customer Center (→ page 291).

### Calling the Mercedes-Benz Customer Center using the multimedia system

#### Requirements:

- You have access to a GSM network.
- The contract partner's GSM network coverage is available in the respective region.
- The ignition is switched on so that vehicle data can be transferred automatically.

Multimedia system:

☛ Phone ▶▶ 🔍 Contacts

- ▶ Call **Mercedes me connect**.  
The call is made.

After confirmation, the multimedia system sends the required vehicle data. The data transfer is shown in the media display.

Then, you can select a service and be connected to a specialist at the Mercedes-Benz Customer Center.

### Calling the Mercedes-Benz Customer Center after automatic accident or breakdown detection

#### Requirements:

- The vehicle has detected an accident or breakdown situation.
- The vehicle is stationary.
- The hazard warning lights are switched on.

ⓘ This function is not available in all countries. In limited situations the vehicle can detect accident or breakdown situations.

In the event an accident or breakdown is detected, the emergency guide shows safety notes in the multimedia system display.

After quitting the emergency guide display on the multimedia system, a prompt appears asking whether you wish to get support from the Mercedes-Benz Customer Center.

▶ Select **Call**.

- After your agreement, or if the Mercedes me connect service "Accident and Breakdown Management" is active, the vehicle data is transferred automatically (→ page 293).
- A Mercedes-Benz Customer Center employee takes your call and organizes the breakdown and accident assistance.

You may be charged for these services.

- ⓘ Depending on the severity of the accident, an automatic emergency call can be initiated. This has priority over all other active calls.
- ⓘ In addition, if the Mercedes me connect service "Telediagnosics" is active, a similar prompt can appear after a delay in the event of a breakdown. If you are already in contact with the Mercedes-Benz Customer Center or have already received support, this prompt can be ignored or declined.
- ⓘ If you answer the prompt for support from the Mercedes-Benz Customer Center with

**Later**, the message will be hidden and appear again later.

The prompt triggered by the Mercedes me connect service "Telediagnosics", can either be confirmed or declined. After being declined, this will not be shown again.

### Arranging a service appointment via a Mercedes me call

If you have activated the maintenance management service, relevant vehicle data is transferred automatically to the Mercedes-Benz Customer Center. You will then receive individual recommendations regarding the maintenance of your vehicle.

Regardless of whether you have consented to the maintenance management service, the multimedia system reminds you after a certain amount of time that a service is due. A prompt appears asking if you would like to make an appointment.

▶ **To arrange a service appointment:** select **Call**.

After your agreement the vehicle data is sent and a Mercedes-Benz Customer Center

employee deals with your appointment. The information is then sent to your desired service outlet.

This will contact you to confirm the appointment and if necessary consult about the details.

- ⓘ If you select **Later** after the service message appears, the message is hidden and reappears at a later time.

### Transferred data during a Mercedes me call

If you initiate a service call using Mercedes me, data is transferred to enable targeted advice and an efficient service.

The following requirements must be fulfilled for the transfer of the data:

- The ignition is switched on.
- The required data transfer technology is supported by the mobile phone network provider.
- The quality of the mobile connection is sufficient.

Multi-stage transfer depends on the following factors:

- Reason for the initiation of the call
- The available mobile phone transmission technology.
- The activated Mercedes me connect services.
- The service selected in the voice control system.

### **Data transfer if Mercedes me connect services are not activated**

If no Mercedes me connect services are activated, the following data is transferred:

- Vehicle identification number
- Time of the call
- Reason for the initiation of the call
- Confirmation of the data protection prompt
- Country indicator of the vehicle
- Set language for the multimedia system
- Telephone number of the communication platform installed in the vehicle

If a call is made for a service appointment via the service reminder, the following data is also transmitted:

- Current mileage and maintenance data

If a call is made after automatic accident or breakdown detection using the multimedia system, the following data is also transmitted:

- Current mileage and maintenance data
- Current vehicle location

If Accident and Breakdown Management is called via the voice control system and no service has been activated, the following data can also be called up from the vehicle by the Mercedes-Benz Customer Center:

- Current vehicle location

### **Data transfer if Mercedes me connect services are activated**

Only if the respective service is activated will additional incident-specific data be transmitted in the second stage to enable an optimal service.

An overview of the data transmitted can be found in the respective terms of use for Mercedes me connect services. These can be obtained in the Mercedes me Portal: <https://me.secure.mercedes-benz.com>

### **Data processing**

The data transmitted within the scope of the call is deleted from the processing system after the call is finished, in so far as this data is not being used for other activated Mercedes me connect services.

The incident-specific data is processed and stored in the Mercedes-Benz Customer Center and, if required to process the incident, forwarded to the service partner authorized by the Mercedes-Benz Customer Center. Please take note of the data protection information on the Mercedes me Internet page <https://www.mercedes.me> or in the recorded message immediately after calling the Mercedes-Benz Customer Center.

- ① The recorded message is not available in every country.

## Mercedes me connect

### Information on Mercedes me connect

Mercedes me connect provides the following services:

- Accident and breakdown management (me button)
- Mercedes-Benz emergency call system (automatic emergency call and SOS button)

The Mercedes-Benz Customer Center and the Mercedes-Benz emergency call center are available for you around the clock.

The me button and the SOS button can be found on the vehicle's overhead control panel (→ page 289).

You can also call the Mercedes-Benz Customer Center using the multimedia system (→ page 290).

Please note that Mercedes me connect is a Mercedes-Benz service. In emergencies, first call the national emergency services using the standard national emergency service telephone numbers. In emergencies, you can also use the

Mercedes-Benz emergency call system (→ page 294).

Observe the conditions of use for Mercedes me connect and other services. These can be obtained in the Mercedes me Portal: <https://me.secure.mercedes-benz.com>

### Information on Mercedes me connect Accident and Breakdown Management

The Accident and Breakdown Management can include the following functions:

- Supplement to the Mercedes-Benz emergency call system (→ page 294)  
If necessary, the contact person at the Mercedes-Benz emergency call center forwards the call to Mercedes me connect Accident and Breakdown Management. Forwarding the call is however not possible in all countries.
- Breakdown assistance by a technician on location and/or the towing away of the vehicle to the nearest authorized Mercedes-Benz Center  
You may be charged for these services.

More information about Mercedes me connect services can be obtained in the Mercedes me Portal: <https://me.secure.mercedes-benz.com>

### Data transferred during Mercedes me connect call services

The data transferred during a Mercedes me connect call depends on:

- The reason for initiation of the call
- The service that is selected in the voice control system
- The activated Mercedes me connect services

Which data is transferred for the services can be taken from the currently valid terms of use. These can be obtained in the Mercedes me portal: <https://me.secure.mercedes-benz.com>

## Mercedes-Benz emergency call system

### Information on the Mercedes-Benz emergency call system

Your vehicle is equipped with the Mercedes-Benz emergency call system ("eCall"). This feature can help save lives in the event of an accident. eCall

in no way replaces assistance provided from dialing 911.

The Mercedes-Benz emergency call system is available for at least ten years starting from the manufacturing date.

Mercedes-Benz eCall only functions in areas where mobile phone coverage is available from the wireless service providers. Insufficient network coverage from the wireless service providers may result in an emergency call not being transmitted.

eCall is a standard feature in your Mercedes-Benz vehicle. In order to function as intended, the system relies on the transmission of data detailed in the Transmitted Data section that follows (→ page 296).

To disable eCall, a customer must visit an authorized Mercedes-Benz Service department to deactivate the vehicle's communication module.

**Deactivation of this module prevents the activation of any and all Mercedes me connect services. After the deactivation of**

**eCall, automatic emergency call and manual emergency call will not be available.**

The ignition must be switched on before an automatic emergency call can be made.

- ❗ eCall is activated at the factory.
- ❗ eCall can be deactivated by an authorized Mercedes-Benz dealer. Please note that in the event ownership of the vehicle is transferred to another owner in its deactivated state, eCall will remain deactivated unless the new owner visits an authorized Mercedes-Benz dealership to reactivate the system.

**Overview of the Mercedes-Benz emergency call system**

eCall can help to reduce the time between an accident and the arrival of emergency services at the site of the accident. It helps locate an accident site in places that are difficult to access. However, even if a vehicle is equipped with eCall, this does not mean the system is ON. As such, eCall does not replace dialing 911 in the event of an accident.

An emergency call can be made automatically (→ page 295) or manually (→ page 295).

Only make emergency calls if you or others are in need of rescue. Do not make an emergency call in the event of a breakdown or a similar situation.

**Displays in the media display**

**SOS READY:** eCall available

**SOS NOT READY:** the ignition is not on or eCall is not available.

During an active emergency call,  appears in the display.

You can find more information on the regional availability of eCall at: <https://www.mercedes-benz-mobile.com/extra/ecall/>

- ❗ If there is a malfunction in the emergency call system (e.g. a malfunction with the speaker, microphone, airbag, SOS button), a corresponding message appears in the multifunction display of the instrument cluster.



### Triggering an automatic emergency call

#### Requirements

- The ignition is switched on.
- The starter battery is sufficiently charged.

If restraint systems such as airbags or Emergency Tensioning Devices have been activated after an accident, the Mercedes-Benz emergency call system may automatically initiate an emergency call.

The emergency call has been made:

- A voice connection is made to the Mercedes-Benz emergency call center.
- A message with accident data is transmitted to the Mercedes-Benz emergency call center.

The Mercedes-Benz emergency call center can transmit the vehicle position data to one of the emergency call centers.

The SOS button in the overhead control panel flashes until the emergency call is finished.

It is not possible to immediately end an automatic emergency call.

If no connection can be made to the emergency services either, a corresponding message appears in the media display.

▶ Dial the local emergency number on your mobile phone.

If an emergency call has been initiated:

- Remain in the vehicle if the road and traffic conditions permit you to do so until a voice connection is established with the emergency call center operator.
- Based on the call, the operator decides whether it is necessary to call rescue teams and/or the police to the accident site.
- If no vehicle occupant answers, an ambulance is sent to the vehicle immediately.

#### Triggering a manual emergency call

▶ Press and hold the SOS button in the overhead control panel for at least one second.

The emergency call has been made:

- A voice connection is made to the Mercedes-Benz emergency call center.

- A message with accident data is transmitted to the Mercedes-Benz emergency call center. The Mercedes-Benz emergency call center can transmit the vehicle position data to one of the emergency call centers.

- Remain in the vehicle if the road and traffic conditions permit you to do so until a voice connection is established with the emergency call center operator.
- Based on the call, the operator decides whether it is necessary to call rescue teams and/or the police to the accident site.

If no connection can be made to the emergency services either, a corresponding message appears in the media display.

▶ Dial the local emergency number on your mobile phone.

#### Ending an unintentional emergency call

▶ **On the multifunction steering wheel:** select . Depress the button for several seconds.

### Data transfer of the Mercedes-Benz emergency call system

In the event of an automatic or manual emergency call the following data is transmitted, for example:

- Vehicle's GPS position data
- GPS position data on the route (a few hundred meters before the incident)
- Direction of travel
- Vehicle identification number
- Vehicle drive type
- Number of people determined to be in the vehicle
- Whether Mercedes me connect is available or not
- Whether the emergency call was initiated manually or automatically
- Time of the accident
- Language setting on the multimedia system

Data transmitted is vehicle information. For any questions about the collection, use and sharing of the eCall system data, please contact MBU-

SA's Customer Assistance Center at 800-FOR-MERC.

For Canada, please contact MBC's Customer Assistance Center at 1-800-387-0100.

Customer requests for covered information should be submitted via the same channels.

For accident clarification purposes, the following measures can be taken up to an hour after the emergency call has been initiated:

- The current vehicle position can be determined.
- A voice connection to the vehicle occupants can be established

## Online and Internet functions

### Internet connection

#### Information on connecting to the Internet

**⚠ WARNING** Risk of distraction from information systems and communications equipment

If you operate information and communication equipment integrated in the vehicle when driving, you will be distracted from the traffic situation. This could also cause you to lose control of the vehicle.

- ▶ Only operate this equipment when the traffic situation permits.
- ▶ If you cannot be sure of this, stop the vehicle whilst paying attention to road and traffic conditions and operate the equipment with the vehicle stationary.

You must observe the legal requirements for the country in which you are currently driving when operating the multimedia system.

**⚠ WARNING** Risk of an accident from operating mobile communication equipment while the vehicle is in motion

Mobile communications devices distract the driver from the traffic situation. This could also cause the driver to lose control of the vehicle.

- ▶ As the driver, only operate mobile communications devices when the vehicle is stationary.
- ▶ As a vehicle occupant, only use mobile communications devices in the areas intended for this purpose, e.g. in the rear passenger compartment.

You must observe the legal requirements for the country in which you are currently driving when operating mobile communication equipment in the vehicle.

The Internet functions can only be used to a limited degree whilst driving.

### Function of the communication module

On vehicles with a built-in communication module, the Internet connection is established via an integrated SIM card.

To use Internet access via the communication module the following conditions must be met:

- The vehicle is equipped with a permanently installed communication module.
- Mercedes me connect is active and ready for operation.
- Mercedes me connect is activated for Internet access.

For most Mercedes me connect services, data volume is available when purchasing the services.

Additional data volume is required to use some functions, e.g. Internet radio or Wi-Fi hotspot.

If the data volume limit is reached, the availability of Mercedes me connect services is limited. The data volume can be purchased **directly from a mobile phone network provider** via the Mercedes me Portal.

- ① Visit an authorized Mercedes-Benz Center to find out whether it is possible to purchase data volume in your country **directly from a mobile phone network provider**.

### Connection status

#### Connection status overview



- ① Display of the communication module reception field strength
- ② Display of existing connection

### Displaying the connection status

Multimedia system:

↳ System ▶▶  Connectivity

▶ Select **Internet Status**.

① In the case of a connection via the communication module the following status information is shown:

- Type of network
- Status online/offline

### Mercedes-Benz Apps

#### Calling up Mercedes-Benz Apps

##### Requirements:

- The registration for the use of Mercedes-Benz Apps has been completed.
- The general terms and conditions have been confirmed.

Multimedia system:

↳ Connect ▶▶  Mercedes-Benz Apps

▶ Select an app.

① The available features are country-dependent.  
License fees may be applicable.

#### Using Mercedes-Benz Apps with voice control

##### Requirements:

- The registration for the use of Mercedes-Benz Apps has been completed.
- The general terms and conditions have been confirmed.

The  symbol indicates that a Mercedes-Benz app can be used via voice control.

▶ Select a Mercedes-Benz app.  
The app menu is displayed.

▶ **To use voice control:** select  Language.

▶ Say the question or command.

① Voice control is not available in all countries and languages.

### TuneIn Radio

#### Calling up TuneIn Radio

##### Requirements:

- The Internet Radio service is activated.
- The data volume is available.  
Depending on the country, data volume may need to be purchased.

• A fast Internet connection for data transmission free of interference.

The services are country-dependent.

For more information, consult an authorized Mercedes-Benz Center.

Multimedia system:

↳ Radio ▶▶  Radio Source

▶ Select **TuneIn Radio**.

The TuneIn Radio display appears. The last station set starts playing.

① The connection quality depends on the local mobile phone reception.

## Overview of Tuneln Radio

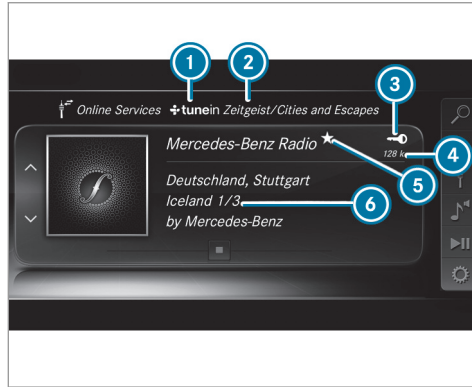

- ① Internet Radio provider
- ② Selected category
- ③ Display (if connected to private user account)
- ④ Data transfer rate
- ⑤ Current station is stored as a favorite
- ⑥ Additional information on the current station

## Selecting and connecting Tuneln Radio stations

Multimedia system:

- Radio ➤ Radio Source
- Tuneln Radio ➤ Search

- Select a category.
- Select a station.  
The connection is established automatically.

or

- Select **Enter Address or POI**.
- Enter a station name using the entry field.

A relatively large volume of data can be transmitted when using Tuneln Radio.

## Saving/deleting a Tuneln Radio station as a favorite

Multimedia system:

- Radio ➤ Radio Source
- Tuneln Radio

- Select a station.

- Press and hold the central control element until an audible signal sounds.  
The symbol appears by the station name.
- Select **Favorites** .  
The list of saved favorite stations appears.

or

- Create an account for the online provider (Tuneln Radio) and then log in on the multimedia system.  
Your favorites are imported to the multimedia system.

## Deleting favorites

- Select **Favorites** .
- Select a station.
- Press and hold the central control element until an audible signal sounds.  
The symbol by the station name disappears.

### Setting the Tuneln Radio options

Multimedia system:

➔ Radio ➔  Radio Source  
➔ Tuneln Radio ➔  Options

The following options are available:

- **Select Stream:** select the stream quality
- **Login to Tuneln Account:** log in to your Tuneln user account
- **Log Out of Account:** log out of your Tuneln user account

▶ Select an option.

### Media

#### Audio mode

#### Information on the audio mode

**⚠ WARNING** Risk of distraction when handling data storage media

If you handle a data storage medium while driving, your attention is diverted from the

traffic conditions. This could also cause you to lose control of the vehicle.

▶ Only handle a data storage medium when the vehicle is stationary.

Permissible file systems:

- FAT32
- exFAT
- NTFS

Permissible data storage medium:

- SD card
- USB storage device
- iPod®/iPhone®
- MTP devices
- Bluetooth® audio equipment

**i** Observe the following notes:

- The multimedia system supports a total of up to 50,000 files.
- Data storage media up to 2 TB are supported (32-bit address space).

Supported formats:

- MP3
- WMA
- AAC
- WAV
- FLAC
- ALAC

**i** Observe the following notes:

- Due to the large variety of available music files regarding encoders, sampling rates and data rates, playback cannot always be guaranteed.
- Due to the wide range of USB devices available on the market, playback cannot be guaranteed for all USB devices.
- Copy-protected music files or DRM encrypted files cannot be played back.
- MP3 players must support Media Transfer Protocol (MTP).



Manufactured under license from Dolby Laboratories. Dolby, Dolby Audio and the double-D symbol are trademarks of Dolby Laboratories.



Gracenote, the Gracenote logo and logotype, "Powered by Gracenote", MusicID and Playlist Plus are either registered trademarks or trademarks of Gracenote, Inc. in the United States and/or other countries.



"Made for iPod", and "Made for iPhone," mean that an electronic accessory has been designed to connect specifically to iPod®, or iPhone®, respectively, and has been certified by the developer to meet Apple performance standards. Apple® is not responsible for the operation of this device or its compliance with safety and regulatory standards. Please note that the use of this accessory with iPod, or iPhone may affect wireless performance.

**For the USA:** iPhone®, iPod®, iPod classic®, iPod nano®, and iPod touch® are trademarks of Apple Inc., registered in the U.S. and other countries. Lightning® is a trademark of Apple Inc.

**For Canada:** iPhone®, iPod®, iPod classic®, iPod nano®, and iPod touch® are trademarks of Apple Inc., registered in the U.S. and other countries. Lightning® is a trademark of Apple Inc.

#### Notes on copyright

Audio files that you create or reproduce yourself for playback are generally subject to copyright protection. In many countries, reproductions, even for private use, are not permitted without the prior consent of the copyright holder. Make

sure that you know about the applicable copyright regulations and that you comply with these.

### Activating media mode

Multimedia system:

→ Media →  Media Sources

- ▶ Select a media source.  
Playable music files are played back.

### Inserting/removing an SD card

**⚠ DANGER** Risk of fatal injury from swallowing SD cards

SD cards are small parts.

They could be swallowed and lead to choking.

- ▶ Keep SD cards out of the reach of children.
- ▶ Seek medical attention immediately if an SD card has been swallowed.

**! NOTE** Damage due to high temperatures

High temperatures may damage the SD card.

- ▶ Remove the SD card after use and take it out of the vehicle.

Multimedia system:

→ Media →  Media Sources

▶▶ Mem. Card

### Inserting

The multimedia connection unit is located in the stowage compartment under the armrest.

- ▶ Insert the SD memory card into the SD card slot until it engages. The side with the contacts must face downwards.  
Playable music files are played back.

### Removing

- ▶ Press the SD card.
- ▶ Remove the SD card.



## Overview of the audio mode

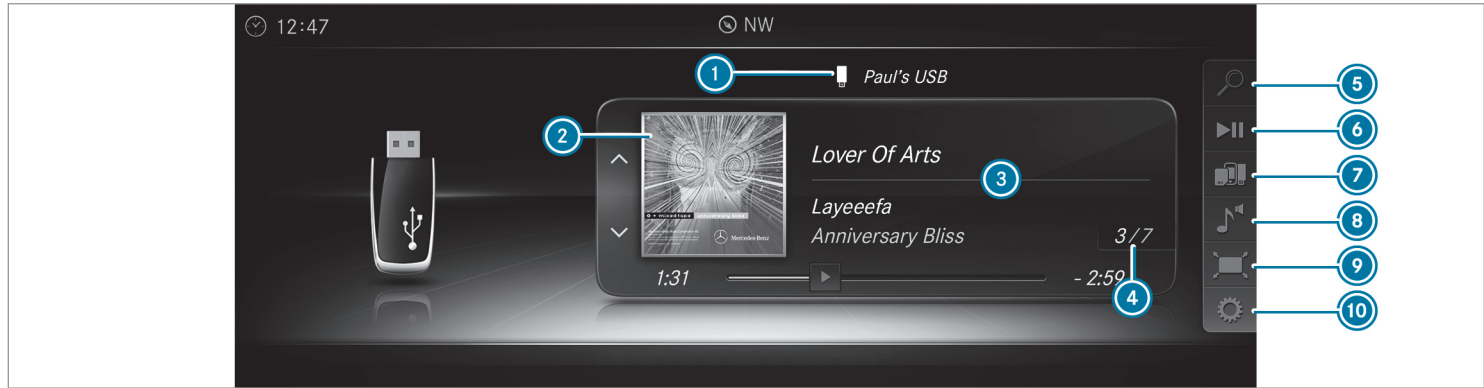

- ① Active data storage medium
- ② Album cover
- ③ Track, artist, album
- ④ Track number and number of tracks in the track list
- ⑤ Search
- ⑥ Playback Control
- ⑦ Media Sources
- ⑧ Sound
- ⑨ Full Screen (for video playback)
- ⑩ Options

## Connecting USB devices

**!** **NOTE** Damage caused by high temperatures

High temperatures can damage USB devices.

▶ Remove the USB device after use and take it out of the vehicle.

The multimedia connection unit is found in the storage compartment under the armrest and has two USB ports.

Depending on the vehicle's equipment, additional USB ports can be found in the storage compartment of the center console and in the rear passenger compartment.

▶ Connect the USB device to the USB port. Playable music files are played back only if the corresponding media display is activated.

- ① Use the USB port identified by  to use Apple CarPlay® and Android Auto.
- ① Depending on the vehicle equipment there is an additional USB port in the rear passenger compartment. Ports that are labeled with a battery symbol can only be used to charge USB devices.

### Selecting a track in the media playback

Multimedia system:

↳ **Media**

### Selecting a track by skipping to a track

▶ **To skip backwards or forwards to a track:** navigate up or down.

### Selecting a track using the current track list

- ▶ Select .
- ▶ Select **Current Track List**.
- ▶ Select a track.

### Selecting playback options

Multimedia system:

↳ **Media** ▶  **Options**

### Playing back similar tracks

- ▶ Select **Play Similar Tracks**.  
A track list with similar tracks is created and played back.

### Playback mode





- ▶ Select **Random Mode - Current Playlist**.  
The current track list is played in random order.
- ▶ Select **Random Mode - Current Medium**.  
All tracks on the active data storage medium are played in random order.
- ▶ Select **Normal Track Sequence**.  
The current track list is played in the order it appears on the data storage medium.

### Controlling media playback

Multimedia system:

↳ **Media** ▶  **Playback Control**

A bar with playback controls is shown.

- ▶ **To pause playback:** select and confirm  with the central control element. The  symbol is displayed.
- ▶ **To resume playback:** select and confirm  again with the central control element. The  symbol is displayed.

### To fast forward/rewind

- ▶ Move  on the timeline.

### To hide the playback controls

- ▶ Press the  button.

### Video mode

### Switching to video mode

Multimedia system:

↳ **Media** ▶  **Media Sources**

- ▶ Select a data storage medium.

- ▶ Search for and select video files or playlists with video files.  
Playable video files are played back.

The multimedia system supports the following formats:

- MPEG
- AVI, DivX, MKV
- MP4, M4V
- WMV

- ⓘ If the vehicle is traveling faster than 3 mph (5 km/h) the video image is hidden from the driver. If available, the channel and program information is continuously displayed.  
Due to the large variety of available video files regarding encoders, sampling rates and data transfer rates, playback cannot be guaranteed.  
Videos up to FullHD (1920x1080) are supported.  
Copy-protected video files or DRM (Digital Rights Management) encrypted files cannot be played back.

Overview of video mode

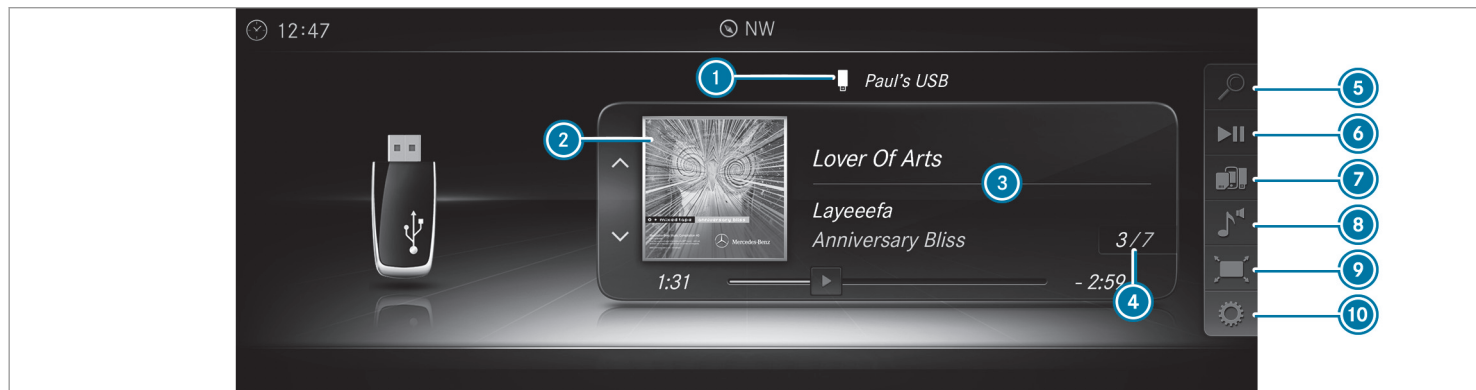

- ① Active data storage medium
- ② Album cover
- ③ Track, artist, album
- ④ Track number and number of tracks in the track list
- ⑤ Search
- ⑥ Playback Control

- ⑦ Media Sources
- ⑧ Sound
- ⑨ Full Screen (for video playback)
- ⑩ Options

**Activating/deactivating full-screen mode**

Multimedia system:

Media Sources

- ▶ Select a data storage medium. Playable video files are played back.
- ▶ **To activate full-screen mode:** select Full Screen.

- ▶ **To deactivate full-screen mode:** press the touchpad.

### Changing video settings

Multimedia system:

- ▶ Media ▶  Options
- ▶ Picture Format

The following picture formats are available:

- Automatic
- 16:9
- 4:3
- Zoom

- ▶ Select a picture format.

### Adjusting the brightness manually

If the **Automatic** picture format is switched off, you can adjust the brightness yourself.

- ▶ Select **Brightness**.
- ▶ Adjust the brightness.

## Media search

### Starting the media search

Multimedia system:

- ▶ Media ▶  Search

Depending on the connected media sources and files, the following categories are listed:

- Current Track List
- Keyword Search
- Playlists
- Artists
- Albums
- Tracks
- Folders
- Music Genres
- Year
- Composers
- Videos
- Podcasts (Apple® devices)
- Audiobooks (Apple® devices)
- ▶ Select a category.

- ⓘ The categories are available as soon as the entire media content has been read in and analyzed.

## Media Interface

### Information about the Media Interface

Media Interface is a universal interface for the connection of mobile audio equipment. The multimedia system has two USB ports. The USB ports are located in the stowage compartment under the armrest.

### Supported devices

The Media Interface allows you to connect the following data storage media:

- iPod®
- iPhone®
- MP3 player
- USB devices

For details and a list of supported devices, visit our website at <https://www.mercedes-benz.com/connect>. Follow the instructions in the "Media Interface" section.

### Switching to Media Interface

Multimedia system:

→ Media →  Media Sources

- ▶ Connect a data storage medium to the USB port (→ page 303).
- ▶ Select a media device.  
Playable music files are played back.

### Overview of Media Interface

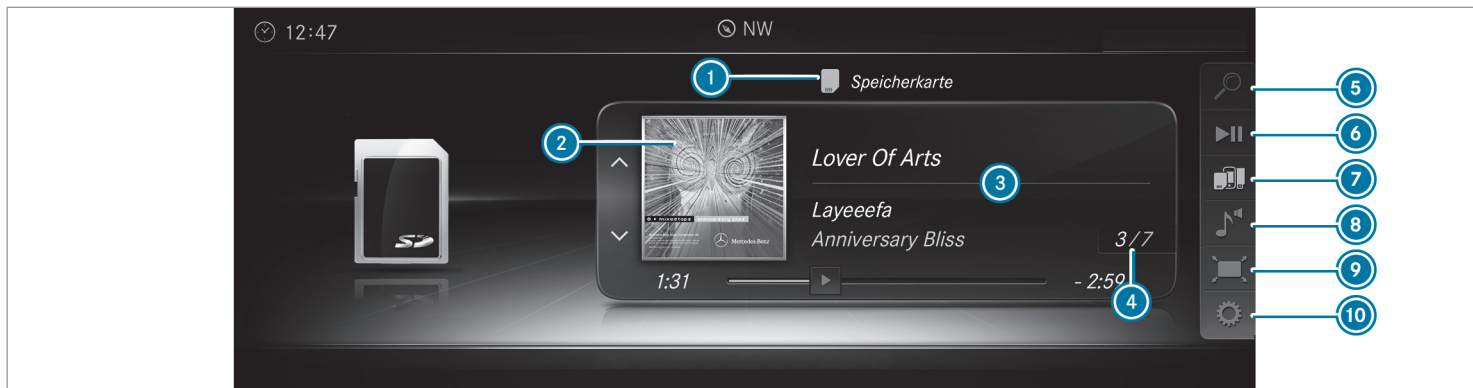

- ① Active data storage medium
- ② Album cover
- ③ Artist, track and album
- ④ Track number and number of tracks in the track list
- ⑤ Search
- ⑥ Playback Control
- ⑦ Media Sources
- ⑧ Sound
- ⑨ Full Screen (video playback only)
- ⑩ Options

## **Bluetooth® audio**

---

### **Information about Bluetooth® audio**

Before using your Bluetooth® audio equipment with the multimedia system for the first time, you will need to authorize it (→ page 310).

## Bluetooth® audio overview

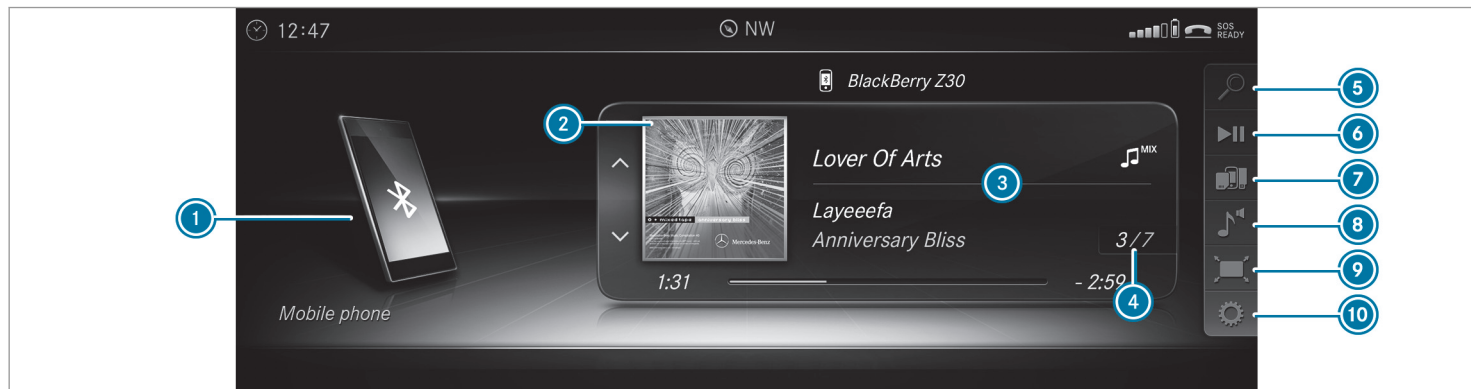

- ① Active data storage medium
- ② Album cover
- ③ Track, artist, album
- ④ Track number and number of tracks in the track list
- ⑤ Search
- ⑥ Playback Control
- ⑦ Media Sources
- ⑧ Sound
- ⑨ Full Screen (video playback only)
- ⑩ Options

### Searching for and authorizing a Bluetooth® audio device

#### Requirements:

- Bluetooth® is activated on the multimedia system and audio equipment (→ page 237).
- The audio equipment supports the Bluetooth® audio profiles A2DP and AVRCP.



- The audio equipment is "visible" for other devices.

Multimedia system:

↳ Media ▶  Media Sources  
 ▶  Bluetooth Audio

### Authorizing a new Bluetooth® audio device

- ▶ Select .
- ▶ Select **Add New Bluetooth Audio Device**.
- ▶ Select **Start Search on System**.  
Detected audio equipment is displayed in the device list.
- ▶ Select a Bluetooth® audio device.  
Authorization starts. A code is displayed on the multimedia system and on the mobile phone.
- ▶ If the codes are identical, confirm on the audio equipment.  
The audio equipment is connected and playback starts.

### Selecting previously authorized Bluetooth® audio equipment

- ▶ Select .
- ▶ Select a Bluetooth® audio device.

### Establishing a connection from the Bluetooth® audio equipment

The Bluetooth® device name of the multimedia system is **MB BLUETOOTH XXXXX**.

- ▶ Select **Search from Device**.
- ▶ Start the authorization on the audio equipment (see manufacturer's operating instructions).  
A code is displayed on the multimedia system and on the audio device.
- ▶ Confirm on both devices if the codes are identical.  
The audio equipment is connected and playback starts.

With some audio equipment, playback must be initially started on the device itself so that the multimedia system can play the audio files.

- ⓘ Device-specific information on authorizing and connecting Bluetooth®-capable mobile phones can be obtained at <https://www.mercedes-benz-mobile.com/> or at an authorized Mercedes-Benz Center.

### Activating Bluetooth® audio

Multimedia system:

↳ Media ▶  Media Sources

- ▶ Select  **Bluetooth Audio**.  
The multimedia system activates the connected Bluetooth® audio equipment.

### Selecting the media player on the Bluetooth® audio device

Multimedia system:

↳ Media ▶ 

- ▶ Select the **Bluetooth Audio Players** category.  
If multiple media players are present on the Bluetooth® audio equipment a list appears.
- ▶ Select a media player.  
Playback starts.

- ⓘ The function is not supported by every mobile phone.

### Searching for a music track on the Bluetooth® audio device

Multimedia system:

↳ Media ▶  Media Sources

▶  Bluetooth Audio

- ▶ Select .
- ▶ Select a category.  
A track list appears.
- ▶ Select a track.

 The function is only available when the mobile phone and the media player selected on the mobile phone support this function.

### Switching Bluetooth® audio equipment via NFC

#### Requirements:

- Observe the notes on using NFC (→ page 278).
- The Bluetooth® audio overview is displayed (→ page 310).

▶ Lightly press the NFC area on the mobile phone (see the manufacturer's operating instructions).

If the mobile phone has already been authorized on the multimedia system as Bluetooth® audio equipment, it is now connected.

If the mobile phone is authorized on the multimedia system as Bluetooth® audio equipment for the first time, it is connected after confirming the instructions on the mobile phone (see the manufacturer's operating instructions).

### Disconnecting Bluetooth® audio equipment

Multimedia system:

↳ Phone ▶  Media Sources

- ▶ Select the  symbol in the line of the mobile phone.  
The disconnection of the mobile phone takes place without a confirmation prompt. The mobile phone remains authorized in the system.

## Radio

### Switching on the radio

Multimedia system:

↳ Radio

- ▶ Alternatively: press the  button.  
The radio display appears. You will hear the last station played on the last frequency band selected.

## Radio overview



- ① Active frequency band
- ② Station name or set frequency
- ③ Artist, title, album and radio text
- ④ Station list
- ⑤ Presets
- ⑥ Radio Source
- ⑦ Sound

- ⑧ Options

### Switching the HD Radio function on/off

Multimedia system:

↳ Radio ▶ ⚙️ Options ▶ HD Radio



▶ Switch the function on  or off .

ⓘ HD Radio Technology manufactured under license from iBiquity Digital Corporation. U.S. and Foreign Patents. HD Radio™ and the HD, HD Radio and "Arc" logos are proprietary trademarks of iBiquity Digital Corp.

### Setting the waveband

Multimedia system:

↳ Radio ▶ 📻 Radio Source

HD Radio FM HD Radio AM and SiriusXM Radio can be selected.

▶ Select a frequency band.

### Selecting a radio station

Multimedia system:

↳ Radio

▶ Navigate up or down.

### Calling up the radio station list

Multimedia system:

↳ Radio ▶ 🔍

▶ Select a station.

### Searching for radio stations using station names or direct frequency entry

Multimedia system:

↳ Radio ▶ 🔍

▶ Enter a station name or frequency.

▶ Select .

The search results are displayed.

▶ Select a station.

### Storing radio stations

Multimedia system:

↳ Radio ▶ ⭐ Presets

▶ Select Store Current Station in the Presets.

### Managing radio station presets

Multimedia system:

↳ Radio ▶ ⭐ Presets

### Moving stations:

▶ Highlight a preset entry and navigate to the left.

- ▶ Select **Move Highlighted Station**.
- ▶ Select a memory preset.

#### Deleting stations:

- ▶ Highlight a preset entry and navigate to the left.
- ▶ Select **Delete Highlighted Station**.
- ▶ Select **Yes**.

#### Activating/deactivating radio text

Multimedia system:

- ↳ **Radio** ▶  **Options**
- ▶ **Display Radio Text Information**
- ▶ Activate  or deactivate  the function.

#### Satellite radio

##### Information on the satellite radio

SIRIUS XM<sup>®</sup> satellite radio offers more than 175 digital-quality radio channels providing 100% commercial-free music, sports, news and entertainment, for example. SIRIUS XM satellite radio employs a fleet of high-performance satellites to

broadcast around the clock throughout the USA and Canada. The satellite radio program is available for a monthly fee. Information about this can be obtained from a Sirius XM<sup>®</sup> Service Center and at <https://www.siriusxm.com> (USA) or <https://www.siriusxm.ca> (Canada).

- ① Sirius, XM and all related marks and logos are trademarks of Sirius XM Radio Inc. and its subsidiaries. All other marks, channel names and logos are the property of their respective owners. All rights reserved.

##### Satellite radio restrictions

Satellite radio mode may be temporarily unavailable or interrupted for a variety of reasons. These include environmental or topographical conditions beyond the control of Mercedes-Benz USA, LLC. Thus, operation at certain locations may not be possible.

##### Registering satellite radio

###### Requirements:

- Satellite radio equipment
- Registration with a satellite radio provider

- If registration is not included when purchasing the system, your credit card details will be required to activate your account.

Multimedia system:

- ↳ **Radio** ▶  **Radio Source**
- ▶ **SiriusXM Radio** ▶  **Options**

##### Select **Service Information**.

The service information screen appears showing the radio ID and the current subscription status.

▶ Establish a telephone connection.

▶ Follow the service staff's instructions. The activation process may take up to ten minutes.

- ① You can also have the satellite service activated online. To do so, please visit <https://www.siriusxm.com> (USA) or <https://www.siriusxm.ca> (Canada).

##### Switching on satellite radio

Multimedia system:

- ↳ **Radio** ▶  **Radio Source**
- ▶ Select **SiriusXM Radio**.

## Overview of the satellite radio





- ① Active frequency band
- ② Logo or cover picture for the song (if available)
- ③ Category
- ④ Channel name
- ⑤ Artist, track and album
- ⑥ SiriusXM Radio Channels

- ⑦ Presets
- ⑧ Radio Source
- ⑨ Sound
- ⑩ Playback Control
- ⑪ Options

### Selecting a satellite radio category

Multimedia system:

- Radio ➤  Radio Source
- SiriusXM Radio
-  SiriusXM Radio Channels ➤ Category
- Select a category.

### Selecting a satellite radio channel

Multimedia system:

- ↳ Radio >>  Radio Source
- >> SiriusXM Radio

- ▶ Navigate up or down.

### Saving or deleting a satellite radio channel

Multimedia system:

- ↳ Radio >>  Radio Source
- >> SiriusXM Radio >>  Presets

- ▶ Select Store Current Station in the Presets.

### Moving a channel

- ▶ Select Options.
- ▶ Select Move Highlighted Station.
- ▶ Select a memory preset.

### Deleting a channel

- ▶ Select Options.
- ▶ Select Delete Highlighted Station.
- ▶ Select a memory preset.

### Displaying EPG information for the current channel

Multimedia system:

- ↳ Radio >>  Radio Source
- >> SiriusXM Radio >>  Options

- ▶ Select EPG Information about Current Channel.

### Setting parental control for radio

Multimedia system:

- ↳ Radio >>  Radio Source
- >> SiriusXM Radio >>  Options
- >> Parental Control

- ▶ Activate the function .
- ▶ Determine a four-digit character sequence and select **ok**.
- All channels with adult content are locked.

### Unlocking a channel



- ▶ Enter the four-digit character sequence and select **ok**.
- All channels with adult content are unlocked.

### Music and sport alerts function

This function enables you to program an alert for your favorite artists, tracks or sporting events. Music alerts can be saved whilst a track is being played and sport alerts can be saved during a live game. You can also specify sport alerts via the menu option. The system then continuously searches through all the channels. If a match is found with a stored alert, you will be informed.

### Setting music and sport alerts

Multimedia system:

- ↳ Radio >>  Radio Source
- >> SiriusXM Radio >>  Options
- >> Alert for Artist, Song & Sporting Event

### Setting a music alert

- ▶ Select Add New Alert.

or

- ▶ Select Manage Artist & Song Alerts.
- ▶ Select  Options.

The following options are available:

- Mark This Entry
- Unmark This Entry

- [Mark All Entries](#)
- [Unmark All Entries](#)
- [Delete This Entry](#)
- [Delete All Entries](#)

▶ Select an option.

▶ [Activate Artist & Song Alerts](#) .

The alert is set for the current artist or track. If a match is found, a prompt appears asking whether you wish to change to the station.

#### Setting a sport alert

▶ Select [Add New Alert](#).

or

▶ Select [Manage Sports Alerts](#).

▶ Select [Select New Alerts](#).

or

▶ Select [Edit Alerts](#).

▶ Select a team from a league.

▶ [Activate Sports Alerts](#) .

#### Information on Smart Favorites and Tune Start

Stations in the station presets can be added as Smart Favorites. Smart Favorites stations are automatically saved to temporary storage in the background. If you change to a Smart Favorites station, you can replay, pause or actively skip forward or back to broadcasts which you have missed. If Tune Start is activated and you change to another Smart Favorites station, the music track currently playing on the station is automatically restarted from the beginning of the track.

#### Adding a channel to Smart Favorites

Multimedia system:

↳ [Radio](#) ▶  [Radio Source](#)  
▶ [SiriusXM Radio](#)

▶ Select the active frequency band.

▶ Highlight an entry.

▶ Select .

▶ Select [Add Highlighted Channel to Smart Favorites](#).

#### Activating/deactivating TuneStart

Multimedia system:

↳ [Radio](#) ▶  [Options](#) ▶ [TuneStart](#)

▶ Activate  or deactivate  the function.

#### Controlling playback

Multimedia system:

↳ [Radio](#) ▶  [Playback Control](#)

You can pause the playback of the current station or skip forward or backward in the timeline. This leaves live mode to access the internal temporary storage.

▶ **To fast forward/rewind:** turn the controller counter-clockwise or clockwise/swipe left or right on the touchpad.

▶ **To jump to the previous/next song:** press the controller left or right/swipe left or right on the touchpad.



▶ **To pause playback:** select .

▶ **To return to live mode:** navigate to the end of the timeline.



**Displaying satellite radio service information**

Multimedia system:

- ↳ Radio >>  Radio Source
- >> SiriusXM Radio >>  Options
- ▶ Select **Service Information**.

**Sound****Tone settings****Information about the sound system**

The sound system has a total output of 100 W and is equipped with five speakers. It is available for all functions in the radio and media modes.

- ⓘ The call can also be made from other audio sources. Replace Media with, for example, Radio in the menu path.

**Calling up the sound menu**

Multimedia system:

- ↳ Media >>  Sound

The following functions are available:

- Equalizer
- Balance and Fader

- Automatic Volume Adjustment
- Other Sound Settings

- ▶ Select a sound menu.

**Adjusting treble, mid-range and bass settings**

Multimedia system:

- ↳ Media >>  Sound >> Equalizer

- ▶ Select Treble, Mid Range or Bass.
- ▶ Change the settings.

**Activating/deactivating automatic volume adjustment**

Multimedia system:

- ↳ Media >>  Sound
- >> Automatic Volume Adjustment

Automatic volume adjustment compensates for differing volumes when changing between audio sources.

- ▶ Activate  or deactivate  the function.

**Adjusting the balance/fader**

Multimedia system:

- ↳ Media >>  Sound
- >> Balance and Fader

- ▶ Adjust the balance and fader.
- ▶ **To exit the menu:** press the  button.

**Burmester® surround sound system****Information about the Burmester® surround sound system**

The Burmester® surround sound system has a total output of 590 W and is equipped with 13 speakers. It is available for all functions in the radio and media modes.

- ⓘ The call can also be made from other audio sources. Replace Media with, for example, Radio in the menu path.

### Calling up the sound menu in the Burmester® surround sound system

Multimedia system:

↳ Media ▶  Sound

The following functions are available:

- Equalizer
- Balance and Fader
- Automatic Volume Adjustment
- Surround Sound
- Sound Focus
- Other Sound Settings

▶ Select a function.

### Adjusting the treble, mid and bass settings on the Burmester® surround sound system

Multimedia system:

↳ Media ▶  Sound ▶ Equalizer

- ▶ Select Treble, Mid Range or Bass.
- ▶ Set the desired values.

### Activating or deactivating volume adjustment in the Burmester® surround sound system

Multimedia system:

↳ Media ▶  Sound  
▶ Automatic Volume Adjustment

Automatic volume adjustment compensates for differing volumes when changing between audio sources.

▶ Activate  or deactivate  the function.

### Adjusting the balance/fader in the Burmester® surround sound system

Multimedia system:

↳ Media ▶  Sound  
▶ Balance and Fader

▶ Adjust the balance and fader.

▶ To exit the menu: press the  button.

### Switching surround sound on or off in the Burmester® surround sound system

Multimedia system:

↳ Media ▶  Sound  
▶ Surround Sound

▶ Activate  or deactivate  the function.

### Adjusting the sound focus in the Burmester® surround sound system

Multimedia system:

↳ Media ▶  Sound ▶ Sound Focus

▶ Adjust the sound focus.

### Advanced sound system

---

#### Information about the Advanced sound system

The Advanced sound system has a total output of 225 W and is equipped with nine speakers. It is available for all functions in the radio and media modes.

### Calling up the sound menu in the Advanced sound system

Multimedia system:

↳ Media ▶  Sound

The following functions are available:

- Equalizer
- Balance and Fader
- Automatic Volume Adjustment

▶ Select a function.

### Adjusting treble, mid-range and bass settings in the Advanced sound system

Multimedia system:

↳ Media ▶  Sound ▶ Equalizer

- ▶ Select **Treble**, **Mid Range** or **Bass**.
- ▶ Set the desired values.

### Switching volume adjustment in the Advanced sound system on/off

Multimedia system:

↳ Media ▶  Sound

▶ Automatic Volume Adjustment

Automatic volume adjustment compensates for differing volumes when changing between audio sources.

▶ Activate  or deactivate  the function.

### Setting the balance/fader in the Advanced sound system

Multimedia system:

↳ Media ▶  Sound

▶ Balance and Fader

▶ Adjust the balance and fader.

### ASSYST PLUS service interval display

#### Function of the ASSYST PLUS service interval display

The ASSYST PLUS service interval display on the Instrument Display provides information on the remaining time or distance before the next service due date.

You can hide this service display using the back button on the left-hand side of the steering wheel.

Depending on how the vehicle is used, the ASSYST PLUS service interval display may shorten the service interval, e.g. in the following cases:

- Mainly short-distance driving
- When the engine is often left idling for long periods
- In the event of frequent cold start phases

Mercedes-Benz recommends avoiding such operating conditions.

You can obtain information concerning the servicing of your vehicle from a qualified specialist

workshop, e.g. an authorized Mercedes-Benz Center.

#### Displaying the service due date

On-board computer:

↪ Service ▶▶ ASSYST PLUS

The next service due date is displayed.

▶ **To exit the display:** press the back button on the left-hand side of the steering wheel.

Bear in mind the following related topic:

- Operating the on-board computer (→ page 207).

#### Information on regular maintenance work

**!** **NOTE** Premature wear through failure to observe service due dates

Maintenance work which is not carried out at the right time or incompletely can lead to increased wear and damage to the vehicle.

- ▶ Adhere to the prescribed service intervals.
- ▶ Always have the prescribed maintenance work carried out at a qualified specialist workshop.

#### Special service requirements

The prescribed service interval is based on normal operation of the vehicle. Maintenance work will need to be performed more often if the vehicle is operated under arduous conditions or increased loads.

The ASSYST PLUS service interval display is only an aid. The driver of the vehicle bears responsibility as regards to whether maintenance work needs to be performed more often than specified based on the actual operating conditions and/or loads.

Examples of arduous operating conditions:

- regular city driving with frequent intermediate stops
- mainly short-distance driving

- frequent operation in mountainous terrain or on poor road surfaces
- when the engine is often left idling for long periods
- operation in particularly dusty conditions and/or if air-recirculation mode is frequently used

In these or similar operating conditions, have the interior air filter, engine air cleaner, engine oil and oil filter etc. changed more frequently. The tires must be checked more frequently if the vehicle is operated under increased loads. Further information can be obtained at a qualified specialist workshop.

### Battery disconnection periods

The ASSYST PLUS service interval display can calculate the service due date only when the battery is connected.

- ▶ Note down the service due date displayed on the instrument display before disconnecting the battery (→ page 322).

## Engine compartment

### Opening and closing the hood

- ⚠ **WARNING** Risk of accident due to driving with the hood unlocked

The hood may open and block your view.

- ▶ Never release the hood when driving.
- ▶ Before every trip, ensure that the hood is locked.

- ⚠ **WARNING** Risk of accident and injury when opening and closing the hood

The hood may suddenly drop into the end position.

There is a risk of injury for anyone in the hood's range of movement.

- ▶ Do not open or close the hood if there is a person in the hood's range of movement.

- ⚠ **WARNING** Risk of burns when opening the hood

If you open the hood when the engine has overheated or when there is a fire in the engine compartment, the following situations may occur:

- You could come into contact with hot gases.
- You could come into contact with other hot, escaping operating fluids.
- ▶ Before opening the hood, allow the overheated engine to cool down.
- ▶ In the event of a fire in the engine compartment, keep the hood closed and call the fire service.

- ⚠ **WARNING** Risk of injury due to moving parts

Components in the engine compartment may continue running or start up suddenly, even if the ignition is switched off.

Make sure of the following before performing tasks in the engine compartment:

- ▶ Switch the ignition off.
- ▶ Never reach into the danger zone surrounding moving components, e.g. the rotation area of the fan.
- ▶ Remove jewellery and watches.
- ▶ Keep items of clothing and hair away from moving parts.

**⚠ WARNING** Risk of injury from touching components under voltage

The ignition system and the fuel injection system work under high voltage. You could receive an electric shock.

- ▶ Never touch components of the ignition system or the fuel injection system when the ignition is switched on.

The live components include the following, for example:

- Ignition coils

- Spark plug connectors
- Injectors

**⚠ WARNING** Risk of burns from hot component parts in the engine compartment

Certain component parts in the engine compartment can be very hot, e.g. the engine, the cooler and parts of the exhaust system.

- ▶ Allow the engine to cool down and only touch component parts described in the following.

**⚠ WARNING** Risk of injury from using the windshield wipers while the engine hood is open

When the engine hood is open and the windshield wipers are set in motion, you can be trapped by the wiper linkage.

- ▶ Always switch off the windshield wipers and ignition before opening the engine hood.

### Opening the hood

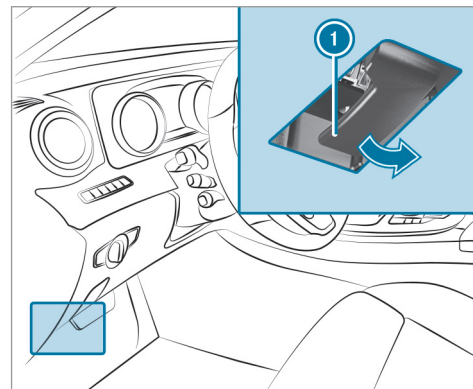

- ▶ To release the hood, pull on handle ①.

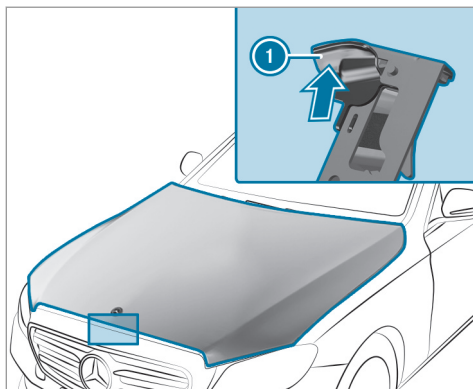

- ▶ Push handle ① of the hood catch upwards and lift the hood until it opens automatically.

### Closing the hood

- ▶ Lower the hood to a height of around 8 in (20 cm) and then allow it to fall, applying a little force as you let it go.

- ▶ If the hood can still be lifted slightly, open the hood again and close it with a little more force until it engages correctly.

### Engine oil

#### Checking the engine oil level using the oil dipstick

**⚠ WARNING** Risk of burns from hot component parts in the engine compartment

Certain component parts in the engine compartment can be very hot, e.g. the engine, the cooler and parts of the exhaust system.

- ▶ Allow the engine to cool down and only touch component parts described in the following.

#### Requirements:

- The engine has an oil dipstick. If not, the engine oil level can be checked only with the on-board computer (→ page 326) .

Depending on the engine, the oil dipstick may be installed in the engine compartment in different locations.

The waiting time before checking the oil level when the engine is at normal operating temperature is five minutes.

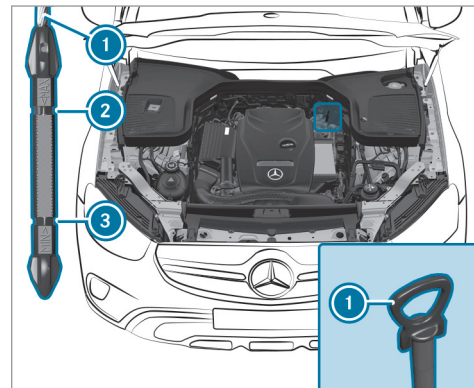

- ▶ Park the vehicle on a level surface.
- ▶ Pull oil dipstick ① out and wipe off.

- ▶ Slowly slide oil dipstick ① into the guide tube to the stop, and pull it out again after about three seconds.
  - Oil level is correct: oil level is between ② and ③.
  - Oil level too low: oil level is at ③ or below.
  - Oil level too high: oil level is above ②.
- ▶ If the oil level is too low, add 1.1 US qt (1 liter) of engine oil.
- ▶ If the oil level is too high, drain off excess engine oil. Consult a qualified specialist workshop.

### Checking the engine oil level using the on-board computer

#### Requirements:

- The engine has an oil level sensor. If not, the engine oil level can be checked only with the oil dipstick (→ page 325).
- The engine has been warmed up.
- The vehicle is parked on a level surface.
- The engine is running at idle speed.

- The hood is closed.

The engine oil level is determined during driving. Determining the engine oil level can take up to 30 minutes with a normal driving style and even longer with an active driving style.

On-board computer:

↪ Service ▶▶ Engine Oil Level

One of the following messages will appear on the multifunction display:

- **Measuring Engine Oil Level...:** measurement of the oil level is not yet possible.
- ▶ Repeat the request after a maximum of 30 minutes' driving.
- **Engine Oil Level OK** and the bar display for indicating the oil level on the multifunction display is green and is between "min" and "max": the oil level is correct.
- **Engine Oil Level Add 1.0 l** and the bar display for indicating the oil level on the multifunction display is orange and is below "min":
- ▶ Add 1.1 US qt (1 l) of engine oil.

- **Reduce Engine Oil Level** and the bar display for indicating the oil level on the multifunction display is orange and is above "max":

- ▶ Drain off any excess engine oil that has been added. To do so, consult a qualified specialist workshop.
- **For Engine Oil Level Switch Ignition On**
- ▶ Switch on the ignition to check the engine oil level.
- **Engine Oil Level System Inoperative:** The oil level sensor is defective or not connected.
- ▶ Consult a qualified specialist workshop.
- **Engine Oil Level System Currently Unavail.**
- ▶ Close the hood.

### Refilling engine oil

**⚠ WARNING** Risk of burns from hot component parts in the engine compartment

Certain component parts in the engine compartment can be very hot, e.g. the engine, the cooler and parts of the exhaust system.



- ▶ Allow the engine to cool down and only touch component parts described in the following.

**⚠ WARNING** Risk of fire and injury from engine oil

If engine oil comes into contact with hot component parts in the engine compartment, it may ignite.

- ▶ Make sure that no engine oil is spilled next to the filler opening.
- ▶ Allow the engine to cool off and thoroughly clean the engine oil from component parts before starting the vehicle.

**! NOTE** Engine damage caused by an incorrect oil filter, incorrect oil or additives

- ▶ Do not use engine oils or oil filters which do not correspond to the specifications explicitly prescribed for the service intervals.

- ▶ Follow the instructions on the service interval display for changing the engine oil and observe the prescribed change intervals.
- ▶ Do not use additives.

**! NOTE** Damage caused by refilling too much engine oil

Too much engine oil can damage the engine or the catalytic converter.

- ▶ Have excess engine oil removed at a qualified specialist workshop.

- i** Depending on driving style, the vehicle consumes up to 0.9 US qt (0.8 liter) of oil per 600 miles (1000 km). The oil consumption may be higher than this when the vehicle is new or if you frequently drive at high engine speeds.

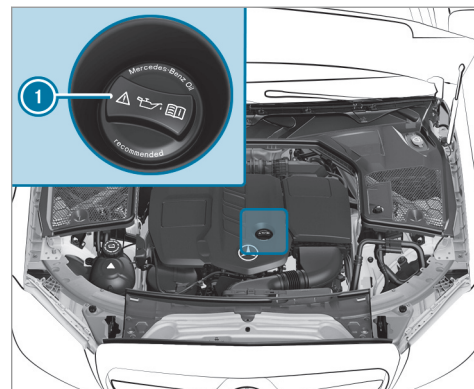

- ▶ Turn cap ① counter-clockwise and remove it.
- ▶ Add engine oil.
- ▶ Replace cap ① and turn it clockwise until it engages.
- ▶ Check the oil level again (→ page 325).

### Checking the coolant level

**⚠ WARNING** Risk of burns from hot component parts in the engine compartment

Certain component parts in the engine compartment can be very hot, e.g. the engine, the cooler and parts of the exhaust system.

- ▶ Allow the engine to cool down and only touch component parts described in the following.

**⚠ WARNING** Risk of scalding from hot coolant

If you open the cap, you could be scalded.

- ▶ Let the motor cool down before opening the cap.
- ▶ When opening the cap, wear protective gloves and safety glasses.
- ▶ Open the cap slowly to release pressure.

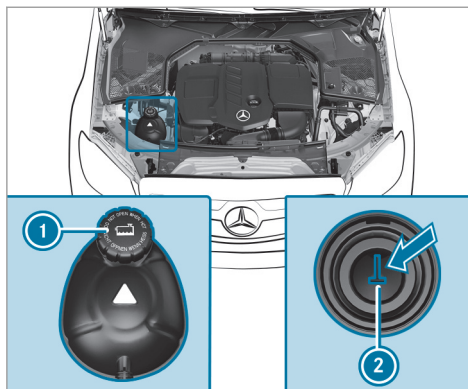

- ▶ Park the vehicle on a level surface.
- ▶ Check the coolant temperature display in the instrument cluster. The coolant temperature must be in the bottom quarter of the temperature display.
- ▶ Slowly turn cap ① counter-clockwise to release overpressure.

- ▶ Continue turning cap ① counter-clockwise and remove it.

The coolant level is correct in the following cases:

- If the engine is cold, the coolant is up to marker bar ②.
- If the engine is warm, the coolant is up to 0.6 in (1.5 cm) over marker bar ②.

- ▶ If necessary, add coolant that has been approved for Mercedes-Benz.

**i** Further information on coolant (→ page 397)

### Refilling the windshield washer system

**⚠ WARNING** Risk of burns from hot component parts in the engine compartment

Certain component parts in the engine compartment can be very hot, e.g. the engine, the cooler and parts of the exhaust system.

- ▶ Allow the engine to cool down and only touch component parts described in the following.

**⚠ WARNING** - Risk of fire and injury from windshield washer concentrate

Windshield washer concentrate is highly flammable. It could ignite if it comes into contact with hot engine component parts or the exhaust system.

- ▶ Make sure that no windshield washer concentrate spills out next to the filler opening.

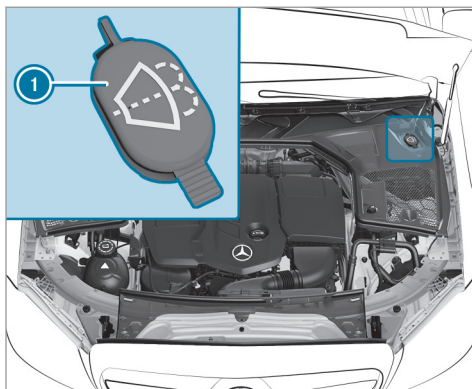

- ▶ Remove cap ① by the tab.
- ▶ Add washer fluid.
- ① Further information about the windshield washer fluid (→ page 397)

### Keeping the air-water duct free

- ▶ Keep the area between the hood and the windshield free of deposits, e.g. ice, snow and leaves.

### Cleaning and care

#### Notes on washing the vehicle in a car wash

- ⚠ WARNING** Risk of accident due to reduced braking effect after washing the vehicle

The braking effect is reduced after washing the vehicle.

- ▶ After the vehicle has been washed, brake carefully while paying attention to the traffic conditions until the braking effect has been fully restored.

**!** **NOTE** Damage from automatic braking

If one of the following functions is switched on, the vehicle brakes automatically in certain situations:

- Active Brake Assist
- Active Distance Assist DISTRONIC
- HOLD function
- Active Parking Assist

To avoid damage to the vehicle, deactivate these systems in the following or similar situations:

- ▶ During towing
- ▶ In a car wash

**!** **NOTE** Damage due to unsuitable car wash

- ▶ Before driving into a car wash make sure that the car wash is suitable for the vehicle dimensions.

- ▶ Ensure there is sufficient ground clearance between the underbody and the guide rails of the car wash.
- ▶ Ensure that the clearance width of the car wash, in particular the width of the guide rails, is sufficient.

To avoid damage to your vehicle when using a car wash, ensure the following beforehand:

- Active Distance Assist DISTRONIC is deactivated.
- The HOLD function is switched off.
- The surround view camera or the rear view camera is switched off.
- The side windows and sliding sunroof are completely closed.
- The blower for the ventilation/heating is switched off.
- The windshield wiper switch is in position **0**.
- The SmartKey is at a minimum distance of 10 ft (3 m) away from the vehicle. Otherwise the trunk lid could open unintentionally.

- For car washes with a conveyor system:
  - Neutral **N** is engaged.
  - If you would like to leave the vehicle while it is being washed, make sure the SmartKey is located in the vehicle. The park position **P** is otherwise automatically engaged.

- ⓘ If, after the car wash, you remove the wax from the windshield and wiper rubbers, this will prevent smearing and reduce wiper noise.

**Notes on using a power washer**

**!** **WARNING** Risk of an accident when using power washers with round-spray nozzles

The water jet can cause externally invisible damage.

Components damaged in this way may unexpectedly fail.

- ▶ Do not use a power washer with round-spray nozzles.
- ▶ Have damaged tires or chassis parts replaced immediately.

To avoid damage to your vehicle, observe the following when using a power washer:

- The SmartKey is at a minimum distance of 10 ft (3 m) away from the vehicle. Otherwise, the trunk lid could open unintentionally.
- Maintain a distance of at least 11.8 in (30 cm) to the vehicle.
- **Vehicles with decorative foil:** Parts of your vehicle are covered with a decorative foil. Maintain a distance of at least 27.6 in (70 cm) between the foil-covered parts of the vehicle and the nozzle of the power washer. Move the power washer nozzle around whilst cleaning. The water temperature of the power washer must not exceed 140°F (60°C).
- Observe the information on the correct distance in the equipment manufacturer's operating instructions.

- Do not direct the nozzle of the power washer directly at sensitive parts, such as tires, gaps, electrical components, batteries, light sources and ventilation slits.

### Washing the vehicle by hand

**!** **NOTE** Engine damage due to water ingress

- ▶ Take care not to point the water jet directly towards the air inlet grille below the hood.

Observe the legal requirements, e.g. in a number of countries, washing by hand is only permitted in specially designated wash bays.

- ▶ Use a mild cleaning agent, e.g. car shampoo.
- ▶ Wash the vehicle with lukewarm water using a soft car sponge. When doing so, do not expose the vehicle to direct sunlight.
- ▶ Carefully hose the vehicle off with water and dry using a chamois.

- ① Observe the notes on the care of vehicle parts (→ page 333).

### Notes on paintwork/matte finish paintwork care

Observe the notes on cleaning and care to avoid damaging the paintwork.

#### Paint

- Insect remains: soak with insect remover and rinse off the treated areas afterwards.
- Bird droppings: soak with water and rinse off afterwards.
- Tree resin, oils, fuels and greases: remove by rubbing gently with a cloth soaked in petroleum ether or lighter fluid.
- Coolant and brake fluid: remove with a damp cloth and clean water.
- Tar stains: use tar remover.
- Wax: use silicone remover.
- Do not attach stickers, films or similar materials.
- Remove dirt immediately, where possible.

### Matte finish

- Only use care products approved for Mercedes-Benz.
- Do not polish the vehicle and alloy wheels.
- Only use car washes that correspond to the latest engineering standards.
- Do not use car wash programs with a final hot wax treatment.
- Do not use paint cleaners, buffing or polishing products, gloss preservers, e.g. wax.
- Always have paintwork repairs carried out at a qualified specialist workshop.

### Notes on cleaning decorative foils

Observe the notes on matte finish care in the chapter "Notes on paintwork/matte finish paintwork care" (→ page 331). They also apply to matte decorative foils.

Observe the notes on cleaning decorative foils to avoid vehicle damage.

### Cleaning

- For cleaning, use plenty of water and a mild cleaning agent without additives or abrasive substances, e.g. a car shampoo approved for Mercedes-Benz.
- Remove dirt immediately, where possible, whilst avoiding rubbing too hard. There is otherwise a risk of damaging the decorative foil irreparably.
- If there is dirt on the finish or if the decorative foil is dull: use the Paint Cleaner recommended and approved for Mercedes-Benz.
- Insect remains: soak with insect remover and rinse off the treated areas afterwards.
- Bird droppings: soak with water and rinse off afterwards.
- To prevent water stains, dry a foil-wrapped vehicle with a soft, absorbent cloth after every car wash.

### Avoiding damage to the decorative foil

- The service life and color of decorative foils are impaired by:
  - Sunlight

- Temperature, e.g. hot air blower
- Weather conditions
- Stone chippings and dirt
- Chemical cleaning agents
- Oily products
- Do not use polish on matte decorative foil. Polishing will have the effect of shining the foil-wrapped surface.
- Do not treat matte or structured decorative foils with wax. Permanent stains may occur.

Scratches, corrosive deposits, areas affected by corrosion and damage caused by incorrect care cannot always be completely repaired. In such cases, visit a qualified specialist workshop.

You can obtain more information on care and cleaning products from the manufacturer.

In the case of foil-wrapped surfaces, optical differences may occur between the surfaces that were not protected by a decorative foil after removing a decorative foil.

- ① Have work or repairs to decorative foils carried out at a qualified specialist workshop, e.g. at an authorized Mercedes-Benz Center.

### Notes on care of vehicle parts

**⚠ WARNING** Risk of entrapment if the windshield wipers are switched on while the windshield is being cleaned

If the windshield wipers are set in motion while you are cleaning the windshield or wiper blades, you can be trapped by the wiper arm.

- ▶ Always switch off the windshield wipers and the ignition before cleaning the windshield or wiper blades.

**⚠ WARNING** Risk of burns from the tailpipe and tailpipe trims

The exhaust tailpipe and tailpipe trims can become very hot. If you come into contact with these parts of the vehicle, you could burn yourself.

- ▶ Always be particularly careful around the tailpipe and the tailpipe trims and supervise children especially closely in this area.
- ▶ Allow vehicle parts to cool down before touching them.

To avoid damage to the vehicle, observe the notes on cleaning and care of the following vehicle parts:

#### Wheels and rims

- Use water and acid-free alloy wheel cleaners.
- Do not use acidic alloy wheel cleaners to remove brake dust. This could damage wheel bolts and brake components.
- To avoid corrosion of the brake discs and brakepads, drive the vehicle for a few minutes after cleaning before parking it. The brake discs and brakepads warm up and dry out.

#### Windows

- Clean the windows inside and outside with a damp cloth and with a cleaning agent recommended for Mercedes-Benz.
- Do not use dry cloths or abrasive or solvent-based cleaning agents to clean the inside of windows.
- ① Remove external fogging or dirt on the windshield in front of the multifunction camera. Otherwise, driving systems and driving safety systems may be impaired or not available (→ page 155).

#### Wiper blades

- Move the wiper arms into the replacement position (→ page 119).
- With the wiper arms folded out, clean the wiper blades with a damp cloth.
- Do not clean the wiper blades too often.

#### Exterior lighting

- Clean the lenses with a wet sponge and mild cleaning agent, e.g. car shampoo.
- Only use cleaning agents or cleaning cloths that are suitable for plastic lenses.

### Sensors

- Clean the sensors in the front and rear bumpers with a soft cloth and car shampoo (→ page 155).
- When using a power washer, maintain a minimum distance of 11.8 in (30 cm).

### Rear view camera and surround view camera

- Open the camera cover with the multimedia system (→ page 195).
- Use clean water and a soft cloth to clean the camera lens.
- Do not use a power washer.

### Tailpipes

- Clean with a cleaning agent recommended for Mercedes-Benz, especially in the winter and after washing the vehicle.
- Do not use acidic cleaning agents.

### Notes on care of the interior

**⚠ WARNING** Risk of injury from plastic parts breaking off after the use of solvent-based care products

Care and cleaning products containing solvents can cause surfaces in the cockpit to become porous. When the airbags are deployed, plastic parts may break away.

- ▶ Do not use any care or cleaning products containing solvents to clean the cockpit.

**⚠ WARNING** Risk of injury or death from bleached seat belts

Bleaching or dyeing seat belts can severely weaken them.

This can, for example, cause seat belts to tear or fail in an accident.

- ▶ Never bleach or dye seat belts.

To avoid damage to the vehicle, observe the following notes on cleaning and care:

### Seat belts

- Clean with lukewarm and soapy water.
- Do not use chemical cleaning agents.
- Do not dry by heating them to over 176°F (80°C) or exposing them to direct sunlight.

### Display

- Switch off the display and let it cool down.
- Clean the surface carefully with a microfiber cloth and a suitable display care product (TFT-LCD).
- Do not use any other agents.

### Plastic trim

- Clean with a damp microfiber cloth.
- For heavy soiling: use a cleaner recommended for Mercedes-Benz.
- Do not attach stickers, films or similar materials.
- Do not allow cosmetics, insect repellent or sun cream to come in contact with the plastic trim.

### Real wood and trim elements

- Clean with a microfiber cloth.



- Black piano-lacquer look: clean with a damp cloth and soapy water.
- For heavy soiling: use a cleaner recommended for Mercedes-Benz.
- Do not use solvent-based cleaning agents, polishes or waxes.

#### Headliner

- Clean with a brush or dry shampoo.

#### Carpet

- Use a carpet and textile cleaning agent recommended for Mercedes-Benz.

#### Steering wheel made of genuine leather or DINAMICA

##### **!** NOTE Damage caused by wrong cleaners

▶ Do not use solvent-based cleaning agents such as tar remover or wheel cleaner; neither should you use polishes or waxes. Otherwise you may damage the finish.

- Clean with a damp cloth and 1% soapy water solution and then wipe with a dry cloth.

- For heavy soiling: use a cleaner recommended for Mercedes-Benz.
- Leather care: use a leather care agent that has been recommended for Mercedes-Benz.
- Do not allow the leather to become too damp.
- Do not use a microfiber cloth.

**i** Leather is a natural product. It has natural surface properties, such as differences in structure, marks caused by growth and injury or subtle color differences.

#### Genuine leather seat covers

- Clean with a damp cloth and then wipe with a dry cloth.
- Leather care: use a leather care agent that has been recommended for Mercedes-Benz.
- Do not allow the leather to become too damp.
- Do not use a microfiber cloth.

#### DINAMICA seat covers

- Clean with a damp cloth.
- Do not use a microfiber cloth.

#### Imitation leather seat covers

- Clean with a damp cloth and 1% soapy water.
- Do not use a microfiber cloth.

#### Fabric seat covers

- Clean with a damp microfiber cloth and 1% soapy water and allow to dry.

## Emergency

### Removing the safety vest

The safety vests are located in the stowage compartments in the driver and front passenger door.

- ▶ **To remove:** pull out safety vest bag by loop.
- ▶ Open the safety vest bag and pull out the safety vest.

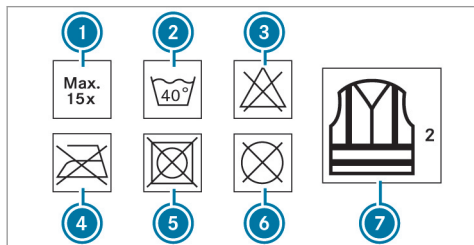

- ① Maximum number of washes
- ② Maximum wash temperature
- ③ Do not bleach
- ④ Do not iron

- ⑤ Do not tumble dry
- ⑥ Do not dry clean
- ⑦ Class 2 safety vest

The requirements defined by the legal standard are only fulfilled if the safety vest is the correct size and is fully closed.

The safety vest must be replaced in the following situations:

- The reflective strips are damaged or dirty
- The maximum permissible number of washes is exceeded
- The fluorescence has faded

## Warning triangle

### Removing the warning triangle

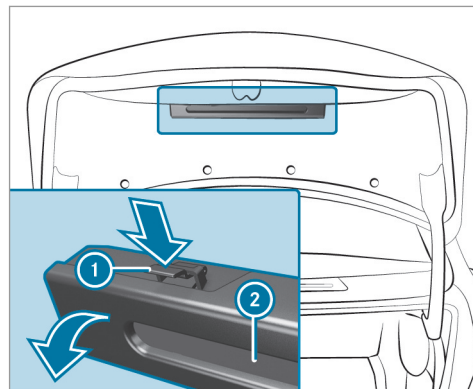

- ▶ Push both sides of warning triangle holder ① in the direction of the arrow and open it.
- ▶ Remove warning triangle ②.

### Setting up the warning triangle

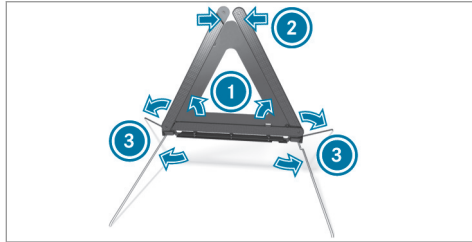

- ▶ Fold side reflectors ① upwards to form a triangle and attach at the top using upper press-stud ②.
- ▶ Fold legs ③ down and out to the side.

### First-aid kit (soft-sided) overview

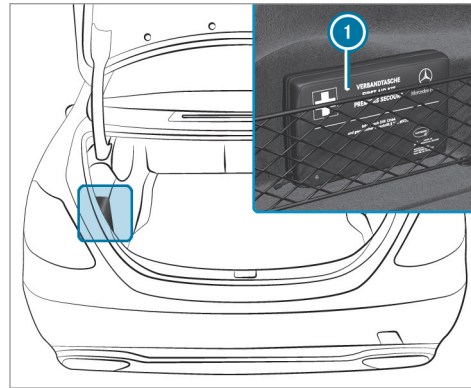

First-aid kit (soft sided) ① is in the trunk in the left-hand or right-hand storage net, depending on the model.

### Flat tire

#### Notes in the event of a flat tire

**⚠ WARNING** Risk of accident due to a flat tire

A flat tire severely affects the driving characteristics as well as the steering and braking of the vehicle.

#### Tires without run-flat characteristics:

- ▶ Do not drive with a flat tire.
- ▶ Change the flat tire immediately with an emergency spare wheel or spare wheel. Alternatively, consult a qualified specialist workshop.

#### Tires with run-flat characteristics:

- ▶ Observe the information and warning notes on MOExtended tires (run-flat tire).

In the event of a flat tire, the following options are available depending on your vehicle's equipment:

- **Vehicles with MOExtended tires:** it is possible to continue the journey for a short period of time. Make sure you observe the notes on MOExtended tires (run-flat tires) (→ page 338).
  - **Vehicles with a TIREFIT kit:** you can repair the tire so that it is possible to continue the journey for a short period of time. To do this, use the TIREFIT kit (→ page 339).
  - **Vehicles with Mercedes me connect:** you can make a call for breakdown assistance via the overhead control panel in the case of a breakdown (→ page 289).
  - **All vehicles:** change the wheel (→ page 382).
- i** The emergency spare wheel is only available in certain countries.

### Notes on MOExtended tires (run-flat tires)

**⚠ WARNING** Risk of accident when driving in limp-home mode

When driving in emergency mode the handling characteristics are impaired.

- ▶ Do not exceed the specified maximum speed of the MOExtended tires.
- ▶ Avoid any abrupt steering and driving maneuvers as well as driving over obstacles (curbs, pot holes, off-road). This applies, in particular, to a loaded vehicle.
- ▶ Stop driving in the emergency mode if you notice:
  - Banging noise
  - Vehicle vibration
  - Smoke which smells like rubber
  - Continuous ESP® intervention
  - Cracks in the tire side walls
- ▶ After driving in emergency mode, have the rims checked by a qualified special-

ist workshop with regard to their further use.

- ▶ The defective tire must be replaced in every case.

With MOExtended tires (run-flat tires), you can continue to drive your vehicle even if there is a total loss of pressure in one or more tires. However, the tire affected must not show any clearly visible damage.

You can recognize MOExtended tires by the MOExtended marking which appears on the side wall of the tire.

**Vehicles with tire pressure loss warning system:** MOExtended tires may only be used in conjunction with an activated tire pressure loss warning system.

**Vehicles with tire pressure monitoring system:** MOExtended tires may only be used in conjunction with an activated tire pressure monitoring system.

If a pressure loss warning message appears in the multifunction display, proceed as follows:

- Check the tires for damage.
- If driving on, observe the following notes.

#### Driving distance possible in emergency mode after the pressure loss warning:

Load condition	Driving distance possible in emergency mode
Partially laden	50 miles (80 km)
Fully laden	19 miles (30 km)

The driving distance possible in emergency mode may vary depending on the driving style. Observe the maximum permissible speed of 50 mph (80 km/h).

If a tire has gone flat and cannot be replaced with an MOExtended tire, you can use a standard tire as a temporary measure.

#### TIREFIT kit storage location

The TIREFIT kit is located under the trunk floor.

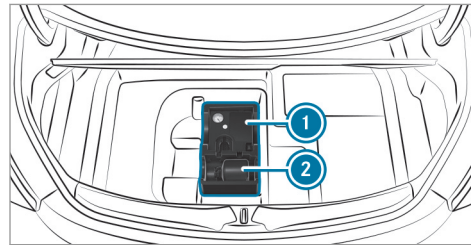

- ① Tire inflation compressor
- ② Tire sealant bottle

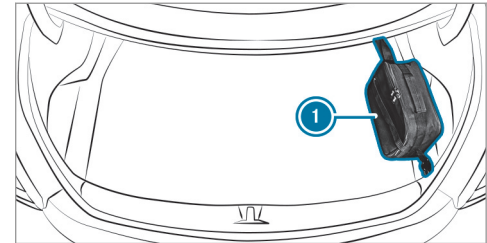

- ① Bag

Depending on the model, the TIREFIT kit may also be located in other places under the cargo compartment floor or in bag ① in the trunk.

#### Using the TIREFIT kit

##### Requirements:

- Tire sealant bottle
- TIREFIT sticker
- Tire inflation compressor
- Gloves (depending on the vehicle equipment)

## 340 Breakdown assistance

TIREFIT kit storage location: (→ page 339)

You can use TIREFIT tire sealant to seal perforation damage of up to 0.16 in (4 mm), particularly those in the tire contact surface. You can use TIREFIT in outside temperatures down to -4 °F (-20 °C).

### **⚠ WARNING** Risk of accident when using tire sealant

The tire sealant may be unable to seal the tire properly, especially in the following cases:

- There are cuts or punctures in the tire larger than damage previously mentioned.
  - The wheel rim is damaged.
  - You have driven at very low tire pressure or on a flat tire.
- ▶ Do not continue driving.
- ▶ Consult a qualified specialist workshop.

### **⚠ WARNING** Risk of injury and poisoning from tire sealant

The tire sealant is harmful and causes irritation. Do not allow it to come into contact with the skin, eyes or clothing, and do not swallow it. Do not inhale tire sealant fumes. Keep the tire sealant away from children.

If you come into contact with the tire sealant, observe the following:

- ▶ Rinse off the tire sealant from your skin immediately using water.
- ▶ If tire sealant gets into your eyes, thoroughly rinse out the eyes using clean water.
- ▶ If tire sealant has been swallowed, immediately rinse out the mouth thoroughly and drink plenty of water. Do not induce vomiting and seek medical attention immediately.
- ▶ Change out of any clothes contaminated with tire sealant immediately.
- ▶ If allergic reactions occur, seek medical attention immediately.

### **! NOTE** Overheating due to the tire inflation compressor running too long

- ▶ Do not run the tire inflation compressor for longer than ten minutes without interruption.

Comply with the manufacturer's safety notes on the sticker on the tire inflation compressor.

Have the tire sealant bottle replaced in a qualified specialist workshop every five years.

- ▶ Do not remove any foreign objects which have entered the tire.

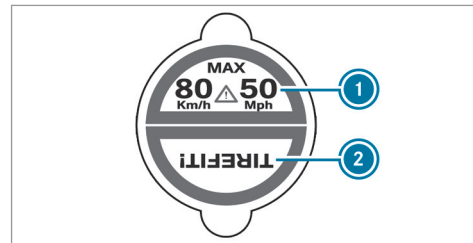

- ▶ Affix part ① of the TIREFIT sticker to the instrument cluster within the driver's field of vision.
- ▶ Affix part ② of the TIREFIT sticker near the valve on the wheel with the faulty tire.

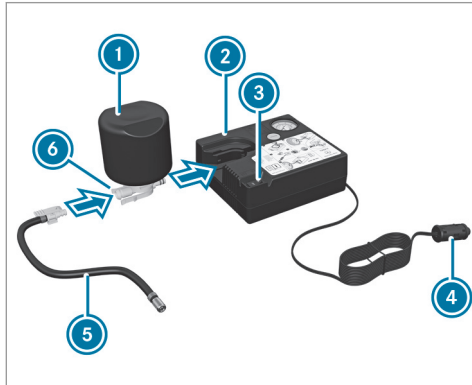

- ▶ Pull plug ④ with the cable and hose ⑤ out of the tire inflation compressor housing.

- ▶ Push the plug of hose ⑤ into flange ⑥ of tire sealant bottle ① until the plug engages.
- ▶ Place tire sealant bottle ① head downwards into recess ② of the tire inflation compressor.



- ▶ Remove the cap from valve ⑦ on the faulty tire.
- ▶ Screw filling hose ⑧ onto valve ⑦.
- ▶ Insert plug ④ into a 12 V socket in your vehicle.
- ▶ Switch on the ignition.

- ▶ Press on and off switch ③ on the tire inflation compressor. The tire inflation compressor is switched on. The tire is inflated. First, tire sealant is pumped into the tire. The pressure may briefly rise to approximately 500 kPa (5 bar/73 psi).

#### Do not switch off the tire inflation compressor during this phase!

- ▶ Let the tire inflation compressor run for a maximum of ten minutes. The tire should then have attained a tire pressure of at least 200 kPa (2.0 bar/29 psi).

If tire sealant leaks out, make sure you clean the affected area as quickly as possible. It is preferable to use clean water.

If you get tire sealant on your clothing, have it cleaned as soon as possible with perchloroethylene.

**If, after ten minutes, a tire pressure of 200 kPa (2.0 bar/29 psi) has not been attained:**

- ▶ Switch off the tire inflation compressor.
- ▶ Unscrew the filling hose from the valve of the faulty tire.

Please note that tire sealant may leak out when unscrewing the filling hose.

- ▶ Very slowly drive forwards or reverse approximately 33 ft (10 m).
- ▶ Pump up the tire again.  
After a maximum of ten minutes the tire pressure must be at least 200 kPa (2.0 bar/29 psi).

**⚠ WARNING** Risk of accident due to the specified tire pressure not being attained

If the minimum tire pressure is not reached after the specified time, the tire is too badly damaged. The tire sealant cannot repair the tire in this instance.

The braking and driving characteristics may be greatly impaired.

- ▶ Do not continue driving.
- ▶ Consult a qualified specialist workshop.

**If, after ten minutes, a tire pressure of 200 kPa (2.0 bar/29 psi) has been attained:**

**⚠ WARNING** Risk of accident from driving with sealed tires

A tire temporarily sealed with tire sealant impairs the handling characteristics and is not suitable for higher speeds.

- ▶ Adapt your driving style accordingly and drive carefully.
- ▶ Do not exceed the maximum speed limit with a tire that has been repaired using tire sealant.

- ▶ Observe the maximum permissible speed for a tire sealed with tire sealant 50 mph (80 km/h).
- ▶ Affix the upper section of the TIREFIT sticker to the instrument cluster in a location where it will be easily seen by the driver.

**! NOTE** Staining caused by leaking tire sealant

After use, excess tire sealant may leak out from the filling hose.

- ▶ Therefore, place the filling hose in the plastic bag that contained the TIREFIT kit.

**🔥 ENVIRONMENTAL NOTE** Environmental pollution caused by environmentally irresponsible disposal

Tire sealant contains pollutants.

- ▶ Have the tire sealant bottle disposed of professionally, e.g. at an authorized Mercedes-Benz Center.

- ▶ Switch off the tire inflation compressor.
- ▶ Unscrew the filling hose from the valve of the faulty tire.
- ▶ Store the tire sealant bottle and the tire inflation compressor.
- ▶ **Pull away immediately.**



- ▶ Stop driving after approximately ten minutes and check the tire pressure using the tire inflation compressor. The tire pressure must now be at least 130 kPa (1.3 bar/ 19 psi).

**⚠ WARNING** Risk of accident due to the specified tire pressure not being attained

If the specified tire pressure is not reached, the tire is too badly damaged. The tire sealant cannot repair the tire in this instance.

The braking and driving characteristics may be greatly impaired.

- ▶ Do not continue driving.
- ▶ Consult a qualified specialist workshop.

In cases such as the one mentioned above, contact an authorized Mercedes-Benz Center. Or call 1-800-FOR-MERCEDES (in the USA) or 1-800-387-0100 (in Canada).

- ▶ Correct the tire pressure if it is still at least 130 kPa (1.3 bar/ 19 psi). See the Tire and Loading Information placard on the B-pillar

on the driver's side or the tire pressure table in the fuel filler flap for values.

- ▶ **To increase the tire pressure:** switch on the tire inflation compressor.

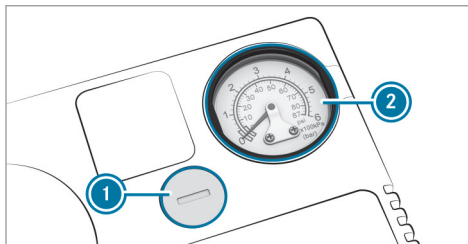

- ▶ **To reduce the tire pressure:** press pressure release button ① next to manometer ②.
- ▶ When the tire pressure is correct, unscrew the filling hose from the valve of the sealed tire.
- ▶ Screw the valve cap onto the valve of the sealed tire.

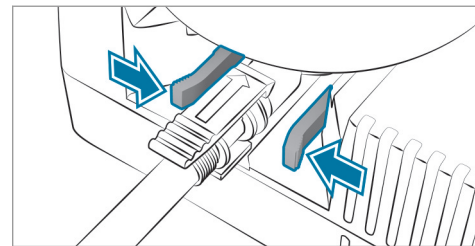

- ▶ Pull the tire sealant bottle out of the tire inflation compressor. Press the locking tabs on the yellow cap together to do this. The filling hose stays on the tire sealant bottle.
- ▶ Drive to the nearest qualified specialist workshop and have the tire, tire sealant bottle and filling hose replaced there.

**Battery (vehicle)****Notes on the 12 V battery**

**⚠ WARNING** Risk of an accident due to work carried out incorrectly on the battery

Work carried out incorrectly on the battery can, for example, lead to a short circuit. This can restrict functions relevant for safety systems and impair the operating safety of your vehicle.

You could lose control of the vehicle in the following situations in particular:

- When braking
- In the event of abrupt steering maneuvers and/or when the vehicle's speed is not adapted to the road conditions
- ▶ In the event of a short circuit or a similar incident, contact a qualified specialist workshop immediately.
- ▶ Do not drive on.

▶ Always have work on the battery carried out at a qualified specialist workshop.

- Further information on ABS (→ page 157)
- Further information on ESP® (→ page 158)

For safety reasons, Mercedes-Benz recommends that you only use batteries which have been tested and approved for your vehicle by Mercedes-Benz.

**All vehicles except vehicles with a lithium-ion battery**

**⚠ WARNING** Risk of explosion due to electrostatic charge

Electrostatic charge can ignite the highly explosive gas mixture in the battery.

- ▶ To discharge any electrostatic charge that may have built up, touch the metal vehicle body before handling the battery.

The highly flammable gas mixture is created while the battery is charging and during starting assistance.

**⚠ WARNING** Danger of chemical burns from the battery acid

Battery acid is caustic.

- ▶ Avoid contact with the skin, eyes or clothing.
- ▶ Do not lean over the battery.
- ▶ Do not inhale battery gases.
- ▶ Keep children away from the battery.
- ▶ Immediately rinse battery acid off thoroughly with plenty of clean water and seek medical attention immediately.

**All vehicles**

**ENVIRONMENTAL NOTE** Environmental damage caused by improper disposal of batteries



Batteries contain pollutants. It is illegal to dispose of them with the household rubbish.



Dispose of batteries in an environmentally responsible manner. Take discharged batteries to a qualified specialist workshop or to a collection point for used batteries.

If you have to disconnect the 12 V battery, contact a qualified specialist workshop.

Comply with safety notes and take protective measures when handling batteries.



Risk of explosion.



Fire, open flames and smoking are prohibited when handling the battery. Avoid creating sparks.



Electrolyte or battery acid is corrosive. Avoid contact with the skin, eyes or clothing. Wear suitable protective clothing, in particular gloves, an apron and a face mask. Immediately rinse electrolyte or acid splashes off with clean water. Consult a doctor if necessary.



Wear safety glasses.



Keep children away.



Observe this Operator's Manual.

Observe the following if you do not intend to use the vehicle over an extended period of time:

- Activate standby mode.
- Alternatively: connect the battery to a battery charger approved by Mercedes-Benz or consult a qualified specialist workshop to disconnect the battery.

### Notes on starting assistance and charging the 12 V battery

#### Vehicles with a lithium-ion battery

When charging the battery and during starting assistance, always use the jump-start connection point in the engine compartment.

**!** **NOTE** Damage to the battery from over-voltage

When charging using a battery charger without a maximum charging voltage, the battery or the on-board electronics may be damaged.

- ▶ Only use battery chargers with a maximum charging voltage of 14.8 V.

#### All other vehicles

When charging the battery and during starting assistance, always use the jump-start connection point in the engine compartment.

**!** **NOTE** Damage to the battery from over-voltage

When charging using a battery charger without a maximum charging voltage, the battery or the on-board electronics may be damaged.

- ▶ Only use battery chargers with a maximum charging voltage of 14.8 V.

**!** **WARNING** Risk of explosion from hydrogen gas igniting

There is a danger of hydrogen gas igniting when charging the battery if there is a short circuit or sparks start to form.

- ▶ Make sure that the positive terminal of the connected battery does not come into contact with vehicle parts.
- ▶ Never place metal objects or tools on a battery.
- ▶ The described order of the battery clamps must be observed when connecting and disconnecting the battery.
- ▶ When giving starting assistance, always make sure that you only connect battery terminals with identical polarity.
- ▶ During starting assistance, you must observe the described order for connecting and disconnecting the jumper cable.
- ▶ Do not connect or disconnect the battery clamps while the engine is running.

**!** **WARNING** Risk of explosion during charging process and starting assistance

During the charging process and starting assistance, the battery may release an explosive gas mixture.

- ▶ Avoid fire, open flames, creating sparks and smoking.
- ▶ Make sure there is sufficient ventilation.
- ▶ Do not lean over a battery.

**!** **WARNING** Risk of explosion from a frozen battery

A discharged battery may freeze at temperatures slightly above or below freezing point.

During starting assistance or battery charging, battery gas can be released.

- ▶ Always allow a battery to thaw before charging it or performing starting assistance.

If the indicator/warning lamps in the instrument cluster do not light up at low temperatures, it is very likely that the discharged battery has frozen. In this case you may neither jump-start the vehicle nor charge the battery.

The service life of a battery that has been thawed may be dramatically shortened. The starting characteristics may be impaired, especially at low temperatures.

It is recommended that you have a thawed battery checked at a qualified specialist workshop.

#### All vehicles

**!** **NOTE** Damage caused by numerous or extended attempts to start the engine

Numerous or extended attempts to start the engine may damage the catalytic converter due to non-combusted fuel.

▶ Avoid numerous and extended attempts to start the engine.

Observe the following points during starting assistance and when charging the battery:

- Only use undamaged jumper cables/charging cables with a sufficient cross-section and insulated terminal clamps.
- Non-insulated parts of the terminal clamps must not come into contact with other metal parts while the jumper cable/charging cable is connected to the battery/jump-start connection point.
- The jumper cable/charging cable must not come into contact with any parts which may move when the engine is running.
- Always make sure that neither you nor the battery is electrostatically charged.
- Keep away from fire and open flames.
- Do not lean over the battery.

Observe the additional following points when charging the battery:

- Only use battery chargers tested and approved for Mercedes-Benz.
- Read the battery charger's operating instructions before charging the battery.

Observe the additional following points during starting assistance:

- Starting assistance may only be provided using vehicles, batteries or other jump start devices with a nominal voltage of 12 V.
- The vehicles must not touch.
- **Vehicles with a gasoline engine:** Jump start the vehicle only when the engine and exhaust system are cold.

#### Starting assistance and charging the 12 V battery

##### Preparing starting assistance/charging

- ▶ Secure the vehicle by applying the electric parking brake.
- ▶ **Automatic transmission:** Shift the transmission to position **P**.
- ▶ **Manual transmission:** Shift the transmission to neutral.
- ▶ Switch off the ignition and all electrical consumers.
- ▶ Open the hood.

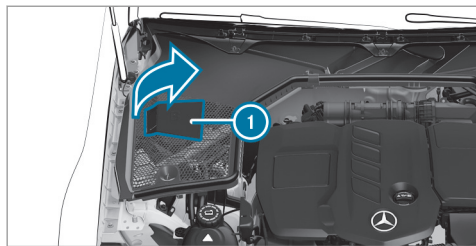

- ▶ Fold cover ① up in the direction of the arrow.

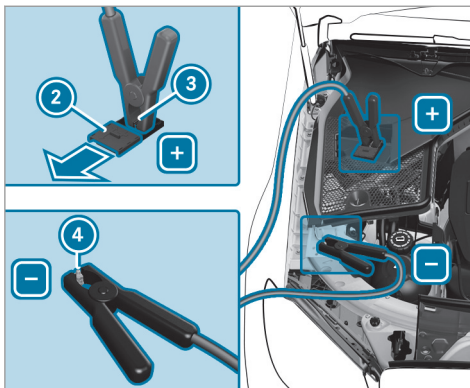

- ▶ Slide cover ② of positive clamp ③ on the jump-starting connection point ④ in the direction of the arrow.

#### Starting assistance

- ▶ Connect positive contact ③ on your vehicle to the positive terminal of the donor battery using the jumper cable. Always begin with positive clamp ③ on your own vehicle first.

- ▶ Start the engine of the donor vehicle and run it at idling speed.
- ▶ Connect the negative terminal of the donor battery to ground point ④ of your vehicle using the jumper cable. Begin with the donor battery first.
- ▶ Start the engine of your own vehicle.
- ▶ Let the engines run for several minutes.
- ▶ Before disconnecting the jumper cables, switch on an electrical consumer in your own vehicle, e.g. the rear window heater or the lighting.

When the starting assistance procedure is complete:

- ▶ First, remove the jumper cables from ground point ④ and the negative terminal of the donor battery, then from positive contact ③ and the positive terminal of the donor battery. Begin each time with the contacts on your own vehicle first.
- ▶ After removing the jumper cables, close cover ② of positive contact ③.
- ▶ Close cover ①.

Further information can be obtained at a qualified specialist workshop.

### Charging

- ▶ Connect positive contact ③ of the vehicle to the positive terminal of the charger using the charging cable. Always begin with positive contact ③ of the vehicle.
- ▶ Connect the negative terminal of the charger and ground point ④ on the vehicle with the charging cable. Start with the charger.
- ▶ Start the charging process.

When the charging process is complete:

- ▶ First, remove the charging cable from ground point ④ and the negative terminal of the charger, then from positive contact ③ and the positive terminal of the charger. Begin each time with the contacts of the vehicle.
- ▶ After removing the charging cable, close cover ② of positive contact ③.
- ▶ Close cover ①.

Further information can be obtained at a qualified specialist workshop.

### Replacing the 12 V battery

- ▶ Observe the notes on the 12 V battery (→ page 344).

Mercedes-Benz recommends that you have the 12 V battery replaced at a qualified specialist workshop, e.g. at an authorized Mercedes-Benz Center.

Observe the following notes if you want to replace the battery yourself:

- Always replace a faulty battery with a battery which meets the specific vehicle requirements.
- The vehicle is equipped with an AGM technology battery (Absorbent Glass Mat) or a lithium-ion battery. Full vehicle functionality is only guaranteed with an AGM battery or lithium-ion battery. For safety reasons, Mercedes-Benz recommends that you only use batteries which have been tested and approved for your vehicle by Mercedes-Benz.
- Carry over detachable parts, such as vent hoses, elbow fitting or terminal covers from the battery being replaced.

- Make sure that the vent hose is always connected to the original opening on the side of the battery.  
Install any existing or supplied cell caps. Otherwise, gases or battery acid could escape.
- Make sure that detachable parts are reconnected in the same way.

### Tow starting or towing away

#### Permitted towing methods

#### **!** NOTE Damage from automatic braking

If one of the following functions is switched on, the vehicle brakes automatically in certain situations:

- Active Brake Assist
- Active Distance Assist DISTRONIC
- HOLD function
- Active Parking Assist

To avoid damage to the vehicle, deactivate these systems in the following or similar situations:

- ▶ During towing
- ▶ In a car wash

Mercedes-Benz recommends transporting your vehicle in the case of a breakdown, rather than towing it away.

For towing, use a tow rope or tow bar with both axles on the ground. Do not use tow bar systems.

**!** **NOTE** Damage to the vehicle due to towing away incorrectly

- ▶ Observe the instructions and notes on towing away.

### Vehicles with automatic transmission

#### Permitted towing methods

Both axles on the ground	Yes, maximum 31 miles (50 km) at 31 mph (50 km/h)
Front axle raised	No
Rear axle raised	Yes, if the steering wheel is fixed in the center position with a steering wheel lock

### 4MATIC vehicles

#### Permitted towing methods

Both axles on the ground	Yes, maximum 31 miles (50 km) at 31 mph (50 km/h)
Front axle raised	No
Rear axle raised	No

**To tow with a raised axle:** towing should be performed by a towing company.

### Towing the vehicle with both axles on the ground

- ▶ Observe the notes on the permitted towing methods (→ page 349).
- ▶ Make sure that the battery is connected and charged.

Observe the following points when the battery is discharged:

- The engine cannot be started
- The electric parking brake cannot be released or applied
- **Vehicles with automatic transmission:** The automatic transmission cannot be shifted to position **N** or **P**

**i** **Vehicles with automatic transmission:** If the automatic transmission cannot be shifted to position **N**, or the multifunction display in the instrument cluster does not show anything, have the vehicle transported away (→ page 352). A towing vehicle with lifting equipment is required for vehicle transportation.



**!** **NOTE** Damage due to towing away at excessively high speeds or over long distances

The drivetrain could be damaged when towing at excessively high speeds or over long distances.

- ▶ A towing speed of 30 mph (50 km/h) must not be exceeded.
- ▶ A towing distance of 30 miles (50 km) must not be exceeded.

**!** **WARNING** Risk of accident when towing a vehicle which is too heavy

If another vehicle is tow-started or towed away, its weight must not exceed the permissible gross mass of your own vehicle, otherwise the following could occur:

- The towing eye may become detached.
- The vehicle/trailer combination may swerve or even rollover.
- ▶ If another vehicle is tow-started or towed away, its weight must not exceed

the permissible gross mass of your own vehicle.

If a vehicle must be tow-started or towed away, its permissible gross weight must not exceed the permissible gross weight of the towing vehicle.

- ▶ Information on the permissible gross mass of the vehicle can be found on the vehicle identification plate (→ page 391).
- ▶ **Vehicles with automatic transmission:** Do not open the driver's door or front passenger door, otherwise the automatic transmission automatically shifts to position **P**.
- ▶ Install the towing eye (→ page 353).
- ▶ Fasten the tow bar.

**!** **NOTE** Damage due to incorrect connection of the tow bar

- ▶ Only connect the tow rope or tow bar to the towing eyes.

- ▶ Deactivate the automatic locking mechanism (→ page 69).

- ▶ Do not activate the HOLD function.
- ▶ Deactivate the tow-away alarm (→ page 85).
- ▶ Deactivate Active Brake Assist (→ page 180).
- ▶ **Vehicles with automatic transmission:** Shift the automatic transmission to position **N**.
- ▶ Release the electric parking brake.

**!** **WARNING** Risk of accident due to limited safety-related functions during the towing process

Safety-related functions are limited or no longer available in the following situations:

- The ignition is switched off.
- The brake system or power steering system is malfunctioning.
- The energy supply or the on-board electrical system is malfunctioning.

When your vehicle is then towed away, significantly more effort may be required to steer and brake than is normally required.

- ▶ Use a tow bar.
- ▶ Make sure that the steering wheel can move freely before towing the vehicle away.

**!** **NOTE** Damage due to excessive tractive power

If you pull away sharply, the tractive power may be too high and the vehicles could be damaged.

- ▶ Pull away slowly and smoothly.

### Loading the vehicle for transport

- ▶ Observe the notes on towing away (→ page 350).
- ▶ Connect the tow bar to the towing eye in order to load the vehicle.
- ▶ **Vehicles with automatic transmission:** shift the automatic transmission to position **[N]**.

**i** **Vehicles with automatic transmission:** the automatic transmission may be locked in position **[P]** in the event of damage to the electrical system. To shift to **[N]**, provide the on-board electrical system with power (→ page 347).

- ▶ Load the vehicle onto the transporter.
- ▶ **Vehicles with automatic transmission:** shift the automatic transmission to position **[P]**.
- ▶ Use the electric parking brake to secure the vehicle against rolling away.
- ▶ Only secure the vehicle by the wheels.

### Vehicles with ADS PLUS (Adaptive Damping System PLUS)

**!** **WARNING** Risk of an accident when transporting vehicles with Adaptive Damping System PLUS

When transporting vehicles with Adaptive Damping System PLUS, the vehicle/trailer combination may begin to rock and start to skid.

- ▶ When transporting, ensure that:
  - The vehicle has been loaded onto the transporter correctly
  - The vehicle is secured at all four wheels with suitable tensioning straps
  - The maximum permissible speed of 35 mph (60 km/h) is not exceeded when transporting

**!** **NOTE** Damage to the vehicle from securing it incorrectly

- ▶ After loading, the vehicle must be secured on all four wheels. Otherwise, the vehicle could be damaged.
- ▶ A minimum distance of 8 in (20 cm) upwards and 4 in (10 cm) downwards must be kept to the transport platform.

- ▶ Secure the vehicle on all four wheels after loading.

### 4MATIC vehicles/vehicles with automatic transmission

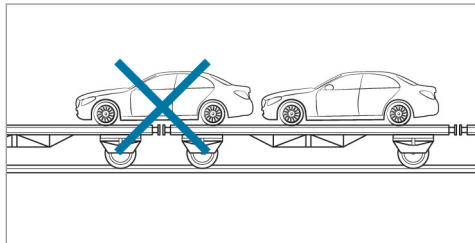

- ▶ Make sure that the front and rear axles come to rest on the same transportation vehicle.

**!** **NOTE** Damage to the drivetrain due to incorrect positioning

- ▶ Do not position the vehicle above the connection point of the transport vehicle.

### Towing eye storage location

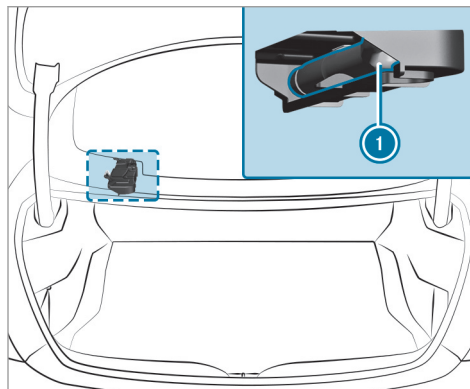

Towing eye ① is in a bracket under the rear shelf.

### Installing the towing eye

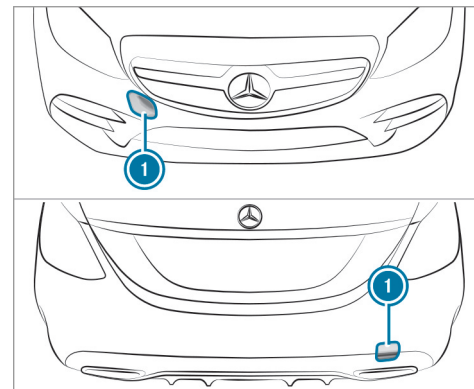

- ▶ Press the mark on cover ① inwards and remove.
- ▶ Screw in the towing eye clockwise as far as it will go and tighten.
- ▶ Make sure that cover ① engages in the bumper when you remove the towing eye.

**!** **NOTE** Damage to the vehicle due to incorrect use of the towing eye

When a towing eye is used to recover a vehicle, the vehicle may be damaged in the process.

- ▶ Only use the towing eye to tow away or tow start the vehicle.

### Tow starting the vehicle (emergency engine start)

#### Vehicles with automatic transmission

**!** **NOTE** Damage to the automatic transmission due to tow starting

The automatic transmission may be damaged in the process of tow starting vehicles with automatic transmission.

- ▶ Vehicles with automatic transmission must not be tow started.
- ▶ Vehicles with automatic transmission must not be tow-started.

### Electrical fuses

#### Notes on electrical fuses

**!** **WARNING** Risk of accident and injury due to overloaded lines

If you manipulate or bridge a faulty fuse or if you replace it with a fuse with a higher amperage, the electric line could be overloaded.

This could result in a fire.

- ▶ Always replace faulty fuses with specified new fuses containing the correct amperage.

**!** **NOTE** Damage due to incorrect fuses

Electrical components or systems may be damaged by incorrect fuses, or their functionality may be significantly impaired.

- ▶ Only use fuses that have been approved by Mercedes-Benz and which have the correct fuse rating.

Blown fuses must be replaced with fuses of the same rating, which you can recognize by the color and the label. The fuse ratings and further information to be observed can be found in the fuse assignment diagram.

**Fuse assignment diagram:** on the fuse box in the trunk (→ page 357).

**!** **NOTE** Damage or malfunctions caused by moisture

Moisture may cause damage to the electrical system or cause it to malfunction.

- ▶ When the fuse box is open, make sure that no moisture can enter the fuse box.
- ▶ When closing the fuse box, make sure that the seal of the lid is positioned correctly on the fuse box.

If the newly inserted fuse also blows, have the cause traced and rectified at a qualified specialist workshop.

Ensure the following before replacing a fuse:

- The vehicle is secured against rolling away.

- All electrical consumers are switched off.
- The ignition is switched off.

The electrical fuses are located in various fuse boxes:

- Fuse box in the engine compartment on the driver's side (→ page 355)
- Fuse box on the driver's side of the cockpit (→ page 356)
- Fuse box in the front passenger footwell (→ page 356)
- Fuse box in the trunk on the right-hand side of the vehicle, when viewed in the direction of travel (→ page 357)

### Opening and closing the fuse box in the engine compartment

#### Requirements:

- A dry cloth and a screwdriver are available.

Observe the notes on electrical fuses (→ page 354).

### Opening

**⚠ WARNING** Risk of injury from using the windshield wipers while the engine hood is open

When the engine hood is open and the windshield wipers are set in motion, you can be trapped by the wiper linkage.

- ▶ Always switch off the windshield wipers and ignition before opening the engine hood.

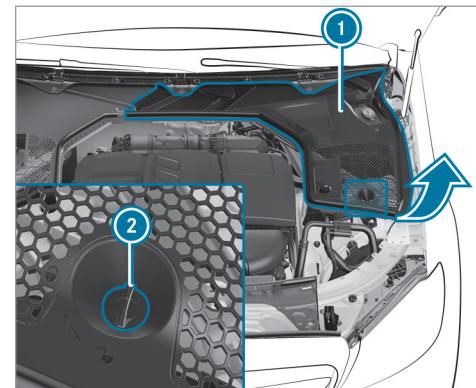

- ▶ Turn retaining clip ② on cover ① a quarter-turn counter-clockwise.
- ▶ Fold cover ① up in the direction of the arrow.

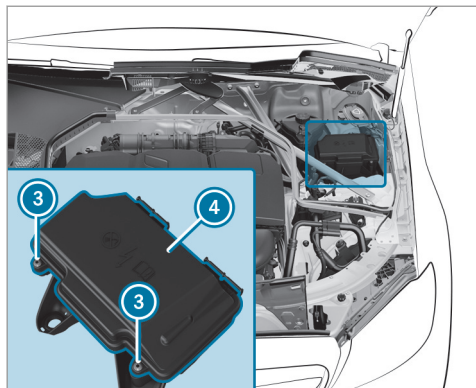

- ▶ Remove any existing moisture from the fuse box using a dry cloth.
- ▶ Loosen screws ③ and remove fuse box lid ④ upwards.

#### Closing

- ▶ Check whether the seal is positioned correctly in lid ④.

- ▶ Insert lid ④ into the bracket at the back of the fuse box.
- ▶ Fold down lid ④ of the fuse box and tighten screws ③.
- ▶ Fold down cover ①.
- ▶ Turn retaining clip ② on cover ① a quarter-turn clockwise.
- ▶ Close the hood.

#### Opening and closing the fuse box in the cockpit

##### Requirements:

- Observe the notes on electrical fuses (→ page 354).

The fuse box is on the driver's side on the side of the cockpit under a cover.

- ▶ Contact an authorized Mercedes-Benz Center for further information.

#### Opening and closing the fuse box in the front passenger footwell

Observe the notes on electrical fuses (→ page 354).

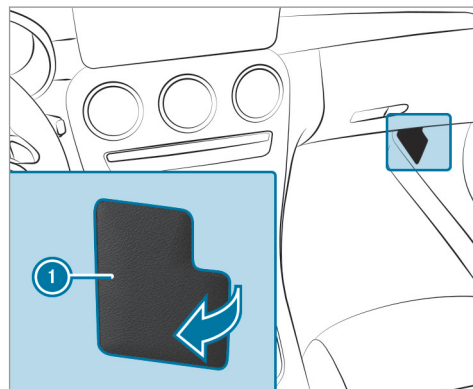

- ▶ **To open:** open cover ① in the direction of the arrow and remove it.
- ▶ **To close:** reinsert cover ①.

## Opening and closing the fuse box in the trunk

Observe the notes on electrical fuses  
(→ page 354).

- ▶ Open the trunk floor .

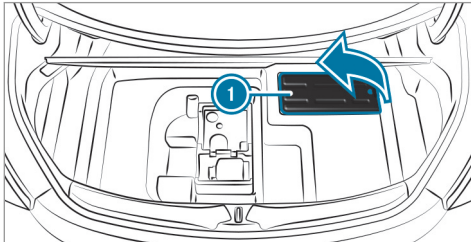

- ▶ Fold cover ① up in the direction of the arrow.

The fuse assignment diagram is in a recess on the side of the fuse box.

### Notes on noise or unusual handling characteristics

Make sure there are no vibrations, noises or unusual handling characteristics when the vehicle is in motion. This may indicate that the wheels or tires are damaged. Hidden tire damage could also be causing the unusual handling characteristics.

If you suspect that a tire is malfunctioning, reduce your speed immediately and have the tires and wheels checked at a qualified specialist workshop.

### Notes on regularly inspecting wheels and tires

**⚠ WARNING** Risk of injury through damaged tires

Damaged tires can cause tire pressure loss.

- ▶ Check the tires regularly for signs of damage and replace any damaged tires immediately.

**⚠ WARNING** Risk of hydroplaning due to insufficient tire tread

Insufficient tire tread will result in reduced tire grip.

In heavy rain or slush the risk of hydroplaning is increased, in particular where speed is not adapted to suit the conditions.

- ▶ Thus, you should regularly check the tread depth and the condition of the tread across the entire width of all tires.

Minimum tread depth for:

- Summer tires:  $\frac{1}{8}$  in (3 mm)
- M+S tires:  $\frac{1}{16}$  in (4 mm)
- ▶ For safety reasons, replace the tires before the legally-prescribed limit for the minimum tread depth is reached.

Carry out the following checks on all wheels regularly, at least once a month or as required, for example, prior to a long journey or driving off-road:

- Check the tire pressure (→ page 359).

- Visually inspect wheels and tires for damage.
- Check the valve caps.
- Visual check of the tire tread depth and the tire contact surface across the entire width.  
The minimum tread depth for summer tires is  $\frac{1}{8}$  in (3 mm) and for winter tires  $\frac{1}{16}$  in (4 mm).

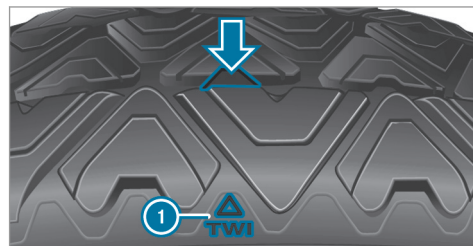

Six marks ① show where the bar indicators (arrow) are integrated into the tire tread. They are visible once a tire tread depth of approximately  $\frac{1}{16}$  in (1.6 mm) has been reached.



### Notes on snow chains

**⚠ WARNING** Risk of accident due to incorrect mounting of snow chains

If you have mounted snow chains to the front wheels, the snow chains may drag against the vehicle body or chassis components.

This could cause damage to the vehicle or the tires.

- ▶ Never mount snow chains on the front wheels.
- ▶ Only mount snow chains on the rear wheels in pairs.

**! NOTE** Damage to components of the vehicle body or chassis due to mounted snow chains

If you mount snow chains to the front wheels of 4MATIC vehicles, you may damage components of the vehicle body or chassis.

- ▶ Only mount snow chains to the rear wheels of 4MATIC vehicles.

Observe the following notes when using snow chains:

- Snow chains are only permissible for certain wheel/tire combinations. You can obtain information about this from an authorized Mercedes-Benz Center.
  - For safety reasons, only use snow chains that have been specifically approved for your vehicle by Mercedes-Benz, or snow chains with the same quality standard.
  - If snow chains are installed, the maximum permissible speed is 30 mph (50 km/h).
  - **Vehicles with Active Parking Assist:** Do not use Active Parking Assist when snow chains are installed.
  - **Vehicles with level control:** If snow chains are installed, only drive at raised vehicle level (→ page 188).
- i** You can deactivate ESP® to pull away (→ page 159). This allows the wheels to spin, achieving an increased driving force.

### Tire pressure

#### Notes on tire pressure

**⚠ WARNING** Risk of accident due to insufficient or excessive tire pressure

Tires with either too low or too high a pressure present the following hazards:

- the tires could burst
  - the tires could wear excessively and/or unevenly
  - the driving characteristics as well as steering and braking characteristics may be severely impaired
- ▶ Observe the recommended tire pressures and check the tire pressure of all tires including the spare wheel:
- monthly
  - if altering the load on the vehicle
  - prior to long journeys
  - if the operating conditions change, for example when driving off-road

- ▶ Adjust the tire pressure where necessary.

Tire pressure which is too high or too low can:

- Shorten the service life of the tires.
- Cause increased tire damage.
- Adversely affect driving characteristics and thus driving safety, e.g. due to hydroplaning.

**⚠ WARNING** Risk of accident due to too low a tire pressure

Tires with pressure that is too low can overheat and burst as a consequence.

In addition, they also suffer from irregular wear, which can significantly impair the braking properties and the handling characteristics.

- ▶ Avoid excessively low tire pressure.

Tire pressure which is too low can cause:

- Tire malfunctions as a result of overheating
- Impaired handling characteristics
- Irregular wear

- Increased fuel consumption

**⚠ WARNING** Risk of accident due to too high a tire pressure

Tires with excessively high pressure can burst.

In addition, they also suffer from irregular wear, which can significantly impair the braking properties and the handling characteristics.

- ▶ Avoid excessively high tire pressures.

Tire pressure which is too high can cause:

- Increased braking distance
- Impaired handling characteristics
- Irregular wear
- Impaired driving comfort
- Susceptibility to damage

**⚠ WARNING** Risk of accident due to repeated pressure drop in the tires

The wheels, valves or tires could be damaged.

Too low a tire pressure can lead to the tires bursting.

- ▶ Examine the tires for foreign objects.
- ▶ Check whether the tire has a puncture or the valve has a leak.
- ▶ If you are unable to rectify the damage, contact a qualified specialist workshop.

You can find information on tire pressure for the vehicle's factory-installed tires on the following labels:

- Tire and Loading Information placard on the B-pillar of your vehicle (→ page 366).
- Tire pressure table on the inside of the fuel filler flap (→ page 361).

Observe the maximum tire pressure (→ page 372).

Use a suitable pressure gauge to check the tire pressure. The outer appearance of a tire does not permit any reliable conclusion about the tire pressure.

Only correct tire pressure when the tires are cold. Conditions for cold tires:

- The vehicle has been parked with the tires out of direct sunlight for at least three hours.
- The vehicle has traveled less than 1 mile (1.6 km).

The vehicle's tires heat up when driving. As the temperature of the tires increases, so too does the tire pressure.

**Vehicles with a tire pressure monitoring system:** You can also check the tire pressure using the on-board computer.

The tire pressure recommended for increased load/speed in the tire pressure table can affect the ride comfort.

**⚠ WARNING** Risk of accident due to unsuitable accessories on tire valves

If you mount unsuitable accessories onto tire valves, the tire valves may be overloaded and malfunction, which can cause tire pressure loss.

- ▶ Only screw standard valve caps or valve caps specifically approved by Mercedes-Benz for your vehicle onto the tire valve.

### Tire pressure table

The tire pressure table is on the inside of the fuel filler flap.

- ⓘ The data shown in the images is example data.

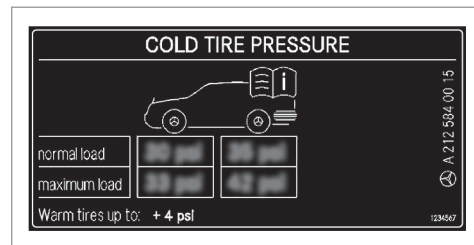

If one or more tire sizes precede a tire pressure, the following tire pressure information is only valid for those tire sizes and their respective load condition.

The load conditions "partially laden" and "fully laden" are defined in the table for different numbers of passengers and amounts of luggage. The actual number of seats may differ from this.

		kPa	psi	kPa	psi
R18					
R19					
M+S					

Some tire pressure tables only show the rim diameter instead of the complete tire size, e.g. **R18**. The rim diameter is part of the tire size and can be found on the tire side wall (→ page 373).

- Tire and Loading Information placard (→ page 366)
- Maximum tire pressure (→ page 372)

### Checking the tire pressure manually

- ▶ Read the tire pressure recommended for the current operating conditions from the Tire and Loading Information placard or the tire pressure table. Observe the notes on tire pressure.
- ▶ Remove the valve cap of the tire to be checked.
- ▶ Press the tire pressure gauge securely onto the valve.
- ▶ Read the tire pressure.
- ▶ If the tire pressure is lower than the recommended value, increase the tire pressure to the recommended value.
- ▶ If the tire pressure is higher than the recommended value, release air. To do so, press down the metal pin in the valve, e.g. using the tip of a pen, for example. Then check the tire pressure again using the tire pressure gauge.
- ▶ Screw the valve cap onto the valve.

Further related subjects:

- Notes on tire pressure (→ page 359)

- Tire pressure table (→ page 361)
- Tire and Loading Information placard (→ page 366)

### Tire pressure monitoring system

#### Function of the tire pressure monitoring system

**⚠ DANGER** Risk of accident due to incorrect tire pressure

Each tire, including the spare (if provided), should be checked monthly when cold and inflated to the inflation pressure recommended by the vehicle manufacturer on the vehicle placard or tire inflation pressure label. (If your vehicle has tires of a different size than the size indicated on the vehicle placard or tire inflation pressure label, you should determine the proper tire inflation pressure for those tires.)

As an added safety feature, your vehicle has been equipped with a tire pressure monitoring system (TPMS) that illuminates a low tire

pressure telltale when one or more of your tires is significantly under-inflated. Accordingly, when the low tire pressure telltale illuminates, you should stop and check your tires as soon as possible, and inflate them to the proper pressure. Driving on a significantly under-inflated tire causes the tire to overheat and can lead to tire failure. Under-inflation also reduces fuel efficiency and tire tread life, and may affect the vehicle's handling and stopping ability. Please note that the TPMS is not a substitute for proper tire maintenance, and it is the driver's responsibility to maintain correct tire pressure, even if under-inflation has not reached the level to trigger illumination of the TPMS low tire pressure telltale.

Your vehicle has also been equipped with a TPMS malfunction indicator to indicate when the system is not operating properly. The TPMS malfunction indicator is combined with the low tire pressure telltale. When the system detects a malfunction, the telltale will flash for approximately one minute and then

remain continuously illuminated. This sequence will continue upon subsequent vehicle start-ups as long as the malfunction exists.

When the malfunction indicator is illuminated, the system may not be able to detect or signal low tire pressure as intended. TPMS malfunctions may occur for a variety of reasons, including the installation of replacement or alternate tires or wheels on the vehicle that prevent the TPMS from functioning properly.

The system checks the tire pressure and the tire temperature of the tires installed on the vehicle by means of a tire pressure sensor.

The tire pressure and the tire temperature appear in the on-board computer (→ page 363).

If there is a substantial pressure loss or if the tire temperature is excessive, you will be warned with display messages (→ page 440) or the  warning lamp in the instrument cluster (→ page 461).

The tire pressure monitoring system is only an aid. It is the driver's responsibility to set the tire pressure to the recommended cold tire pressure suitable for the operating situation.

In most cases, the tire pressure monitoring system will automatically update the new reference values after you have changed the tire pressure. You can, however, also update the reference values by restarting the tire pressure monitoring system manually (→ page 364).

#### System limits

The system may be impaired or may not function particularly in the following situations:

- The tire pressure has been set incorrectly
- Sudden pressure loss caused by a foreign object penetrating the tire, for example
- There is a malfunction caused by another radio signal source

#### Checking the tire pressure with the tire pressure monitoring system

##### Requirements:

- The ignition is switched on.

On-board computer:

→ Service ► Tires

One of the following displays appears:

- Current tire pressure and tire temperature of the individual wheels:

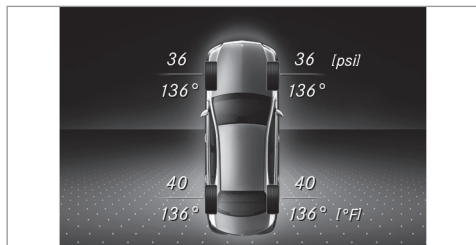

- **Tire pressure will be displayed after driving a few minutes**
  - **Tire Pressure Monitor Active:** the teach-in process of the system is not yet complete. The tire pressures are already being monitored.
- Compare the tire pressure with the recommended tire pressure for the current operat-

ing condition (→ page 361). Observe the notes on tire temperature (→ page 359).

- ① The values displayed in the on-board computer may deviate from those of the tire pressure gauge as they refer to sea level. At high elevations, the tire pressure values indicated by a pressure gauge are higher than those shown by the on-board computer. In this case, do not reduce the tire pressure.

### Restarting the tire pressure monitoring system

#### Requirements:

- The recommended tire pressure is correctly set for the respective operating status on all of the wheels (→ page 359).

Restart the tire pressure monitoring system in the following situations:

- The tire pressure has changed.
- The wheels or tires have been changed or newly installed.

On-board computer:

→ Service ► Tires

- Swipe downwards on Touch Control on the left-hand side of the steering wheel. The **Use Current Pressures as New Reference Values?** message is shown in the multifunction display.
- To restart, press Touch Control on the left-hand side of the steering wheel. The **Tire Press. Monitor Restarted** message is shown in the multifunction display. Current warning messages are deleted and the yellow  warning lamp goes out. After you have been driving for a few minutes, the system checks whether the current tire pressures are within the specified range. The current tire pressures are then accepted as reference values and monitored.

Be sure to also pay attention to the following related topic:

- Notes on tire pressure (→ page 359)

## Tire pressure loss warning system

### Function of the tire pressure loss warning system

The tire pressure loss warning system warns the driver by means of display messages when there is a severe tire pressure loss.

### System limits

The system may be impaired or may not function particularly in the following situations:

- Incorrectly set tire pressure
- Sudden pressure loss caused, for example, by a foreign object penetrating the tire
- Steady pressure loss in several tires

The system has a restricted or delayed function particularly in the following situations:

- Poor ground conditions, e.g. snow or gravel
- Driving with snow chains
- When adopting a very sporty driving style with high cornering speeds or sudden acceleration
- Driving with a high load

The tire pressure loss warning system is only an aid. It is the driver's responsibility to set the tire pressure to the recommended cold tire pressure suitable for the operating situation and to check it.

Be sure to also observe the following further related subjects:

- Notes on tire pressure (→ page 359)
- Display messages about the tires (→ page 440)

### Restarting the tire pressure loss warning system

#### Requirements:

- The recommended tire pressure is correctly set for the respective operating status on all wheels.

Restart the tire pressure loss warning system in the following situations:

- The tire pressure has changed.
- The wheels or tires have been changed or newly installed.

On-board computer:

↳ Service ▶ Tires

- ▶ Swipe downwards on Touch Control on the left-hand side of the steering wheel. The **Tire Pressure Control System Active Restart: Press Touch Control** message is shown in the multifunction display.
  - ▶ To begin restart, press Touch Control on the left-hand side of the steering wheel. The **Tire Pressure Now OK?** message is shown in the multifunction display.
  - ▶ Select **Yes**.
  - ▶ To confirm restart, press Touch Control on the left-hand side of the steering wheel. The **Run Flat Indicator Restarted** message is shown in the multifunction display.
- After you have driven for a few minutes, the tire pressure loss warning system monitors the set tire pressure of all the tires.

Be sure to also pay attention to the following related topic:

- Notes on tire pressure (→ page 359)

## Loading the vehicle

### Notes on Tire and Loading Information placard

**⚠ WARNING** Risk of accident from overloaded tires

Overloaded tires may overheat and burst as a consequence. Overloaded tires can also impair the steering and handling characteristics and lead to brake failure.

- ▶ Observe the load rating of the tires.
- ▶ The load rating must be at least half the permissible axle load of the vehicle.
- ▶ Never overload the tires by exceeding the maximum load.

The Tire and Loading Information placard is on the B-pillar on the driver's side of the vehicle.

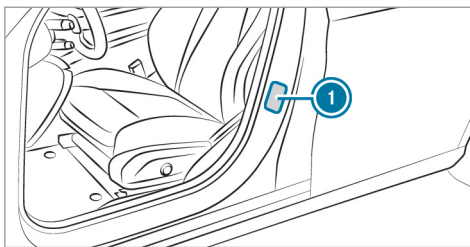

① Tire and Loading Information placard

TIRE AND LOADING INFORMATION		RENSEIGNEMENTS SUR LES PNEUS ET LE CHARGEMENT	
SEATING CAPACITY NOMBRE DE PLACES	TOTAL 7	FRONT AVANT	MIDDLE MI EU 3   REAR ARRIÈRE 2
The combined weight of occupants and cargo should never exceed XXX kg or XXX lbs. Le poids total des occupants et du chargement ne doit jamais dépasser XXX kg ou XXX lbs.			
TIRE PNEU	SIZE DIMENSIONS	COLD TIRE PRESSURE PRESSION DES PNEUS À FROID	SEE OWNER'S MANUAL FOR ADDITIONAL INFORMATION
FRONT AVANT	255/40 ZR18 99Y XL	200 KPA, 29 PSI	VOIR LE MANUEL DE L'USAGER POUR PLUS DE RENSEIGNEMENTS
REAR ARRIÈRE	285/35 ZR18 101Y XL	200 KPA, 29 PSI	
SPARE DE SECOURS	175/55-18 95P	420 KPA, 60 PSI	

ⓘ The data shown in the illustration is example data.

The Tire and Loading Information placard shows the following information:

- Maximum number of seats ② according to the maximum number of people permitted to travel in the vehicle.



- Maximum permissible load **③** comprises the gross weight of all vehicle occupants, load and luggage.
- Recommended tire pressure **①** for cold tires. The recommended tire pressures are valid for the maximum permissible load and up to the maximum permissible vehicle speed.

Please also note:

- Information on permissible weights and loads on the vehicle identification plate (→ page 391).
- Information on tire pressure in the tire pressure table (→ page 361).

Further related subjects:

- Determining the maximum permissible load (→ page 367)
- Notes on tire pressure (→ page 359).

### Steps for Determining Correct Load Limit

The following steps have been developed as required of all manufacturers under Title 49,

Code of U.S. Federal Regulations, Part 575, pursuant to the "National Traffic and Motor Vehicle Safety Act of 1966".

- ▶ **(1):** Locate the statement "The combined weight of occupants and cargo should never exceed XXX kg or XXX lbs." on your vehicle's placard.
- ▶ **(2):** Determine the combined weight of the driver and passengers that will be riding in your vehicle.
- ▶ **(3):** Subtract the combined weight of the driver and passengers from XXX kg or XXX lbs.
- ▶ **(4):** The resulting figure equals the available amount of cargo and luggage load capacity. For example, if the "XXX" amount equals 1,400 lbs. and there will be five 150 lb passengers in your vehicle, the amount of available cargo and luggage load capacity is 650 lbs. (1,400 - 750 (5 x 150) = 650 lbs.)
- ▶ **(5):** Determine the combined weight of luggage and cargo being loaded on the vehicle. That weight may not safely exceed the availa-

ble cargo and luggage load capacity calculated in Step 4.

- ▶ **(6):** If your vehicle will be towing a trailer, load from your trailer will be transferred to your vehicle. Consult this manual to determine how this reduces the available cargo and luggage load capacity of your vehicle.

**i** Not all vehicles are permitted to tow a trailer. Towing a trailer is only permitted if a trailer-hitch is installed. Please consult an authorized Mercedes-Benz dealer if you have any questions about towing a trailer with your vehicle.

Even if you have calculated the total load carefully, you should still make sure that the maximum permissible gross weight and the maximum gross axle weight rating of your vehicle are not exceeded. Details can be found on the vehicle identification plate.

- ▶ Have your loaded vehicle – including driver, occupants and load – weighed on a vehicle weighbridge.  
The measured values may not exceed the maximum permissible values stated on the vehicle identification plate.

Further related subjects:

- Calculation example for determining the maximum load (→ page 368)

- Tire and Loading Information placard (→ page 366)
- Tire pressure table (→ page 361)
- Vehicle identification plate (→ page 391)

#### Calculation example for determining the maximum load

The following table shows examples of how to calculate total and load capacities with varying

seating configurations and different numbers and sizes of occupants. The following examples use a maximum load of 1500 lbs (680 kg). **This is for illustration purposes only.** Make sure you are using the actual load limit for your vehicle stated on your vehicle's Tire and Loading Information placard (→ page 366).

The higher the weight of all the occupants, the smaller the maximum load for luggage.

#### Step 1

	Example 1	Example 2
Combined maximum weight of occupants and load (data from the Tire and Loading Information placard)	1500 lbs (680 kg)	1500 lbs (680 kg)

**Step 2**

	Example 1	Example 2
Number of people in the vehicle (driver and occupants)	5	1
Distribution of the occupants	Front: 2 Rear: 3	Front: 1
Weight of occupants	Occupant 1: 150 lbs (68 kg) Occupant 2: 180 lbs (82 kg) Occupant 3: 160 lbs (73 kg) Occupant 4: 140 lbs (63 kg) Occupant 5: 120 lbs (54 kg)	Occupant 1: 200 lbs (91 kg)
Total weight of all occupants	750 lbs (340 kg)	200 lbs (91 kg)

**Step 3**

	Example 1	Example 2
Permissible load (maximum gross vehicle weight rating from the Tire and Loading Information placard minus the gross weight of all occupants)	$1500 \text{ lbs (680 kg)} - 750 \text{ lbs (340 kg)} = 750 \text{ lbs (340 kg)}$	$1500 \text{ lbs (680 kg)} - 200 \text{ lbs (91 kg)} = 1300 \text{ lbs (589 kg)}$

## Tire labeling

### Overview of tire labeling

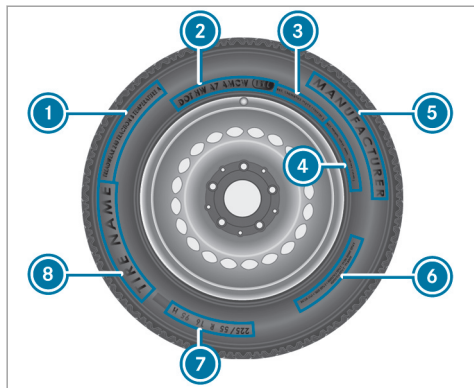

- ① Uniform Tire Quality Grading Standards
- ② DOT (Department of Transportation), (TIN) Tire Identification Number
- ③ Maximum tire load (→ page 372)
- ④ Maximum tire pressure (→ page 372)

- ⑤ Manufacturer
  - ⑥ Tire characteristics (→ page 373)
  - ⑦ Tire size designation, load-bearing capacity, speed rating and load index (→ page 373)
  - ⑧ Tire name
- ① The data shown in the illustration is example data.

### Tire Quality Grading

In accordance with the US Department of Transportation's "Uniform Tire Quality Grading Standards", tire manufacturers are required to grade their tires on the basis of the following three performance factors:

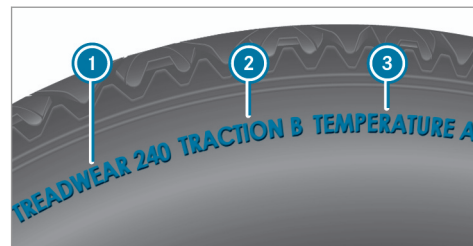

- ① Tread wear grade
  - ② Traction grade
  - ③ Temperature grade
- ① The data shown in the illustration is example data.
- ① The classification is not legally stipulated for Canada, but it is generally stated.

### Tread wear grade

The treadwear grade is a comparative rating based on the wear rate of the tire when tested under controlled conditions on a specified government test course. For example, a tire graded 150 would wear one and one-half (1 1/2\)

times as well on the government course as a tire graded 100.

The relative performance of tires depends upon the actual conditions of their use, however, and may depart significantly from the norm due to variations in driving habits, service practices and differences in road characteristics and climate.

### Traction grade

**⚠ DANGER** Risk of accident due to inadequate traction

The traction grade assigned to this tire is based on straight-ahead braking traction tests.

- ▶ Always adapt your driving style and drive at a speed to suit the prevailing traffic and weather conditions.

**! NOTE** Damage to the drivetrain from wheelspin

- ▶ Avoid wheelspin.

The traction grades, from highest to lowest, are AA, A, B, and C. Those grades represent the tire's ability to stop on wet pavement as measured under controlled conditions on specified government test surfaces of asphalt and concrete. A tire marked C may have poor traction performance.

### Temperature grade

**⚠ WARNING** Risk of accident from tire overheating and tire failure

Excessive speed, underinflation, or excessive loading, either separately or in combination, can cause excessive heat build-up and possible tire failure.

- ▶ Observe the recommended tire pressure.
- ▶ Regularly check the pressure of all the tires.
- ▶ Adjust the tire pressure, if necessary.

The temperature grades are A (the highest), B, and C, representing the tire's resistance to the generation of heat and its ability to dissipate

heat when tested under controlled conditions on a specified indoor laboratory test wheel. Sustained high temperature can cause the material of the tire to degenerate and reduce tire life, and excessive temperature can lead to sudden tire failure. The grade C corresponds to a level of performance which all passenger car tires must meet under the Federal Motor Safety Standard No. 109. Grades B and A represent higher levels of performance on the laboratory test wheel than the minimum required by law.

### DOT, Tire Identification Number (TIN)

US tire regulations stipulate that every tire manufacturer or retreader must imprint a TIN in or on the side wall of each tire produced.

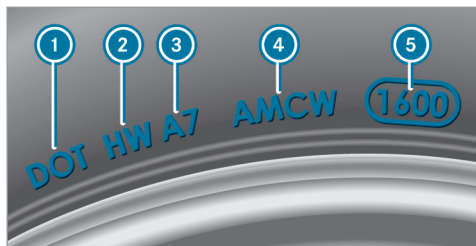

**i** The data shown in the image is example data.

The TIN is a unique identification number to identify tires and comprises the following:

- **DOT (Department of Transportation):** tire symbol marks **1** indicating that the tire complies with the requirements of the US Department of Transportation.
- **Manufacturer identification code:** manufacturer identification code **2** contains details of the tire manufacturer. New tires have a code with two symbols. Retreaded tires have a code with four symbols. Further information on retreaded tires (→ page 378).

- **Tire size:** identifier **3** describes the tire size.
- **Tire type code:** tire type code **4** can be used by the manufacturer as a code to describe specific characteristics of the tire.
- **Manufacturing date:** manufacturing date **5** provides information about the age of a tire. The 1st and 2nd positions represent the calendar week and the 3rd and 4th positions state the year of manufacture (e.g. "3208" represents the 32nd week of 2008).

#### Information on the maximum tire load



**i** The data shown in the image is example data.

Maximum tire load **1** is the maximum permissible weight for which the tire is approved.

Do not overload the tires by exceeding the specified load limit. The maximum permissible load can be found on the vehicle's Tire and Loading Information placard on the B-pillar on the driver's side (→ page 366).

#### Specifications for maximum tire pressure

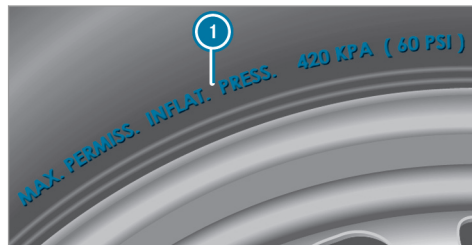

**i** The data shown in the illustration is example data.

Never exceed maximum tire pressure ❶ specified for the tire. Always observe the recommended tire pressure for your vehicle when adjusting the tire pressure (→ page 361).

### Information on tire characteristics



❶ The data shown in the image is example data.

This information describes the type of tire cord and the number of layers in side wall ❶ and under tire tread ❷.

### Tire size designation, load-bearing capacity, speed rating and load index

**⚠ WARNING** Risk of injury through exceeding the specified tire load-bearing capacity or the permissible speed rating

Exceeding the specified tire load rating or the permissible speed rating may lead to tire damage and to the tires bursting.

- ▶ Therefore, only use tire types and sizes approved for your vehicle model.
- ▶ Observe the tire load rating and speed rating required for your vehicle.

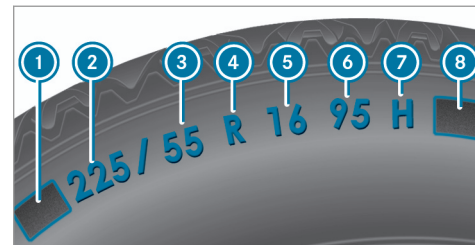

- ❶ First letter(s)
- ❷ Nominal tire width in millimeters
- ❸ Aspect ratio in %
- ❹ Tire code
- ❺ Rim diameter
- ❻ Load-bearing index
- ❼ Speed rating
- ❽ Load index

❶ The data shown in the illustration is example data.

Information about reading tire data can be obtained from any qualified specialist workshop.

**First letter(s)** ①:

- Without: passenger vehicle tires according to European manufacturing standards.
- "P": passenger vehicle tires according to US manufacturing standards.
- "LT": light truck tires according to US manufacturing standards.
- "T": compact emergency spare wheels with high tire pressure that are only designed for temporary use in an emergency.

**Aspect ratio** ②:

Ratio between tire height and tire width in percent (tire height divided by tire width).

**Tire code** ④ (tire type):

- "R" radial tire
- "D": bias ply tire
- "B": bias belted tires
- "ZR": radial tire with a maximum speed above 149 mph (240 km/h) (optional)

**Rim diameter** ⑤:

The diameter of the bead seat (not the diameter of the rim flange). The rim diameter is specified in inches (in).

**Load-bearing index** ⑥:

Numerical code that specifies the maximum load-bearing capacity of a tire (e.g. "91" corresponds to 1356 lbs (615 kg)).

The load-bearing capacity of the tire must be at least half the gross axle weight rating of your vehicle. Do not overload the tires by exceeding the specified load limit.

See also:

- Maximum permissible load on the Tire and Loading Information placard (→ page 366)
- Maximum tire load (→ page 372)
- Load index

**Speed rating** ⑦:

Specifies the approved maximum speed of the tire.

① An electronic speed limiter prevents your vehicle from exceeding a speed of 130 mph (210 km/h).

Make sure that your tires have the required speed rating. You can obtain information on the required speed rating from an authorized Mercedes-Benz Center.

**Summer tires**

Index	Speed rating
Q	up to 100 mph (160 km/h)
R	up to 106 mph (170 km/h)
S	up to 112 mph (180 km/h)
T	up to 118 mph (190 km/h)
H	up to 130 mph (210 km/h)
V	up to 149 mph (240 km/h)
W	up to 168 mph (270 km/h)
Y	up to 186 mph (300 km/h)



Index	Speed rating
ZR...Y <sup>1</sup>	up to 186 mph (300 km/h)
ZR...(..Y) <sup>1</sup>	over 186 mph (300 km/h)
ZR <sup>1</sup>	over 149 mph (240 km/h)

- Specifying the speed rating as the "ZR" index in tire code ④ is optional for tires up to 186 mph (300 km/h).
- If your tire code ④ includes "ZR" and there is no speed rating ⑦, find out what the maximum speed is from the tire manufacturer.
- If load-bearing index ⑥ and speed rating ⑦ are in brackets, the maximum speed rating of your tire is above 186 mph (300 km/h). To find out the maximum speed, ask the tire manufacturer.

<sup>1</sup> "ZR" stated in the tire code.

<sup>2</sup> Or "M+S"  " for winter tires.

### All-weather tires and winter tires

Index	Speed rating
Q M+S <sup>2</sup>	up to 100 mph (160 km/h)
T M+S <sup>2</sup>	up to 118 mph (190 km/h)
H M+S <sup>2</sup>	up to 130 mph (210 km/h)
V M+S <sup>2</sup>	up to 149 mph (240 km/h)

Winter tires bear the  snowflake symbol and fulfill the requirements of the Rubber Manufacturers Association (RMA) and the Rubber Association of Canada (RAC) regarding the tire traction on snow.

### Load index ⑧:

- No specification given: standard load (SL) tire
- "XL" or "Extra Load": extra load tire or reinforced tire
- "Light Load": light load tire

- "C", "D", "E": a load range that depends on the maximum load that the tire can carry at a certain pressure

### Definition of terms for tires and loading

**Tire structure and characteristics:** describes the number of layers or the number of rubber-coated belts in the tire contact surface and the tire wall. These are made of steel, nylon, polyester and other materials.

**Bar:** metric unit for tire pressure. 14.5038 pounds per square inch (psi) and 100 kilopascal (kPa) is the equivalent of one bar.

**DOT (Department of Transportation):** DOT-marked tires fulfill the requirements of the US Department of Transportation.

**Average weight of the vehicle occupants:** the number of vehicle occupants for which the vehicle is designed, multiplied by 150 lb (68 kg).

**Uniform Tire Quality Grading Standards:** a uniform standard to grade the quality of tires with regard to tread quality, tire traction and temperature characteristics. The quality grading assessment is made by the manufacturer following specifications from the U.S. government. The quality grade of a tire is imprinted on the side wall of the tire.

**Recommended tire pressure:** the recommended tire pressure is the tire pressure specified for the tires mounted to the vehicle at the factory.

The tire and information table contains the recommended tire pressures for cold tires, the maximum permissible load and the maximum permissible vehicle speed.

The tire pressure table contains the recommended tire pressures for cold tires under various operating conditions, i.e. loading and/or speed of the vehicle.

**Increased vehicle weight due to optional equipment:** the combined weight of all standard and optional equipment available for the vehicle,

regardless of whether it is actually installed on the vehicle or not.

**Rim:** the part of the wheel on which the tire is installed.

**GAWR (Gross Axle Weight Rating):** the GAWR is the maximum permissible axle load. The actual load on an axle must never exceed the gross axle weight rating. The gross axle weight rating can be found on the vehicle identification plate on the B-pillar on the driver's side.

**Speed rating:** the speed rating is part of the tire identification. It specifies the speed range for which a tire is approved.

**GVW (Gross Vehicle Weight):** the gross vehicle weight comprises the weight of the vehicle including fuel, tools, the spare wheel, accessories installed, occupants, luggage and the trailer drawbar noseweight, if applicable. The gross vehicle weight must not exceed the gross vehicle weight rating GVWR as specified on the vehicle identification plate on the B-pillar on the driver's side.

**GVWR (Gross Vehicle Weight Rating):** the GVWR is the maximum permitted gross weight

of the fully laden vehicle (weight of the vehicle including all accessories, occupants, fuel, luggage and the trailer drawbar noseweight if applicable). The gross vehicle weight rating is specified on the vehicle identification plate on the B-pillar on the driver's side.

**Maximum weight of the laden vehicle:** the maximum weight is the sum of the curb weight of the vehicle, the weight of the accessories, the maximum load and the weight of optional equipment installed at the factory.

**Kilopascal (kPa):** metric unit for tire pressure. 6.9 kPa corresponds to 1 psi. Another unit for tire pressure is bar. 100 kilopascal (kPa) equals 1 bar.

**Load index:** in addition to the load-bearing index, the load index may also be imprinted on the side wall of the tire. This specifies the load-bearing capacity of the tire more precisely.

**Curb weight:** the weight of a vehicle with standard equipment including the maximum capacity of fuel, oil and coolant. It also includes the air conditioning system and optional equipment if

these are installed on the vehicle, but does not include passengers or luggage.

**Maximum tire load:** the maximum tire load is the maximum permissible weight in kilograms or lbs for which a tire is approved.

**Maximum permissible tire pressure:** maximum permissible tire pressure for one tire.

**Maximum load on one tire:** maximum load on one tire. This is calculated by dividing the maximum axle load of one axle by two.

**PSI (pounds per square inch):** standard unit of measurement for tire pressure.

**Aspect ratio:** ratio between tire height and tire width in percent.

**Tire pressure:** pressure inside the tire applying an outward force to every square inch of the tire. The tire pressure is specified in pounds per square inch (psi), in kilopascals (kPa) or in bar. The tire pressure should only be corrected when the tires are cold.

**Cold tire pressure:** the tires are cold when the vehicle has been parked for at least 3 hours

without direct sunlight on the tires or the vehicle has been driven for less than 1 mile (1.6 km).

**Tire contact surface:** the part of the tire that comes into contact with the road.

**Tire bead:** the purpose of the tire bead is to ensure that the tire sits securely on the wheel rim. There are several wire cores in the tire bead to prevent the tire from changing length on the wheel rim.

**Side wall:** the part of the tire between the tread and the tire bead.

**Weight of optional equipment:** the combined weight of the optional equipment weighing more than the replaced standard parts and more than 5 lbs (2.3 kg). This optional equipment, such as high-performance brakes, level control system, a roof luggage rack or high-performance batteries, is not included in the curb weight and the weight of the accessories.

**TIN (Tire Identification Number):** a unique identification number which can be used by a tire manufacturer to identify tires, for example, in a product recall, and thus identify the purchasers. The TIN is made up of the manufactur-

er's identity code, tire size, tire type code and the manufacturing date.

**Load-bearing index:** the load-bearing index is a code that contains the maximum load-bearing capacity of a tire.

**Traction:** traction is the grip resulting from friction between the tires and the road surface.

**Wear indicator:** narrow bars (tread wear bars) that are distributed over the tire contact surface. If the tire tread is level with the bars, the wear limit of 1/16 in (1.6 mm) has been reached.

**Distribution of vehicle occupants:** distribution of vehicle occupants over designated seat positions in a vehicle.

**Maximum permissible payload weight:** nominal load and luggage load plus 150 lb (68 kg) multiplied by the number of seats in the vehicle.

## Changing a wheel

### Notes on selecting, installing and replacing tires

#### **!** NOTE Mercedes-AMG vehicles

- ▶ Observe the notes in the Supplement. You could otherwise fail to recognize dangers.

#### **▲** WARNING Risk of injury through incorrect sizes of wheels and tires

If wheels and tires of the wrong size are installed, the wheel brakes or components in the brake system and in the wheel suspension may be damaged.

- ▶ Always replace wheels and tires with those that fulfill the specifications of the original part.

For wheels, pay attention to the following:

- Designation
- Type

For tires, pay attention to the following:

- Designation
- Manufacturer
- Type

#### **▲** WARNING Risk of injury through exceeding the specified tire load-bearing capacity or the permissible speed rating

Exceeding the specified tire load rating or the permissible speed rating may lead to tire damage and to the tires bursting.

- ▶ Therefore, only use tire types and sizes approved for your vehicle model.
- ▶ Observe the tire load rating and speed rating required for your vehicle.

#### **!** NOTE Vehicle and tire damage through tire types and sizes that have not been approved

For safety reasons, only use tires, wheels and accessories which have been specially approved by Mercedes-Benz for your vehicle.

These tires are specially adapted to the active safety systems, such as ABS, ESP® and 4MATIC, and marked as follows:

- MO = Mercedes-Benz Original
- MOE = Mercedes-Benz Original Extended (run-flat tire only for certain wheels)
- MO1 = Mercedes-Benz Original (only certain AMG tires)

Otherwise, certain properties, such as handling characteristics, vehicle noise emissions, consumption, etc. could be adversely affected. Furthermore, other tire sizes could result in the tires rubbing against the body and axle components when loaded. This could result in damage to the tire or the vehicle.

Only use tires, wheels and accessories that have been checked and recommended by Mercedes-Benz.

**!** **NOTE** Risk to driving safety from retreaded tires

Retreaded tires are neither tested nor recommended by Mercedes-Benz, since previous damage cannot always be detected on retreaded tires.

For this reason driving safety cannot be guaranteed.

- ▶ Do not use used tires if you have no information about their previous usage.

**!** **NOTE** Possible wheel and tire damage when driving over obstacles

Large wheels have a smaller section width. As the section width decreases, the risk of wheels and tires being damaged when driving over obstacles increases.

- ▶ Avoid obstacles or drive especially carefully.
- ▶ Reduce your speed when driving over curbs, speed bumps, manhole covers and potholes.
- ▶ Avoid particularly high curbs.

**!** **NOTE** Possible wheel and tire damage when parking on curbs or in potholes

Parking on curbs or in potholes may damage the wheels and tires.

- ▶ If possible, park only on flat surfaces.
- ▶ Avoid curbs and potholes when parking.

**!** **NOTE** Damage to electronic component parts from the use of tire-mounting tools

**Vehicles with a tire pressure monitoring system:** Electronic component parts are located in the wheel. Tire-mounting tools should not be used in the area of the valve.

This could otherwise damage the electronic component parts.

- ▶ Have the tires changed at a qualified specialist workshop only.

**!** **NOTE** Damage to summer tires at low ambient temperatures

At low ambient temperatures, tears could form when driving with summer tires, causing permanent damage to the tire.

- ▶ At temperatures below 45 °F (7 °C) use  M+S- tires.

Accessory parts that are not approved for your vehicle by Mercedes-Benz or are not being used correctly can impair the operating safety.

Before purchasing and using non-approved accessories, visit a qualified specialist workshop and inquire about:

- Suitability
- Legal stipulations
- Factory recommendations

**⚠ WARNING** Risk of accident with high performance tires

The special tire tread in combination with the optimized tire compound means that the risk of skidding and hydroplaning on wet roads is increased.

In addition, the tire grip is greatly reduced at a low outside temperature and tire running temperature.

- ▶ Switch on the ESP® and adapt your driving style accordingly.
- ▶ Use  M+S tires at outside temperatures of less than 50 °F (10 °C).
- ▶ Only use the tires for their intended purpose.

Observe the following when selecting, installing and replacing tires:

- Furthermore, the use of certain tire types in certain regions and areas of operation can be highly beneficial.

- Only use tires and wheels of the same type (summer tires, winter tires, MOExtended tires) and the same make.

- Only install wheels of the same size on one axle (left and right).

It is only permissible to install a different wheel size in the event of a flat tire in order to drive to the specialist workshop.

- **Vehicles with a tire pressure monitoring system:** All installed wheels must be equipped with functioning sensors for the tire pressure monitoring system.
- At temperatures below 45 °F (7 °C) use winter tires or all-season tires marked  M+S for all wheels.

Winter tires provide the best possible grip in wintry road conditions.

- For M+S tires, only use tires with the same tread.
- Observe the maximum permissible speed for the M+S tires installed.

If the tire's maximum speed is below that of the vehicle, this must be indicated by an

appropriate label in the driver's field of vision.

- Break in new tires at moderate speeds for the first 60 miles (100 km).
- Replace the tires after six years at the latest, regardless of wear.
- **When replacing with tires that do not feature run-flat characteristics:** vehicles with MOExtended tires are not equipped with a TIREFIT kit at the factory. Equip the vehicle with a TIREFIT kit after replacing with tires that do not feature run-flat characteristics, e.g. winter tires.

For more information on wheels and tires, contact a qualified specialist workshop.

Be sure to also observe the following further related subjects:

- Notes on tire pressure (→ page 359)
- Tire and Loading Information placard (→ page 366)
- Tire size designation, load-bearing capacity, speed rating and load index (→ page 373)
- Tire pressure table (→ page 361)

- Notes on the emergency spare wheel (→ page 387)

### Notes on rotating wheels

**⚠ WARNING** Risk of injury through different wheel sizes

Rotating the front and rear wheels can severely impair the driving characteristics. The wheel brakes or suspension components may also be damaged.

- ▶ Rotate front and rear wheels only if the wheels and tires are of the same dimensions.

The wear patterns on the front and rear wheels differ:

- Front wheels wear more on the tire shoulder
- Rear wheels wear more in the center of the tire

Do not drive with tires that have too little tread depth. This significantly reduces traction on wet roads (hydroplaning).

On vehicles that have the same size front and rear wheels, rotate the wheels according to the intervals in the tire manufacturer's warranty book in your vehicle documents. If this is not available, rotate the tires every 3000 to 6000 miles (5000 to 10,000 km), depending on the wear. Ensure that the direction of rotation is maintained.

Observe the instructions and safety notes on "Changing a wheel" when doing so (→ page 382).

### Notes on storing wheels

When storing wheels, observe the following notes:

- After removing wheels, store them in a cool, dry and preferably dark place.
- Protect the tires from contact with oil, grease or fuel.

### Overview of the tire-change tool kit

**!** **NOTE** Mercedes-AMG vehicles

- ▶ Observe the notes in the Supplement. You could otherwise fail to recognize dangers.

Apart from some country-specific variants, vehicles are not equipped with a tire-change tool kit. For more information on which tire-changing tools are required and approved for performing a wheel change on your vehicle, consult a qualified specialist workshop.

You require the following tools, for example, to change a wheel:

- Jack
- Chock
- Lug wrench
- Alignment bolt

The tire-change tool kit is located under the trunk floor.

## 382 Wheels and tires

- i Depending on the model, the tire change tool kit may be located at other positions under the trunk floor.

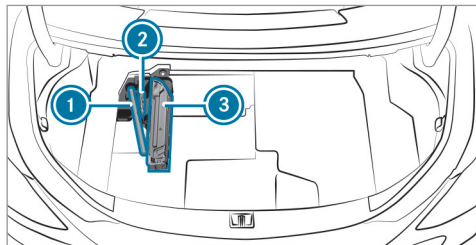

- ① Lug wrench
- ② Folding chock
- ③ Jack

### Preparing the vehicle for a wheel change

#### Requirements:

- The required tire-change tool is available. If your vehicle is not equipped with the tire-change tool kit, consult a qualified specialist workshop to find out about suitable tools.

- The vehicle is not on a slope.
- The vehicle is on solid, non-slippery and level ground.

- ▶ Apply the electric parking brake manually.
- ▶ Move the front wheels to the straight-ahead position.
- ▶ **Vehicles with automatic transmission:** Shift to position **P**.
- ▶ **Vehicles with level control system:** Set the normal vehicle level (→ page 188).
- ▶ Switch off the engine.
- ▶ Make sure that the engine cannot be started.
- ▶ Place chocks or other suitable items under the front and rear of the wheel that is diagonally opposite the wheel you wish to change.
- ▶ If necessary, remove the wheel trim/hub caps (→ page 382).
- ▶ Raise the vehicle (→ page 383).

### Removing and installing the wheel trim/hub caps

#### Requirements:

- The vehicle is prepared for a wheel change (→ page 382).

#### Plastic hub cap

- ▶ **To remove:** turn the center cover of the hub cap counter-clockwise and remove the hub cap.
- ▶ **To install:** make sure that the center cover of the hub cap is turned counter-clockwise.
- ▶ Position the hub cap and turn the center cover clockwise until the hub cap engages physically and audibly.



### Aluminum hub cap

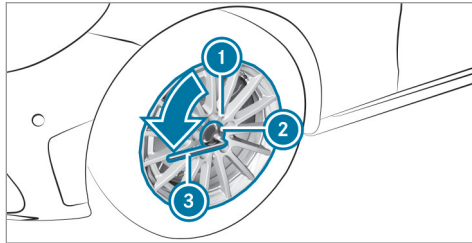

- ▶ **To remove:** position socket ② from the tire-change tool kit on hub cap ①.
  - ▶ Position wheel wrench ③ on socket ②.
  - ▶ Using wheel wrench ③, turn hub cap ① counter-clockwise and remove it.
  - ▶ **To install:** follow the instructions above in reverse order.
- ⓘ **Specified tightening torque:** 18 lb-ft (25 Nm).

### Raising the vehicle when changing a wheel

#### Requirements:

- There are no persons in the vehicle.
- The vehicle has been prepared for a wheel change (→ page 382).
- The wheel trims and hub caps have been removed (→ page 382).

#### Important notes on using the jack:

- Use only a vehicle-specific jack that has been approved by Mercedes-Benz to raise the vehicle.
- The jack is only designed for raising and holding the vehicle for a short time while a wheel is being changed and not for maintenance work under the vehicle.
- The jack must be placed on a firm, flat and non-slip surface. If necessary, use a large, flat, load-bearing, non-slip underlay.
- The foot of the jack must be positioned vertically under the jack support point.

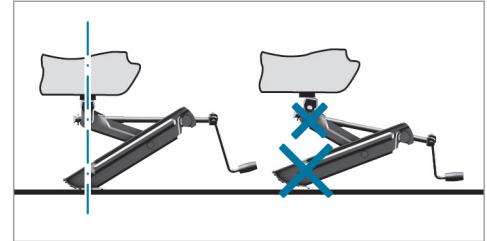

#### Rules of conduct when the vehicle is raised:

- Never place your hands or feet under the vehicle.
- Never lie under the vehicle.
- Do not start the engine and do not release the electric parking brake.
- Do not open or close any doors or the trunk lid.

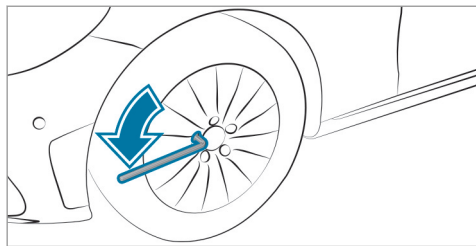

▶ Using the lug wrench, loosen the wheel bolts on the wheel you wish to change by about one full turn. Do not unscrew the bolts completely.

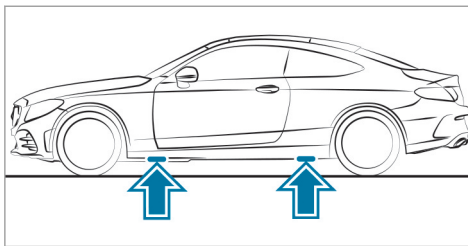

Position of jack support points

**!** **NOTE** Mercedes-AMG vehicles

▶ Observe the notes in the Supplement. You could otherwise fail to recognize dangers.

**!** **WARNING** Risk of injury from incorrect positioning of the jack

If you do not position the jack correctly at the appropriate jacking point of the vehicle, the jack could tip with the vehicle raised.

▶ Only position the jack at the appropriate jacking point of the vehicle. The base of the jack must be positioned vertically under the jacking point of the vehicle.

**!** **NOTE** Vehicle damage from the jack

If you do not position the jack correctly at the appropriate jack support point of the vehicle, the jack could tip over with the vehicle raised.

▶ The jack is designed exclusively for jacking up the vehicle at the jack support points.

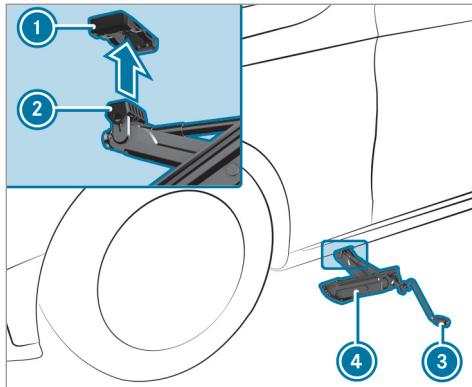

- ▶ Position support ② of jack ④ on jack support point ①.
- ▶ Turn crank ③ clockwise until support ② sits completely on jack support point ① and the base of the jack lies evenly on the ground.
- ▶ Turn crank ③ until the tire is raised a maximum of 1.2 in (3 cm) from the ground.
- ▶ Loosen and remove the wheel (→ page 385).

### Removing a wheel

#### Requirements:

- The vehicle is raised (→ page 383).

#### ! NOTE Mercedes-AMG vehicles

- ▶ Observe the notes in the Supplement. You could otherwise fail to recognize dangers.

When changing a wheel, avoid applying any force to the brake discs, as this could impair the level of comfort when braking.

#### ! NOTE Damage to threading from dirt on wheel bolts

- ▶ Do not place wheel bolts in sand or on a dirty surface.

- ▶ Unscrew the uppermost wheel bolt completely.

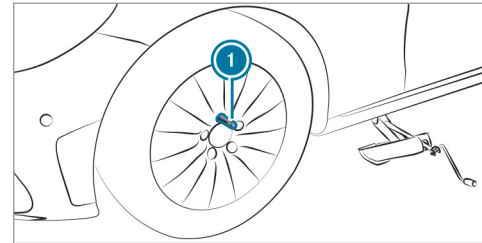

- ▶ Screw alignment bolt ① into the thread instead of the wheel bolt.
- ▶ Unscrew the remaining wheel bolts completely.
- ▶ Remove the wheel.
- ▶ Install the new wheel (→ page 385).

### Installing a new wheel

#### Requirements:

- The wheel is removed (→ page 385).

**!** NOTE Mercedes-AMG vehicles

- ▶ Observe the notes in the Supplement. You could otherwise fail to recognize dangers.

**⚠** WARNING Risk of accident from losing a wheel

Oiled, greased or damaged wheel bolt/wheel nut threads or wheel hub/wheel mounting bolt threads can cause the wheel bolts/wheel nuts to come loose.

As a result, you could lose a wheel while driving.

- ▶ Never oil or grease the threads.
- ▶ In the event of damage to the threads, contact a qualified specialist workshop immediately.
- ▶ Have the damaged wheel bolts or damaged hub threads replaced.
- ▶ Do not continue driving.

- ▶ Observe the information on the choice of tires (→ page 378).

For tires with a specified direction of rotation, an arrow on the side wall of the tire indicates the correct direction of rotation. Observe the direction of rotation when installing.

- ▶ Slide the wheel to be mounted onto the alignment bolt and push it on.

**⚠** WARNING Risk of injury from tightening wheel bolts and nuts

If you tighten the wheel bolts or wheel nuts when the vehicle is raised, the jack could tip.

- ▶ Only tighten wheel bolts or wheel nuts when the vehicle is on the ground.

- ▶ Be sure to observe the instructions and safety notes on "Changing a wheel" (→ page 378).
- ▶ For safety reasons, only use wheel bolts which have been approved by Mercedes-Benz and for the wheel in question.

**!** NOTE Damage to paintwork of the wheel rim when screwing on the first wheel bolt

If the wheel has too much play when screwing in the first wheel bolt, the wheel rim paint can be damaged.

- ▶ Press the wheel firmly against the wheel hub when screwing on the first wheel bolt.

- ▶ Tighten the wheel bolts evenly in a diagonal pattern in the order indicated until they are finger-tight.
- ▶ Unscrew and remove the alignment bolt.
- ▶ Tighten the last wheel bolt until it is finger-tight.
- ▶ Lower the vehicle (→ page 386).

**Lowering the vehicle after a wheel change****Requirements:**

- The new wheel has been installed (→ page 385).

- ▶ **To lower the vehicle:** turn the crank of the jack counter-clockwise until the vehicle is once again standing firmly on the ground.

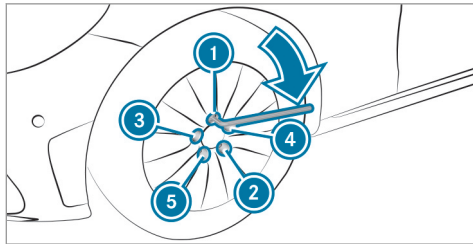

- ▶ Tighten the wheel bolts evenly in a diagonal pattern in the order indicated ① to ⑤ with an initial maximum force of 59 lb-ft (80 Nm).
- ▶ Tighten the wheel bolts evenly in a diagonal pattern in the order indicated ① to ⑤ to the specified tightening torque of 96 lb-ft (130 Nm).

**⚠ WARNING** Risk of accident due to incorrect tightening torque

The wheels could come loose if the wheel bolts or wheel nuts are not tightened to the prescribed torque.

- ▶ Ensure that the wheel bolts or wheel nuts are tightened to the prescribed tightening torque.
- ▶ If you are not sure, do not move the vehicle. Contact a qualified specialist workshop and have the tightening torque checked immediately.

- ▶ Check the tire pressure of the newly installed wheel and adjust it if necessary.

**i** The following does not apply if the new wheel is an emergency spare wheel.

- ▶ **Vehicles with tire pressure loss warning system:** Restart the tire pressure loss warning system (→ page 365).
- ▶ **Vehicles with a tire pressure monitoring system:** Restart the tire pressure monitoring system (→ page 364).

## Emergency spare wheel

### Notes on the emergency spare wheel

**⚠ WARNING** Risk of accident caused by incorrect wheel and tire dimensions

The wheel or tire size and the tire type of the emergency spare wheel or spare wheel and the wheel to be replaced may differ. The emergency spare wheel or spare wheel can significantly impair driving characteristics of the vehicle.

To prevent hazardous situations:

- ▶ Adapt your driving style accordingly and drive carefully.
- ▶ Never install more than one emergency spare wheel or spare wheel that differs in size.
- ▶ Only use an emergency spare wheel or spare wheel of a different size briefly.
- ▶ Do not switch off ESP®.
- ▶ Have the emergency spare wheel or spare wheel of a different size replaced

at the nearest qualified specialist workshop. The new wheel must have the correct dimensions.

- i** The emergency spare wheel is secured in the emergency spare wheel bag in the trunk.

Observe the following notes on installing an emergency spare wheel:

- Check the tire pressure of the emergency spare wheel installed. Correct the pressure as necessary.
  - The maximum permissible speed with an emergency spare wheel installed is 50 mph (80 km/h).
  - Do not install the emergency spare wheel with snow chains.
  - Replace the emergency spare wheel after six years at the latest, regardless of wear.
- i** **Vehicles with a tire pressure loss warning system:** If an emergency spare wheel is installed, the tire pressure loss warning system cannot function reliably. Only restart the

system again when the emergency spare wheel has been replaced with a new wheel.

**Vehicles with a tire pressure monitoring system:**

If an emergency spare wheel is installed, the tire pressure monitoring system cannot function reliably. For a few minutes after an emergency spare wheel is installed, the system may still display the tire pressure of the removed wheel. Only restart the system again when the emergency spare wheel has been replaced with a new wheel.

Be sure to also observe the following further related subjects:

- Notes on tire pressure (→ page 359)
- Tire and Loading Information placard (→ page 366)
- Tire pressure table (→ page 361)
- Notes on installing tires (→ page 378)

### Notes on technical data

#### **!** NOTE Mercedes-AMG vehicles

- ▶ Observe the notes in the Supplement. You could otherwise fail to recognize dangers.

The data stated only applies to vehicles with standard equipment. You can obtain further information from an authorized Mercedes-Benz Center.

### Vehicle electronics

#### Two-way radios

##### Notes on installing two-way radios

#### **!** WARNING Risk of accident due to improper work on two-way radios

If two-way radios are manipulated or retrofitted incorrectly, the electromagnetic radiation from the two-way radios can interfere with the vehicle electronics and jeopardize the operating safety of the vehicle.

- ▶ You should have all work on electrical and electronic components carried out at a qualified specialist workshop.

#### **!** WARNING Risk of accident due to improper operation of two-way radios

If you use two-way radios in the vehicle improperly, their electromagnetic radiation can disrupt the vehicle's electronics. This is the case in the following situations, in particular:

- The two-way radio is not connected to an exterior antenna.
- The exterior antenna is installed incorrectly or is not a low-reflection antenna.

This could jeopardize the operating safety of the vehicle.

- ▶ Have the low-reflection exterior antenna installed at a qualified specialist workshop.

- ▶ When operating two-way radios in the vehicle, always connect them to the low-reflection exterior antenna.

#### **!** NOTE Invalidation of the operating permit due to failure to comply with the instructions for installation and use

The operating permit may be invalidated if the instructions for installation and use of two-way radios are not observed.

- ▶ Only use approved frequency bands.
- ▶ Observe the maximum permissible output power in these frequency bands.
- ▶ Only use approved antenna positions.

On vehicles with a panoramic sliding sunroof, installing an antenna to the front or rear roof area is not permitted.

Use Technical Specification ISO/TS 21609 (Road Vehicles - "EMCs for installation of aftermarket radio frequency transmitting equipment") when retrofitting two-way radios. Comply with the legal requirements for detachable parts.

## 390 Technical data

If your vehicle has installing for two-way radio equipment, use the power supply and antenna connectors provided in the pre-installation. Observe the manufacturer's supplements when installing.

### Two-way radio transmission output

The maximum transmission output (PEAK) at the base of the antenna must not exceed the values in the following table.

### Frequency band and maximum transmission output

Frequency band	Maximum transmission output
Short wave 3 - 54 MHz	100 W
4 m frequency band 74 - 88 MHz	30 W
2 m frequency band 144 - 174 MHz	50 W

Frequency band	Maximum transmission output
Terrestrial Trunked Radio (TETRA) 380 - 460 MHz	10 W
70 cm frequency band 420 - 450 MHz	35 W
Two-way radio (2G/3G/4G)	10 W

The following can be used in the vehicle without restrictions:

- Two-way radios with a maximum transmission output of up to 100 mW
- RF transmitters with transmitter frequencies in the 380 - 410 MHz frequency band and a maximum transmission output of up to 2 W (TETRA)
- Mobile phones (2G/3G/4G)

There are no restrictions when positioning the antenna on the outside of the vehicle for the following frequency bands:

- Terrestrial Trunked Radio (TETRA)
- 70 cm frequency band
- 2G/3G/4G

### Regulatory radio identification of small components

Manufacturer information about radio-based vehicle components can be found using the key phrase "Regulatory radio identification" in the Digital Operator's Manual in the vehicle, on the Internet and in the app.



Vehicle identification plate, VIN and engine number overview

Vehicle identification plate

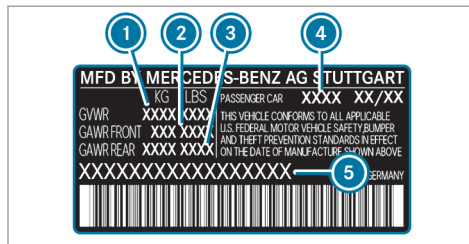
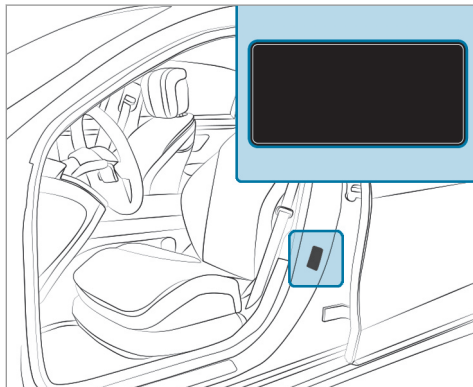

Vehicle identification plate (USA only)

- ① Maximum permissible gross vehicle weight
- ② Maximum permissible front axle load
- ③ Maximum permissible rear axle load
- ④ Paint code
- ⑤ VIN (vehicle identification number)

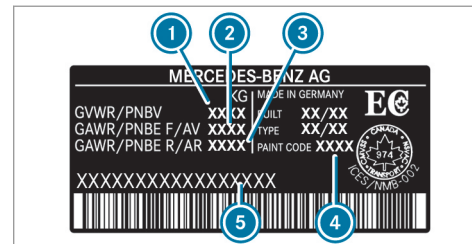

Vehicle identification plate (Canada only)

- ① Maximum permissible gross vehicle weight
- ② Maximum permissible front axle load
- ③ Maximum permissible rear axle load
- ④ Paint code
- ⑤ VIN (vehicle identification number)

The maximum permissible gross vehicle weight is made up of the vehicle weight, all vehicle occupants, the fuel and the load. The maximum gross axle weight rating is the maximum weight that can be carried on one axle (front or rear axle).

Do not exceed the maximum gross vehicle weight or the maximum gross axle weight rating for the front or rear axle.

### VIN below right-hand front seat

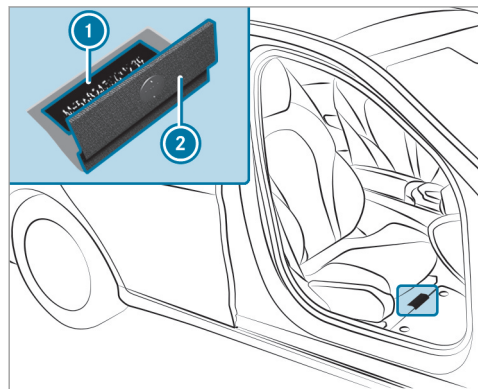

- ① Imprinted VIN (vehicle identification number)
- ② Floor covering

### Additional plates

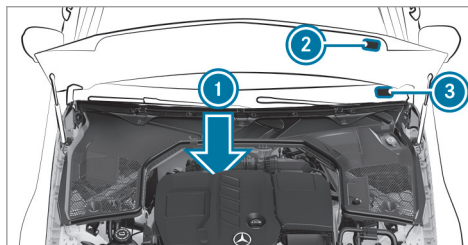

- ① Engine number stamped into the crankcase
- ② Plate with information about emissions testing, including confirmation of emissions guidelines at the U.S. federal level as well as for California
- ③ VIN (vehicle identification number) as a label at the lower edge of the windshield

### Operating fluids

#### Notes on operating fluids

##### ! NOTE Mercedes-AMG vehicles

- ▶ Observe the notes in the Supplement. You could otherwise fail to recognize dangers.

##### ⚠ WARNING Risk of injury from operating fluids harmful to your health

Operating fluids may be poisonous and harmful to your health.

- ▶ Observe the text on the original containers when using, storing or disposing of operating fluids.
- ▶ Always store operating fluids sealed in their original containers.
- ▶ Always keep children away from operating fluids.



**ENVIRONMENTAL NOTE** Environmental pollution due to disposing of operating fluids in a non-environmentally responsible manner

Operating fluids include the following:

- fuels
- exhaust gas aftertreatment additives, e.g. DEF
- lubricants

Incorrect disposal of operating fluids can cause considerable damage to the environment.

- ▶ Dispose of operating fluids in an environmentally responsible manner.

Operating fluids include the following:

- Fuels
- Lubricants
- Coolant
- Brake fluid
- Windshield washer fluid

- Climate control system refrigerant

Only use products approved by Mercedes-Benz. Damage caused by the use of products that have not been approved is not covered by the Mercedes-Benz warranty or goodwill gestures.

The operating fluids approved by Mercedes-Benz can be identified by the following inscriptions on the container:

- MB-Freigabe (e.g. MB-Freigabe 229.51)
- MB-Approval (e.g. MB-Approval 229.51)

Further information on approved operating fluids:

- in the Mercedes-Benz Specifications for Operating Fluids by entering the designation
  - at <https://bevo.mercedes-benz.com>
  - in the Mercedes-Benz BeVo app
- at a qualified specialist workshop



**WARNING** Risk of fire or explosion from fuel

Fuels are highly flammable.

- ▶ Fire, open flames, smoking and creation of sparks must be avoided.
- ▶ Switch off the ignition and, if available, the stationary heater, before and while refueling the vehicle.

**WARNING** Risk of injury from fuels

Fuels are poisonous and hazardous to your health.

- ▶ Do not swallow fuel or let it come into contact with skin, eyes or clothing.
- ▶ Do not inhale fuel vapor.
- ▶ Keep children away from fuel.
- ▶ Keep doors and windows closed during the refueling process.

If you or other people come into contact with fuel, observe the following:

- ▶ Immediately rinse fuel off your skin with soap and water.
- ▶ If fuel comes into contact with your eyes, immediately rinse them thor-

oroughly with clean water. Seek medical attention immediately.

- ▶ If you swallow fuel, seek medical attention immediately. Do not induce vomiting.
- ▶ Change immediately out of clothing that has come into contact with fuel.

Flexible-fuel vehicles can be refueled with the following fuel types:

- Unleaded premium grade gasoline
- E85 fuel
- A mixture of E85 fuel and unleaded premium grade gasoline

Flexible-fuel vehicles can be identified by the **Ethanol up to E85** sticker on the inside of the fuel filler flap.

Depending on the country, the fuels you can use in your vehicle may differ from the information in the Operator's Manual. The fuels that have been approved for your vehicle can be found on the instruction label on the inside of the fuel filler flap.

## Fuel

### Notes on fuel grades for vehicles with a gasoline engine

Observe the notes on operating fluids (→ page 392).

#### **!** NOTE Damage caused by the wrong fuel

Even small amounts of the wrong fuel could result in damage to the fuel system, the engine and the emission control system.

- ▶ Only refuel with low-sulfur gasoline.

This fuel may contain up to 10% ethanol by volume. Your vehicle is suitable for use with E10 fuel.

Never refuel with one of the following fuels:

- Diesel
- Gasoline with more than 10% ethanol by volume, e.g. E15, E85, E100
- Gasoline with more than 3% methanol by volume, e.g. M15, M30, M85, M100
- Gasoline with additives containing metal

If you have accidentally refueled with the wrong fuel:

- ▶ do not switch the ignition on.
- ▶ Consult a qualified specialist workshop.

If the available fuel is not sufficiently low in sulfur, this can produce unpleasant odors.

Only refuel with fuel that has at least the octane number specified in the information label in the fuel filler flap (→ page 145).

**If you want maximum engine output:** only refuel with unleaded premium grade gasoline with an octane number of at least 91 AKI/95 RON.

As a temporary measure, if the recommended fuel is not available, you may also refuel with unleaded regular gasoline with at least 87 AKI/91 RON. This may reduce engine output and increase fuel consumption.

Never refuel using gasoline with an even lower RON.

**!** **NOTE** Premature wear through unleaded regular gasoline

Unleaded regular gasoline can cause the engine to wear more quickly and impair longevity and performance.

If unleaded premium grade gasoline is unavailable and you have to refuel using unleaded regular gasoline:

- ▶ Only fill the fuel tank to half full with unleaded regular gasoline and refill as soon as possible with unleaded premium grade gasoline.
- ▶ Do not drive at the maximum design speed.
- ▶ Avoid sudden acceleration engine speeds over 3000 rpm.

Further information on fuel is available at the following locations:

- at a gas station
- at a qualified specialist workshop
- on the <https://www.mbusa.com> (USA only)

### Notes on additives in gasoline

Observe the notes on operating fluids (→ page 392).

**!** **NOTE** Damage from use of unsuitable additives

Even small amounts of the wrong additive may lead to malfunctions occurring.

- ▶ Only add cleaning additives recommended by Mercedes-Benz to the fuel.

Mercedes-Benz recommends that you use brand-name fuels with additives.

In some countries, the fuel available may not have sufficient additives. Residue could build up in the fuel injection system as a result. In this case, in consultation with an authorized Mercedes-Benz Center, mix the fuel with the cleaning additive recommended by Mercedes-Benz. Observe the notes and mixing ratios indicated on the tank.

### Tank content and reserve fuel

Model	Total capacity
All models	17.4 gal (66.0 liters)
Model	Of which reserve
All models	1.9 gal (7.0 liters)

### Engine oil

#### Notes on engine oil

Observe the notes on operating fluids (→ page 392).



**!** **NOTE** Engine damage caused by an incorrect oil filter, incorrect oil or additives

- ▶ Do not use engine oils or oil filters other than those which meet the specifications necessary for the prescribed service intervals.
- ▶ Do not alter the engine oil or oil filter in order to achieve longer change intervals than prescribed.
- ▶ Do not use additives.
- ▶ Have the engine oil changed after the prescribed intervals.

Mercedes-Benz recommends that you have the oil change carried out at a qualified specialist workshop.

### Quality and capacity of engine oil

Gasoline engines	MB-Freigabe or MB-Approval
All models	229.51, 229.52, 229.61 229.71*

\* Recommended for lowest possible fuel consumption (lowest SAE viscosity class in each case; observe possible restrictions of the approved SAE viscosity classes).

To achieve the lowest possible fuel consumption, it is recommended to use the engine oil specifications marked in the table for the lowest SAE viscosity class. Possible restrictions of the approved SAE viscosity classes must be observed.

The following values refer to an oil change, including the oil filter.

Model	Capacity
C 300	7.0 US qt (6.6 liters)
C 300 4MATIC	6.3 US qt (6.0 liters)

### Notes on brake fluid

Observe the notes on operating fluids (→ page 392).

**!** **WARNING** Risk of an accident due to vapor pockets forming in the brake system

The brake fluid constantly absorbs moisture from the air. This lowers the boiling point of the brake fluid. If the boiling point is too low, vapor pockets may form in the brake system when the brakes are applied hard.

This causes the braking effect to be impaired.

- ▶ Have the brake fluid renewed at the specified intervals.

Have the brake fluid regularly replaced at a qualified specialist workshop.  
Only use a brake fluid approved by Mercedes-Benz according to MB-Freigabe or MB-Approval 331.0.

## Coolant

### Notes on coolant

Observe the notes on operating fluids (→ page 392).

**⚠ WARNING** - Risk of fire and injury from antifreeze

If antifreeze comes into contact with hot component parts in the engine compartment, it may ignite.

- ▶ Allow the engine to cool down before adding antifreeze.
- ▶ Make sure that no antifreeze spills out next to the filler opening.
- ▶ Thoroughly clean off any antifreeze from component parts before starting the vehicle.

**!** **NOTE** Damage caused by incorrect coolant

- ▶ Only use coolant that has been pre-mixed with the required antifreeze protection.

Information on coolant is available at the following locations:

- In the Mercedes-Benz Specifications for Operating Fluids 310.1
  - At <https://bevo.mercedes-benz.com>
  - In the Mercedes-Benz BeVo app
- At a qualified specialist workshop

**!** **NOTE** Overheating at high outside temperatures

If an inappropriate coolant is used, the engine cooling system is not sufficiently protected against overheating and corrosion at high outside temperatures.

- ▶ Always use coolant approved by Mercedes-Benz.

- ▶ Observe the instructions in the Mercedes-Benz Specifications for Operating Fluids 310.1.

Have the coolant regularly replaced at a qualified specialist workshop.

Proportion of antifreeze concentrate in the engine cooling system:

- A minimum of 50% (antifreeze protection down to approximately -35°F (-37°C))
- A maximum of 55% (antifreeze protection down to -49°F (-45°C))

### Coolant capacity

Model	Capacity
All models	9.5 US qt (9.0 liters)

### Notes on windshield washer fluid

Observe the notes on operating fluids (→ page 392).

**⚠ WARNING** - Risk of fire and injury from windshield washer concentrate

Windshield washer concentrate is highly flammable. It could ignite if it comes into contact with hot engine component parts or the exhaust system.

- ▶ Make sure that no windshield washer concentrate spills out next to the filler opening.

**⚠ NOTE** Damage to the exterior lighting due to unsuitable windshield washer fluid

Unsuitable windshield washer fluid may damage the plastic surface of the exterior lighting.

- ▶ Only use windshield washer fluid which is also suitable for use on plastic surfaces, e.g. MB SummerFit or MB WinterFit.

**⚠ NOTE** Blocked spray nozzles caused by mixing windshield washer fluids

- ▶ Do not mix MB SummerFit and MB WinterFit with other windshield washer fluids.

Do not use distilled or de-ionized water. Otherwise, the fill level sensor may be triggered erroneously.

Recommended windshield washer fluid:

- Above freezing point: e.g. MB SummerFit
- Below freezing point: e.g. MB WinterFit

For the correct mixing ratio, refer to the information on the antifreeze container.

Mix washer fluid with windshield washer fluid all year round.

### Refrigerant

#### Notes on refrigerant

Observe the notes on operating fluids (→ page 392).

**⚠ NOTE** Damage due to incorrect refrigerant

If a non-approved refrigerant is used, the climate control system may be damaged.

- ▶ **USA:** use only R-134a refrigerant.
- ▶ **Canada:** use only R-1234yf refrigerant.

**⚠ NOTE** Damage to the climate control system due to incorrect refrigerant compressor oil

- ▶ Only use refrigerant compressor oil that has been approved by Mercedes-Benz.
- ▶ Do not mix the approved refrigerant compressor oil with a different refrigerant compressor oil.

Work on the climate control system may be carried out only by a qualified specialist workshop. All applicable regulations, as well as SAE standard J639, must be adhered to.

The information label for the climate control system regarding the refrigerant type and the refrigerant



erant compressor oil (PAG oil) is located on the inside of the hood.

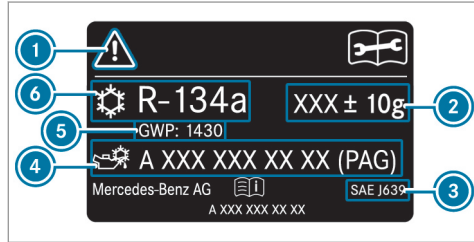

Information label (example - USA/China)

- ① Hazard and service warning symbols
- ② Refrigerant filling capacity
- ③ Applicable standards
- ④ PAG oil part number
- ⑤ GWP (global warming potential) of the refrigerant used
- ⑥ Refrigerant type

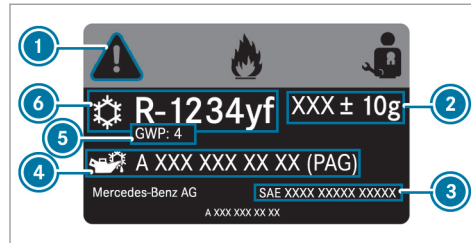

Information label (example - Canada)

- ① Hazard and service warning symbols
- ② Refrigerant filling capacity
- ③ Applicable standards
- ④ PAG oil part number
- ⑤ GWP (global warming potential) of the refrigerant used
- ⑥ Refrigerant type

Symbols ① indicate the following:

- Possible dangers
- The need to have service work carried out at a qualified specialist workshop only

### Filling capacity for refrigerant and PAG oil

Model	Refrigerant
All models	22.2 ± 0.4 oz (630 ± 10 g)
Model	PAG oil
All models	2.8 ± 0.4 oz (80 ± 10 g)

### Vehicle data

#### Vehicle dimensions

The heights specified may vary as a result of the following factors:

- Tires
- Load
- Condition of the suspension
- Optional equipment

## Height when opened

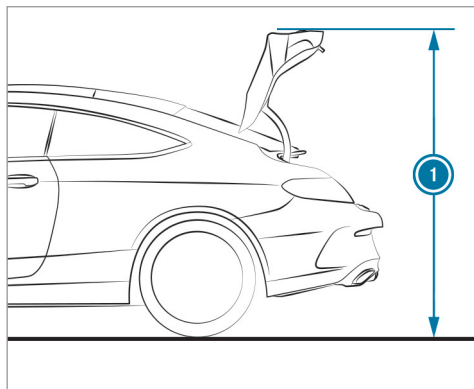

Missing values were not available at time of going to print.

Model	① Height when opened
C 300	
C 300 4MATIC	

## Vehicle dimensions

All models	
Vehicle length	184.5 in (4686 mm)
Vehicle width including outside mirrors	79.4 in (2016 mm)
Wheelbase	111.8 in (2840 mm)

## Vehicle height

C 300	55.3 in (1405 mm)
C 300 4MATIC	55.6 in (1413 mm)

## Turning radius

C 300	
C 300 4MATIC	

## Weights and loads

Please observe the following notes for the specified vehicle data:

- Items of optional equipment increase the curb weight and reduce the payload.

Model	Maximum roof load
All models	165 lb (75 kg)

## Display messages

### Introduction



#### Notes about display messages

Display messages appear on the multifunction display.

Display messages with graphics are simplified in the Operator's Manual and may differ from the appearance on the multifunction display. The multifunction display shows high-priority display messages in red. Certain display messages are accompanied by a warning tone.

Please act in accordance with the display messages and follow the additional notes in the Operator's Manual.

For some display messages, a symbol will also be shown:

-  Further information
-  Hide display message

With the left-hand Touch Control, you can select the respective symbol by swiping to the left or right. Press the  symbol to show further infor-

mation on the media display. Press the  symbol to hide the display message.

You can hide low-priority display messages by pressing the  back button or the left-hand Touch Control. The display messages will then be stored in the message memory.

Rectify the cause of a display message as quickly as possible.

High-priority display messages cannot be hidden. The multifunction display shows these display messages continuously until the cause of the display message has been rectified.

#### Calling up saved display messages

On-board computer:



 [Service](#)  [1 Message](#)

If there are no display messages, [No Messages](#) will appear on the multifunction display.

 Scroll through the display messages by swiping upwards or downwards on the left-hand Touch Control.

 **To exit the message memory:** press the back button .

Occupant safety

Display messages	Possible causes/consequences and ► Solutions
 <p>SRS Malfunction Service Required</p>	<p>* The restraint system is malfunctioning (→ page 36).</p> <p><b>▲ WARNING</b> Risk of injury due to malfunctions in the restraint system</p> <p>Components in the restraint system may be activated unintentionally or not deploy as planned in an accident.</p> <p>► Have the restraint system checked and repaired immediately at a qualified specialist workshop.</p>
 <p>Front Left Malfunction Service Required (example)</p>	<p>* The corresponding restraint system is malfunctioning (→ page 36).</p> <p><b>▲ WARNING</b> Risk of injury due to malfunctions in the restraint system</p> <p>Components in the restraint system may be activated unintentionally or not deploy as planned in an accident.</p> <p>► Have the restraint system checked and repaired immediately at a qualified specialist workshop.</p>
 <p>Left Side Curtain Airbag Malfunction Service Required (example)</p>	<p>* The corresponding restraint system is malfunctioning (→ page 36).</p> <p><b>▲ WARNING</b> Risk of injury or fatal injury due to a malfunction in the window curtain airbag</p> <p>The window curtain airbag might be triggered unintentionally or might not be triggered at all in the event of an accident.</p> <p>► Have the window curtain airbag checked and repaired immediately at a qualified specialist workshop.</p>

Display messages	Possible causes/consequences and ► Solutions
<p>Front Passenger Airbag Disabled See Operator's Manual</p>	<p>* The front passenger airbag and the front passenger knee airbag have been disabled even though an adult or a person of adult stature is on the front passenger seat. If additional forces are applied to the seat, the weight the system detects may be too low.</p> <div data-bbox="550 346 1696 550" style="border: 1px solid gray; padding: 5px;"> <p><b>▲ WARNING</b> Risk of injury or fatal injury due to a disabled front passenger airbag</p> <p>If the front passenger airbag is disabled, the front passenger airbag will not be deployed in the event of an accident and cannot perform its intended protective function.</p> <p>A person in the front passenger seat could then, for example, come into contact with the vehicle's interior, especially if the person is sitting too close to the cockpit.</p> <p>► Make sure, both before and during the journey, that the status of the front passenger airbag is correct.</p> </div> <ul style="list-style-type: none"> <li>► Stop the vehicle immediately in accordance with the traffic conditions.</li> <li>► Make sure that no objects are trapped under the front passenger seat.</li> <li>► Check the status of automatic front passenger airbag actuation (→ page 47).</li> <li>► If necessary, consult a qualified specialist workshop immediately.</li> </ul>
<p>Front Passenger Airbag Enabled See Operator's Manual</p>	<p>* The front passenger airbag and the front passenger knee airbag will be enabled while the vehicle is in motion in the following situations:</p> <ul style="list-style-type: none"> <li>• Even when a child, a small adult or an object weighing less than the system weight threshold is located on the front passenger seat</li> <li>• Even when the front passenger seat is not occupied</li> </ul>

#### 404 Display messages and warning/indicator lamps

Display messages	Possible causes/consequences and ► Solutions
	<p>The system may detect objects or forces that are adding to the weight applied to the seat.</p> <p><b>▲ WARNING</b> Risk of injury or death when using a child restraint system while the front passenger airbag is enabled</p> <p>If you secure a child in a child restraint system on the front passenger seat and the front passenger airbag is enabled, the front passenger airbag can deploy in the event of an accident. The child could be struck by the airbag.</p> <p>► Ensure, both before and during the journey, that the status of the front passenger airbag is correct.</p> <p>NEVER use a rearward facing child restraint on a seat protected by an ACTIVE AIRBAG in front of it, DEATH or SERIOUS INJURY to the CHILD can occur.</p> <ul style="list-style-type: none"><li>► Stop the vehicle immediately in accordance with the traffic conditions.</li><li>► Make sure that no objects are trapped under the front passenger seat.</li><li>► Check the status of automatic front passenger airbag actuation (→ page 47).</li><li>► If necessary, consult a qualified specialist workshop immediately.</li></ul>
<a href="#">PRE-SAFE Inoperative See Operator's Manual</a>	<p>* The PRE-SAFE® functions are malfunctioning.</p> <ul style="list-style-type: none"><li>► Consult a qualified specialist workshop.</li></ul>

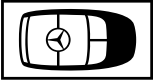
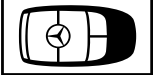
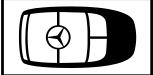

## SmartKey

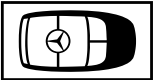
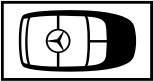



Display messages	Possible causes/consequences and ► Solutions
 <p data-bbox="195 384 376 407">Obtain a New Key</p>	<ul style="list-style-type: none"> <li data-bbox="519 291 796 313">* Have SmartKey replaced.</li> <li data-bbox="543 324 975 347">► Consult a qualified specialist workshop.</li> </ul>
 <p data-bbox="195 524 399 547">Replace Key Battery</p>	<ul style="list-style-type: none"> <li data-bbox="519 433 907 455">* The SmartKey battery is discharged.</li> <li data-bbox="543 466 916 488">► Replace the battery (→ page 65).</li> </ul>
 <p data-bbox="195 664 445 717">Key Not Detected (white display message)</p>	<ul style="list-style-type: none"> <li data-bbox="519 576 925 598">* The SmartKey is currently undetected.</li> <li data-bbox="543 609 1092 631">► Change the location of the SmartKey in the vehicle.</li> <li data-bbox="543 642 1554 696">► If the SmartKey is still not recognized, place it in the marked space for starting with the SmartKey (→ page 130).</li> </ul>

Display messages	Possible causes/consequences and ► Solutions
 <p>Key Not Detected (red display message)</p>	<p>* The SmartKey cannot be detected and may no longer be in the vehicle. The SmartKey is no longer in the vehicle and you switch off the engine:</p> <ul style="list-style-type: none"> <li>• You can no longer start the engine.</li> <li>• You cannot centrally lock the vehicle.</li> </ul> <p>► Ensure that the SmartKey is in the vehicle.</p> <p>If the SmartKey detection function has a malfunction due to a strong radio signal source:</p> <ul style="list-style-type: none"> <li>► Stop the vehicle immediately in accordance with the traffic conditions.</li> <li>► Place the SmartKey in the marked space for starting the engine with the SmartKey (→ page 130).</li> </ul>
 <p>Don't Forget Your Key</p>	<p>* A warning tone will also sound. This message reminds you to take your SmartKey with you when you leave the vehicle.</p>
<p>Place the Key in the Marked Space See Operator's Manual</p>	<p>* SmartKey detection is malfunctioning.</p> <ul style="list-style-type: none"> <li>► Change the location of the SmartKey in the vehicle.</li> <li>► Place the SmartKey in the marked space for starting the engine with the SmartKey (→ page 130).</li> </ul>



## Lights

Display messages	Possible causes/consequences and ► Solutions
 <p data-bbox="195 384 358 436">Check Left Low Beam (example)</p>	<ul style="list-style-type: none"> <li data-bbox="524 291 981 314">* The corresponding light source is defective.               <ul style="list-style-type: none"> <li data-bbox="543 325 759 349">► Drive on carefully.</li> <li data-bbox="543 359 1068 383">► Visit a qualified specialist workshop immediately.</li> </ul> </li> <li data-bbox="543 393 1646 442">ⓘ LED light sources: the display message for the corresponding light appears only when all the light-emitting diodes in the light are faulty.</li> </ul>
 <p data-bbox="195 556 436 603">Malfunction See Operator's Manual</p>	<ul style="list-style-type: none"> <li data-bbox="524 463 925 486">* The exterior lighting is malfunctioning.               <ul style="list-style-type: none"> <li data-bbox="543 497 975 521">► Consult a qualified specialist workshop.</li> </ul> </li> </ul>
 <p data-bbox="195 724 469 771">Automatic Headlamp Mode Inoperative</p>	<ul style="list-style-type: none"> <li data-bbox="524 630 1160 654">* The light sensor for automatic driving lights is malfunctioning.               <ul style="list-style-type: none"> <li data-bbox="543 665 975 688">► Consult a qualified specialist workshop.</li> </ul> </li> </ul>



Display messages	Possible causes/consequences and ► Solutions
 <p data-bbox="144 342 417 391">Active Headlamps Inoperative</p>	<ul style="list-style-type: none"> <li>* The active headlamps are malfunctioning.                             <ul style="list-style-type: none"> <li>► Consult a qualified specialist workshop.</li> </ul> </li> </ul>
 <p data-bbox="144 510 369 536">Switch On Headlamps</p>	<ul style="list-style-type: none"> <li>* You are driving without low-beam headlamps.                             <ul style="list-style-type: none"> <li>► Turn the light switch to the  or <b>AUTO</b> position.</li> </ul> </li> </ul>
 <p data-bbox="144 653 317 679">Switch Off Lights</p>	<ul style="list-style-type: none"> <li>* You are leaving the vehicle and the lights are still switched on.                             <ul style="list-style-type: none"> <li>► Turn the light switch to the <b>AUTO</b> position.</li> </ul> </li> </ul>
 <p data-bbox="144 796 417 845">Intell. Light System Inoperative</p>	<ul style="list-style-type: none"> <li>* The Intelligent Light System is malfunctioning. The lighting system continues to function properly without the functions of the Intelligent Light System.                             <ul style="list-style-type: none"> <li>► Consult a qualified specialist workshop.</li> </ul> </li> </ul>



Display messages	Possible causes/consequences and ► Solutions
<p>Adaptive Highbeam Assist Currently Unavailable See Operator's Manual</p>	<p>* Adaptive Highbeam Assist is temporarily unavailable. The system limits have been reached (→ page 115). Once the cause of the problem is no longer present, the system will be available again. The <a href="#">Adaptive Highbeam Assist Now Available</a> display message will appear.</p> <ul style="list-style-type: none"> <li>► Drive on.</li> <li>► Operate the high beam manually until Adaptive High Beam Assist is available again.</li> </ul>
<p>Adaptive Highbeam Assist Inoperative</p>	<p>* Adaptive Highbeam Assist is malfunctioning.</p> <ul style="list-style-type: none"> <li>► Consult a qualified specialist workshop.</li> </ul>
<p>Adaptive Highbeam Assist Camera View Restricted See Operator's Manual</p>	<p>* The camera view is restricted. Possible causes:</p> <ul style="list-style-type: none"> <li>• Dirt on the windshield in the camera's field of vision</li> <li>• Heavy rain, snow or fog</li> </ul> <p>Driving systems and driving safety systems may be malfunctioning or temporarily unavailable. Once the cause of the problem is no longer present, the driving systems and driving safety systems will be available again.</p> <p>If the display message does not disappear:</p> <ul style="list-style-type: none"> <li>► Stop the vehicle in accordance with the traffic conditions.</li> <li>► Clean the windshield.</li> </ul>



## 410 Display messages and warning/indicator lamps

Display messages	Possible causes/consequences and ► Solutions
Hazard Warning Flashers Malfunctioning	<ul style="list-style-type: none"><li>* The hazard warning lamp switch is malfunctioning.<ul style="list-style-type: none"><li>► Consult a qualified specialist workshop.</li></ul></li></ul>

### Vehicle

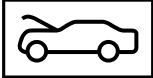
Display messages	Possible causes/consequences and ► Solutions
 Vehicle Ready to Drive Switch the Ignition Off Before Exiting	<ul style="list-style-type: none"><li>* You are leaving the vehicle in a ready-to-drive state.<ul style="list-style-type: none"><li>► When you leave the vehicle, switch off the ignition, secure the vehicle against rolling away and take the Smart-Key with you.</li><li>► If you do not leave the vehicle, switch off the electrical consumers, e.g. the seat heating. Otherwise, the 12-V battery may discharge and starting the engine may be possible only with the help of a second battery (jump start).</li></ul></li></ul>
 Steering Malfunction Increased Physical Effort See Operator's Manual	<ul style="list-style-type: none"><li>* The power steering assistance is malfunctioning.<ul style="list-style-type: none"><li><b>▲ WARNING</b> Risk of an accident due to altered steering characteristics</li><li>If the power assistance of the steering fails partially or completely, you will need to use more force to steer.<ul style="list-style-type: none"><li>► If safe steering is possible, drive on carefully.</li><li>► Visit or consult a qualified specialist workshop immediately.</li></ul></li></ul></li></ul>

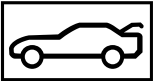

Display messages	Possible causes/consequences and ► Solutions
 <p data-bbox="194 342 462 418">Steering Malfunction Stop Immediately See Operator's Manual</p>	<p data-bbox="524 249 1289 275">* The steering is malfunctioning. Steering capability is significantly impaired.</p> <div data-bbox="550 291 1696 471" style="border: 1px solid gray; padding: 5px;"> <p data-bbox="559 301 1204 327">▲ <b>WARNING</b> Risk of accident if steering capability is impaired</p> <p data-bbox="559 339 1461 365">If the steering does not function as intended, the vehicle's operating safety is jeopardized.</p> <ul style="list-style-type: none"> <li data-bbox="559 376 1633 427">▶ Pull over and stop the vehicle safely as soon as possible, paying attention to road and traffic conditions. Do not continue driving under any circumstances.</li> <li data-bbox="559 438 994 464">▶ Consult a qualified specialist workshop.</li> </ul> </div>
	<p data-bbox="524 487 802 513">* At least one door is open.</p> <ul style="list-style-type: none"> <li data-bbox="543 524 735 550">▶ Close all doors.</li> </ul>
	<p data-bbox="524 596 722 622">* The hood is open.</p> <div data-bbox="550 638 1696 788" style="border: 1px solid gray; padding: 5px;"> <p data-bbox="559 648 1264 674">▲ <b>WARNING</b> Risk of accident due to driving with the hood unlocked</p> <p data-bbox="559 686 968 712">The hood may open and block your view.</p> <ul style="list-style-type: none"> <li data-bbox="559 723 968 749">▶ Never release the hood when driving.</li> <li data-bbox="559 759 1086 785">▶ Before every trip, ensure that the hood is locked.</li> </ul> </div> <ul style="list-style-type: none"> <li data-bbox="543 806 1286 831">▶ Stop the vehicle immediately in accordance with the traffic conditions.</li> <li data-bbox="543 842 735 868">▶ Close the hood.</li> </ul>

Display messages	Possible causes/consequences and ► Solutions
	<p>* The trunk lid is open.</p> <div style="border: 1px solid black; padding: 5px; margin: 10px 0;"> <p><b>⚠ DANGER</b> Risk of exhaust gas poisoning</p> <p>Combustion engines emit poisonous exhaust gases such as carbon monoxide. Exhaust gases can enter the vehicle interior if the trunk lid is open when the engine is running, especially if the vehicle is in motion.</p> <ul style="list-style-type: none"> <li>▶ Always switch off the engine before opening the trunk lid.</li> <li>▶ Never drive with the trunk lid open.</li> </ul> </div> <p>► Close the trunk lid.</p>
 <p>Rear Left Backrest Not Latched (example)</p>	<p>* The seat backrest of the corresponding seat is not engaged.</p> <p>► Fold the seat backrest back until it engages.</p>
 <p>Front Left Seat Backrest Not Locked (example)</p>	<p>* The seat backrest of the corresponding front seat is not engaged.</p> <p>► Fold the seat backrest back until it engages.</p>



Display messages	Possible causes/consequences and ► Solutions
 <p data-bbox="195 342 399 365">Check Washer Fluid</p>	<ul style="list-style-type: none"> <li>* The washer fluid level in the washer fluid reservoir has dropped below the minimum.               <ul style="list-style-type: none"> <li>► Add washer fluid (→ page 328).</li> </ul> </li> </ul>

## Engine

Display messages	Possible causes/consequences and ► Solutions
<p data-bbox="195 518 469 619">To switch engine off, press and hold Start/Stop button for at least 3 secs. or press 3 times.</p>	<ul style="list-style-type: none"> <li>* You have pressed the start/stop button while the vehicle is in motion.               <ul style="list-style-type: none"> <li>► Information about switching off the engine while driving (→ page 129).</li> </ul> </li> </ul>
 <p data-bbox="195 740 450 788">Check Coolant Level See Operator's Manual</p>	<ul style="list-style-type: none"> <li>* The coolant level is too low.               <div data-bbox="550 689 1696 772" style="border: 1px solid black; padding: 5px; margin: 10px 0;"> <p><b>!</b> <b>NOTE</b> Engine damage due to insufficient coolant</p> <ul style="list-style-type: none"> <li>► Avoid long journeys with insufficient coolant.</li> </ul> </div> <ul style="list-style-type: none"> <li>► Add coolant (→ page 328).</li> <li>► Have the engine cooling system checked at a qualified specialist workshop.</li> </ul> </li> </ul>

Display messages	Possible causes/consequences and ► Solutions
 <p data-bbox="144 342 421 391">Coolant Too Hot Stop Vehicle Turn Engine Off</p>	<p data-bbox="476 249 717 270">* The coolant is too hot.</p> <ul style="list-style-type: none"><li data-bbox="495 280 1493 306">► Stop the vehicle immediately in accordance with the traffic conditions and switch off the engine.</li></ul> <div data-bbox="495 332 1644 588" style="border: 1px solid gray; padding: 5px;"><p data-bbox="506 342 1042 368"><b>⚠ WARNING</b> Risk of burns when opening the hood</p><p data-bbox="506 379 1596 430">If you open the hood when the engine has overheated or when there is a fire in the engine compartment, the following situations may occur:</p><ul style="list-style-type: none"><li data-bbox="519 441 986 462">• You could come into contact with hot gases.</li><li data-bbox="519 472 1245 498">• You could come into contact with other hot, escaping operating fluids.</li></ul><ul style="list-style-type: none"><li data-bbox="506 519 1227 544">► Before opening the hood, allow the overheated engine to cool down.</li><li data-bbox="506 555 1498 581">► In the event of a fire in the engine compartment, keep the hood closed and call the fire service.</li></ul></div> <ul style="list-style-type: none"><li data-bbox="495 607 916 627">► Wait until the engine has cooled down.</li><li data-bbox="495 638 1153 664">► Make sure that the air supply to the radiator is not obstructed.</li><li data-bbox="495 674 1618 726">► Avoiding high loads on the engine, drive to the nearest qualified specialist workshop. In doing so, ensure that the coolant temperature display remains below the red marking.</li></ul>
	<p data-bbox="476 746 722 767">* The fan motor is faulty.</p> <ul style="list-style-type: none"><li data-bbox="495 778 1618 829">► Avoiding high loads on the engine, drive to the nearest qualified specialist workshop. In doing so, ensure that the coolant temperature display remains below the red marking.</li></ul>



Display messages	Possible causes/consequences and ► Solutions
 Fuel Level Low	<ul style="list-style-type: none"> <li>* The fuel supply has dropped into the reserve range.               <ul style="list-style-type: none"> <li>► Refuel.</li> </ul> </li> </ul>
 Gas Cap Loose	<ul style="list-style-type: none"> <li>* The fuel filler cap is not closed correctly or the fuel system is leaking.               <ul style="list-style-type: none"> <li>► Close the fuel filler cap.</li> <li>► <b>If the fuel filler cap was already properly closed:</b> consult a qualified specialist workshop.</li> </ul> </li> </ul>

## Transmission

Display messages	Possible causes/consequences and ► Solutions
Only Shift to 'P' when Vehicle is Stationary	<ul style="list-style-type: none"> <li>* It is possible to select the park position <b>P</b> only if the vehicle is stationary.               <ul style="list-style-type: none"> <li>► To stop, depress the brake pedal.</li> <li>► Shift the transmission to park position <b>P</b> when the vehicle is stationary.</li> </ul> </li> </ul>
Apply Brake to Shift from 'P'	<ul style="list-style-type: none"> <li>* You have attempted to shift the transmission out of park position <b>P</b> and into another transmission position.               <ul style="list-style-type: none"> <li>► Depress the brake pedal.</li> <li>► Select transmission position <b>D</b>, <b>R</b> or neutral <b>N</b>.</li> </ul> </li> </ul>

## 416 Display messages and warning/indicator lamps





Display messages	Possible causes/consequences and ► Solutions
To Deselect P or N, Depress Brake and Start Engine	<ul style="list-style-type: none"><li>* You have attempted to shift the transmission out of park position <b>P</b> or neutral <b>N</b> and into another transmission position.<ul style="list-style-type: none"><li>► Depress the brake pedal.</li><li>► Start the vehicle.</li><li>► Change the transmission position.</li></ul></li></ul>
Apply Brake to Shift to 'R'	<ul style="list-style-type: none"><li>* You have attempted to select transmission position <b>R</b>.<ul style="list-style-type: none"><li>► Depress the brake pedal.</li><li>► Select transmission position <b>R</b>.</li></ul></li></ul>
Driver's Door Open & Transmission Not in P Risk of Vehicle Rolling Away	<ul style="list-style-type: none"><li>* The driver's door is not fully closed and transmission position <b>D</b>, <b>R</b> or neutral <b>N</b> is selected. The vehicle may roll away.<ul style="list-style-type: none"><li>► Select park position <b>P</b> when switching off the vehicle.</li></ul></li></ul>
N Permanently Active Risk of Rolling Away	<ul style="list-style-type: none"><li>* Neutral <b>N</b> has been selected while the vehicle is rolling or while you are driving.<ul style="list-style-type: none"><li>► Depress the brake pedal to stop.</li><li>► Shift the transmission to park position <b>P</b> while the vehicle is stationary.</li><li>► To continue driving, select transmission position <b>D</b> or <b>R</b>.</li></ul></li></ul>
Service Required Do Not Shift Gears Visit Dealer	<ul style="list-style-type: none"><li>* The transmission is malfunctioning. It is no longer possible to change the transmission position.<ul style="list-style-type: none"><li>► When transmission position <b>D</b> is selected, consult a qualified specialist workshop and do not change the transmission position.</li></ul></li></ul>





Display messages	Possible causes/consequences and ► Solutions
	<ul style="list-style-type: none"> <li>► For all other transmission positions, park the vehicle safely.</li> <li>► Consult a qualified specialist workshop or breakdown service.</li> </ul>
Reversing Not Possible Service Required	<ul style="list-style-type: none"> <li>* The transmission is malfunctioning. It is not possible to select transmission position <b>R</b>.</li> <li>► Consult a qualified specialist workshop.</li> </ul>
Transmission Malfunction Stop	<ul style="list-style-type: none"> <li>* The transmission is malfunctioning. The transmission shifts to neutral <b>N</b> automatically.</li> <li>► Stop the vehicle immediately in accordance with the traffic conditions.</li> <li>► Depress the brake pedal.</li> <li>► Engage park position <b>P</b>.</li> <li>► Consult a qualified specialist workshop.</li> </ul>
Stop Vehicle Leave Engine Running Wait Transmission Cooling	<ul style="list-style-type: none"> <li>* The transmission is overheating. Pulling away may be temporarily impaired or not possible.</li> <li>► Stop the vehicle immediately in accordance with the traffic conditions. Do not continue driving.</li> <li>► Leave the engine running.</li> <li>► Wait until the display message disappears before pulling away.</li> </ul>
Auxiliary Battery Malfunction (white display message)	<ul style="list-style-type: none"> <li>* The auxiliary battery for the transmission is no longer being charged.</li> <li>► Consult a qualified specialist workshop.</li> <li>► Until then, always select park position <b>P</b> manually before you switch off the engine.</li> <li>► Before leaving the vehicle, apply the electric parking brake.</li> </ul>



## 418 Display messages and warning/indicator lamps

Display messages	Possible causes/consequences and ► Solutions
Auxiliary Battery Malfunction (red display message)	<ul style="list-style-type: none"><li>* The auxiliary battery for the transmission is no longer being charged.<ul style="list-style-type: none"><li>► Consult a qualified specialist workshop.</li><li>► Until then, always select park position <b>P</b> manually before you switch off the engine.</li><li>► Before leaving the vehicle, apply the electric parking brake.</li></ul></li></ul>



## Brakes

Display messages	Possible causes/consequences and ► Solutions
 (USA only)  (Canada only) Parking Brake See Operator's Manual	<ul style="list-style-type: none"><li>* The yellow  indicator lamp is lit. The electric parking brake is malfunctioning. <b>To apply:</b><ul style="list-style-type: none"><li>► Switch the ignition off and switch it back on.</li><li>► Apply the electric parking brake manually (→ page 153).</li></ul> If it is not possible to apply the electric parking brake:<ul style="list-style-type: none"><li>► Consult a qualified specialist workshop.</li><li>► Where necessary, also secure the parked vehicle against rolling away.</li></ul></li><li>* The yellow  indicator lamp and the red <b>PARK</b> (USA only) or  (Canada only) indicator lamp are lit. The electric parking brake is malfunctioning. <b>To release:</b></li></ul>

Display messages	Possible causes/consequences and ► Solutions
	<ul style="list-style-type: none"> <li>► Switch the ignition off and switch it back on.</li> <li>► Release the electric parking brake manually (→ page 153).</li> </ul> <p>or</p> <ul style="list-style-type: none"> <li>► Release the electric parking brake automatically (→ page 152).</li> </ul> <p>If it is still not possible to release the electric parking brake:</p> <ul style="list-style-type: none"> <li>► Do not continue driving. Consult a qualified specialist workshop.</li> </ul> <p>* The yellow  indicator lamp is lit and the red  (USA only) or  (Canada only) indicator lamp is flashing. The electric parking brake is malfunctioning.</p> <p>The electric parking brake could not be applied or released.</p> <ul style="list-style-type: none"> <li>► Switch the ignition off and switch it back on.</li> </ul> <p><b>To apply:</b></p> <ul style="list-style-type: none"> <li>► Release and then apply the electric parking brake manually (→ page 153).</li> </ul> <p><b>To release:</b></p> <ul style="list-style-type: none"> <li>► Apply and then release the electric parking brake manually.</li> </ul> <p>If the electric parking brake cannot be applied or the red  (USA only) or  (Canada only) indicator lamp continues to flash:</p> <ul style="list-style-type: none"> <li>► Do not continue driving. Consult a qualified specialist workshop.</li> <li>► Where necessary, also secure the parked vehicle against rolling away.</li> </ul>

Display messages	Possible causes/consequences and ► Solutions
	<p>* The yellow  indicator lamp is lit and the red  (USA only) or  (Canada only) indicator lamp flashes for approximately ten seconds after the electric parking brake has been applied or released. It then remains lit or goes out. The electric parking brake is malfunctioning.</p> <p><b>If the state of charge is too low:</b></p> <ul style="list-style-type: none"><li>► Charge the 12 V battery.</li></ul> <p><b>To apply:</b></p> <ul style="list-style-type: none"><li>► Switch the ignition off. The electric parking brake will be applied automatically.</li></ul> <p>If you do not want the electric parking brake to be applied, e.g. at an automatic car wash or when the vehicle is being towed, leave the ignition switched on. This does not include having the vehicle towed with the rear axle raised.</p> <p>If the electric parking brake is not applied automatically:</p> <ul style="list-style-type: none"><li>► Switch the ignition off and switch it back on.</li><li>► Release and then apply the electric parking brake manually (→ page 153).</li></ul> <p>If it is still not possible to apply the electric parking brake:</p> <ul style="list-style-type: none"><li>► Consult a qualified specialist workshop.</li><li>► Where necessary, also secure the parked vehicle against rolling away.</li></ul>



Display messages	Possible causes/consequences and ► Solutions
	<p><b>To release:</b></p> <ul style="list-style-type: none"> <li>► If the conditions for automatic release are fulfilled and the electric parking brake is not released automatically, release the electric parking brake manually (→ page 153).</li> </ul> <p>If it is still not possible to release the electric parking brake:</p> <ul style="list-style-type: none"> <li>► Do not continue driving. Consult a qualified specialist workshop.</li> </ul>
<div data-bbox="205 441 362 521" style="border: 1px solid black; padding: 5px; text-align: center; font-weight: bold; font-size: 1.2em;">PARK</div> <p data-bbox="205 529 306 552">(USA only)</p> <div data-bbox="205 567 362 647" style="border: 1px solid black; padding: 5px; text-align: center; font-weight: bold; font-size: 1.2em;">(P)</div> <p data-bbox="205 655 343 678">(Canada only)</p> <p data-bbox="195 689 430 738">Please Release Parking Brake</p>	<p data-bbox="524 436 1430 458">* The red <span style="border: 1px solid black; padding: 0 2px;">PARK</span> indicator lamp (USA only) or <span style="border: 1px solid black; border-radius: 50%; padding: 0 2px;">(P)</span> indicator lamp (Canada only) is flashing.</p> <p data-bbox="543 470 1125 493">The electric parking brake is applied while you are driving:</p> <ul style="list-style-type: none"> <li>• A condition for automatic release of the electric parking brake has not been fulfilled (→ page 152).</li> <li>• You are performing emergency braking using the electric parking brake (→ page 153).</li> </ul> <ul style="list-style-type: none"> <li>► Check the conditions for automatic release of the electric parking brake.</li> <li>► Release the electric parking brake manually.</li> </ul>



Display messages	Possible causes/consequences and ► Solutions
<div data-bbox="155 252 312 332" data-label="Image"> </div> <p data-bbox="155 342 260 365">(USA only)</p> <div data-bbox="155 379 312 458" data-label="Image"> </div> <p data-bbox="155 469 291 492">(Canada only)</p> <p data-bbox="147 505 410 553">Turn On the Ignition to Release the Parking Brake</p>	<p data-bbox="473 249 1363 308">* The red  (USA only) or  (Canada only) indicator lamp is lit. You have attempted to release the electric parking brake with the ignition switched off.</p> <ul data-bbox="495 319 753 341" style="list-style-type: none"> <li>► Switch on the ignition.</li> </ul>
<div data-bbox="155 584 312 664" data-label="Image"> </div> <p data-bbox="147 674 253 697">(USA only)</p> <div data-bbox="155 710 312 790" data-label="Image"> </div> <p data-bbox="147 800 284 823">(Canada only)</p> <p data-bbox="147 837 389 857">Check Brake Fluid Level</p>	<p data-bbox="473 581 1079 603">* There is insufficient brake fluid in the brake fluid reservoir.</p> <div data-bbox="500 622 1644 660" data-label="Text"> <p><b>▲ WARNING</b> Risk of an accident due to low brake fluid level</p> </div> <p data-bbox="513 671 1513 694">If the brake fluid level is too low, the braking effect and the braking characteristics may be impaired.</p> <ul data-bbox="513 704 1585 824" style="list-style-type: none"> <li>► Pull over and stop the vehicle safely as soon as possible, paying attention to road and traffic conditions. Do not continue driving under any circumstances.</li> <li>► Consult a qualified specialist workshop.</li> <li>► Do not add brake fluid.</li> </ul>





Display messages	Possible causes/consequences and ► Solutions
 <p data-bbox="195 342 426 391">Check Brake Pads See Operator's Manual</p>	<ul style="list-style-type: none"> <li>* The brakepads have reached the wear limit.                             <ul style="list-style-type: none"> <li>► Consult a qualified specialist workshop.</li> </ul> </li> </ul>

### Driving systems

Display messages	Possible causes/consequences and ► Solutions
 <p data-bbox="195 637 229 658">Off</p>	<ul style="list-style-type: none"> <li>* The HOLD function is deactivated because the vehicle is slipping or a condition for activation is not fulfilled.                             <ul style="list-style-type: none"> <li>► Reactivate the HOLD function later or check the activation conditions for the HOLD function (→ page 160).</li> </ul> </li> </ul>
 <p data-bbox="195 781 469 826">ATTENTION ASSIST Inoperative</p>	<ul style="list-style-type: none"> <li>* ATTENTION ASSIST is malfunctioning.                             <ul style="list-style-type: none"> <li>► Consult a qualified specialist workshop.</li> </ul> </li> </ul>

Display messages	Possible causes/consequences and ► Solutions
 <p>ATTENTION ASSIST: Take a Break!</p>	<ul style="list-style-type: none"> <li>* ATTENTION ASSIST has detected fatigue or an increasing lack of concentration on the part of the driver (→ page 161).                             <ul style="list-style-type: none"> <li>► If necessary, take a break.</li> </ul> </li> </ul>
 <p>--- mph</p>	<ul style="list-style-type: none"> <li>* Cruise control cannot be activated as not all activation conditions are fulfilled.                             <ul style="list-style-type: none"> <li>► Observe the activation conditions for cruise control (→ page 163).</li> </ul> </li> </ul>
<p>Cruise Control Inoperative</p>	<ul style="list-style-type: none"> <li>* Cruise control is malfunctioning.                             <ul style="list-style-type: none"> <li>► Consult a qualified specialist workshop.</li> </ul> </li> </ul>
<p>Cruise Control Off</p>	<ul style="list-style-type: none"> <li>* Cruise control has been deactivated.                             <ul style="list-style-type: none"> <li>If there is an additional warning tone, cruise control has been deactivated automatically (→ page 163).</li> </ul> </li> </ul>
 <p>--- mph</p>	<ul style="list-style-type: none"> <li>* Active Distance Assist DISTRONIC cannot be activated as not all activation conditions are fulfilled.                             <ul style="list-style-type: none"> <li>► Comply with the activation conditions of Active Distance Assist DISTRONIC (→ page 167).</li> </ul> </li> </ul>

Display messages	Possible causes/consequences and ► Solutions
 <p data-bbox="195 344 310 366">Suspended</p>	<p data-bbox="524 251 1628 301">* If you depress the accelerator pedal beyond the setting of Active Distance Assist DISTRONIC, the system will switch to passive mode (→ page 165).</p>
 <p data-bbox="195 484 229 506">Off</p>	<p data-bbox="524 396 1591 446">* Active Distance Assist DISTRONIC was deactivated. If a warning tone also sounds, Active Distance Assist DISTRONIC has deactivated automatically (→ page 167).</p>
<p data-bbox="195 536 469 610">Active Distance Assist Currently Unavailable See Operator's Manual</p>	<p data-bbox="524 536 1578 658">* Active Distance Assist DISTRONIC is temporarily unavailable. The ambient conditions are outside the system limits (→ page 165). As soon as the ambient conditions are within the system limits, the system will become available again.</p> <p data-bbox="543 638 672 658">► Drive on.</p>
<p data-bbox="195 681 476 731">Active Distance Assist Inoperative</p>	<p data-bbox="524 681 1319 770">* Active Distance Assist DISTRONIC is malfunctioning. Other driving systems and driving safety systems may also be malfunctioning.</p> <p data-bbox="543 750 975 770">► Consult a qualified specialist workshop.</p>
<p data-bbox="195 785 469 835">Active Distance Assist Now Available</p>	<p data-bbox="524 785 1179 847">* Active Distance Assist DISTRONIC is operational again.</p> <p data-bbox="543 826 1179 847">► Switch on Active Distance Assist DISTRONIC (→ page 167).</p>

## 426 Display messages and warning/indicator lamps

Display messages	Possible causes/consequences and ► Solutions
<a href="#">Active Steering Assist Currently Unavailable See Operator's Manual</a>	<p>* Active Steering Assist is temporarily unavailable. The ambient conditions are outside the system limits (→ page 171). As soon as the ambient conditions are within the system limits, the system will become available again.</p> <ul style="list-style-type: none"><li>► Drive on.</li><li>► If necessary, clean the windshield in the camera's field of vision.</li><li>► Check the tire pressure if necessary.</li></ul>
<a href="#">Active Steering Assist Inoperative</a>	<p>* Active Steering Assist is malfunctioning. Active Distance Assist DISTRONIC remains available.</p> <ul style="list-style-type: none"><li>► Consult a qualified specialist workshop.</li></ul>
<a href="#">Active Steering Assist Currently Unavailable Due to Multiple Emergency Stops</a>	<p>* Active Steering Assist is temporarily unavailable due to multiple emergency stops.</p> <ul style="list-style-type: none"><li>► Take over the steering and stop in accordance with the traffic conditions.</li><li>► Switch the ignition off and switch it back on. Active Steering Assist is available once more.</li></ul>
<a href="#">Beginning Emergency Stop</a>	<p>* Your hands are not on the steering wheel. An emergency stop is being initiated (→ page 173).</p> <ul style="list-style-type: none"><li>► Put your hands back on the steering wheel.</li></ul> <p>You can cancel the deceleration at any time by performing one of the following actions:</p> <ul style="list-style-type: none"><li>• Steering</li><li>• Braking or accelerating</li><li>• Deactivating Active Distance Assist DISTRONIC</li></ul>

Display messages	Possible causes/consequences and ► Solutions
	<p>* Active Steering Assist has reached the system limits (→ page 171). You have not steered independently for a considerable period of time.</p> <ul style="list-style-type: none"> <li>► Take over the steering and drive on in accordance with the traffic conditions.</li> </ul>
<p>Traffic Sign Assist Currently Unavailable See Operator's Manual</p>	<p>* Traffic Sign Assist is temporarily unavailable. Once the cause of the problem is no longer present, the system will be available again.</p> <ul style="list-style-type: none"> <li>► Drive on.</li> <li>► If the display message does not disappear, stop the vehicle safely and clean the windshield.</li> </ul>
<p>Traffic Sign Assist Inoperative</p>	<p>* Traffic Sign Assist is malfunctioning.</p> <ul style="list-style-type: none"> <li>► Stop the vehicle in accordance with the traffic conditions and restart the engine.</li> <li>► If the display message still appears, consult a qualified specialist workshop.</li> </ul>
<p>Traffic Sign Assist Camera View Restricted See Operator's Manual</p>	<p>* The camera view is restricted. Possible causes:</p> <ul style="list-style-type: none"> <li>• Dirt on the windshield in the camera's field of vision</li> <li>• Heavy rain, snow or fog</li> </ul> <p>Driving systems and driving safety systems may be malfunctioning or temporarily unavailable. Once the cause of the problem is no longer present, the driving systems and driving safety systems will be available again.</p> <p>If the display message does not disappear:</p> <ul style="list-style-type: none"> <li>► Stop the vehicle in accordance with the traffic conditions.</li> </ul>

## 428 Display messages and warning/indicator lamps

Display messages	Possible causes/consequences and ► Solutions
<a href="#">Blind Spot Assist Currently Unavailable See Operator's Manual</a>	<ul style="list-style-type: none"><li>► Clean the windshield.</li></ul> <p>* Blind Spot Assist is temporarily unavailable. The system limits have been reached (→ page 182). Once the cause of the problem is no longer present, the system will be available again.</p> <ul style="list-style-type: none"><li>► Drive on.</li></ul> <p>or</p> <ul style="list-style-type: none"><li>► If the display message does not disappear, stop the vehicle in accordance with the traffic conditions and restart the engine.</li><li>► If necessary, clean the rear bumper. If the bumper is especially dirty, the sensors in the bumper may be malfunctioning.</li></ul>
<a href="#">Blind Spot Assist Inoperative</a>	<p>* Blind Spot Assist is malfunctioning.</p> <ul style="list-style-type: none"><li>► Consult a qualified specialist workshop.</li></ul>
<a href="#">Active Blind Spot Assist Currently Unavailable See Operator's Manual</a>	<p>* Active Blind Spot Assist is temporarily unavailable. The system limits have been reached (→ page 182). Once the cause of the problem is no longer present, the system will be available again.</p> <ul style="list-style-type: none"><li>► Drive on.</li></ul> <p>or</p>

Display messages	Possible causes/consequences and ► Solutions
	<ul style="list-style-type: none"> <li>► If the display message does not disappear, stop the vehicle in accordance with the traffic conditions and restart the engine.</li> </ul>
Active Blind Spot Assist Inoperative	<ul style="list-style-type: none"> <li>* Active Blind Spot Assist is malfunctioning.           <ul style="list-style-type: none"> <li>► Consult a qualified specialist workshop.</li> </ul> </li> </ul>
Active Lane Keeping Assist Currently Unavailable See Operator's Manual	<ul style="list-style-type: none"> <li>* Active Lane Keeping Assist is temporarily unavailable. The ambient conditions are outside the system limits (→ page 185). As soon as the ambient conditions are within the system limits, the system will become available again. <b>Vehicles with Active Steering Assist:</b> The camera view may be limited by the windshield.           <ul style="list-style-type: none"> <li>► Drive on.</li> </ul> <b>Vehicles with Active Steering Assist:</b> If the display message does not disappear:           <ul style="list-style-type: none"> <li>► Stop the vehicle in accordance with the traffic conditions.</li> <li>► Clean the windshield.</li> </ul> </li> </ul>
Active Lane Keeping Assist Inoperative	<ul style="list-style-type: none"> <li>* Active Lane Keeping Assist is malfunctioning.           <ul style="list-style-type: none"> <li>► Consult a qualified specialist workshop.</li> </ul> </li> </ul>
Active Lane Keeping Assist Camera View Restricted See Operator's Manual	<ul style="list-style-type: none"> <li>* <b>Vehicles without Active Steering Assist:</b> the camera view is restricted. Possible causes:           <ul style="list-style-type: none"> <li>• Dirt on the windshield in the camera's field of vision</li> </ul> </li> </ul>



## 430 Display messages and warning/indicator lamps

Display messages	Possible causes/consequences and ► Solutions
	<ul style="list-style-type: none"><li>• Heavy rain, snow or fog</li></ul> <p>Driving systems and driving safety systems may be malfunctioning or temporarily unavailable. Once the cause of the problem is no longer present, the driving systems and driving safety systems will be available again.</p> <p>If the display message does not disappear:</p> <ul style="list-style-type: none"><li>► Stop the vehicle in accordance with the traffic conditions.</li><li>► Clean the windshield.</li></ul>
 <p>Malfunction Drive at Max. 50 mph</p>	<p>* AIRMATIC is functioning only to a limited extent. The vehicle's handling characteristics may be affected.</p> <div data-bbox="497 539 1646 684"><p><b>!</b> <b>NOTE</b> The tires on the front axle or the fenders could be damaged by large steering movements</p><ul style="list-style-type: none"><li>► Avoid large steering movements while driving and listen for scraping sounds.</li><li>► If you hear scraping sounds, pull over and stop the vehicle in accordance with the traffic conditions, and set a higher vehicle level if possible.</li></ul></div> <ul style="list-style-type: none"><li>► Drive in a manner appropriate for the current level, but do not exceed 50 mph (80 km/h).</li><li>► Consult a qualified specialist workshop.</li></ul> <p>* DYNAMIC BODY CONTROL is malfunctioning. The vehicle's handling characteristics may be affected.</p> <ul style="list-style-type: none"><li>► Do not drive at speeds greater than 50 mph (80 km/h).</li><li>► Consult a qualified specialist workshop.</li></ul>

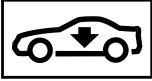

Display messages	Possible causes/consequences and ► Solutions
 <p data-bbox="194 347 447 391">Stop Vehicle Too Low</p>	<p data-bbox="526 253 1155 274">* You have pulled away despite the vehicle level being too low.</p> <ul style="list-style-type: none"> <li data-bbox="545 284 1155 336">► Stop the vehicle in accordance with the traffic conditions. The vehicle will be raised to the selected vehicle level.</li> <li data-bbox="545 347 1201 367">► Wait until the display message disappears before pulling away.</li> </ul> <p data-bbox="545 398 1580 419">If the display message does not disappear and a warning tone also sounds, AIRMATIC is malfunctioning:</p> <ul style="list-style-type: none"> <li data-bbox="545 429 1690 450">► Do not drive at speeds greater than 50 mph (80 km/h) and consult a qualified specialist workshop immediately.</li> </ul> <div data-bbox="545 481 1690 626" style="border: 1px solid black; padding: 5px;"> <p data-bbox="563 492 1561 512"><b>!</b> <b>NOTE</b> The tires on the front axle or the fenders could be damaged by large steering movements</p> <ul style="list-style-type: none"> <li data-bbox="563 533 1358 554">► Avoid large steering movements while driving and listen for scraping sounds.</li> <li data-bbox="563 564 1635 616">► If you hear scraping sounds, pull over and stop the vehicle in accordance with the traffic conditions, and set a higher vehicle level if possible.</li> </ul> </div> <ul style="list-style-type: none"> <li data-bbox="545 647 1145 694">► Set a higher vehicle level (→ page 188). Depending on the malfunction, the vehicle will be raised.</li> </ul>
 <p data-bbox="194 808 286 828">Lowering</p>	<p data-bbox="526 714 1071 735">* The vehicle level will lower for the following reasons:</p> <ul style="list-style-type: none"> <li data-bbox="554 751 1025 771">• You have selected a different drive program.</li> <li data-bbox="554 782 933 802">• You have exceeded the speed limit.</li> <li data-bbox="554 813 1164 833">• You have changed the vehicle level by pressing the button.</li> </ul>



## 432 Display messages and warning/indicator lamps

Display messages	Possible causes/consequences and ► Solutions
 <p>Vehicle Rising</p>	<ul style="list-style-type: none"><li>* Your vehicle is adjusting to the level you have selected.</li></ul>
 <p>Vehicle Rising Please Wait</p>	<ul style="list-style-type: none"><li>* The vehicle level is too low. The vehicle will be raised to the selected vehicle level.<ul style="list-style-type: none"><li>► Wait until the display message disappears before pulling away.</li></ul></li></ul>
 <p>Drive More Slowly</p>	<ul style="list-style-type: none"><li>* You are driving too fast for the selected vehicle level.<ul style="list-style-type: none"><li>► To adjust the vehicle level, you must not drive at speeds greater than 37 mph (60 km/h).</li></ul></li></ul>
<p>Parking Assist Maneuvering Assistance Restricted See Operator's Manual</p>	<ul style="list-style-type: none"><li>* The Parking Assist maneuvering assistant is temporarily unavailable or only partially available.<ul style="list-style-type: none"><li>► Clean all sensors of the parking and camera system (→ page 333).</li><li>► If the display message still appears, consult a qualified specialist workshop.</li></ul></li></ul>
<p>Parking Assist and PARKTRONIC Inoperative See Operator's Manual</p>	<ul style="list-style-type: none"><li>* <b>Vehicles with Active Parking Assist:</b> Active Parking Assist and Parking Assist PARKTRONIC are malfunctioning. <b>Vehicles without Active Parking Assist:</b> Parking Assist PARKTRONIC is malfunctioning.<ul style="list-style-type: none"><li>► Stop the vehicle in accordance with the traffic conditions and restart the engine.</li></ul></li></ul>

Display messages	Possible causes/consequences and ► Solutions
	<p>► If the display message still appears, consult a qualified specialist workshop.</p>

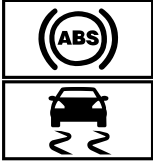
### Driving safety systems

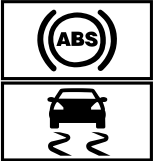
Display messages	Possible causes/consequences and ► Solutions
<div data-bbox="205 420 362 588">  </div> <p data-bbox="195 596 458 645">Currently Unavailable See Operator's Manual</p>	<p data-bbox="528 417 972 445">* ABS and ESP® are temporarily unavailable.</p> <p data-bbox="543 453 1507 481">Other driving systems and driving safety systems (e.g. BAS) may also be temporarily unavailable.</p> <p data-bbox="543 487 1687 536">The brake system will continue to operate normally. Braking distance may increase in an emergency braking situation.</p> <div data-bbox="550 560 1698 598" style="background-color: #e0e0e0; padding: 5px;"> <p data-bbox="559 567 1240 595"><b>▲ WARNING</b> Risk of skidding if ABS and ESP® are malfunctioning</p> </div> <p data-bbox="559 609 1452 637">The wheels may lock during braking and ESP® does not perform any vehicle stabilization.</p> <p data-bbox="559 643 1681 692">The steerability and braking characteristics are heavily impaired and the braking distance may increase. In addition, other driving safety systems are switched off.</p> <ul style="list-style-type: none"> <li data-bbox="559 705 1642 754">► Drive carefully on a suitable stretch of road, making slight steering movements at a speed above 19 mph (30 km/h).</li> <li data-bbox="559 767 1665 816">► If the display message does not disappear, consult a qualified specialist workshop immediately. Drive carefully.</li> </ul>

Display messages	Possible causes/consequences and ► Solutions
 <p data-bbox="144 425 417 474">Inoperative See Operator's Manual</p>	<p data-bbox="476 249 1631 368">* ABS and ESP® are malfunctioning. Other driving systems and driving safety systems (e.g. BAS) may also be malfunctioning. The brake system will continue to operate normally. Braking distance may increase in an emergency braking situation.</p> <div data-bbox="500 389 1644 430" style="background-color: #f0f0f0; padding: 5px;"> <p data-bbox="510 399 1190 425">▲ <b>WARNING</b> Risk of skidding if ABS and ESP® are malfunctioning</p> </div> <p data-bbox="510 441 1631 529">The wheels may block during braking and ESP® does not perform any vehicle stabilization. The steerability and braking characteristics are heavily impaired and the braking distance may increase. In addition, other driving safety systems are switched off.</p> <ul data-bbox="510 539 1310 601" style="list-style-type: none"> <li data-bbox="510 539 728 565">► Drive on carefully.</li> <li data-bbox="510 576 1310 601">► Have ABS and ESP® checked immediately at a qualified specialist workshop.</li> </ul>
 <p data-bbox="144 721 408 769">Currently Unavailable See Operator's Manual</p>	<p data-bbox="476 630 1374 689">* ESP® is temporarily unavailable. Other driving systems and driving safety systems (e.g. BAS) may also be malfunctioning.</p> <div data-bbox="500 710 1644 752" style="background-color: #f0f0f0; padding: 5px;"> <p data-bbox="510 721 1082 746">▲ <b>WARNING</b> Risk of skidding if ESP is malfunctioning®</p> </div> <p data-bbox="510 762 1613 809">If ESP® is malfunctioning, ESP® cannot carry out vehicle stabilization. In addition, other driving safety systems are switched off.</p>

Display messages	Possible causes/consequences and ► Solutions
	<ul style="list-style-type: none"> <li>► Drive carefully on a suitable stretch of road, making slight steering movements at a speed above 19 mph (30 km/h).</li> <li>► If the display message does not disappear, consult a qualified specialist workshop immediately. Drive carefully.</li> </ul>
 <p data-bbox="195 487 467 536">Inoperative See Operator's Manual</p>	<p data-bbox="524 394 781 420">* ESP® is malfunctioning.</p> <p data-bbox="543 430 1424 456">Other driving systems and driving safety systems (e.g. BAS) may also be malfunctioning.</p> <p data-bbox="543 467 1687 513">The brake system will continue to operate normally. Braking distance may increase in an emergency braking situation.</p> <div data-bbox="543 534 1702 581" style="background-color: #e0e0e0; padding: 5px;"> <p data-bbox="556 544 1134 570"><b>▲ WARNING</b> Risk of skidding if ESP® is malfunctioning</p> </div> <p data-bbox="561 586 1665 638">If ESP® is malfunctioning, ESP® cannot carry out vehicle stabilization. In addition, other driving safety systems are switched off.</p> <ul style="list-style-type: none"> <li>► Drive on carefully.</li> <li>► Have ESP® checked at a qualified specialist workshop.</li> </ul>

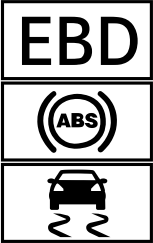
Display messages	Possible causes/consequences and ► Solutions
 <p data-bbox="144 513 417 560">Inoperative See Operator's Manual</p>	<p data-bbox="476 249 1374 311">* EBD, ABS and ESP® are malfunctioning. Other driving systems and driving safety systems (e.g. BAS) may also be malfunctioning.</p> <div data-bbox="495 329 1648 550" style="border: 1px solid gray; padding: 5px;"> <p data-bbox="506 339 1245 365">▲ <b>WARNING</b> Risk of skidding if EBD, ABS and ESP® are malfunctioning</p> <p data-bbox="513 381 1415 407">The wheels may block during braking and ESP® does not perform any vehicle stabilization.</p> <p data-bbox="513 417 1628 469">The steerability and braking characteristics are heavily impaired and the braking distance may increase. In addition, other driving safety systems are switched off.</p> <ul style="list-style-type: none"> <li data-bbox="513 479 728 505">▶ Drive on carefully.</li> <li data-bbox="513 515 1337 541">▶ Have the brake system checked immediately at a qualified specialist workshop.</li> </ul> </div>
<p data-bbox="144 588 417 664">Active Brake Assist Functions Currently Limited See Operator's Manual</p>	<p data-bbox="476 588 1628 640">* <b>Vehicles with the Driving Assistance Package:</b> Active Brake Assist with cross-traffic function, Evasive Steering Assist or PRE-SAFE® PLUS are temporarily unavailable or only partially available.</p> <p data-bbox="495 650 1489 676"><b>Vehicles without the Driving Assistance Package:</b> Active Brake Assist is temporarily unavailable.</p> <ul style="list-style-type: none"> <li data-bbox="495 686 1563 738">▶ Drive on. As soon as the ambient conditions are within the system limits, the system will become available again.</li> <li data-bbox="495 749 1646 800">▶ If the display message does not disappear, stop the vehicle in accordance with the traffic conditions and restart the engine.</li> </ul>

Display messages	Possible causes/consequences and ► Solutions
<p>Active Brake Assist Functions Limited See Operator's Manual</p>	<p>* For vehicles with the Driving Assistance Package, the following functions may be temporarily unavailable or limited:</p> <ul style="list-style-type: none"> <li>• Active Brake Assist with cross-traffic function</li> <li>• Evasive Steering Assist</li> <li>• PRE-SAFE® PLUS</li> </ul> <p><b>Vehicles without the Driving Assistance Package:</b> Active Brake Assist is temporarily unavailable or only partially available.</p> <p>► Consult a qualified specialist workshop.</p>
<p>Radar Sensors Dirty See Operator's Manual</p>	<p>* The radar sensor system is malfunctioning. Possible causes:</p> <ul style="list-style-type: none"> <li>• Dirt on the sensors</li> <li>• Heavy rain or snow</li> <li>• Extended country driving without other traffic, e.g. in the desert</li> </ul> <p>Driving systems and driving safety systems may be malfunctioning or temporarily unavailable.</p> <p>Once the cause of the problem is no longer present, the driving systems and driving safety systems will be available again.</p> <p>If the display message does not disappear:</p> <ul style="list-style-type: none"> <li>► Stop the vehicle in accordance with the traffic conditions.</li> <li>► Clean all sensors (→ page 333).</li> <li>► Restart the engine.</li> </ul>

### Mercedes me connect

Display messages	Possible causes/consequences and ► Solutions
<p>Mercedes me connect Services Limited See Operator's Manual</p>	<p>* The vehicle functions for malfunction detection are restricted. At least one of the main functions of the Mercedes me connect system is malfunctioning.</p> <ul style="list-style-type: none"> <li>► Observe the notes on the diagnostics connection (→ page 26).</li> <li>► Consult a qualified specialist workshop.</li> </ul>
<div style="border: 1px solid black; padding: 5px; display: inline-block;">  </div> <p>Inoperative</p>	<p>* At least one of the main functions of the Mercedes me connect system or of the Mercedes-Benz emergency call system is malfunctioning.</p> <ul style="list-style-type: none"> <li>► Consult a qualified specialist workshop.</li> </ul>

### Battery

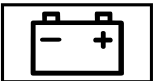
Display messages	Possible causes/consequences and ► Solutions
<div style="border: 1px solid black; padding: 5px; display: inline-block;">  </div> <p>12 V Battery See Operator's Manual</p>	<p>* The engine is off and the charge level is too low.</p> <ul style="list-style-type: none"> <li>► Switch off electrical consumers that are not required.</li> </ul> <p>To charge the 12 V battery:</p> <ul style="list-style-type: none"> <li>► Leave the engine running for a few minutes, or drive an extended distance.</li> </ul>



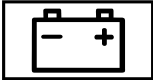
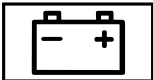

Display messages	Possible causes/consequences and ► Solutions
 <p>See Operator's Manual</p>	<p>* If the message appears while the engine is running, this indicates an on-board electrical system malfunction.</p> <ul style="list-style-type: none"> <li>► Consult a qualified specialist workshop.</li> </ul> <p>* The 12 V battery is not being charged.</p> <div style="border: 1px solid black; padding: 5px; margin: 5px 0;"> <p><b>!</b> <b>NOTE</b> Possible engine damage if you continue driving</p> <ul style="list-style-type: none"> <li>► Do not continue driving under any circumstances.</li> <li>► Consult a qualified specialist workshop.</li> </ul> </div> <ul style="list-style-type: none"> <li>► Stop the vehicle immediately in accordance with the traffic conditions and switch off the engine.</li> <li>► Consult a qualified specialist workshop.</li> </ul>
 <p>Stop Vehicle See Operator's Manual</p>	<p>* The 12 V battery is no longer being charged and the charge level is too low.</p> <div style="border: 1px solid black; padding: 5px; margin: 5px 0;"> <p><b>!</b> <b>NOTE</b> Possible engine damage if you continue driving</p> <ul style="list-style-type: none"> <li>► Do not continue driving under any circumstances.</li> <li>► Consult a qualified specialist workshop.</li> </ul> </div> <ul style="list-style-type: none"> <li>► Stop the vehicle immediately in accordance with the traffic conditions. Do not continue driving under any circumstances.</li> <li>► Switch off the engine.</li> </ul>



#### 440 Display messages and warning/indicator lamps

Display messages	Possible causes/consequences and ► Solutions
 <p data-bbox="144 381 413 433">Stop Vehicle Leave Engine Running</p>	<ul style="list-style-type: none"><li data-bbox="495 249 925 272">► Consult a qualified specialist workshop.</li></ul> <p data-bbox="476 291 894 313">* The 12 V battery charge level is too low.</p> <ul style="list-style-type: none"><li data-bbox="495 324 1480 347">► Stop the vehicle immediately in accordance with the traffic conditions. Do not continue driving.</li><li data-bbox="495 357 787 380">► Leave the engine running.</li><li data-bbox="495 390 968 413">► If the display message disappears: drive on.</li><li data-bbox="495 423 1354 446">► If the display message does not disappear: consult a qualified specialist workshop.</li></ul>

#### Tire pressure monitor

Display messages	Possible causes/consequences and ► Solutions
<p data-bbox="144 594 389 646">Tire Press. Monitor Currently Unavailable</p>	<p data-bbox="476 594 1633 646">* There is interference from a powerful radio signal source As a result, no signals from the tire pressure sensors are being received. The tire pressure monitoring system is temporarily unavailable.</p> <p data-bbox="495 656 1517 679">The tire pressure monitoring system will restart automatically as soon as the cause has been rectified.</p> <ul style="list-style-type: none"><li data-bbox="495 689 620 712">► Drive on.</li></ul>
<p data-bbox="144 729 426 781">Tire Press. Monitor Inoperative</p>	<p data-bbox="476 729 1036 752">* The tire pressure monitoring system is malfunctioning.</p> <div data-bbox="500 772 1644 850"><p data-bbox="506 783 1517 806"><b>⚠ WARNING</b> There is a risk of an accident if the tire pressure monitoring system is malfunctioning</p><p data-bbox="506 821 1622 844">The tire pressure monitoring system cannot issue a warning if there is pressure loss in one or more of the tires.</p></div>

Display messages	Possible causes/consequences and ► Solutions
	<p>Tires with insufficient tire pressure may impair the driving characteristics as well as steering and braking.</p> <p>► Have the tire pressure monitoring system checked at a qualified specialist workshop.</p>
<p>Tire Pressure Monitor Inoperative No Wheel Sensors</p>	<p>* The wheels installed do not have suitable tire pressure sensors. The tire pressure monitoring system is deactivated.</p> <p>► Install wheels with suitable tire pressure sensors.</p>
 <p>Wheel Sensor(s) Missing</p>	<p>* There is no signal from the tire pressure sensor of one or more wheels. No pressure value is displayed for the affected tire.</p> <p>► Have the faulty tire pressure sensor replaced at a qualified specialist workshop.</p>
 <p>Check Tires</p>	<p>* The tire pressure in one or more tires has dropped significantly. The wheel position is displayed. A warning tone will also sound.</p> <p><b>▲ WARNING</b> Risk of an accident due to insufficient tire pressure</p> <ul style="list-style-type: none"> <li>• The tires can burst.</li> <li>• The tires can wear excessively and/or unevenly.</li> <li>• The driving characteristics as well as the steering and braking may be greatly impaired.</li> </ul> <p>You could then lose control of the vehicle.</p> <p>► Observe the recommended tire pressures.</p>

Display messages	Possible causes/consequences and ► Solutions
	<ul style="list-style-type: none"> <li>► Adjust the tire pressure if necessary.</li> <li>► Stop the vehicle in accordance with the traffic conditions.</li> <li>► Check the tire pressure (→ page 359) and the tires.</li> </ul>
<div style="text-align: center;">  </div> <p data-bbox="144 477 395 526">Please Correct Tire Pressure</p>	<p data-bbox="476 384 1596 433">* The tire pressure is too low in at least one of the tires, or the difference in tire pressure between the individual wheels is too great.</p> <ul style="list-style-type: none"> <li>► Check the tire pressure and add air, if necessary.</li> <li>► When the tire pressure is correct, restart the tire pressure monitor (→ page 364).</li> </ul>
<div style="text-align: center;">  </div> <p data-bbox="144 643 395 671">Warning Tire Malfunction</p>	<p data-bbox="476 550 1471 578">* The tire pressure in one or more tires has dropped suddenly. The wheel position will be displayed.</p> <div style="background-color: #f0f0f0; padding: 5px; margin-bottom: 10px;"> <p data-bbox="506 601 1134 629"><b>⚠ WARNING</b> Risk of an accident from driving with a flat tire</p> <ul style="list-style-type: none"> <li>• The tires can overheat and be damaged.</li> <li>• The driving characteristics as well as the steering and braking characteristics may be greatly impaired.</li> </ul> <p data-bbox="513 721 931 743">You could then lose control of the vehicle.</p> <ul style="list-style-type: none"> <li>► Do not drive with a flat tire.</li> <li>► Do not exceed the maximum permissible driving distance in emergency mode and the maximum permissible speed with a flat MOExtended tire.</li> <li>► Observe the notes on flat tires.</li> </ul> </div>

Display messages	Possible causes/consequences and ► Solutions
	<p>Notes in the event of a flat tire (→ page 337).</p> <ul style="list-style-type: none"> <li>► Stop the vehicle in accordance with the traffic conditions.</li> <li>► Check the tires.</li> </ul>
Tires Overheated	<p>* At least one tire is overheating. The affected tires are displayed in red. At temperatures close to the limit value, the tires are displayed in yellow.</p> <div style="border: 1px solid black; padding: 5px; margin-top: 10px;"> <p><b>⚠ WARNING</b> Risk of an accident from driving with overheated tires</p> <p>Overheated tires can burst.</p> <ul style="list-style-type: none"> <li>► Reduce speed so that the tires cool down.</li> </ul> </div>
Decrease Speed	<p>* At least one tire is overheating. The affected tires are displayed in red. At temperatures close to the limit value, the tires are displayed in yellow.</p> <div style="border: 1px solid black; padding: 5px; margin-top: 10px;"> <p><b>⚠ WARNING</b> Risk of an accident from driving with overheated tires</p> <p>Overheated tires can burst.</p> <ul style="list-style-type: none"> <li>► Reduce speed so that the tires cool down.</li> </ul> </div>

#### 444 Display messages and warning/indicator lamps



##### Tire pressure loss warning system

Display messages	Possible causes/consequences and ► Solutions
Check Tire Pressure Soon	<p>* Canada only: The tire pressure loss warning system has detected a significant loss of pressure.</p> <div data-bbox="495 365 1652 629" style="border: 1px solid gray; padding: 5px;"><p><b>⚠ WARNING</b> Risk of an accident due to insufficient tire pressure</p><ul style="list-style-type: none"><li>• The tires can burst.</li><li>• The tires can wear excessively and/or unevenly.</li><li>• The driving characteristics as well as the steering and braking may be greatly impaired.</li></ul><p>You could then lose control of the vehicle.</p><ul style="list-style-type: none"><li>► Observe the recommended tire pressures.</li><li>► Adjust the tire pressure if necessary.</li></ul></div> <p>► Stop the vehicle in accordance with the traffic conditions.</p> <p>► Check the tire pressure (→ page 359) and the tires.</p> <p>► When the tire pressure is correct, restart the tire pressure loss warning system (→ page 365).</p>
Check Tire Pressure Then Restart Run Flat Indicator	<p>* Canada only: The tire pressure loss warning system generated a display message and has not been restarted since.</p> <p>► When the tire pressure is correct, restart the tire pressure loss warning system (→ page 365).</p>

Display messages	Possible causes/consequences and ► Solutions
Run Flat Indicator Inoperative	<p>* Canada only: The tire pressure loss warning system is malfunctioning.</p> <p>► Consult a qualified specialist workshop.</p>

## Engine oil

Display messages	Possible causes/consequences and ► Solutions
 <p>Check Engine Oil At Next Refueling</p>	<p>* The engine oil level has dropped to the minimum level.</p> <div data-bbox="550 526 1696 614" style="border: 1px solid gray; padding: 5px;"> <p><b>!</b> <b>NOTE</b> Engine damage caused by driving with insufficient engine oil</p> <p>► Avoid long journeys with insufficient engine oil.</p> </div> <p>► Check the engine oil level when next refueling.</p> <p>Add engine oil (→ page 326).</p> <p>Notes on engine oil (→ page 395).</p>

Display messages	Possible causes/consequences and ► Solutions
 <p data-bbox="144 342 376 394">Check Engine Oil Level (Add 1 quart)</p>	<p data-bbox="476 249 1036 308">* Display message only for certain engines: The engine oil level has dropped to the minimum level.</p> <div data-bbox="500 325 1646 412" style="border: 1px solid black; padding: 5px;"> <p data-bbox="506 335 1221 360">! <b>NOTE</b> Engine damage caused by driving with insufficient engine oil</p> <p data-bbox="506 377 1018 401">► Avoid long journeys with insufficient engine oil.</p> </div> <p data-bbox="491 428 1203 495">► When next refueling, add 1.1 US qt (1 l) of engine oil (→ page 326). Notes on engine oil (→ page 395).</p>
 <p data-bbox="144 610 421 630">Engine Oil Reduce Oil Level</p>	<p data-bbox="476 516 907 576">* Display message only for certain engines: The engine oil level is too high.</p> <div data-bbox="500 592 1646 679" style="border: 1px solid black; padding: 5px;"> <p data-bbox="506 602 1179 627">! <b>NOTE</b> Engine damage caused by driving with excess engine oil</p> <p data-bbox="506 644 975 669">► Avoid long journeys with excess engine oil.</p> </div> <p data-bbox="491 696 1430 721">► Consult a qualified specialist workshop immediately and have the engine oil level reduced.</p>
 <p data-bbox="144 830 408 878">Engine Oil Level Low Stop Vehicle Turn Engine Off</p>	<p data-bbox="476 737 907 796">* Display message only for certain engines: The engine oil level is too low.</p>



Display messages	Possible causes/consequences and ► Solutions
	<div data-bbox="550 252 1698 291" style="border: 1px solid black; padding: 2px;"> <p><b>!</b> <b>NOTE</b> Engine damage caused by driving with insufficient engine oil</p> </div> <div data-bbox="550 291 1698 336" style="border: 1px solid black; padding: 2px;"> <p>► Avoid long journeys with insufficient engine oil.</p> </div> <ul style="list-style-type: none"> <li>► Stop the vehicle immediately in accordance with the traffic conditions. Do not continue driving.</li> <li>► Switch off the engine.</li> <li>► Add 1.1 US qt (1 l) of engine oil (→ page 326).</li> <li>► Check the engine oil level.</li> </ul> <p>Notes on engine oil (→ page 395).</p>
<div data-bbox="205 542 362 624" style="border: 1px solid black; text-align: center; width: 85px; height: 80px; margin: 0 auto;">  </div> <p data-bbox="199 632 445 681">Engine Oil Pressure Stop Switch Off Engine</p>	<p>* Display message only for certain engines: The oil pressure is too low.</p> <div data-bbox="550 617 1698 655" style="border: 1px solid black; padding: 2px;"> <p><b>!</b> <b>NOTE</b> Engine damage caused by driving with insufficient oil pressure</p> </div> <div data-bbox="550 655 1698 701" style="border: 1px solid black; padding: 2px;"> <p>► Avoid driving with insufficient oil pressure.</p> </div> <ul style="list-style-type: none"> <li>► Stop the vehicle immediately in accordance with the traffic conditions. Do not continue driving.</li> <li>► Switch off the engine.</li> <li>► Consult a qualified specialist workshop.</li> </ul>

## 448 Display messages and warning/indicator lamps

Display messages	Possible causes/consequences and ► Solutions
 <p data-bbox="144 342 417 389">Engine Oil Level Cannot Be Measured</p>	<p data-bbox="473 249 1489 272">* The electrical connection to the oil level sensor has been interrupted or the oil level sensor is faulty.</p> <ul data-bbox="495 282 925 305" style="list-style-type: none"><li data-bbox="495 282 925 305">► Consult a qualified specialist workshop.</li></ul>

### Warning and indicator lamps

#### Overview of indicator and warning lamps

Some systems will perform a self-test when the ignition is switched on. Some indicator and warning lamps may briefly light up or flash. This behavior is non-critical. These indicator and warning lamps indicate a malfunction only if they light up or flash after the engine has been started or during a journey.

#### Instrument display (standard)

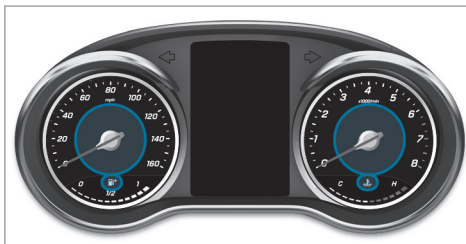



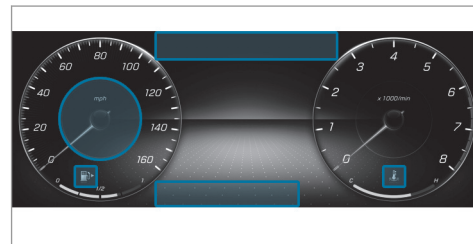



















#### Widescreen cockpit instrument display





Depending on the display setting, the positions of the indicator lamps on the instrument display may differ from the example shown.

**Indicator and warning lamps:**

	Restraint system (→ page 450)		Distance warning (→ page 458)
	Seat belt (→ page 450)		AIRMATIC (→ page 458)
	Power steering (→ page 451)		DYNAMIC BODY CONTROL (→ page 458)
	Coolant temperature (→ page 452)		ABS (→ page 459)
	Engine diagnostics (→ page 452)		ESP® (→ page 459)
	Electrical malfunction (→ page 452)		ESP® OFF (→ page 459)
	Reserve fuel with fuel filler flap location indicator (→ page 452)		Tire pressure monitoring system (→ page 461)
<b>PARK</b>	USA: electric parking brake (red) (→ page 455)		Parking lights (→ page 112)
	Canada: electric parking brake (red) (→ page 455)		Low beam (→ page 112)
	Electric parking brake (yellow) (→ page 455)		High beam (→ page 113)
<b>RBS</b>	USA: Recuperative Brake System (→ page 455)		Turn signal lights (→ page 113)
	Canada: brakes (yellow) (→ page 455)		Rear fog light (→ page 112)
<b>BRAKE</b>	USA: brakes (red) (→ page 455)		
	Canada: brakes (red) (→ page 455)		

## Occupant safety

Warning/indicator lamp	Possible causes/consequences and ► Solutions
 <p data-bbox="144 384 402 433">Restraint system warning lamp</p>	<p data-bbox="463 291 1191 339">* The red restraint system warning lamp is lit while the engine is running. The restraint system is malfunctioning (→ page 36).</p> <div data-bbox="482 360 1644 477" style="border: 1px solid gray; padding: 5px;"> <p data-bbox="491 365 1221 391">▲ <b>WARNING</b> Risk of injury due to malfunctions in the restraint system</p> <p data-bbox="491 407 1591 433">Components in the restraint system may be activated unintentionally or not deploy as planned in an accident.</p> <ul style="list-style-type: none"> <li data-bbox="491 443 1480 469">▶ Have the restraint system checked and repaired immediately at a qualified specialist workshop.</li> </ul> </div> <ul style="list-style-type: none"> <li data-bbox="476 495 694 521">▶ Drive on carefully.</li> <li data-bbox="476 531 994 557">▶ Note the messages on the multifunction display.</li> <li data-bbox="476 567 1036 593">▶ Consult a qualified specialist workshop immediately.</li> </ul>
 <p data-bbox="144 700 376 726">Seat belt warning lamp</p>	<p data-bbox="463 607 1286 627">* The red seat belt warning lamp flashes and an intermittent warning tone sounds.</p> <p data-bbox="476 643 504 664"><b>or</b></p> <p data-bbox="476 674 1328 700">The red seat belt warning lamp lights up for six seconds once the engine has started.</p> <p data-bbox="476 710 1003 731">In addition, an intermittent warning tone may sound.</p> <p data-bbox="476 736 1354 762"><b>The red seat belt warning lamp flashes and an intermittent warning tone sounds:</b></p> <p data-bbox="476 767 1437 793">The driver or front passenger has not fastened his or her seat belt while the vehicle is in motion.</p> <ul style="list-style-type: none"> <li data-bbox="476 803 864 829">▶ Fasten your seat belt (→ page 40).</li> </ul> <p data-bbox="476 855 944 881">There are objects on the front passenger seat.</p>

Warning/indicator lamp	Possible causes/consequences and ► Solutions
	<ul style="list-style-type: none"> <li>► Remove the objects from the front passenger seat.</li> </ul> <p><b>The red seat belt warning lamp lights up once the engine has started:</b></p> <p>In addition, an intermittent warning tone may sound.</p> <p>The red seat belt warning lamp reminds the driver and front passenger to fasten their seat belts.</p> <ul style="list-style-type: none"> <li>► Fasten your seat belt (→ page 40).</li> </ul> <p>If you have placed objects on the front passenger seat, the red seat belt warning lamp may remain lit.</p>

## Vehicle

Warning/indicator lamp	Possible causes/consequences and ► Solutions
 <p>Power steering warning lamp (red)</p>	<p>* The red power steering system warning lamp is lit while the engine is running. The power assistance or the steering itself is malfunctioning.</p> <div style="background-color: #f0f0f0; padding: 5px; margin: 5px 0;"> <p><b>▲ WARNING</b> Risk of accident if steering capability is impaired</p> <p>If the steering does not function as intended, the vehicle's operating safety is jeopardized.</p> <ul style="list-style-type: none"> <li>► Pull over and stop the vehicle safely as soon as possible, paying attention to road and traffic conditions. Do not continue driving under any circumstances.</li> <li>► Consult a qualified specialist workshop.</li> </ul> </div> <ul style="list-style-type: none"> <li>► Note the messages on the multifunction display.</li> </ul>

## Engine

### Warning/indicator lamp



Coolant warning lamp

### Possible causes/consequences and ► Solutions

\* The red coolant warning lamp is lit while the engine is running.

Possible causes:

- The temperature sensor is malfunctioning
- The coolant level is too low
- The air supply to the radiator is obstructed
- The radiator fan is faulty
- The coolant pump is faulty

If there is an additional warning tone, the coolant temperature has exceeded the maximum permissible temperature.

#### **▲ WARNING** Risk of burns when opening the hood



If you open the hood when the engine has overheated or when there is a fire in the engine compartment, the following situations may occur:

- You could come into contact with hot gases.
- You could come into contact with other hot, escaping operating fluids.

► Before opening the hood, allow the overheated engine to cool down.

► In the event of a fire in the engine compartment, keep the hood closed and call the fire service.





Warning/indicator lamp	Possible causes/consequences and ► Solutions
	<ul style="list-style-type: none"> <li>► Stop the vehicle immediately in accordance with the traffic conditions and switch off the engine. Do not continue driving under any circumstances.</li> <li>► Note the messages on the multifunction display.</li> </ul> <p>If the coolant temperature display is at the lower end of the temperature scale:</p> <ul style="list-style-type: none"> <li>► Consult a qualified specialist workshop.</li> </ul> <p>If the coolant temperature display is at the upper end of the temperature scale:</p> <ul style="list-style-type: none"> <li>► Exit the vehicle and keep a safe distance from it until the engine has cooled down.</li> <li>► Check the coolant level (→ page 328).</li> <li>► Make sure that the air supply to the radiator is not obstructed.</li> <li>► Avoiding high loads on the engine, drive to the nearest qualified specialist workshop. In doing so, ensure that the coolant temperature display remains below the red area.</li> </ul>
 <p data-bbox="195 721 450 767">Engine diagnosis warning lamp</p>	<p data-bbox="513 627 1337 676">* The yellow Check Engine warning lamp is lit while the engine is running. A malfunction has occurred in the engine, the exhaust system or the fuel system.</p> <p data-bbox="526 687 1400 712">The emission limit values may be exceeded and the engine may be in emergency mode.</p> <p data-bbox="526 724 1659 772">In some states, legal requirements stipulate that you must immediately consult a qualified specialist workshop as soon as the yellow Check Engine warning lamp lights up.</p> <ul style="list-style-type: none"> <li>► Have the vehicle checked as soon as possible at a qualified specialist workshop.</li> </ul>

Warning/indicator lamp	Possible causes/consequences and ► Solutions
 <p data-bbox="144 339 428 394">Electrical malfunction warning lamp</p>	<p data-bbox="458 249 898 298">* The red electrical fault warning lamp is lit. There is a fault in the electrics.</p> <ul data-bbox="476 308 994 335" style="list-style-type: none"><li data-bbox="476 308 994 335">► Note the messages on the multifunction display.</li></ul>
 <p data-bbox="144 499 410 526">Fuel reserve warning lamp</p>	<p data-bbox="458 412 1156 439">* The yellow fuel reserve warning lamp lights up while you are driving.</p> <p data-bbox="476 449 502 466"><b>or</b></p> <p data-bbox="476 476 1219 503">The yellow fuel reserve warning lamp lights up while the engine is running.</p> <p data-bbox="476 503 1219 530"><b>The yellow fuel reserve warning lamp lights up while you are driving:</b></p> <p data-bbox="476 540 1629 588">There has been pressure loss in the fuel system. The fuel filler cap is not closed correctly or the fuel system is leaking.</p> <ul data-bbox="476 598 750 625" style="list-style-type: none"><li data-bbox="476 598 750 625">► Close the fuel filler cap.</li></ul> <p data-bbox="476 646 1012 673">If the fuel filler cap has already been closed correctly:</p> <ul data-bbox="476 683 909 710" style="list-style-type: none"><li data-bbox="476 683 909 710">► Consult a qualified specialist workshop.</li></ul> <p data-bbox="476 710 1289 737"><b>The yellow fuel reserve warning lamp lights up while the engine is running:</b></p> <p data-bbox="476 747 990 774">The fuel supply has dropped into the reserve range.</p> <ul data-bbox="476 785 583 812" style="list-style-type: none"><li data-bbox="476 785 583 812">► Refuel.</li></ul>





## Brakes

Warning/indicator lamp	Possible causes/consequences and ► Solutions
<div data-bbox="203 295 360 372" data-label="Image"> </div> <p data-bbox="194 383 471 429">Electric parking brake indicator lamp (red) (USA only)</p> <div data-bbox="203 440 360 518" data-label="Image"> </div> <p data-bbox="194 528 471 606">Electric parking brake indicator lamp (red) (Canada only)</p> <div data-bbox="203 616 360 694" data-label="Image"> </div> <p data-bbox="194 704 471 751">The electric parking brake (yellow) indicator lamp</p>	<p data-bbox="517 290 1136 315">* The red electric parking brake indicator lamp flashes or is lit.</p> <p data-bbox="517 326 1450 352">The yellow electric parking brake indicator lamp also lights up in the event of a malfunction.</p> <ul data-bbox="517 352 1044 378" style="list-style-type: none"> <li>► Note the messages on the multifunction display.</li> </ul>



Warning/indicator lamp	Possible causes/consequences and ► Solutions
 <p>Recuperative Brake System warning lamp (USA only)</p>  <p>Brakes warning lamp (yellow) (Canada only)</p>	<p>*The yellow  warning lamp (USA only) or the yellow  brakes warning lamp (Canada only) is lit while the engine is running.</p> <p><b>▲ WARNING</b> Risk of an accident due to a brake system malfunction</p> <p>If the brake system is malfunctioning, braking characteristics may be impaired.</p> <ul style="list-style-type: none"><li>▶ Drive on carefully.</li><li>▶ Have the brake system checked immediately at a qualified specialist workshop.</li></ul> <p>► Adjust your speed and drive on carefully, leaving a suitable distance to the vehicle in front.</p> <p>► If the multifunction display shows a display message, observe it.</p> <p>► Consult a qualified specialist workshop.</p>

Warning/indicator lamp	Possible causes/consequences and ► Solutions
<div data-bbox="205 254 362 335" data-label="Image"> </div> <p data-bbox="195 342 452 394">Brake warning lamp (USA only)</p> <div data-bbox="205 399 362 480" data-label="Image"> </div> <p data-bbox="195 487 473 539">Brake system warning lamp (Canada only)</p>	<p data-bbox="513 249 1212 275">* The red brake system warning lamp is lit while the engine is running.</p> <p data-bbox="526 283 694 306">Possible causes:</p> <ul data-bbox="534 319 1480 377" style="list-style-type: none"> <li data-bbox="534 319 1480 344">• The brake force boosting is malfunctioning and the braking characteristics may be affected.</li> <li data-bbox="534 353 1147 377">• There is insufficient brake fluid in the brake fluid reservoir.</li> </ul> <p data-bbox="526 394 1045 420">► Note the messages on the multifunction display.</p> <div data-bbox="537 439 1696 480" data-label="Section-Header"> <p><b>▲ WARNING</b> Risk of accident and injury if brake force boosting is malfunctioning</p> </div> <p data-bbox="545 487 1670 539">If brake force boosting is malfunctioning, increased brake pedal force may be necessary for braking. The braking characteristics may be impaired. The braking distance can increase in emergency braking situations.</p> <ul data-bbox="545 547 1184 605" style="list-style-type: none"> <li data-bbox="545 547 1184 572">► Stop in a safe location immediately. Do not continue driving.</li> <li data-bbox="545 581 981 605">► Consult a qualified specialist workshop.</li> </ul> <div data-bbox="537 636 1696 677" data-label="Section-Header"> <p><b>▲ WARNING</b> Risk of an accident due to low brake fluid level</p> </div> <p data-bbox="545 684 1548 710">If the brake fluid level is too low, the braking effect and the braking characteristics may be impaired.</p> <ul data-bbox="545 717 1655 838" style="list-style-type: none"> <li data-bbox="545 717 1655 769">► Pull over and stop the vehicle safely as soon as possible, paying attention to road and traffic conditions. Do not continue driving under any circumstances.</li> <li data-bbox="545 778 981 803">► Consult a qualified specialist workshop.</li> <li data-bbox="545 812 814 838">► Do not add brake fluid.</li> </ul>

## Driving systems

Warning/indicator lamp	Possible causes/consequences and ► Solutions
 <p data-bbox="144 384 413 433">Warning lamp for distance warning function</p>	<p data-bbox="463 291 1387 373">* The red distance warning lamp lights up while the vehicle is in motion. The distance to the vehicle in front is too small for the speed selected. If there is an additional warning tone, you are approaching an obstacle at too high a speed.</p> <ul data-bbox="476 384 859 443" style="list-style-type: none"><li data-bbox="476 384 859 410">► Be prepared to brake immediately.</li><li data-bbox="476 415 739 443">► Increase the distance.</li></ul> <p data-bbox="476 462 942 487">Function of Active Brake Assist (→ page 175).</p>
 <p data-bbox="144 596 413 645">Suspension warning lamp (yellow)</p>	<p data-bbox="463 503 1099 586">* The yellow AIRMATIC warning lamp is lit. The yellow DYNAMIC BODY CONTROL warning lamp is lit. A malfunction has occurred in AIRMATIC.</p> <p data-bbox="476 596 1099 622">A malfunction has occurred in the DYNAMIC BODY CONTROL.</p> <ul data-bbox="476 632 997 658" style="list-style-type: none"><li data-bbox="476 632 997 658">► Note the messages on the multifunction display.</li></ul>

## Driving safety systems

Warning/indicator lamp	Possible causes/consequences and ► Solutions
 <p data-bbox="195 384 380 407">ABS warning lamp</p>	<p data-bbox="513 291 1151 339">* The yellow ABS warning lamp is lit while the engine is running. ABS is malfunctioning.</p> <p data-bbox="526 350 1129 372">If an additional warning tone sounds, EBD is malfunctioning.</p> <p data-bbox="526 384 1304 407">Other driving systems and driving safety systems may also be malfunctioning.</p> <p data-bbox="526 418 1045 441">► Note the messages on the multifunction display.</p> <div data-bbox="532 464 1696 676" style="border: 1px solid gray; padding: 5px;"> <p data-bbox="541 470 1276 493"><b>⚠ WARNING</b> There is a risk of skidding if EBD or ABS is malfunctioning</p> <p data-bbox="541 511 911 534">The wheels may lock during braking.</p> <p data-bbox="541 545 1665 594">The steerability and braking characteristics are heavily impaired and the braking distance may increase. In addition, other driving safety systems are switched off.</p> <ul style="list-style-type: none"> <li data-bbox="541 606 765 628">► Drive on carefully.</li> <li data-bbox="541 640 1369 663">► Have the brake system checked immediately at a qualified specialist workshop.</li> </ul> </div>
 <p data-bbox="195 785 393 808">ESP® warning lamp</p>	<p data-bbox="513 695 1212 717">* The yellow ESP® warning lamp flashes while the vehicle is in motion.</p> <p data-bbox="526 729 556 752">or</p> <p data-bbox="526 763 1162 786">The yellow ESP® warning lamp is lit while the engine is running.</p> <p data-bbox="526 787 1271 810"><b>The yellow ESP® warning lamp flashes while the vehicle is in motion:</b></p> <p data-bbox="526 821 1138 844">One or more wheels has reached its grip limit (→ page 158).</p>

Warning/indicator lamp	Possible causes/consequences and ► Solutions
	<p>► Adapt your driving style to suit the road and weather conditions.  <b>The yellow ESP warning lamp® is lit while the engine is running.</b>                      ESP® is malfunctioning.                      Other driving systems and driving safety systems (e.g. BAS) may also be malfunctioning.</p> <p>► Note the messages on the multifunction display.</p> <div style="background-color: #f0f0f0; padding: 5px; border: 1px solid #ccc;"> <p><b>▲ WARNING</b> Risk of skidding if ESP® is malfunctioning</p> <p>If ESP® is malfunctioning, ESP® cannot carry out vehicle stabilization. In addition, other driving safety systems are switched off.</p> <ul style="list-style-type: none"> <li>► Drive on carefully.</li> <li>► Have ESP® checked at a qualified specialist workshop.</li> </ul> </div>
<div style="text-align: center;">  <p>ESP® OFF warning lamp</p> </div>	<p>* The yellow ESP® OFF warning lamp is lit while the engine is running.                      ESP® is deactivated.                      Other driving systems and driving safety systems may also be inoperative.</p> <div style="background-color: #f0f0f0; padding: 5px; border: 1px solid #ccc;"> <p><b>▲ WARNING</b> Risk of skidding when driving with ESP® deactivated</p> <p>ESP® does not act to stabilize the vehicle. The availability of further driving safety systems is also limited.</p> <ul style="list-style-type: none"> <li>► Drive on carefully.</li> </ul> </div>

Warning/indicator lamp	Possible causes/consequences and ► Solutions
	<ul style="list-style-type: none"> <li>► Deactivate ESP® only for as long as the situation requires.</li> <li>If ESP® cannot be activated, ESP® is malfunctioning.</li> <li>► Have ESP® checked immediately at a qualified specialist workshop.</li> </ul> <p>► Observe the notes on deactivating ESP® (→ page 158).</p>

### Tire pressure monitor

Warning/indicator lamp	Possible causes/consequences and ► Solutions
 <p>Tire pressure monitoring system warning lamp</p>	<p>*The yellow tire pressure monitor warning lamp (pressure loss/malfunction) flashes for approximately one minute and then remains lit.</p> <p><b>or</b></p> <p>The yellow tire pressure monitoring system warning lamp (pressure loss/malfunction) is lit.  <b>The yellow tire pressure monitor warning lamp (pressure loss/malfunction) flashes for approximately one minute and then remains lit:</b></p> <p>The tire pressure monitor is malfunctioning.</p> <p><b>▲ WARNING</b> There is a risk of an accident if the tire pressure monitoring system is malfunctioning</p> <p>The tire pressure monitoring system cannot issue a warning if there is pressure loss in one or more of the tires.</p>

Warning/indicator lamp	Possible causes/consequences and ► Solutions
	<p data-bbox="495 256 1548 280">Tires with insufficient tire pressure may impair the driving characteristics as well as steering and braking.</p> <p data-bbox="495 291 1378 314">► Have the tire pressure monitoring system checked at a qualified specialist workshop.</p> <p data-bbox="476 342 1474 366"><b>The yellow tire pressure monitoring system warning lamp (pressure loss/malfunction) is lit:</b></p> <p data-bbox="476 377 1424 400">The tire pressure monitoring system has detected tire pressure loss in at least one of the tires.</p> <p data-bbox="495 428 1166 452"><b>▲ WARNING</b> Risk of an accident due to insufficient tire pressure</p> <ul data-bbox="500 470 1400 560" style="list-style-type: none"><li>• The tires can burst.</li><li>• The tires can wear excessively and/or unevenly.</li><li>• The driving characteristics as well as the steering and braking may be greatly impaired.</li></ul> <p data-bbox="495 581 916 605">You could then lose control of the vehicle.</p> <p data-bbox="495 615 957 639">► Observe the recommended tire pressures.</p> <p data-bbox="495 649 901 673">► Adjust the tire pressure if necessary.</p> <p data-bbox="476 701 1092 725">► Stop the vehicle in accordance with the traffic conditions.</p> <p data-bbox="476 735 888 759">► Check the tire pressure and the tires.</p>



**1, 2, 3 ...****4MATIC**

Function..... 145

**12 V battery**

see Battery (vehicle)

**12 V socket**

see Socket (12 V)

**360° Camera**

Function..... 192

Selecting a view..... 194

Setting favorites..... 195

**A****A/C function**

Activating/deactivating (control panel)..... 125

**ABS (Anti-lock Braking System)**..... 157**Acceleration**

see Kickdown

**Accident and Breakdown Management**

Mercedes me connect..... 293

**Acoustic locking verification signal**

Activating/deactivating..... 64

**Activating/deactivating automatic volume adjustment**

Advanced sound system..... 321

Burmester® surround sound system..... 320

**Active Blind Spot Assist**

Brake application..... 184

Function..... 182

System limitations..... 182

**Active Brake Assist**

Function/notes..... 175

Setting..... 180

**Active Distance Assist DISTRONIC**

Active Emergency Stop Assist..... 173

Active Lane Change Assist..... 174

Calling up a speed..... 167

Function..... 165

Increasing/decreasing the speed..... 167

Route-based speed adaptation..... 169

Storing a speed..... 167

Switching off/deactivating..... 167

Switching on/activating..... 167

System limitations..... 165

**Active Emergency Stop Assist**..... 173**Active headlamps**..... 115**Active Lane Change Assist**

Activating/deactivating..... 175

Function..... 174

**Active Lane Keeping Assist**

Activating/deactivating..... 186

Activating/deactivating the warning..... 187

Function..... 185

System limits..... 185

**Active Parking Assist**

Exiting a parking space..... 202

Function..... 199

Parking..... 200

System limitations..... 199

**Active Service System PLUS**

see ASSYST PLUS

**Active Speed Limit Assist**

Display..... 169

Function..... 169

**Active Steering Assist**

Activating/deactivating..... 173

Active Emergency Stop Assist..... 173

- Active Lane Change Assist..... 174  
 Function..... 171  
 System limits..... 171
- Adaptive cruise control**  
 see Active Distance Assist DISTRONIC
- Adaptive Highbeam Assist**  
 Function..... 115  
 Switching on/off..... 116
- Additives**  
 Engine oil..... 395  
 Fuel..... 395
- Additives (engine oil)**  
 see Additives
- Additives (fuel)**  
 see Fuel
- Address book**  
 see Contacts
- Adjusting bass, mid-range and treble settings**  
 Advanced sound system..... 321
- Adjusting mid-range, treble and bass settings**  
 Advanced sound system..... 321
- Adjusting the balance/fader**  
 Advanced sound system..... 321  
 Burmester® surround sound system..... 320
- Adjusting the bass, mid-range and treble**  
 Burmester® surround sound system..... 320
- Adjusting the mid-range, treble and bass**  
 Burmester® surround sound system..... 320
- Adjusting the sound focus**  
 Burmester® surround sound system..... 320
- Adjusting treble, mid-range and bass settings**  
 Advanced sound system..... 321  
 Burmester® surround sound system..... 320
- ADS PLUS damping system**  
 see AIRMATIC
- Advanced sound system**  
 Adjusting the balance/fader..... 321  
 Adjusting treble, mid-range and bass settings..... 321  
 Calling up the sound menu..... 321  
 Information..... 320
- Switching volume adjustment on/off.... 321
- After-sales service center**  
 see ASSYST PLUS
- Air bag**  
 Reduced protection..... 44
- Air distribution**  
 Setting..... 124
- Air freshener system**  
 see Perfume atomizer
- Air inlet**  
 see Air-water duct
- Air pressure**  
 see Tire pressure
- Air suspension**  
 see AIRMATIC
- Air vents**  
 Adjusting (front)..... 127  
 Adjusting (rear)..... 127
- Air vents**  
 see Air vents
- Air-conditioning system**  
 see Climate control

- Air-recirculation mode**..... 125
- Air-water duct**  
 Keeping free..... 329
- Airbag**  
 Activation..... 36  
 Front airbag (driver, front passenger)..... 42  
 Installation locations..... 42  
 Knee airbag..... 42  
 Overview..... 42  
 PASSENGER AIR BAG indicator lamp..... 47  
 Protection..... 43  
 Side airbag..... 42  
 Window curtain airbag..... 42
- Airflow**  
 Setting..... 124
- AIRMATIC**  
 Setting..... 188  
 Suspension..... 188
- Alarm**  
 see Panic alarm
- Alarm system**  
 see ATA (anti-theft alarm system)
- All-wheel drive**  
 see 4MATIC
- Alternative route**  
 see Route
- Ambient lighting**  
 Setting (MBUX multimedia system)..... 118
- Android Auto**  
 Connecting a mobile phone (wireless)... 288  
 Ending..... 288  
 Information..... 287  
 Overview..... 287  
 Sound settings..... 288  
 Transferred vehicle data..... 289
- Animals**  
 Pets in the vehicle..... 62
- Anti-lock braking system**  
 see ABS (Anti-lock Braking System)
- Anti-skid chains**  
 see Snow chains
- Anti-theft protection**  
 Immobilizer..... 83
- Anti-theft protection**  
 see ATA (anti-theft alarm system)
- Anticipatory occupant protection**  
 see PRE-SAFE® (anticipatory occupant protection)  
 see PRE-SAFE® PLUS (anticipatory occupant protection plus)
- Apple CarPlay®**  
 Connecting an iPhone® ..... 286  
 Ending..... 287  
 Notes..... 286  
 Overview..... 285  
 Sound settings..... 287  
 Transferred vehicle data..... 289
- Assistance systems**  
 see Driving safety system
- ASSYST PLUS**  
 Battery disconnection periods..... 323  
 Displaying the service due date..... 322  
 Function/notes..... 322  
 Regular maintenance work..... 322  
 Special service requirements..... 322
- ATA (anti-theft alarm system)**  
 Activating/deactivating the interior motion sensor..... 85  
 Arming/disarming the tow-away alarm... 85

- Deactivating the alarm..... 84
- Function..... 83
- Function of the interior motion sensor.... 85
- The tow-away alarm function..... 84
- ATTENTION ASSIST**
- Function..... 161
- Setting..... 162
- System limitations..... 161
- Attention assistant**
- see ATTENTION ASSIST
- Audio mode**
- Activating media mode..... 302
- Connecting USB devices..... 303
- Copyrights..... 301
- Information..... 300
- Inserting/removing an SD card..... 302
- Media search..... 307
- Overview..... 303
- Pause and playback function..... 304
- Selecting a track..... 304
- Selecting playback options..... 304
- Track list..... 304
- Authorized Mercedes-Benz Center**
- see Qualified specialist workshop
- Authorized workshop**
- see Qualified specialist workshop
- Automatic distance control**
- see Active Distance Assist DISTRONIC
- Automatic driving lights**..... 113
- Automatic engine start (ECO start/stop function)**..... 137
- Automatic engine stop (ECO start/stop function)**..... 137
- Automatic front passenger front air-bag shutoff**
- Function of the automatic front passenger front airbag shutoff..... 45
- PASSENGER AIR BAG indicator lamp..... 47
- Automatic front passenger front air-bag shutoff**
- see Automatic front passenger front airbag shutoff
- Automatic mirror folding function**
- Activating/deactivating..... 123
- Automatic transmission**
- DIRECT SELECT lever..... 141
- Drive program display..... 140
- Drive programs..... 139
- DYNAMIC SELECT switch..... 139
- Engaging drive position..... 142
- Engaging neutral..... 142
- Engaging park position..... 142
- Engaging reverse gear..... 142
- Kickdown..... 144
- Manual gearshifting..... 143
- Steering wheel paddle shifters..... 143
- Transmission position display..... 141
- Transmission positions..... 141
- Automatic transmission (problem)**
- see Transmission (problem)
- B**
- Back seat**
- see Seats
- Bag hook**..... 105
- BAS (Brake Assist System)**..... 157
- Battery**
- see Battery (vehicle)
- Battery (SmartKey)**
- Replacing..... 65

- Battery (vehicle)**  
 Charging..... 347  
 Charging (Remote Online)..... 131  
 Notes..... 344  
 Notes (starting assistance and charging)..... 345  
 Replacing..... 349  
 Starting assistance..... 347
- Belt**  
 see Seat belt
- Blind Spot Assist**  
 Activating/deactivating..... 185  
 Function..... 182  
 System limitations..... 182
- Blower**  
 see Climate control
- Bluetooth®**  
 Activating/deactivating..... 237  
 Information..... 237
- Bluetooth® audio**  
 Activating..... 311  
 De-authorizing (de-registering) the device..... 312  
 Information..... 309
- Overview..... 310  
 Searching for a track..... 312  
 Searching for and authorizing the device..... 310  
 Selecting a media player..... 311  
 Switching device via NFC..... 312
- Brake Assist System**  
 see BAS (Brake Assist System)
- Brake fluid**  
 Notes..... 396
- Brake force distribution**  
 EBD (electronic brake force distribution)..... 159
- Brakes**  
 ABS (Anti-lock Braking System)..... 157  
 Active Brake Assist..... 175  
 BAS (Brake Assist System)..... 157  
 Breaking-in notes..... 132  
 Driving tips..... 133  
 EBD (electronic brake force distribution)..... 159  
 HOLD function..... 160  
 Limited braking effect (salt-treated roads)..... 133
- New/replaced brake linings/brake discs..... 132
- Braking assistance**  
 see BAS (Brake Assist System)
- Breakdown**  
 Changing a wheel..... 382  
 Overview of the help functions..... 18  
 Roadside Assistance..... 23  
 Tow-starting..... 354  
 Towing away..... 350  
 Transporting the vehicle..... 352
- Breakdown**  
 see Flat tire
- Breaking-in notes**..... 132
- Burmester® surround sound system**  
 Adjusting the balance/fader..... 320  
 Adjusting the sound focus..... 320  
 Adjusting treble, mid-range and bass settings..... 320  
 Automatic volume adjustment..... 320  
 Calls up the sound menu..... 320  
 Information..... 319  
 Switching the surround sound on/off... 320

**Buttons**

Steering wheel..... 207

**C****Call list**

Making a call..... 283

Overview..... 282

**Calling up the sound menu**

Advanced sound system..... 321

**Calls**

Accepting..... 279

Activating functions during a call..... 279

Calls with several participants..... 279

Declining..... 279

Ending a call..... 279

Incoming call during an existing call..... 280

Making..... 279

Mercedes me..... 289

**Calls up the sound menu**

Burmester® surround sound system.... 320

**Camera**

see 360° Camera

see Rear view camera

**Car key**

see SmartKey

**Car wash**

see Care

**Car wash (care)..... 329****Care**

Air-water duct..... 329

Automatic car wash..... 329

Carpet..... 334

Decorative foil..... 332

Display..... 334

Exterior lighting..... 333

Headliner..... 334

Matte finish..... 331

Paintwork..... 331

Plastic trim..... 334

Power washer..... 330

Real wood/trim elements..... 334

Rear view camera..... 333

Seat belt..... 334

Seat cover..... 334

Sensors..... 333

Steering wheel..... 334

Surround view camera..... 333

Tailpipes..... 333

Washing by hand..... 331

Wheels/rims..... 333

Windows..... 333

Wiper blades..... 333

**Cargo tie-down rings..... 105****Carpet (Care)..... 334****Change of address..... 23****Change of ownership..... 23****Changing a wheel**

Preparation..... 382

Raising the vehicle..... 383

**Changing a wheel**

see Emergency spare wheel

**Changing gears**

Manually..... 143

**Changing hub caps..... 382****Character entry**

Using the controller..... 234

**Charging**

Battery (vehicle)..... 347





















**Child seat**







































Attaching (notes)..... 54





- Basic instructions..... 50
- Front-passenger seat (notes)..... 60
- LATCH-type (ISOFIX) (installing)..... 55
- Notes on risks and dangers..... 51
- Securing on the front passenger seat..... 61
- Securing on the rear seat..... 58
- Top Tether..... 57
- Children**
- Avoiding dangers in the vehicle..... 51
- Basic instructions..... 50
- Special seat belt retractor..... 55
- Chock**
- Storage location..... 381
- Chock**
- see Chock
- Cleaning**
- see Care
- Climate control**
- Activating/deactivating..... 124
- Activating/deactivating the A/C function (control panel)..... 125
- Activating/deactivating the synchronization function (control panel)..... 125
- Air-recirculation mode..... 125
- Automatic control..... 125
- Control panel for 3-zone automatic climate control..... 124
- Control panel for dual-zone automatic climate control..... 124
- Defrosting the windshield..... 124
- Filling capacity for PAG oil..... 399
- Front air vents..... 127
- Inserting/removing the flacon (fragrance system)..... 126
- Ionization..... 125
- Note..... 124
- Rear air vents..... 127
- Refrigerant..... 398
- Refrigerant filling capacity..... 399
- Removing condensation from the windows..... 125
- Setting the air distribution..... 124
- Setting the airflow..... 124
- Setting the fragrance system..... 126
- Setting the vehicle interior temperature..... 124
- Switching the rear window heater on/off..... 124
- Ventilating the vehicle (convenience opening)..... 77
- Cockpit**
- Overview..... 6
- Coffee cup symbol**
- see ATTENTION ASSIST
- Collision detection (parked vehicle)**
- Information..... 153
- COMAND**
- see Multimedia system
- COMAND Touch**
- Managing devices..... 240
- Combination switch**..... 113
- Compass**..... 272
- Computer**
- see On-board computer
- Connecting the parcel net**..... 106
- Connection status**
- Displaying..... 298
- Overview..... 297
- Contacts**
- Calling up..... 281
- Deleting..... 282
- Downloading (from mobile phone)..... 280
- Importing..... 281

- Importing (overview)..... 281
  - Information..... 280
  - Making a call..... 282
  - Name format..... 281
  - Options..... 282
  - Storing..... 282
  - Controller**
    - Operating..... 228
  - Convenience closing**..... 78
  - Convenience opening**..... 77
  - Coolant (engine)**
    - Capacity..... 397
    - Check level..... 328
    - Notes..... 397
  - Cooling**
    - see Climate control
  - Copyrights**
    - License..... 34
    - Trademarks..... 34
  - Cornering light**..... 115
  - Cross Traffic Alert**..... 204
  - Crosswind Assist**
    - Function/notes..... 159
  - Cruise control**
    - Activating..... 163
    - Buttons..... 163
    - Calling up a speed..... 163
    - Deactivating..... 163
    - Function..... 163
    - Requirements:..... 163
    - Selecting..... 163
    - Setting a speed..... 163
    - Storing a speed..... 163
    - System limitations..... 163
  - Customer Assistance Center (CAC)**..... 28
  - Customer Relations Department**..... 28
- D**
- Dashboard**
    - see Cockpit
  - Data acquisition**
    - Vehicle..... 29
  - Data import/export**
    - Function/notes..... 242
    - Importing/exporting..... 242
  - Data protection rights**
    - Data storage..... 32
  - Data storage**
    - Data protection rights..... 32
    - Electronic control units..... 29
    - Online services..... 32
    - Vehicle..... 29
  - Date**
    - Setting the time and date automatically..... 236
  - Daytime running lamp mode**
    - see Daytime running lights
  - Daytime running lights**
    - Switching on/off..... 117
  - Deactivating the alarm (ATA)**..... 84
  - Dealership**
    - see Qualified specialist workshop
  - Declaration of conformity**
    - Wireless vehicle components..... 25
  - Decorative foil (cleaning instructions)**.... 332
  - Definitions (tires and loading)**..... 375
  - Destination**
    - Editing intermediate destinations..... 253
    - Editing the previous destinations..... 264
    - External..... 264



- Saving (current vehicle position)..... 263  
 Saving as a favorite..... 264  
 Saving as global favorite..... 264  
 Storing a map position..... 264
- Destination entry**  
 Entering a 3 word address..... 254  
 Entering a POI or address..... 249  
 Entering an intermediate destination.... 253  
 Entering geo-coordinates..... 254  
 Selecting a contact..... 254  
 Selecting a POI..... 252  
 Selecting from the map..... 255  
 Selecting previous destinations..... 251
- Detecting inattentiveness**  
 see ATTENTION ASSIST
- Diagnostics connection**..... 26
- Digital Operator's Manual**..... 20
- Dinghy towing**  
 see Tow-bar system
- DIRECT SELECT lever**  
 Engaging drive position..... 142  
 Engaging neutral..... 142  
 Engaging park position..... 142  
 Engaging park position automatically.... 142
- Engaging reverse gear..... 142  
 Function..... 141
- Display (care)**..... 334
- Display (multimedia system)**  
 Settings..... 235
- Display (on-board computer)**  
 Displays on the multifunction display.... 208
- Display message**  
 Calling up (on-board computer)..... 401  
 Notes..... 401
- Display messages**  
 --- mph..... 424  
 --- mph..... 424  
 12 V Battery See Operator's Manual..... 438  
 Active Headlamps Inoperative..... 408  
 ATTENTION ASSIST Inoperative.... 423  
 ATTENTION ASSIST: Take a Break!..... 424  
 Automatic Headlamp Mode Inoperative..... 407
-  Check Brake Fluid Level..... 422  
 Check Brake Pads See Operator's Manual..... 423  
 Check Coolant Level See Operator's Manual..... 413  
 Check Engine Oil At Next Refueling..... 445  
 Check Engine Oil Level (Add 1 quart)..... 446  
 Check Left Low Beam (example).. 407  
 Check Tires..... 441  
 Check Washer Fluid..... 413  
 Coolant Too Hot Stop Vehicle Turn Engine Off..... 414  
 Currently Unavailable See Operator's Manual..... 433  
 Currently Unavailable See Operator's Manual..... 434  
 Don't Forget Your Key..... 406  
 Drive More Slowly..... 432

- |                                                                                                                                              |                                                                                                                                                           |                                                                                                                                                                 |
|----------------------------------------------------------------------------------------------------------------------------------------------|-----------------------------------------------------------------------------------------------------------------------------------------------------------|-----------------------------------------------------------------------------------------------------------------------------------------------------------------|
|  Engine Oil Level Cannot Be Measured..... 448               |  Intell. Light System Inoperative.... 408                                |  Rear Left Backrest Not Latched (example)..... 412                           |
|  Engine Oil Level Low Stop Vehicle Turn Engine Off..... 446 |  Key Not Detected (red display message)..... 406                         |  Replace Key Battery..... 405                                                |
|  Engine Oil Pressure Stop Switch Off Engine..... 447        |  Key Not Detected (white display message)..... 405                       |  See Operator's Manual..... 439                                              |
|  Engine Oil Reduce Oil Level..... 446                       |  Left Side Curtain Airbag Malfunction Service Required (example).... 402 |  SRS Malfunction Service Required..... 402                                   |
|  Front Left Malfunction Service Required (example)..... 402 |  Lowering..... 431                                                       |  Steering Malfunction Increased Physical Effort See Operator's Manual... 410 |
|  Front Left Seat Backrest Not Locked (example)..... 412     |  Malfunction Drive at Max. 50 mph..... 430                               |  Steering Malfunction Stop Immediately See Operator's Manual..... 411        |
|  Fuel Level Low..... 415                                    |  Malfunction See Operator's Manual..... 407                              |  Stop Vehicle Leave Engine Running..... 440                                  |
|  Gas Cap Loose..... 415                                     |  Obtain a New Key..... 405                                               |  Stop Vehicle See Operator's Manual..... 439                                 |
|  Inoperative See Operator's Manual..... 434                 |  Off..... 425                                                            |  Stop Vehicle Vehicle Too Low..... 431                                       |
|  Inoperative See Operator's Manual..... 435                 |  Off..... 423                                                            |  Suspended..... 425                                                          |
|  Inoperative See Operator's Manual..... 436                 |  Parking Brake See Operator's Manual..... 418                            |  Switch Off Lights..... 408                                                  |
|  Inoperative..... 438                                       |  Please Correct Tire Pressure..... 442                                   |  Switch On Headlamps..... 408                                                |
|                                                                                                                                              |  Please Release Parking Brake..... 421                                   |  Turn On the Ignition to Release the Parking Brake..... 422                  |

-  Vehicle Ready to Drive Switch  
the Ignition Off Before Exiting..... 410
-  Vehicle Rising Please Wait..... 432
-  Vehicle Rising..... 432
-  Warning Tire Malfunction..... 442
-  Wheel Sensor(s) Missing..... 441
- Active Blind Spot Assist Currently  
Unavailable See Operator's Manual..... 428
- Active Blind Spot Assist Inoperative..... 429
- Active Brake Assist Functions Cur-  
rently Limited See Operator's Manual... 436
- Active Brake Assist Functions Limi-  
ted See Operator's Manual..... 437
- Active Distance Assist Currently  
Unavailable See Operator's Manual..... 425
- Active Distance Assist Inoperative..... 425
- Active Distance Assist Now Available... 425
- Active Lane Keeping Assist Camera  
View Restricted See Operator's Man-  
ual..... 429
- Active Lane Keeping Assist Currently  
Unavailable See Operator's Manual..... 429
- Active Lane Keeping Assist Inopera-  
tive..... 429
- Active Steering Assist Currently  
Unavailable Due to Multiple Emer-  
gency Stops..... 426
- Active Steering Assist Currently  
Unavailable See Operator's Manual..... 426
- Active Steering Assist Inoperative..... 426
- Adaptive Highbeam Assist Camera  
View Restricted See Operator's Man-  
ual..... 409
- Adaptive Highbeam Assist Currently  
Unavailable See Operator's Manual..... 409
- Adaptive Highbeam Assist Inoperative.. 409
- Apply Brake to Shift from 'P'..... 415
- Apply Brake to Shift to 'R'..... 416
- Auxiliary Battery Malfunction (white  
display message)..... 417
- Auxiliary Battery Malfunction (red  
display message)..... 418
- Beginning Emergency Stop..... 426
- Blind Spot Assist Currently Unavaila-  
ble See Operator's Manual..... 428
- Blind Spot Assist Inoperative..... 428
- Check Tire Pressure Soon..... 444
- Check Tire Pressure Then Restart  
Run Flat Indicator..... 444
- Cruise Control Inoperative..... 424
- Cruise Control Off..... 424
- Decrease Speed..... 443
- Driver's Door Open & Transmission  
Not in P Risk of Vehicle Rolling Away.... 416
- Front Passenger Airbag Disabled See  
Operator's Manual..... 403
- Front Passenger Airbag Enabled See  
Operator's Manual..... 403
- Hazard Warning Flashers Malfunc-  
tioning..... 410

- Mercedes me connect Services Limited See Operator's Manual..... 438
- N Permanently Active Risk of Rolling Away..... 416
- Only Shift to 'P' when Vehicle is Stationary..... 415
- Parking Assist and PARKTRONIC Inoperative See Operator's Manual..... 432
- Parking Assist Maneuvering Assistance Restricted See Operator's Manual..... 432
- Place the Key in the Marked Space See Operator's Manual..... 406
- PRE-SAFE Inoperative See Operator's Manual..... 404
- Radar Sensors Dirty See Operator's Manual..... 437
- Reversing Not Possible Service Required..... 417
- Run Flat Indicator Inoperative..... 445
- Service Required Do Not Shift Gears Visit Dealer..... 416
- Stop Vehicle Leave Engine Running Wait Transmission Cooling..... 417
- Tire Press. Monitor Currently Unavailable..... 440
- Tire Press. Monitor Inoperative..... 440
- Tire Pressure Monitor Inoperative No Wheel Sensors..... 441
- Tires Overheated..... 443
- To Deselect P or N, Depress Brake and Start Engine..... 416
- To switch engine off, press and hold Start/Stop button for at least 3 secs. or press 3 times..... 413
- Traffic Sign Assist Camera View Restricted See Operator's Manual..... 427
- Traffic Sign Assist Currently Unavailable See Operator's Manual..... 427
- Traffic Sign Assist Inoperative..... 427
- Transmission Malfunction Stop..... 417
- Display on the windshield**  
see Head-up Display
- Distance control**  
see Active Distance Assist DISTRONIC
- DISTRONIC**  
see Active Distance Assist DISTRONIC
- Door**  
Locking/unlocking (emergency key)..... 69  
Opening (from inside)..... 67  
Unlocking (from inside)..... 67
- Door control panel**..... 16
- DOT, Tire Identification Number (TIN)**..... 371
- Drawbar**  
see Tow-bar system
- Drinking and driving**..... 133
- Drive Away Assist**..... 203
- Drive Away Assist**  
see Protection against collision
- Drive position**  
Inserting..... 142
- Drive program display**..... 140

**Drive programs**

see DYNAMIC SELECT

**Driver's seat**

see Seat

**Driving safety system**

ABS (Anti-lock Braking System).....	157
Active Brake Assist.....	175
BAS (Brake Assist System).....	157
Cameras.....	155
EBD (electronic brake force distribution).....	159
ESP® Crosswind Assist.....	159
Overview.....	156
Radar and ultrasonic sensors.....	155
Responsibility.....	155
STEER CONTROL.....	159

**Driving system**

DYNAMIC BODY CONTROL.....	187
---------------------------	-----

**Driving system**

see 360° Camera  
 see Active Blind Spot Assist  
 see Active Distance Assist DISTRONIC  
 see Active Emergency Stop Assist  
 see Active Lane Change Assist

see Active Lane Keeping Assist  
 see Active Parking Assist  
 see Active Speed Limit Assist  
 see Active Steering Assist  
 see AIRMATIC  
 see ATTENTION ASSIST  
 see Blind Spot Assist  
 see Cruise control  
 see Driving safety system  
 see HOLD function  
 see Parking Assist PARKTRONIC  
 see Rear view camera  
 see Traffic Sign Assist

**Driving tips**

Breaking-in notes.....	132
Drinking and driving.....	133
General driving tips.....	133
Optimized acceleration.....	132

**Drowsiness detection**

see ATTENTION ASSIST

**DYNAMIC BODY CONTROL**

Suspension.....	187
-----------------	-----

**Dynamic handling control system**

see ESP® (Electronic Stability Program)

**DYNAMIC SELECT**

Configuring drive program I.....	140
Displaying engine data.....	140
Displaying vehicle data.....	140
Drive program display.....	140
Drive programs.....	139
Function.....	139
Operating (DYNAMIC SELECT switch)....	140
Selecting the drive program.....	140
Showing operation feedback.....	140

**E**

E10.....	394
----------	-----

**Easy entry feature**

Function/notes.....	97
Setting.....	98

**Easy exit feature**

Function/notes.....	97
Setting.....	98

**EBD (electronic brake force distribution)**

Function/notes.....	159
---------------------	-----

**ECO display**

Function.....	138
---------------	-----

- ECO start/stop function**  
 Automatic engine start..... 137  
 Automatic engine stop..... 137  
 Method of operation..... 137  
 Switching off/on..... 138
- Electric parking brake**  
 Applying automatically..... 151  
 Applying/releasing manually..... 153  
 Emergency braking..... 153  
 Releasing automatically..... 152
- Electronic Stability Program**  
 see ESP® (Electronic Stability Program)
- Emergency**  
 First-aid kit (soft sided)..... 337  
 Overview of the help functions..... 18  
 Reflective safety vest..... 336  
 Removing the warning triangle..... 336  
 Setting up the warning triangle..... 337
- Emergency braking**..... 153
- Emergency braking**  
 see BAS (Brake Assist System)
- Emergency engine start**..... 354
- Emergency key**  
 Locking/unlocking the doors..... 69
- Emergency operation mode**  
 Starting the vehicle..... 130
- Emergency release**  
 Trunk lid (from inside)..... 75
- Emergency spare wheel**  
 Notes..... 387
- Emergency Tensioning Devices**  
 Activation..... 36
- ENERGIZING COMFORT**  
 Overview of programs..... 247  
 Starting the program..... 247
- Engine**  
 ECO start/stop function..... 137  
 Engine number..... 391  
 Starting (emergency operation mode)... 130  
 Starting (Remote Online)..... 131  
 Starting (start/stop button)..... 129  
 Starting assistance..... 347  
 Switching off (start/stop button)..... 147
- Engine data**  
 Displaying..... 140
- Engine number**..... 391
- Engine oil**  
 Additives..... 395  
 Capacity..... 396  
 Checking the oil level using the oil  
 dipstick..... 325  
 Checking the oil level using the on-  
 board computer..... 326  
 MB-Freigabe or MB-Approval..... 396  
 Quality..... 396  
 Refilling..... 326
- Entering characters**  
 Function/notes..... 233  
 On the touchpad..... 235
- ESC (Electronic Stability Control)**  
 see ESP® (Electronic Stability Program)
- ESP®**  
 Crosswind Assist..... 159
- ESP® (Electronic Stability Program)**  
 Activating/deactivating..... 159  
 Function/notes..... 158
- Exterior lighting**  
 Care..... 333

- Exterior lighting**  
 see Lights
- Exterior mirrors**  
 Automatic mirror folding function..... 123  
 Folding in/out..... 121  
 Operating the memory function..... 99  
 Parking position..... 122  
 Setting..... 121
- F**
- Fatigue detection**  
 see ATTENTION ASSIST
- Favorites**  
 Adding..... 231  
 Calling up..... 231  
 Deleting..... 231  
 Moving..... 231  
 Overview..... 230  
 Renaming..... 231
- First-aid kit (soft sided)..... 337**
- Flacon**  
 Inserting/removing..... 126
- Flat tire**  
 Changing a wheel..... 382
- MOExtended tires..... 338  
 Notes..... 337  
 TIREFIT kit..... 339
- Flat towing**  
 see Tow-bar system
- Floor mats..... 110**
- Foil covering**  
 Radar and ultrasonic sensors..... 155
- Fragrance**  
 see Perfume atomizer
- Free software..... 34**
- Frequencies**  
 Two-way radio..... 390
- Front airbag (driver, front passenger)..... 42**
- Front passenger seat**  
 see Seat
- Fuel**  
 Additives..... 395  
 E10..... 394  
 Fuel reserve..... 395  
 Gasoline..... 394  
 Quality (gasoline)..... 394  
 Refueling..... 145
- Sulfur content..... 394  
 Tank content..... 395
- Function seat**  
 see Door control panel
- Fuses**  
 Before replacing a fuse..... 354  
 Dashboard fuse box..... 356  
 Fuse assignment diagram..... 354  
 Fuse box in the engine compartment.... 355  
 Fuse box in the front-passenger foot-  
 well..... 356  
 Fuse box in the trunk..... 357  
 Notes..... 354
- Fuses**  
 see Fuses
- G**
- Garage door opener**  
 Clearing the memory..... 151  
 Programming buttons..... 149  
 Resolving problems..... 151  
 Synchronizing the rolling code..... 150
- Garage door openers**  
 Opening/closing the door..... 151

**Gas station search**

- Starting automatic search..... 252
- Switching the automatic search on/  
off..... 258
- Using automatic search..... 258

**Gasoline**..... 394

**Gearshift recommendation**..... 144

**Genuine parts**..... 21

**Glide mode**..... 144

**H****Handbrake**

see Electric parking brake

**Handling characteristics (unusual)**..... 358

**HANDS-FREE ACCESS**..... 73

**Hazard warning lights**..... 114

**Hazardous substances**

Information..... 24

**Head restraint**

- Front (adjusting mechanically)..... 90
- Rear (removing/installing)..... 91

## Rear passenger compartment

(adjusting)..... 91

**Head-up Display**

- Adjusting display elements (on-board  
computer)..... 209
- Adjusting the brightness (on-board  
computer)..... 209
- Function..... 208
- Menu (on-board computer)..... 209
- Operating the memory function..... 99
- Setting the position (on-board com-  
puter)..... 209
- Switching on/off..... 210

**Headlamps**

see Automatic driving lights

**Headliner (care)**..... 334

**Heating**

see Climate control

**Help call**

see Mercedes-Benz emergency call system

**High beam**

Activating/deactivating..... 113

**High beam**

see Adaptive Highbeam Assist

**High-beam flasher**..... 113

**Hill start assist**..... 161

**HOLD function**

- Function/notes..... 160
- Switching on/off..... 160

**Hood**

Opening/closing..... 323

**Hotspot**

Setting up (Wi-Fi)..... 239

**I****Identification plate**

- Engine..... 391
- Refrigerant..... 398
- Vehicle..... 391

**Ignition**

Switching on (Start/Stop button)..... 128

**Ignition key**

see SmartKey

**Immobilizer**..... 83



- Indicator lamp**  
see Warning/indicator lamp
- Individual drive program**  
Configuring..... 140  
Selecting..... 140
- Inside rearview mirror**  
Anti-glare mode (automatic)..... 122
- Inside rearview mirror**  
see Outside mirrors
- Inspection**  
see ASSYST PLUS
- Instrument cluster**  
Function/notes..... 205, 206
- Instrument Display**  
Function/notes..... 206  
Instrument cluster..... 10  
Warning/indicator lamps..... 448
- Instrument Display and on-board computer**  
Function/notes..... 205
- Intelligent Light System**  
Active headlamps..... 115  
Adaptive Highbeam Assist..... 115  
Cornering light..... 115
- Interior lighting**  
Adjusting..... 117  
Ambient lighting..... 118  
Reading lamp..... 117  
Switch-off delay time..... 118
- Interior motion sensor**  
Activating/deactivating..... 85  
Function..... 85
- Intermediate destination**  
Calculating a route with intermediate destinations..... 253  
Entering..... 253  
Modifying..... 253  
Starting an automatic gas station search..... 252  
Starting the automatic service station search..... 259
- Internet connection**  
Communication module function..... 297  
Displaying the connection status..... 298  
Information..... 296  
Overview of connection status..... 297  
Restrictions..... 296
- Internet radio**  
see Tuneln
- Ionization**  
Activating/deactivating (multimedia system)..... 125
- iPhone®**  
see Apple CarPlay®  
see Mercedes-Benz Link
- J**
- Jack**  
Storage location..... 381
- Jump-start connection**  
General notes..... 345
- K**
- KEYLESS-GO**  
Deactivating a function..... 64  
Locking/unlocking the vehicle..... 67  
Problem..... 68  
Unlocking setting..... 64
- Kickdown**  
Using..... 144

**Knee airbag**..... 42

## L

### Labeling (tires)

see Tire labeling

### Lamp

see Interior lighting

### Lamp (instrument display)

see Warning/indicator lamp

### Lane detection (automatic)

see Active Lane Keeping Assist

### Lane Keeping Assist

see Active Lane Keeping Assist

### Language

Notes..... 241

Setting..... 241

### LATCH-type (ISOFIX) child seat

#### anchor

Installing..... 55

### Level control system

see AIRMATIC

### Light switch

Overview..... 112

### Lighting

see Interior lighting

see Lights

### Lights

Active headlamps..... 115

Adaptive Highbeam Assist..... 115

Automatic driving lights..... 113

Combination switch..... 113

Cornering light..... 115

Hazard warning lights..... 114

High beam..... 113

High-beam flasher..... 113

Light switch..... 112

Low-beam headlamps..... 112

Parking lights..... 112

Rear fog lamp..... 112

Responsibility for lighting systems..... 112

Setting the exterior lighting switch-

off delay time..... 117

Setting the surround lighting..... 117

Standing lights..... 112

Turn signal light..... 113

### Limited Warranty

Vehicle..... 29

### Live Traffic Information

Displaying subscription information..... 265

Displaying the traffic map..... 265

Displaying traffic incidents..... 266

Extending a subscription..... 265

Issuing hazard alerts..... 267

**Load index (tires)**..... 373

**Load-bearing capacity (tires)**..... 373

### Loading

Bag hook..... 105

Cargo tie-down rings..... 105

Definitions..... 375

Notes..... 100

Roof luggage rack..... 107

**Loading guidelines**..... 100

**Loading information table**..... 366

### Loads

Securing..... 100

### Locator lighting

see Surround lighting

### Locking an external device (child

safety lock)..... 241

- Locking/unlocking**  
 Activating/deactivating the automatic locking feature..... 69  
 Emergency key..... 69  
 KEYLESS-GO..... 67  
 Unlocking/opening the doors from the inside..... 67
- Low-beam headlamps**  
 Switching on/off..... 112
- Lubricant additives**  
 see Additives
- Luggage**  
 Parcel net..... 106  
 Securing..... 100
- Lumbar support**  
 see Lumbar support (4-way)
- Lumbar support (4-way)**..... 90
- M**
- Maintenance**  
 Vehicle..... 23
- Maintenance**  
 see ASSYST PLUS
- Malfunction**  
 Restraint system..... 36
- Malfunction message**  
 see Display message
- Maneuvering assistance**  
 Activating/deactivating..... 204  
 Cross Traffic Alert..... 204  
 Drive Away Assist..... 203
- Map**  
 Avoiding an area..... 270  
 Avoiding an area (overview)..... 270  
 Changing an area..... 270  
 Deleting an area..... 271  
 Displaying online map contents..... 272  
 Displaying the compass..... 272  
 Displaying the map version..... 270  
 Displaying the next intersecting street.. 269  
 Displaying the satellite map..... 272  
 Displaying the traffic map..... 265  
 Displaying weather information..... 272  
 Map data..... 271  
 Moving..... 268  
 Overview..... 267  
 Selecting POI symbols..... 269  
 Selecting text information..... 269
- Selecting the map orientation..... 269  
 Setting the map scale..... 268  
 Setting the map scale automatically..... 272  
 Updating..... 271
- Map and compass**  
 Overview..... 267
- Message programs**  
 Resetting the settings..... 92  
 Selecting the front seats..... 92
- Matte finish (cleaning instructions)**..... 331
- Maximum load rating**..... 372
- Maximum permissible load**  
 Calculation example..... 368  
 Determining..... 367
- Maximum tire pressure**..... 372
- MBUX multimedia system**  
 Calling up applications..... 230  
 Collision detection (parked vehicle)..... 153  
 Resetting (factory setting)..... 246  
 Setting the fragrance system..... 126  
 Switching ionization on/off..... 125  
 Switching the sound on/off..... 232  
 To adjust the volume..... 233

- Mechanical key**  
 Inserting/removing..... 65
- Media**  
 Searching..... 307
- Media display**  
 Notes..... 226
- Media Interface**  
 Activating..... 308  
 Information..... 307  
 Overview..... 308
- Media mode**  
 Activating..... 302
- Media search**  
 Starting..... 307
- Medical aids**..... 27
- Memory function**  
 Function..... 98  
 Head-up Display – Calling up stored settings..... 99  
 Head-up Display – Storing settings..... 99  
 Operating..... 99  
 Outside mirrors – Calling up stored settings..... 99  
 Outside mirrors – Storing settings..... 99  
 Seat – Calling up stored settings..... 99  
 Seat – Storing settings..... 99  
 Steering wheel – Calling up saved settings..... 99  
 Steering wheel – Saving settings..... 99
- Menu (on-board computer)**  
 Head-up Display..... 209  
 Overview..... 207
- Mercedes me calls**  
 Arranging a service appointment..... 291  
 Calling the Mercedes-Benz Customer Center..... 290  
 Calling the Mercedes-Benz Customer Center after automatic accident or breakdown detection..... 290  
 Information..... 290  
 Making a call via the overhead control panel..... 289  
 Transferred data..... 291
- Mercedes me connect**  
 Accident and Breakdown Management..... 293  
 Information..... 293  
 Transferred data..... 293
- Mercedes-AMG vehicles**  
 Notes..... 128
- Mercedes-Benz Apps**  
 Calling up..... 298  
 Using with voice control..... 298
- Mercedes-Benz emergency call system**  
 Automatic emergency call..... 295  
 Information..... 293  
 Information on data transfer..... 296  
 Manual emergency call..... 295  
 Overview..... 294
- Mercedes-Benz Link**  
 Connecting..... 285  
 Ending..... 284  
 Overview..... 284  
 Using..... 285
- Message (multifunction display)**  
 see Display message
- Message memory**..... 401
- Messages**  
 Voice commands (Voice Control System)..... 222

**Messages**

see Text messages

**Mirrors**

see Exterior mirrors

**Mobile phone**

see Android Auto  
 see Apple CarPlay®  
 see Mercedes-Benz Link  
 see Second telephone  
 see Telephone

**Mobile phone voice recognition**

Starting..... 279  
 Stopping..... 279

**Model series**

see Vehicle identification plate

**MOExtended tires**..... 338

**Multifunction display**

Overview of the displays..... 208

**Multifunction steering wheel**

Overview of buttons..... 207

**Multifunction steering wheel**

see Steering wheel

**Multimedia system**

Activating/deactivating standby mode..... 154  
 Central control elements..... 227  
 Configuring display settings..... 235  
 Configuring drive program I..... 140  
 ENERGIZING COMFORT program (overview)..... 247  
 Favorites..... 230  
 Overview..... 226  
 Starting the ENERGIZING COMFORT program..... 247

**Multimedia system**

see Entering characters  
 see Touchpad

**N****Navigation**

Showing/hiding the menu..... 248  
 Switching on..... 248  
 Updating the map data..... 271  
 Voice commands (Voice Control System)..... 215

**Navigation**

see Destination

see Destination entry

see Map

see Route

see Route guidance

see Traffic information

**Navigation announcements**

Activating/deactivating..... 261  
 Adjusting the volume..... 262  
 Repeating..... 262  
 Switching audio fadeout on/off..... 262

**Near Field Communication (NFC)**

Connecting the mobile phone to the multimedia system..... 278  
 Information..... 278  
 Switching Bluetooth® audio equipment..... 312  
 Switching mobile phones..... 278  
 Using a mobile phone..... 278

**Neutral**

Inserting..... 142

**NFC**

see Near Field Communication (NFC)

## O

**Occupant safety**

- see Airbag
- see Automatic front passenger front airbag shutoff
- see Child seat
- see Pets in the vehicle
- see PRE-SAFE® (anticipatory occupant protection)
- see PRE-SAFE® PLUS (anticipatory occupant protection plus)
- see Restraint system
- see Seat belt

**Oil**

- see Engine oil

**On-board computer**

- Displaying the service due date..... 322
- Head-up Display menu..... 209
- Multifunction display..... 208
- Operating..... 207
- Overview of menus..... 207

**On-board diagnostics interface**

- see Diagnostics connection

**On-board electronics**

- Notes..... 389
- Two-way radios..... 389

**Online services**

- Data storage..... 32

**Open-source software..... 34****Opening the trunk lid using your foot**

- HANDS-FREE ACCESS..... 73

**Operating fluids**

- Additives (fuel)..... 395
- Brake fluid..... 396
- Coolant (engine)..... 397
- Engine oil..... 395
- Fuel (gasoline)..... 394
- Notes..... 392
- Refrigerant (air conditioning system)..... 398
- Windshield washer fluid..... 397

**Operating safety**

- Declaration of conformity (wireless vehicle components)..... 25
- Information..... 24

**Operating system**

- see On-board computer

**Operator's Manual**

- Vehicle equipment..... 22

**Operator's Manual (digital)..... 20****Optimized acceleration**

- Activating..... 132

**Outside mirrors**

- Anti-glare mode (automatic)..... 122

**Overhead control panel**

- Overview..... 14

## P

**Paint code..... 391****Paintwork (cleaning instructions)..... 331****Panic alarm**

- Activating/deactivating..... 64

**Panorama roof with power tilt/sliding panel**

- see Sliding sunroof

**Park position**

- Inserting..... 142
- Selecting automatically..... 142

- Parking**
  - see Electric parking brake
- Parking aid**
  - see Parking Assist PARKTRONIC
- Parking Assist PARKTRONIC**
  - Activating..... 198
  - Adjusting warning tones..... 198
  - Function..... 195
  - Side impact protection..... 197
  - Switching off..... 198
  - System limitations..... 195
- Parking assistance systems**
  - see Active Parking Assist
- Parking brake**
  - see Electric parking brake
- Parking for an extended period**..... 154
- Parking lights**..... 112
- Parking position**
  - Exterior mirrors..... 122
  - Storing the position of the front-passenger outside mirror using reverse gear..... 123
- PASSENGER AIR BAG status display**
  - see Automatic front passenger front airbag shutoff
- Payload**
  - Calculation example..... 368
  - Determining the maximum..... 367
- Perfume**
  - see Perfume atomizer
- Perfume atomizer**
  - Inserting/removing the flacon..... 126
  - Setting..... 126
- Perfume vial**
  - see Perfume atomizer
- Period out of use**
  - Activating/deactivating standby mode..... 154
  - Standby mode function..... 154
- Permitted towing methods**..... 349
- Personalization**
  - see User profile
- Pets in the vehicle**..... 62
- Phone book**
  - see Contacts
- Picture formats**
  - see Video mode
- Picture settings**
  - see Video mode
- PIN protection**
  - Activating/deactivating..... 242
- Plastic trim (Care)**..... 334
- Playback options**
  - Selecting..... 304
- POI**
  - Selecting..... 252
- POI symbols**
  - Selecting..... 269
- Power supply**
  - Switching on (Start/Stop button)..... 128
- Power washer (care)**..... 330
- PRE-SAFE® (anticipatory occupant protection)**
  - Function..... 49
  - PRE-SAFE® Sound..... 49
  - Reversing measures..... 50

**PRE-SAFE® PLUS (anticipatory occupant protection plus)**

- Function..... 50
- Reversing measures..... 50

**Preventative occupant protection system**

- see PRE-SAFE® (anticipatory occupant protection)
- see PRE-SAFE® PLUS (anticipatory occupant protection plus)

**Previous destinations**

- Selecting..... 251

**Programs**

- see DYNAMIC SELECT

**Protecting the environment**

- Notes..... 21

**Protection against collision..... 203****Pulling away**

- see Driving tips

**Q****QR code**

- Rescue card..... 29

**Qualified specialist workshop..... 27****R****Radar and ultrasonic sensors**

- Damage..... 155

**Radio**

- Activating..... 312
- Activating/deactivating radio text..... 315
- Calling up the station list..... 314
- Deleting stations..... 314
- Direct frequency entry..... 314
- Displaying information..... 315
- Displaying radio text..... 315
- Managing favorites..... 314
- Managing station presets..... 314
- Moving stations..... 314
- Overview..... 313
- Searching for stations..... 314
- Setting a channel..... 314
- Setting the waveband..... 314
- Storing radio stations..... 314
- Switching the HD Radio function on/off..... 314
- Voice commands (Voice Control System)..... 219

**Rain-closing feature**

- Sliding sunroof..... 82

**Reading lamp**

- see Interior lighting

**Real wood (Care)..... 334****Rear fog lamp**

- Switching on/off..... 113

**Rear seat**

- see Seats

**Rear view camera**

- Care..... 333
- Function..... 190
- Opening the camera cover (surround view camera)..... 195
- Setting favorites (360° Camera)..... 195

**Rear window heater..... 124****Reflective safety vest..... 336****Refrigerant (air conditioning system)**

- Notes..... 398

**Refueling**

- Refueling the vehicle..... 145

**Regulatory radio identification..... 390**



- Remote Online**
  - Charging the starter battery..... 131
  - Cooling/heating the vehicle interior..... 131
  - Starting the vehicle..... 131
- Reporting safety defects**..... 28
- Rescue card**..... 29
- Reserve**
  - Fuel..... 395
- Reset function (MBUX multimedia system)**..... 246
- Reset function (MBUX multimedia system)**
  - see Reset function (MBUX multimedia system)
- Resetting (factory setting)**
  - see Reset function (MBUX multimedia system)
- Restraint system**
  - Basic instructions for children..... 50
  - Function in an accident..... 36
  - Functionality..... 35
  - Malfunction..... 36
  - Protection..... 35
- Reduced protection..... 35
- Self-test..... 35
- Warning lamp..... 35
- Reverse gear**
  - Inserting..... 142
- Rims (care)**..... 333
- Roadside Assistance (breakdown)**..... 23
- Roll away protection**
  - see HOLD function
- Roller sunblind**
  - Sliding sunroof..... 79
- Roof load**..... 400
- Roof luggage rack**
  - Loading..... 107
  - Securing..... 107
- Route**
  - Calculating..... 256
  - Displaying destination information..... 258
  - Planning..... 253
  - Selecting a type..... 256
  - Selecting an alternative route..... 258
  - Selecting notifications..... 258
  - Selecting options..... 257
- Starting the automatic service station search..... 259
- Switching the automatic gas station search on/off..... 258
- Using automatic gas station search..... 258
- With intermediate destinations..... 253
- Route guidance**
  - Canceling..... 262
  - Changing direction..... 260
  - Destination reached..... 261
  - From an off-road location..... 263
  - Lane recommendations..... 261
  - Notes..... 259
  - Off-road..... 263
  - To an off-road destination..... 263
- Route-based speed adaptation**
  - Function..... 169
- Route-based speed adjustment**
  - Setting..... 171
- Run-flat characteristics**
  - MOExtended tires..... 338

- S**
- Safety systems**  
see Driving safety system
- Satellite map**..... 272
- Satellite radio**  
Activating/deactivating TuneStart..... 318  
Adding a channel to Smart Favorites..... 318  
Deleting a channel..... 317  
Displaying EPG information..... 317  
Displaying service information..... 319  
Information..... 315  
Information about Smart Favorites  
and TuneStart..... 318  
Logging in..... 315  
Moving a channel..... 317  
Music and sport alerts function..... 317  
Overview..... 316  
Pause and playback function..... 318  
Restrictions..... 315  
Selecting a category..... 316  
Selecting a channel..... 317  
Setting music and sport alerts..... 317  
Setting the parental control..... 317  
Storing a channel..... 317
- Switching on..... 315
- SD card**  
Inserting/removing..... 302
- Seat**  
4-way lumbar support..... 90  
Adjusting (electrically)..... 89  
Adjusting (manually and electrically)..... 87  
Configuring the settings..... 92  
Correct driver's seat position..... 86  
Folding back the backrest (rear  
passenger compartment)..... 104  
Folding the backrest forwards/back  
(with memory function)..... 92  
Folding the backrest forwards/back-  
wards (without memory function)..... 93  
Locking the backrest (rear passenger  
compartment)..... 104  
Operating the memory function..... 99  
Resetting the settings..... 92  
Setting options..... 16
- Seat belt**  
Care..... 334  
Fastening..... 40  
Protection..... 37
- Seat belt adjustment**  
Activating/deactivating..... 41  
Function..... 41
- Seat belt extender**..... 40
- Seat belt warning**  
see Seat belts
- Seat belts**  
Activating/deactivating seat belt  
adjustment..... 41  
Reduced protection..... 38  
Releasing..... 41  
Seat belt adjustment (function)..... 41  
Seat belt extender..... 40  
Warning lamp..... 41
- Seat cover (Care)**..... 334
- Seat heating**  
Activating/deactivating..... 94
- Seat ventilation**  
Activating/deactivating..... 95
- Seats**  
Folding the backrest forwards (rear  
passenger compartment)..... 102

- Second telephone**  
 Connecting..... 276  
 Features..... 276
- Selecting a gear**  
 see Changing gears
- Selector lever**  
 see DIRECT SELECT lever
- Self-test**  
 Automatic front passenger front air-  
 bag shutoff..... 47
- Sensors (care)..... 333**
- Service center**  
 see Qualified specialist workshop
- Service interval display**  
 see ASSYST PLUS
- Service station search**  
 Starting automatic search..... 259
- Setting a speed**  
 see Cruise control
- Setting summer time..... 236**
- Setting the date format..... 237**
- Setting the distance unit..... 241**
- Setting the map scale**  
 see Map
- Shift paddles**  
 see Steering wheel paddle shifters
- Shifting gears**  
 Gearshift recommendation..... 144
- Short messages**  
 see Text messages
- Side airbag..... 42**
- Side impact protection..... 197**
- Side windows**  
 Closing using the SmartKey..... 78  
 Convenience closing..... 78  
 Convenience opening..... 77  
 Opening with the SmartKey..... 77  
 Opening/closing..... 76  
 Problem..... 78
- Size designation (tires)..... 373**
- Sliding sunroof**  
 Automatic features..... 82  
 Closing..... 79  
 Closing using the SmartKey..... 78  
 Opening..... 79
- Opening with the SmartKey..... 77  
 Problem..... 82  
 Rain-closing feature..... 82
- SmartKey**  
 Acoustic locking verification signal..... 64  
 Battery..... 65  
 Deactivating a function..... 64  
 Energy consumption..... 64  
 Function overview..... 63  
 Key ring attachment..... 65  
 Mechanical key..... 65  
 Panic alarm..... 64  
 Problem..... 66  
 Unlocking setting..... 64
- Smartphone**  
 see Android Auto  
 see Apple CarPlay®  
 see Mercedes-Benz Link  
 see Telephone
- Snow chains..... 359**
- Socket (12 V)**  
 Front center console..... 108  
 Trunk/cargo compartment..... 108

- Software update**  
Performing..... 245  
Software updates..... 244  
System updates..... 245
- Sound**  
PRE-SAFE® Sound..... 49  
Wheels and tires..... 358
- Sound**  
see Advanced sound system  
see Burmester® surround sound system  
see Sound settings
- Sound settings**  
Adjusting the balance/fader..... 319  
Adjusting treble, mid-range and bass  
settings..... 319  
Automatic volume adjustment..... 319  
Calls up the sound menu..... 319  
Information..... 319
- Spare wheel**  
see Emergency spare wheel
- Special seat belt retractor**..... 55
- Specialist workshop**  
see Qualified specialist workshop
- Speech dialog system**  
see Voice Control System
- Speed index (tires)**..... 373
- Standby mode**  
Activating/deactivating..... 154  
Function..... 154
- Standing lights**..... 112
- Start-off assist**  
see Optimized acceleration
- Start/stop button**  
Parking the vehicle..... 147  
Starting the vehicle..... 129  
Switching on the power supply or  
ignition..... 128
- Start/stop function**  
see ECO start/stop function
- Starter battery**  
Charging (Remote Online)..... 131
- Starting**  
see Vehicle
- Starting assistance**  
see Jump-start connection
- Starting-off aid**  
see Hill start assist
- Station**  
Deleting..... 314  
Direct frequency entry..... 314  
Moving..... 314  
Searching..... 314  
Setting..... 314  
Storing..... 314
- Station list**  
Calling up..... 314
- Station presets**  
Managing..... 314
- STEER CONTROL**  
Function/notes..... 159
- Steering wheel**  
Adjusting (electrically)..... 96  
Adjusting (manually)..... 95  
Buttons..... 207  
Care..... 334  
Operating the memory function..... 99  
Steering wheel heater..... 97
- Steering wheel heater**  
Activating/deactivating..... 97

- Steering wheel paddle shifters**..... 143
- Storage areas**  
see Storage space
- Storage compartments**  
see Storage space
- Storage space**  
Armrest..... 102  
Center console..... 102  
Door..... 102  
Glove box..... 102
- Stowage areas**  
see Loading
- Stowage compartments**  
see Loading
- Sulfur content**..... 394
- Surround lighting**  
Setting..... 117
- Surround View**  
see 360° Camera
- Surround view camera**  
Care..... 333  
Opening the camera cover (rear view camera)..... 195
- Suspension**  
Damping characteristics..... 187  
DYNAMIC BODY CONTROL..... 187  
Setting the suspension level (AIR-MATIC)..... 188
- Suspension**  
see AIRMATIC
- Suspension level (AIRMATIC)**  
Setting..... 188
- Switch-off delay time**  
Exterior..... 117  
Interior..... 118
- Switching the surround sound on/off**  
Burmester® surround sound system.... 320
- Synchronization function**  
Activating/deactivating (control panel)..... 125
- System settings**  
Activating/deactivating PIN protection..... 242  
Reset function (MBUX multimedia system)..... 246  
Setting the distance unit..... 241
- Setting the time and date automatically..... 236  
Setting the time zone..... 236  
Setting the time/date format..... 237  
Switching transmission of the vehicle position on/off..... 237
- System settings**  
see Bluetooth®  
see Data import/export  
see Language  
see Wi-Fi
- T**
- Tailpipes (care)**..... 333
- Tank content**  
Fuel..... 395  
Reserve (fuel)..... 395
- Technical data**  
Information..... 389  
Regulatory radio identification..... 390  
Vehicle identification plate..... 391
- Telephone**  
Activating functions during a call..... 279  
Call and ringtone volume..... 279

- Calls with several participants..... 279
  - Connecting a mobile phone (Near Field Communication (NFC))..... 278
  - Connecting a mobile phone (Passkey)... 275
  - Connecting a mobile phone (Secure Simple Pairing)..... 275
  - De-authorizing a mobile phone..... 277
  - Disconnecting a mobile phone..... 277
  - Importing contacts..... 281
  - Importing contacts (overview)..... 281
  - Incoming call during an existing call..... 280
  - Information..... 275
  - Interchanging mobile phones..... 276
  - Mobile phone voice recognition..... 279
  - Notes..... 273
  - Operating modes..... 275
  - Reception and transmission volume..... 278
  - Switching mobile phones (Near Field Communication (NFC))..... 278
  - Telephone menu overview..... 274
  - Telephone operation..... 279
  - Using Near Field Communication (NFC)..... 278
  - Voice commands (Voice Control System)..... 218
  - Wireless charging (mobile phone)..... 110
- Telephony operating modes**
    - Bluetooth® Telephony..... 275
  - Telephony operating modes**  
see Second telephone
  - Temperature**
    - Setting the vehicle interior temperature..... 124
  - Temperature grade**..... 370
  - Text messages**
    - Calling a message sender..... 284
    - Changing folders..... 284
    - Composing..... 283
    - Configuring the displayed text messages..... 283
    - Deleting..... 284
    - Drafts..... 284
    - Notes..... 283
    - Options..... 284
    - Outbox..... 284
    - Read-aloud function..... 283
    - Reading..... 283
    - Replying..... 284
    - Sending..... 283
  - Voice commands (Voice Control System)..... 222
  - Through-loading feature**  
see Seats
  - Time**
    - Manual time setting..... 237
    - Setting summer time..... 236
    - Setting the time and date automatically..... 236
    - Setting the time zone..... 236
    - Setting the time/date format..... 237
  - TIN (Tire Identification Number)**..... 371
  - Tire and Loading Information placard**.... 366
  - Tire characteristics**..... 373
  - Tire inflation compressor**  
see TIREFIT kit
  - Tire information table**..... 366
  - Tire labeling**
    - Characteristics..... 373
    - DOT, Tire Identification Number (TIN).... 371
    - Load index..... 373
    - Load-bearing capacity..... 373
    - Maximum tire load..... 372

- Maximum tire pressure..... 372
- Overview..... 370
- Speed rating..... 373
- Temperature grade..... 370
- Tire Quality Grading..... 370
- Tire size designation..... 373
- Traction grade..... 370
- Tread wear grade..... 370
- Tire load (maximum)**..... 372
- Tire pressure**
  - Checking (manually)..... 362
  - Checking (tire pressure monitoring system)..... 363
  - Maximum..... 372
  - Notes..... 359
  - Restarting the tire pressure loss warning system..... 365
  - Restarting the tire pressure monitoring system..... 364
  - Tire pressure loss warning system (function)..... 365
  - Tire pressure monitoring system (function)..... 362
  - Tire pressure table..... 361
  - TIREFIT kit..... 339
- Tire pressure loss warning system**
  - Function..... 365
  - Restarting..... 365
- Tire pressure monitor**
  - Function..... 362
  - Restarting..... 364
- Tire pressure monitoring system**
  - Checking the tire pressure..... 363
  - Checking the tire temperature..... 363
- Tire pressure table**..... 361
- Tire Quality Grading**..... 370
- Tire temperature**
  - Checking (tire pressure monitoring system)..... 363
  - Tire pressure monitoring system (function)..... 362
- Tire tread**..... 358
- Tire-change tool kit**
  - Overview..... 381
- TIREFIT kit**
  - Storage location..... 339
  - Using..... 339
- Tires**
  - Characteristics..... 373
  - Checking..... 358
  - Checking the tire pressure (manually)... 362
  - Checking the tire pressure (tire pressure monitoring system)..... 363
  - Definitions..... 375
  - DOT, Tire Identification Number (TIN).... 371
  - Flat tire..... 337
  - Installing..... 385
  - Load index..... 373
  - Load-bearing capacity..... 373
  - Maximum tire load..... 372
  - Maximum tire pressure..... 372
  - MOExtended tires..... 338
  - Noise..... 358
  - Notes on installing..... 378
  - Overview of tire labeling..... 370
  - Removing..... 385
  - Replacing..... 378, 382
  - Replacing the wheel trim..... 382
  - Restarting the tire pressure loss warning system..... 365
  - Restarting the tire pressure monitoring system..... 364
  - Rotating..... 381

- Selection..... 378
  - Snow chains..... 359
  - Speed rating..... 373
  - Storing..... 381
  - Temperature grade..... 370
  - Tire and Loading Information placard.... 366
  - Tire pressure (notes)..... 359
  - Tire pressure loss warning system  
(function)..... 365
  - Tire pressure monitoring system  
(function)..... 362
  - Tire pressure table..... 361
  - Tire Quality Grading..... 370
  - Tire size designation..... 373
  - TIREFIT kit..... 339
  - Traction grade..... 370
  - Tread wear grade..... 370
  - Unusual handling characteristics..... 358
- Tool**  
see Vehicle tool kit
- Top Tether**..... 57
- Touch Control**
- On-board computer..... 207
  - Operating..... 227
  - Setting the sensitivity..... 228
- Touchpad**
- Activating/deactivating haptic operation feedback..... 230
  - Operating..... 228
  - Reading the handwriting recognition aloud..... 229
  - Selecting a station and track..... 230
  - Setting the sensitivity..... 229
  - Switching on/off..... 228
- Tow-away alarm**
- Activating/deactivating..... 85
  - Function..... 84
- Tow-bar system**..... 204
- Tow-starting**..... 354
- Towing away**..... 350
- Towing eye**
- Installing..... 353
  - Storage location..... 353
- Towing methods**..... 349
- Track**
- Selecting (audio mode)..... 304
- Traction grade**..... 370
- Traffic information**
- Displaying the traffic map..... 265
  - Displaying traffic incidents..... 266
  - Extending a Live Traffic Information subscription..... 265
  - Issuing hazard warnings..... 267
  - Live Traffic Information..... 265
  - Overview..... 265
- Traffic map**  
see Map
- Traffic Sign Assist**
- Function/notes..... 180
  - Setting..... 181
  - System limits..... 180
- Transferred vehicle data**
- Android Auto..... 289
  - Apple CarPlay®..... 289
- Transmission (problem)**..... 143
- Transmission position display**..... 141
- Transporting**
- Vehicle..... 352
- Tread wear grade**..... 370
- Trim element (Care)**..... 334



**Trunk lid**

- Activating/deactivating the tailgate opening height restriction..... 76
- Closing..... 71
- Emergency release (from inside)..... 75
- HANDS-FREE ACCESS..... 73
- Locking separately..... 75
- Opening..... 70

**TuneIn**

- Logging out..... 300
- Registering..... 300
- Selecting stream..... 300
- Setting options..... 300
- Terms of use..... 300

**TuneIn**

- Calling up..... 298
- Deleting stations..... 299
- Overview..... 299
- Saving stations..... 299
- Selecting and connecting a station..... 299

**Turn signal indicator**..... 113**Turn signal light**

- Activating/deactivating..... 113

**Two-way radios**

- Frequencies..... 390
- Notes on installation..... 389
- Transmission output (maximum)..... 390

**U****Units of measurement**

- Setting..... 241

**Unlocking**

- see Locking/unlocking

**Unlocking setting**..... 64**Updates**

- Important system updates..... 245
- Information..... 244
- Performing..... 245
- Software updates..... 245

**USB devices**

- Connecting..... 303

**USB port**

- Front storage compartment..... 102

**User profile**

- Creating..... 243
- Importing/exporting..... 244

- Options..... 244
- Setting..... 243

**Using the telephone**

- see Calls

**V****Vehicle**

- Activating/deactivating standby mode..... 154
- Collision detection (parking)..... 153
- Correct use..... 27
- Data acquisition..... 29
- Data storage..... 29
- Diagnostics connection..... 26
- Equipment..... 22
- Limited Warranty..... 29
- Locking (automatically)..... 69
- Locking/unlocking (emergency key)..... 69
- Locking/unlocking (from inside)..... 67
- Locking/unlocking (KEYLESS-GO)..... 67
- Lowering..... 386
- Maintenance..... 23
- Medical aids..... 27
- Parking for an extended period..... 154
- Problem notification..... 28

- QR code rescue card..... 29
- Qualified specialist workshop..... 27
- Raising..... 383
- Standby mode function..... 154
- Starting (emergency operation mode)... 130
- Starting (Remote Online)..... 131
- Starting (start/stop button)..... 129
- Switching off (start/stop button)..... 147
- Towing..... 204
- Ventilating (convenience opening)..... 77
- Voice commands (Voice Control System)..... 223
- Vehicle camera**
- Information..... 155
- Vehicle data**
- Displaying (DYNAMIC SELECT)..... 140
- Roof load..... 400
- Transferring to Android Auto..... 289
- Transferring to Apple CarPlay®..... 289
- Turning radius..... 399
- Vehicle height..... 399
- Vehicle length..... 399
- Vehicle width..... 399
- Wheelbase..... 399
- Vehicle data storage**
- Event data recorders..... 33
- Multimedia system/Mercedes me connect..... 33
- Vehicle dimensions**..... 399
- Vehicle identification number**
- see VIN
- Vehicle identification plate**
- Paint code..... 391
- VIN..... 391
- Vehicle interior**
- Cooling or heating (Remote Online)..... 131
- Vehicle location**
- Activating/deactivating transmission.... 237
- Vehicle maintenance**
- see ASSYST PLUS
- Vehicle operation**
- Outside the USA or Canada..... 23
- Vehicle sensors**
- Information..... 155
- Vehicle SmartKey**
- see SmartKey
- Vehicle tool kit**
- TIREFIT kit..... 339
- Towing eye..... 353
- Ventilating**
- Convenience opening..... 77
- Ventilation**
- see Climate control
- Vents**
- see Air vents
- Video mode**
- Activating..... 304
- Activating/deactivating full-screen mode..... 306
- Overview..... 306
- Settings..... 307
- VIN**
- Identification plate..... 391
- Seat..... 391
- Windshield..... 391
- Vision**
- Removing condensation from the windows..... 125

<b>Voice command types (Voice Control System)</b> .....	212
<b>Voice Control System</b>	
Application specific voice commands....	212
Audible help functions.....	213
Global voice commands.....	212
Improving speech quality.....	213
Language setting.....	213
Media player voice commands.....	220
Message voice commands.....	222
Multifunction steering wheel (operating).....	211
Navigation voice commands.....	215
Operable functions.....	212
Operating safety.....	211
Radio voice commands.....	219
Switch voice commands.....	213
Telephone voice controls.....	218
Text message voice commands.....	222
Types of voice commands.....	212
Vehicle voice commands.....	223
Voice prompting.....	212
<b>Voice control system</b>	
see Voice Control System	

## W

### Warning lamp

see Warning/indicator lamp

### Warning system

see ATA (anti-theft alarm system)

### Warning triangle

Removing..... 336

Setting up..... 337

### Warning/indicator lamp

 ABS warning lamp..... 459

 Brake system warning lamp  
(Canada only)..... 457

 Brake warning lamp (USA only).... 457

 Brakes warning lamp (yellow)  
(Canada only)..... 456

 Coolant warning lamp..... 452

 Electric parking brake indicator  
lamp (red) (Canada only)..... 455

 Electric parking brake indicator  
lamp (red) (USA only)..... 455

 Electrical malfunction warning  
lamp..... 454

 Engine diagnosis warning lamp.... 453

 ESP® OFF warning lamp..... 460

 ESP® warning lamp..... 459

 Fuel reserve warning lamp..... 454

 Power steering warning lamp  
(red)..... 451

 RBS Recuperative Brake System  
warning lamp (USA only)..... 456

 Restraint system warning lamp.... 450

 Seat belt warning lamp..... 450

 Suspension warning lamp (yel-  
low)..... 458

 The electric parking brake (yel-  
low) indicator lamp..... 455

 Tire pressure monitoring sys-  
tem warning lamp..... 461

 Warning lamp for distance  
warning function..... 458

- Overview..... 448
- Warning/indicator lamps**
  - PASSENGER AIR BAG..... 47
- Warranty**..... 29
- Washer fluid**
  - see Windshield washer fluid
- Washing by hand (care)**..... 331
- Water tank**
  - see Air-water duct
- Weather information**..... 272
- what3words**
  - Destination entry with a 3 word address..... 254
- Wheel change**
  - Lowering the vehicle..... 386
  - Mounting a new wheel..... 385
  - Removing a wheel..... 385
  - Removing/installing hub caps..... 382
- Wheel rotation**..... 381
- Wheels**
  - Care..... 333
  - Checking..... 358
  - Checking the tire pressure (manually)... 362
  - Checking the tire pressure (tire pressure monitoring system)..... 363
  - Definitions..... 375
  - DOT, Tire Identification Number (TIN).... 371
  - Flat tire..... 337
  - Installing..... 385
  - Load index..... 373
  - Load-bearing capacity..... 373
  - Maximum tire load..... 372
  - Maximum tire pressure..... 372
  - MOExtended tires..... 338
  - Noise..... 358
  - Notes on installing..... 378
  - Overview of tire labeling..... 370
  - Removing..... 385
  - Replacing..... 378, 382
  - Replacing the hub cap..... 382
  - Restarting the tire pressure loss warning system..... 365
  - Restarting the tire pressure monitoring system..... 364
  - Rotating..... 381
  - Selection..... 378
  - Snow chains..... 359
  - Speed rating..... 373
  - Storing..... 381
  - Temperature grade..... 370
  - Tire and Loading Information placard.... 366
  - Tire characteristics..... 373
  - Tire pressure (notes)..... 359
  - Tire pressure loss warning system (function)..... 365
  - Tire pressure monitoring system (function)..... 362
  - Tire pressure table..... 361
  - Tire Quality Grading..... 370
  - Tire size designation..... 373
  - TIREFIT kit..... 339
  - Traction grade..... 370
  - Tread wear grade..... 370
  - Unusual handling characteristics..... 358
- Wi-Fi**
  - Overview..... 238
  - Setting..... 238
  - Setting up a hotspot..... 239
- Widescreen Cockpit Instrument Display**
  - Instrument cluster..... 12
- Window curtain airbag**..... 42

- Window lifter**  
see Side windows
- Windows**  
Care..... 333
- Windows**  
see Side windows
- Windshield**  
Defrosting..... 124  
Replacing the wiper blades..... 119
- Windshield**  
see Windshield
- Windshield washer fluid**  
Notes..... 397
- Windshield washer system**  
Refilling..... 328
- Windshield wipers**  
Activating/deactivating..... 118  
Replacing the wiper blades..... 119
- Winter operation**  
Snow chains..... 359
- Wiper blades**  
Care..... 333  
Replacing..... 119
- Wireless charging**  
Function/notes..... 109  
Mobile phone..... 110
- Wireless vehicle components**  
Declaration of conformity..... 25
- Workshop**  
see Qualified specialist workshop

