

Order-No. DaimlerChrysler 6515 6634 13 Blaupunkt 8 622 402 618 Index C Parts-No. 210 584 45 96 USA Edition A 2002

208/210

Operator's Manual COMAND



Mercedes-Benz



COMAND  
Operator's Manual

As a result of new improvements in equipment and components, some descriptions and illustrations in this operating manual are approximate or may deviate from the features actually included in your COMAND operating unit.

As such, the information, illustrations and descriptions contained in this manual may not be reasonably relied upon in making any claims with respect to the actual performance of the product.

If your COMAND operating unit is equipped with functions which are not described in this operating manual or if you have any questions, please contact any Mercedes-Benz Center for further information.

We recommend that you keep the operating instructions in your vehicle so that you always have them available.

If you sell your vehicle, you should give the operating manual to the new owner.

## How to use the COMAND operating manual

Before you take your first drive, please make yourself familiar with the COMAND operating unit and the functions it supports. Read through these operating instructions carefully and, if necessary, refer to the operating instructions of your vehicle.

The operating instructions are divided into 6 chapters:

- **Introduction:** An overview of the operating and display elements as well as explanation of the basic functions
- **Audio:** Information on the radio and CD equipment (CD drive and CD changer) as well as sound settings
- **Telephone:** Explanation of the telephone functions
- **Navigation:** How to enter your destination, selecting your route, route guidance, how to use the route memory, and selecting a detour.
- **Info Services and system settings:** Information on how to request and display service informations, setting language, date/time, tones and day/night display
- **Index:** Search items to help you find exactly what you are looking for

Explanation of symbols used:

**Warning notices for the protection of yourself and others are preceded by a  symbol.**

## Operation – COMAND and telephone



### Warning!

**In order to avoid distraction which could lead to an accident, system settings should be entered with the vehicle at standstill and system should be operated by the driver only when traffic conditions permit.**

**Bear in mind that at a speed of just 30 mph (approximately 50 km/h), your car is covering a distance of 50 feet (approximately 14 m) every second.**

COMAND supplies you with information to help you select your route more easily and guides you conveniently and safely to your destination. For safety's sake, you should not use some of the functions, such as entering the destination, unless your vehicle is stationary (electronic key in the ignition at position 1).

**The navigation system does not supply any information on stop signs, yield signs, traffic regulations or traffic safety rules. This always remains your personal responsibility when you drive.**

1 Observe all legal requirements.

## Operating safety



### Warning!

**Any alterations made to electronic components and the software can cause malfunctions.**

**The radio, amplifier, CD changer, telephone and Voice recognition system are interconnected. Therefore, when one of the components is defective or has not been removed/replaced properly this may impair the function of other components.**

**These malfunctions might seriously impair the operating safety of your vehicle.**

**We recommend that you have any service work or alternations on electronic components done in an authorized Mercedes-Benz Center.**

## Contents

Introduction .....	1
How to use the COMAND operating manual .....	1
Operation - COMAND and telephone .....	2
Operating safety .....	2
Contents .....	3
Quick reference - COMAND .....	8
Multifunction steering wheel, Multifunction display .....	11
Screen displays .....	12
Switch the COMAND operating unit on and off .....	13
Adjusting the volume .....	15
Selecting beep tones .....	15
Switching the screen on and off .	15
Pop-up screen messages when the battery gets low .....	16
Status window for Tele Aid calls .....	16

## Audio

Contents - Audio .....	17
Radio operation .....	18
Quick reference - Radio .....	18
Menu overview - Radio .....	20
Switching radio operation on .....	22
Changing the Radio Band .....	22
Selecting a station .....	24
Automatic Station Scan .....	28
Memory functions .....	29
Radio playback mute .....	38
Multifunction steering wheel, Multifunction display .....	39
CD operation .....	40
Quick reference for CD drive in the control unit and CD changer operation .....	40
General information on CD playback .....	42
CD playback .....	43

Loading a CD into the CD drive .....	44
Loading CDs in the CD changer .....	45
Menu overview - CD operation ..	48
Switching on CD operation (CD drive, CD changer) .....	50
Track select .....	51
Selecting CD's .....	53
Fast forward / fast backward .....	55
CD track scan .....	56
Entering, altering and deleting CD names .....	57
Selecting playback mode .....	60
CD playback mute .....	62
Error messages .....	63
Tips on caring for your CD's .....	65
Multifunction steering wheel, Multifunction display .....	68
Sound settings .....	69
Adjust sound settings .....	69

**Telephone**

Contents - Telephone .....	77
Notes .....	78
Before you use the telephone .....	78
Multifunction steering wheel, Multifunction display .....	80
Overview of the Multifunction displays .....	81
Quick reference - Telephone .....	82
Menu overview - Telephone .....	84
Switching telephone operation on .....	86
Incoming calls .....	88
Outgoing calls .....	92
Dialing a telephone number .....	92
Dialing a number from the phone book .....	95

Redial .....	102
Dialing from calls list .....	106
Speed-dialing (only with COMAND) .....	107
Quick-dialing (for the first 10 memory locations) .....	109
Notebook .....	110
Editing the phone book .....	111
SMS function .....	118
Emergency call (9-1-1) .....	122
Service numbers .....	125

**Navigation**

Contents - Navigation .....	128
Notes .....	130
Before you use the navigation system .....	130
Navigation .....	132
Quick reference - Navigation ....	132
Switching the navigation system on .....	135
Changing the Navigation CD .....	137
Destination entry .....	138
Menu overview - Destination entry .....	138
Entering destination address ....	140
Continue destination input .....	148
Selecting a destination via the map .....	151
Entering points of interest .....	155
Selecting the last destinations ..	160
Selecting the route calculation mode and calculating the route ...	161

Route guidance .....	164	Resetting functions during route guidance .....	191	Sorting the destination memory .....	201
The principle of route guidance .....	164	Deviating from the calculated route .....	192	Deleting a destination in the destination memory .....	202
Requesting destination and route information .....	167	Reaching your destination .....	192	Entering the vehicle position ....	203
Beginning route guidance .....	174	Activating audio system .....	193	Calibration .....	204
Turning onto a street .....	176	Activating audio functions during route guidance .....	194		
Following the course of the road .....	178	Cancelling route guidance .....	195		
Driving through an intersection .....	179	Destination memory .....	196		
Changing to map display during route guidance .....	180	Activating the main destination memory menu .....	196		
Route guidance with a mixture of map and symbol display .....	181	Retrieving a destination from the destination memory .....	197		
Altering the map scale .....	182	Saving the current destination in the destination memory .....	198		
Selecting map orientation .....	183	Saving the current vehicle location in the destination memory .....	200		
Marking a way point .....	184				
Selecting a detour during route guidance .....	187				

## **Info Services and system settings**

Contents - Info Services and system settings .....	207
Info Services .....	208
Requesting and displaying Info Services .....	208
System settings .....	211
Activating the main system settings menu .....	211
Adjusting the brightness .....	212

## Contents

Activating Settings menu .....	213
Selecting the language .....	214
Set the date and time .....	215
Switching beep tones on and off .....	222

## 6

Setting changeover between day and night display .....	223
Reset all settings to the factory settings .....	224
Auxiliary audio source .....	225

## Index

Index .....	227
-------------	-----



## Quick reference – COMAND



- 1 Switching the COMAND on/off, page 13
- 2 Switching the navigation system on/off, Quick reference, page 132
- 3 Switching the CD operation on, Quick reference, page 40
- 4 Switching radio operation on, Quick reference, page 18  
Changing the radio band, page 23
- 5 CD drive, inserting an audio or a navigation CD, page 44
- 6 Switching telephone operation on, Quick reference, page 82
- 7 Ejecting an audio or a navigation CD
- 8 Radio:  
Station selection via number keypad (presets), page 26  
Station selection via direct frequency entry, page 27  
  
CD operation:  
Selecting tracks, page 51  
Selecting CD's, page 53

Telephone:

- Entering the unlock code, page 86
- Entering a telephone number, page 92

Navigation (Destination input):

- Moving the cross hairs according to the corresponding arrows, page 152

- 9 Subsequent dialing, page 94
- 10 Subsequent dialing, page 94
- 11 The last digit or the whole number will be deleted, page 92  
Deleting list entries (e.g. CD name), page 59  
Altering or deleting entries, page 57
- 12 Return to the previous menu  
Ending a call, page 99
- 13 **Turn** to highlight a menu field, list entry or a symbol  
**Press** to activate a submenu, confirm an entry/selection or start a function
- 14 **Turn** to adjust the volume of the audio source, set the volume for the hands-free operation of the telephone or altering the voice output during route guidance  
**Press** to repeat the current route instruction

## Introduction

## 10

- 15** Radio:  
Automatic seek tuning backwards, page 24  
Manual tuning backwards, page 25  
CD operation:  
previous track, page 51  
fast backward, page 55
- 16** Radio:  
Automatic seek tuning forwards, page 24  
Manual tuning forwards, page 25  
CD operation:  
previous next track, page 51  
fast forward, page 55
- 17** Audio:  
Press to mute audio source, press again to cancel mute function  
Navigation (voice output):  
Press to mute current spoken recommendation,  
Press longer than 2 seconds to mute the voice output for the duration of route guidance, page 175
- 18** Press to call up in succession: night display - switched off screen - day display
- 19** Requesting destination and route information, page 167  
Display an entry in a window in full, page 156
- 20** Requesting and displaying Info Services, page 208  
Adjust system settings (brightness, language, clock, day/night-display), page 211
- 21** Route guidance (navigation) active:  
Switches between map and symbol display, page 180  
Route guidance not active:  
Activating the location map, page 167
- 22** Activating the main detour menu  
Selecting a detour during route guidance, page 187
- 23** Press to activate the map scale bar,  
Press again to increase the map scale,  
pages 152 and 182
- 24** Press to activate the map scale bar,  
Press again to reduce the map scale,  
pages 152 and 182
- 25** Color screen

## Multifunction steering wheel, Multifunction display



- 1 Multifunction display
- 2 Multifunction steering wheel

Turn the electronic key in the steering lock to position 1 or 2. See your vehicle's operating instructions.

The steering wheel buttons enable activation and operation of radio, CD and external audio source (e.g. portable tape deck), the telephone, navigation and Tele Aid. Information such as the radio frequency is shown in the multifunction display.

For more detailed information, refer to “Multifunction steering wheel, multifunction display” in the chapters on the radio, CD, telephone and navigation systems.

Press key:

3  Next system

4  Previous system

Systems which can be activated refer to vehicle operating instructions

5  Next display in the system

6  Previous display in the system

7  Raising the volume

8  Lowering the volume

9  Accept incoming telephone call, page 88  
Starts dialing after the selection of a number, page 96, 103

10  End telephone call, End Tele Aid info or Roadside call, page 88  
refuse telephone call, page 88

## Screen displays

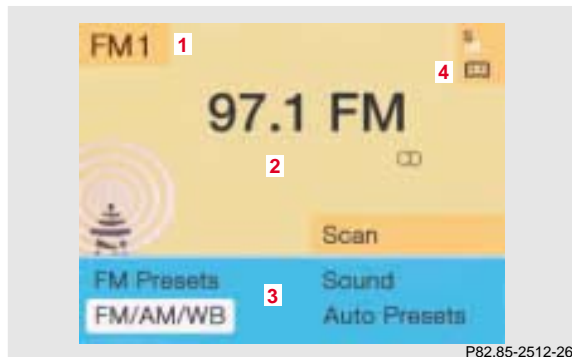

Screen displays include:

- Main menus, the radio main menu in the example above
- Lists, e.g. CD names list, page 59
- Input menus, e.g. entering, changing and deleting CD names, page 57
- Selection menus, e.g. selecting playback mode, page 60
- Symbol and map displays in navigation
- Pop-up windows, page 156

Structure of, e.g. a radio main menu:

- 1 Information/status line  
Display of the system switched on (FM) and additional information, e.g. 1 (memory location 1) or menu name, e.g. FM Memory

Other system displays:

- AM - AM radio band
- WB - Weather band
- CD - CD operation
- TEL - Telephone
- NAVI - Navigation
- SVC - Info Services and system settings
- AUX - External audio source

- 2 Station frequency, activated functions
- 3 Menu fields which branch off to submenus
- 4 Symbol bar  
Reception strength of the mobile phone

Note:

The symbol bar appears in all system main menus as well as in the symbol and map displays in navigation.

## Switch the COMAND operating unit on and off



### Switch on

Press **PWR**.

The COMAND operating unit is switched on. The graphic characters Mercedes-Benz, and the Mercedes star will be displayed.



The display changes, and an alert box will appear.

COMAND switches on with the system which was last active and displays the corresponding menu.

## Introduction

Press the button marked for the equipment you would like to switch on (e.g. **FM/AM**).

Note:

If the navigation system was the last system used, there are three different screens which may appear, depending on the last status.

## 14

Route guidance was active:

- the symbol display
- the map

Destination entry was active:

- the main destination input menu.

**Switch off**

Press **PWR**.

The COMAND operating unit will switch off.

## Adjusting the volume

Using buttons on the multifunction steering wheel:

Raising the volume – press steering wheel button **+**

Lowering the volume – press steering wheel button **-**

On the COMAND operating unit:

Raising the volume – turn left-hand rotary/push-button **⬆** to the right

Lowering the volume – turn left-hand rotary/push-button **⬇** to the left

Audio functions for radio and CD operation (CD drive and CD changer):

The volume selected applies to all of the audio functions.

For other audio sources:

Other audio sources are telephone, voice output during route guidance and Voice Recognition System. Refer to separate operating instructions for telephone and voice recognition system. The volume level for voice output in navigation and voice recognition system is the same (altering either affects the other). Telephone volume is adjusted separately.

Altering the listening volume for the telephone affects only the telephone and not navigation or voice recognition system.

## Selecting beep tones

To indicate operating steps or error messages acoustically, it is possible to select different beep tones. Beep tones may be switched on and off, page 222.

Acknowledgement beep:

is heard when an entry is accepted

Info beep:

is heard when window displays warn that the battery power is decreasing, page 16.

Alarm beep:

is heard on a serious malfunction (e.g. if the tape cover sticks). This warning can only be switched off by switching the COMAND off.

## Day/Night display, switch off screen

You can change over between day display, night display and screen switched off by repeatedly pressing **DISP**. Press **DISP** once again to switch on the screen again.

It is also possible to automatically change over between day display and night display by means of the headlights switch, page 223.

### Pop-up screen messages when the battery gets low

To prevent the car battery from running down, the driver will receive two messages to start the engine when battery power gets low. This warning will appear in all of the displays.

It is possible to switch off the warning “Caution. Please turn on ignition. Otherwise system will shut down in 3 minutes” by pressing the right-hand rotary/pushbutton . Please, start the engine, refer to the operating instructions of the vehicle.

You can then still operate COMAND.

The next two messages will not disappear until the engine has been started or COMAND has been switched off. It is not possible to operate COMAND while they are on the screen.

First the following warning will appear on the screen: “Caution. Please turn on ignition. Otherwise system will shut down in 10 seconds”. Please, start the engine.

If the engine is not started, COMAND will switch off after 10 seconds. The following message will appear in the display: “Caution. The system will shut down.”. Please, start the engine.

### Status window for Tele Aid calls

When the Tele Aid call system is in operation (refer to operating instructions of the vehicle) a pop-up window appears indicating the type of call and status.

During transmission of a Tele Aid call the audio source will be muted until the Tele Aid call is ended.

The window can be cleared by manually by turning or pressing the right-hand rotary/pushbutton . It will switch off automatically when the emergency call is completed.

## Audio

Radio operation .....	18	General information on CD		Selecting playback mode .....	60
Quick reference - Radio .....	18	playback .....	42	CD playback mute .....	62
Menu overview - Radio .....	20	CD playback .....	43	Error messages .....	63
Switching radio operation on .....	22	Loading a CD into the		Tips on caring for your CD's.....	65
Changing the Radio Band .....	22	CD drive .....	44	Multifunction steering wheel,	
Selecting a station .....	24	Loading CDs in the		Multifunction display .....	68
Automatic Station Scan .....	28	CD changer .....	45	Sound settings .....	69
Memory functions .....	29	Menu overview - CD operation ..	48	Adjust sound settings .....	69
Radio playback mute .....	38	Switching on CD operation			
Multifunction steering wheel,		(CD drive, CD changer) .....	50		
Multifunction display .....	39	Track select .....	51		
CD operation .....	40	Selecting CD's .....	53		
Quick reference for CD drive		Fast forward / fast backward .....	55		
in the control unit and		CD track scan .....	56		
CD changer operation .....	40	Entering, altering and			
		deleting CD names .....	57		

## Quick reference – Radio





- 1 Switching the COMAND on/off, page 13
- 2 Switching radio operation on, page 22
- 3 Station selection via number keypad (presets), page 26  
 Station selection via direct frequency entry, page 27  
 Saving stations, page 29  
 Selecting stations from the preset menu FM/AM, page 35  
 Selecting channels from the WB preset menu, page 36
- 4 Activating the input mode for station frequencies:  
 in the main radio menu, page 27  
 in the presets, page 37
- 5 Deleting stations from the presets FM/AM, page 35
- 6 Return to previous menu
- 7 **Turn** to highlight a function or menu field,  
**Press** to perform a function or access a submenu
- 8 Turn to the right – raising the volume  
 Turn to the left – lowering the volume
- 9 Automatic seek tuning backwards, page 24  
 Manual tuning backwards, page 25
- 10 Automatic seek tuning forwards, page 24  
 Manual tuning forwards, page 25
- 11 Press to mute radio audio,  
 press again to cancel the mute function, page 38
- 12 Requesting and displaying Info Services, page 208  
 Adjust system settings (brightness, language, clock, day/night-display), page 211
- 13 Color screen with main radio menu

Radio operation

20

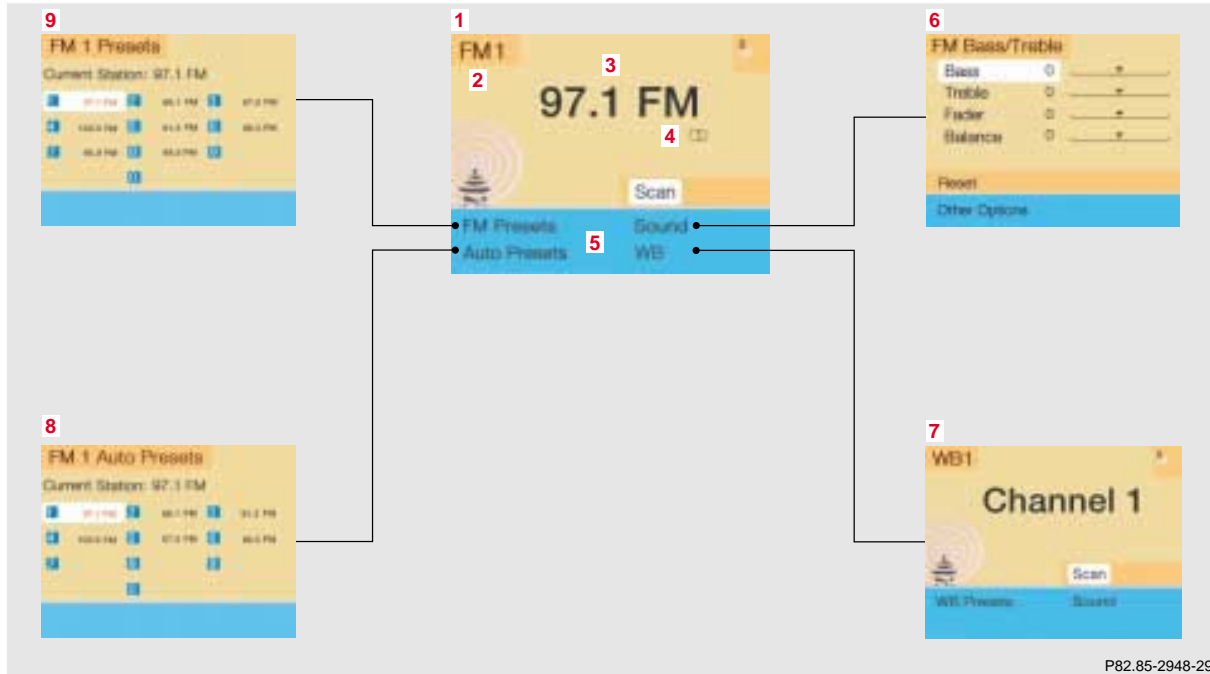
Menu overview – Radio



- 1 Main radio menu FM
- 2 Current band (FM) and memory preset selected (1) are displayed
- 3 Current frequency
- 4  symbol indicates stereo reception
- 5 Menu fields to activate submenus
- 6 Main sound settings menu, Adjust sound settings, page 69
- 7 Auto preset  
Save stations automatically, FM/AM, page 32  
Select a station, page 33
- 8 Main radio menu AM, page 23  
Activate Weather band (WB), page 23
- 9 Preset menu  
Save stations manually FM, page 29  
Save stations manually AM, page 31  
Select a station, page 35

## Radio operation

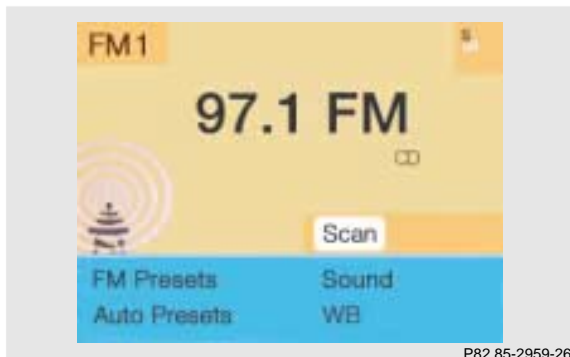
**Switching radio operation on and off**

P82.85-2959-26

**Switching on the radio**

Press **FM/AM**. The radio will switch on.

The station last tuned to will begin to play. On FM and AM frequency will appear in the display.

You can operate the telephone and navigation system while the radio is on.

## 22

**Switching off the radio**

Press **FM/AM** while the main radio menu is on the screen.

The following message will appear: "Radio off".

To switch to another system, press the corresponding button.

## Changing the Radio Band



You can select the FM-, AM- and WB-band one after the other by repeatedly pressing the right-hand rotary/pushbutton  while "FM/AM/WB" is highlighted.

Press the right-hand rotary/pushbutton  to confirm the marked menu field "FM/AM/WB".

The station last tuned to will begin to play. The frequency will appear in the display.

Frequency ranges:

- FM 87.9 – 107.9 FM
- AM 530 – 1710 AM

Radio operation

## Weather Band (WB)



Highlight the "FM/AM/WB" menu field and press the right-hand rotary/pushbutton  repeatedly until "WB" is displayed in the upper left hand corner of the display.

The channel last tuned to will appear in the display.

If a weather band station cannot be received on this channel an automatic search run of all 7 channels will take place. As soon as a weather band station is received, the search run stops and the channel appears in the display. Two cycles through the 7 channels will be made.

If a weather band station cannot be received on any of the 7 channels the screen message "No WB" appears.

23

## Radio operation

24

**Selecting a station**

Different functions are available for selecting a station:

- Automatic seek tuning, page 24
- “Seek” tuning at the multifunction steering wheel, page 25
- Manual tuning, page 25
- Station selection via number keypad (presets), page 26
- Station selection via direct frequency entry, page 27
- Automatic Station Scan, page 28
- Station selection from the preset menu, page 35

**Automatic seek tuning**

Press **◀** or **▶** briefly.

FM- and AM-Bands:

The next receivable station in the direction of seek (descending/ascending) will be tuned in and begin to play. The station frequency will appear on the screen.

Weather Band (WB):

The next receivable station will be selected. Alternatively press a number key **1** through **7** and that station will be directly selected.

### “Seek” tuning at multifunction steering wheel

With station frequency displayed in the multifunction display:

Select next higher frequency preset – press 



Select next lower frequency preset – switch 

Note:

The up/down arrows have different functions depending on which made the seek function in the multifunction display is programmed to. The two available options are Memory Scan or Frequency Scan. Refer to the vehicle operator’s manual on how to program this option.

### Manual tuning (FM, AM)



Press  or  longer than 2 seconds. The menu fields will appear in light grey lettering.

FM band:

The frequency displayed will change in the corresponding direction in increments of 0.2 MHz.

AM band (activate via “FM/AM/WB” menu field):

Tuning will take place in increments of 10 kHz.

## Radio operation

## Station selection via number keypad (presets)



Press one of the number keys, such as **2** briefly.

The radio will tune to the frequency assigned to that memory location. If none has been set by the user, a default frequency will appear.

## 26

Note that FM and AM presets are independent and can only be accessed while in the corresponding band.

For WB, tune the radio to the selected channel. The memory preset number will appear in the status line.

Saving stations (FM, AM), page 29 through 33.

The “XX Presets” (XX = FM, AM or WB) menu field provides an overview of which stations have been allocated to which memory presets, page 30.

## Station selection via direct frequency entry



It is possible to set a station by entering the station frequency directly via the number keypad.

Press **\*** (bottom left on the keypad). An input line will appear in the main radio menu.

Use the number keys to enter the desired frequency, e.g. **1 0 2 7** for 102.7 FM (FM waveband).

The display in the main radio menu will now indicate the new frequency. The station will begin to play.

Notes:

Frequencies can be entered only for FM and AM. If no entry is completed within 8 seconds, the station last tuned will resume play.

Enter in given frequency range.

Frequency ranges:

- FM 87.9 – 107.9 FM
- AM 530 – 1710 AM

If you enter a frequency that is outside the allowable input range, you will see the display “Invalid input”. Repeat entry with new frequency.

## Radio operation

**Automatic Station Scan**

The stations on same band (FM/AM/WB) can be scanned one after the other for 8 seconds each.

Once the “Scan” menu field has been selected, press the right-hand rotary/pushbutton  to confirm it.

The scan function will begin, “Scan” will appear in red lettering.

## 28

To play a station (end scan function):

If the station you want is being played, press the right-hand rotary/pushbutton  again.

The station selected will appear on the screen with the frequency. “Scan” will appear in black lettering again.

**Scanning Weather Band (WB)**

With the scan function the individual weather stations stored in the memory on 7 channels can be scanned one after the other for 8 seconds each.

The scan function stops automatically when the first station received has been scanned twice.

## Memory functions

The following functions are available:

- Saving stations manually, FM, page 29  
Saving stations manually, AM, page 31
- Saving stations automatically, FM/AM, page 32
- Selecting stations from the preset menu, FM/AM, page 35
- Selecting channels from the WB preset menu, page 36
- Selecting stations by entering the station frequency in the presets, FM/AM, page 37

Note:

There are 2 memories for each of the FM and AM waveband, standard FM/AM presets and the Auto presets.

The standard FM/AM presets are not affected by the automatic presets. This is a second possibility for storing a station range you are currently receiving.

## Saving stations manually, FM



In the main radio menu:

Press the corresponding number key, e.g. **3**, longer than 2 seconds. You will hear a confirmation beep if this was switched on before, page 15.

The currently displayed station will be saved in the memory corresponding to for that number key. There are 10 memory presets available. The memory preset selected (0 to 9) will appear in the status line.

Note:

An existing entry is overwritten in the memory list when a new input is given.

## Radio operation

30



- 1 Preset of the station currently selected
- 2 Frequency of the station currently selected
- 3 Current frequency appears in red lettering, cursor highlights memory preset no. 1
- 4 Memory preset allocated
- 5 Memory preset available

On the memory list:

Use the right-hand rotary/pushbutton  to highlight the “FM Presets” menu field in the main radio menu and confirm it. The FM preset memory menu will appear on the screen.

Use the right-hand rotary/pushbutton  to move the cursor to the desired memory location.

Press the right-hand rotary/pushbutton  or corresponding number key for longer than 2 seconds.

The main radio menu will appear, with the new memory preset number, automatically after 3 seconds or after you press the key **BACK**.

Note:

The standard FM presets are not affected by the automatic presets. This is a second possibility for storing a station range you are currently receiving.

## Saving stations manually, AM



Use the “FM/AM/WB” menu field in the main radio menu to activate the AM band.

Use the “AM Presets” menu field to activate the corresponding memory.



Save a station in the same way as described for the FM band, page 29.

Note:

The standard AM presets are not affected by the automatic ones. This is a second possibility for storing a station range you are currently receiving.

## Radio operation

## Saving stations automatically, FM/AM



Use the “FM/AM/WB” menu field in the main radio menu to activate the desired band.

## 32

Use the right-hand rotary/pushbutton  to highlight the “Auto Presets” menu field and press the knob longer than 2 seconds.

While the station is being saved “Searching...” will appear on the screen.



The 10 strongest stations will be searched and stored. The station frequencies available will appear in the memory list.

Select other stations:

Use the right-hand rotary/pushbutton  to highlight the memory position and press to confirm.

The main radio menu will appear, for the frequency selected, automatically after 3 seconds or after you press the key **BACK**.

## Radio operation

## Weather band



Use the “WB Presets” menu field in the WB main menu (page 23) to activate the WB Presets.

## 34

Use the right-hand rotary/pushbutton  to highlight the “WB Presets” menu field and press the knob to confirm. This will activate the memory.

Channels 1 to 7 are listed in the memory.

The memory positions of the channels for weather band are fixed and cannot be altered.

## Selecting stations from the preset menu, FM/AM



In both cases, the main radio menu will then appear automatically after 3 seconds, indicating the memory preset number.

Use one of the following two ways to select a station from the FM/AM presets:

- Press the corresponding number key (e.g. **3**) to select the desired station.
- Use the right-hand rotary/pushbutton **0** to highlight a memory preset in the preset list (FM/AM) and press briefly to confirm.

## Radio operation

## Selecting channels from the WB preset menu



Use the “WB Presets” menu field in the WB main menu (page 23) to activate the WB Presets.

## 36

Press the corresponding number key (e.g. **3**) or use the right-hand rotary/pushbutton  to select the desired channel and press briefly to confirm. The station on this channel will be received.

The main WB menu will then appear automatically after 3 seconds, indicating the memory preset number.

## Selecting stations by entering the station frequency in the presets, FM/AM



The station frequency can be entered in FM and AM bands in the corresponding presets list.

To activate the input mode:

Press **\*.**

An input line will appear on the top line in place of the current station name.

Enter the frequency with the number keys.

The frequency is entered into the input line beginning from the right. After 3 seconds at the most, the station selected will begin to play.

Notes:

Enter in given frequency range.

Frequency ranges:

- FM 87.9 – 107.9 FM
- AM 530 – 1710 AM

If you enter a frequency which is not within the given range, the following message will appear: “Invalid input”.

Repeat enter with new frequency.

## Radio operation

**Radio playback mute**

Press **MUT** while listening to the radio.

The radio will be muted and the symbol  will appear on the icon bar.



## 38

Cancel radio mute:

Press **MUT** again.

The symbol will disappear from the icon bar and the station last tuned to will begin to play.

Note:

The mute function will also be cancelled if you switch to a different audio source, e.g. CD, use  or  to select another radio station or turn the left-hand rotary/pushbutton  to alter the volume.

## Multifunction steering wheel, Multifunction display

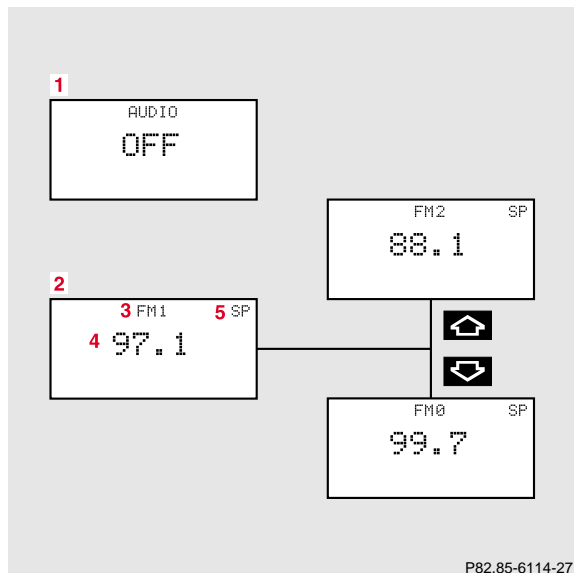

- 1 No audio function has been switched on.
- 2 The radio is switched on.
- 3 Frequency selected as well as the memory preset, if applicable.
- 4 Frequency of the station selected
- 5 Appears only if “Memory” has been selected instead of “Frequency” in the “Individual settings” menu in the instrument cluster.  
See your vehicle’s operating instructions of the instrument cluster.

Press **FM/AM** on the COMAND and switch the radio on.

Press **Menu** repeatedly, as necessary, until display (2) appears.

Press **Up** or **Down** until the desired station name or frequency appears.

**Up** or **Down** can also be used to select a station frequency which has been saved. This depends on the setting selected in the “Individual settings” menu. See your vehicle’s operating instructions of the instrument cluster.

Press **Next** to display the next system.

## Quick reference for CD drive in the control unit and CD changer operation

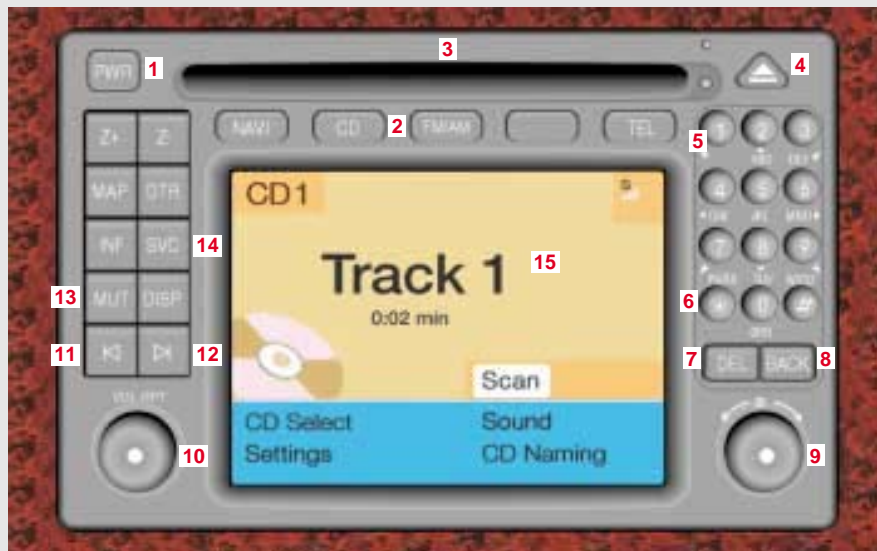

- 1 Switching the COMAND on/off, page 13
- 2 Switching on CD operation (CD drive in the control unit, CD changer), page 50
- 3 CD drive:
  - Inserting an audio CD, page 44
  - Inserting a navigation CD, page 44
- 4 Ejecting an audio CD, page 44
  - Ejecting a navigation CD, page 44
- 5 Selecting tracks, page 51
  - Selecting CD's, page 53
- 6 Starting and ending the input mode for track selection, page 52
- 7 Press **DEL** briefly:
  - Deleting the character entered last, page 57
  - Press **DEL** for longer than 2 seconds:
    - Deleting a complete name, page 57
- 8 Return to previous menu
- 9 **Turn** to highlight a function or a menu field,  
**Press** to perform a function or activate a sub-menu
- 10 Turn to the right – raising the volume  
Turn to the left – lowering the volume
- 11 Press **◀** briefly:
  - previous track, page 51
  - Press **◀** for longer than 2 seconds:
    - fast backward, page 55
- 12 Press **▶** briefly:
  - next track, page 51
  - Press **▶** for longer than 2 seconds:
    - fast forward, page 55
- 13 Press to mute CD audio, press again to cancel mute function, page 62
- 14 Requesting and displaying Info Services, page 208
  - Adjust system settings (brightness, language, clock, day/night-display), page 211
- 15 Color screen with main CD menu

### General information on CD playback



#### Warning!

The CD changer is a Class 1 laser product. There is a danger of invisible laser radiation if the cover is opened or damaged.

Do not remove the cover. The CD changer does not contain any parts which can be serviced by the user. For safety reasons, have any service work performed only by qualified personnel.

#### Notes:

An 8-cm CD adapter may cause damage to the CD changer and should not be used.



Use only CDs which bear the label shown above. Load the CD changer with 12-cm CDs only, do not use 8-cm CDs.

## CD playback

Both the CD drive in the COMAND operating unit and the CD changer with its magazine can be used to play CDs.

In addition to audio CDs, the CD drive can also read in the data on the navigation CD.

A total of 7 CDs can be loaded into the system (CD drive and 6 slots in the magazine of the CD changer).

Loading a CD into the CD drive, page 44.

Loading CDs in the CD changer, page 45.

The status line (page 49) indicates which component is being used for CD playback.

## CD operation

## Loading a CD into the CD drive

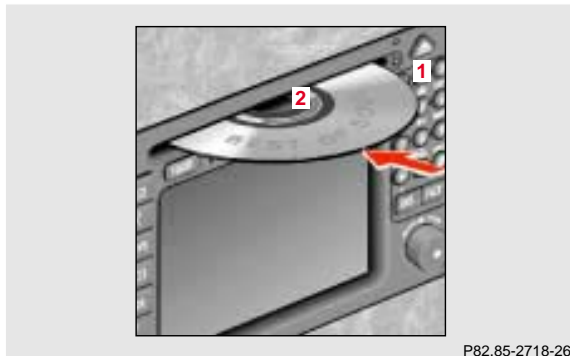

P82.85-2718-26

- 1 Eject button
- 2 CD slot

Press (1) to eject an CD if necessary.

## 44

Insert a CD as illustrated with the label facing up into the CD drive (2) until it is automatically pulled in.

Notes:

Refer to page 65 for information on how to handle CDs.

Changing the navigation CD, page 137.

**Important!**

**After changing a navigation CD the menu (page 137) can appear. The program stored on the navigation CD is loaded.**

**Do not interrupt the loading process. Do not insert an audio CD until the loading process has been completed.**

## Loading CDs in the CD changer

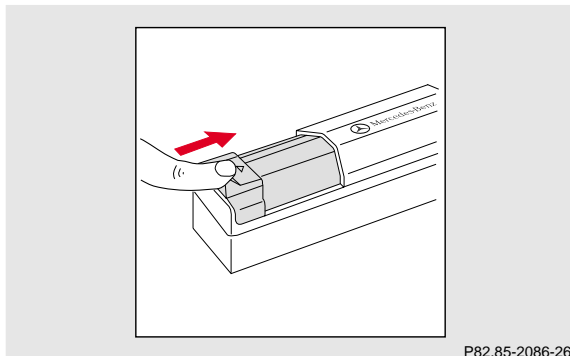

The CD changer is in the trunk. It can accommodate up to 6 CDs.

Open the sliding door by pushing in the direction of the arrow indicated above. Push the door completely open until it locks in the open position.

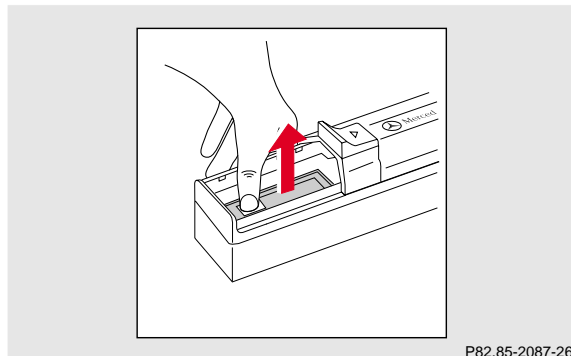

Press the green eject button. The magazine will slide upwards.

Note:

The magazine can be ejected even if COMAND is switched off. However, the eject button will not function if the battery is not connected or drained.

## CD operation

46

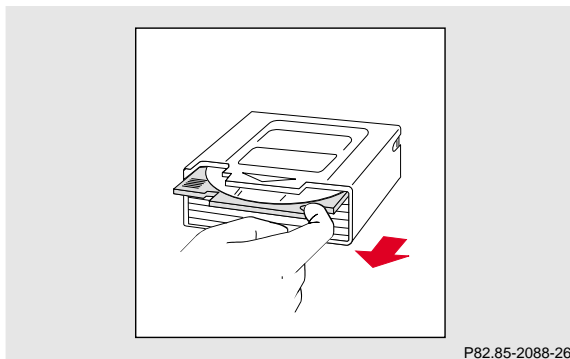

Pull the disk tray forward until it stops.

Note:

Do not attempt to remove the tray from the magazine.

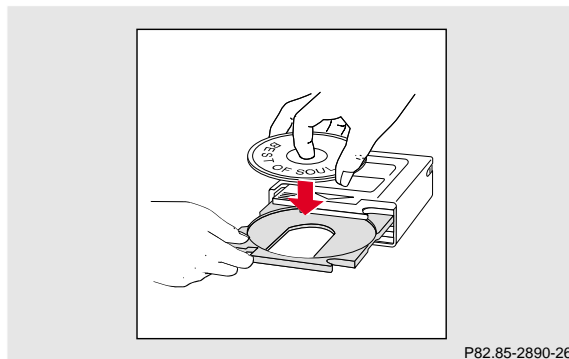

Place a CD in the tray. The CD should be inserted with the label side up.

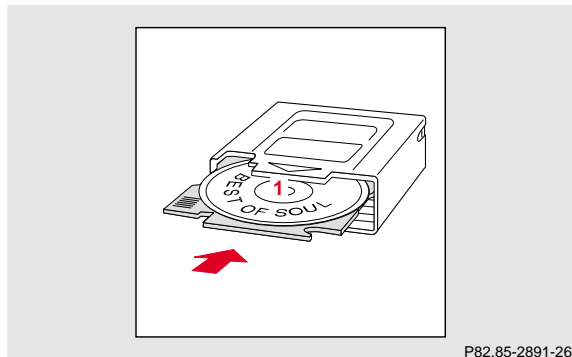

Push the CD magazine into the magazine completely.

- 1 Arrow tip on the rack wall

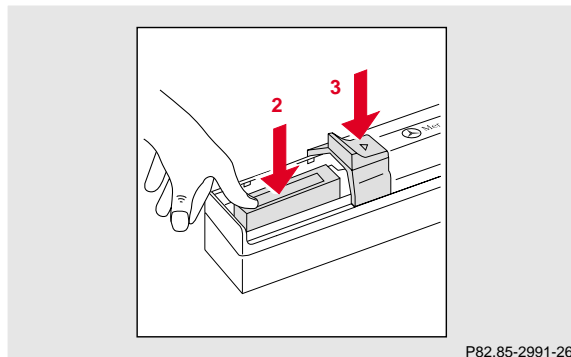

Slide the magazine into the CD changer until it clicks into place (listen for the click). Close the sliding door (3) by pressing gently down on the door release button. Spring pressure gently closes the door.

Note:

Make sure that the tip of the arrow on the side of the magazine (1) is pointing in the direction of the arrow (2).

Do not force the magazine into the changer. If the magazine does not enter smoothly, please, check for proper orientation of the magazine.

## Menu overview - CD operation

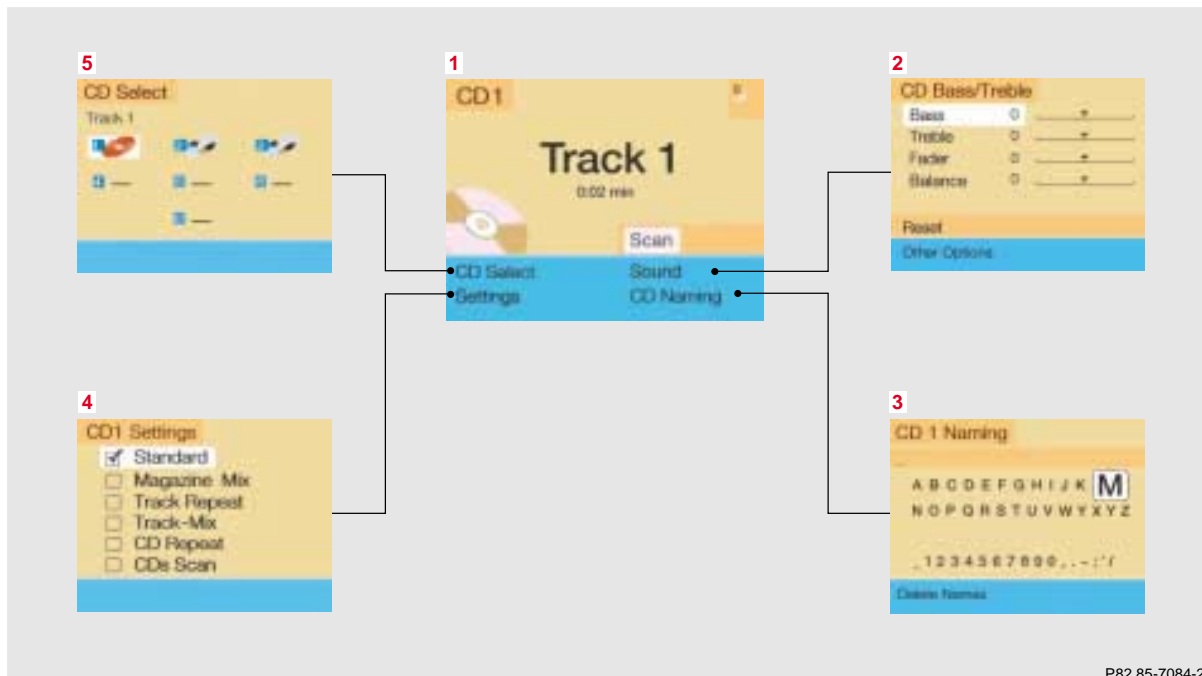

- 1 Main CD menu
  - 2 Status line
    - CD 0: the CD drive is in operation
    - CD 1-6: the CD changer is in operation

The numbers 1-6 stand for the selected CD magazine slot containing a playable audio CD.
  - 3 Main sound settings menu,  
Adjust sound settings, page 69
  - 4 CD Naming menu,  
Entering, altering and deleting CD names,  
page 57
  - 5 Settings menu,  
Selecting playback mode, page 60
- Note:
- The “Magazine Mix”, “CDs Scan” and “CD Repeat” functions are not available for the CD drive.
- 6 CD select menu,  
Selecting tracks, page 51  
Selecting CD's, page 53

## CD operation

50

## Switching on CD operation

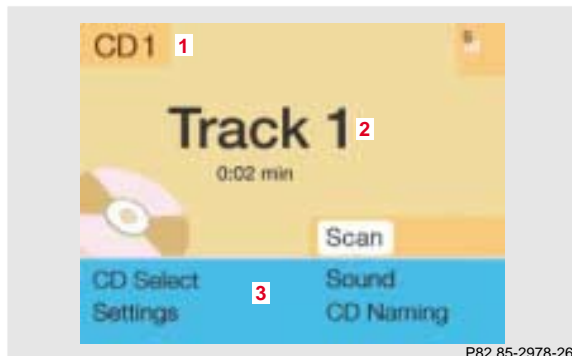

- 1 CD function with the number of the magazine slot currently playing:  
CD changer: CD 1-6
- 2 Track number and elapsed playback time, the name of the CD may appear above this information if the playing CD has been previously named by the user
- 3 Scan function and menu fields to activate menus

Press **CD**.

The main CD menu will appear on the screen.

When you switch to CD operation, the COMAND system will check which component was used last (CD drive or CD changer) and whether or not there are any CDs inserted.

If there is no CD in the component last used, the system will automatically switch to the other component.

CD drive - playback will begin with the first track on the CD

CD changer - playback will begin with the first track on the first CD detected in the magazine

If the CD changer was used last, the following message will appear: "CD loading" when the magazine is changed.

Error messages, page 63.

## Track select

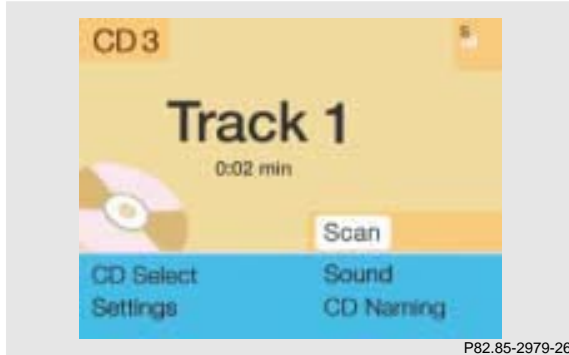

There are 3 different ways in which you can select CD tracks for CD changer.

Select a track by pressing **◀** / **▶**:

Press **▶** briefly: next track

Press **◀** briefly: previous track (if less than 9 seconds of playing time has elapsed), beginning of the current track (if more than 9 seconds of playing time has elapsed).

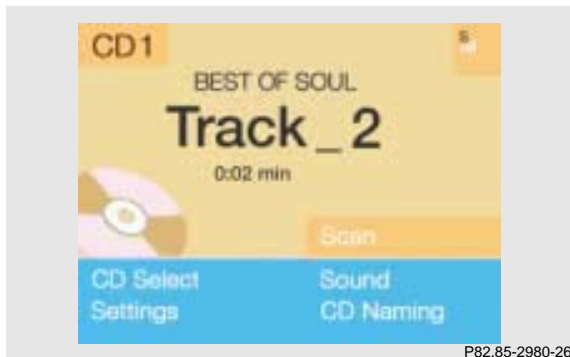

Select a track using the number keypad:

Press **\*** and enter the number of the track you wish to select, e.g. **2**. The selected track will then begin to play automatically after 3 seconds or immediately after you press **\***.

Note:

If you enter a two-digit number, you must enter the second number within 3 seconds. Otherwise, the function will switch off and the screen will return to the previous display.

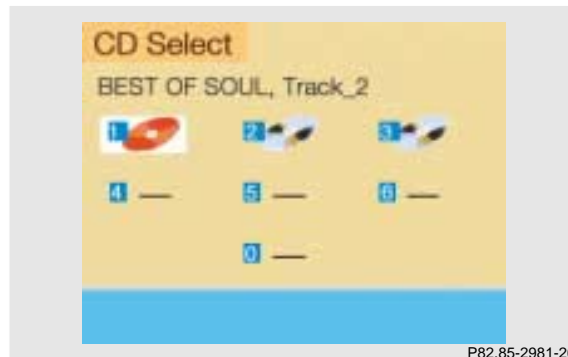

Select a track in the “CD Select” menu:

Activate the menu with the “CD Select” menu field.

Press **\*** and the number key for the track you wish to select, e.g. **2**.

The chosen track will be played automatically after 3 seconds or immediately after you press **\***.

## Selecting CD's

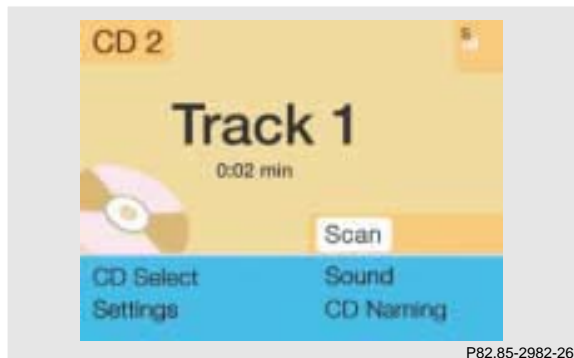

P82.85-2982-26

Selecting a CD with a number key:

Press a number key, e.g. **2** to select the corresponding CD. The following message will appear on the screen: "CD loading". Playback will begin with track 1.

Number key **0**: CD drive

Number keys **1** - **6**: Magazine slots in the CD changer

Messages: "CD drive: No CD" or "CD changer: No CD":

There are no audio CDs in the CD drive or in a magazine slot in the CD changer.

If it is not possible to play a CD selected from the CD drive (message: "Error"), the COMAND system will automatically load the next CD in the magazine.

Other error messages, page 63.

## CD operation

54

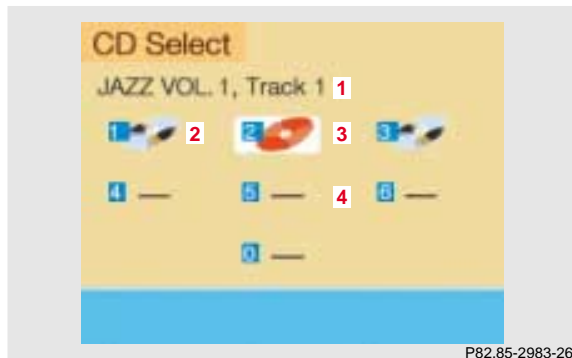

- 1 Current track and the name of the CD playing if this was entered previously, page 57
- 2 Selected CD, current CD in red color
- 3 Magazine slot contains a CD  
Position 0: CD drive  
Position 1-6: magazine slots in the CD changer
- 4 Magazine slot does not contain a CD

Selecting a CD in the “CD select” menu:

Use the right-hand rotary/pushbutton  to highlight the “CD Select” menu field in the main CD menu and confirm your selection by pressing.

Use the right-hand rotary/pushbutton  to highlight the desired CD in the menu and confirm your selection by pressing. “CD loading ...” will appear middle above the selection places on the screen. Playback will then begin with track 1 of the CD selected.

Note:

If magazine slots are empty, it is not possible to select them with the right-hand rotary/pushbutton .

If you select an empty magazine slot with a number key, e.g.  the message “No CD” is displayed.

## Fast forward/backward

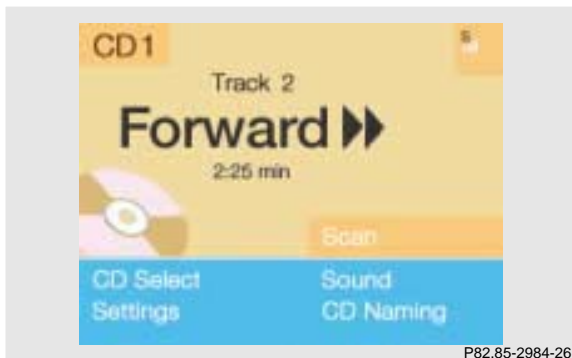

### Fast forward:

Press **▶▶** longer than 2 seconds.  
Display message: “Forward ▶▶”, display shows the current position via the time indicator display.

### Fast backward:

Press **◀◀** longer than 2 seconds.  
Display message: “◀◀ Reverse”, display shows the current position via the time indicator display.

Release the on of the keys to stop the function. Playback will resume.

## CD operation

## CD track scan

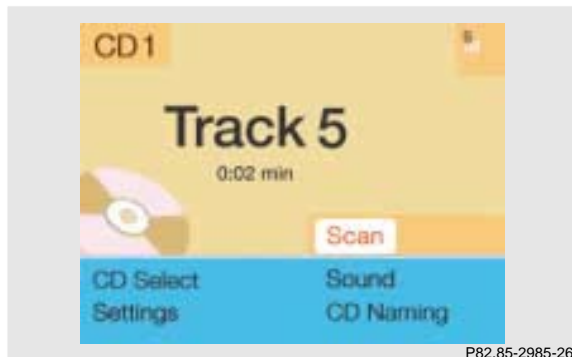



The tracks on a CD can be scanned one after the other for 8 seconds each.

Press the right-hand rotary/pushbutton  to activate the "Scan" function when it is highlighted.

Scan will begin and "Scan" will appear in red.

## 56

There are three ways to switch the function off:

- Press the right-hand rotary/pushbutton  again
- Press  / 
- Switches off automatically when the starting track is reached.

Note:

For the CD changer, it is also possible to scan all of the CDs in the magazine slots 1-6 for 8 seconds each (always track 1). Activate the function "CDs scan" in the "Settings" menu, page 62.

## Entering, altering and deleting CD names

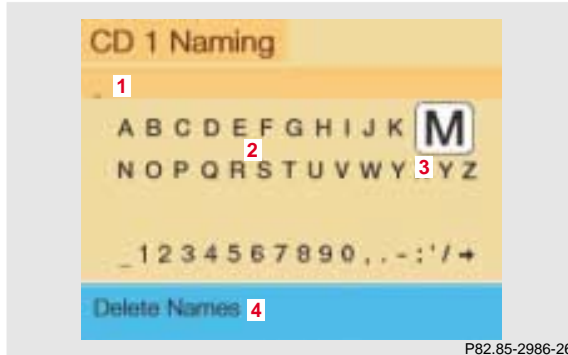

- 1 Input line
- 2 Symbols list (letters, digits, special characters)
- 3 Character selected appears magnified, magnified “M” is starting point
- 4 “Delete Names” function

This function can be used to allocate a name to a CD (e.g. CD title). The name will be recognized and displayed by COMAND after removal and re-insertion of a CD.

Naming the CDs inserted in the magazine:

Use the right-hand rotary/pushbutton  to highlight the “CD Naming” menu field in the main CD menu and press to confirm your selection. The “CD Naming” menu will appear on the screen.

Use the right-hand rotary/pushbutton  to highlight the desired characters (letters, numbers) and press the knob briefly to confirm. When you have selected a character, it will appear in magnified form (3), and when confirmed it will appear in the input line (1).

The input marker indicates the current position.

Delete the character entered last:

Press **DEL** briefly. The input marker moves to the left as it deletes.

Deleting a complete name:

Press **DEL** for longer than 2 seconds.

Altering a name:

Delete one character at a time or the entire name. Then enter the new name.

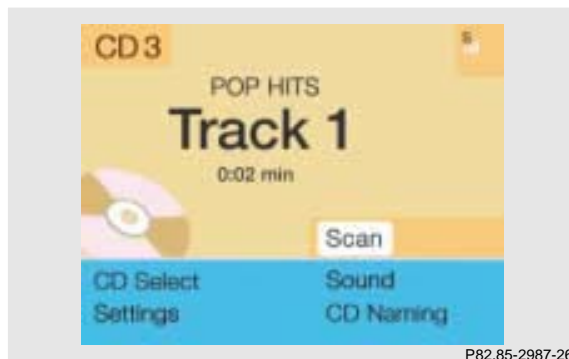

Press the right-hand rotary/pushbutton  longer than 2 seconds to confirm the name. The main CD menu will appear on the screen.

The name of the CD currently playing will appear above the track number.

The CD will retain this name even if it is inserted into a different magazine slot.

#### Notes:

The CD names are saved in the names list in alphabetical order. If the name memory is full, the following message will appear: “Attention, name memory is full; new entry only possible after clearing old one!”

Confirm the message by pressing the menu field marked “OK”. The input menu will appear again.

Use the “Delete Names” menu field to clear the memory, page 59.

## Delete CD name

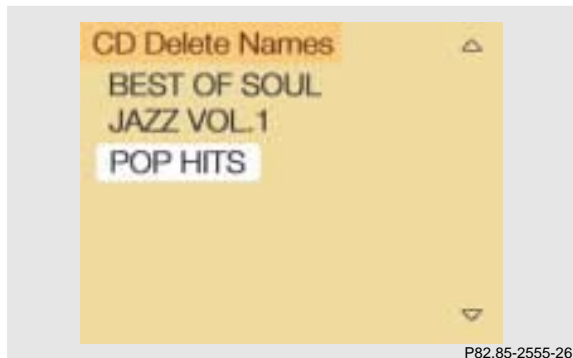

Use the right-hand rotary/pushbutton  to highlight the “Delete Names” menu field in the “CD Naming” menu and confirm it.

The list of CD names will appear on the screen.

Use the right-hand rotary/pushbutton  to highlight the name you wish to delete.

Press the right-hand rotary/pushbutton  briefly to delete the name. The following entry will then move up one position.

Press the right-hand rotary/pushbutton  longer than 2 seconds to return to the CD main menu.

Paging forward in the name memory:

- Highlight the ▼ symbol and confirm
- Move the cursor with the right-hand rotary/pushbutton  above the last page entry and past the ▼ symbol.

Paging backward in the name memory:

- Highlight the ▲ symbol and confirm
- Move the cursor with the right-hand rotary/pushbutton  above the first page entry and past the ▲ symbol.

## CD operation

## Selecting playback mode

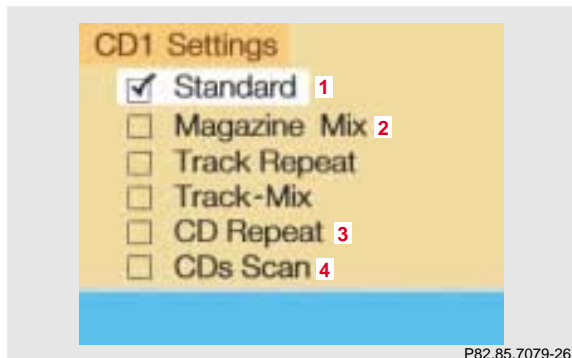

Use the right-hand rotary/pushbutton  to highlight the "Settings" menu field in the main CD menu and press to confirm.

The "Settings" menu will appear.  
A checkmark indicates the active function.

## 60

Selection (1):

The "Standard" function is active (CD playback in ascending order). This function is automatically selected when another CD has been selected.

Selection (2) to (4):

Lettering in black - CD changer in operation,  
function can be selected

Lettering in grey - CD drive in operation,  
function cannot be selected

No functions displayed - no CD changer connected

Note:

It is only possible to select one playback mode at a time.

## Magazine Mix (CD changer only)

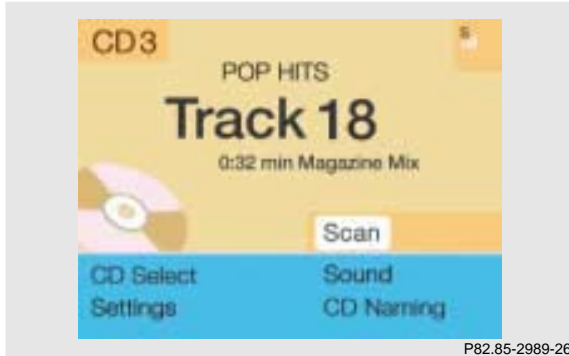

Select the “Magazine mix” function to play all of the tracks of all of the CDs in the magazine slots 1-6 in random order.

Use the right-hand rotary/pushbutton  to highlight the “Magazine mix” function and press it to confirm. This function will be marked with a checkmark. Press **BACK** to return to the main CD menu.

“Magazine mix” will appear in the main CD menu.

## Track repeat

Select the “Track Repeat” function to repeat the current track until you switch the function off.

“Track Repeat” will appear in the main CD menu.

## Play CD tracks in random order

Select the “Track-Mix” function to play back the tracks on the CD currently selected in random order.

The message “Track-Mix” appears in the CD main menu.



## CD repeat (CD changer only)

Select the “CD Repeat” function to repeat the current CD until you switch the function off again.

“CD Repeat” will appear in the main CD menu.

### CD Scan Function (CD changer only)

Select the “CDs scan” function to scan all of the CDs in the magazine slots 1-6 for 8 seconds each (track 1).

The scan function will begin with the CD following the CD currently playing. The scan function will end automatically after all of the CDs have been scanned or if you press  / .

### Switching off the function

Use the right-hand rotary/pushbutton  to highlight the desired function in the “CD settings” menu and press it to confirm your selection (no checkmark).

The “Standard” function will be activated automatically (checkmark).

### CD playback mute

Press  while a CD is being played.



CD operation will be muted and the symbol  appears in the symbol bar.

Cancel playback mute:

Press  once again.

CD operation is switched on again and the symbol  is faded out of the symbol bar.

Note:

Changing over to another (e.g. radio), choosing a title by pressing  /  or by altering the volume with the left-hand rotary/pushbutton  also cancels the mute.

## Error messages



- 1 CD changer error messages
- 2 CD drive error messages

“No CD changer” - The system cannot detect the CD changer; contact a Mercedes-Benz Center (1)

“No magazine” -There is no magazine inserted in the CD changer; load CDs into the magazine and insert the magazine into the CD changer (1)

“Magazine empty” -There are no CDs in the magazine; load CDs into the magazine and insert the magazine into the CD changer (1)

“No CD”:

- The magazine slot selected does not contain a CD; select a different magazine slot (1)
- No CD is in the CD drive or the CD in the drive is not ready to play (2)

“Being activated” - The CD changer is not yet ready for operation (1)

“Reading error” - The system cannot read the CD which has been inserted (2), e.g. audio CD

## CD operation

## 64

“Error” – an error other than those described here has occurred (1, 2)

If an error occurs in the operation of the CD drive or the CD changer, the system will automatically switch to the other component after 3 seconds.

CD operation will resume when the error has been corrected.

If it is not possible to play the CD which has been selected in the CD changer (“Error” message), the system will automatically select the next CD in the magazine.

“Temperature too high” – CD operation will switch off automatically after 3 seconds; press the corresponding key to select a different audio source (1, 2)

## Tips on caring for your CDs

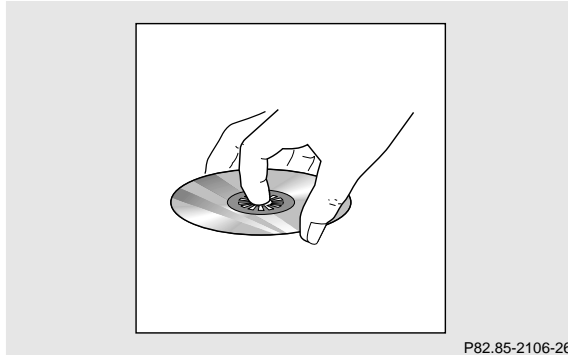

Handle CDs only as illustrated.

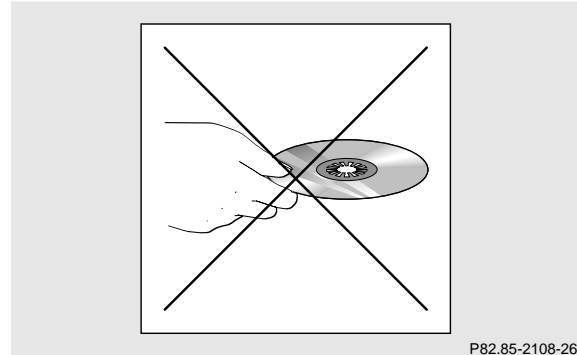

Avoid touching the CD surface with your fingers!

## CD operation

66



Clean CDs with a dry, lint-free cloth. Wipe them from the inside to the outer edge. Never wipe the CD in a circular motion.

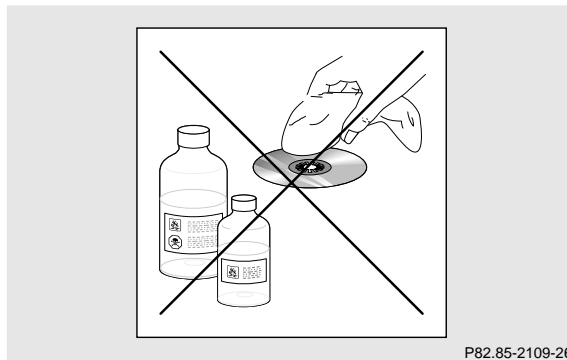

Do not use rubbing alcohol or solvents to clean the CDs.

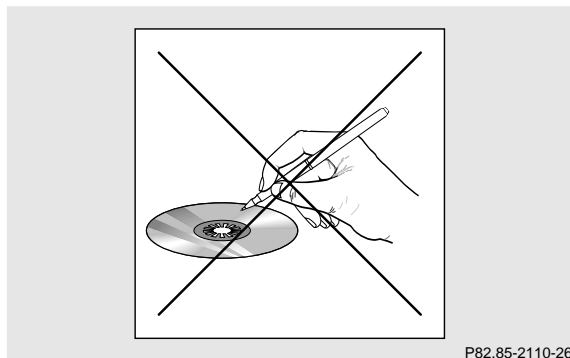

Do not write or put stickers on CDs.

Note:

You can name a CD and then this name will be displayed on the screen when you play it, page 57.

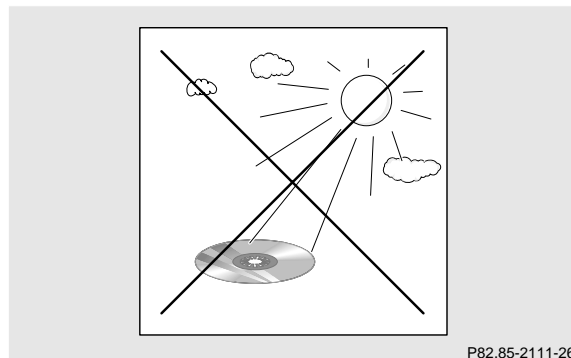

Do not expose the CDs to heat or direct sunlight.

## CD operation

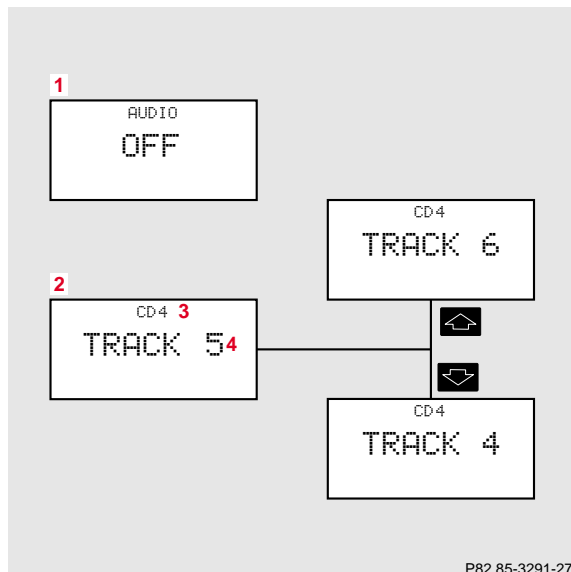

**Multifunction steering wheel, Multifunction display**



## 68

- 1 No audio system has been switched on.
- 2 The CD unit is switched on.
- 3 The number of the CD currently playing will be displayed.
- 4 Track number being played.

Press **CD** on COMAND to switch the CD unit on.

Press  or  repeatedly if necessary until display (2) appears.

Press  or  until the desired track number appears.

Press  or  to display the next or previous system.

## Adjust sound settings

The COMAND system is equipped with a standard amplifier.

You can set the sound Bass/Treble and the sound-center (fader and balance) individually or select sound impressions.

See individual audio mode descriptions for instructions on this feature.

Adjustments to the sound have a different effect on the audio and service sources. The predefined sound modes are available for the audio sources only.

The audio sources include:

- Radio (FM/AM, WB)
- CD drive and CD changer
- Auxiliary sound source, e.g. tape deck (if connected)

The main menu for the sound is activated in the audio sources through the menu field “Sound”.

Service sources include:

- Telephone
- Voice output in navigation
- Voice recognition system

The main menu for the sound is activated in the menu “NAVI Settings” through the menu field “Sound”.

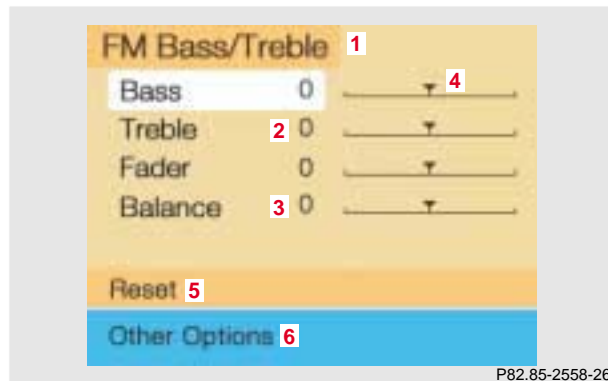
**Activate main Sound menu**

For audio sources:

- 1 Status line, radio (FM) is switched on

Other messages:

AM band is active - "AM Bass/Treble"

WB band is active - "WB Bass/Treble"

CD drive or CD changer is switched on -  
"CD Bass/Treble"

- 2 Actual sound settings (Bass/Treble)

- 3 Actual sound-center  
Fader: front - back  
Balance: left - right

- 4 Slide switch to alter the value

- 5 Reset bass and treble to "0", and the fader/balance to the middle

- 6 Activate predefined sound impressions, page 74

To activate the main sound menu for radio (FM/AM, WB) or CD operation:

Use the right-hand rotary/pushbutton  to highlight the main menu field "Sound" and press it to confirm your selection.

The actual settings for sound and fader/balance are displayed. The "Bass" menu field is highlighted whenever "Bass/Treble" menu (FM/AM, WB, or CD) is first accessed.

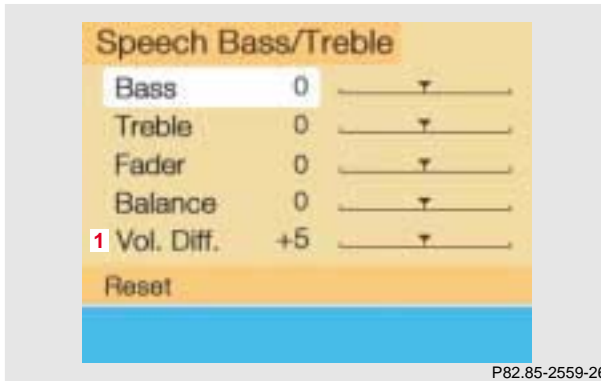

Activate the main sound menu for setting the service sources:

Use the right-hand rotary/pushbutton  to highlight the “Settings” menu field in the navigation menu and press to confirm your selection. The menu “NAVI Settings” will now appear.

Use the right-hand rotary/pushbutton  to highlight the “Sound” menu field and confirm by pressing.

The actual settings for sound and fader/balance are displayed. The “Bass” menu field is highlighted whenever the “Speech Bass/Treble” menu is first accessed.

#### 1 Volume difference

Set the volume difference between language during route guidance and an active audio source.

“0” - The volume of the audio sources is not affected during voice output

“10” - The audio source is set very low during language playback.

Notes:

- No sound impressions is provided for service sources.
- During adjustment of Bass/Treble/Fader/Balance in the “Speech Bass/Treble” menu, COMAND will issue a repetitive voice output of “Sample” to allow you to set the settings as you prefer.

## Setting Bass/Treble/Fader/Balance

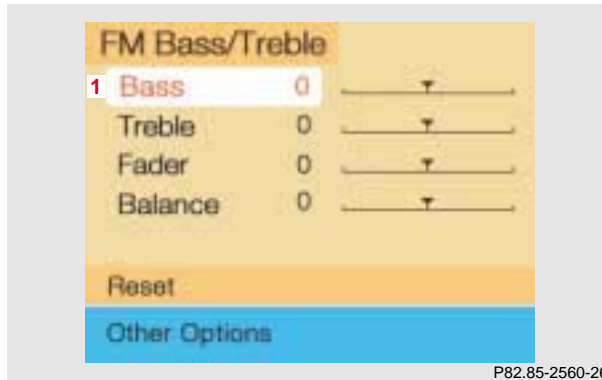

P82.85-2560-26

## 1 Setting mode active

Use the right-hand rotary/pushbutton  to move the cursor to the parameter you want to alter and confirm by pressing.

The setting mode is activated. The activated sound parameter is shown in red.

Turn the right-hand rotary/pushbutton  to set the desired value and confirm by pressing. The marked sound feature is shown in black.

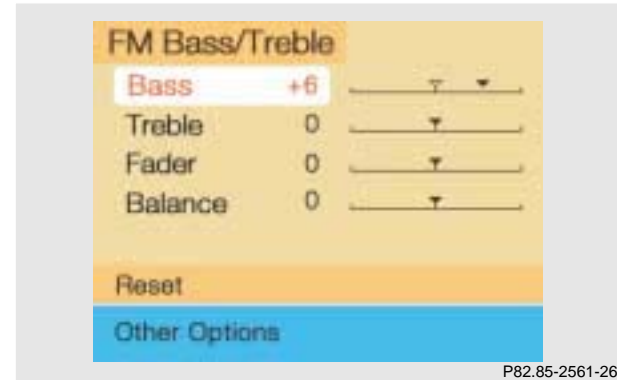

P82.85-2561-26

There are three ways to return to the main audio menu:

- Press **BACK**
- Hold the right-hand rotary/pushbutton  longer than 2 seconds
- Automatic activation after 15 seconds.

To reset the current alteration, set all values to “0”:

Use the right-hand rotary/pushbutton  to highlight the menu field “Reset” and confirm by pressing.

Notes:

The balance is adjusted to the same setting for the radio (FM/AM, WB) and CD changer.

Adjustments which are made to the navigation system will affect the Voice recognition system and the telephone.

Use the “Reset” menu field to position the balance back to the center of the vehicle, to set the sound linearly and to reset at the same time the sound volume to a defined value.

## Activating sound impressions



In the main sound settings menu, use the right-hand rotary/pushbutton  to highlight the menu field “Other Options” and confirm by pressing.

The “Other Options” menu (FM/AM, WB, or CD) is activated, the symbol for the actual sound impression is shown.

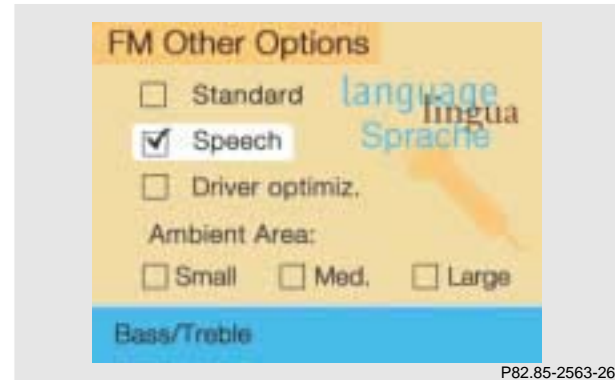

Selecting a new sound impression:

Use the right-hand rotary/pushbutton  to highlight the required sound optimization and confirm by pressing (checkmark appears).

Note:

It is only possible to select one sound optimization at a time.

There are three ways to return to the main audio menu:

- Press **BACK**
- Hold the right-hand rotary/pushbutton  longer than 2 seconds
- Automatic activation after 8 seconds.

Note:

The main sound menu is activated through the “Bass/Treble” menu field.

Sound settings

Available sound impressions:

- Standard – the sound is set linearly for the center of the vehicle
- Speech – the emphasis is on the spoken word
- Driver optimiz. – the sound is optimized for the driver’s position
- Ambience
  - Small – small rooms are simulated
  - Medium – medium-sized rooms are simulated
  - Large – large rooms are simulated

Note:

Sound impressions are not available for the service sources.

## Telephone

Notes .....	78	Incoming calls .....	88	Quick-dialing (for the first 10 memory locations) .....	109
Before you use the telephone .....	78	Outgoing calls .....	92	Notebook .....	110
Multifunction steering wheel, Multifunction display .....	80	Dialing a telephone number .....	92	Editing the phone book .....	111
Overview of the Multifunction displays .....	81	Dialing a number from the phone book .....	95	SMS function .....	118
Quick reference - Telephone .....	82	Redial .....	102	Emergency call (9-1-1) .....	122
Menu overview - Telephone .....	84	Dialing from calls list .....	106	Service numbers .....	125
Switching telephone operation on .....	86	Speed-dialing (only with COMAND) .....	107		

### Before you use the telephone



#### Warning!

**Never operate radio transmitters equipped with a built-in or attached antenna (i.e. without being connected to an external antenna) from inside the vehicle while the engine is running. Doing so could lead to a malfunction of the vehicle's electronic systems, possibly resulting in an accident and personal injury.**

Radio transmitters, such as a portable telephone or a citizens band unit should only be used inside the vehicle if they are connected to an antenna that is installed on the outside of the vehicle.

- Please read this section first before attempting to operate your telephone.
- Always drive with extreme caution when you operate the telephone hands-free.
- Do not stop or park in no-parking areas to use the telephone.
- Close the windows and reduce all outside noise as much as possible when you use hands-free operation.
- If the signal strength is very weak (display in the symbol field of all main menus) you should not make telephone calls. Wait until reception improves.
- A brief disconnection from the cellular network is not a malfunction, as this can occur when the network switches areas.
- If you are required to enter the unlock code when you switch the COMAND operating unit on, enter it to be able to use all of the telephone functions. Enter the unlock code, see page 86.
- If a telephone menu other than the telephone menu is displayed on the COMAND screen, the display will change if an outgoing call is sent out via the multifunction steering wheel.

In the following situations, it is not possible or not yet possible to use the telephone:

- The telephone is already unlocked but is not (yet) registered in the network. The message “No Service” is displayed. The telephone will try to register into the network. If the network is available, the telephone will be ready for use. The above message also appears if the network is no longer available due to weak signals.

The message “No Service” is displayed for 8 seconds if you try to make a call.

- The message “Telephone is being activated. Please wait” appears. The phone is being initialized for use. Select other equipment functions by pressing the corresponding button or wait until the phone is active.
- The message “Error: Phone not connected” is displayed. Please connect the telephone.
- The message “Error: Phone defective” appears. The telephone cannot work because an error has occurred. Please contact a Mercedes-Benz Center.

In the following situation, it is not yet possible to use the functions “Dial number from phone book” or “Speed-dial”.

- The mobile telephone has been plugged into its holder correctly the COMAND operating unit has been switched on and the telephone function download function has been actuated (see telephone section in operator’s manual).

In the following situations it is not possible to make a call and following messages appear:

- “System busy, redial?” – dialing has failed because system is busy.
- “No Service, redial?” – dialing has failed because network cannot be received.
- “Phone off” – Tele Aid is active, the telephone function will switch on automatically after Tele Aid is ended.

## Telephone









80

## Multifunction steering wheel, Multifunction display



- 1 Multifunction display
- 2 Multifunction steering wheel

Turn the electronic key in the steering lock to position 1 or 2.

- 3  Activates next system
- 4  Activates previous system
- 5  Pages backwards through the phone book
- 6  Pages forwards through the phone book
- 7  Raises telephone volume of dial tone/idle tone
- 8  Lowers telephone volume of dial tone/idle tone
- 9  Accepts incoming calls, page 88  
Activates the redial memory, page 102  
Starts dialing after the selection of a number, page 96, 103
- 10  Ends telephone call, page 88  
Refuse call, page 88  
Interrupts dialing, the message READY will appear, page 96

If the telephone menu is displayed on at the multifunction display and the telephone operation is switched on at COMAND, changes in COMAND affect the multifunction display.

## Overview of the Multifunction displays

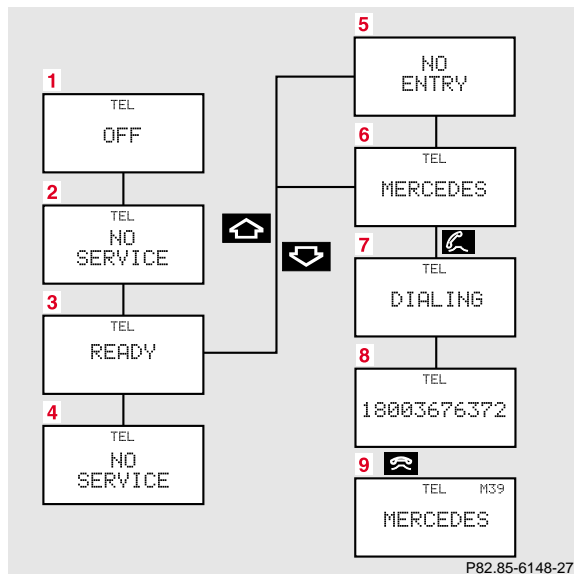

- 1 The telephone is switched on, Telephone operation is activated, page 86
- 2 The system is searching for the corresponding telephone network
- 3 The telephone is ready for use
- 4 The vehicle is currently outside the transmission or reception range
- 5 Phone book is empty and/or has not been loaded into the COMAND telephone memory
- 6 A number selected from the phone book
- 7 Dialing begins
- 8 Dialing is completed and the number is displayed. The display will remain until you end the call
- 9 Number of the memory location and the name stored here

## Quick reference – Telephone

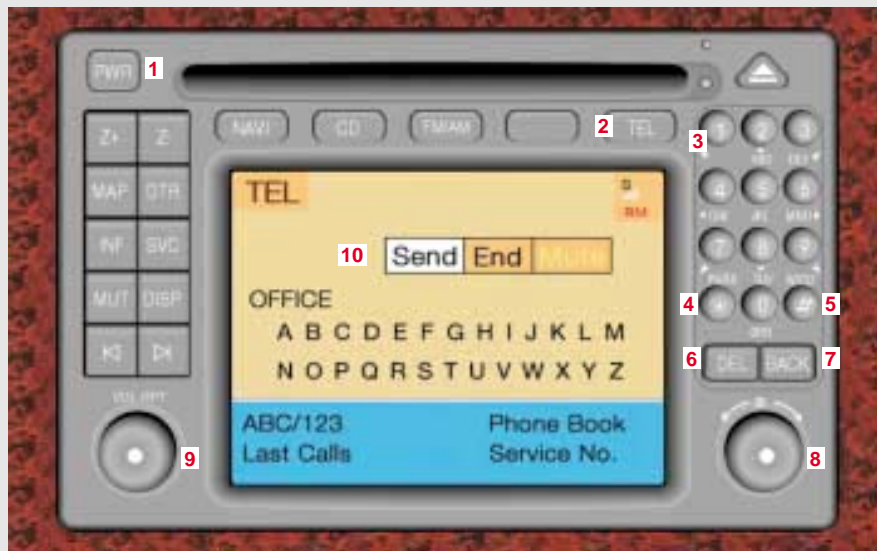

- 1 Switching the COMAND on/off, page 13
- 2 Switching telephone operation on, page 86
- 3 Entering the unlock code, page 86  
Entering a telephone number, page 92  
Speed-dialing (only with COMAND), page 105  
Quick-dialing (for the first ten memory locations), page 109  
Enter the emergency call, page 122
- 4 Subsequent dialing, page 94
- 5 Subsequent dialing, page 94
- 6 Enter the unlock code, enter the telephone number:  
Press **DEL** briefly: the last digit will be deleted  
Press **DEL** for longer than 2 seconds: the whole number will be deleted
- 7 Activates previous menu
- 8 **Turn** to highlight a menu field, a list entry, or a symbol  
**Press** to activate a sub-menu, confirms an entry/selection, starts dialing when “Send” is highlighted, ends the call when “End” is highlighted, switches off the microphone of the hands-free telephone when “Mute” is highlighted.
- 9 Sets the volume for hands-free operation of the telephone (during a call), page 90
- 10 Color screen with main telephone menu

## Telephone

84

## Menu overview - Telephone

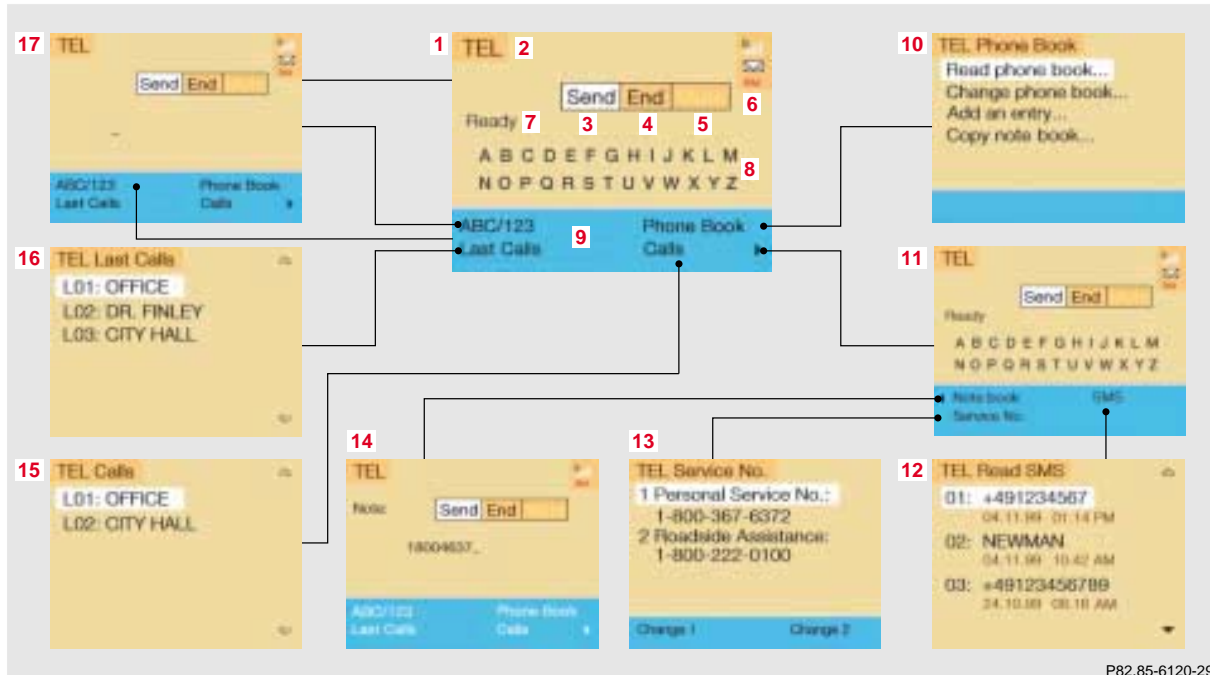

- 1 Main telephone menu
- 2 Telephone system is active
- 3 Accepting calls using COMAND, page 89  
Begin dialing, page 93
- 4 Ending a call, page 94
- 5 Microphone mute, page 90
- 6 Reception quality is indicated by up to 5 bars for a connected and functional telephone  
  - ☒ - incoming SMS message, page 118
  - ROAM indicator:  
    - RM in black - telephone is using a home type system
    - RM in red - telephone is using a non home type system
    - No RM - telephone is using the home system
- 7 Input line
- 8 Alphabet
- 9 Menu fields for activating sub-menus
- 10 "Phone book" selection menu, page 98  
  - Can be activated when the input line is empty
  - Phone book with names, page 98
  - Activation according to input of up to 3 letters
- 11 Main telephone menu with other menu fields can be activated via the "►" symbol
- 12 SMS list, page 119  
  - An SMS message can be read or deleted in the sequence menus
- 13 "Service No." menu, page 125  
  - Selecting a service number for an outgoing call or changing a service number
- 14 Notebook, page 110  
  - Noting a telephone number during a call
  - Dialing from the notebook
- 15 "Calls" function, page 106  
  - The last incoming calls are stored
- 16 Redial memory, the last 10 (L01-L10) numbers dialed are stored  
  - L01, last number or name dialed
  - L01-L10 - numbers or names dialed previously, page 104
- 17 Telephone menu for entering telephone numbers, page 92  
  - Switch back to the main telephone menu via the "ABC/123" menu field

### Switching telephone operation on

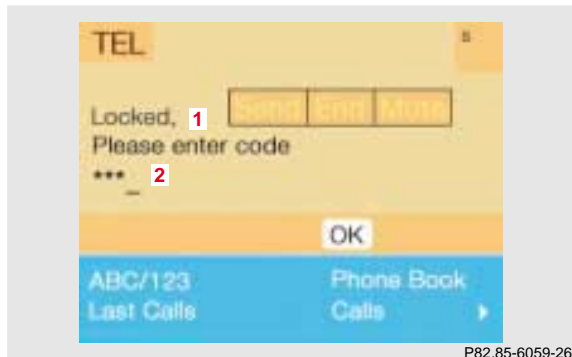

- 1 Status line, telephone not yet logged onto network
- 2 Input line for unlock code

Press **TEL**, the menu for entering the unlock code will appear.

#### Entering the unlock code

Use the number keys **1** through **0** to enter the unlock code. Asterisks will appear in place of the digits in the input line.

If entered code is correct and the phone is registered in a network, the phone is ready for use.

Notes:

Your unlock code prevents unauthorized persons from using your telephone. Be sure to memorize this code, a three digit number, carefully.

If you enter an incorrect code, the systems returns to the menu for entering the unlock code.

The unlock code must be entered when the telephone is switched on for the first time (if phone is in locked mode), but not if you switch to it from another system (i.e. navigation).

“No Service” – This message will appear in case the phone is not registered in a network or the network is no longer available due to weak signal conditions.

#### Switching telephone operation off

The phone can be switched by pressing the **TEL** button (when connected to the coiled cord) or the **PWR** button (when in portable mode).

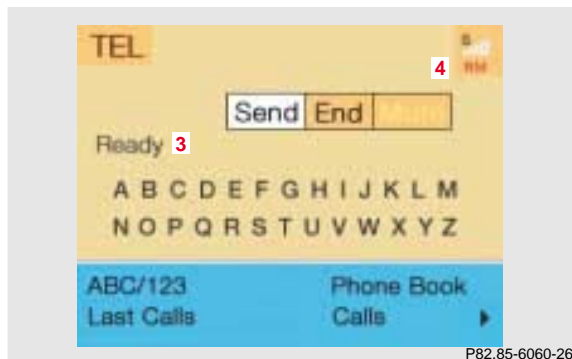

If the phone memory has been downloaded to COMAND, the menu fields “Phone Book”, “Last Calls” and “Calls” will be available. If the memory was not downloaded, the menu fields will be dimmed out.

Outgoing calls, page 92.

- 3 Telephone is ready for operation, the “Send” button is highlighted
- 4 Reception quality is indicated by up to 5 bars, RM will be shown, if you are not in a home system

## Incoming calls

### Accepting a call using the multifunction steering wheel



- 1 “Call” – the system detects an incoming call, the phone rings

Accepting a call:

Press , audio source is automatically muted.

Refusing a call:

Press .

Ending a call:

Press , audio source is restored.  
The main telephone display appears.

Communication between the multifunction display and the COMAND screen:

If different systems are displayed, the changes made to COMAND will have no effect on the driver information display.

Press the COMAND key marked  to switch to the telephone functions.

## Accepting calls using COMAND

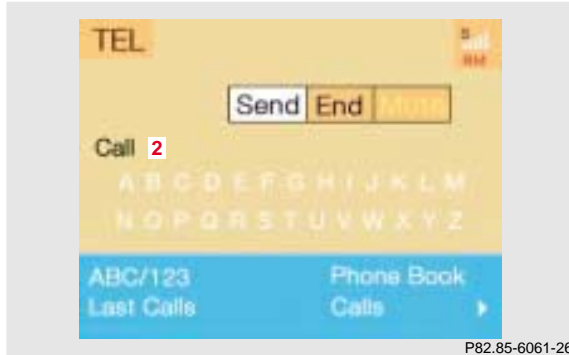

- 2 “Call” – the system detects an incoming call, the phone rings

If no telephone menu is shown on the screen press **TEL** if the phone is ringing. The above menu appears.

Accepting a call:

Confirm the “Send” button by pressing the right-hand rotary/pushbutton **⬇**. An audio source will switch to mute.

Refusing a call, use one of the three ways:

- Press the right-hand rotary/pushbutton **⬇** to confirm the “End” button
- Press **TEL**
- Press **BACK**.





3 “00:01:21 h” – the call time appears

Switching the microphone for the hands-free telephone off:

Use the right-hand rotary/pushbutton  to highlight the “Mute” button and confirm by pressing.

Volume set for hands-free operation:

Turn the left-hand rotary/pushbutton to the right  – raising the volume

Turn the left-hand rotary/pushbutton to the left  – lowering the volume

Ending a call, use one of the three ways:

- Press the right-hand rotary/pushbutton  to confirm the “End” button
- Press **TEL**
- Press **BACK**.

The main telephone menu will reappear.

### Important!

If the menu of a different system is displayed on the COMAND screen and/or the multifunction display, it is possible to accept an incoming call by pressing  on the steering wheel, page 96.

Note:

There is an incoming calls memory list. You can activated the list by using the “Calls” menu field, page 106.

## Accepting an incoming call using the mobile telephone handset

The telephone is installed in the storage compartment under the armrest, see your vehicle's operating instructions.

Press the right-hand rotary/pushbutton  to confirm the "Send" button.

Remove the telephone from its cradle and conduct your call. Hands-free operation will switch off.

Ending a call:

Put the phone back in its mount.



### Warning!

**Please be sure to pay attention to the traffic situation at all times. Use the mobile telephone<sup>1</sup> only when the traffic situation allows.**

**Some jurisdictions prohibit the driver from using a cellular telephone while driving a vehicle. Whether or not prohibited by law, for safety reasons, the driver should not use the cellular telephone while the vehicle is in motion. Stop the vehicle in a safe location before answering or placing a call.**

<sup>1</sup> Observe all legal requirements.

### Outgoing calls

You can use the following functions:

- Dialing a telephone number, page 92
- Dialing a number from phone book, page 95
- Redial, page 102
- Dialing from calls list, page 106
- Speed-dialing (only with COMAND), page 107
- Quick-dialing (for the first 10 memory locations), page 109
- Emergency call, page 122

### Dialing a telephone number

#### Entering a telephone number



Press **TEL**. The main telephone menu will appear.

Enter the telephone number with the number keys **1** through **0**. The menu will change when the first digit is entered.

Correcting input:

- Press **DEL** briefly – the last digit will be corrected
- Press **DEL** longer than 2 seconds – the whole entry will be corrected.

## Begin dialing

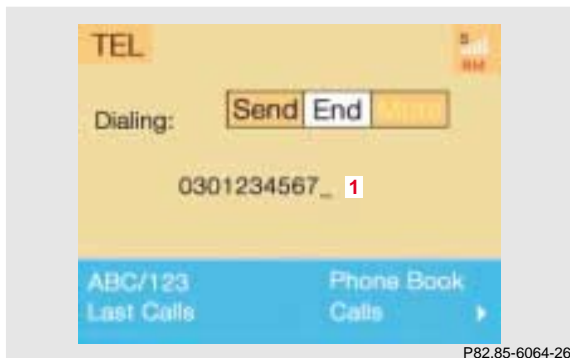

- 1 If the number together with a name is stored in the phone book, the name is displayed on the screen after the “Send” button is pressed.

When the “Send” button is highlighted, press the right-hand rotary/pushbutton  and confirm your entry.

Dialing will begin. The “End” button is highlighted. An active audio source will automatically be muted.

Interrupt dialing, use one of the three ways:

- Press the right-hand rotary/pushbutton  to confirm the “End” button
- Press **TEL**
- Press **BACK**.

### Conducting a call



When the call is answered, the call time will appear on the screen.

Ending a call, use one of the three ways:

- Press the right-hand rotary/pushbutton  to confirm the “End” button or call has been finished by the other party
- Press **TEL**
- Press **BACK**.

Subsequent dialing:

During a call you can press the number keys **1** through **0**, **\*** and **#** to transmit other DTMF tones.

The numbers dialed will appear in the menu for 10 seconds after the last key is pressed (subsequent dialing display).

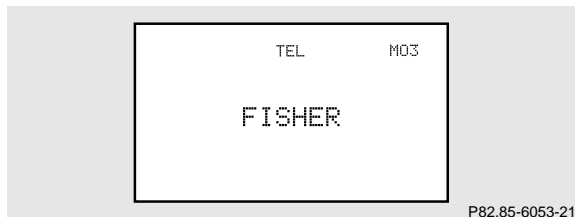

## Dialing a number from the phone book

### Dialing using the multifunction steering wheel





In order to use this feature, the phone book must have previously been downloaded to the COMAND memory. This is performed automatically each time the portable phone is connected to the coiled cord.



The telephone is ready for operation, page 87.

Press  or  as often as necessary until the telephone mode appears in the multifunction display.

If the display ENTER CODE appears, enter the unlock code first, page 86.

Message NO ENTRY will appear when the portable phone has been put into the cradle and no entries are stored in the phone book.

Press  or , to page forwards or backwards through the redial memory in alphabetical order.

If  or  is pressed for longer than 2 seconds, the phone book is scrolled through very quickly.

The name selected will appear in the display.

Note:

If you do not wish to place a call, press . The process will be cancelled and the message READY will appear.

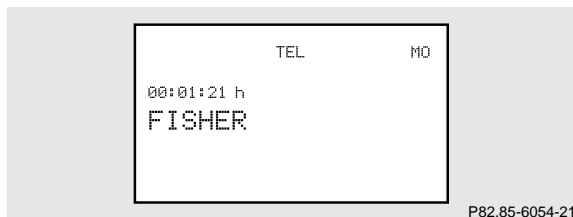

Press , when the name you want is displayed.



The number will be dialed.

DIALING will appear in the display. The current audio source will be muted automatically.

After dialing has been completed, the name will reappear. It will remain in the display for the duration of the phone call.

Press  to end the call.

The message READY will appear. The audio source will switch on again.

Press  or  to display the next or previous system.

Notes:

Numbers are stored in the telephone book according to memory locations; a memory location starts with “M”.

Memory locations available: M01-M99

## Dialing using COMAND

Phone book, names:

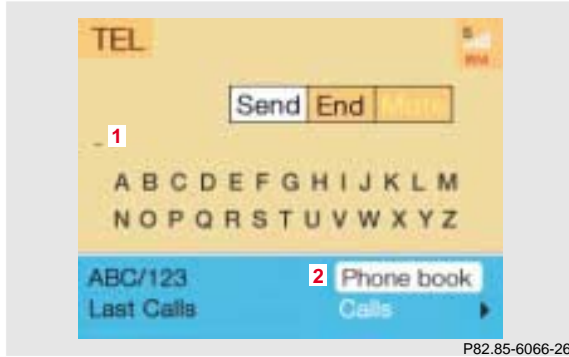

To access the phone book in the main telephone menu:

Use the right-hand rotary/pushbutton ● to highlight menu field (2) and press it to confirm.

- 1 Input line is empty – activates the “Phone book” selection menu, page 98

When up to 3 letters are entered in the input line the relevant page of the “Phone book” (names) will be opened, page 98.

Use the right-hand rotary/pushbutton ● to highlight the letters one after the other and press to confirm. The letters will be entered in the input line.

- 2 Activates the “Phone book” selection menu or opens the phone book (names).

Note:

The phone book will also be opened if the right-hand rotary/pushbutton ● is pressed for longer than 2 seconds after input of the last letter.

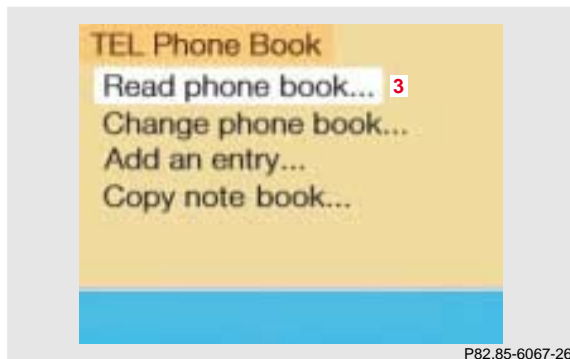

The “Phone book” selection menu will be activated.

- 3 Opens the first page of the phone book (names)

Press the right-hand rotary/pushbutton  and confirm the marked menu field “Read phone book”. The phone book will be opened.

Select the desired entry, see information on the right.

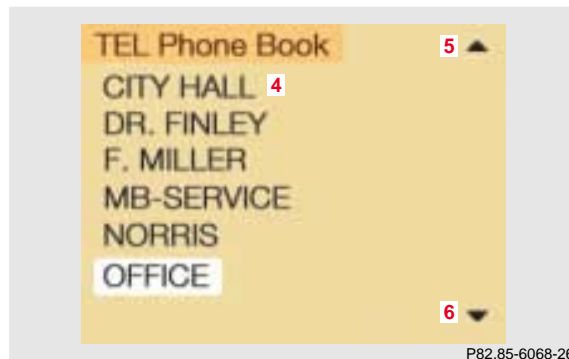

The relevant page of the phone book will be accessed after input of up to 3 letters in the telephone main menu.

- 4 Marked entry, sorted alphabetically
- 5 Symbol, page back in the list
- 6 Symbol, page forward in the list

Note:

The phone book stored in the phone is memory being read downloaded. Use the right-hand rotary/pushbutton  to highlight the desired entry and press to confirm.



The main telephone menu will appear with information on the name selected.

Begin dialing:

Press the right-hand rotary/pushbutton  (to confirm the “Send” button). The “End” button is highlighted.

Ending a call, use one of the three ways:

- Press the right-hand rotary/pushbutton  to confirm the “End” button
- Press **TEL**
- Press **BACK**.

## Telephone

100

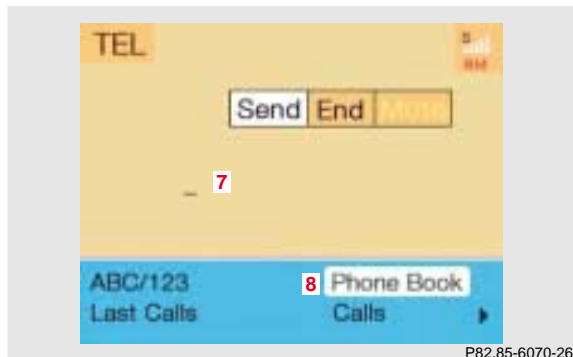

Phone book, telephone number:



Use the right-hand rotary/pushbutton  to highlight the “ABC/123” menu field and press to confirm. The menu for entering the telephone number will appear.

- 7 Input line is empty – activates the “Phone book” selection menu, page 111

When up to 3 digits are entered in the input line to dial the memory location, the relevant page of the “Phone book” (telephone numbers) will be opened, page 101

Use the numerical keys  through  to highlight the digits one after the other and press to confirm. Enter the digits in the input line.

- 8 Activates the “Phone book” selection menu or opens the phone book (telephone numbers)

To activate the “Phone book” selection menu, open the phone book:

Use the right-hand rotary/pushbutton  to highlight menu field (8) and press to confirm.

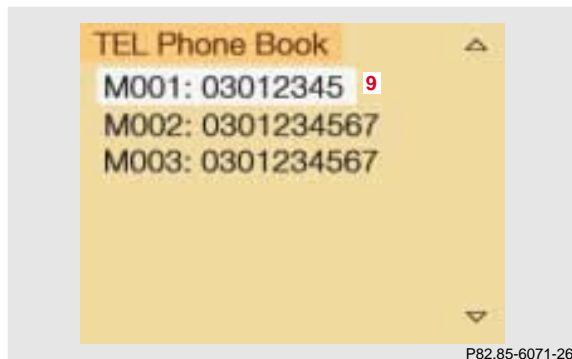

- 9 Entries, sorted according to memory location  
Memory locations in the telephone: M01-M09



Use the right-hand rotary/pushbutton  to highlight and confirm the desired entry.

The main telephone menu will appear indicating the selected number and memory location.

Begin dialing, page 93

Conducting a call, page 94.

To select the memory location directly:

Enter up to 2 digits using the  through  number keys in the main telephone menu.

Use the right-hand rotary/pushbutton  to highlight and confirm the “Phone Book” menu field.

The phone book (numbers list), which is stored in the telephone, will be appear.

Use the right-hand rotary/pushbutton  to highlight the desired entry and press to confirm.

The main telephone menu will appear indicated the selected phone number.

Begin dialing, ending a call, page 99.

Note:

If there is no entry in the numbers list, the message “No entry in list” appears in the telephone menu.

## Telephone

102

## Redial

## Dialing using the multifunction steering wheel

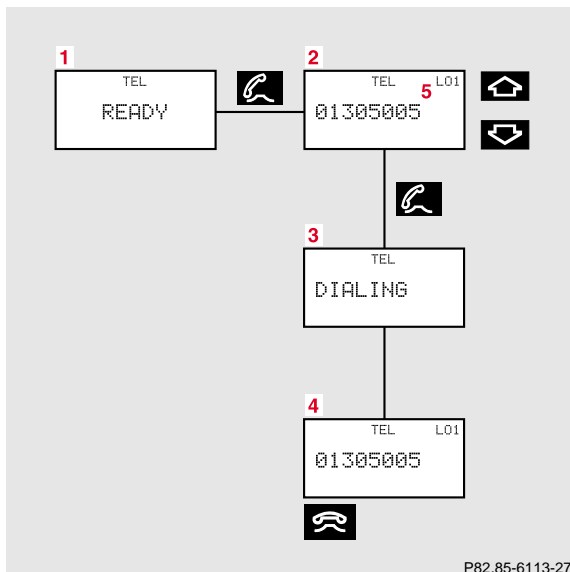



- 1 The telephone is ready for operation
- 2 Number in the redial memory
- 3 Number in the redial memory – dialing has begun
- 4 Dialing is completed
- 5 Memory location number, the last 10 numbers dialed are stored  
L01, the number dialed last  
L01 to L10, numbers dialed previously

The telephone is switched on.

Press or repeatedly until the corresponding telephone menu (1) appears on the screen.

Press , the redial memory is activated and the last number dialed will appear on the screen.

Press  or , to page forwards or backwards through the redial memory. The number selected will appear on the screen with the corresponding memory location.

Note:



If you do not wish to place a call, press . The process will be cancelled and the display will appear (1).

Press  when the desired number appears in the display (2).

Dialing will begin (3).

When dialing has been completed, the number will remain on the display.



Press  to end the call. The ready entry will appear in the display (1).

Press  or  to display the next system or previous system.

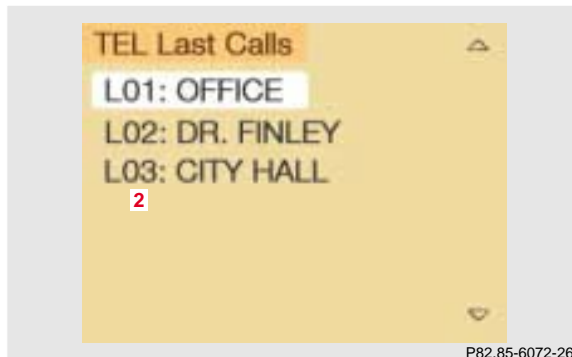
### Dialing with COMAND



- 6 Memory location L01 – L10, the last 10 numbers dialed are stored
  - L01, the last number dialed
  - L01 – L10, the numbers dialed previously
- 7 An empty triangle marks the start of the list
- 8 An empty triangle marks the end of the list

Use the right-hand rotary/pushbutton  to highlight and confirm the “Last Calls” menu field in the main telephone menu or press the right-hand rotary/pushbutton  when the “Send” button is marked and when there is a blank input line.

The redial memory will be activated.

Turn the right-hand rotary/pushbutton  to select the desired phone number.

Select the number by pressing the right-hand rotary/pushbutton .



The main telephone menu is activated and the phone number or name selected will appear.

Begin dialing:

Press the right-hand rotary/pushbutton  to confirm the “Send” button. The “End” button will now be highlighted. The message “Dialing” will appear.

Note:

If the list is empty, the message “No entry in list” will appear.

Ending a call, use one of the three ways:

- Press the right-hand rotary/pushbutton  to confirm the “End” button
- Press **TEL**
- Press **BACK**.

### Dialing from calls list



Use the right-hand rotary/pushbutton  to highlight and confirm the “Calls” menu field in the main telephone menu.

The incoming calls memory will be activated.

Turn the right-hand rotary/pushbutton  to select the desired phone number.

Begin dialing:

Press the right-hand rotary/pushbutton  (to confirm the “Send” button). The “End” button is highlighted.

Ending a call, use one of the three ways:

- Press the right-hand rotary/pushbutton  to confirm the “End” button
- Press **TEL**
- Press **BACK**.

## Speed-dialing (only with COMAND)

For all memory locations

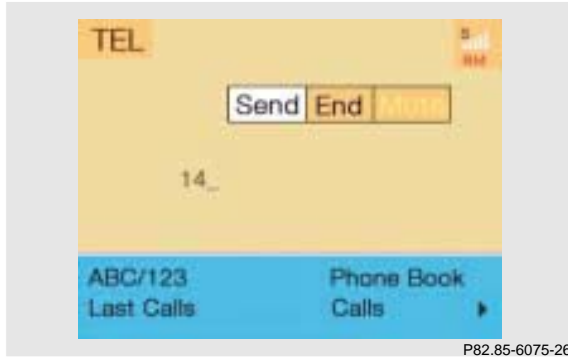

When the main telephone menu is on display enter the memory location desired with the number keys, e.g. ① ④. You can enter up to 2 digits.

Begin dialing, use one of the two ways:

- Press the right-hand rotary/pushbutton ④ to confirm the “Send” button. The “End” button will now be highlighted.
- Press the last number key longer than 2 seconds.

### Important!

If you enter “1” and press the right-hand rotary/pushbutton ④, the number stored in memory location 1 (default is 9-1-1) will be dialed.

Pressing or holding “1” longer than 2 seconds will also initiate the call.

**The 9-1-1 emergency call system is a public service. Using it without due cause is a criminal offense.**

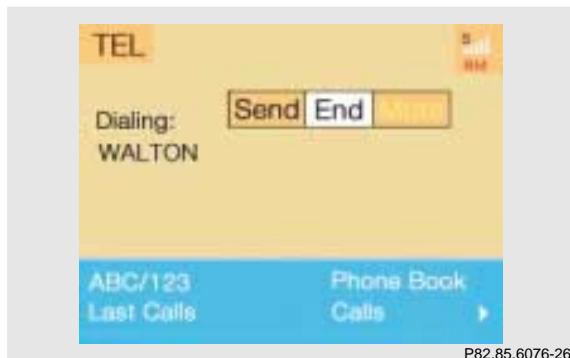

The phone number or name will appear in the menu.  
When the call is initiated, the call time will appear on the screen.

Ending a call, use one of the three ways:

- Press the right-hand rotary/pushbutton  to confirm the “End” button
- Press **TEL**
- Press **BACK**.

### Quick-dialing (for the first 10 memory locations)

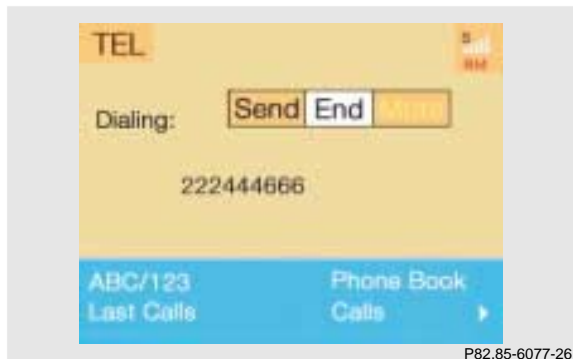

The main telephone menu is displayed:

Press **1** through **0** longer than 2 seconds.

### Important:

Pressing or holding “1” longer than 2 seconds will initiate the emergency call 9-1-1 (default), page 122.

The phone number or the name stored at this memory location will appear on the screen.

When the call is initiated, the call time will appear on the screen.

Ending the call, page 99.

## Telephone

## Notebook



During a conversation you can enter a telephone number in the notebook or edit an existing one.

To open the notebook:

Use the right-hand rotary/pushbutton  to highlight the “▶” symbol and press to confirm.



Then use the right-hand rotary/pushbutton  to highlight the “Notebook” menu field and press to confirm.

## 110

To enter the telephone number:

Use the number keys  to , or press  and .



To correct input:

- Briefly press  to delete the last digit
- Press  for longer than 2 seconds to delete the entire entry

To close the notebook and store input:

Press .

## Dialing a telephone number from the notebook

To open the notebook, see information on the left. When the telephone number in the notebook appears, press the right-hand rotary/pushbutton  and the  symbol to confirm.

Note:

The telephone number in the notebook can be transferred to the phone book, page 101.

## Editing the phone book

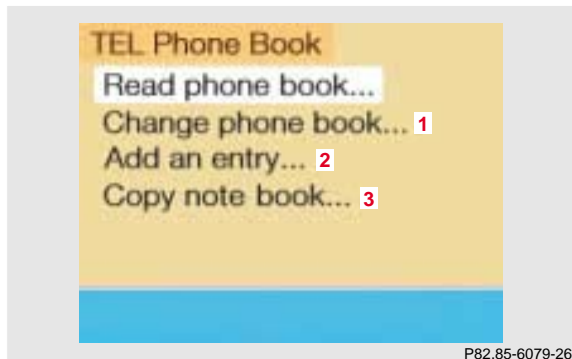

Use the right-hand rotary/pushbutton  to highlight the “Phone book” menu field in the main telephone menu and press to confirm.

The “Phone book” selection menu will be activated.

- 1 To change entries in the phone book, page 111
- 2 To add an entry in the phone book, page 116
- 3 To transfer a telephone number from the notebook, page 117

## Changing entries in the phone book

Use the right-hand rotary/pushbutton  to highlight menu field (1) and press to confirm.

The phone book will either display the list of names sorted alphabetically or the list of telephone numbers sorted according to memory location.

To activate the input menu:

Use the right-hand rotary/pushbutton  to highlight the desired entry and press to confirm.

## Telephone

To change a name:

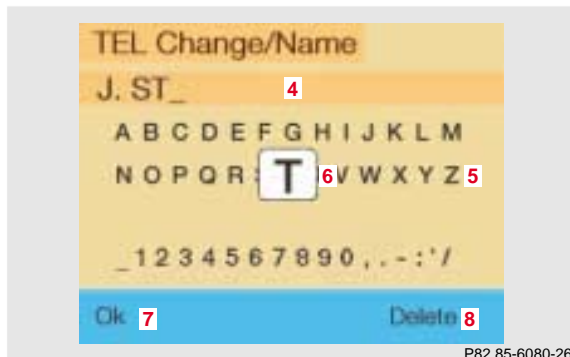

- 4 Phone book entry selected, enter up to 20 characters
- 5 Character list, selection of letters, digits and special characters
- 6 Zoom, character selected appears magnified
- 7 Confirm the changed entry
- 8 Deletes the entry in the phone book, page 115

## 112

To correct input:

- Briefly press **DEL** to delete the last digit
- Press **DEL** longer than 2 seconds to delete the entire entry

Use the right-hand rotary/pushbutton  to highlight the desired character one after the other and press to confirm. A character selected will be displayed magnified (6).

The name will be entered in the input line (4). The input cursor indicates the current input position.



Note:

The characters can also be selected using the numerical keys. Each numerical key has more than one assignment.



Select a character by pressing the key as listed below the corresponding number of times. The character selected (6) will appear magnified.

Button 1:	,	.	-	1	:	'	/	
Button 2:	A	B	C	2	Ä	Å	Æ	Ç
Button 3:	D	E	F	3	É	È		
Button 4:	G	H	I	4	IJ			
Button 5:	J	K	L	5				
Button 6:	M	N	O	6	Ñ	Ö	Ø	Œ
Button 7:	P	Q	R	7				
Button 8:	T	U	V	8	Ü			
Button 9:	W	X	Y	9	Z			
Button 0:	Blank		0					

To adopt the character selected and to enter it in the input line:

- press  or turn the right-hand rotary/pushbutton 
- automatically after 2 seconds.

Select one of the options to store a name changed in the phone book:

- Use the right-hand rotary/pushbutton  highlight the “OK” menu field and press it to confirm.
- Press and hold down the right-hand rotary/pushbutton  to confirm the last letter of the name.

The menu for entering telephone numbers (page 114) will appear.

If you do not wish to save the changes:

Press **BACK**.

## Telephone

## 114

Changing a telephone number:

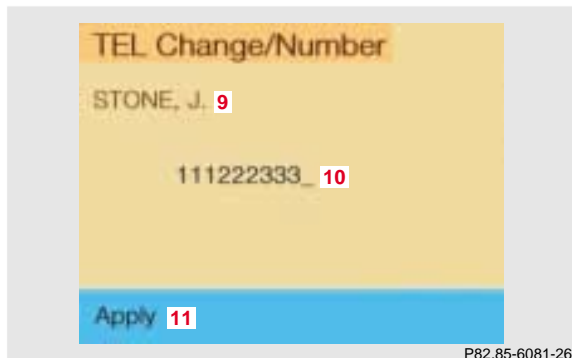

9 Current name or name previously changed (brown) will not be displayed if there is no name entry in the phone book for the telephone number concerned.

10 Input line, marked when activated

11 Telephone number will be stored in the phone book

Enter the telephone number using the numerical keys

1 to 0, the # and \* keys.

To correct input:

- Briefly press **DEL** to delete the last digit
- Press **DEL** longer than 2 seconds to delete the entire entry

To store the telephone number in the phone book:

Use the right-hand rotary/pushbutton  to highlight menu field (11) and press to confirm.

The main telephone menu will be activated.

## Deleting an entry in the phone book

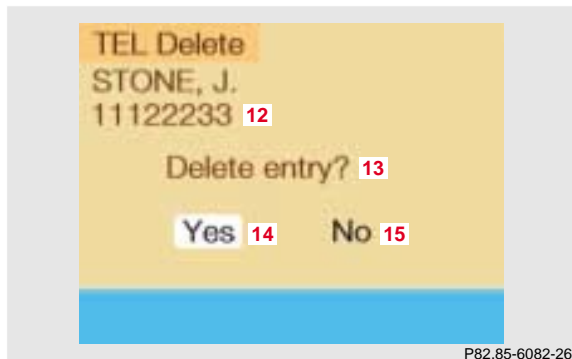

The query will appear after confirmation of the “Delete” menu field in the input menu, page 112.

**12** Name and telephone number of the entry to be deleted

**13** Query

Note:

Positions (12) and (13) are highlighted in brown.

Use the right-hand rotary/pushbutton  to highlight the menu field and press to confirm:

**14** Entry is deleted,  
the main telephone menu will appear.

**15** The entry is not deleted,  
the menu previously activated will appear.

## Telephone

**Adding an entry to the phone book**

To enter the name:

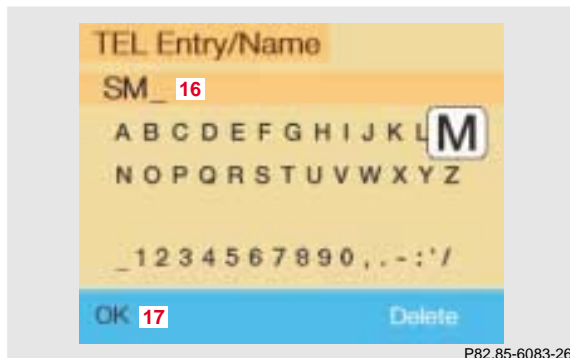

Use the right-hand rotary/pushbutton  to highlight the “Add entry” menu field in the selection menu (page 111) and press to confirm. An input menu will appear.

**116**

**16** Input line

**17** Confirm the name

Note:

The name will also be stored if the last letter of name was confirmed by pressing and holding the right-hand rotary/pushbutton .

The menu for entering the telephone number will be activated, page 112.

To change a name, page 112.

To correct input, page 112.

Entering and storing a telephone number:

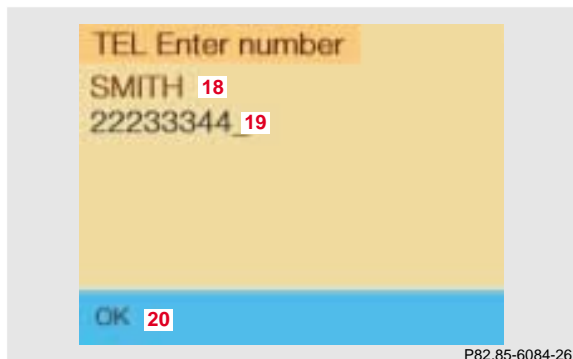

- 18 Name previously entered
- 19 Input line for telephone number  
Enter the telephone number using the numerical 1 to 0, the # and \* keys.
- 20 The telephone number will be filed in the memory selected, the main telephone menu will be activated.

### Storing a number in the notebook

After selecting the “Copy notebook” menu field in the “Phone book” selection menu (page 111) the menu for entering the name (page 112) and then the menu for entering the telephone numbers (page 114) will appear.

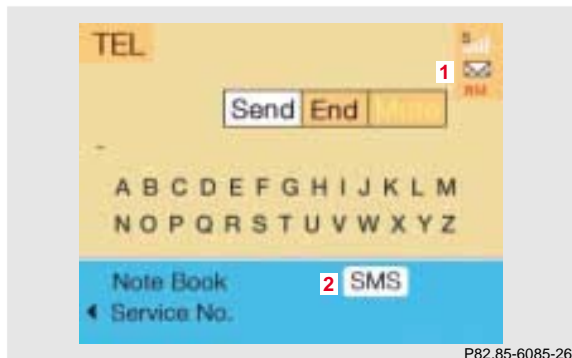
**SMS function**

This function can be used for receiving, reading and deleting short text messages<sup>1</sup>.

**Activating the SMS function**

Use the right-hand rotary/pushbutton  to highlight the “▶” symbol in the main telephone menu and press to confirm. Other menu fields will be displayed.

<sup>1</sup> If available from your carrier.

- 1 The  symbol will appear when a new SMS message has arrived.

Note:

When an SMS message arrives the “RM” symbol (roaming mode) may be faded out and the  symbol displayed.

- 2 Activates the SMS list, page 119

Note:

If necessary, SMS messages must be read in by the COMAND unit. The following message will appear: “SMS loading...”. The loading process can take up to 30 seconds.

## Reading SMS messages received



Use the right-hand rotary/pushbutton  to highlight the “Reading SMS” menu field and press to confirm.

The list of SMS messages received (up to 10 messages) will be displayed. The messages are sorted according to the time received.

- 3 Current SMS message marked, telephone number or name (if it is in the phone book) will be displayed, date and time will be highlighted in brown

Use the corresponding arrow symbols to page forwards and backwards through the list of messages.

## Telephone

## 120

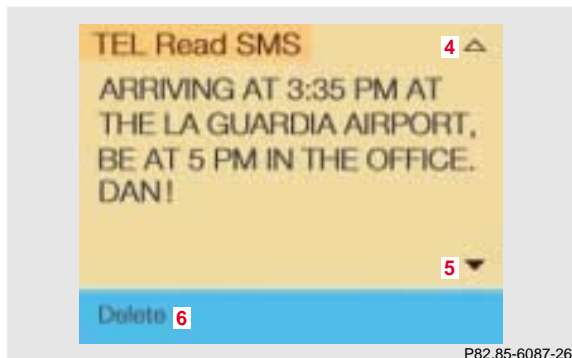



Press the right-hand rotary/pushbutton  to page through the list:

- 4 Pages through the list backwards when the symbol is marked
- 5 Pages through the list forwards when the symbol is marked
- 6 Deletes an SMS message, page 121

Use the right-hand rotary/pushbutton  to highlight the desired SMS message and press to confirm. The SMS message will be displayed.

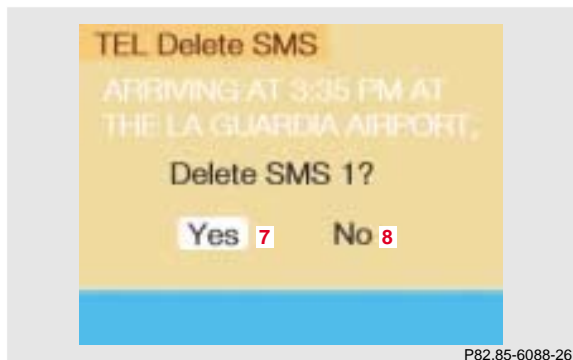
## Deleting an SMS message



Use the right-hand rotary/pushbutton  to highlight the “Delete” menu field and press to confirm.

### 7 SMS message currently displayed is deleted

If there was only one SMS message:  
The main telephone menu will be activated.

If there are other SMS messages:  
The next SMS message will be displayed.

Notes:

An SMS message can also be deleted by pressing **DEL**.

After the oldest SMS message has been deleted the current SMS message will be marked in the list displayed.

### 8 SMS message is not deleted, the list with the SMS messages received (page 119) will be activated, the SMS message previously marked remains marked

## Emergency call

### Important!

If you enter “1” and press the right-hand rotary/pushbutton , the number stored in memory location 1 (default is 9-1-1) will be dialed.

Pressing or holding “1” longer than 2 seconds will also initiate the call.

**The 9-1-1 emergency call system is a public service. Using it without due cause is a criminal offense.**

You can make an emergency call to an emergency rescue station with a mobile communications network.

The emergency call will be placed as long as the corresponding mobile communications network is available. To do this, switch the telephone on, if you have not already done so.

It will also be placed, if the unlock code is not entered.

Emergency calls may not be possible with all mobile phone networks or if certain network services and/or telephone functions are active. Check with your local network operating company.

### Note:

This function places a call to the local 9-1-1 provider. It does not initiate a Tele Aid call.



### Caution!

It will not be possible to complete the emergency call if the the cellular system is busy. The message “System busy, redial?” appears.

Take appropriate measures to alert an emergency service as soon as possible.

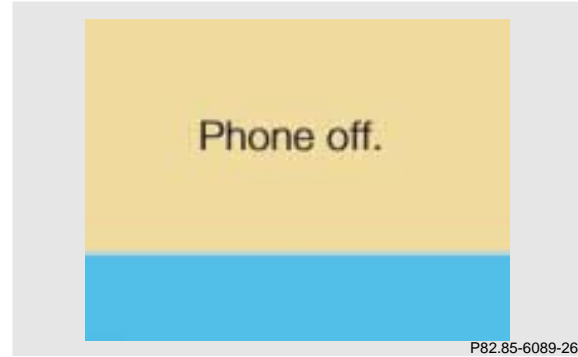

In this case the telephone main menu will disappear and the message “Phone off.” is displayed. After Tele Aid call is ended the telephone main menu will re-appear.  
See your vehicle’s operator's manual.

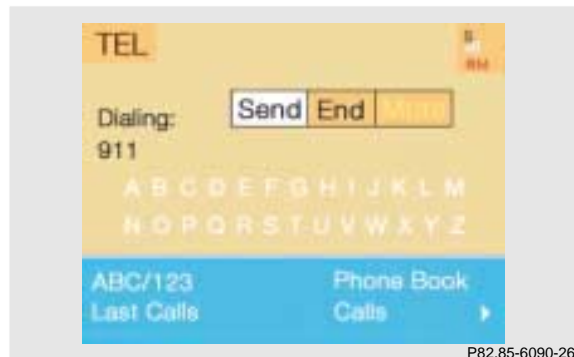
**Telephone is ready for operation**

P82.85-6090-26

When the main telephone menu or a memory menu is displayed on the screen, enter the emergency number by pressing **1** for longer than 2 seconds (quick-dialing).

Do not place the emergency call:

Mark the “End” button with the right-hand rotary/pushbutton **2** and press to confirm or press **BACK**.

Begin dialing:

After pressing the **1** key longer than 2 seconds the number being dialed will appear. The “End” button is highlighted.

When the call is initiated, the call time will appear in the display.

Ending a call, use one of the three ways:

- Press the right-hand rotary/pushbutton **2** to confirm the “End” button
- Press **TEL**
- Press **BACK**.

Notes:

To use this function you must ensure that the number stored in memory location 1 is the number to be dialed in case of emergency.

This function will also be performed if the phone is locked.

## Service numbers

### Calling a service number

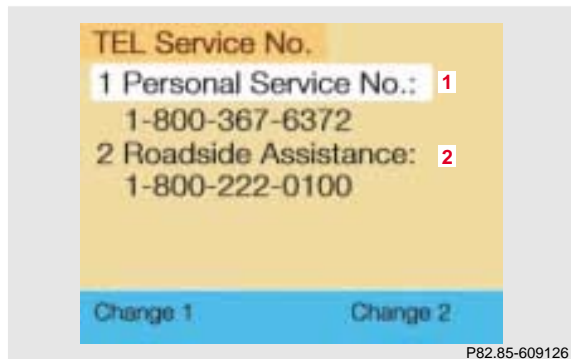

Use the right-hand rotary/pushbutton  to highlight the menu field “Service No.” in the main telephone menu and confirm by pressing. The “Service No.” menu is activated.

- 1 Personal service number
- 2 Number for roadside assistance

Use the right-hand rotary/pushbutton  to highlight the service you require in the menu and confirm by pressing.

The main telephone menu is activated.

The dialing process starts:

Confirm the “Send” button by pressing the right-hand rotary/pushbutton . One of the messages “Personal Service No.” or “Roadside Assistance” appears. The “End” button is highlighted.

After the call has been initiated the length of the call is displayed.



Ending a call, use one of the three ways:

- Press the right-hand rotary/pushbutton  to confirm the “End” button
- Press **TEL**
- Press **BACK**.

### Changing personal service number



Use the right-hand rotary/pushbutton  to mark the menu field “Change 1” in the “Service No.” menu and confirm by pressing.  
The menu “Change Service No. 1” is activated.

Use the number keys  through  to enter the new service number.

Confirm the new service number by pressing the right-hand rotary/pushbutton .  
The new service number is now stored in the menu “Service No.”.

Note:

The personal service number is deleted after pressing the right-hand rotary/pushbutton  and inserting an empty input line.

Return to the main telephone menu by pressing **BACK**.

## Changing the number for roadside assistance



Use the right-hand rotary/pushbutton  to highlight the menu field "Change 2" in the "Service No." menu and confirm by pressing.  
The country list "Change Service No. 2" is activated.

Select the new country service number by highlighting the country abbreviation you want with the right-hand rotary/pushbutton  and confirm by pressing.

The new service number is now stored in the menu "Service No."

Return to the main telephone menu by pressing **BACK**.

**Navigation**

Notes .....	130	Selecting the last destinations ..	160	Route guidance with a mixture of map and symbol display .....	181
Before you use the navigation system .....	130	Selecting the route calculation mode and calculating the route ...	161	Altering the map scale .....	182
Navigation .....	132	Route guidance .....	164	Selecting map orientation .....	183
Quick reference - Navigation ....	132	The principle of route guidance .....	164	Marking a way point .....	184
Switching the navigation system on .....	135	Requesting destination and route information .....	167	Selecting a detour during route guidance .....	187
Changing the Navigation CD .....	137	Beginning route guidance .....	174	Resetting functions during route guidance .....	191
Destination entry .....	138	Turning onto a street .....	176	Deviating from the calculated route .....	192
Menu overview - Destination entry .....	138	Following the course of the road .....	178	Reaching your destination .....	192
Entering destination address ....	140	Driving through an intersection .....	179	Activating audio system .....	193
Continue destination input .....	148	Changing to map display during route guidance .....	180	Activating audio functions during route guidance .....	194
Selecting a destination via the map .....	151			Cancelling route guidance .....	195
Entering points of interest .....	155				

Destination memory .....	196	Saving the current vehicle location in the destination memory .....	200	Entering the vehicle position ....	203
Activating the main destination memory menu .....	196	Sorting the destination memory .....	201	Calibration .....	204
Retrieving a destination from the destination memory .....	197	Deleting a destination in the destination memory .....	202		
Saving the current destination in the destination memory .....	198				

### Before you use the navigation system

The route calculated by COMAND is a recommendation on how to best reach your selected destination.



#### Warning!

During route guidance, you will not receive any information on traffic lights, stop or yield signs, no parking or no stopping zones, one-way streets, narrow bridges and similar traffic regulation data. Please always strictly observe traffic regulations while driving. Traffic regulations always have priority over any route recommendations given. Study manual and select route before driving, – do not watch display screen or operate buttons while the vehicle is in motion – let voice instructions guide you. – Stop at a safe location before using buttons or making corrections. Drive carefully and always obey traffic laws and road signs even if they contradict system instructions.

For safety's sake you should only enter destinations when the vehicle is stationary. When the vehicle is in motion, a passenger should enter the destination.



#### Warning!

The CD reader contains a Class 1 laser product. There is a danger of invisible laser radiation if the cover is opened or damaged.

Do not remove the cover. The CD reader does not contain any parts which can be serviced by the user. For safety reasons, have any service work which may be necessary performed only by qualified personnel.

The data stored on the original navigation CD is used for route calculation. Using other navigation CDs might lead to malfunctions.

Because of changes in local traffic patterns and/or incomplete data, errors in calculation may occur. The recommended trip may deviate in this case from the available traffic pattern, because the data material stored on the CD represent the local conditions at the time the CD was produced.

The current vehicle position cannot be displayed exactly in every case. Satellite reception conditions, road conditions, the condition of the vehicle, etc. could cause deviations from the actual situation. In this case enter the current vehicle position manually, page 203.

When the vehicle has been transported by a car train or a ferry, COMAND will require some time to find its exact position. In these cases it is often sufficient to move the vehicle a few yards to receive a complete route recommendation.

The reception of GPS signals can be unreliable or at times even impossible:

- When driving between tall buildings, in parking garages or tunnels, when obstructed by large vehicles and similar structures
- During electrical storms or very heavy rains
- Satellites may be switched off for checking or repair

Changing tires:

We recommend that you have any tire changes done by a Mercedes-Benz Center. Because COMAND operates using measurements taken by wheel revolutions, the tire new size must be entered when the tires are changed, see calibration on page 204.

Travelling abroad:

If you intend to travel through different regions or abroad you will need the respective CD. Contact your Mercedes-Benz Center or the Client Assistance Center at 1-800-FOR-MERCEdes (1-800-367-6372) for the available CDs.

Remove the actual Navigation CD when you leave a region or cross the border and insert the Navigation CD for the region or country you are now in.

CD drive:

The CD drive is able to read navigation CDs as well as audio CDs. If there is an audio CD in the CD drive, the following message will appear when you press **NAVI**: "No CD, please insert NAVI CD".

Remove the audio CD and insert a navigation CD, page 44.

## Quick reference – Navigation



- 1 Switching the COMAND system on/off, page 13
- 2 Switching the navigation system on, after which either the main destination input menu, the symbol display or the map will appear
- 3 CD drive:  
Inserting navigation CD, page 44  
Inserting audio CD, page 44
- 4 Ejecting navigation CD, page 137
- 5 Cursor keys **1** to **4**, **6** to **9** according to the corresponding arrows to enter the destination from the map, page 152
- 6 When entering information:  
Press briefly - to delete the last character entered  
Press for longer than 2 seconds - to delete the complete entry
- 7 Return to the previous menu
- 8 **Turn:**  
Highlight a menu field, list entry or symbol  
Altering the map scale, page 154 and 182

**Press:** Confirm an entry/selection, start a function or activate a submenu  
Activate the map scale bar, page 154 and 182

- 9 **Turn:**  
Turn to the left - To lower the volume during voice output  
  
Turn to the right - To raise the volume during voice output  
  
**Press:** To repeat the current route instruction
- 10 Press the key briefly:  
The current route instruction is muted, page 175  
  
Press the key for more than 2 seconds:  
The voice output is switched off for the duration of the current route guidance, page 175
- 11 Display the current destination and estimated time of arrival, page 167  
  
For list display:  
To display a long list entry in full in a window, page 156

## Navigation

## 134

- 12** Requesting and displaying Info Services, page 208  
Adjust system settings (brightness, language, clock, day/night-display), page 211
- 13** Route guidance active: Switches between map and symbol display, page 180  
Route guidance not active: Activates location map
- 14** Selecting a detour during route guidance, page 187
- 15** Activates the map scale bar and alters the map scale, page 154 and 182  
For list display:  
Removes the window for Number 11, page 156
- 16** Activates the map scale bar and alters the map scale, page 154 and 182
- 17** Color screen

## Switching the navigation system on

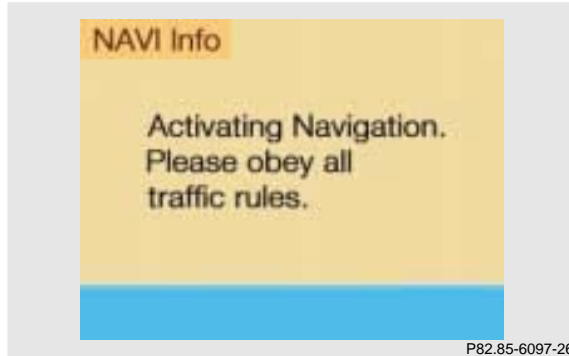

Press **NAVI**.

The following message will appear when COMAND is preparing for navigation startup: "Activating Navigation. Please obey all traffic rules".



One of three displays will appear:

- the main destination input menu, for active destination entry (illustrated above)
- the map display, page 164 when route guidance and the map were previously active and route was not completed
- the symbol display indicating turns, page 164 when route guidance and the symbol display were previously active and not completed.

## Navigation

## 136

Note:

When navigation is preparing for operation, various error messages may appear:

- “Navigation cannot be activated, an error has occurred.”
- “CD-Reading error. Please change CD” – remove the current CD and insert the Navigation CD.
- “No CD. Please insert NAV-CD type DX only” – you did not insert a CD, insert the Navigation CD type DX. Please use only a current navigation CD. A navigation CD from an older model may not be compatible and may cause an error message to be displayed.

When the error has been corrected COMAND shows the message “Activating Navigation. Please obey all traffic rules”.

To change over to another system press the corresponding key, e.g. **FM/AM**.

## Changing the Navigation CD

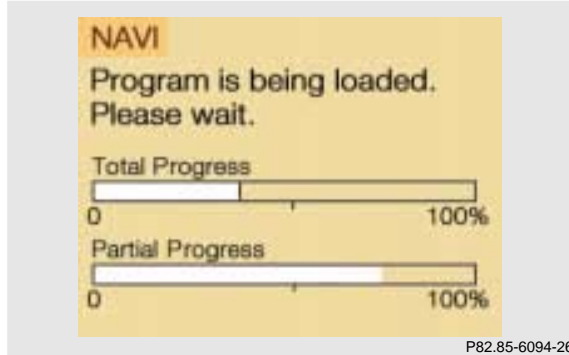

Press  to eject an inserted navigation CD.  
Insert another navigation CD.

The screen above will be displayed. The program stored on the navigation CD is being loaded.

### Important!

**Do not interrupt the loading process. Do not insert an audio CD until the loading process has been completed.**

You will then hear a voice output message informing you that the language is being loaded into memory.

### Notes:

If it has not been removed, the navigation CD ejected will be automatically retrieved by the CD player after 10 seconds.

The CD player can either read navigation CDs (destination input, route guidance) or play back audio CDs (CD mode).

During CD mode only the playback modes “Standard”, “Track repeat” and “Magazine mix” can be selected, page 60.

Destination input

138

## Menu overview – Destination entry

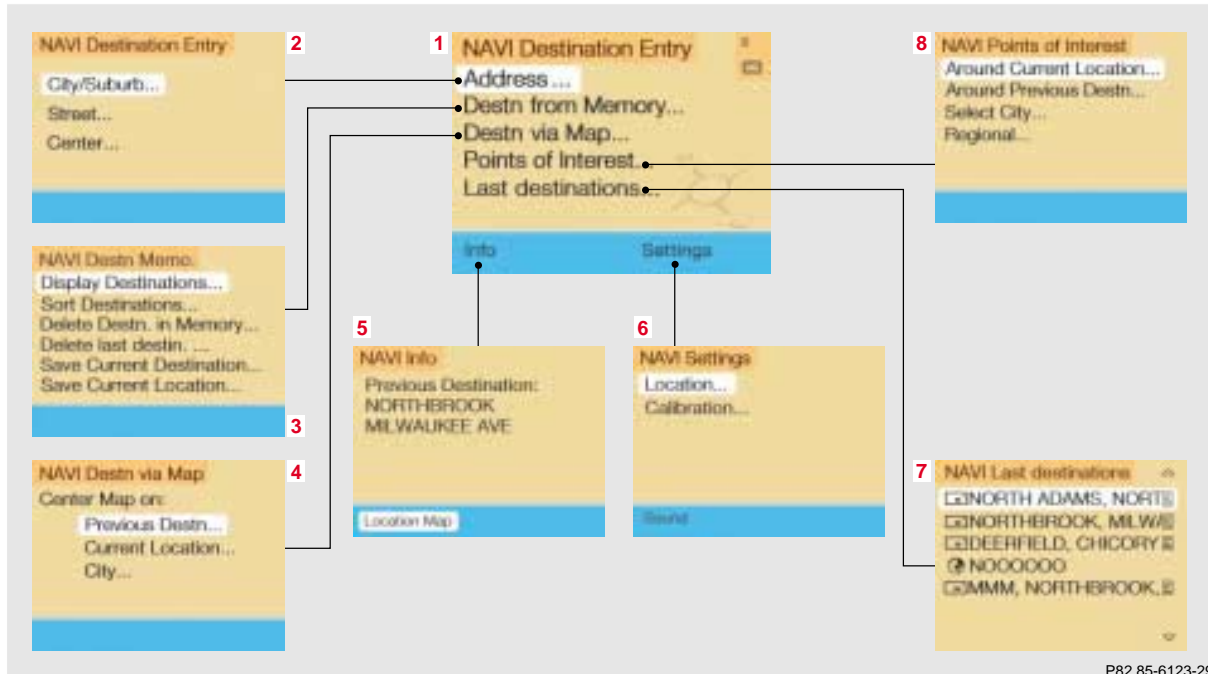

- 1 Main destination input menu, select type of destination entry:
  - Entering destination address, page 140
  - Retrieving a destination from destination memory, page 197
  - Selecting a destination via the map, page 151
  - Entering points of interest, page 155
  - Selecting the last destinations (the last 12 destinations), page 160
- 2 Entering destination address, page 140
- 3 Main destination memory menu, page 196
- 4 Set destination via location on map, page 151
- 5 Details about previous destination
- 6 Entering the vehicle position manually, page 203  
System calibration, page 204
- 7 Activates the list of the last 12 destinations for a new calculation, page 160
- 8 Points of interest main menu – set destination via point of interest listing, page 155

## Destination input

## Entering destination address

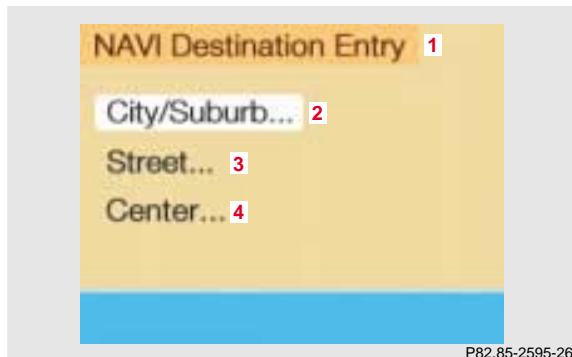

Press the right-hand rotary/pushbutton  in the main destination input menu to confirm the “Address...” menu field.

## 140

- 1 Info/status line
- 2 Select city/suburb, page 141  
No entry: place not yet entered  
Entry available: place last entered
- 3 Selecting a street, page 145  
Menu field can be selected if a city has been previously selected
- 4 Selecting a city center, page 150  
Menu field can be selected if a city has been previously selected

To cancel destination input:

Press **BACK**.

The main destination input menu will appear.

## Select city/suburb

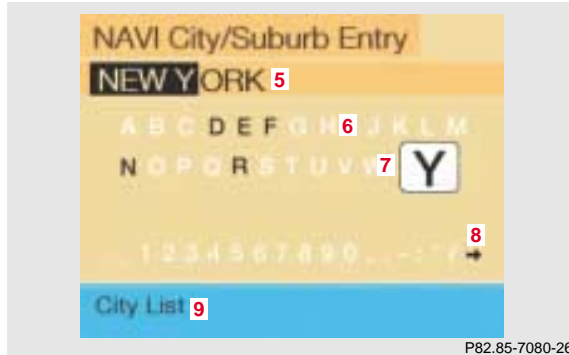

Press the right-hand rotary/pushbutton  to confirm the “City/Suburb...” menu field. An entry menu will appear.

- 5 Input line, selected characters are shown inverted; the last city selected is also shown here
- 6 Character set – alphabetic, numeric and special characters
- 7 Zoom, enlarges the currently selected character
- 8 Move the insertion point one position to the right
- 9 Activate the city list

Selecting a new destination:

Selections are made from the city list (9), call up via the menu field (9). First enter in the input line (5) the required destination or adopt the destination last selected.

Entering the destination via the input menu:

Turn the right-hand rotary/pushbutton  to select the desired letter from the character set (6), it will appear magnified (7).

Press the right-hand rotary/pushbutton  to confirm your selection, the letter selected will appear highlighted in the input line (5).

The new entry will be completed with additional letters to form one of the city/suburb names available on the list.

Note:

For quicker input, the system will offer available characters from the character set (6) based on your selections and the names of the cities stored on the navigation CD.

## Destination input

Move the insertion point one position to the right:

Use the right-hand rotary switch/pushbutton  to highlight the symbol (8) and confirm by pressing.

## 142

Correcting the entry:

To delete the last character entered – press **DEL** briefly

To delete all of the characters entered – press **DEL** longer than 2 seconds

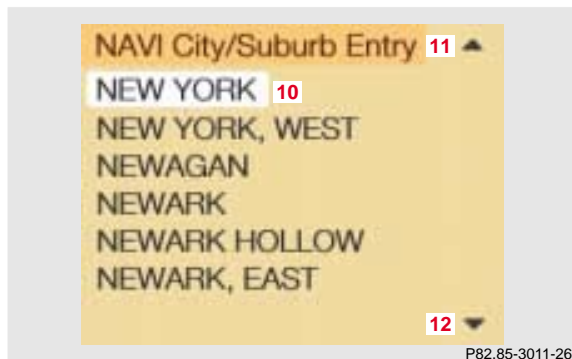

The next/previous page can be reached by turning the right-hand rotary/pushbutton  past the last/first entry.

Turn the right-hand rotary/pushbutton  to highlight the desired destination and press it to confirm.

To access the list of places:

Press the right-hand rotary/pushbutton  longer than 2 seconds or highlight and confirm menu field (9).

- 10 Selected City/Suburb, already highlighted
- 11 Display to previous page
- 12 Display to next page

## Destination input

144

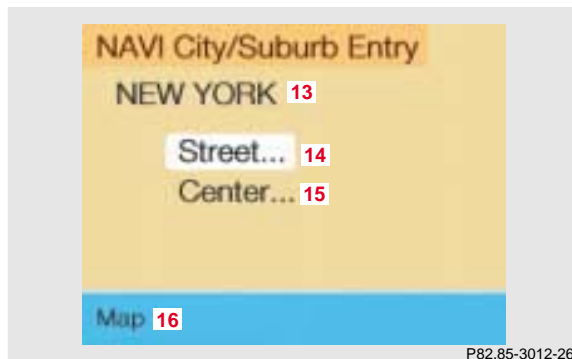

- 13 City previously selected
- 14 Selecting a street, page 145
- 15 Selecting a city center, page 150
- 16 Activates the map to select a destination, page 152

If the destination selected is stored on the CD more than once, a menu will appear so you can confirm the desired place name.

Otherwise, the selection menu illustrated above will appear on the screen.

## Selecting a street



Press the right-hand rotary/pushbutton  to confirm the “Street...” menu field.  
The street input menu will appear.

- 17 Input line, enter the letters of your desired street destination
- 18 Character set
- 19 Zoom, enlarges the currently selected character
- 20 Move the insertion point one position to the right
- 21 Activate the street list

## Selecting the street:

The selection is made from the street list, activated via the menu field (21). First enter the desired street in the input line (17).

## Enter a street:

Turn the right-hand rotary/pushbutton  to select the desired character from the character set (18), the character selected will appear in magnified form (19).

Press the right-hand rotary/pushbutton  to confirm your selection, the letter selected will be highlighted in the input line (17), the previous entry will be deleted. The new entry will be completed with additional letters to form one of the street names available on the list.

## Note:

For quicker input, the system will offer available characters from the character set (18) based on your selections and the names of the cities stored on the navigation CD.

## Destination input

Move the insertion point one position to the right:

Use the right-hand rotary switch/pushbutton  to highlight the symbol (20) and confirm by pressing.

## 146

Correcting the entry:

To delete the last character entered – press **DEL** briefly

To delete all of the characters entered – press **DEL** longer than 2 seconds.

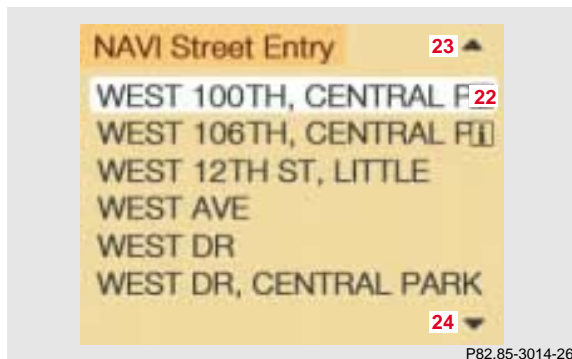

Press the right-hand rotary/pushbutton  longer than 2 seconds or highlight and confirm menu field (21).

If the street you select is saved on the CD more than once, a menu will appear for you to select the corresponding suburb of entered city.

**22** The street entered is highlighted

Call up next/previous page – use the right-hand rotary/pushbutton  to highlight symbol (23, 24) and continue to move in the corresponding direction:

**23** Previous page

**24** Next page

Turn the right-hand rotary/pushbutton  to highlight the desired street and press to confirm.

## Destination input

## Continue destination input

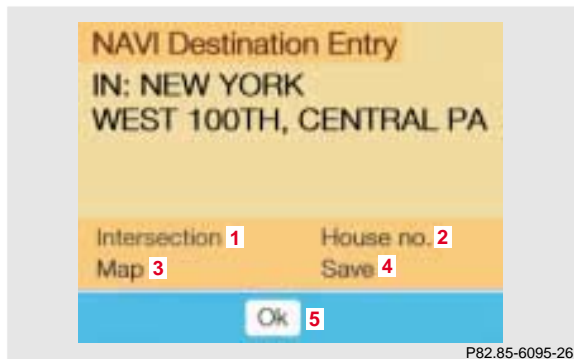



You can define your destination address more precisely by adding an intersection or a house number or by selecting it on the map.

If you do not want to add anything to your destination input, select the route calculation mode and have the route calculated, page 160.

## 148

Note:

Whether or not there is a menu field for the house number depends on the data stored on the navigation CD you are using.

Use the right-hand rotary/pushbutton  to highlight the menu field and press  to confirm:

- 1 Selecting an intersection, page 149
- 2 Entering the house number, page 150
- 3 Selecting a destination via the map, page 151
- 4 Saves the destination address in the destination memory, page 198
- 5 Confirms the destination, Select the route calculation mode and the route will be calculated, page 161

## Selecting an intersection

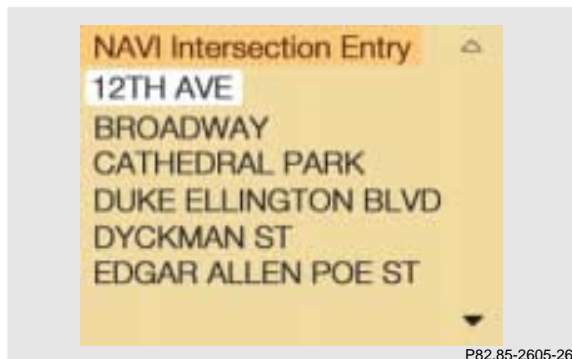

Use the right-hand rotary/pushbutton  to highlight the “Intersection” menu field in the menu (page 148) and press to confirm.

A list of roads intersecting with the previously input street will appear.

Use the right-hand rotary/pushbutton  to highlight the name of the junction on the list and press to confirm.



To confirm the destination:

Use the right-hand rotary/pushbutton  to highlight the “Ok” menu field and press it to confirm.

Then select the route calculation mode and calculate the route, page 161.



## Destination input

150

**Entering the house number**

In large cities, it is possible to enter a house number to make your destination more precise. It is possible, if the “House no.” menu field (page 148) is shown in black.

Use the right-hand rotary/pushbutton  to highlight the “House no.” menu field and press to confirm.

Use the right-hand rotary/pushbutton  to highlight the desired digits in the input menu one after the other and press the button to select the digits. Press the right-hand rotary/pushbutton  for a longer time to confirm the house number entered.

House numbers usually appear on the list in blocks, e.g. 1 - 5 (odd numbers), 42 - 50 (even numbers) or 1 - 50 (mixed).

Use the right-hand rotary/pushbutton  to highlight the desired block and press to confirm.

Then select the route calculation mode and calculate the route, page 161.

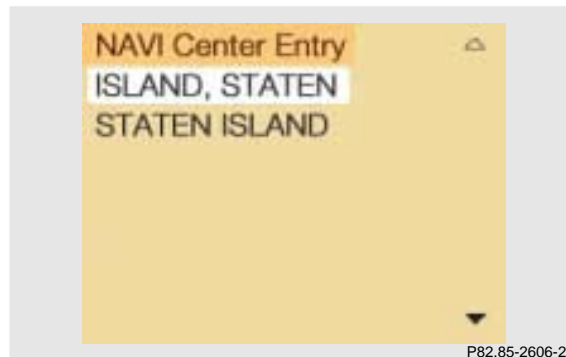
**Selecting a city center**

Use the right-hand rotary/pushbutton  to highlight the “Center” menu field in the main address menu (page 140) or after selecting a city/suburb (page 141) and press to confirm.

Use the right-hand rotary/pushbutton  to highlight the desired entry on the list and press to confirm.

Then select the route calculation mode and calculate the route, page 161.

## Selecting a destination via the map

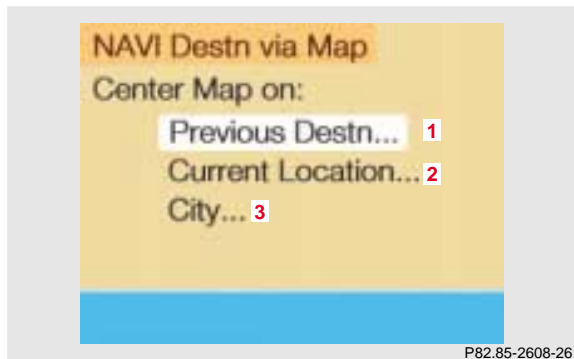

Use the right-hand rotary/pushbutton  to highlight the "Destn via Map..." menu field in the main destination input menu and press to confirm. A selection menu will appear.

The selection menu will not appear if you access the map from the menu (page 148). In this case, the map will appear immediately.

- 1 Activates the map with the center on the previous destination
- 2 Activates the map with the center on the current vehicle position
- 3 Activates the city entry menu, page 141

Use the right-hand rotary/pushbutton  to highlight the menu field and press to confirm. The map will appear.

To cancel your selection of the destination via the map:

Press **BACK** twice. The main destination input menu will appear.

## Destination input

152

## Moving the cross hairs



P82.85-3016-26

- 4 Street name or the name of the symbol (e.g. parking area/ -garage) that the cross hairs are centered on
- 5 Cross hairs to select the destination
- 6 Symbol for current vehicle location
- 7 Current map scale

During destination entry, the map will always appear facing north (north is up). The appearance of the map is dependent on the scale.



P82.85-3017-26

Use the number keys ❶ through ❹, ❸ through ❹ according to the corresponding arrows to move the cross hairs around the map:

- ❶ - Move to the top left
- ❷ - Move up
- ❸ - Move to the top right
- ❹ - Move to the left
- ❹ - Move to the right

- 7 - Move to the bottom left
- 8 - Move down
- 9 - Move to the bottom right

Notes:

Moving the cross hairs out towards the edge of the screen with the cursor keys activates an adjacent section of the map. It may take a few seconds to point to each new map.

Adjacent map sections overlap somewhat so that destinations on the edge of the map can be marked as well.



## Entering points of interest

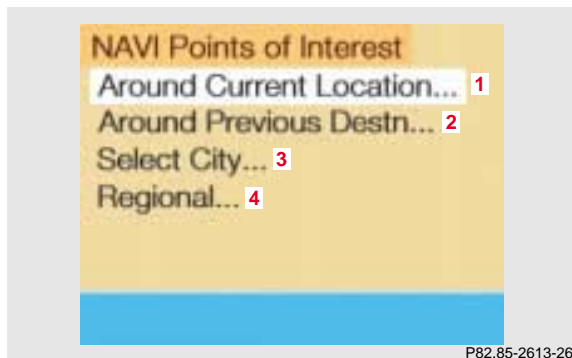

This function allows you to select such points of interest as gas stations, Mercedes-Benz Centers, parking facilities, shopping centers or airports.

Use the right-hand rotary/pushbutton  to highlight the "Point of interest..." menu field in the main destination entry menu and press to confirm. The Point of interest menu will appear.

Confirming the menu field:

- 1 Select a point of interest around the current area of vehicle location, page 156
- 2 Select a point of interest around the previous destination area, page 156
- 3 Select a point of interest in the surrounding area of another city, page 157
- 4 Select a regional point of interest, e.g. airport, page 158

### Selecting points of interest around current area of vehicle location or previous destination area



Use the right-hand rotary/pushbutton  to highlight menu field (1) or (2) in the points of interest menu and press to confirm.

Use the right-hand rotary/pushbutton  to highlight the desired category and press to confirm.

Note:

Not all Points of Interest may be listed on the CD.

5 Previous page - available when arrow is solid

6 Next page - available when arrow is solid

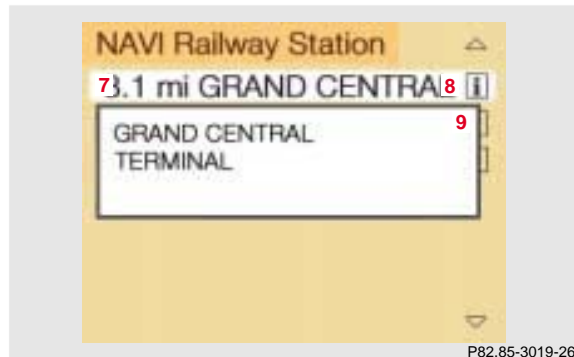

7 Distance to destination  
(point to point distance in miles)

8 Press **INF** to display the entry in full

9 Window displaying the complete entry  
Press **Z-** to remove the window

Use the right-hand rotary/pushbutton  to highlight the desired destination in the selection list and press to confirm. Then select the route calculation mode and calculate the route, page 161.

## Selecting points of interest in the area surrounding another city



Use the right-hand rotary/pushbutton  to highlight the menu field for “Select City ...” in the points of interest menu and press to confirm.

Use the right-hand rotary/pushbutton  to highlight the initial letters of the desired city one after the other and press to confirm.

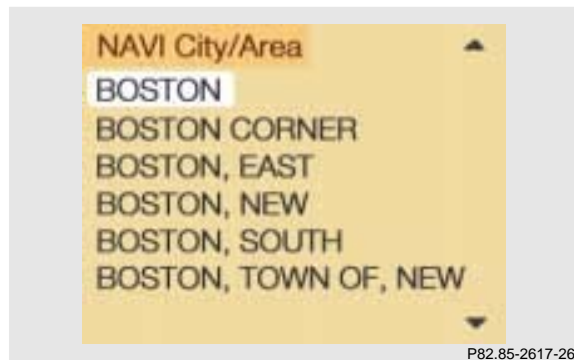

Structure of the input menu, page 141.  
Correcting the entry, page 141.



Activating the city list:

Press the right-hand rotary/pushbutton  longer than 2 seconds or highlight the “City list” menu field and confirm.

Moving to the next/previous page:

Use the right-hand rotary/pushbutton  to highlight the scrolling symbol and turn in the corresponding direction or confirm the symbol by pressing.  
Turn the right-hand rotary/pushbutton  to highlight the desired destination and press to confirm.

## Selecting regional destinations



P82.85-6100-26

If the city/suburb is stored only once on the CD, then the categories list will appear. Otherwise, another menu will appear first in which you must confirm the desired city/suburb again.

Select the desired category, page 156.

Note:

Not all points of interest may be listed on the CD.



P82.85-6101-26

Use the right-hand rotary/pushbutton  to highlight the “Regional...” menu field in the points of interest menu and press to confirm.

Use the right-hand rotary/pushbutton  to highlight the desired category and press to confirm.

Note:

Not all points of interest may be listed on the CD.

An input menu will appear.

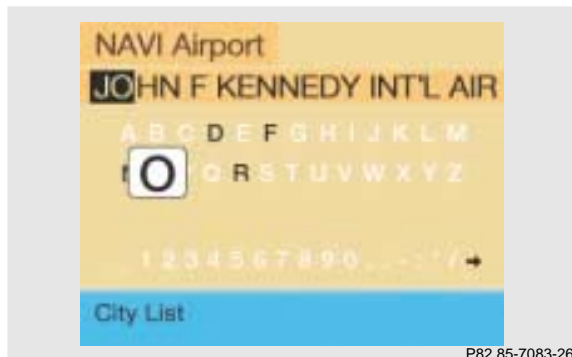

Use the right-hand rotary/pushbutton  to highlight the letters of the desired destination one after the other in the input menu and press to confirm.

The input line will automatically be populated with the first matching entry in the list. As subsequent characters are entered, the system will narrow the available list.

Structure of the input menu, page 141.  
Correcting the entry, page 141.

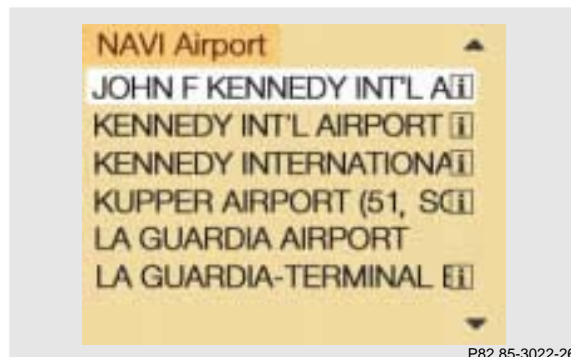

Activating the list:

Press the right-hand rotary/pushbutton  longer than 2 seconds or highlight the “List” menu field and confirm.

Moving to the next/previous page:

Use the right-hand rotary/pushbutton  to highlight the scrolling symbol and turn in the corresponding direction.

Turn the right-hand rotary/pushbutton  to highlight the desired destination and press to confirm.

Select the route calculation mode and calculate the route, page 161.

## Destination input

## Selecting the last destinations

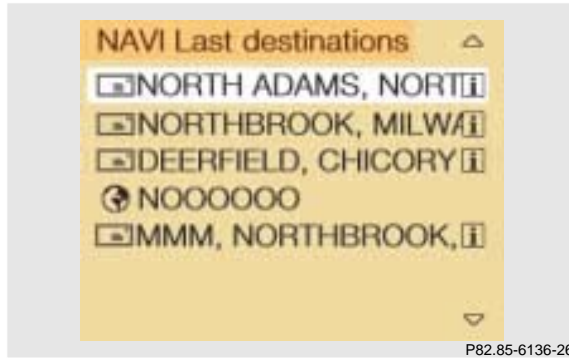

Use the right-hand rotary/pushbutton  to highlight the “Last destinations” menu field in the main destination input menu and press to confirm.

A list will be activated. The last 12 destinations entered will be displayed.

## 160

Use the right-hand rotary/pushbutton  to highlight the desired destination and press it to confirm your selection.

The route mode menu will appear.

Select the route calculation mode and calculate the route, page 161.

## Selecting the route calculation mode and calculating the route

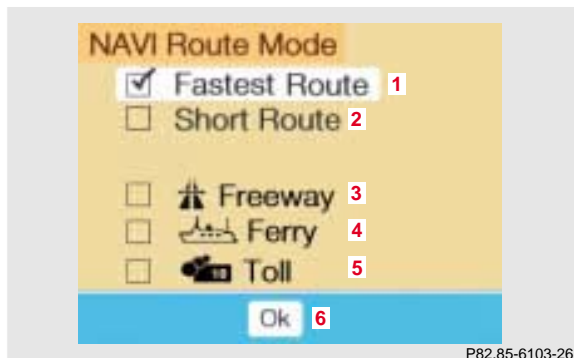

After you have entered your destination, select the route calculation mode and calculate your route.

Route calculation is performed either as the Fastest route (1) or Short route (2) whereby traffic routes (3), (4) and (5) can be included or avoided (several selections are available).

Use the right-hand rotary/pushbutton  to highlight the menu field and press the button to confirm your selection:

- 1  Route calculated for optimum driving time, p. 160
- 2  Route calculated for optimum driving route, p. 160

To include /avoid  traffic routes, several selections are available:

- 3  Calculate the route using freeways  
 Avoid freeways
- 4  Calculate the route using ferry connections, car trains  
 Avoid ferry connections, car trains
- 5  Calculate the route using toll roads  
 Avoid toll roads
- 6 The route will be calculated with the selected settings.

Calculate the route:

Press the right-hand rotary/pushbutton  longer than 2 seconds.

Note:

In the event that no reasonable alternate route for that destination exists, the route will be calculated including freeways, ferries and toll roads even if these selections are to be avoided.

## Calculate the route

162

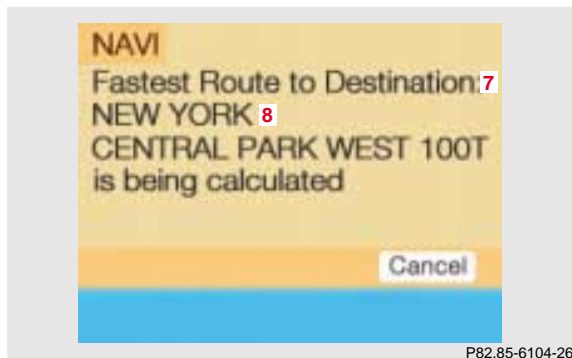

P82.85-6104-26

The menu on the screen indicates:

- 7 The method of calculation
- 8 The destination

You will hear the voice output "The route is being calculated".

To cancel route calculation:

Press **BACK** or press the right-hand rotary/pushbutton **●** to confirm the cancel menu field. The main destination entry menu will appear on the screen.



P82.85-6105-26

After a few seconds, the symbol display will appear:

- 9 The driving route is being calculated, other messages may also appear here during route guidance, page 163
- 10 Arrow indicating the direction to the destination (point to point distance), may also be displayed briefly during route guidance, e.g. if you are driving on roads/road sections that are not stored on the Navigation CD.
- 11 Distance to the destination (point to point distance)



The arrow indicating your driving direction will appear when the COMAND system has identified the road you are travelling on.

You will hear a message, such as “Please, make the next right turn”.

How route guidance works, page 164.

- 1 Name of the street onto which you should turn or distance from destination

Note:

As you approach a junction or interchange (e.g. I-695), the system will advise you the direction of travel to follow (e.g. North) as well as the name of the route.

- 2 Arrow indicating the driving direction, other symbols are also possible: arrow indicating the direction to the destination, symbol for new calculation of a route or destination flag
- 3 Name of the street on which you are travelling
- 4 The following may be displayed:
  - Distance bar to turn-off
  - Distance to the next turn in miles
  - Messages:
    - “OFF MAP” – the vehicle is located outside of the digitized map area
    - “OFF ROAD” – the vehicle is located on a road which is not digitized
    - “DEST AREA” – the vehicle is approaching the destination, the destination area is not digitized

“CALC. ROUTE” – a route is being calculated  
“NEW ROUTE” – an existing route is being recalculated  
“NO ROUTE” – system is unable to calculate a route

- 5 Activates the map  
While route guidance is in progress it is also possible to activate the map by pressing **MAP**.
- 6 Marking a way point, page 184
- 7 Mixture of map and symbol display, page 181
- 8 Activates the symbol display  
While route guidance is in progress it is also possible to activate the symbol display by pressing **MAP**.
- 9 Selecting map orientation:  
North orientation (North-up) or direction of travel at the top (Heading-up), page 183
- 10 Current map scale
- 11 Symbol for the current vehicle location with respect to route
- 12 Destination flag

## Route guidance

Route guidance is visual with screen displays and acoustic with voice outputs.

You can select the following screen displays during route guidance:

- Symbol display – always appears after a route has been calculated
- Map display – activate the map with menu field (5), switch back with menu field (8)
- Mix – before the vehicle makes a turn the COMAND switches automatically to the symbol display, and the map is displayed again once the turn has been completed

## 166

In the map display, menu fields (6), (8) and (9) are removed after 15 seconds. Turn the right-hand rotary/pushbutton  to display the menu field again.

## Requesting destination and route information

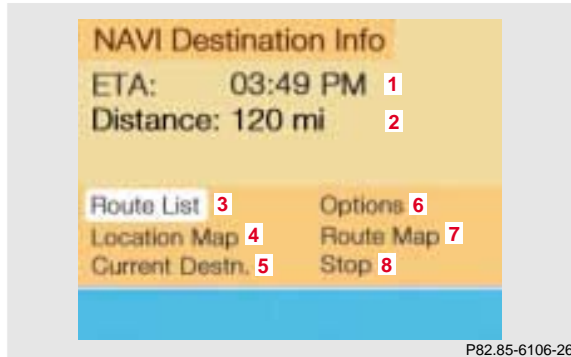

After the route has been calculated, it is possible to request destination and route information.

Press **INF**.

1 Estimated time of arrival

2 Distance from destination

Use the right-hand rotary/pushbutton  to highlight the menu field and press it to confirm:

3 Displays the route list, page 168

4 Displays the location map, page 169

5 Displays current destination, page 170

6 Requests the route mode, page 171

7 Activates the route map, page 172

8 Displays stop-over, page 173

Route guidance is switched off:

The last destination driven to will appear in line (1).

### Displaying the route list

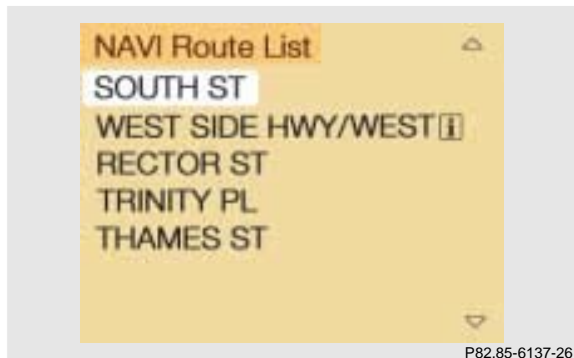

Turn the right-hand rotary/pushbutton  to highlight menu field (3) and press to confirm. The following message will appear: “Compiling Route List...”.

The route list contains a list of streets which will be travelled or which still lie ahead.

Press **INF** to display long entries in full in a window.  
Press **Z+** to remove the window from the screen.

Turn the right-hand rotary/pushbutton  to move to the next/previous page, move the cursor past the upper/lower scrolling symbol.

Press **BACK** twice to return to the symbol display or the map.

Notes:

The route list is updated during the trip, the display will indicate the streets which remain to be travelled.

If a longer route is calculated to avoid sections of the freeway (page 160), these freeways may still appear on the route list. As the vehicle approaches the freeway, it will be deleted from the list.

## Activating the location map

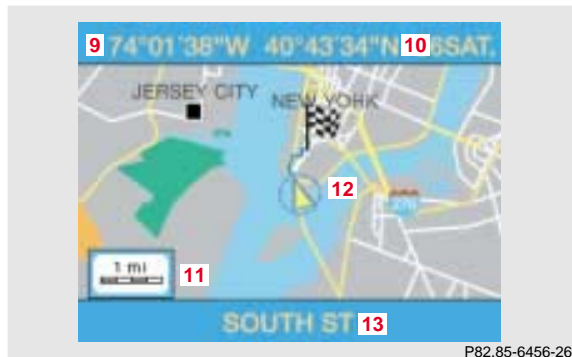

Turn the right-hand rotary/pushbutton  to menu field "Location map" (page 167) and press to confirm. The route map shows the general view for the whole route.

- 9 Geographical latitude and longitude for your current position
- 10 Number of satellites received
- 11 Scale of the last activation of the position map, Altering the map scale, page 182
- 12 Current vehicle position in the center of the screen
- 13 Name of the street you are currently travelling on

Press **BACK** twice to return to the symbol display or the map.

### Displaying the current destination



Use the right-hand rotary/pushbutton  to highlight the menu field “Current destination” in the menu (page 167) and press it to confirm.

Press **BACK** to return to symbol display or the map.

## Requesting the route mode

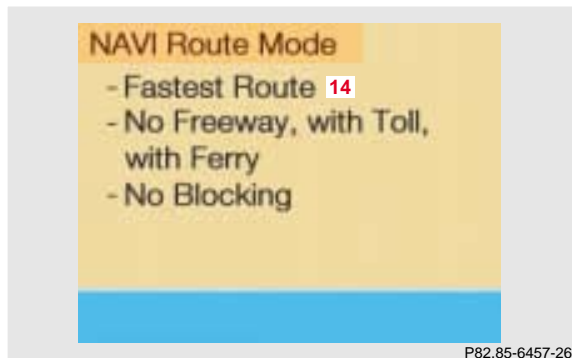

Turn the right-hand rotary/pushbutton  to menu field "Options" (page 167) and press to confirm.

**14** Indicates settings for the route calculation mode selected for the current route

Selecting the route calculation mode, page 160

Selecting a detour during route guidance, page 186

Marking a way point, page 183

Press **BACK** to return to the symbol display or the map.

The screen will return to this display automatically after 15 seconds.

## Route guidance

## Activating the route map

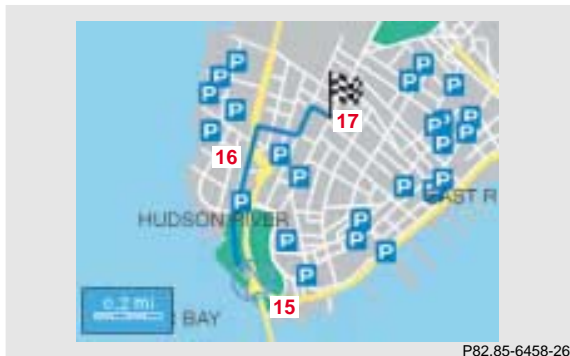

Turn the right-hand rotary/pushbutton  to menu field "Route map" (page 167) and press to confirm. The route map shows the general view for the whole route.

## 172

- 15 Current vehicle position
- 16 Route displayed as a blue line
- 17 Destination

The map scale selected depends on the route. The route map faces north.

Press **BACK** to return to the symbol display or the map.

## Displaying a stop-over

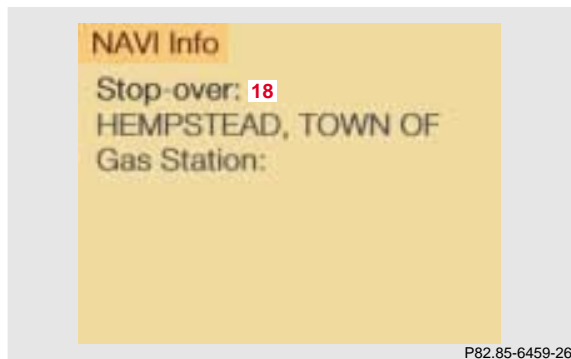

Use the right-hand rotary/pushbutton  to highlight the menu field "Stop" in the menu (page 167) and press it to confirm.

## 18 Stop-over

Place, type of stop-over and name

Note:

A stop-over will be displayed if this was previously selected.

### Beginning route guidance

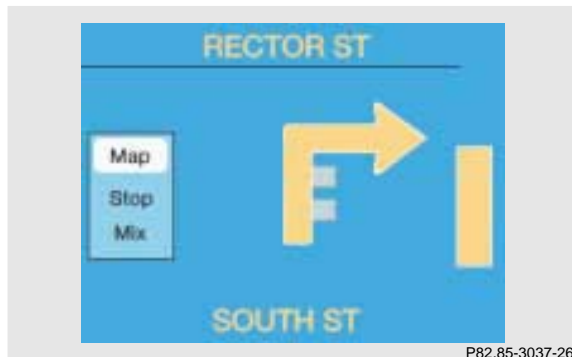

After the route has been calculated, the symbol display will appear. If you now are at the turn-off point, you will also hear a voice telling you, e.g. "Please turn right".

You can select screen display during the journey:

- Symbol display
- Switch between symbol and map display, page 179
- Route guidance with a mixture of map and symbol display, page 180

### Voice output during route guidance

During the trip, along with the visual information – symbol or map displays – COMAND also provides all of the necessary spoken route information via voice output.



#### Warning!

**Voice output is intended to direct you while driving without diverting your attention from the road and driving. Please always use this feature instead of consulting the screen symbols or map for directions while driving which may cause you to divert your attention from driving which can increase your risk of accident.**

Spoken recommendations are given:

- when route guidance begins,
- after the route has been calculated,
- before and during a change in the driving direction,
- when the destination or a way point has been reached.

If an audio source is switched on, e.g. the radio, the voice output is mixed with that of the audio source.

The audio volume differential between Voice output/Audio source can be set individually, page 69. During telephone/Tele Aid operation, navigation voice outputs are muted.

To repeat the current spoken recommendation:

Press the left-hand rotary/pushbutton  briefly.

To mute the current spoken recommendation:

Press **MUT** briefly during a voice output. The next announcement will be heard normally.

### Switching the voice output on/off

Press **MUT** longer than 2 seconds during a voice output.

The following message will appear on the screen: “Voice output is muted.”

The voice output will remain muted for the duration of the current route guidance.

Switch the voice output on again:

- Press the left-hand rotary/pushbutton 
- Automatically at the end of the current route guidance

Select the language for voice output, see the chapter on Info Services and system settings.

### Altering the voice output volume

While you are listening to a spoken recommendation, alter its volume by turning the left-hand rotary/pushbutton .

This setting will then affect all of following voice outputs.

Note:

During a voice output you can alter the sound level with the steering wheel keys as well:

 – Increase volume

 – Decrease volume

The minimum sound level depends on the current audio volume.

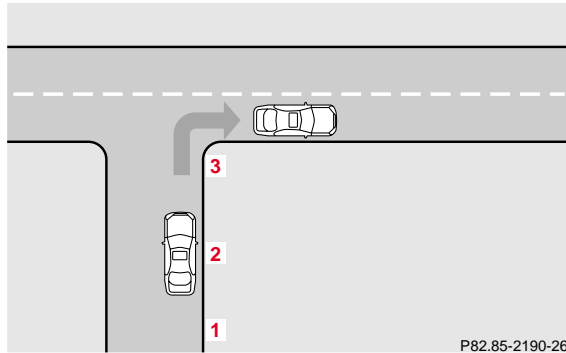
**Turning onto a street**

Traffic situation and voice output:

- 1 “Prepare to turn right.”
- 2 “Turn right after one quarter mile.”
- 3 “Please turn right.”

Note:

As you approach a junction or interchange (e.g. I-695), the system will advise you the direction of travel to follow (e.g. North) as well as the name of the route.

Manual recall of the current voice instruction:

Press the left-hand rotary/pushbutton .



6 Name of the street you are travelling on

7 Distance in miles to right turn

Note:

In special situations, e.g. when turning quickly several times in succession or traveling at high speeds, there may be deviations in the accuracy of the voice instructions.

Warning of right turn:

4 Name of the street you are to turn onto

Note:

As you approach a junction or interchange (e.g. I-695), the system will advise you the direction of travel to follow (e.g. North) as well as the name of the route.

5 Arrow indicating the driving direction

## Following the course of the road

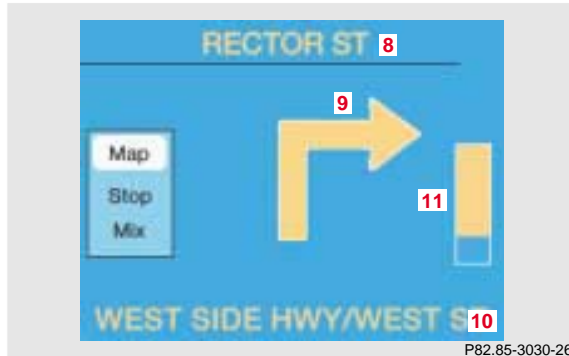

P82.85-3030-26

Just before a right turn:

- 8 Name of the street you will turn onto
- 9 Right-turn arrow
- 10 Name of the street you are now driving on
- 11 Distance graph to turning point, is reduced as you approach the intersection



P82.85-3031-26

- 1 Distance in miles to destination
- 2 Arrow indicating driving direction
- 3 Name of the street you are currently driving on
- 4 Distance in miles to next turn

## Driving through an intersection

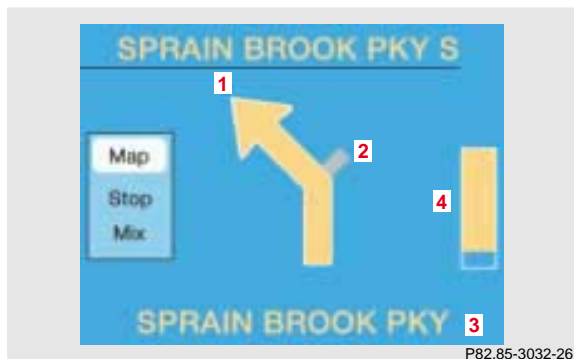

- 1 Name of the street onto which the vehicle is to be driven

Note:

As you approach a junction or interchange (e.g. I-695), the system will advise you the direction of travel to follow (e.g. North) as well as the name of the route.

- 2 Intersection

- 3 Name of the street you are now driving on
- 4 Distance graph to turning point

Before you drive through a intersection you will be informed of the continued route, e.g.

“Prepare to bear left”

“Bear left after one quarter mile”

“Please bear left”.

Notes:

In contrast to actually making a turn onto a street (page 176), the spoken recommendation, e.g. “bear left” will indicate that the course of the road will soon change, or the current road intersects another major road.

In the symbol display the road turn-off (2) indicates the part of the road which is not to be followed.

### Changing to map display during route guidance

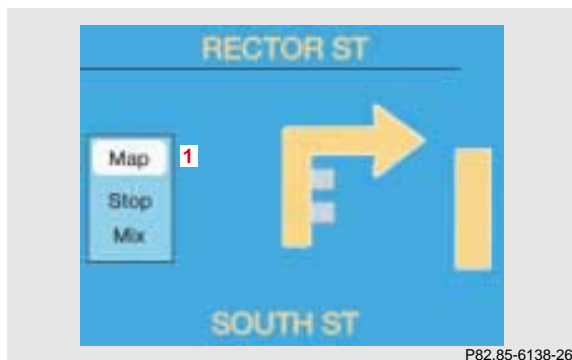

P82.85-6138-26

#### 1 Activate map display

There are two ways to switch to the map display during route guidance:

- Press **MAP**
- Confirm the menu field “Map” by pressing the right-hand rotary/pushbutton .

The map is activated in last scale you selected.



P82.85-3034-26

#### 2 Last scale selected

Altering the map scale, page 182

#### 3 Return to symbol display

Activate symbol display by pressing the right-hand rotary/pushbutton  or press **MAP**.

#### 4 Actual vehicle location

#### 5 Name of the street you will turn onto

After 6 seconds, the left-hand menu bar will disappear except for the scale. To recall the menu bar to the screen, press the right-hand rotary/pushbutton .

## Route guidance with a mixture of map and symbol display



Mix:

Before a turn-off, the symbol display is activated automatically from the map display. After you have made the turn, the map is displayed again.

Switching the mix function on:

Use the right-hand rotary/pushbutton  to highlight the menu field "Mix" in the symbol display and confirm by pressing. "Mix" is shown in red.



The symbol display is activated before you have to make the turn e.g. a U-turn. After you have made the U-turn, the display switches back to the map.

Switching the mix function off:

Use the right-hand rotary/pushbutton  to highlight the menu field "Mix" in the map or symbol display and confirm by pressing. "Mix" is shown in black.

### Altering the map scale



P82.85-2638-26

To activate the scale bar (2), select one of the following methods:

- Press **Z+** or **Z-**
- Use the right-hand rotary/pushbutton  to highlight the scale menu field (1) and confirm by pressing.

**1** Current map scale

**2** Scale bar

**3** New scale



P82.85-2639-26

Increase the map scale (activate a more detailed map):

Press **Z+** or turn the right-hand rotary/pushbutton  to the left.

Reduce the map scale (activate a less detailed map):



Press **Z-** or turn the right-hand rotary/pushbutton  to the right.

Note:

A division mark corresponds to an available scale. There are 12 different scales ranging from 0.1 miles/inch to 500 miles/inch.

## Selecting map orientation



- 1 Select map orientation:  
North arrow  - The map is displayed facing due north (North-up).  
Compass needle  (black tip pointing to the north)  
- The map is displayed facing driving direction pointing up (Heading-up).
- 2 Symbol for the current vehicle position



To select Heading-up:

Use the right-hand rotary/pushbutton  to highlight menu field (1) and press to confirm. The symbol (2) points in the driving direction.

To return to North-up:

Use the right-hand rotary/pushbutton  to highlight the menu field (1) and press to confirm. The north arrow is displayed again.

## Marking a way point



### 1 Activate Way point menu

During route guidance it is possible to store a way point.

Use the right-hand rotary/pushbutton  to highlight button (1) in the symbol display and press to confirm.

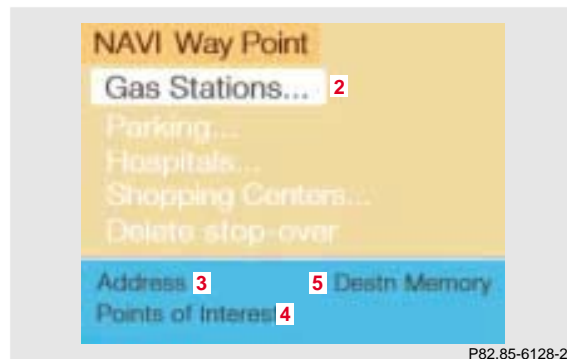

- 2 Select gas station, parking, hospitals or shopping centers from a list.  
Not all Way Points may be listed on the CD.
- 3 Activate the Destination entry menu,  
Entering destination address, page 140
- 4 Activates the “Point of Interest” menu,  
page 155
- 5 Activates the destination memory, page 196

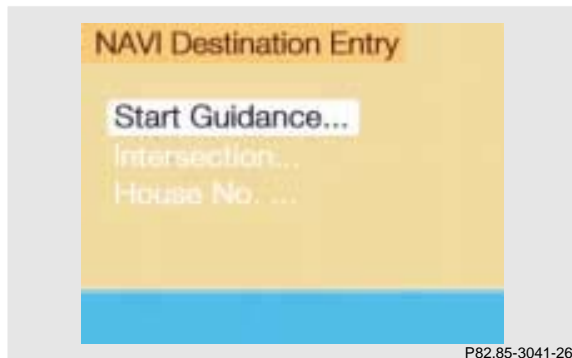

To begin route guidance:

Press the right-hand rotary/pushbutton  to confirm the "Start Guidance ..." menu field.

Note:

After an address has been entered, the "Intersection..." and "House No. ..." menu fields may appear in black, indicating that it is possible to select them.

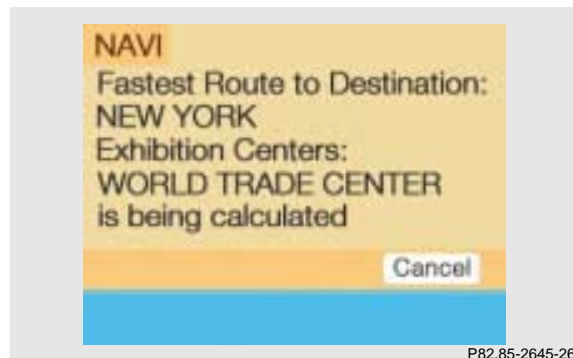

You will now see information on the screen. Voice output: "The route to your intermediate destination is being calculated".

Cancel the calculation:

Press the right-hand rotary/pushbutton  and confirm the menu field "Cancel".

Notes:

The previously selected route mode is retained.

After you reach the way point, you will continue to follow the route to the original input destination.

## Route guidance

## Delete way point

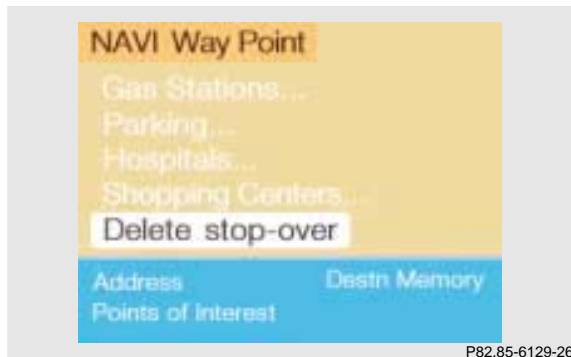

Use the right-hand rotary/pushbutton  to highlight the menu field “Stop” in the symbol or map display and confirm by pressing.

Note:

If the menu bar is not visible in the map, turn the right-hand rotary/pushbutton  to display it on the screen.

## 186

When the menu is activated, the menu field “Delete stop-over” is highlighted.

Press the right-hand rotary/pushbutton  to confirm.

To abort cancelling the way point:

Press **BACK** to return to the route guidance.

Note:

It is also possible to delete a way point in the menu (page 191).

## Selecting a detour during route guidance



Press **DTR** while any menu is on the screen during route guidance.

The main detour menu will appear on the screen.

- 1 Route sections ahead can be blocked in order to calculate a detour

Use the right-hand rotary/pushbutton  to highlight the menu and confirm by pressing.

- 2 Ends the detour function, the previous route will be calculated

Traffic Jam Ahead/Detour in Route List not activated:

“Cancel” menu field cannot be selected.

Traffic Jam Ahead/Detour in Route List activated:  
“Cancel” menu field is marked.

- 3 Sections of the route can be blocked in the route list, page 189

Note:

Traffic jams are identified by the driver, not by the navigation system.

## Route guidance

## Traffic jam ahead

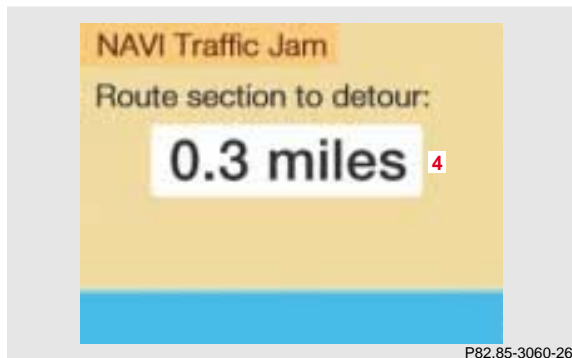

Press the right-hand rotary/pushbutton  to confirm the “Traffic Jam Ahead...” menu field highlighted in the main detour menu.

- 4** The window is highlighted when it appears, indicates the length of the blocked route section in km or m, reasonable sections of road are suggested

Minimum/maximum length of detour is governed by the logical grouping of route sections. If additional detour segments are required after the original detour, they must be requested individually.

## 188

Enter the length of the road section you want to block.

Increase the blocked section:

Turn the right-hand rotary/pushbutton  to the right.

Decrease the blocked section:

Turn the right-hand rotary/pushbutton  to the left.

To calculate the detour:

Press the right-hand rotary/pushbutton  to confirm your selection.

The route will be re-calculated. An information menu will appear on the screen.

Then route guidance will continue.

Note:

The “Traffic Jam Ahead...” menu field can also be selected during the course of a detour. The current block to be avoided will then be cancelled.

## Detour in route list

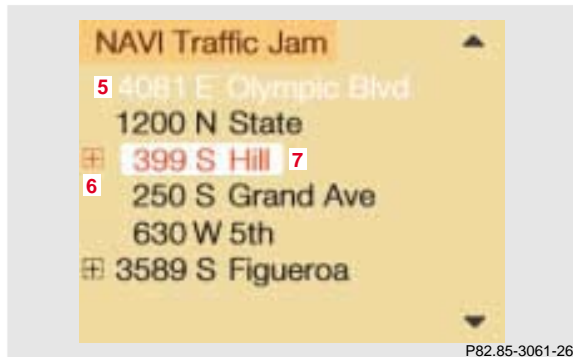

Turn the right-hand rotary/pushbutton  to highlight the “Detour in Route List...” menu field in the main detour menu and press it to confirm.

The following message will appear: “The route list is being calculated”.  
Then the route list will appear on the screen.

Activating the detour function:

Press the right-hand rotary/pushbutton . The street marked will appear in red.

- 5 Street cannot be blocked off
- 6 “+” symbol – Street contains several sections which can be blocked off
- 7 Blocked street will appear in red

Press **Z+** to access the detailed route list, page 187

Press **INF** to display longer entries in a window in full.

Press **Z+** to remove the window from the screen.



P82.85-3062-26

The detailed route list will appear on the screen:

- 8 “-” symbol – Street sections for one street are on display

To block off several streets/street sections:

Turn the right-hand rotary/pushbutton  to the right. With each turn the following street name will appear in red.

To cancel the blocks:

Turn the right-hand rotary/pushbutton to the left. The street name will return to black lettering.

To return to the route list:

Press  – the “+” symbol appears in front of the street name.

The blocking function is still active.

Cancelling the blocks, do not re-calculate the route:

Press . The tailback menu will appear on the screen.

Ending the blocking function, recalculate the route with the blocks selected:

Press the right-hand rotary/pushbutton .

The route will be recalculated using the previously selected route calculation mode. A corresponding message will appear on the screen.

The symbol display will now appear on the screen and route guidance will continue.

## Resetting functions during route guidance



Press **DEL** during route guidance.

Use the right-hand rotary/pushbutton  to highlight the desired menu field and press it to confirm.

- 1 Delete a way point
- 2 Cancels a detour (traffic jam ahead)  
Selecting a detour during route guidance, page 187

- 3 Cancels a detour (road sections blocked in the route list, page 189)
- 4 Resets all functions

The route will be recalculated using the previously selected calculation mode. The corresponding information will appear on the screen.

Then the symbol display will appear and route guidance will continue.

Note:

Menu fields (2) and (3) are not available if no detour has been selected.

### Deviating from the calculated route



If you deviate from a recommended route, the system automatically calculates a new route from the current vehicle location to the requested destination.

If applicable, the message: “NEW ROUTE” will appear on the screen along with an arrow outline indicating the driving direction.

After the new calculation has been completed, route guidance will continue. The arrow indicating the driving direction will appear as usual.

### Reaching your destination



When you reach the destination you will see the destination flag in the display.

You will hear the voice output “You have reached your destination”.

The main destination input menu is then activated and you can now enter another destination.

Note:

When you approach and arrive at way points, you will hear acoustic notices and this will also be shown in the display.

## Activating audio system



During route guidance (the symbol or map display is shown), it is possible to select another COMAND system by pressing the corresponding buttons.

The corresponding main menu will appear and e.g. audio playback will be started. Route guidance and the navigation's voice output remain active.

The voice output is added to the audio playback. The volume levels for voice output and audio playback can be adjusted individually, page 69.



Press e.g. **FM/AM**.

The main radio menu will appear, the system will tune into the station played last. Selecting a station, page 24.

Press **NAVI** or **MAP** to return to the Navigation system.

## Route guidance

194

## Activating audio functions during route guidance

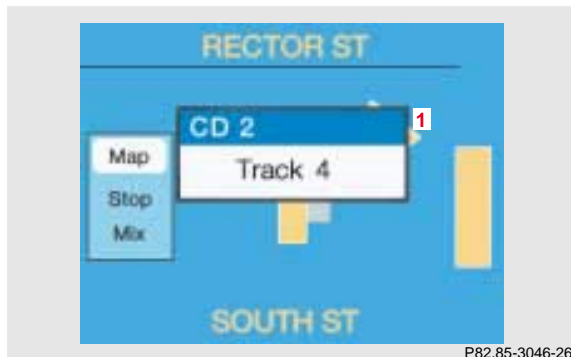

While the symbol or map display is active, it is possible to operate an audio source in the background under limited conditions without having to activate the corresponding system.

- 1 The window is shown in the symbol or map display with the active audio source indicated

The window is removed:

- Automatically after 3 seconds
- Press **BACK**.

The radio is on:

- Select the memorized station from the respective memory (FM, AM or WB) with the number keys **1** through **0**
- Press **◀** / **▶** briefly: Station seek is performed
- Hold one of the keys **◀** / **▶** for more than 2 seconds: A manual search is started in the direction you selected (frequency ranges FM, AM or WB)

The CD is on:

- Select CD with numbers key:
  - 0** - CD drive
  - 1** through **6** - CD changer
- Press **◀** / **▶** briefly: Select previous/next track
- Hold one of the keys **◀** / **▶** for more than 2 seconds: Skip backwards/forwards

## Cancelling route guidance



If you want to cancel route guidance press **NAVI** while the map or the symbol is being displayed.

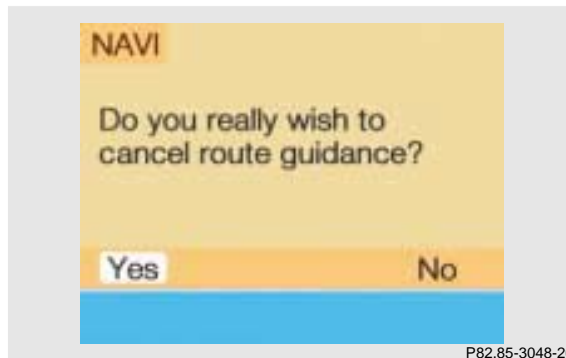

Press the right-hand rotary/pushbutton  if you want to cancel route guidance. The main destination input menu will appear.

Continue route guidance:

Press **BACK** or turn the right-hand rotary/pushbutton  to highlight the menu field "No" and press to confirm.

The map or the symbol display will be reactivated.

The principle of route guidance

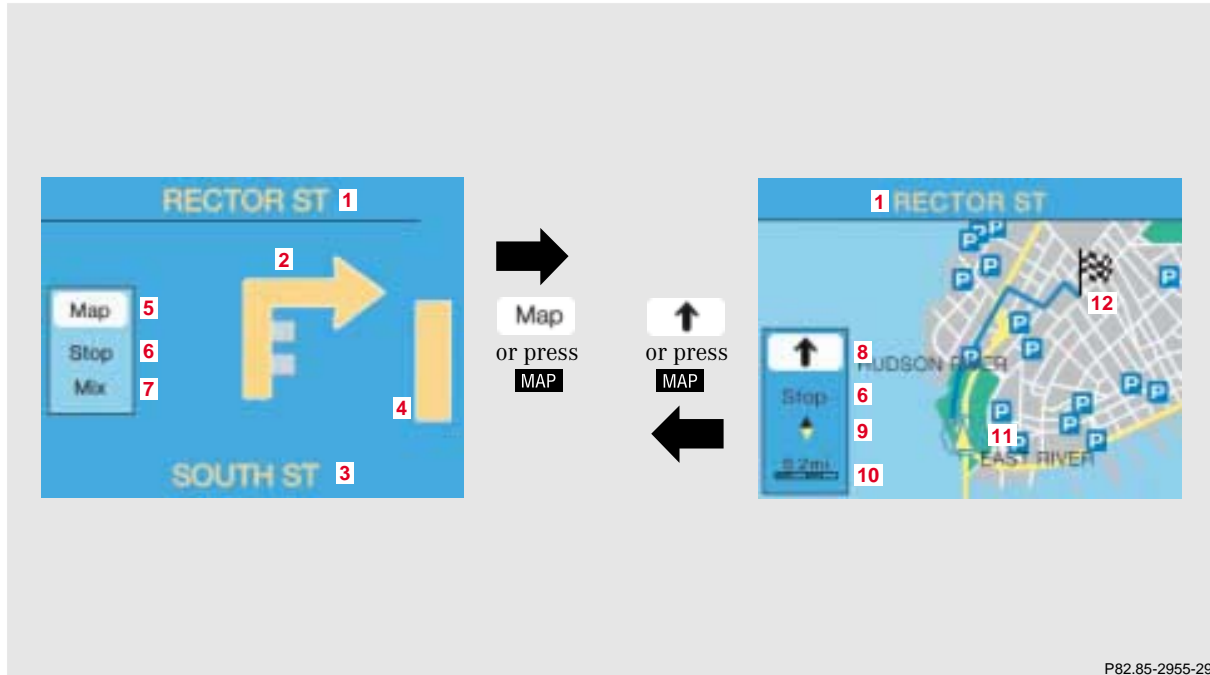

### Activating the main destination memory menu

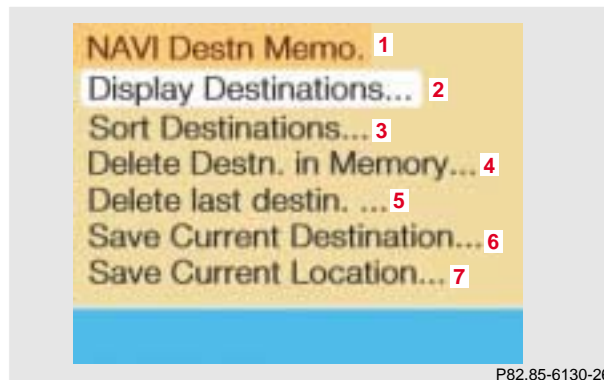

Use the right-hand rotary/pushbutton  to highlight the “Destn Memory” menu field in the main destination input menu and press to confirm.

- 1 Info/status line
- 2 Activates the destination list, page 197
- 3 Sorting the destinations, page 201
- 4 Deleting a destination in the destination memory, page 202
- 5 Deleting the last destination
- 6 Saving the current destination, page 198
- 7 Saving the current vehicle location with a name, page 200

## Retrieving a destination from the destination memory

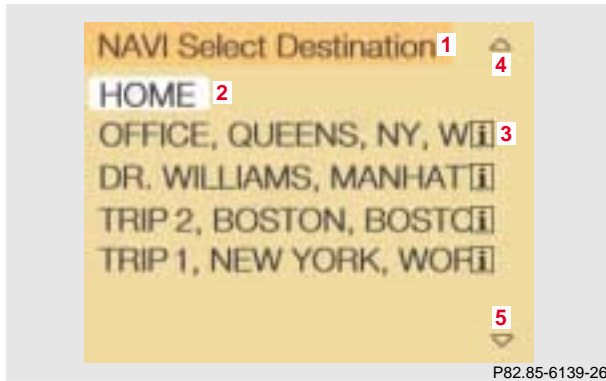

Turn the right-hand rotary/pushbutton  to highlight the “Display Destinations...” menu field and press to confirm.

- 1 Info/status line
- 2 Highlighted entry
- 3 Press the **INF** key – a long entry will display in full in a window, press **INF** again to remove the window
- 4 Previous page  
An empty triangle marks the start of the list
- 5 Next page  
An empty triangle marks the end of the list

Use the right-hand rotary/pushbutton  to highlight the desired entry and press to confirm.

Select the route calculation mode and calculate the route, page 161.

### Saving the current destination in the destination memory

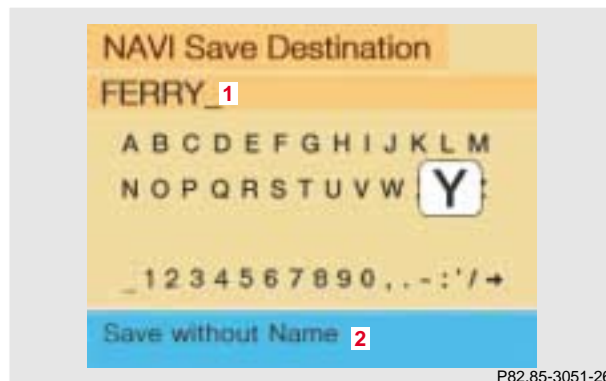

Use the rotary/pushbutton  to highlight the “Save Current Destination...” menu field in the main destination memory menu and press to confirm.

- 1 Name entered
- 2 Saves the destination without entering a name

Save the destination with a name:

Turn the right-hand rotary/pushbutton  to highlight the desired letter in the alphabet and press to confirm, the letter selected will appear in the input line. Enter the other letters.

When you have completed the name, press the right-hand rotary/pushbutton  for more than 2 seconds. This will activate the destination memory.

Note:

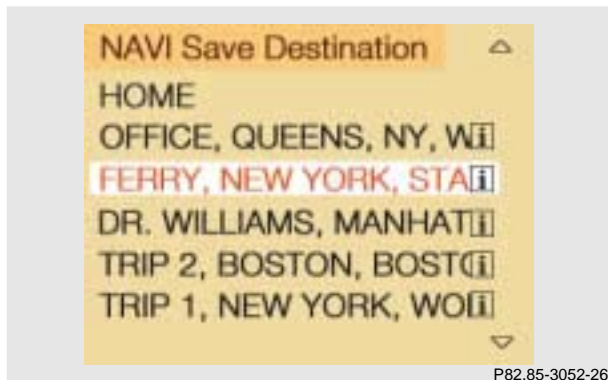

If the destination memory is full, a corresponding message will appear. Press the right-hand rotary/pushbutton . This will activate the destination memory.

Deleting a destination in the destination memory, page 202.



Save the destination without entering a name:

Turn the right-hand rotary/pushbutton  to highlight the “Save without Names” menu field and press to confirm.

In the user sorted list, the newly input location is highlighted and in red. Using the right-hand rotary/pushbutton , the entry can be located anywhere in the list. Use the right-hand rotary/pushbutton  to move the entry to the desired point in the list and then confirm by pressing.



Entry will change from red to black.

The main destination input menu is activated, the menu field “Start Guidance...” is highlighted.

Note:

The destination can also be saved directly after it is entered during the selection of the route.

### Saving the current vehicle location in the destination memory

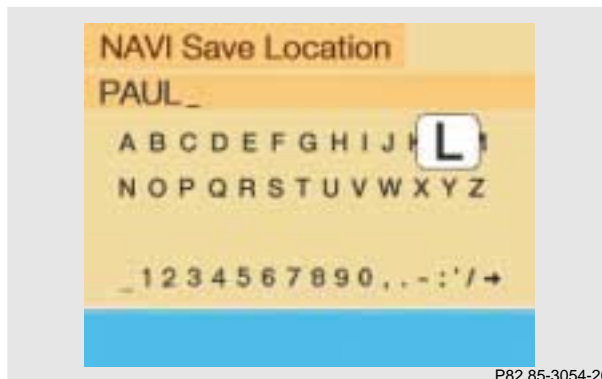



Using this function it is possible to save the current vehicle position in the memory. You will have to name it to be able to retrieve it at a later date.

Turn the right-hand rotary/pushbutton  to highlight the “Save Current Location...” menu field in the main destination memory menu and press to confirm.

An input menu will appear.

Save the destination with a name, page 198.

Press the rotary/pushbutton  longer than 2 seconds to store the destination.

Use the right-hand rotary/pushbutton  to move the entry to the desired memory location in the list. Press the right-hand rotary/pushbutton  and confirm your selection.

The main destination input menu is activated.

## Sorting the destination memory

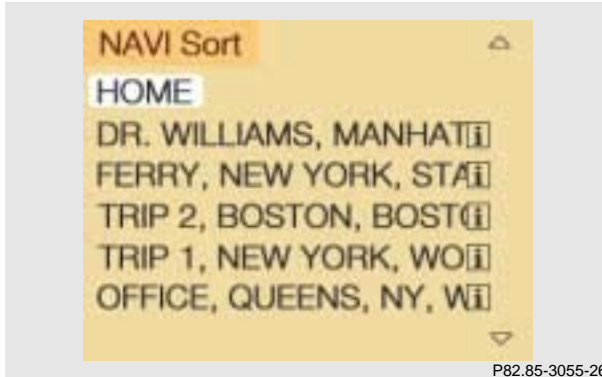

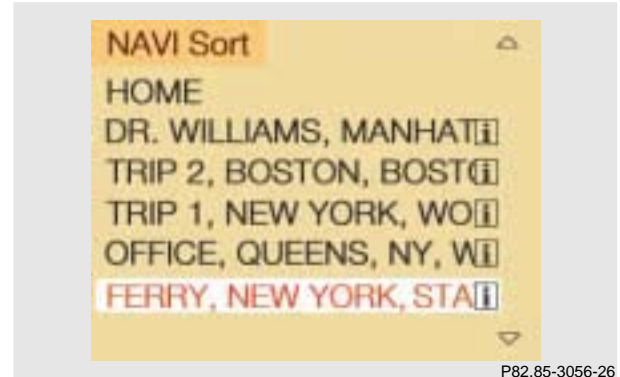

Activate the destination list:

Turn the right-hand rotary/pushbutton  to highlight the “Sort Destinations...” menu field and press to confirm.



Use the right-hand rotary/pushbutton  to highlight the desired entry and press to confirm. The entry is now shown in red.

Use the right-hand rotary/pushbutton  to move the entry to the desired position.

Press the right-hand rotary/pushbutton  to save the entry at that location. The entry is shown in black, the main destination memory menu for saving destinations is reactivated automatically.

### Deleting a destination in the destination memory

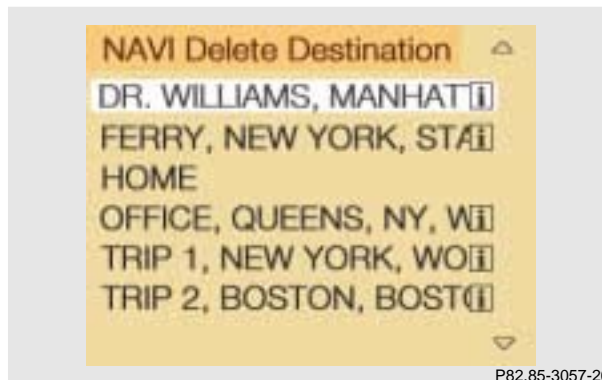

Turn the right-hand rotary/pushbutton **⬇️** to highlight the “Delete Destination...” menu field in the main destination memory menu and press to confirm.

The first entry is highlighted.

Turn the right-hand rotary/pushbutton **⬇️** to highlight the entry you wish to delete. Press **DEL**.

The following inquiry will appear on the screen: “Do you really want to delete the destination?”.

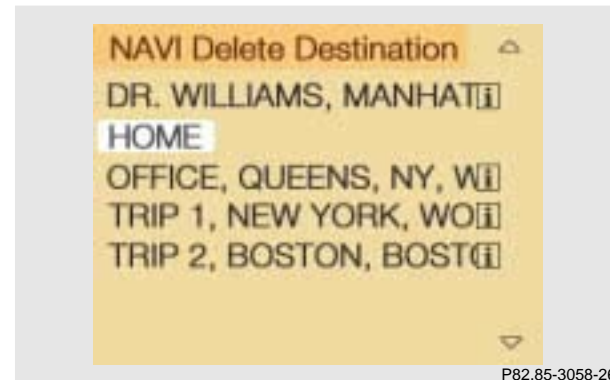

If you do not want to delete the destination:

Turn the right-hand rotary/pushbutton **⬇️** to highlight the “No” menu field and press to confirm.

To delete the destination:

Press the right-hand rotary/pushbutton **⬇️** to confirm the “Yes” menu field. The entry will be deleted from the list, the following entries will each move up one position. The delete function is still active.

Press **BACK** to activate the main destination memory menu.

## Entering the vehicle position

It is only necessary to enter the vehicle position when the system is not able to position itself automatically with the GPS.

It is only possible to enter the vehicle position in connection with a crossroad.

Use the right-hand rotary/pushbutton  to highlight the menu field “Settings” in the main destination input menu and confirm by pressing.

In the “Settings” menu (page 204) use the right-hand rotary/pushbutton  to select the menu field “Location...”. This activates the menu for entering the location.

Now enter the city/suburb and street in the menu and select the required entries from the respective lists. See page 141 for how to enter a destination address.

After you have selected the street, you will see a prompt for the intersection. Highlight the appropriate cross street with the right-hand rotary/pushbutton  and confirm by pressing.

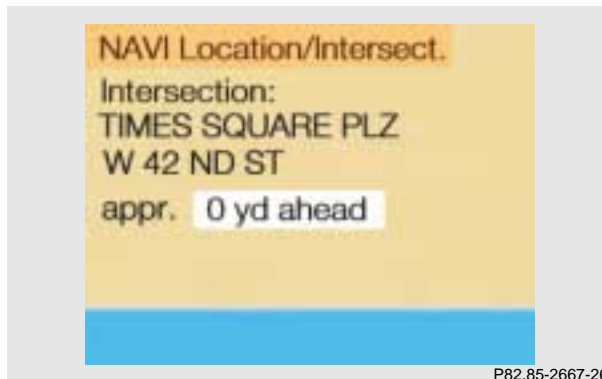

Set the vehicle’s current position in the following menu.

Actual position is in front of a junction:  
Turn the right-hand rotary/pushbutton  to the right.

Actual position is behind a junction:  
Turn the right-hand rotary/pushbutton  to the left.

Press the right-hand rotary/pushbutton  to accept selected position. The message “Chosen location accepted” will be displayed and will automatically disappear in 3 seconds.

## Calibration

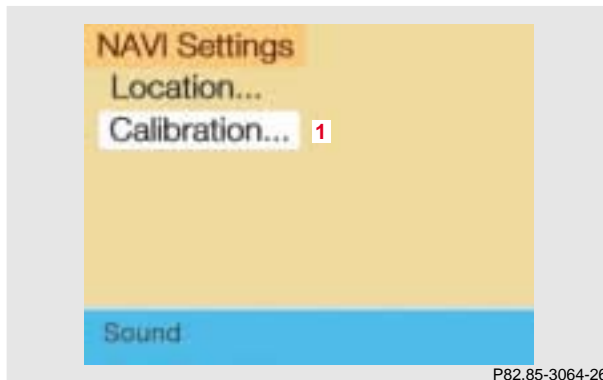



In order to ensure an exact fix on position, COMAND must be calibrated to new tires every time tires are changed.

Highlight the menu field “Settings” in the main destination input menu with the right-hand rotary/pushbutton  and confirm. A menu of options will appear.

Highlight the menu field “Calibration” with the right-hand rotary/pushbutton  and confirm by pressing:

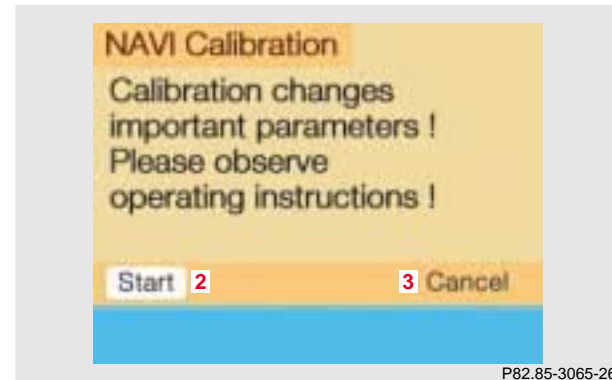
- 1 Activates the entry menu “Calibration”



Highlight the desired menu field with the right-hand rotary/pushbutton  and confirm by pressing:

- 2 Enter the tread depth and the tire type, page 205 press the right-hand rotary/pushbutton  to start
- 3 Return to the main destination input menu

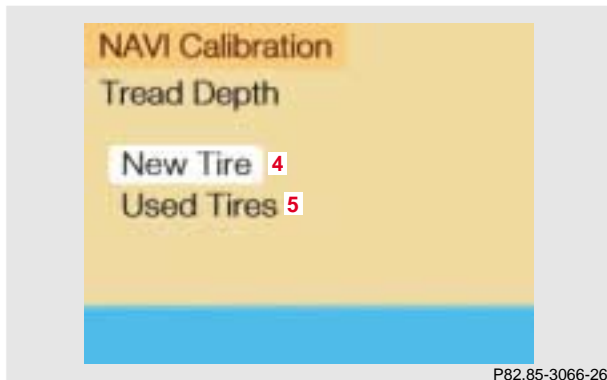

Enter the tread depth in the options menu.

For change of front tires:

- 4 tread depth  $\geq$  4mm (3/16 in.)
- 5 tread depth  $<$  4mm (3/16 in.)

Highlight the proper menu field with the right-hand rotary/pushbutton  and confirm by pressing.

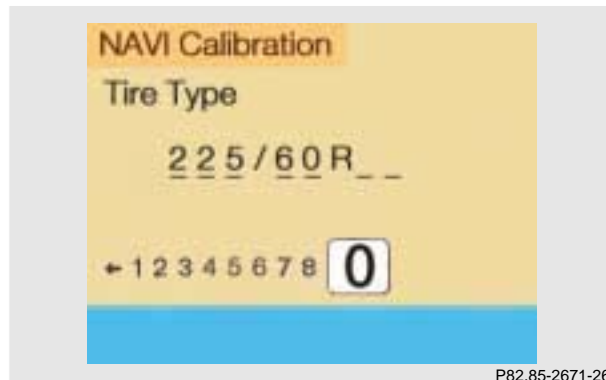

Enter the new tire type in the following menu.

Enter the appropriate digits one by one into the entry line. Mark by turning the right-hand rotary/pushbutton  and confirm your choice by pressing.

Confirm entry by keeping the right-hand rotary/pushbutton  depressed for 2 seconds. The main destination input menu will appear.



## **Info Services and system settings**

Info Services .....	208
Requesting and displaying Info Services .....	208
System settings .....	211
Activating the main system settings menu .....	211
Adjusting the brightness .....	212
Activating Settings menu .....	213
Selecting the language .....	214
Set the date and time .....	215
Switching beep tones on and off .....	222
Setting changeover between day and night display .....	223
Reset all settings to the factory settings .....	224
Auxiliary audio source .....	225

### Requesting and displaying Info Services

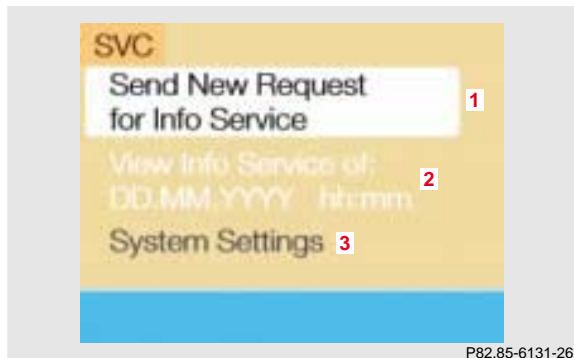

Press **SVC** in any menu.  
The main service menu will appear.

- 1 New information service is requested from provider, page 209

Note:

The characters are displayed in light grey during active request transmission.

- 2 Shows date and time of the message, a list (page one) of all received messages will appear, move to the next message by pressing the right-hand rotary/pushbutton 

Info Services categories include news, weather, stocks, sports and reminders. Choices can be selected via [www.MBUSA.com](http://www.MBUSA.com) or by calling 1-800-FOR-MERCEdes.

Note:

If no information is available, the characters are displayed in light grey.

- 3 The main system settings menu will appear, page 211

Note:

Before you can use Info Services, Tele Aid must be activated at the Response center and Info Services selected.

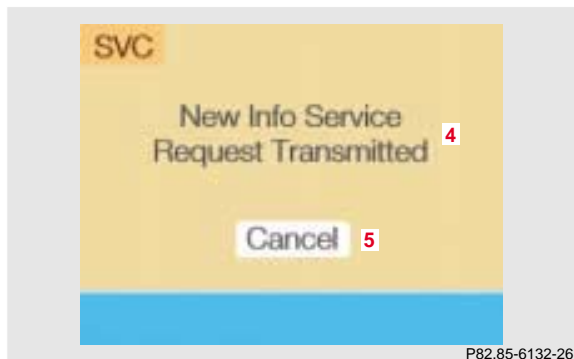

- 4 This message appears, a beep tone will be heard if there is a new incoming message

There are three ways to switch to a main menu (e.g. radio main menu) before the **SVC** key was pressed:

- Press the right-hand rotary/pushbutton ●
- Press **BACK**
- automatically after 15 seconds.

- 5 Cancels the request

Note on (4):

In the following situations it is not possible to make a request and the following messages appear:

- “Data Connection Cannot be Established” – request has failed because Response Center cannot be accessed
- “No Cellular Connection Available” – vehicle may be in a cellular weak signal area
- “Cellular System Busy” – request has failed because cellular system is busy, try again later
- “Data transmission failure” – request has failed because a data transfer error has occurred, try again
- “Tele Aid Call in Progress!” – request has failed because SOS or Roadside call is in progress.
- “Tele Aid. Please visit workshop” - a hardware error has been detected. Contact M-B Center.
- “To subscribe to information services dial phone number” - you have not yet subscribed to service
- “No information available at this time. Press SVC button later” - no new information is available

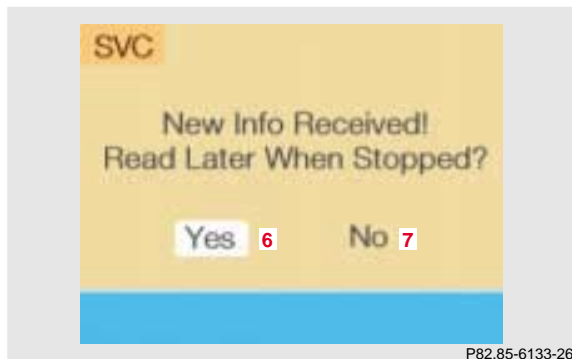

- 7 Switches back to the main menu (e.g. radio main menu)

- 6 Displays the new message

There is more than one message:

Move to the next message by pressing the right-hand rotary/pushbutton .

To activate the main service menu, page 208:

Press **BACK**.

## Activating the main system settings menu

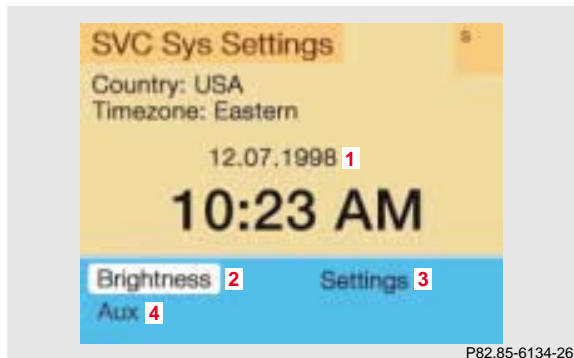

Press **SVC** in any menu.

The main system settings menu is loaded.

- 1 Information on the date, time  
Format depends on the time format selected,  
to select the time format, page 221
- 2 Adjusting the brightness, page 212
- 3 Accessing the settings menu, page 213
- 4 Switching on an external audio source, e.g. a tape  
deck, page 225

- 5 Country setting,  
the time zone can also be displayed

Note on (5):

Information is shown if the clock has been set to GPS reception and if a country, e.g. USA, Canada and time zone was selected, page 218.

Setting the clock with GPS reception, page 216.

## System settings

## 212

## Adjusting the brightness

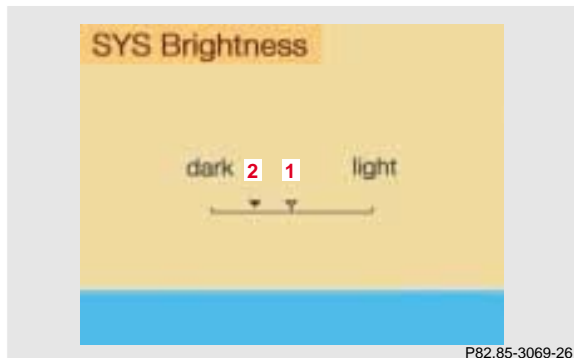

Use the right-hand rotary/pushbutton  to highlight the “Brightness” menu field and press to confirm. The Brightness menu will appear.

- 1 Previous setting
- 2 Current setting

To darken the screen:

Turn the right-hand rotary/pushbutton  to the left, the triangle (2) moves to the left.

To brighten the screen:

Turn the right-hand rotary/pushbutton  to the right, the triangle (2) moves to the right.

To confirm the new setting:

Press the right-hand rotary/pushbutton . The main system settings menu will now appear.

## Activating Settings menu

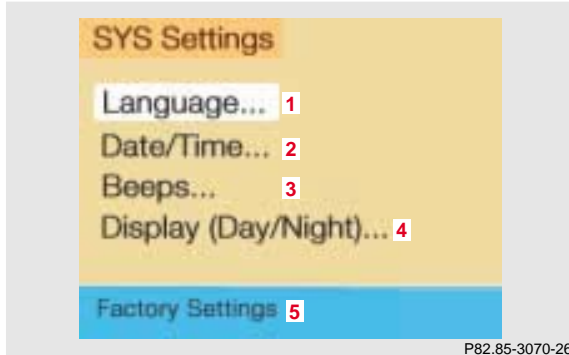

- 1 Selects the language, page 214
- 2 Sets the date and time, page 215
- 3 Switches the beep tones on and off, page 222
- 4 Setting changeover between day and night display, page 223
- 5 Activates factory settings, page 224

Use the right-hand rotary/pushbutton  to highlight the “Settings” menu field in the main system settings menu and press to confirm.

The settings menu will appear.

## System settings

## 214

## Selecting the language

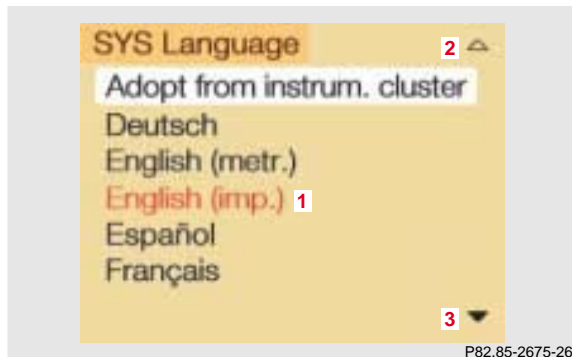

Press the right-hand rotary/pushbutton  to confirm the highlighted “Language...” menu field in the settings menu.

The languages list will appear.

- 1 Current language setting appears in red
- 2 Page back, if the arrow is filled in
- 3 Page forward for more languages

Use the right-hand rotary/pushbutton  to highlight the desired language and press to confirm.

The message “Loading the xx language” will be displayed.

The language selected will be loaded.

You will hear the corresponding voice output.

Note:

The language affects the menu text displays and the voice output during route guidance.

After the language has been loaded, the main system settings menu will appear with the display text in the language selected.

List of languages:

- “Adopt from Instrument Cluster” – the system will use the same language as is set in instrument cluster
- “Deutsch”
- “English (metric)” – distance measured in km, speed in km/h
- “English (imperial)” – distance measured in yards, miles, speed in mph
- “Español“
- “Français“
- “Italiano“
- “Nederlands“

### Set the date and time

COMAND is equipped with an integrated clock. Press **SVC** to display the current time. The clock is used e.g. for indicating the estimated time of arrival at the destination, page 167.

There are several ways to set the time:

- With GPS reception, page 216

Set the time in 30 minute steps, page 217

Set the time by selecting a country and the time zone, page 218

- Without GPS reception, page 216

Set the date and time manually, page 220

Note:

The clock must always be reset if the COMAND system was disconnected or if the vehicle battery was discharged.

## With GPS reception



Use the right-hand rotary/pushbutton  to highlight the “Date/Time ...” menu field in the “Settings” menu (page 213) and press to confirm.

- 1 GPS symbol indicates GPS time reception
- 2 Setting the clock to a 30 minute increments, Activating the setting mode, page 217
- 3 Selecting the country and time zone, page 218
- 4 Selecting the time format, page 221

## Without GPS reception

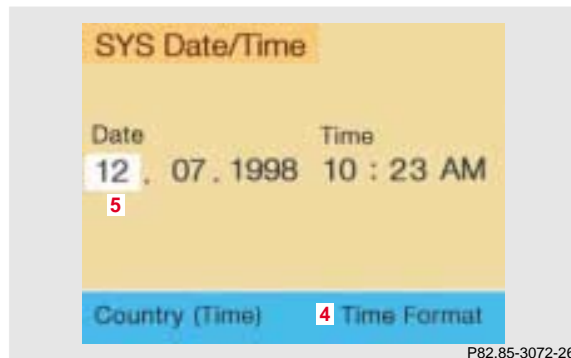

- 5 Setting the date and time manually, page 220

Note:

If GPS time is not available, the GPS symbol (1) will not appear in the display.

## GPS reception: setting the time in 30 minute increments

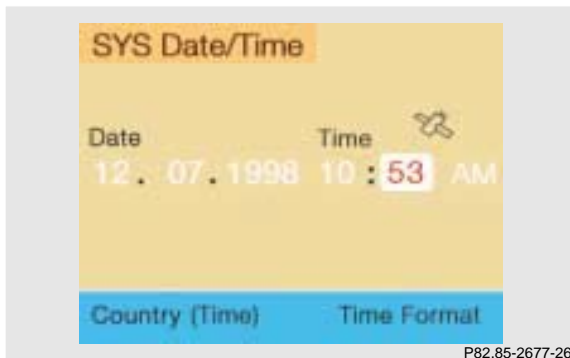

Activating the setting mode:

Press the right-hand rotary/pushbutton . The minutes will appear in red lettering.

Altering the time to a 30 minute increments:

Setting the clock ahead - Turn the right-hand rotary/pushbutton  to the right, the time will move back 30 minutes with each click.

Setting the clock back - Turn the right-hand rotary/pushbutton  to the left, the time will move back 30 minutes with each click.

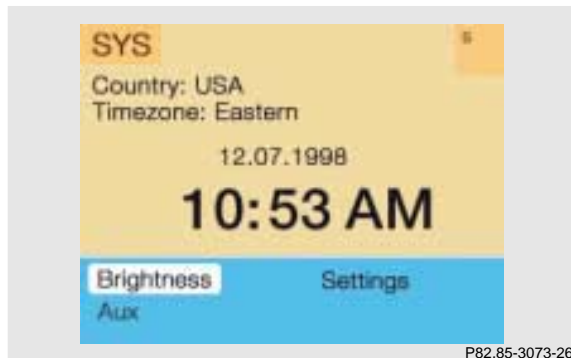

Canceling the setting mode:

Press the right-hand rotary/pushbutton . The minutes will appear in black lettering.

To activate the main System settings menu, either:



- Press **BACK**
- Press the right-hand rotary/pushbutton  longer than 2 seconds.

The new time will appear in the display.

### Selecting the country and the time zone







Use the right-hand rotary/pushbutton  to highlight the “Country (Time)” menu field in the “Date/Time” menu and press it to confirm. An input menu will appear.

- 6 Use the right-hand rotary/pushbutton  to highlight the initial letters for the country name one after the other and press to confirm
- 7 To access country list, use the right-hand rotary/pushbutton  to highlight this menu field and press to confirm or press the right-hand rotary/pushbutton  until the zoom disappears.



- 8 Highlighted country, entered previously
- 9 Move to previous page, Arrow is empty - start of list
- 10 Move to next page, Arrow is empty - end of list

Use the right-hand rotary/pushbutton  to highlight the desired country and press to confirm.

To move to the next/previous page, highlight the  or  symbol with the right-hand rotary/pushbutton  and confirm by pressing.



P82.85-2686-26

For countries with several time zones (e.g. Canada, USA):

After you have confirmed the country, the “Timezone” menu is activated. Highlight the zone you want with the right-hand rotary/pushbutton  and confirm by pressing.



P82.85-3076-26

In the next menu, press the right-hand rotary/pushbutton  to set the menu field “Automatic S/W time”.

“Automatic S/W time” menu field - there is change of time in this country/timezone and the dates of time changes are known. Checkmark  indicates that automatic time change is active.

“Summer time” menu field - the dates of time changes are unknown, the change to the winter time must be made manually, page 220.

Press the right-hand rotary/pushbutton  longer than 2 seconds. The settings are adopted, and the main system menu is displayed.

**Set the date and time manually**

If the clock has been disconnected from the vehicle battery for any reason or if the dates of the change between summer and winter time are not available in advance, it will be necessary to set the clock manually.

Use the right-hand rotary/pushbutton  to highlight the “Date/Time ...” menu field in the “Settings” menu (page 213) and press to confirm.

- 11** Setting the day, month, year, hours, minutes, when the menu appears on the screen, the day is highlighted automatically.

Activate the setting mode:

Press the right-hand rotary/pushbutton . The day is shown in red.

Move the day forwards – turn the right-hand rotary/pushbutton  to the right.

Move the day back – turn the right-hand rotary/pushbutton  to the left.

Exiting from the setting mode:

Press the right-hand rotary/pushbutton . The day is shown in black, the cursor moves to the month indicating.

Adopting a date and time:

Press the right-hand rotary/pushbutton  longer than 2 seconds.

The main System settings menu will appear.

Note:

If an entry is not accepted, the message “Invalid input” will appear.

## Selecting the time format

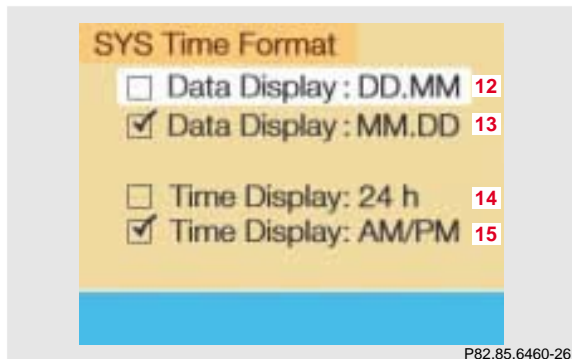

In the “Date/Time” menu use the right-hand rotary/pushbutton  to highlight the “Time Format” menu field and press to confirm.

The time format menu will appear.

- Setting is active
- Setting is not active

- 12 Date displayed in day, month format
- 13 Date displayed in month, day format
- 14 Time displayed in 24 hour format
- 15 Time displayed in 12 hour format (AM and PM), in the main menu for system settings and in the “Date/Time” menu the abbreviations AM or PM are shown after the time.

To alter the setting:

Use the right-hand rotary/pushbutton  to highlight an entry and press to confirm (a checkmark will appear).

You can confirm your selection in one of the following ways:

- Hold the right-hand rotary/pushbutton  longer than 2 seconds – this activates the main menu for system settings
- Press **BACK** – this activates the “Date/Time” menu.

## System settings

222

## Switching beep tones on and off

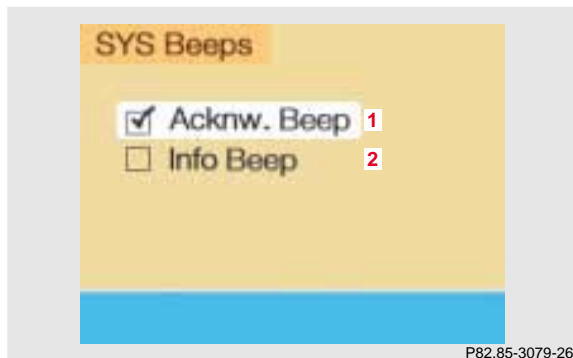

Use the right-hand rotary/pushbutton  to highlight the “Beeps...” menu field in the settings menu and press to confirm.

The beeps menu will appear.

- Tone is switched on
- Tone is switched off

- 1 Acknowledgement beep – acknowledges a function or the selection of an entry  
Factory setting is off.
- 2 Info beep – is heard where information is provided to the user, e.g. navigation turn is approaching.

To alter the setting:

Turn the right-hand rotary/pushbutton  to highlight the desired beep and press to confirm. The beep selected will be switched off or on accordingly.

You can confirm your selection in one of the following ways:

- Hold the right-hand rotary/pushbutton  longer than 2 seconds - this activates the main menu for system settings
- Press **BACK** - this activates the “Date/Time” menu.

## Setting changeover between day and night display

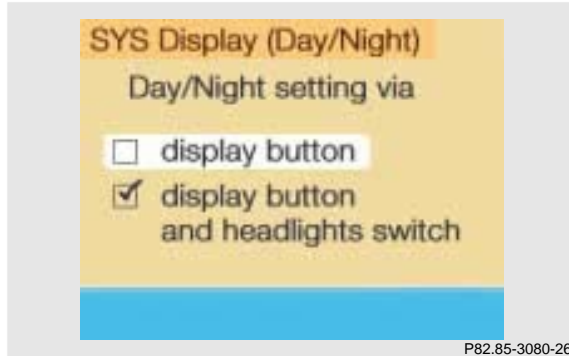

In the settings menu (page 213) highlight the menu field “Display (Day/Night)” with the rotary pushbutton **◀** and confirm by pressing.

The menu “Display (Day/Night)” will appear.

- Setting active
- Setting not active

Note:

The setting (2) is active when calling up for the first time. A change is stored and becomes active when COMAND is switched on again.

- 1 Changeover of the day/night display by pressing **DISP**
- 2 Changeover of the day/night display by pressing **DISP** and headlights switch

Note:

You can change over between day display, night display and screen switched off by repeatedly pressing **DISP**. Press **DISP** again to switch on the screen.

If the setting (2) is selected the night display is automatically switched on together with the headlights. It is possible to change over to the day display by pressing **DISP**.

### Reset all settings to the factory settings

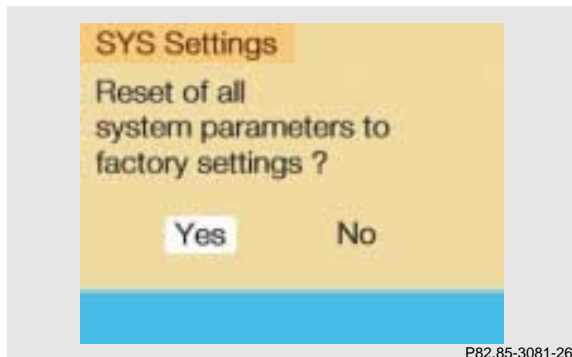

Use the right-hand rotary/pushbutton  to highlight the "Factory settings" menu field in the settings menu and press to confirm.

An inquiry menu will appear.

To accept the factory settings:

Press the right-hand rotary/pushbutton  confirm the "Yes" menu field). A screen with the factory settings is shown for a few seconds. The main menu for system settings is reactivated.

The factory settings are:

- Acknowledgement beep - off
- Info beep - off
- Language - English (imp.)
- Time display - AM/PM
- Date display - MM.DD (MM - month, DD - day)

If you do not wish to reset settings:

Use the right-hand rotary/pushbutton  to highlight "No" and press to confirm. This activates the main menu for system settings.

## Auxiliary audio source

### Connecting an auxiliary audio source

**We recommend that any auxiliary audio unit be installed and connected by a Mercedes-Benz Center.**

The auxiliary audio source (e.g. CD changer) will be installed in the glove compartment of your vehicle and connected to the socket available for this purpose. You will require a separate connecting cable for this.

Refer to the separate operating instructions for information on how to operate the auxiliary audio source (e.g. CD changer).

Notes:

Traffic radio announcements and voice output during route guidance can also be heard while the auxiliary audio source is switched on.

The telephone can be used while the auxiliary audio source is in operation.

### Switching on auxiliary audio source on/off

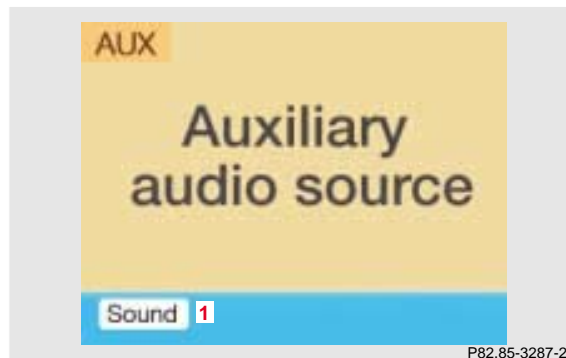

Turn the right-hand rotary/pushbutton  to highlight the “Aux” menu field in the main System settings menu and press to confirm.

**1** Adjusting sound settings, page 69

Note:

The values selected for the auxiliary audio source sound are independent of those selected for the COMAND audio sources.

## System settings

## 226

When this menu is activated, the auxiliary audio source, e.g. a tape deck, will switch on if it has been connected to the COMAND system.

To mute the external audio source:

Press **MUT**. The symbol  will appear in the symbol bar.

To cancel mute function, press **MUT** again. The symbol  will disappear from the symbol bar.

To switch off the external audio source:

Press e.g. **FM/AM**. The COMAND audio source selected will switch on.

Adjusting the volume level of an auxiliary audio source.

- Adjust volume of vehicle radio to a comfortable listening level.
- Connect adapter cable to portable tape deck and to vehicle ( socket in glove box).
- Press “SVC” button on COMAND unit.
- Select “AUX:” setting on COMAND unit.
- Press play on portable tape deck.
- Adjust the volume on the portable tape deck so that the audio system output is at or near the same comfortable level previously set in radio mode.
- Volume can now be adjusted using either COMAND or volume controls on multifunction steering wheel.

Note:

Only the volume setting of the tape player can be controlled using the COMAND system.

## A

Accepting a call (using the multifunction steering wheel).....	88
Accepting calls using COMAND .....	89
Activating the location map .....	169
Activating the route map .....	172
Acknowledgement beep .....	15
Adjusting the brightness .....	212
Adjusting the volume .....	14
Alarm beep .....	14
Altering the map scale .....	154, 182
Altering the voice output volume .....	175
AM (Ante Meridiem) .....	221
Audio sources .....	69
Automatic Station Scan .....	28
Auxiliary audio source, Switching on/off.....	225

## B

Beep tones, Switching on/off .....	222
------------------------------------	-----

## C

Calibration .....	204
Canceling route guidance.....	195
CD changer .....	45
CD, Loading into the CD drive .....	44
CDs scan.....	62
CD track scan .....	56
CD playback .....	43
Changing to map display during route guidance .....	180
City list .....	143
COMAND (Cockpit Management and Data System) .....	2
Compass needle .....	183
Cross hairs .....	152
Current map scale .....	154, 169
Current vehicle position .....	169, 172

## D

Date and Time, Setting.....	215
Day/Night display .....	223
Delete CD name.....	59
Destination address, Entering .....	140
Destination memory, Sorting.....	201
Destination, Selecting via the map .....	151

Destination, Reaching your .....	192
Destination, Saving in the memory .....	198
Deviating from the calculated route .....	192
Dialing a number from the phone book .....	95
Displaying the route list .....	168
Distance bar .....	165

**E**

Emergency call .....	107
Entering CD names .....	57
Entering destination address .....	140
Entering the house number .....	150
Entering the station frequency in the presets .....	37

**F**

Factory settings .....	224
FM, AM .....	23
Frequency ranges .....	23, 27
Fast forward/rewinding .....	55

**G**

Geographical latitude and longitude of your current position .....	169
GPS reception, set the time .....	217
GPS-signals .....	132

**H**

Heading-up .....	183
House numbers, Entering .....	150

**I**

Information/status line .....	12
Increase the map scale .....	154, 182
Info beep .....	14, 222

**L**

Last destination, Activating .....	160
List of languages .....	214
Lists .....	12

## M

Map display .....	166
Map orientation, Selecting .....	183
Map scale, Current .....	154, 182
Map scale, Reduce .....	154, 182
Map scale, Increasing .....	154, 182
Menus .....	12
Message “Activating Navigation. Please obey all traffic rules!” .....	136, 137
Message “Attention, name memory is full; new entry only possible after cleaning an old one!” ..	58
Message “Being activated” .....	63
Message “CALC. ROUTE” .....	163
Message “Caution. Please turn on ignition. Otherwise system will shut down in 3 minutes” .....	15
Message “Caution. Please turn on ignition. Otherwise system will shut down in 10 seconds” .....	15
Message “Caution. The system will shut down.” .....	15
Message “CD changer: No CD” .....	54
Message “CD loading” .....	50, 54
Message “CD-Reading error. Please change CD” .....	137
Message “Cellular System Busy” .....	209
Message “Compiling Route List” .....	165

Message “Data Connection Cannot be Established” .....	209
Message “Data transmission failure” .....	209
Message “DEST AREA” .....	165
Message “Error” .....	64
Message “Error: Phone defective” .....	79
Message “Error: Phone not connected” .....	79
Message “Forward”, “Rewind” .....	55
Message “Magazine empty” .....	63
Message “Navigation cannot be activated, an error has occurred” .....	137
Message “NEW ROUTE” .....	165, 192
Message “No CD. Insert navigation CD” .....	137
Message “No CD changer” .....	63
Message “No Cellular Connection Available” .....	209
Message “No information available at this time. Press SVC button later.” .....	209
Message “No magazine” .....	63
Message “NO ROUTE” .....	165
Message “No Service” .....	79, 86
Message “No Service, redial?” .....	79
Message “OFF MAP” .....	165
Message “OFF ROAD” .....	165
Message “Reading error” .....	63
Message “Ready” .....	95

**Index**

Message “System busy, redial?” ..... 79, 123  
 Message “Tele Aid Call in Progress!” ..... 209  
 Message “Tele Aid. Please visit workshop” ..... 209  
 Message “Telephone is being activated. Please wait” ..... 79  
 Message “Temperature too high” ..... 64  
 Message “To subscribe to information services dial phone number” ..... 209  
 Message “Voice output is muted” ..... 173  
 Mix ..... 166, 181  
 Mobile telephone handset ..... 91  
 Moving the cross hairs ..... 152  
 Multifunction steering wheel, multifunction display (telephone) ..... 80  
 Multifunction steering wheel, multifunction display (CD) ..... 68  
 Multifunction steering wheel, multifunction display (radio) ..... 39

**N**

Navigation system ..... 131  
 Navigation CD, Changing ..... 138  
 North-up ..... 183

Notebook ..... 110  
 Number keypad ..... 8  
 Number of satellites received ..... 169

**Q**

Quick-dialing ..... 109

**P**

Personal Service Number ..... 126  
 Phone book ..... 95, 97  
 Phone book, Editing the  
 PM (Post Meridien) ..... 221  
 Points of interest ..... 156  
 Pop-up window ..... 15  
 Principle of route guidance ..... 164

**R**

Radio station frequency, Entering ..... 37  
 Radio station, Selecting ..... 24  
 Radio stations, Deleting in the memory ..... 35  
 Radio stations, Scanning ..... 28

Radio stations, Saving automatically, AM .....	32	Scale bar .....	154, 182
Radio stations, Saving manually, AM .....	31	Selecting a destination via the map .....	151
Radio stations, Saving manually, FM .....	29	Selecting a detour .....	187
Reaching your destination .....	192	Selecting an intersection .....	149
Reception quality .....	185	Selecting a station .....	24
Redial .....	102	Selecting the route calculation mode and calculating the route .....	161
Reduce the map scale .....	154, 182	Selecting CD's .....	53
Requesting the route mode .....	171	Selecting map orientation .....	183
ROAM indicator .....	85, 118	Selecting the last destinations .....	160
Route guidance with a mixture of map and symbol display .....	181	Selecting the time format .....	221
Route list, Displaying .....	168	Selecting/avoiding specific traffic routes .....	161
Route map, Activating .....	172	Service numbers .....	125
Route mode, Requesting .....	171	Service sources .....	69
Route, Fastest .....	161	Set the date and time .....	215
Route, Short .....	161	Setting Bass/Treble/Fader/Balance .....	72
		Setting the date and time manually .....	220
		Short route .....	161
		SMS function .....	118
		SMS message, Reading an .....	119
		SMS message, Deleting an .....	121
		Sorting destination memory .....	201
		Sound impressions .....	69
		Speed-dialing (only at COMAND) .....	107

## S

Saving stations automatically, AM .....	32
Saving stations manually, AM .....	31
Saving stations manually, FM .....	29
Saving the current destination .....	198
Saving the current vehicle position .....	200

Station selection via direct frequency entry ..... 27  
 Switching beep tones on and off ..... 222  
 Switch the COMAND operating unit on and off ..... 13  
 Switch off screen ..... 14  
 Switch the microphone off ..... 90  
 Switching the voice output on/off ..... 175  
 Symbol display ..... 166  
 System ..... 12

**T**

Time zones ..... 218  
 Track repeat ..... 61

**U**

Unlock code ..... 86

**V**

Voice output, Switching on/off ..... 175  
 Voice output “Bear left after one quarter mile” ..... 179  
 Voice output during route guidance ..... 174

Voice output “Please bear left” ..... 179  
 Voice output “Please turn right” ..... 174, 176  
 Voice output “Prepare to bear left” ..... 179  
 Voice output “Prepare to turn right” ..... 176  
 Voice output “The route is being calculated” ..... 162  
 Voice output “The route to your intermediate destination is being calculated” ..... 185  
 Voice output “Turn right after one quarter mile” ..... 176  
 Voice output “You have reached your destination” ..... 192  
 Voice recognition system ..... 14, 69  
 Volume difference ..... 71

**W**

Weather band (WB) ..... 23  
 Way point ..... 165, 184

**Z**

Zoom ..... 112

We reserve the right to modify the technical details of the COMAND system as given in the data and illustrations of this Operator's Manual. Reprinting, translation and copying, even of excerpts, is not permitted without our prior authorization in writing.

Title illustration no. P82.85-6134-26

Press time 04/10/01

MBNA/TI

Printed in Germany