



2305844683

Order No. 6515 3065 13 Part No. 230 584 46 83 USA Edition A, 2007

Operator's Manual SL-Class



Operator's Manual  
SL-Class



Mercedes-Benz

SL 550

SL 55 AMG

SL 600

SL 65 AMG

Our company and staff congratulate you on the purchase of your new Mercedes-Benz.

Your selection of our product is a demonstration of your trust in our company name. Furthermore, it exemplifies your desire to own an automobile that will be as easy as possible to operate and provide years of service.

Your Mercedes-Benz represents the efforts of many skilled engineers and craftsmen. To help assure your driving pleasure, and also the safety of you and your passengers, we ask you to make a small investment of time:

- Please read this manual carefully, then return it to your vehicle where it will be handy for your reference.
- Please follow the recommendations contained in this manual. They are designed to acquaint you with the operation of your Mercedes-Benz.
- Please pay attention to the warnings and cautions contained in this manual. They are designed to help improve the safety of the vehicle operator and occupants.

We extend our best wishes for many miles of safe, pleasurable driving.

Mercedes-Benz USA, LLC  
A DaimlerChrysler Company

<b>Introduction</b> .....	9	<b>At a glance</b> .....	21	<b>Getting started</b> .....	37
Product information .....	9	Exterior view .....	22	Unlocking .....	38
Operator's Manual .....	10	Cockpit .....	24	Unlocking with the SmartKey .....	38
Service and warranty information ..	10	Instrument cluster .....	26	Unlocking with KEYLESS-GO* .....	39
Important notice for California		Multifunction steering wheel .....	30	Starter switch positions .....	39
retail buyers and lessees of		Center console .....	31	Adjusting .....	42
Mercedes-Benz automobiles .....	11	Upper part .....	31	Seats .....	42
Maintenance .....	12	Lower part .....	32	Steering wheel .....	45
Roadside Assistance .....	12	Overhead control panel .....	33	Mirrors .....	47
Change of address or ownership....	12	Storage compartments .....	34	Driving .....	49
Operating your vehicle outside the		Door control panel .....	36	Fastening the seat belts .....	49
USA or Canada .....	13			Starting the engine .....	52
Where to find it .....	14			Parking brake .....	54
Symbols .....	15			Driving off .....	54
Operating safety .....	16			Switching on headlamps .....	55
Proper use of the vehicle .....	16			Turn signals .....	56
Problems with your vehicle .....	17			Windshield wipers .....	57
Reporting safety defects .....	18			Problems while driving .....	59
Reporting safety defects .....	18			Parking and locking .....	60
Vehicle data recording .....	19			Parking brake .....	61
Information regarding electronic				Switching off headlamps .....	61
recording devices .....	19			Turning off the engine .....	62
				Releasing seat belts .....	62
				Locking .....	63

<b>Safety and Security</b> .....	65	<b>Controls in detail</b> .....	101	Lighting .....	128
Occupant safety .....	66	Locking and unlocking .....	102	Exterior lamp switch .....	128
Air bags .....	68	SmartKey .....	102	Corner-illuminating front fog	
Occupant Classification System .....	72	SmartKey with KEYLESS-GO* .....	105	lamps .....	132
Seat belts .....	77	Opening the doors from the		Combination switch .....	133
Roll bar .....	81	inside .....	111	Hazard warning flasher .....	133
Children in the vehicle .....	83	Opening the trunk .....	111	Interior lighting .....	134
Panic alarm .....	86	Closing the trunk .....	113	Courtesy lighting .....	135
Activating .....	86	Valet locking .....	117	Trunk lamp .....	135
Deactivating .....	86	Trunk lid emergency release .....	117	Instrument cluster .....	136
Driving safety systems .....	87	Power closing assist for trunk lid .....	118	Adjusting instrument cluster	
ABS .....	87	Automatic central locking .....	119	illumination .....	136
BAS .....	89	Locking and unlocking from the		Coolant temperature gauge .....	137
ESP® .....	89	inside .....	119	Trip odometer .....	137
Electro-hydraulic brake system .....	92	Seats .....	121	Tachometer .....	138
Anti-theft systems .....	96	Moving the seats forward and		Outside temperature indicator .....	138
Immobilizer .....	96	backward .....	121	Control system .....	139
Anti-theft alarm system .....	96	Lumbar support .....	121	Multifunction display .....	139
Tow-away alarm .....	98	Multicontour backrest* .....	122	Multifunction steering wheel .....	140
		Seat heating .....	123	Menus .....	142
		Seat ventilation* .....	125	Standard display menu .....	145
		Memory function .....	126	AMG menu .....	146
		Storing positions into memory .....	127	AUDIO menu .....	149
		Recalling positions from memory .....	127	NAV menu .....	151
				Distronic* menu .....	151

Vehicle status message memory menu.....	152	Automatic climate control .....	184	Driving systems.....	209
Settings menu.....	153	Deactivating the automatic climate control system .....	187	Cruise control .....	209
Trip computer menu.....	163	Operating the automatic climate control system in automatic mode .....	187	DISTRONIC* .....	213
TEL menu* .....	165	Setting the temperature.....	188	Distance warning function* .....	224
Automatic transmission.....	168	Adjusting air distribution.....	189	Active Body Control (ABC) .....	225
Gear selector lever position .....	170	Adjusting air volume .....	190	Parktronic system* (Parking assist) .....	228
Driving tips.....	171	Maximum cooling MAXCOOL .....	190	Useful features.....	233
Gear ranges .....	172	Front defroster.....	190	Storage compartments .....	233
Automatic shift program .....	173	Air recirculation mode .....	191	Cup holders .....	238
Gear selector lever one-touch gearshifting .....	174	Air conditioning.....	193	Ashtray .....	239
Steering wheel gearshift control one-touch gearshifting* .....	175	Residual heat and ventilation .....	194	Cigarette lighter.....	239
Manual shift program (SL 55 AMG and SL 65 AMG only) .....	177	Ventilated glove box .....	195	Heated steering wheel* .....	240
Emergency operation (Limp-Home Mode) .....	179	Power windows .....	196	Load assist in the trunk .....	241
Good visibility .....	180	Opening and closing the windows.....	196	Power outlet .....	242
Headlamp cleaning system .....	180	Synchronizing power windows .....	198	Telephone* .....	243
Rear view mirrors.....	180	Retractable hardtop.....	199	Tele Aid.....	244
Sun visors .....	182	Opening and closing the retractable hardtop .....	199	Garage door opener.....	251
Rear window defroster .....	183				

# Contents

<b>Operation</b> .....	257	At the gas station .....	271	Maximum tire load .....	308
The first 1000 miles (1500 km) .....	258	Refueling .....	271	Maximum tire inflation pressure ..	309
Driving instructions .....	259	Check regularly and before a long trip.....	272	Uniform Tire Quality Grading Standards (U.S. vehicles) .....	309
Drive sensibly – save fuel .....	259	Engine compartment .....	274	Tire ply material .....	311
Drinking and driving .....	259	Hood .....	274	Tire and loading terminology.....	312
Pedals .....	259	Engine oil .....	275	Rotating tires .....	315
Power assistance .....	260	Transmission fluid level.....	279	Winter driving .....	316
Brakes .....	260	Oil level in the ABC system .....	279	Winter tires .....	316
Driving off.....	262	Coolant .....	280	Block heater (Canada only) .....	317
Parking.....	263	Battery .....	281	Snow chains.....	318
Tires .....	263	Windshield washer system and headlamp cleaning system.....	282	Maintenance.....	319
Hydroplaning.....	264	Tires and wheels.....	283	Maintenance service indicator message .....	319
Tire traction.....	265	Important guidelines .....	283	Calling up the maintenance service indicator display .....	320
Tire speed rating .....	265	Tire care and maintenance.....	284	Resetting the maintenance service indicator .....	321
Winter driving instructions .....	266	Direction of rotation .....	286	Vehicle care.....	322
Standing water .....	267	Loading the vehicle .....	286	Cleaning and care of the vehicle..	322
Passenger compartment .....	268	Recommended tire inflation pressure .....	291		
Driving abroad.....	268	Checking tire inflation pressure ...	292		
Control and operation of radio transmitters.....	268	MO <i>Extended</i> system* .....	301		
Catalytic converter.....	269	Tire labeling.....	302		
Emission control.....	269	Load identification .....	306		
Coolant temperature .....	270	DOT, Tire Identification Number (TIN) .....	307		

<p><b>Practical hints</b> ..... 331</p> <p>What to do if ... ..... 332</p> <p>    Lamps in the instrument cluster .. 332</p> <p>    Air bag off indicator lamp ..... 345</p> <p>    Vehicle status messages in the multifunction display ..... 347</p> <p>Where will I find ...? ..... 388</p> <p>    First aid kit ..... 388</p> <p>    Vehicle tool kit, jack, and spare wheel ..... 388</p> <p>Locking/unlocking in an emergency ..... 391</p> <p>    Unlocking the vehicle ..... 391</p> <p>    Locking the vehicle ..... 393</p> <p>    Lowering the load assist manually 394</p> <p>Replacing SmartKey batteries ..... 395</p> <p>Replacing bulbs ..... 397</p> <p>    Bulbs ..... 397</p> <p>    Replacing bulbs for front lamps ... 399</p> <p>    Replacing bulbs for rear lamps..... 402</p> <p>Replacing wiper blades ..... 403</p> <p>    Placing wiper arms in vertical position ..... 403</p> <p>    Removing wiper blades ..... 404</p> <p>    Installing wiper blades ..... 404</p>	<p>Flat tire ..... 405</p> <p>    Preparing the vehicle ..... 405</p> <p>    Mounting the spare wheel ..... 405</p> <p>    MO<i>Extended</i> system* ..... 413</p> <p>Batteries ..... 414</p> <p>    Disconnecting the batteries ..... 416</p> <p>    Removing the batteries ..... 417</p> <p>    Charging and reinstalling batteries ..... 417</p> <p>    Reconnecting the batteries ..... 418</p> <p>Jump starting ..... 419</p> <p>Towing the vehicle ..... 421</p> <p>    Installing towing eye bolt ..... 423</p> <p>Fuses ..... 424</p> <p>    Fuse boxes in engine compartment ..... 425</p> <p>    Fuse box in passenger compartment ..... 426</p> <p>    Fuse in trunk ..... 426</p> <p>    Emergency engine shut-down ..... 426</p>	<p><b>Technical data</b> ..... 427</p> <p>Parts service ..... 428</p> <p>Warranty coverage ..... 429</p> <p>    Loss of Service and Warranty Information Booklet ..... 429</p> <p>Identification labels ..... 430</p> <p>Layout of poly-V-belt drive ..... 432</p> <p>    SL 550 ..... 432</p> <p>    SL 55 AMG ..... 432</p> <p>    SL 600, SL 65 AMG ..... 432</p> <p>Engine ..... 433</p> <p>Rims and tires ..... 435</p> <p>    Same size tires ..... 436</p> <p>    Mixed size tires ..... 437</p> <p>    MO<i>Extended</i> tires* ..... 439</p> <p>    Spare wheel ..... 440</p> <p>Electrical system ..... 441</p> <p>Main dimensions ..... 442</p> <p>Weights ..... 443</p>
---	---	---



## Contents

Fuels, coolants, lubricants, etc. ....	444
Capacities .....	444
Engine oils.....	446
Engine oil additives .....	446
Air conditioning refrigerant .....	446
Brake fluid.....	447
Premium unleaded gasoline .....	447
Fuel requirements .....	448
Gasoline additives .....	448
Coolants.....	449
Windshield and headlamp washer system .....	452
<hr/>	
<b>Index</b> .....	453

### ▼ Product information

Please observe the following in your own best interest:

We recommend using Genuine Mercedes-Benz parts as well as conversion parts and accessories explicitly approved by us for your vehicle model.

We have tested these parts to determine their reliability, safety and special suitability for Mercedes-Benz vehicles.

We are unable to make an assessment for other products and therefore cannot be held responsible for them, even if in individual cases an official approval or authorization by governmental or other agencies should exist. Use of such parts and accessories could adversely affect the safety, performance or reliability of your vehicle. Please do not use them.

Genuine Mercedes-Benz parts as well as conversion parts and accessories approved by us are available at your authorized Mercedes-Benz Center where you will receive comprehensive information, also on permissible technical modifications, and where proper installation will be performed.

This Operator's Manual contains a great deal of useful information. We urge you to read it carefully and familiarize yourself with the vehicle before driving.

For your own safety and longer service life of the vehicle, we urge you to follow the instructions and warnings contained in this manual. Ignoring them could result in damage to the vehicle or personal injury to you or others. Vehicle damage caused by failure to follow instructions is not covered by the Mercedes-Benz Limited Warranty.

Your vehicle may have some or all of the equipment described in this manual. Therefore, you may find explanations for optional equipment not installed in your vehicle. If you have any questions about the operation of any equipment, your authorized Mercedes-Benz Center will be glad to demonstrate the proper procedures.

We continuously strive to improve our product, and ask for your understanding that we reserve the right to make changes in design and equipment. Therefore, information, illustrations, and descriptions in this Operator's Manual might differ from your vehicle.

Optional equipment is also described in this manual, including operating instructions wherever necessary. Since they are special-order items, the descriptions and illustrations herein may vary slightly from the actual equipment of your vehicle.

If there are any equipment details that are not shown or described in this Operator's Manual, your authorized Mercedes-Benz Center will be glad to inform you of correct care and operating procedures.

The Operator's Manual and Maintenance Booklet are important documents and should be kept with the vehicle.

### Service and warranty information

---

The Service and Warranty Information Booklet contains detailed information about the warranties covering your Mercedes-Benz, including:

- New Car Limited Warranty,
- Emission System Warranty,
- Emission Performance Warranty,
- California, Maine, Massachusetts, and Vermont Emission Control System Warranty (California, Maine, Massachusetts, and Vermont only),
- State Warranty Enforcement Laws (Lemon Laws).

### **Important notice for California retail buyers and lessees of Mercedes-Benz automobiles**

Under California law you may be entitled to a replacement of your vehicle or a refund of the purchase price or lease price, if Mercedes-Benz USA, LLC and / or its authorized repair or service facilities fail to fix one or more substantial defects or malfunctions in the vehicle that are covered by its express warranty after a reasonable number of repair attempts. During the period of 18 months from original delivery of the vehicle or the accumulation of 18000 miles (approx. 29000 km) on the odometer of the vehicle, whichever occurs first, a reasonable number of repair attempts is presumed for a retail buyer or lessee if one or more of the following occurs:

- (1) the same substantial defect or malfunction results in a condition that is likely to cause death or serious bodily injury if the vehicle is driven, that defect or malfunction has been subject to repair two or more times, and you have directly notified Mercedes-Benz USA, LLC in writing of the need for its repair,
- (2) the same substantial defect or malfunction of a less serious nature than category (1) has been subject to repair four or more times and you have directly notified us in writing of the need for its repair, or
- (3) the vehicle is out of service by reason of repair of the same or different substantial defects or malfunctions for a cumulative total of more than 30 calendar days.

Written notification should be sent to us, not a dealer, at Mercedes-Benz USA, LLC, Customer Assistance Center, One Mercedes Drive, Montvale, NJ 07645-0350.

### Maintenance

---

The Maintenance Booklet describes all the necessary maintenance work which should be performed at regular intervals.

Always have the Maintenance Booklet with you when you take the vehicle to your authorized Mercedes-Benz Center for service. The service advisor will record each service in the booklet for you.

### Roadside Assistance

---

The Mercedes-Benz Roadside Assistance Program provides factory trained technical help in the event of a breakdown. Calls to the toll-free Roadside Assistance number:

**1-800-FOR-MERCEdes (in the USA)**  
**1-800-387-0100 (in Canada)**

will be answered by Mercedes-Benz Customer Assistance Representatives 24 hours a day, 365 days a year.

For additional information refer to the Mercedes-Benz Roadside Assistance Program brochure in your vehicle literature portfolio.

### Change of address or ownership

---

If you change your address, be sure to send in the "Change of Address Notice" found in the Service and Warranty Information Booklet, or simply call the Mercedes-Benz Customer Assistance Center (in the USA) at 1-800-FOR-MERCEdes, or Customer Service (in Canada) at 1-800-387-0100. It is in your own interest that we can contact you should the need arise.

If you sell your Mercedes, please leave all literature with the vehicle to make it available to the next operator.

If you bought this vehicle used, be sure to send in the "Notice of Purchase of Used Car" found in the Service and Warranty Information Booklet, or call the Mercedes-Benz Customer Assistance Center (in the USA) at 1-800-FOR-MERCEdes, or Customer Service (in Canada) at 1-800-387-0100.

## Operating your vehicle outside the USA or Canada

---

If you plan to operate your vehicle in foreign countries, please be aware that:

- Service facilities or replacement parts may not be readily available,
- unleaded gasoline for vehicles with catalytic converters may not be available; the use of leaded fuels will damage the catalyts,
- gasoline may have a considerably lower octane rating, and improper fuel can cause engine damage.

Certain Mercedes-Benz models are available for delivery in Europe under our European Delivery Program. For details, consult an authorized Mercedes-Benz Center or write to:

In the USA:

Mercedes-Benz USA, LLC  
European Delivery Department  
One Mercedes Drive  
Montvale, NJ 07645-0350

In Canada:

Mercedes-Benz Canada, Inc.  
European Delivery Department  
98 Vanderhoof Avenue  
Toronto, Ontario M4G 4C9

### Where to find it

This Operator's Manual is designed to provide comprehensive support information for you, the vehicle operator. Each section has its own reference color:

#### At a glance

Here you will find an overview of all the controls that can be operated from the driver's seat.

#### Getting started

Here you will find all the information you need for your first drive. You should read this section first if this is your first Mercedes-Benz vehicle or if you are renting or borrowing this vehicle.

#### Safety and Security

Here you will find descriptions of the safety and security features in your vehicle.

#### Controls in detail

Here you will find detailed information about the equipment installed on your vehicle. This section expands on the "Getting started" section and also describes technical innovations. If you are already familiar with the basic functions of your vehicle, this section will be of particular interest to you.

#### Operation

Here you will find all the information you need for the proper operation of your vehicle.

#### Practical hints

This section provides fast assistance for dealing with problems you may encounter.

#### Technical data

All important technical data for your vehicle can be found in this section.

#### Indexes

The table of contents and the index are designed to help you find information quickly and easily.

The following publications are part of your vehicle documentation:

- this Operator's Manual
- the Maintenance Booklet

Separate operating instructions will be provided as required depending on the equipment options installed in your vehicle.

## ▼ Symbols

Trademarks:

- ESP® is a registered trademark of DaimlerChrysler.
- HomeLink® is a registered trademark of Prince, a Johnson Controls Company.

The following symbols are found in this Operator's Manual:

- \* Optional equipment is identified with an asterisk. Since standard equipment varies between models, the descriptions and illustrations in this manual may differ slightly from the actual equipment of your vehicle.

### Warning!



Warning notices draw your attention to hazards that may endanger your health or life, or the health or life of others.

**!** *Highlights hazards that may result in damage to your vehicle.*

**i** *Helpful hints or further information you may find useful.*

- ▶ This symbol points to instructions for you to follow.
- ▶ A number of these symbols appearing in succession indicates a multiple-step procedure.
- ▷ Page This symbol tells you where to look for further information on a topic.
- ▷▷ This continuation symbol indicates a procedure which will be continued on the next page.
- ▷▷ This continuation symbol indicates a warning which will be continued on the next page.
- Display Words appearing in the multi-function display are printed in the type shown here.



#### Warning!



Work improperly carried out on electronic components and associated software could cause them to cease functioning. Because the vehicle's electronic components are interconnected, any modifications made may produce an undesired effect on other systems. Electronic malfunctions could seriously impair the operating safety of your vehicle.

See an authorized Mercedes-Benz Center for repairs or modifications to electronic components.

Other improper work or modifications on the vehicle could also have a negative impact on the operating safety of the vehicle.

Some safety systems only function while the engine is running. You should therefore never turn off the engine while driving.

#### Warning!



Heavy blows against the vehicle underbody or tires / wheels, for example when running over an obstacle, road debris or a pothole, may cause serious damage and impair the operating safety of your vehicle. If you feel a sudden significant vibration or ride disturbance, or you suspect that damage to your vehicle has occurred, you should turn on your hazard warning flashers, carefully slow down, and drive with caution to an area which is a safe distance from the road.

Inspect the vehicle underbody and tires / wheels for possible damage. If the vehicle appears unsafe, have it towed to the nearest authorized Mercedes-Benz Center or other qualified maintenance or repair facility for further inspection or repairs.

#### Proper use of the vehicle

Proper use of the vehicle requires that you are familiar with the following information and rules:

- the safety precautions in this manual
- the “Technical data” section in this manual
- traffic rules and regulations
- motor vehicle laws and safety standards

#### Warning!



Various warning labels are attached to your vehicle. These warning labels are intended to make you and others aware of various risks. You should not remove any of these warning labels unless explicitly instructed to do so by information on the label itself. Removal of any of these labels may cause you and others to be unaware of certain risks which may result in an accident and/or personal injury.

**▼ Problems with your vehicle**

If you should experience a problem with your vehicle, particularly one that you believe may affect its safe operation, we urge you to immediately contact an authorized Mercedes-Benz Center to have the problem diagnosed and corrected if required. If the matter is not handled to your satisfaction, please discuss the problem with the Mercedes-Benz Center management, or if necessary contact us at one of the following addresses:

In the USA:

Customer Assistance Center  
Mercedes-Benz USA, LLC  
One Mercedes Drive  
Montvale, NJ 07645-0350

In Canada:

Customer Relations Department  
Mercedes-Benz Canada, Inc.  
98 Vanderhoof Avenue  
Toronto, Ontario M4G 4C9

### Reporting safety defects

For the USA only:

The following text is published as required of manufacturers under Title 49, Code of U.S. Federal Regulations, Part 575 pursuant to the “National Traffic and Motor Vehicle Safety Act of 1966”.

#### **Reporting safety defects**

---

If you believe that your vehicle has a defect which could cause a crash or could cause injury or death, you should immediately inform the National Highway Traffic Safety Administration (NHTSA) in addition to notifying Mercedes-Benz USA, LLC.

If NHTSA receives similar complaints, it may open an investigation, and if it finds that a safety defect exists in a group of vehicles, it may order a recall and remedy campaign. However, NHTSA cannot become involved in individual problems between you, your dealer, or Mercedes-Benz USA, LLC.

To contact NHTSA, you may call the Vehicle Safety Hotline toll-free at 1-888-327-4236 (TTY: 1-800-424-9153); go to <http://www.safercar.gov>; or write to: Administrator, NHTSA, 400 Seventh Street, SW., Washington, D.C. 20590. You can also obtain other information about motor vehicle safety from <http://www.safercar.gov>.

## ▼ Vehicle data recording

### Information regarding electronic recording devices

---

(Including notice pursuant to California Code § 9951)

Please note that your vehicle is equipped with devices that can record vehicle systems data and, if equipped with the Tele Aid system, may transmit some data in certain accidents.

This information helps, for example, to diagnose vehicle systems after a collision and to continuously improve vehicle safety. DaimlerChrysler may access the information and share it with others

- for safety research or vehicle diagnosis purposes
- with the consent of the vehicle owner or lessee
- in response to an official request by law enforcement or other government agency
- for use in dispute resolution involving DaimlerChrysler, its affiliates or sales/service organization and/or
- as otherwise required or permitted by law.

Please check the Tele Aid subscription service agreement for details regarding the information that may be recorded or transmitted via that system.



**Exterior view**

**Cockpit**

**Instrument cluster**

**Multifunction steering wheel**

**Center console**

**Overhead control panel**

**Storage compartments**

**Door control panel**



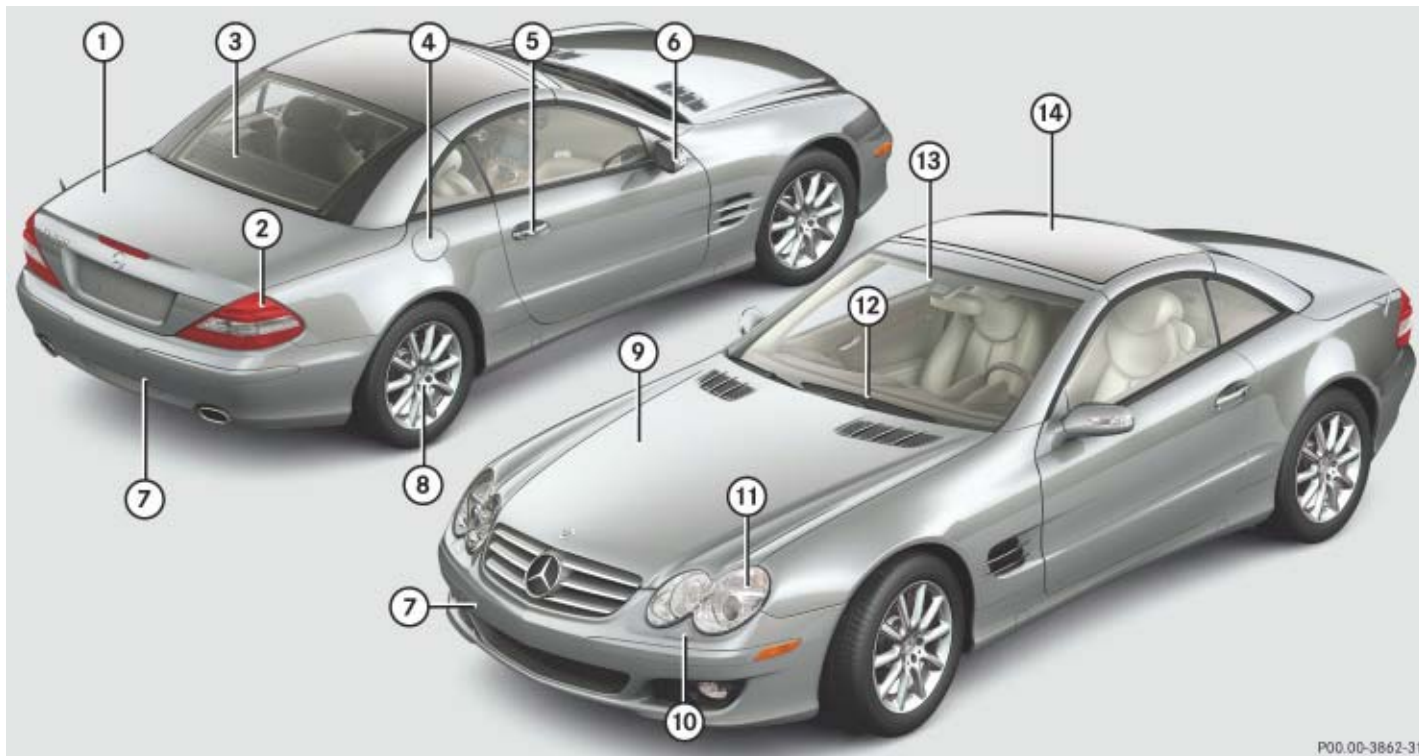

P00.00-3862-31

Item	Page
① Trunk	
Opening the trunk	111
Closing the trunk	113
Spare wheel	388
Vehicle tool kit	388
② Rear lamps	398
③ Rear window defroster	183
④ Fuel filler flap	271
Refueling	271
Gasoline	447
⑤ Doors	
Locking and unlocking	102
Opening and closing	111
Locking/unlocking in an emergency	391
⑥ Exterior rear view mirrors	
Adjusting	48
Auto-dimming rear view mirrors	180

Item	Page
⑦ Towing	421
Installing towing eye bolt	423
⑧ Tires and wheels	283
Checking tire inflation pressure	292
Run Flat Indicator*	293
Tire Pressure Monitoring System (TPMS)	295
Advanced Tire Pressure Monitoring System (Advanced TPMS)*	298
General information	283
Flat tire	405
Vehicle tool kit	388
⑨ Hood	
Opening	274
Engine oil	275
Coolant	280, 449

Item	Page
⑩ Headlamp cleaning system	180, 282
⑪ Front lamps	398
⑫ Windshield wipers	57
Wiper blades, replacing	403
Wiper blades, cleaning	326
⑬ Windshield	
Cleaning with wiper fluid	58
Cleaning	326
⑭ Retractable hardtop	
Opening/closing	199
Wind screen	204
Luggage cover	205
Sunshade for panorama roof*	208



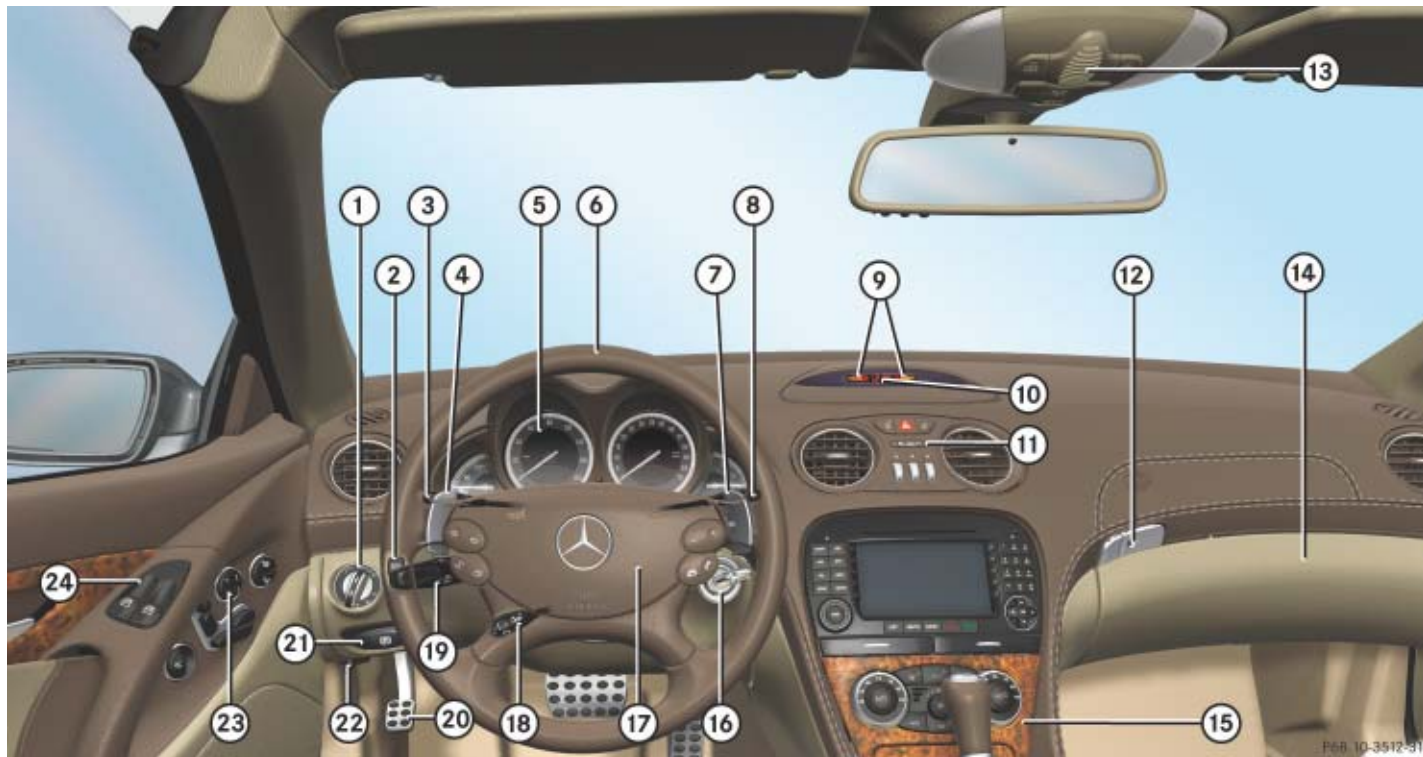

Feb. 10-3512-91







Item	Page
① Exterior lamp switch	55, 128
② Headlamp washer button	180
③ Cruise control lever	
• Cruise control	209
• Distronic*	213
④ Shift paddle*: downshift	175
⑤ Instrument cluster	26, 136
⑥ Multifunction steering wheel	30, 140
⑦ Shift paddle*: upshift	175
⑧ Lever for voice control system*, see separate operating instructions	
⑨ Front Parktronic* warning indicator	230

Item	Page
⑩ Digital clock	
⑪ Front passenger front air bag off indicator lamp	76
⑫ Interior storage compartments (locking/unlocking)	235
⑬ Overhead control panel	33
⑭ Glove box	233
⑮ Center console	31, 32
⑯ Starter switch	41
⑰ Horn	
⑱ Steering wheel adjustment stalk	45
Heated steering wheel*	240

Item	Page
⑲ Combination switch	
• Turn signals	56
• Windshield wipers	57
• High beam	133
⑳ Parking brake pedal	54, 61
㉑ Parking brake release handle	54
㉒ Hood lock release	274
㉓ Door control panel	36
㉔ Power window switch	196



P54.32-3868-31







Item	Page
① <b>Coolant temperature gauge with:</b>	
 Coolant temperature warning lamp	337
② <b>Speedometer with:</b>	
 Left turn signal indicator lamp	56
 Right turn signal indicator lamp	56
 Brake warning lamp, USA only	335
 Brake warning lamp, Canada only	335
 ABS/ESP® warning lamp	332

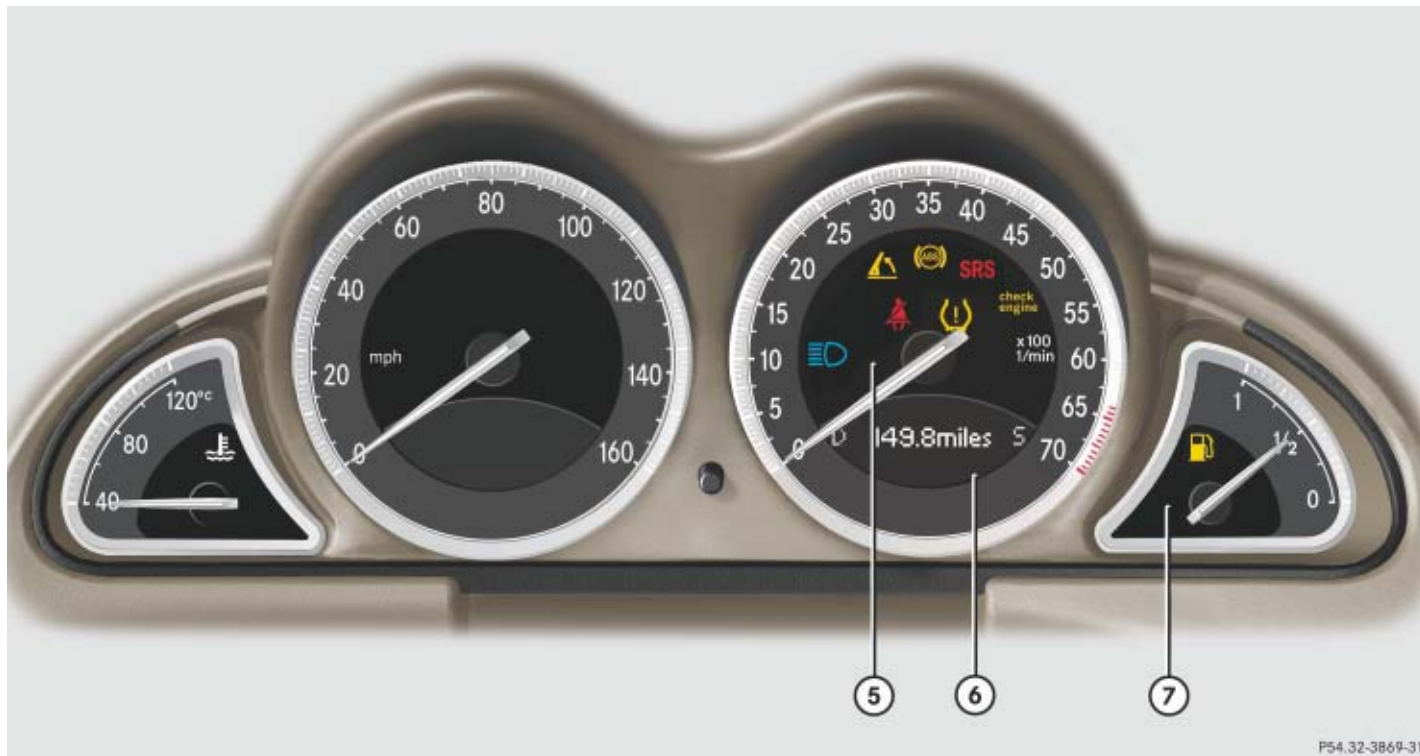

Item	Page
 Distronic* indicator lamp <sup>1</sup> (white) or distance warning lamp (red)	213, 339
③ <b>Left multifunction display with:</b>	
• Trip odometer	137
• Main odometer	
• Stored speed for	
• Cruise control	209
• Distronic*	151, 213

Item	Page
④ <b>Reset button for:</b>	
• Resetting trip odometer	137
• Resetting individual settings	153
• Adjusting instrument cluster illumination	136

<sup>1</sup> Vehicles without Distronic\*: Warning/indicator lamp without function. It illuminates when the ignition is on. It should go out when the engine is running.









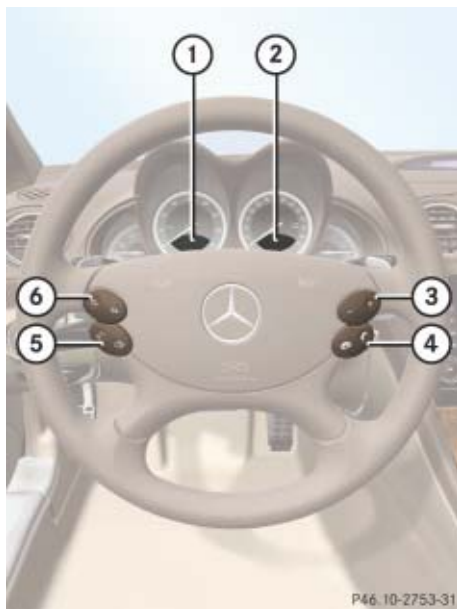

Item	Page
⑤ <b>Tachometer with:</b>	138
 High beam headlamp indicator	133
 Engine malfunction indicator lamp, USA only	336
 Engine malfunction indicator lamp, Canada only	
 Roll bar warning lamp	340
 Antilock Brake System (ABS) indicator lamp	334
 Supplemental Restraint System (SRS) indicator lamp	342

Item	Page
 Seat belt telltale	341
 Combination low tire pressure/TPMS malfunction telltale, USA only	343
Low tire pressure telltale*, Canada only	
⑥ <b>Right multifunction display with:</b>	
• Gear selector lever position	170
• Outside temperature display	138
• Program mode	169
⑦ <b>Fuel gauge with:</b>	
 Fuel reserve warning lamp	339

## Multifunction steering wheel



Item	Page
① Left multifunction display in the speedometer	139
② Right multifunction display in the tachometer	139
<b>Operating the control system</b>	140
③ Selecting the submenu or setting the volume: Press button	
 down/to decrease	
 up/to increase	
④ Telephone*: Press button	
 to take a call	
 to end a call	

Item	Page
⑤ Menu systems: Press button	
 for previous menu	
 for next menu	
⑥ Moving within a menu: Press button	
 for next display	
 for previous display	

## ▼ Center console

## Upper part



Item	Page
① Central locking switch	119
② Hazard warning flasher on/off switch	133
③ Central unlocking switch	120
④ Center and side air vent adjustment	189
⑤ COMAND system, see separate operating instructions	
⑥ Right cup holder	238
⑦ KEYLESS-GO* start/stop button	40
⑧ Automatic climate control panel	184
⑨ Ashtray Cigarette lighter	239 239
⑩ Left cup holder	238



## Center console

### Lower part



Item	Page
① Gear selector lever for automatic transmission	173
② Parktronic system* deactivation switch	228
③ Exterior rear view mirror adjustment	47
④ ABC suspension tuning button	225
⑤ Tow-away alarm switch	98
⑥ Retractable hardtop open/close switch with buttons for roll bar	199, 81

Item	Page
⑦ ABC vehicle level control button	225
⑧ ESP® switch	91
⑨ Thumbwheel for setting following distance for Distronic*	221
⑩ Distance warning function* on/off switch	224
⑪ Program mode selector switch for automatic transmission	177

## ▼ Overhead control panel

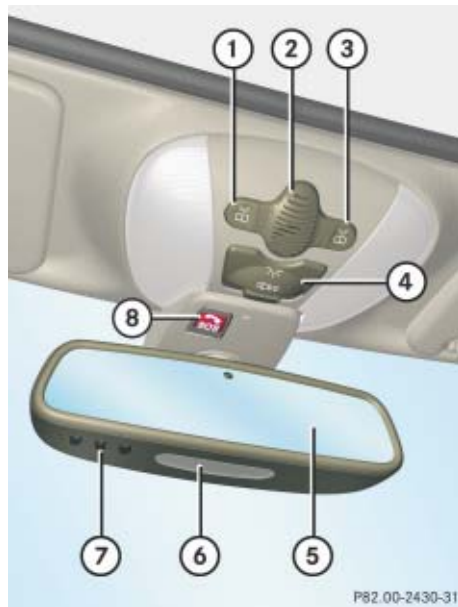

Item	Page
① Left reading lamp on/off	134
② Temperature sensor for automatic climate control	184
③ Right reading lamp on/off	134
④ Interior lighting control	134
⑤ Interior rear view mirror	47, 180
⑥ Reading lamp	134
⑦ Garage door opener	251
⑧ Tele Aid (emergency call system) button	244

Storage compartments

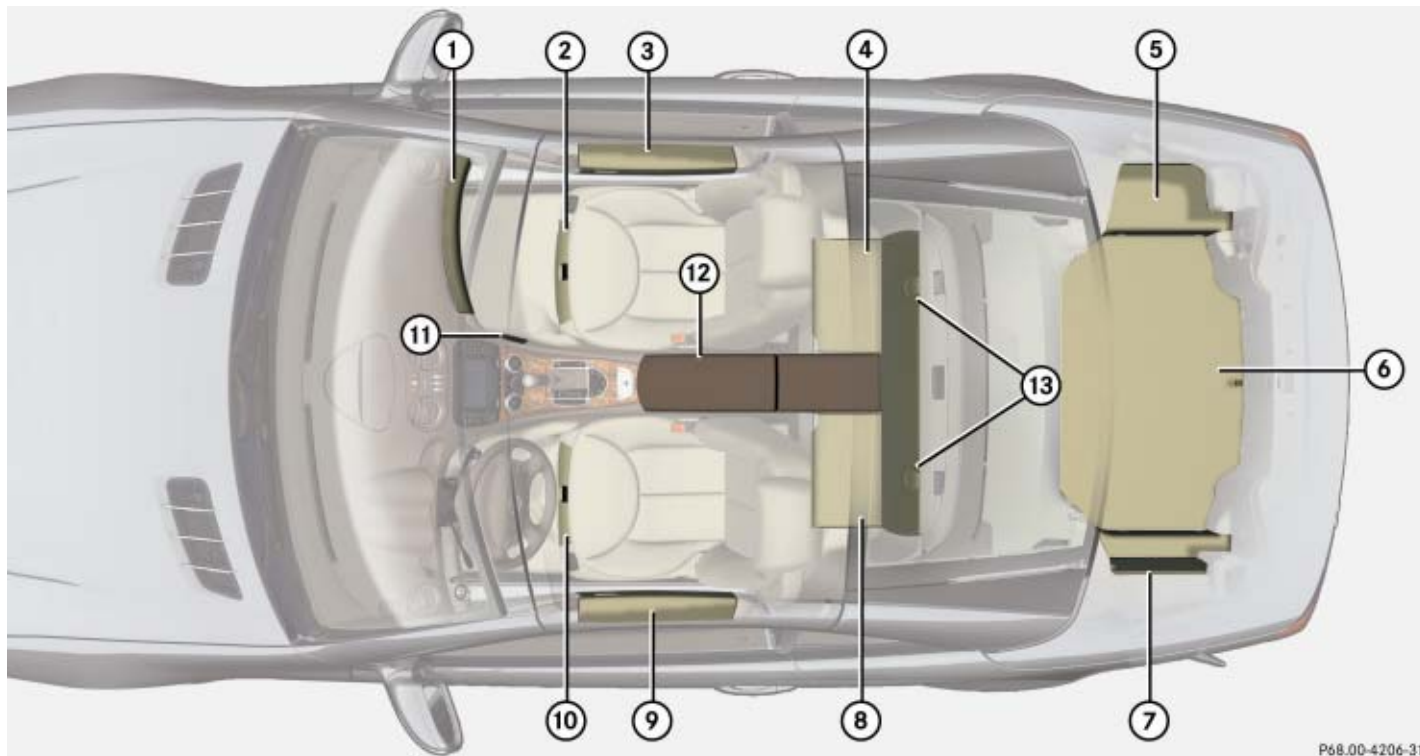

P68.00-4206-31

	Item	Page
①	Glove box	233
②	Passenger seat storage compartment	234
	First aid kit	388
③	Door storage compartment	233
④	Rear storage compartment, passenger side	235
	CD changer	235
⑤	Side storage compartment in trunk, parcel net	237
⑥	Trunk	
	Vehicle tool kit, jack, spare wheel	388
	Load assist	241
	Luggage cover	205
	Trunk load	443
	Load limit	288

	Item	Page
⑦	Navigation computer (refer to separate Operator's Manual)	
⑧	Rear storage compartment, driver's side	235
⑨	Door storage compartment	233
⑩	Driver's seat storage compartment	234
⑪	Parcel net in passenger footwell	236
⑫	Armrest storage compartment	234
	Armrest storage tray	234
⑬	Luggage straps	237

### Door control panel



Item	Page
① Inside door handle	111
② Switches for opening/closing door and rear side windows	196
③ Storing seat, mirror and steering wheel settings (Memory function)	126
④ Seat heating switch	123
Seat ventilation* switch	125
⑤ Seat adjustment switch	42, 121
⑥ Remote trunk opening switch	112
Remote trunk opening/closing* switch	113

Unlocking

Adjusting

Driving

Parking and locking



### Unlocking





The “Getting started” section provides an overview of the vehicle’s most basic functions. First-time Mercedes-Benz owners should pay special attention to the information given here.

If you are already familiar with the basic functions described here, the “Controls in detail” section will provide you with further information. The corresponding page references are located at the end of each segment.

#### Unlocking with the SmartKey



#### SmartKey with remote control

- ①  Lock button
- ②  Unlock button for trunk lid
- ③  Unlock button
- ④  PANIC Panic button

- ▶ Press unlock button  on the SmartKey.

All turn signal lamps flash once. The locking knobs in the doors move up. The anti-theft alarm system is disarmed.

The electro-hydraulic brake system is activated.

- ▶ Enter the vehicle and insert the SmartKey in the starter switch.

#### Warning!



When leaving the vehicle, always remove the SmartKey from the starter switch, take it with you, and lock the vehicle. Do not leave children unattended in the vehicle, or with access to an unlocked vehicle. Unsupervised use of vehicle equipment may cause an accident and/or serious personal injury.

**i** Opening a door causes the windows on that side of the car to open slightly. They will return to the up-position when the door is closed.

For more information, see “SmartKey” (▷ page 102).

## Unlocking with KEYLESS-GO\*

With the KEYLESS-GO function, you can lock and unlock the vehicle without using the remote control buttons on the SmartKey and start the engine without inserting the SmartKey in the starter switch.

The function of the SmartKey overrules the KEYLESS-GO function.

### Warning!



When leaving the vehicle, always take the SmartKey with KEYLESS-GO\* with you, and lock the vehicle. Do not leave children unattended in the vehicle, or with access to an unlocked vehicle. Unsupervised use of vehicle equipment may cause an accident and/or serious personal injury.

**i** To unlock the vehicle, the SmartKey with KEYLESS-GO must be outside the vehicle, no further than approx. 3 feet (1 meter) away from the door.

- ▶ Grasp an outside door handle.

All turn signal lamps flash once. The locking knobs on the doors move up. The anti-theft alarm system is disarmed.

The electro-hydraulic brake system is activated.

**i** If the vehicle has been parked for more than 72 hours, you must pull an outside door handle in order to activate the KEYLESS-GO function.

If the SmartKey with KEYLESS-GO is inside the vehicle, pressing the KEYLESS-GO start/stop button on the gear selector lever corresponds to turning the SmartKey to the various starter switch positions (▷ page 40).

**i** Opening a door causes the windows on that side of the car to open slightly. They will return to the up-position when the door is closed.

For more information, see “SmartKey with KEYLESS-GO\*” (▷ page 105).

## Starter switch positions

### Warning!



When leaving the vehicle, always remove the SmartKey or the SmartKey with KEYLESS-GO\* from the starter switch, take it with you, and lock the vehicle. Do not leave children unattended in the vehicle, or with access to an unlocked vehicle. Unsupervised use of vehicle equipment may cause an accident and/or serious personal injury.



## Unlocking

### SmartKey

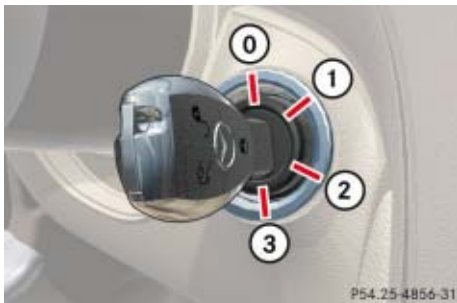

### Starter switch

**0** For removing SmartKey

**1** Power supply for some electrical consumers, such as seat adjustment

**2** Ignition (power supply for all electrical consumers) and driving position

All lamps (except high beam headlamp indicator lamp and turn signal indicator lamps unless activated) in the instrument cluster come on. If a lamp in the instrument cluster fails to come on when the ignition is switched on, have it checked and replaced if necessary.

If a lamp in the instrument cluster remains on after starting the engine or comes on while driving, refer to “Lamps in the instrument cluster” (▷ page 332).

### 3 Starting position

**i** When you switch on the ignition, the indicator and warning lamps (except high beam headlamp indicator lamp and turn signal indicator lamps unless activated) in the instrument cluster come on. The indicator and warning lamps (except high beam headlamp indicator lamp and turn signal indicator lamps if activated) should go out when the engine is running. This indicates that the respective systems are operational.

**i** The SmartKey can only be removed from the starter switch with the gear selector lever in position **P**.

**!** If the SmartKey cannot be turned in the starter switch, the starter battery may not be sufficiently charged.

- Check the starter battery and charge it if necessary (▷ page 414).
- Get a jump start (▷ page 419).

To prevent accelerated battery discharge or a completely discharged battery, always remove the SmartKey from the starter switch when the engine is not in operation.

### SmartKey with KEYLESS-GO\*



### KEYLESS-GO start/stop button

- ① USA only
- ② Canada only

The SmartKey with KEYLESS-GO must be located in the vehicle.

- ▶ Make sure the gear selector lever is set to **P**.
- ▶ Do not depress the brake pedal.

### **Position 0**

Before you press the KEYLESS-GO start/stop button, the vehicle's on-board electronics have the status **0** (as with SmartKey removed).

### **Position 1**

- ▶ Press the KEYLESS-GO start/stop button once.

This supplies power for some electrical consumers, such as seat adjustment.

**i** If you now press the KEYLESS-GO start/stop button

- once again, the ignition (position 2) is switched on
- twice, the power supply is again switched off

### **Ignition (or Position 2)**

- ▶ Press the KEYLESS-GO start/stop button twice.

This supplies power for all electrical consumers. All lamps (except high beam headlamp indicator lamp and turn signal indicator lamps unless activated) in the instrument cluster come on.

**i** If you now press the KEYLESS-GO start/stop button once, the power supply is again switched off.

**i** When you switch on the ignition, the indicator and warning lamps (except high beam headlamp indicator lamp and turn signal indicator lamps unless activated) in the instrument cluster come on. The indicator and warning lamps (except high beam headlamp indicator lamp and turn signal indicator lamps if activated) should go out when the engine is running. This indicates that the respective systems are operational.

For more information, see “SmartKey with KEYLESS-GO\*” (▷ page 105).

For information on starting the engine using the KEYLESS-GO start/stop button, see “Starting with KEYLESS-GO\*” (▷ page 53).

### Adjusting

#### Warning!



All seat, head restraint, steering wheel, and rear view mirror adjustments, as well as fastening of seat belts, must be done before the vehicle is put into motion.

### Seats

#### Warning!



Do not adjust the driver's seat while driving. Adjusting the seat while driving could cause the driver to lose control of the vehicle.

Never ride in a moving vehicle with the seat backrest in an excessively reclined position as this can be dangerous. You could slide under the seat belt in a collision. If you slide under it, the belt would apply force at the abdomen or neck. That could cause serious or fatal injuries. The seat backrest and seat belts provide the best restraint when the wearer is in a nearly upright position and belts are properly positioned on the body. Your seat must be adjusted so that you can correctly fasten your seat belt (▷ page 49).

Never place hands under the seat or near any moving parts while a seat is being adjusted.

#### Warning!



When leaving the vehicle, always remove the SmartKey or the SmartKey with KEYLESS-GO\* from the starter switch, take it with you, and lock the vehicle.

Even with the SmartKey or the SmartKey with KEYLESS-GO\* removed from the starter switch or the SmartKey with KEYLESS-GO\* removed from the vehicle, the power seats can be operated when the respective door is open. Therefore, do not leave children unattended in the vehicle, or with access to an unlocked vehicle. Unsupervised use of vehicle equipment may cause an accident and/or serious personal injury.

**Warning!**

Children 12 years old and under must be seated and properly secured in an appropriate infant or child restraint recommended for the size and weight of the child.

The infant or child restraint must be properly secured with the vehicle's seat belt fully in accordance with the child seat manufacturer's instructions.

A child's risk of serious or fatal injuries is significantly increased if the child restraints are not properly secured in the vehicle and the child is not properly secured in the child restraint.

**Seat adjustment**

The seat adjustment switch is located in the door.



- ① Head restraint height
- ② Seat height
- ③ Seat cushion tilt
- ④ Seat cushion depth
- ⑤ Seat fore and aft adjustment
- ⑥ Seat backrest tilt

▶ Switch on the ignition (▷ page 39).

or

▶ Open the respective door.

**i** The memory function (▷ page 126) lets you store the settings for the seat position together with the settings for the steering wheel and the exterior rear view mirrors.

**Seat fore and aft adjustment**

▶ Press the switch forward or backward in direction of arrow ⑤.

Adjust seat to a comfortable seating position that still allows you to reach the accelerator / brake pedal safely. The position should be as far to the rear as possible, consistent with ability to properly operate controls.

**!** When moving the seats, make sure there are no items in the footwell or behind the seats. Otherwise you could damage the seats.

### Adjusting

#### Seat height

- ▶ Press the switch up or down in direction of arrow ②.

#### Seat cushion tilt

- ▶ Press the switch up or down in direction of arrow ③ until your upper legs are lightly supported.

#### Seat cushion depth

- ▶ Press the switch forward or backward in direction of arrow ④ until your legs are supported comfortably.

#### Seat backrest tilt

- ▶ Press the switch forward or backward in direction of arrow ⑥ until your arms are slightly angled when holding the steering wheel.

#### Head restraint height

- ▶ Press the switch up or down in direction of arrow ①.

#### Warning!



For your protection, drive only with properly positioned head restraints.

Adjust head restraint so that it is as close to the head as possible and the center of the head restraint supports the back of the head at eye level. This will reduce the potential for injury to the head and neck in the event of an accident or similar situation.

Do not drive the vehicle without the seat head restraints. Head restraints are intended to help reduce injuries during an accident.

**i** When moving the seat fore or aft after adjusting the head restraints, the head restraints may readjust automatically.

#### Head restraint tilt

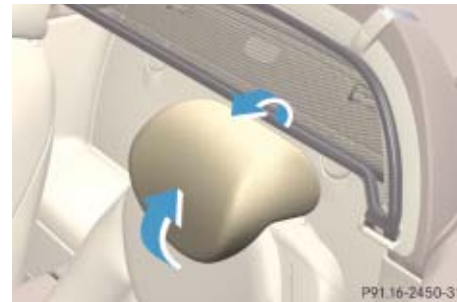

Manually adjust the angle of the head restraint.

- ▶ Push or pull on the lower edge of the head restraint cushion.

For more information on seats, see “Seats” (▷ page 121).

## Steering wheel

### Warning!



Do not adjust the steering wheel while driving. Adjusting the steering wheel while driving could cause the driver to lose control of the vehicle.

When leaving the vehicle, always remove the SmartKey or the SmartKey with KEYLESS-GO\* from the starter switch, take it with you, and lock the vehicle.

Even with the SmartKey or the SmartKey with KEYLESS-GO\* removed from the starter switch or the SmartKey with KEYLESS-GO\* removed from the vehicle, the steering wheel adjustment feature can be operated when the driver's door is open. Therefore, do not leave children unattended in the vehicle, or with access to an unlocked vehicle. Unsupervised use of vehicle equipment may cause an accident and/or serious personal injury.

**i** The memory function (▷ page 126) lets you store the settings for the steering wheel together with the settings for the seat position and the exterior rear view mirrors.

Make sure that

- you can reach the steering wheel with your arms slightly bent at the elbows
- you can move your legs freely
- all displays (including malfunction and indicator lamps) on the instrument cluster are clearly visible

## Steering wheel adjustment

The steering wheel adjustment stalk is located on the lower left of the steering column.



- ① Adjusting steering wheel, in or out
  - ② Adjusting steering wheel, up or down
- ▶ Switch on the ignition (▷ page 39).  
or  
▶ Open the driver's door.

### Adjusting

#### *Adjusting steering wheel in or out*

- ▶ Move stalk forward or back in direction of arrow ① until a comfortable steering wheel position is reached with your arms slightly bent at the elbow.

#### *Adjusting steering wheel up or down*

- ▶ Move stalk up or down in direction of arrow ②.

For more information, see “Heated steering wheel\*\*” (▷ page 240).

#### **Easy-entry/exit feature**

This feature allows for easier entry into and exit from the vehicle. When entering and exiting the vehicle, the steering wheel is in its uppermost position.

The easy-entry/exit feature can be activated or deactivated in the Convenience sub-menu of the control system (▷ page 162).

#### **Warning!**



You must make sure no one can become trapped or injured by the moving steering wheel when the easy-entry/exit feature is activated.

To stop steering wheel adjustment, do one of the following:

- Move steering wheel adjustment stalk (▷ page 45).
- Press one of the memory position buttons\* or the memory button **M\*** (▷ page 126).

Do not leave children unattended in the vehicle, or with access to an unlocked vehicle. Children could open the driver's door and unintentionally activate the easy-entry/exit feature, which could result in an accident and/or serious personal injury.

With the easy-entry/exit feature activated, the steering wheel will return to its last set position when you:

- close the driver's door with the ignition switched on
- or
- insert the SmartKey into the starter switch or press the KEYLESS-GO\* start/stop button (▷ page 40) once with the driver's door closed

**i** *The last set steering wheel position is stored when*

- *the ignition is switched off (▷ page 39)*
- *the position is stored in memory (▷ page 126)*

With the easy-entry/exit feature activated, the steering wheel tilts upwards when you

- remove the SmartKey from the starter switch  
or
- open the driver's door with the SmartKey in starter switch position **0** or **1** or the KEYLESS-GO\* start/stop button in position **1** (▷ page 40)

**i** *If the current position for the steering wheel is in the uppermost tilt position, the steering wheel will no longer be able to move upward when the easy-entry/exit feature is activated.*

*The adjustment procedure is briefly interrupted when the engine is started.*

### Warning!



Let the system complete the adjustment procedure before setting the vehicle in motion. All steering wheel adjustment must be completed before setting the vehicle in motion. Driving off with the steering wheel still adjusting could cause the driver to lose control of the vehicle.

## Mirrors

Adjust the interior and exterior rear view mirrors before driving so that you have a good view of the road and traffic conditions.

### Warning!



In case of an accident, liquid electrolyte may escape the mirror housing if the mirror glass breaks.

Electrolyte has an irritating effect. Do not allow the liquid to come into contact with eyes, skin, clothing, or respiratory system. In case it does, immediately flush affected area with water, and seek medical help if necessary.

**!** *Electrolyte drops coming into contact with the vehicle paint finish can only be completely removed while in their liquid state and by applying plenty of water.*



### Adjusting

#### Interior rear view mirror

- ▶ Manually adjust the interior rear view mirror.

For more information, see “Rear view mirrors” (▷ page 180).

#### Exterior rear view mirrors

##### Warning!



Exercise care when using the passenger side exterior rear view mirror. The mirror surface is convex (outwardly curved surface for a wider field of view). Objects in mirror are closer than they appear. Check your interior rear view mirror or glance over your shoulder before changing lanes.

The buttons are located on the lower part of the center console.



- ① Driver's side exterior rear view mirror button
  - ② Passenger-side exterior rear view mirror button
  - ③ Adjustment button
- ▶ Switch on the ignition (▷ page 39).
  - ▶ Press button ① or button ② to select the desired exterior rear view mirror.
  - ▶ Push adjustment button ③ up, down, left, or right according to the desired setting.

**!** If an exterior rear view mirror was forcibly pushed forward (hit from the rear) or forcibly pushed rearward (hit from the front), reposition it by applying firm pressure until it snaps into place. The mirror housing is then properly positioned and you can adjust the mirror in the usual manner.

**i** At low ambient temperatures, the exterior rear view mirrors will be heated automatically.

**i** The memory function (▷ page 126) lets you store the setting for the exterior rear view mirrors together with the settings for the steering wheel and the seat position.

For more information, see “Good visibility” (▷ page 180).

## ▼ Driving

### Warning!



Make sure that absolutely no objects are obstructing the pedal's range of movement. Keep the driver's footwell clear of all obstacles. If there are any floor mats or carpets in the footwell, make sure the pedals still have sufficient clearance.

During sudden driving or braking maneuvers, the objects could get caught between the pedals. You could then no longer brake or accelerate. This could lead to accidents or injury.

## Fastening the seat belts

### Warning!



Always fasten your seat belt before driving off. Always make sure your passengers are properly restrained, even pregnant women.

Failure to wear and properly fasten and position your seat belt greatly increases your risk of injuries and their likely severity in an accident. You and your passenger should always wear seat belts.

If you are ever in an accident, your injuries can be considerably more severe without your seat belt properly buckled. Without your seat belt buckled, you are much more likely to hit the interior of the vehicle or be ejected from it. You can be seriously injured or killed.

In the same crash, the possibility of injury or death is lessened if you are wearing your seat belt. The air bags can only provide the protection they were designed to afford if the occupants are using their seat belts (▷ page 66).

### Warning!



Children 12 years old and under must be seated and properly secured in an appropriate infant, or toddler restraint, or booster seat recommended for the size and weight of the child. For additional information, see "Children in the vehicle" (▷ page 83).

A child's risk of serious or fatal injuries is significantly increased if the child restraints are not properly secured in the vehicle and the child is not properly secured in the child restraint.

### Driving

#### Warning!



Never let more people ride in the vehicle than there are seat belts available. Be sure everyone riding in the vehicle is correctly restrained with a separate seat belt. Never use a seat belt for more than one person at a time.

#### Warning!



Never ride in a moving vehicle with the seat backrest in an excessively reclined position as this can be dangerous. You could slide under the seat belt in a collision. If you slide under it, the belt would apply force at the abdomen or neck. That could cause serious or even fatal injuries. The seat backrest and seat belt provide the best restraint when the wearer is in a nearly upright position and the belt is properly positioned on the body.

#### Warning!



Read and observe the additional warning notices in the “Safety and Security” section (▷ page 77).

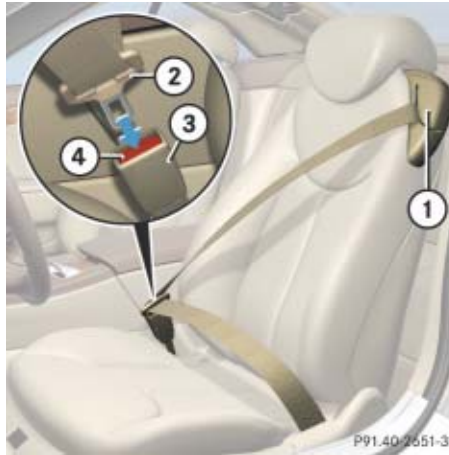

- ① Seat belt housing
- ② Latch plate
- ③ Buckle
- ④ Release button

- ▶ With a smooth motion, pull the belt from seat belt housing ①.
- ▶ Place the shoulder portion of the belt across the top of your shoulder and the lap portion across your hips.
- ▶ Push latch plate ② into buckle ③ until it clicks.
- ▶ If necessary, tighten the lap portion to a snug fit by pulling shoulder portion up.
- ▶ To release the seat belt, press release button ④ and guide latch plate back to seat belt housing ①.

### Proper use of seat belts

- Do not twist the belt when fastening.
  - Adjust seat belt so that the shoulder portion is located as close as possible to the middle of the shoulder (it should not touch the neck). Never pass the shoulder portion of the belt under your arm.
  - Position the lap belt as low as possible on your hips (over hip joint) and not across the abdomen.
  - Place the seat backrest in a nearly upright position.
  - Never use a seat belt for more than one person at a time.
- Do not fasten a seat belt around a person and another object at the same time. When using a seat belt to secure infant or toddler restraints or children in booster seats, always follow the child seat manufacturer's instructions
  - Check your seat belt during travel to make sure that it is properly positioned.
  - Make sure the seat belt is always fitted snugly. Take special care of this when wearing loose clothing.

### Warning!



Do not pass belts over sharp edges. They could tear.

Do not allow the belt to get caught in the door or in the seat adjustment mechanism. This could damage the belt.

Never attempt to make modifications to seat belts. This could impair the effectiveness of the belts.

Do not bleach or dye seat belts as this may severely weaken them. In a crash, they may not be able to provide adequate protection.

Damaged seat belts or belts that were highly stressed in an accident must be replaced. Contact an authorized Mercedes-Benz Center.

#### Starting the engine

##### Warning!



Inhalation of exhaust gas is hazardous to your health. All exhaust gas contains carbon monoxide (CO), and inhaling it can cause unconsciousness and possible death.

Do not run the engine in confined areas (such as a garage) which are not properly ventilated. If you think that exhaust gas fumes are entering the vehicle while driving, have the cause determined and corrected immediately. If you must drive under these conditions, drive with at least one window fully open.

#### Automatic transmission

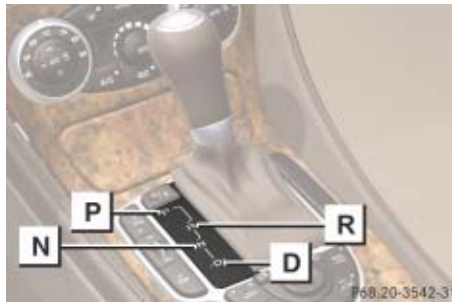

##### Gearshift pattern for automatic transmission

- P** Park position with gear selector lever lock
- R** Reverse gear
- N** Neutral
- D** Drive position

For more information, see “Automatic transmission” (▷ page 168).

#### Starting with the SmartKey

- ▶ Make sure the gear selector lever is set to **P**.
- ▶ Do not depress the accelerator.
- ▶ Turn the SmartKey in the starter switch to position **3** and hold until the engine starts (▷ page 40).

**i** You can also use the “touch-start” function. Turn the SmartKey to position **3** and release it again immediately. The engine then starts automatically.

For information on turning off the engine with the SmartKey, see “Turning off with the SmartKey” (▷ page 62).

**Starting with KEYLESS-GO\***

You can start your vehicle without the SmartKey in the starter switch using the KEYLESS-GO start/stop button on the gear selector lever.

**KEYLESS-GO start/stop button**

- ① USA only
- ② Canada only

- ▶ Make sure the gear selector lever is set to **P**.

- ▶ Depress the brake pedal during the starting procedure. Do not depress accelerator.
- ▶ Press the KEYLESS-GO start/stop button once.

The engine starts if the SmartKey with KEYLESS-GO is in the vehicle.

For information on turning off the engine with KEYLESS-GO, see "Turning off with KEYLESS-GO\*" (▷ page 62).

**Starting difficulties**

If the engine does not start as described, carry out the following steps:

- ▶ If you are starting the engine with the SmartKey: Turn SmartKey in starter switch to position **0** and repeat starting procedure.

- ▶ If you are starting the engine with KEYLESS-GO\*: Close any doors that may be open to allow for better detection of the SmartKey with KEYLESS-GO.

Or:

Start the engine with the SmartKey as radio signals from another source may be interfering with the SmartKey with KEYLESS-GO\*.

- ▶ Repeat the starting procedure (▷ page 52). Remember that extended starting attempts can drain the battery.
- ▶ Get a jump start (▷ page 419).

If the engine does not start after several starting attempts, there could be a malfunction in the engine electronics or in the fuel supply system.

- ▶ Contact an authorized Mercedes-Benz Center.

#### Parking brake



- ① Release handle
- ② Parking brake pedal

#### Warning!



When leaving the vehicle, always remove the SmartKey or the SmartKey with KEYLESS-GO\* from the starter switch, take it with you, and lock the vehicle. Do not leave children unattended in the vehicle, or with access to an unlocked vehicle. Children could release the parking brake, which could result in an accident and/or serious injury.

- ▶ Release the parking brake by pulling on release handle ①.

The indicator lamp **BRAKE** (USA only) or **Ⓟ** (Canada only) in the instrument cluster goes out.

#### Driving off

- ▶ Depress the brake pedal.
- ▶ Place the gear selector lever in position **D** or **R**.

#### Warning!



It is dangerous to shift the gear selector lever out of **P** or **N** if the engine speed is higher than idle speed. If your foot is not firmly on the brake pedal, the vehicle could accelerate quickly forward or in reverse. You could lose control of the vehicle and hit someone or something. Only shift into gear when the engine is idling normally and when your right foot is firmly on the brake pedal.

**Warning!**

On slippery road surfaces, never downshift in order to obtain braking action. This could result in drive wheel slip and reduced vehicle control. Your vehicle's ABS will not prevent this type of loss of control.

**!** In order to avoid damage to the transmission:

- Wait for the gear selection process to complete before setting the vehicle in motion.
  - Place the gear selector lever in position **D** or **R** only when the vehicle is stopped.
- ▶ Release the brake pedal.
- ▶ Carefully depress the accelerator pedal.

Once the vehicle is in motion, the automatic central locking system engages and the locking knobs drop down.

**!** If you hear a warning signal and the message **Release parking brake** appears in the multifunction display when driving off, you have forgotten to release the parking brake.

*Release the parking brake.*

After a cold start, the transmission engages at a higher revolution. This allows the catalytic converter to reach its operating temperature earlier.

**!** Do not run cold engine at high engine speed. Running a cold engine at high engine speed may shorten the service life of the engine.

**!** Simultaneously depressing the accelerator pedal and applying the brake reduces engine performance and causes premature brake and drivetrain wear.

**i** You can open a locked door from the inside. Open door only when conditions are safe to do so.

You can deactivate the automatic locking using the control system (▷ page 162).

**Switching on headlamps****Low beam headlamps**

The exterior lamp switch is located on the dashboard to the left of the steering wheel.

**Exterior lamp switch**

- ① Off
  - ② Low beam headlamps on
- ▶ Turn the exterior lamp switch to position .

The low beam headlamps come on.



### Driving

#### High beam

The combination switch is located on the left of the steering column.



#### Combination switch

- ① High beam
- ② High beam flasher

► Push the combination switch in direction of arrow ①.

The high beam headlamps come on.

The high beam headlamp indicator  in the instrument cluster comes on (▷ page 29).

For more information, see “Lighting” (▷ page 128).

#### Turn signals



The combination switch is located on the left of the steering column.



#### Combination switch

- ① Turn signals, right
- ② Turn signals, left

► Press the combination switch in direction of arrow ① or ②.

The corresponding turn signal indicator lamp  or  in the instrument cluster flashes (▷ page 27).

The combination switch resets automatically after major steering wheel movements.

**i** To signal minor directional changes such as changing lanes, press combination switch only to point of resistance and release. The corresponding turn signals will flash three times.

## Windshield wipers

The combination switch is located on the left of the steering column.

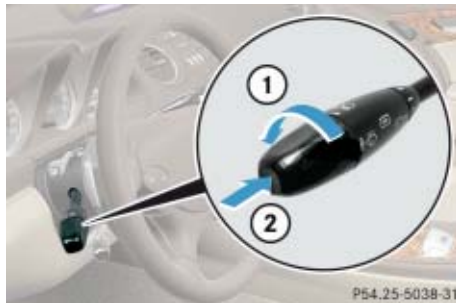

### Combination switch

- ① Switching on windshield wipers
- ② Single wipe
  - Wiping with windshield washer fluid
- ▶ Switch on the ignition (▷ page 39).

**!** Do not operate the windshield wipers when the windshield is dry. Dust that accumulates on a windshield might scratch the glass and/or damage the wiper blades when wiping occurs on a dry windshield. If it is necessary to operate the windshield wipers in dry weather conditions, always operate the windshield wipers with windshield washer fluid (▷ page 58).

### Switching on windshield wipers

- ▶ Turn the combination switch in direction of arrow ① to the desired position, depending on the intensity of the rain.
  - 0 Windshield wipers off
  - I Intermittent wiping
  - II Normal wiper speed
  - III Fast wiper speed

### Intermittent wiping

**!** Do not leave windshield wipers in intermittent setting when the vehicle is taken to an automatic car wash or during windshield cleaning. Windshield wipers will operate in the presence of water sprayed on the windshield, and windshield wipers may be damaged as a result.

**!** If you have set intermittent wiping, dirt on the surface of the rain sensor or optical effects may cause the windshield wipers to wipe in an undesired fashion. This could then damage the windshield wiper blades or scratch the windows. You should therefore switch off the windshield wipers when weather conditions are dry.

The intermittent wiping interval is dependent on the wetness of the windshield.

- ▶ Turn the combination switch in direction of arrow ① to position I.

After the initial wipe, pauses between wipes are controlled by the rain sensor. ▷▷

### Driving

- ▷▷ **i** *Intermittent wiping is interrupted when the vehicle is at a standstill and a front door is opened. This protects persons getting into or out of the vehicle from being sprayed.*

*Intermittent wiping will be continued when*

- *all doors are closed and the gear selector lever is in position **D** or **R***  
*or*
- *the wiper setting is changed using the combination switch*

#### Single wipe

- ▶ Press the combination switch briefly in direction of arrow ② to the resistance point.

The windshield wipers wipe one time without washer fluid.

#### Wiping with windshield washer fluid

- ▶ Push the combination switch in direction of arrow ② past the resistance point.

The windshield wipers operate with washer fluid.

- i** *To prevent smears on the windshield, wipe with windshield washer fluid every now and then even when it is raining.*

For information on filling up the washer reservoir, see “Windshield washer system and headlamp cleaning system” (▷ page 282).

- !** *If anything blocks the windshield wipers (leaves, snow, etc.), switch them off immediately.*

- *For safety reasons, stop the vehicle in a safe location and*
  - *remove the SmartKey from the starter switch*  
*or*
  - *turn off the engine by pressing the KEYLESS-GO\* start/stop button and open the driver's door (with the driver's door open, the starter switch is in position **0**, same as with the SmartKey removed from the starter switch)*

*before attempting to remove any blockage.*

- *Remove blockage.*
- *Turn the windshield wipers on again.*

*If the windshield wipers fail to function at all in switch position **I**,*

- *set the combination switch to the next higher wiper speed*
- *have the windshield wipers checked at the nearest authorized Mercedes-Benz Center*

## Problems while driving

---

### The engine runs erratically and misfires

- An ignition cable may be damaged.
- The engine electronics may not be operating properly.
- Unburned gasoline may have entered the catalytic converter and damaged it.
- ▶ Give very little gas.
- ▶ Have the problem repaired by an authorized Mercedes-Benz Center as soon as possible.

### The coolant temperature gauge is above 248°F (120°C)

The coolant is too hot and is no longer cooling the engine.

- ▶ Stop the vehicle as soon as possible in a safe location and turn off the engine. Allow engine and coolant to cool.
- ▶ Check the coolant level and add coolant if necessary (▷ page 280).

### In case of accident

If the vehicle is leaking gasoline:

- ▶ Do not start the engine under any circumstances.
- ▶ Notify local fire and/or police authorities.

If the extent of the damage cannot be determined:

- ▶ Notify an authorized Mercedes-Benz Center.

If no damage can be determined on the

- major assemblies
- fuel system
- engine mount:
- ▶ Start the engine in the usual manner.

### Parking and locking

You have now completed your first drive. You have properly stopped and parked your vehicle. End your drive as follows.

#### Warning!



With the engine not running, there is no power assistance for the brake and steering systems. In this case, it is important to keep in mind that a considerably higher degree of effort is necessary to brake and steer the vehicle.

#### Warning!



Do not park this vehicle in areas where combustible materials such as grass, hay or leaves can come into contact with the hot exhaust system, as these materials could be ignited and cause a vehicle fire.

To reduce the risk of personal injury as a result of vehicle movement, before turning off the engine and leaving the vehicle always:

- Keep right foot on brake pedal.
- Firmly depress parking brake pedal.
- Move the gear selector lever to position **P**.
- Slowly release brake pedal.

- When parked on an incline, turn front wheels towards the road curb.
- Turn the SmartKey in the starter switch to position **0** and remove the SmartKey from the starter switch, or press the start/stop button (vehicles with KEYLESS-GO\*).
- Take the SmartKey or the SmartKey with KEYLESS-GO\* and lock vehicle when leaving.

## Parking brake



- ① Release handle
- ② Parking brake pedal

- ▶ Step firmly on parking brake pedal ②.

When the engine is running, the indicator lamp **BRAKE** (USA only) or **(P)** (Canada only) in the instrument cluster will be illuminated.

### Warning!



When leaving the vehicle, always remove the SmartKey or the SmartKey with KEYLESS-GO\* from the starter switch, take it with you, and lock the vehicle. Do not leave children unattended in the vehicle, or with access to an unlocked vehicle. Children could release the parking brake and/or move the gear selector lever from position **P**, either of which could result in an accident and/or serious injury.

### Warning!



Getting out of your vehicle with the gear selector lever not fully engaged in position **P** is dangerous. Also, when parked on an incline, position **P** alone may not prevent your vehicle from moving, possibly hitting people or objects.

Always set the parking brake in addition to shifting to position **P** (▷ page 170).

When parked on an incline, also turn front wheels towards the road curb.

## Switching off headlamps

- ▶ Turn the exterior lamp switch to position **0** (▷ page 55).

For more information, see “Exterior lamp switch” (▷ page 128).

### Parking and locking

#### Turning off the engine

- ▶ Place the gear selector lever in position **P**.
- ▶ Apply the parking brake (▷ page 61).

**i** Always set the parking brake in addition to shifting to position **P**.

On slopes, turn the front wheels towards the road curb.

#### Turning off with the SmartKey

- ▶ Turn the SmartKey in the starter switch to position **0** (▷ page 40).
- ▶ Remove the SmartKey from the starter switch.

The immobilizer is activated.

**i** The SmartKey can only be removed from the starter switch with the gear selector lever in position **P**.

**i** With the SmartKey removed and the driver's door open, a warning sounds if the vehicle's exterior lamps are not switched off.

#### Turning off with KEYLESS-GO\*

- ▶ Place the gear selector lever in position **P**.
- ▶ Press the KEYLESS-GO start/stop button (▷ page 40) to turn off the engine.

With the driver's door closed, the starter switch is now in position **1**. With the driver's door opened, the starter switch is set to position **0**, same as SmartKey removed from starter switch (▷ page 40).

**i** If you hear a warning signal you have tried to turn off the engine while the gear selector lever was not in **P**.

In addition, the message **Gear selector lever to P** appears in the multifunction display.

Place the gear selector lever in position **P**.

#### Releasing seat belts

- ▶ Press the seat belt release button (▷ page 50).

Allow the retractor to completely rewind the seat belt by guiding the latch plate.

**!** Make sure the seat belt retracts fully so that the seat belt and/or latch plate cannot get caught or pinched in the door or in the seat mechanism. This can damage the seat belt and impair the effectiveness of the seat belt, and/or cause damage to the door and/or door trim panel. Such damage is not covered by the Mercedes-Benz Limited Warranty.

Damaged seat belts must be replaced. Contact an authorized Mercedes-Benz Center.

## Locking

### Warning!



To prevent possible personal injury, always keep hands and fingers away from the door openings when closing the doors. Be especially careful when small children are around.

Before closing doors, make sure that there is no possibility of someone getting caught in a door during closing.

### Warning!



When leaving the vehicle, always remove the SmartKey or the SmartKey with KEYLESS-GO\* from the starter switch, take it with you, and lock the vehicle. Do not leave children unattended in the vehicle, or with access to an unlocked vehicle. Unsupervised use of vehicle equipment may cause an accident and/or serious personal injury.

**i** If you hear a warning signal you have forgotten to turn off the headlamps.

*In addition the message Turn off lights appears in the multifunction display.*

*Switch off the headlamps.*

▶ Exit the vehicle and close the doors and the trunk.

**i** Vehicles with KEYLESS-GO\*: A warning signal and the message Don't forget your key remind you not to leave the SmartKey with KEYLESS-GO\* in the vehicle.

**i** Opening a door causes the windows on that side of the car to open slightly. They will return to the closed position when the door is closed.

## Locking with the SmartKey

▶ Press the lock button  on the SmartKey (▷ page 38).

With the trunk and all doors closed, all turn signal lamps flash three times. The locking knobs on the doors move down. The anti-theft alarm system is armed.

For more information, see “Locking and unlocking” (▷ page 102).



### Parking and locking

#### Locking with KEYLESS-GO\*

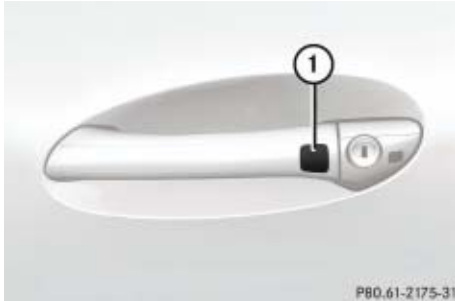

#### ① Lock button

- ▶ Press lock button ① on a door handle or the lock button on the trunk lid (▷ page 110).

With the trunk and all doors closed, the turn signal lamps flash three times. The locking knobs on the doors move down. The anti-theft alarm system is armed.

For more information, see “Locking and unlocking” (▷ page 102).

**Occupant safety**

**Panic alarm**

**Driving safety systems**

**Anti-theft systems**



### Occupant safety

In this section you will learn the most important facts about the restraint systems of the vehicle.

The restraint systems are

- Seat belts (▷ page 77)
- Child restraints (▷ page 83)

Additional protection potential provided by

- Supplemental Restraint System (SRS) with
  - Air bags (▷ page 68)
  - Air bag control unit (with crash sensors)
  - Emergency tensioning device (ETD) for seat belts (▷ page 81)
- Roll bar (▷ page 81)

Air bag system components with

- Front passenger front air bag off indicator lamp (▷ page 76)
- Front passenger seat with Occupant Classification System (OCS) (▷ page 72)

Although independent systems, their protective functions work in conjunction with each other.

**i** For information on infants and children traveling with you in the vehicle and restraint systems for infants and children, see “Children in the vehicle” (▷ page 83).

The SRS system conducts a self-test when the ignition is switched on and in regular intervals while the engine is running. This facilitates detection of malfunctions. The **SRS** indicator lamp in the instrument cluster comes on when the ignition is switched on and goes out no later than a few seconds after the engine has been started.

The SRS components are in operational readiness if the **SRS** indicator lamp is not lit when the engine is running.

A malfunction in the system has been detected if the **SRS** indicator lamp:

- fails to go out after approximately 4 seconds after the engine was started
- does not come on at all
- comes on after the engine was started or while driving

**Warning!**

Modifications to or work improperly conducted on restraint systems (such as seat belts and anchors, emergency tensioning devices, seat belt force limiters or air bags) or their wiring, as well as tampering with interconnected electronic systems, can lead to the restraint systems no longer functioning as intended.

Air bags or emergency tensioning devices, for example, could deploy inadvertently or fail to deploy in accidents although the deceleration threshold for air bag deployment is exceeded. Therefore, never modify the restraint systems. Do not tamper with electronic components or their software.

**Warning!**

In the event that the **SRS** indicator lamp comes on during driving or does not come on at all, the SRS self-check has detected a malfunction. For your safety, we strongly recommend that you visit an authorized Mercedes-Benz Center immediately to have the system checked; otherwise the SRS may not deploy when needed in an accident, which could result in serious or fatal injury, or it might deploy unexpectedly and unnecessarily which could also result in injury.

In addition, improper repair work on the SRS creates a risk of rendering the SRS inoperative or causing unintended air bag deployment. Work on the SRS must therefore only be performed by qualified technicians. Contact an authorized Mercedes-Benz Center.

If it is necessary to modify an air bag system to accommodate a person with disabilities, contact your local authorized Mercedes-Benz Center or call our Customer Assistance Center at 1-800-FOR-MERCEdes (1-800-367-6372) for details.

## Occupant safety

### Air bags

#### Warning!



Air bags are designed to reduce the potential of injury and fatality in certain frontal impacts (front air bags, driver-side knee bag) or side impacts (head-thorax air bags). However, no system available today can totally eliminate injuries and fatalities.

The deployment of the air bags temporarily releases a small amount of dust from the air bags. This dust, however, is neither injurious to your health, nor does it indicate a fire in the vehicle. The dust might cause some temporary breathing difficulty for people with asthma or other breathing trouble. To avoid this, you may wish to get out of the vehicle as soon as it is safe to do so. If you have any breathing difficulty but cannot get out of the vehicle after the air bag inflates, then get fresh air by opening a window or door.

#### Warning!



To reduce the risk of injury when the front air bags inflate, it is very important for the driver and passenger to always be in a properly seated position and to wear their seat belts.

For maximum protection in the event of a collision always be in normal seated position with your back against the backrest. Fasten your seat belt and make sure that it is properly positioned on your body (▷ page 49).

Since the air bag inflates with considerable speed and force, a proper seating and hands on steering wheel position will help to keep you at a safe distance from the air bag. Occupants who are unbelted, out of position or too close to the air bag can be seriously injured or killed by an air bag as it inflates with great force in the blink of an eye:

- Sit properly belted in a nearly upright position with your back against the seat backrest.

- Adjust the driver's seat as far as possible rearward, still permitting proper operation of vehicle controls. The distance from the center of the driver's breastbone to the center of the air bag cover on the steering wheel must be at least 10 inches (25 cm) or more. You should be able to accomplish this by a combination of adjustments to the seat and steering wheel. If you have any problems, please see an authorized Mercedes-Benz Center.
- Do not lean your head or chest close to the steering wheel or dashboard.
- Keep hands on the outside of steering wheel rim. Placing hands and arms inside the rim can increase the risk and potential severity of hand / arm injury when driver's front air bag inflates.
- Adjust the passenger seat as far as possible rearward from the dashboard when the seat is occupied.

- Occupants, especially children, should never lean their heads in the area of the door where the head-thorax air bag inflates. This could result in serious injuries or death should the air bag be triggered. Always sit nearly upright, properly use the seat belts and appropriate size infant or child restraint system.

Failure to follow these instructions can result in severe injuries to you or other occupants.

If you sell your vehicle, it is important that you make the buyer aware of this safety information. Be sure to give the buyer this Operator's Manual.

### Warning!



It should be noted, however, that there is a possibility for a head-thorax air bag related injury if occupants, especially children, are not properly seated or restrained when next to a head-thorax air bag which needs to deploy rapidly in a side impact in order to do its job.

To help avoid the possibility of injury, please follow these guidelines:

- (1) Occupants, especially children, should never place their bodies or lean their heads in the area of the door where the head-thorax air bag inflates. This could result in serious injuries or death should the head-thorax air bag be triggered.

- (2) Always sit nearly upright, properly use the seat belts and for children 12 years old and under, use an appropriately sized infant or toddler restraint or booster seat recommended for the size and weight of the child.

- (3) Always wear seat belts properly.

If you believe that, even with the use of these guidelines, it would be safer for your passenger seat occupants to have the passenger side head-thorax air bag deactivated, then deactivation can be accomplished upon your written election to do so at an authorized Mercedes-Benz Center at an additional cost. Please contact your local authorized Mercedes-Benz Center or call our Customer Assistance Center (in the USA) at 1-800-FOR-MERcedes, or Customer Service (in Canada) at 1-800-387-0100 for details.

### Occupant safety

**i** Air bags are designed to activate only in certain frontal impacts (front air bags, driver-side knee bag) and side impacts (head-thorax air bags) which exceed preset thresholds. Only during these events, will they provide their supplemental protection.

The driver and passenger should always wear their seat belts. Otherwise it is not possible for the air bags to provide their intended supplemental protection.

In case of other types of impacts and impacts below air bag deployment thresholds, air bags will not deploy. The driver and passenger will then be protected to the extent possible by a properly fastened seat belt. A properly fastened seat belt is also needed to provide the best possible protection in a rollover.

We caution you not to rely on the presence of the air bags in order to avoid wearing your seat belt.

It is important to your safety and that of your passenger that you replace deployed air bags and repair any malfunctioning air bags to make sure that the vehicle will continue to provide supplemental crash protection for occupants.

### Safety guidelines for the seat belt, emergency tensioning device and air bag

#### Warning!



- Damaged seat belts or belts that were highly stressed in an accident must be replaced and their anchoring points must also be checked. Only use belts installed or supplied by an authorized Mercedes-Benz Center.
- Air bags and pyrotechnic emergency tensioning devices (ETDs) are designed to function on a one-time-only basis. An air bag or ETD that has deployed must be replaced.
- Do not pass belts over sharp edges. They could tear.
- Do not make any modification that could change the effectiveness of the belts.

- No modifications of any kind may be made to any components or wiring of the SRS. This includes changing or removing any component or part of the SRS, the installation of additional trim material, badges, etc. over the steering wheel hub, passenger front air bag cover, door frame trims, or door trim panels, and installation of additional electrical /electronic equipment on or near SRS components and wiring. Keep area between air bags and occupants free from objects (e.g. packages, purses, umbrellas, etc.).
- Do not bleach or dye seat belts as this may severely weaken them. In a crash, they may not be able to provide adequate protection.
- Air bag system components will be hot after an air bag has inflated. Do not touch.
- Never place your feet on the instrument panel, dashboard, or on the seat. Always keep both feet on the floor in front of the seat.

- In addition, improper repair work on the SRS creates a risk of rendering the SRS inoperative or causing unintended air bag deployment. Work on the SRS must therefore only be performed by qualified technicians. Contact an authorized Mercedes-Benz Center.
- For your protection and the protection of others, when scrapping the air bag unit or emergency tensioning device, our safety instructions must be followed. These instructions are available from your authorized Mercedes-Benz Center.
- Given the considerable deployment speed, required inflation volume, and the textile structure of the air bags, there is the possibility of abrasions or other, potentially more serious injuries resulting from air bag deployment.

When you sell your vehicle, we strongly urge you to give notice to the subsequent owner that it is equipped with an SRS by alerting them to the applicable section in the Operator's Manual.

### Front air bags

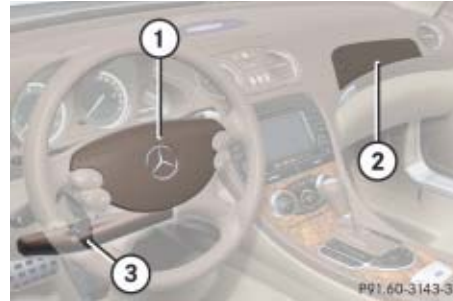

- ① Driver air bag
- ② Passenger air bag
- ③ Knee bag

Driver and passenger air bags are deployed:

- in the event of certain frontal impacts
- if impact exceeds a preset deployment threshold
- independently of the head-thorax air bags

**i** *The front air bags in this vehicle have been designed to inflate in two stages. This allows the air bag to have different rates of inflation that are based on the rate of relevant vehicle deceleration as assessed by the air bag control unit.*

*On the passenger side, the front air bag deployment is additionally influenced by the passenger's weight category as identified by the Occupant Classification System (OCS) (▷ page 72).*

*The lighter the passenger side occupant, the higher the vehicle deceleration rate required for the second stage inflation of the air bag.*

The air bags will not deploy in impacts which do not exceed the system's deployment thresholds. You will then be protected by the fastened seat belts.



### Occupant safety

The passenger front air bag will only be deployed if:

- the system, based on OCS weight sensor readings, senses that the front passenger seat is occupied
- the  indicator lamp in the center console is not lit (▷ page 76)
- the impact exceeds a preset deployment threshold

#### Knee bag

The knee bag is located on the driver-side lower instrument panel. It is designed to operate together with the driver air bag in certain frontal impacts exceeding a preset threshold. The knee bag operates best in conjunction with a properly positioned and fastened seat belt.

#### Head-thorax air bags

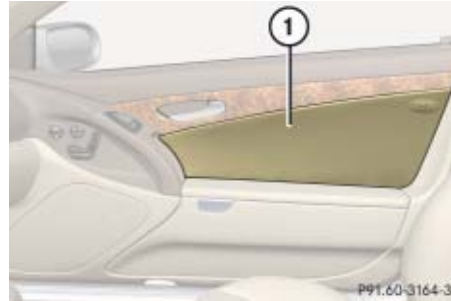

#### ① Head-thorax air bag

The head-thorax air bags are deployed:

- in impacts exceeding a preset deployment threshold
- on the impacted side of the vehicle
- independently of the front air bags

The head-thorax air bags are not deployed in impacts which do not exceed the system's deployment threshold.

#### Occupant Classification System

The Occupant Classification System (OCS) automatically turns the passenger front air bag on or off based on the classified occupant weight category determined by weight sensor readings from the passenger seat.

 *The system does not deactivate the head-thorax air bag and the emergency tensioning device.*

Occupants must sit properly belted in a nearly upright position with their back against the seat backrest and feet on the floor to be correctly classified. If the occupant's weight is transferred to another object in the vehicle (e.g. by leaning on armrests), the OCS may not be able to properly approximate the occupant's weight category.



**i** If the seat, including the trim cover and cushion needs to be serviced in any way, take the vehicle to an authorized Mercedes-Benz Center.

Only seat accessories approved by Mercedes-Benz may be used.

Both driver and the passenger should always use the  indicator lamp as an indication of whether or not the passenger is properly positioned.

### Warning!



If the  indicator lamp illuminates when an adult or someone larger than a small individual is in the passenger seat, have the passenger re-position himself or herself in the seat until the  indicator lamp goes out.

More information about air bag display messages (▷ page 356).

In the event of a collision, the air bag control unit will not allow passenger front air bag deployment when the OCS classified the passenger seat occupant as being up to or less than the weight of a typical 12-month-old child in a standard child restraint or if the passenger seat is sensed as being empty.



When the OCS senses that the passenger seat occupant is classified as being up to or less than the weight of a typical 12-month-old child in a standard child restraint, the  indicator lamp will illuminate when the engine is started and remain illuminated, indicating that the passenger front air bag is deactivated.

When the OCS senses that the passenger seat is classified as being empty, the  indicator lamp will illuminate when the engine is started and remain illuminated, indicating that the passenger front air bag is deactivated.





### Occupant safety



When the OCS senses that the passenger seat occupant is classified as being heavier than the weight of a typical 12-month-old child seated in a standard child restraint or as being a small individual (such as a young teenager or a small adult), the  indicator lamp will illuminate for approximately 6 seconds when the engine is started and then, depending on occupant weight sensor readings from the seat, remain illuminated or go out. With the  indicator lamp illuminated, the passenger front air bag is deactivated. With the  indicator lamp out, the passenger front air bag is activated.

When the OCS senses that the passenger seat occupant is classified as an adult or someone larger than a small individual, the  indicator lamp will illuminate for approximately 6 seconds when the engine is started and then go out, indicating that the passenger front air bag is activated.

If the  indicator lamp is illuminated, the passenger front air bag is deactivated and will not be deployed.

If the  indicator lamp is not illuminated, the passenger front air bag is activated and will be deployed:

- in the event of certain frontal impacts
- if impact exceeds a preset deployment threshold
- independently of the head-thorax air bags.

If the passenger front air bag is deployed, the rate of inflation will be influenced by:

- the rate of relevant vehicle deceleration as assessed by the air bag control unit
- passenger's weight category as identified by the Occupant Classification System (OCS).

### Warning!













Children 12 years old and under must be seated and properly secured in an appropriate infant or child restraint recommended for the size and weight of the child.

The infant or child restraint must be properly secured with the vehicle's seat belt fully in accordance with the child seat manufacturer's instructions.

Children can be killed or seriously injured by an inflating air bag. Note the following important information:

- Your vehicle is equipped with air bag technology designed to turn off the passenger front air bag in your vehicle when the system senses the weight of a typical 12-month-old child or less along with the weight of a standard appropriate child restraint on the passenger seat.

- A child in a rear-facing child restraint on the passenger seat will be seriously injured or even killed if the passenger front air bag inflates in a collision which could occur under some circumstances, even with the air bag technology installed in your vehicle.
- If you install a rear-facing child restraint on the passenger seat, make sure that the   indicator lamp is illuminated, indicating that the passenger front air bag is deactivated. Should the   indicator lamp not illuminate or go out while the restraint is installed, please check installation. Periodically check the   indicator lamp while driving to make sure the   indicator lamp is illuminated. If the   indicator lamp goes out or remains out, do not transport a child on the passenger seat until the system has been repaired. A child in a rear-facing child restraint on the passenger seat will be seriously injured or even killed if the passenger front air bag inflates.

- If you place a child in a forward-facing child restraint on the passenger seat, move the seat as far back as possible, use the proper child restraint recommended for the age, size and weight of the child, and secure child restraint with the vehicle's seat belt according to the child seat manufacturer's instructions. For children larger than the typical 12-month-old child, the passenger front air bag may or may not be activated (▷ page 74).

 *Deployment of the driver front air bag does not mean that the passenger front air bag also should have deployed.*

*The Occupant Classification System (▷ page 72) may have determined:*

- *that the seat was empty or occupied by the weight up to or less than that of a typical 12-month-old child seated in a standard child restraint – both instances where the system suppresses deployment of the passenger front air bag even though the impact met the criteria and was of sufficient severity to deploy the driver front air bag.*
- *that the seat was occupied by a small individual (such as a young teenager or a small adult) or a child weighing more than the weight of a typical 12-month-old child in a standard child restraint – instances where the system may suppress deployment of the passenger front air bag even though the impact met the criteria and was of sufficient severity to deploy the driver front air bag.*

### Occupant safety

The  **PASS AIR BAG OFF** indicator lamp is located in the upper part of the center console, between the center air vents.



① Front passenger front air bag off indicator lamp

The  **PASS AIR BAG OFF** indicator lamp ① will be illuminated, except with the SmartKey removed or in starter switch position **0**.

### Warning!





If the **SRS** indicator lamp and the  **PASS AIR BAG OFF** indicator lamp are lit at the same time, there is a malfunction in the Occupant Classification System. The passenger front air bag will be deactivated in this case.

In order to ensure proper operation of the air bag system and OCS:

- Have the system checked as soon as possible by qualified technicians. Contact an authorized Mercedes-Benz Center.
- Sit properly belted in a nearly upright position with your back against the seat backrest.
- Do not lean on the armrests or lift yourself from the seat by using the handle over the door as this may cause the OCS to be unable to correctly approximate the occupant weight category.

- Only have the seat repaired or replaced by an authorized Mercedes-Benz Center.
- Read and observe all warnings in this chapter.

### Self-test Occupant Classification System

After turning the SmartKey in the starter switch to position **1** or **2** or pressing the KEYLESS-GO\* start/stop button once or twice, the  **PASS AIR BAG OFF** indicator lamp located in the upper part of the center console, between the center air vents illuminates. If an adult occupant is properly sitting on the passenger seat and the system senses the occupant as being an adult, the  **PASS AIR BAG OFF** indicator lamp will illuminate and go out after approximately 6 seconds.

If the seat is not occupied and the system senses the passenger seat as being empty, the  **PASS AIR BAG OFF** indicator lamp will illuminate and not go out.

**Warning!**

If the  indicator lamp should not illuminate, the system is not functioning. You must see an authorized Mercedes-Benz Center before seating any child on the passenger seat.

More information can be found in the “Practical hints” section (▷ page 345).

**Warning!**

Never place anything between seat cushion and child seat (e.g. pillow), since it reduces the effectiveness of the Occupant Classification System. The bottom of the child seat must make full contact with the passenger seat cushion. An incorrectly mounted child seat could cause injuries to the child in case of an accident, instead of increasing protection for the child.

Follow the manufacturer’s instructions for installation of child seats.

**Seat belts**

The use of seat belts and infant and child restraint systems is required by law in all 50 states, the District of Columbia, the U.S. territories and all Canadian provinces.

Even where this is not the case, we strongly recommend that all vehicle occupants have their seat belts fastened and wear them properly.

For information on fastening seat belts, see “Fastening the seat belts” (▷ page 49).

 *For information on infants and children traveling with you in the vehicle and restraint systems for infants and children, see “Children in the vehicle” (▷ page 83).*

**Warning!**

Always fasten your seat belt before driving off. Always make sure your passengers are properly restrained, even pregnant women.

Failure to wear and properly fasten and position your seat belt greatly increases your risk of injuries and their likely severity in an accident. You and your passenger should always wear seat belts.

If you are ever in an accident, your injuries can be considerably more severe without your seat belt properly buckled. Without your seat belt buckled, you are much more likely to hit the interior of the vehicle or be ejected from it. You can be seriously injured or killed.

In the same crash, the possibility of injury or death is lessened if you are properly wearing your seat belt. Air bags can only protect as they are designed if the occupants are properly wearing their seat belts.

### Occupant safety

#### Warning!



Never ride in a moving vehicle with the seat backrest in an excessively reclined position as this can be dangerous. You could slide under the seat belt in a collision. If you slide under it, the belt would apply force at the abdomen or neck. This could cause serious or even fatal injuries. The seat backrest and seat belt provide the best restraint when the wearer is in a nearly upright position and the belt is properly positioned on the body.

Keep door storage compartments closed while vehicle is in motion. Failure to do so may cause the seat belt to catch at the rear and prevent proper positioning of the seat belt.

#### Warning!



Never let more people ride in the vehicle than there are seat belts available. Be sure everyone riding in the vehicle is correctly restrained with a separate seat belt. Never use a seat belt for more than one person at a time.

#### Warning!



Damaged seat belts or belts that were highly stressed in an accident must be replaced and their anchoring points must also be checked.

Only use seat belts which have been approved by Mercedes-Benz.

Do not make any modifications to the seat belts.

Do not bleach or dye seat belts as this may severely weaken them. In a crash, they may not be able to provide adequate protection.

Have all work carried out only by qualified technicians. Contact an authorized Mercedes-Benz Center.

**Warning!****USE SEAT BELTS PROPERLY**

- Seat belts can only work when used properly. Never wear seat belts in any other way than as described in this section, as that could result in serious injuries in case of an accident.
  - Each occupant should wear their seat belt at all times, because seat belts help reduce the likelihood of and potential severity of injuries in accidents, including rollovers. The integrated restraint system includes SRS (driver air bag, driver-side knee bag, passenger front air bag, head-thorax air bags) and ETD (seat belt emergency tensioning device). The system is designed to enhance the protection offered to properly belted occupants in certain frontal (front air bags, driver-side knee bag and ETD) and side (head-thorax air bags and ETD) impacts which exceed preset deployment thresholds.
- Never wear the shoulder belt under your arm, against your neck or off your shoulder. In a crash, your body would move too far forward. That would increase the chance of head and neck injuries. The belt would also apply too much force to the ribs or abdomen, which could severely injure internal organs such as your liver or spleen.
  - Never wear belts over rigid or breakable objects in or on your clothing, such as eyeglasses, pens, keys, etc., as these might cause injuries.
  - Position the lap belt as low as possible on your hips and not across the abdomen. If the belt is positioned across your abdomen, it could cause serious injuries in a crash.
  - Never use a seat belt for more than one person at a time. Do not fasten a seat belt around a person and another person or other objects.
- Belts should not be worn twisted. In a crash, you would not have the full width of the belt to manage impact forces. The twisted belt against your body could cause injuries.
  - Pregnant women should also use a lap-shoulder belt. The lap belt portion should be positioned as low as possible on the hips to avoid any possible pressure on the abdomen.
  - Never place your feet on the instrument panel, dashboard or on the seat. Always keep both feet on the floor in front of the seat.
  - When using a seat belt to secure infant or toddler restraints or children in booster seats, always follow the child seat manufacturer's instructions.



## Occupant safety

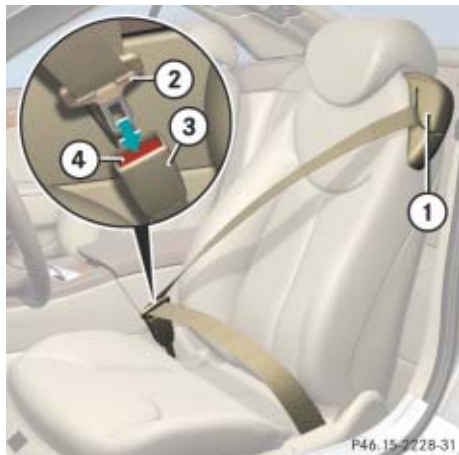



- ① Seat belt housing
- ② Latch plate
- ③ Buckle
- ④ Release button



### Enhanced seat belt reminder system

When the engine is started, the seat belt telltale  illuminates for a maximum of 6 seconds and a warning chime sounds to remind you and your passenger to fasten your seat belts.

If after these 6 seconds, the driver's or the passenger's seat belt (with the passenger seat occupied) are not fastened with all doors closed,

- and the vehicle speed does not exceed 15 mph (25 km/h), the seat belt telltale  remains illuminated for as long as either the driver's or passenger's seat belt is not fastened
- and the vehicle speed exceeds 15 mph (25 km/h), the seat belt telltale  starts flashing and a warning chime sounds with increasing intensity until both the driver's and passenger's seat belt are fastened, or for a maximum of 60 seconds from the time the vehicle speed

exceeded 15 mph (25 km/h) if either the driver's or passenger's seat belt remains unfastened.

If the driver's or passenger's seat belt remains unfastened after 60 seconds, the seat belt telltale  stops flashing and the warning chime stops sounding. The seat belt telltale  then continues to be illuminated for as long as either the driver's or passenger's seat belt are not fastened.

The seat belt telltale  will only go out if both the driver's and the passenger's seat belt (with the front passenger seat occupied) are fastened, or the vehicle is standing still and a front door is opened.

For more information, on the seat belt telltale , see the "Practical hints" section (▷ page 341).

### Emergency tensioning device (ETD), seat belt force limiter

The seat belts are equipped with emergency tensioning devices and belt force limiters.

The ETD is designed to activate in the following cases:

- in frontal or rear-end impacts exceeding the system deployment threshold
- if the restraint systems are operational and functioning correctly, see **SRS** indicator lamp (> page 66)
- in certain vehicle rollovers if the system determines an additional degree of protection

**i** *The ETDs will only activate if the seat belts are fastened (latch plate properly inserted into buckle).*

When activated, emergency tensioning devices remove slack from the belts in such a way that the seat belts fit more snugly against the body. Belt force limiters reduce the force exerted by the seat belts on occupants during a crash.

#### Warning!



An emergency tensioning device (ETD) that was activated must be replaced.

When disposing of the emergency tensioning device, our safety instructions must be followed. These are available at your authorized Mercedes-Benz Center.

### Automatic comfort-fit feature seat belt

The automatic comfort-fit feature reduces the retracting force of the seat belts when they are in normal use.

### Roll bar

#### Warning!



This vehicle is a two occupant vehicle. The rear storage area is not intended for use by occupants and is not equipped for properly seating or restraining occupants. Thus this area should never be used by any persons.

Before operating the roll bar switch make sure that the roll bar's path is clear and no persons are injured by the moving roll bar due to inattention. Raising or lowering of the roll bar could injure someone in its proximity.

For your own safety, we recommend to drive with the roll bar raised if the outside temperature is below +5°F (-15°C).

**!** *If the outside temperature falls below +5°F (-15°C), the roll bar must be raised manually using the buttons provided to avoid damaging the hydraulics.*

### Occupant safety

The roll bar raises automatically in an accident or in a critical driving situation. You can also raise and lower the roll bar manually using the buttons provided.

**i** When the roll bar is raised automatically, you will hear a ratcheting sound.

The buttons for the roll bar are on the center console under the retractable hardtop switch.



- ① Raise roll bar
- ② Lower roll bar

The roll bar can be moved manually when the ignition is switched on (▷ page 39).

#### Warning!



If the roll bar warning light  in the tachometer remains lit after starting the engine, there is a malfunction. In the display you see the message `Raise roll-over bar`.

For safety reasons, drive only with the roll bar upright until the malfunction is repaired. Have your vehicle checked at an authorized Mercedes-Benz Center.

#### Raising the roll bar

- ▶ Lift the switch for the retractable hardtop.
- ▶ Press and hold button ① until the roll bar is raised.

#### Lowering the roll bar

- ▶ Lift the switch for the retractable hardtop.

If the roll bar was raised manually:

- ▶ Press and hold button ② until the roll bar is lowered.

If the roll bar was raised automatically:

- ▶ Press and hold button ① until you hear the roll bar lock into place.
- ▶ Press and hold button ② until the roll bar is lowered.

**i** If you have raised the roll bar manually using the button, the roll bar will automatically be lowered and then raised again when you close and open the retractable hardtop.

## Children in the vehicle

If an infant or child is traveling with you in the vehicle:

- Secure the child using an infant or child restraint appropriate to the age and size of the child.
- Make sure the infant or child is properly secured at all times while the vehicle is in motion.

Infant and child restraint seats and information on choosing an appropriate restraint system can be obtained from any Mercedes-Benz Center.

### Warning!



Do not leave children unattended in the vehicle, even if they are secured in a child restraint system. The children could

- injure themselves on parts of the vehicle
- be seriously or fatally injured through excessive exposure to extreme heat or cold

Do not expose the child restraint system to direct sunlight. The child restraint system's metal parts, for example, could become very hot, and the child could be burned on these parts.

If children open a door, they could

- injure other persons
- get out of the car and injure themselves or be injured by following traffic

Do not carry heavy or hard objects in the passenger compartment unless they are firmly secured in place.

For more information, please refer to the "Useful features" section (▷ page 233) through (▷ page 238).

Unsecured or improperly positioned cargo increases a child's risk of injury in the event of

- strong braking maneuvers
- sudden changes of direction
- an accident

## Infant and child restraint systems

We recommend all infants and children be properly restrained at all times while the vehicle is in motion.

The passenger lap-shoulder belt has a special seat belt retractor for the secure fastening of child restraints.

To fasten a child restraint follow child restraint instructions for mounting. Then pull the shoulder belt out completely and let it retract. During the seat belt retraction a ratcheting sound can be heard to indicate that the special seat belt retractor is activated. The belt is now locked. Push down on child restraint to take up any slack.

To deactivate, release seat belt buckle and let seat belt retract completely. The seat belt can again be used in the usual manner.

### Occupant safety

#### Warning!



Never release the seat belt buckle while the vehicle is in motion, since the special seat belt retractor will be deactivated.

The use of infant or child restraints is required by law in all 50 states, the District of Columbia, the U.S. territories, and all Canadian provinces.

Infants and small children should be seated in an appropriate infant or child restraint system which is properly secured by a lap-shoulder belt and that complies with U.S. Federal Motor Vehicle Safety Standard 213 and Canadian Motor Vehicle Safety Standard 213.

A statement by the child restraint manufacturer of compliance with this standard can be found on the instruction label on the restraint and in the instruction manual provided with the restraint.

When using any infant or child restraint system, be sure to carefully read and follow all manufacturer's instructions for installation and use.

Please read and observe warning labels affixed to inside of vehicle and to infant or child restraints.

#### Warning!













Children 12 years old and under must be seated and properly secured in an appropriate infant or child restraint recommended for the size and weight of the child.

The infant or child restraint must be properly secured with the vehicle's seat belt fully in accordance with the child seat manufacturer's instructions.

Occupants, especially children, should never place their bodies or lean their heads in the area of the door where the head-thorax air bag inflates. This could result in serious injuries or death should the head-thorax air bag be triggered. Always sit nearly upright, properly use the seat belt and use an appropriately sized infant or toddler restraint or booster seat recommended for the size and weight of the child.

Children can be killed or seriously injured by an inflating air bag. Note the following important information when you place a child in the passenger seat:

- Your vehicle is equipped with air bag technology designed to turn off the front passenger front air bag in your vehicle when the OCS senses the weight of a typical 12-month-old child or less along with the weight of a standard appropriate child restraint on the front passenger seat.

- A child in a rear-facing child restraint on the passenger seat will be seriously injured or even killed if the passenger front air bag inflates in a collision which could occur under some circumstances, even with the air bag technology installed in your vehicle.
- If you install a rear-facing child restraint on the passenger seat, make sure that the   indicator lamp is illuminated, indicating that the passenger front air bag is deactivated. Should the   indicator lamp not illuminate or go out while the restraint is installed, please check installation. Periodically check the   indicator lamp while driving to make sure the   indicator lamp is illuminated. If the   indicator lamp goes out or remains out, do not transport a child on the passenger seat until the system has been repaired. A child in a rear-facing child restraint on the passenger seat will be seriously injured or even killed if the passenger front air bag inflates.

- If you place a child in a forward-facing child restraint on the passenger seat, move the seat as far back as possible, use the proper child restraint recommended for the age, size and weight of the child, and secure child restraint with the vehicle's seat belt according to the child seat manufacturer's instructions. For children larger than the typical 12-month-old child, the passenger front air bag may or may not be activated (▷ page 74).

### Warning!



Infants and small children should never share a seat belt with another occupant. During an accident, they could be crushed between the occupant and seat belt.

A child's risk of serious or fatal injuries is significantly increased if the child restraints are not properly secured in the vehicle and the child is not properly secured in the child restraint.

### Warning!



Children too big for a toddler restraint must ride in seats using regular seat belts. Position the shoulder belt across chest and shoulder, not face or neck. A booster seat may be necessary to achieve proper belt positioning for children over 41 lbs until they reach a height where a lap/shoulder belt fits properly without a booster.

When the child restraint is not in use, remove it from the vehicle or secure it with the seat belt to prevent the child restraint from becoming a projectile in the event of an accident.

Do not leave children unattended in the vehicle, even if the children are secured in a child restraint system. Unsupervised children in a child restraint system may use vehicle equipment and cause an accident and/or serious personal injury.

### Panic alarm

An audible alarm and flashing exterior lamps will operate briefly.



① PANIC button

**i** USA only: This device complies with Part 15 of the FCC Rules. Operation is subject to the following two conditions:

- (1) This device may not cause harmful interference, and
- (2) this device must accept any interference received, including interference that may cause undesired operation.

*Any unauthorized modification to this device could void the user's authority to operate the equipment.*

**i** Canada only:

*This device complies with RSS-210 of Industry Canada. Operation is subject to the following two conditions:*

- (1) This device may not cause interference, and
- (2) this device must accept any interference received, including interference that may cause undesired operation of the device.

*Any unauthorized modification to this device could void the user's authority to operate the equipment.*

### Activating

---

- ▶ Press and hold button ① for at least 1 second.

### Deactivating

---

- ▶ Press button ① again.

or

- ▶ Insert SmartKey or the SmartKey with KEYLESS-GO\* in starter switch.

or

- ▶ Press the KEYLESS-GO\* start/stop button on the gear selector lever.

The SmartKey with KEYLESS-GO\* must be in the vehicle.

## ▼ Driving safety systems

In this section you will find information on the following driving safety systems:

- ABS (Antilock Brake System)
- BAS (Brake Assist System)
- ESP® (Electronic Stability Program)
- Electro-hydraulic brake system

### Warning!



The following factors increase the risk of accidents:

- Excessive speed, especially in turns
- Wet and slippery road surfaces
- Following another vehicle too closely

The ABS, BAS, ESP®, and the electro-hydraulic brake system cannot reduce this risk.

Always adjust your driving style to the prevailing road and weather conditions.

**i** In winter operation, the maximum effectiveness of the ABS, the BAS, the ESP®, and the electro-hydraulic brake system is only achieved with winter tires (▷ page 316) or snow chains as required.

## ABS

### Warning!



Do not pump the brake pedal. Use firm, steady brake pedal pressure instead. Pumping the brake pedal defeats the purpose of the ABS and significantly reduces braking effectiveness.

The Antilock Brake System (ABS) regulates the brake pressure so that the wheels do not lock during braking. This allows you to maintain the ability to steer your vehicle.

The ABS is functional above a speed of approximately 5 mph (8 km/h) independent of road surface conditions.

On slippery road surfaces, the ABS will respond even to light brake pressure.



### Driving safety systems

The  indicator lamp in the instrument cluster comes on when you switch on the ignition. It goes out when the engine is running.

#### Braking

If the ABS activates during braking, the ABS/ESP<sup>®</sup> warning lamp  in the instrument cluster dial flashes. Because of the electro-hydraulic brake system, you will not feel any pulsation in the brake pedal.

- ▶ Keep firm and steady pressure on the brake pedal.

Continuous, steady brake pedal pressure yields the advantages provided by the ABS, namely braking power and the ability to steer the vehicle.

The ABS/ESP<sup>®</sup> warning lamp  flashes whenever the ABS is activated which can be an indication of hazardous road conditions and functions as a reminder to take extra care while driving.

#### Emergency brake maneuver

- ▶ Keep continuous, full pressure on the brake pedal.

#### Warning!



When the ABS is malfunctioning, the BAS and the ESP<sup>®</sup> are also switched off.

When the ABS is malfunctioning, the wheels may lock during hard braking, reducing steering capability and extending the braking distance.

#### Warning!



The ABS cannot prevent the natural laws of physics from acting on the vehicle, nor can it increase braking or steering efficiency beyond that afforded by the condition of the vehicle brakes and tires or the traction afforded. The ABS cannot prevent accidents, including those resulting from excessive speed in turns, following another vehicle too closely, or hydroplaning. Only a safe, attentive, and skillful driver can prevent accidents. The capabilities of an ABS equipped vehicle must never be exploited in a reckless or dangerous manner which could jeopardize the user's safety or the safety of others.

For more information, see the “Practical hints” section (▶ page 332).

## BAS

The Brake Assist System (BAS) operates in emergency situations. If you apply the brakes very quickly, the BAS automatically provides full brake boost, thereby potentially reducing the braking distance.

- ▶ Apply continuous full braking pressure until the emergency braking situation is over.

The ABS will prevent the wheels from locking.

When you release the brake pedal, the brakes function again as normal. The BAS is then deactivated.

### Warning!



If the BAS is malfunctioning, the brake system is still functioning normally, but without the additional brake boost available that BAS would normally provide in an emergency braking maneuver. Therefore, the braking distance may increase.

### Warning!





BAS cannot prevent the natural laws of physics from acting on the vehicle, nor can it increase braking efficiency beyond that afforded by the condition of the vehicle brakes and tires or the traction afforded. The BAS cannot prevent accidents, including those resulting from excessive speed in turns, following another vehicle too closely, or hydroplaning. Only a safe, attentive, and skillful driver can prevent accidents. The capabilities of a BAS equipped vehicle must never be exploited in a reckless or dangerous manner which could jeopardize the user's safety or the safety of others.

## ESP®

The Electronic Stability Program (ESP®) is operational as soon as the engine is running and monitors the vehicle's traction (force of adhesive friction between the tires and the road surface) and handling.

The ESP® recognizes when a wheel is spinning or if the vehicle starts to skid. By applying brakes to the appropriate wheel and by limiting engine output, the ESP® works to stabilize the vehicle. The ESP® is especially useful while driving off and on wet or slippery road surfaces. The ESP® also stabilizes the vehicle during braking maneuvers.

The ABS/ESP® warning lamp  in the instrument cluster (▷ page 27) flashes when the ESP® is engaged.

The ABS/ESP® warning lamp  in the instrument cluster comes on when you switch on the ignition. It goes out when the engine is running.

## Driving safety systems

### Warning!



Never switch off the ESP<sup>®</sup> when you see the ABS/ESP<sup>®</sup> warning lamp  flashing in the instrument cluster. In this case proceed as follows:

- While driving off, apply as little throttle as possible.
- While driving, ease up on the accelerator.
- Adapt your speed and driving style to the prevailing road conditions.

Failure to observe these guidelines could cause the vehicle to skid.

The ESP<sup>®</sup> cannot prevent accidents resulting from excessive speed.

### Warning!



The ESP<sup>®</sup> cannot prevent the natural laws of physics from acting on the vehicle, nor can it increase the traction afforded. The ESP<sup>®</sup> cannot prevent accidents, including those resulting from excessive speed in turns, or hydroplaning. Only a safe, attentive, and skillful driver can prevent accidents. The capabilities of an ESP<sup>®</sup> equipped vehicle must never be exploited in a reckless or dangerous manner which could jeopardize the user's safety or the safety of others.

**!** Because the ESP<sup>®</sup> operates automatically, the engine must be shut off (SmartKey in starter switch position **0** or **1** or KEYLESS-GO\* start/stop button in position **0** or **1**) when

- the parking brake is being tested on a brake test dynamometer
- the vehicle is being towed with the front/rear axle raised

Active braking action through the ESP<sup>®</sup> may otherwise seriously damage the brake system.

The ESP<sup>®</sup> will only function properly if you use wheels of the recommended tire size (▷ page 435).

**i** The cruise control and the Distronic\* system deactivate automatically when the ESP<sup>®</sup> is in operation (▷ page 220).

For more information, see the “Practical hints” section (▷ page 332) and (▷ page 355).

## Electronic traction system

The electronic traction system is a component of ESP®.

The electronic traction system improves the vehicle's ability to utilize available traction, especially under slippery road conditions by applying the brakes to a spinning wheel.

When you switch off the ESP®, the electronic traction system is still enabled.

### Warning!



If you are driving too fast, the electronic traction system cannot reduce the risk of an accident.

The electronic traction system cannot prevent the natural laws of physics from acting on the vehicle.

## Switching off the ESP®

### Warning!



ESP® should not be switched off during normal driving other than in the circumstances described below. Disabling of the system will reduce vehicle stability in standard driving maneuvers.

Do not switch off the ESP® when a spare wheel is mounted.

To improve the vehicle's traction, switch off the ESP® in driving situations where it would be advantageous to have the drive wheels spin and thus cut into surfaces for better grip such as:

- when driving with snow chains
- in deep snow
- in sand or gravel

**!** Switch on the ESP® immediately if the aforementioned circumstances do not apply anymore.

When you switch off the ESP®

- the ESP® does not stabilize the vehicle
- the engine output is not limited, which allows the drive wheels to spin and thus cut into surfaces for better grip
- the electronic traction system will still apply the brakes to a spinning wheel
- the ESP® continues to operate when you are braking
- you cannot activate the cruise control or the DISTRONIC\* system
- the cruise control or the DISTRONIC\* system switch off if currently activated

**i** When the ESP® is switched off and one or more drive wheels are spinning, the ABS/ESP® warning lamp  in the speedometer flashes. However, the ESP® will then not stabilize the vehicle.

### Driving safety systems

The switch is located in the lower part of the center console.



#### ① ESP® switch

- ▶ Press ESP® switch ① until the ABS/ESP® warning lamp  in the instrument cluster comes on.

The ESP® is deactivated.

#### Warning!



When the ABS/ESP® warning lamp  is illuminated continuously, the ESP® is switched off or is not operational due to a malfunction. Vehicle stability in standard driving maneuvers reduces.

Adapt your speed and driving to the prevailing road conditions and to the non-operating status of the ESP®.

**!** *Avoid spinning of a drive wheel for an extended period with the ESP® switched off. This may cause serious damage to the drivetrain which is not covered by the Mercedes-Benz Limited Warranty.*

#### Switching on the ESP®

- ▶ Press ESP® switch ①.

The ABS/ESP® warning lamp  in the instrument cluster goes out.



You are now again in normal driving mode with the ESP® switched on.

### Electro-hydraulic brake system

The electro-hydraulic brake system combines a hydraulic brake circuit with electronically controlled brake servo assistance. You have increased braking safety and improved braking comfort.

#### Warning!



Never ignore a brake malfunction indicated in the speedometer display, for example by the  (USA only) or  (Canada only) indicator lamp. Refer to the “Practical hints” section (▷ page 335). Also read and observe the messages in the instrument cluster multifunction display (▷ page 366).

**Warning!**

The electro-hydraulic brake system requires electrical power to operate.

A malfunction in the vehicle's power supply or electrical system may impair brake system operation and switch it into its emergency operation mode. In such a case, the red brake warning lamp (▷ page 335) comes on and warning messages (▷ page 366) appear in the multifunction display while driving. To brake, the driver must then apply significantly greater brake pedal pressure and depress the pedal much further to obtain the expected braking effect. If necessary, apply full pressure to the brake pedal. Brakes are only applied to the front wheels. Stopping distance is increased!

If there is a malfunction in the electro-hydraulic brake system, we recommend that the vehicle be transported with all wheels off the ground using flatbed or appropriate wheel lift/dolly equipment.

A tow bar must be used if circumstances do not permit the use of the recommended towing methods and the vehicle requires towing with all four wheels on the ground. Towing the vehicle with all four wheels on the ground is only permissible for distances up to 30 miles (50 km) and at a speed not to exceed 30 mph (50 km/h). For more information, see "Towing the vehicle" (▷ page 421).

The electro-hydraulic brake system is automatically activated when you

- unlock the vehicle with the SmartKey or the SmartKey with KEYLESS-GO\*
- open the driver's or passenger door
- turn the SmartKey in the starter switch to position **1**
- in vehicles with KEYLESS-GO\*, press the start/stop button on the gear selector lever once
- depress the brake pedal
- release the parking brake

### Driving safety systems

**i** If the electro-hydraulic brake system is activated as the brake pedal is first depressed, you may feel a reduced pedal resistance and longer pedal travel than normal. When releasing the pedal, you may also feel the brake pedal pulsate and you may hear a sound which is caused by the activation of the electro-hydraulic brake system pump. This is normal and not an indication of a malfunction. Pedal travel returns to normal when you release the brake pedal and the sound soon ceases.

If you experience the above while driving and the red brake warning lamp (▷ page 335) illuminates and/or warning messages appear in the multifunction display (▷ page 366), the brake system is malfunctioning. Follow the instructions of the warning message(s) and have the brake system checked immediately.

#### Warning!



Have brake pad replacement and other work on the electro-hydraulic brake system carried out by qualified technicians only. Contact an authorized Mercedes-Benz Center for further information. The electro-hydraulic brake system must be deactivated prior to working on the system. High pressure is intermittently built up in the system as part of its automatic self-test. In addition, the system is automatically activated when the vehicle is unlocked by remote control, when the driver or passenger door is opened, when the SmartKey in the starter switch is turned to position 1 or the KEYLESS-GO\* start/stop button is pressed once, when the brake pedal is depressed or when the parking brake is released. Failure to deactivate the system prior to maintenance will cause brake pistons to extend and brake fluid to leak, which may result in injuries (contusions and acid burns). Extended brake pistons may also cause injury.

The electro-hydraulic brake system switches off automatically

- approximately 2 minutes after you turned the SmartKey in the starter switch to position **0** or removed the SmartKey
- approximately 2 minutes after you pressed the KEYLESS-GO\* start/stop button to turn off the engine or power supply and opened the driver's door (with driver's door open, the starter switch is set to position **0**, same as SmartKey removed from starter switch)
- approximately 20 seconds after you locked the vehicle from outside

### Notes on driving with the electro-hydraulic brake system

- Following extended periods of only minor loads to your brake system, you should occasionally apply the brakes when traveling at high speeds. This improves the grip of the brake pads.

After driving on wet or snow-covered roads, you should apply your brakes firmly before parking your vehicle. This produces heat which serves to dry the brake disks and help prevent corrosion.

- On long and steep grades, shift to a lower gear (gear range **1**, **2**, or **3**) to prevent the brakes from overheating and to reduce brake wear.
- After hard braking, it is advisable to drive on for some time so that the air stream will cool down the brakes faster.
- Only Mercedes-Benz approved components (e.g. brake pads) should be installed on your vehicle. Brake pads not approved by Mercedes-Benz may impair the safety of your vehicle.

#### Warning!



Be very careful not to endanger other road users when you apply the brakes.



### Anti-theft systems

#### Immobilizer

---

The immobilizer prevents unauthorized persons from starting your vehicle.

#### Activating

##### *With the SmartKey*

- ▶ Remove the SmartKey from the starter switch.

##### *With KEYLESS-GO\**

- ▶ Press the start/stop button on the gear selector lever once.  
The engine is turned off.
- ▶ Open the driver's door.

#### Deactivating

##### *With the SmartKey*

- ▶ Turn the SmartKey in the starter switch to position **2** (▷ page 40).

##### *With KEYLESS-GO\**

- ▶ Switch on the ignition (▷ page 41).

**i** *Starting the engine will also deactivate the immobilizer.*

*In case the engine cannot be started (yet the vehicle's battery is charged), the system is not operational. Contact an authorized Mercedes-Benz Center or call 1-800-FOR-MERCEdes (in the USA), or 1-800-387-0100 (in Canada).*

#### Anti-theft alarm system

---

Once the alarm system has been armed, a visual and audible alarm is triggered when someone opens

- a door
- the trunk lid
- the hood
- a storage compartment in the rear
- the glove box
- the storage compartment under the armrest

The alarm will stay on, even if the activating element (a door, for example) is immediately closed.

The alarm system will also be triggered when

- someone attempts to raise the vehicle
- unlocking and opening the driver's door with the mechanical key
- someone opens a door from the inside
- someone opens the trunk lid with the emergency release button

**i** *If the alarm stays on for more than 30 seconds, a call to the Response Center is initiated automatically by the Tele Aid system (▷ page 245) provided Tele Aid service was subscribed to and properly activated, and that necessary cellular service and GPS coverage are available.*

### Arming the alarm system

The alarm system is armed after locking the vehicle with the SmartKey or KEYLESS-GO\*. The turn signal lamps flash three times to indicate that the alarm system is activated. The indicator lamp in the central locking switch (▷ page 31) begins to flash after arming the alarm system.

**i** *If the turn signal lamps do not flash three times, a door or the trunk lid may not be properly closed.*

*Close the respective element and lock the vehicle again.*

### Disarming the alarm system



The alarm system is disarmed when you unlock your vehicle with the SmartKey or KEYLESS-GO\*. The turn signal lamps flash once to indicate that the alarm system is disarmed.

**i** *The alarm system will rearm automatically again after approximately 40 seconds if no door was opened.*

### Canceling the alarm

To cancel the alarm:

#### **With the SmartKey**

- ▶ Insert the SmartKey in the starter switch.
- or
- ▶ Press the  or  button on the SmartKey.

#### **With KEYLESS-GO\***

- ▶ Grasp an outside door handle.
- The SmartKey with KEYLESS-GO must be within 3 ft. (1 m) of the vehicle.
- or
- ▶ Press the KEYLESS-GO start/stop button (▷ page 40).

The SmartKey with KEYLESS-GO must be inside the vehicle.

### Anti-theft systems

#### Tow-away alarm

Once the tow-away alarm is armed, a visual and audible alarm will be triggered when someone attempts to raise the vehicle.

**i** *If the alarm stays on for more than 30 seconds, a call to the Response Center is initiated automatically by the Tele Aid system (▷ page 245) provided Tele Aid service was subscribed to and properly activated, and that necessary cellular service and GPS coverage are available.*

#### Arming tow-away alarm

When you lock your vehicle, the tow-away alarm is automatically armed after about 30 seconds.

When you unlock your vehicle, the tow-away protection disarms automatically.

#### Disabling tow-away alarm

To prevent triggering the tow-away alarm, disable the tow-away alarm feature before towing the vehicle, or when parking on a surface subject to movement, such as a ferry or auto train.

The button is located on the center console between the driver's seat and the passenger seat.



① Tow-away alarm off button

② Indicator lamp

► Switch off the ignition and remove the SmartKey from the starter switch.

**i** *You cannot disarm the tow-away alarm when the ignition is switched on.*

- ▶ Press button ①.

The indicator lamp ② in the switch comes on briefly.

- ▶ Exit and lock your vehicle with the SmartKey or (vehicles with KEYLESS-GO\*) with the lock button on each door handle or trunk lid.

The tow-away alarm remains disarmed until you lock the vehicle again.



### Canceling the alarm

To cancel the alarm:

#### *With the SmartKey*

- ▶ Insert the SmartKey in the starter switch.

or

- ▶ Press the  or  button on the SmartKey.

#### *With KEYLESS-GO\**

- ▶ Grasp an outside door handle.

The SmartKey with KEYLESS-GO must be within 3 ft. (1 m) of the vehicle.

or

- ▶ Press the KEYLESS-GO start/stop button (▷ page 40).

The SmartKey with KEYLESS-GO must be inside the vehicle.





**Locking and unlocking**

**Seats**

**Memory function**

**Lighting**

**Instrument cluster**

**Control system**

**Automatic transmission**

**Good visibility**

**Automatic climate control**

**Power windows**

**Retractable hardtop**

**Driving systems**

**Useful features**

### Locking and unlocking

In the “Controls in detail” section you will find detailed information on how to operate the equipment installed on your vehicle. If you are already familiar with the basic functions of your vehicle, this section will be of particular interest to you.

To quickly familiarize yourself with the basic functions of the vehicle, refer to the “Getting started” section of this manual. The corresponding page numbers are given at the beginning of each segment.

For more information on locking and unlocking, see the “Getting started” section (▷ page 38).

#### SmartKey

Your vehicle comes supplied with two SmartKeys, each with remote control and a removable mechanical key.

The locking tabs for the mechanical key portion of the two SmartKeys are a different color to help distinguish each SmartKey unit.





The SmartKey provides an extended operating range. To prevent theft, however, it is advisable to only unlock the vehicle when you are in close proximity to it.

The SmartKey centrally locks and unlocks:

- the doors
- the trunk lid
- the glove box
- the storage compartment under the armrest
- the storage compartment in the rear
- the fuel filler flap



#### SmartKey with remote control

- ①  Lock button
- ②  Opening button for trunk (▷ page 111)
- ③ Mechanical key locking tab
- ④  Unlock button
- ⑤ Battery check lamp
- ⑥  PANIC Panic button (▷ page 86)

**Warning!**

When leaving the vehicle, always remove the SmartKey from the starter switch, take it with you, and lock the vehicle. Do not leave children unattended in the vehicle, or with access to an unlocked vehicle. It is possible for children to open a locked door from the inside, which could result in an accident and/or serious injury.

**!** To prevent possible malfunction, avoid exposing the SmartKey to high levels of electromagnetic radiation.

**i** USA only: This device complies with Part 15 of the FCC Rules. Operation is subject to the following two conditions:

- (1) This device may not cause harmful interference, and
- (2) this device must accept any interference received, including interference that may cause undesired operation.

Any unauthorized modification to this device could void the user's authority to operate the equipment.

**i** Canada only:

This device complies with RSS-210 of Industry Canada. Operation is subject to the following two conditions:

- (1) This device may not cause interference, and
- (2) this device must accept any interference received, including interference that may cause undesired operation of the device.

Any unauthorized modification to this device could void the user's authority to operate the equipment.

**i** You can also open and close the power windows (▷ page 196) and the retractable hardtop using the SmartKey (▷ page 201).

**Factory setting****Global unlocking**

▶ Press button .

All turn signals flash once. The locking knobs in the doors move up. The anti-theft alarm system is disarmed.

The vehicle will lock again automatically and reactivate the alarm system within approximately 40 seconds of unlocking if:

- neither door nor trunk is opened
- the SmartKey is not inserted in the starter switch
- the central locking switch is not activated

**Global locking**

▶ Press button .



With the trunk and all doors closed, all turn signals flash three times. The locking knobs in the doors move down. The anti-theft alarm system is armed.



### Locking and unlocking

#### Selective setting

If you frequently travel alone, you may wish to reprogram the SmartKey so that pressing  only unlocks the driver's door, interior lockable storage compartments and the fuel filler flap.

- ▶ Press and hold buttons  and  simultaneously for about 6 seconds until battery check lamp  flashes twice.

The SmartKey will then function as follows:

#### Unlocking driver's door and fuel filler flap

- ▶ Press button  once.

All turn signals flash once. The locking knob in the driver's door moves up. The anti-theft alarm system is disarmed.

#### Global unlocking

- ▶ Press button  twice.





All turn signals flash once. The locking knobs in the doors move up. The anti-theft alarm system is disarmed.

#### Global locking







- ▶ Press button .

All turn signals flash three times. The locking knobs in the doors move down. The anti-theft alarm system is armed.

#### Restoring to factory setting



- ▶ Press and hold buttons  and  simultaneously for about 6 seconds until battery check lamp  ( page 102) flashes twice.

 If you can no longer lock or unlock the vehicle with the SmartKey, then the batteries in the SmartKey are discharged, the SmartKey is malfunctioning or the vehicle battery is drained.

- Check the batteries in the SmartKey ( page 105) and replace them if necessary ( page 395).
- Use the mechanical key to unlock the driver's door ( page 391) and the trunk ( page 117).
- Have the vehicle batteries and their connections checked ( page 414).
- Use the mechanical key to lock or unlock the doors ( page 393).

If the SmartKey is malfunctioning, contact an authorized Mercedes-Benz Center.

### Checking the batteries



- ▶ Press button  or .

Battery check lamp ⑤ (▷ page 102) comes on briefly to indicate that the SmartKey batteries are in order.

 *If battery check lamp ⑤ does not come on briefly during check, then the SmartKey batteries are discharged.*

- *Replace the batteries (▷ page 395).*

*You can obtain the required batteries at any authorized Mercedes-Benz Center.*

 *If the batteries are checked within signal range of the vehicle, pressing the  or  button will lock or unlock the vehicle accordingly.*

### Loss of SmartKey or mechanical key

If you lose a SmartKey or mechanical key, you should do the following:

- ▶ Have the SmartKey deactivated by an authorized Mercedes-Benz Center.
- ▶ Report the loss of the SmartKey or the mechanical key to your car insurance company immediately.
- ▶ If necessary, have the mechanical lock replaced.

Your authorized Mercedes-Benz Center will be glad to supply you with a replacement.

### SmartKey with KEYLESS-GO\*

Vehicles equipped with KEYLESS-GO come with two SmartKeys with KEYLESS-GO, each with remote controls and a removable mechanical key.

The locking tabs for the mechanical key portion of the two SmartKeys with KEYLESS-GO are a different color to help distinguish each SmartKey with KEYLESS-GO unit.

The function of the SmartKey overrules the KEYLESS-GO function.

The KEYLESS-GO function is integrated into the SmartKey. On these vehicles, the validity of the SmartKey with KEYLESS-GO is checked every time you grasp a door handle.







### Locking and unlocking

If the SmartKey with KEYLESS-GO is valid, your vehicle unlocks

- the doors
- the trunk lid
- the glove box
- the storage compartment under the armrest
- the storage compartment in the rear
- the fuel filler flap



#### SmartKey with KEYLESS-GO

- ①  Lock button
- ②  Opening button for trunk (▷ page 111)
- ③  Mechanical key locking tab
- ④  Unlock button
- ⑤  Battery check lamp
- ⑥  PANIC Panic button (▷ page 86)

For information on using the SmartKey buttons, see “SmartKey” (▷ page 102).

#### Warning!



When leaving the vehicle, always take the SmartKey with KEYLESS-GO with you and lock the vehicle. Do not leave children unattended in the vehicle, or with access to an unlocked vehicle. Unsupervised use of vehicle equipment may cause an accident and/or serious personal injury.

**!** To prevent possible malfunction, avoid exposing the SmartKey with KEYLESS-GO to high levels of electromagnetic radiation.

**i** USA only: This device complies with Part 15 of the FCC Rules. Operation is subject to the following two conditions:

- (1) This device may not cause harmful interference, and
- (2) this device must accept any interference received, including interference that may cause undesired operation.

Any unauthorized modification to this device could void the user's authority to operate the equipment.

**i** *Canada only:*

*This device complies with RSS-210 of Industry Canada. Operation is subject to the following two conditions:*

- (1) This device may not cause interference, and*
- (2) this device must accept any interference received, including interference that may cause undesired operation of the device.*

*Any unauthorized modification to this device could void the user's authority to operate the equipment.*

**i** *You can also close the power windows (▷ page 196) and the retractable hardtop using the SmartKey with KEYLESS-GO (▷ page 201).*

**i** *When you unlock the vehicle, the electro-hydraulic brake system is activated.*

**Important notes on using KEYLESS-GO**

- You can also use the SmartKey with KEYLESS-GO like a normal SmartKey (▷ page 102).
- You can combine KEYLESS-GO functions with normal SmartKey functions (e.g. unlocking with KEYLESS-GO and locking with the  button).
- Always carry the SmartKey with KEYLESS-GO with you.
- Never store the SmartKey with KEYLESS-GO together with:
  - Electronic items such as a cellular phone or another SmartKey with KEYLESS-GO
  - Metallic objects such as coins or metal foil

Doing so could impair the function of the KEYLESS-GO system.

- To lock or unlock the vehicle, the SmartKey with KEYLESS-GO must be located outside the vehicle within approximately 3 ft (1 m) of a door or the trunk.
- In order to start the engine with the SmartKey with KEYLESS-GO:
  - The SmartKey with KEYLESS-GO must be located in the vehicle.
  - All doors must be closed.
  - The brake pedal must be firmly depressed. Do not depress the accelerator.
- If you have started the engine with the KEYLESS-GO start/stop button (▷ page 40), you can only turn it off again with this button, even if you have put the SmartKey in the starter switch in the meantime.

### Locking and unlocking

- This does not apply if, after starting, the selector lever is still in position **P** and the SmartKey is then inserted in the starter switch. The SmartKey will then have priority over the KEYLESS-GO function and the vehicle's electrical system will operate according to the position of the SmartKey in the starter switch, even stopping the engine.
- If the SmartKey with KEYLESS-GO is positioned farther away from the vehicle, the system may no longer recognize the SmartKey with KEYLESS-GO. The vehicle then cannot be locked or the engine started via the KEYLESS-GO system.
- If the SmartKey with KEYLESS-GO is removed from the vehicle while the engine is running (e.g. if passenger exits the vehicle with the SmartKey with KEYLESS-GO), the message **Key not detected!** will appear in the multifunction display while driving off.

Find the SmartKey or change its present location immediately (e.g. place it on the front passenger seat or insert it in shirt pocket).

- Remember that the engine can be started by anyone with a SmartKey with KEYLESS-GO that is left inside the vehicle. If you leave the SmartKey with KEYLESS-GO behind when exiting and locking the vehicle, the message **Key recognized in vehicle!** will appear in the multifunction display.

#### Factory setting

#### Global unlocking

- ▶ Grasp an outside door handle.

All turn signals flash once. The locking knobs in the doors move up. The anti-theft alarm system is disarmed.

**i** *If the vehicle has been parked for more than 72 hours, you must pull an outside door handle in order to activate the KEYLESS-GO function.*

The vehicle will lock again automatically and reactivate the alarm system within approximately 40 seconds of unlocking if neither a door nor the trunk is opened.

**i** *The vehicle could inadvertently unlock if the SmartKey with KEYLESS-GO is within 3 ft (1 m) of the vehicle and*

- *an outside door handle is splashed with water*
- or*
- *you attempt to clean an outside door handle*



#### Global locking

- ▶ Press lock button on an outside door handle (> page 64) or the trunk lid (> page 110).

With the trunk and all doors closed, all turn signals flash three times. The locking knobs in the doors move down. The anti-theft alarm system is armed.

### Selective setting

If you frequently travel alone, you may wish to reprogram the SmartKey with KEYLESS-GO so that grasping an outside door handle only unlocks the driver's door, interior lockable storage compartments and the fuel filler flap.

- ▶ Press and hold buttons  and  simultaneously for about 6 seconds until battery check lamp  (▷ page 106) flashes twice.

The SmartKey with KEYLESS-GO will then function as follows:

### Unlocking the driver's door and fuel filler flap

- ▶ Grasp the driver's door handle.

All turn signals flash once. The locking knob in the driver's door moves up. The anti-theft alarm system is disarmed.

### Global unlocking

- ▶ Grasp the door handle on the passenger side.



All turn signals flash once. The locking knobs in the doors move up. The anti-theft alarm system is disarmed.

### Global locking

- ▶ Press lock button on an outside door handle or the trunk lid.

With the trunk and all doors closed, all turn signals flash three times. The locking knobs in the doors move down. The anti-theft alarm system is armed.

### Restoring to factory setting

- ▶ Press and hold buttons  and  simultaneously for about 6 seconds until battery check lamp  (▷ page 106) flashes twice.

**!** *If you can no longer lock or unlock the vehicle with the SmartKey with KEYLESS-GO, then the batteries in the SmartKey are discharged, the SmartKey with KEYLESS-GO is malfunctioning or the vehicle battery is drained.*

- *Check the batteries in the SmartKey with KEYLESS-GO (▷ page 105) and replace them if necessary (▷ page 395).*
- *Use the mechanical key to unlock the driver's door (▷ page 391) and the trunk (▷ page 117).*
- *Have the vehicle batteries and their connections checked (▷ page 414).*
- *Use the mechanical key to lock or unlock the doors (▷ page 393).*

*If the SmartKey with KEYLESS-GO is malfunctioning, contact an authorized Mercedes-Benz Center.*

### Locking and unlocking

#### Global locking using the lock button on the trunk lid

**i** Vehicles with KEYLESS-GO\*: To prevent a possible inadvertent lockout, the trunk lid will open automatically if a SmartKey with KEYLESS-GO is recognized inside the trunk.

When the hardtop is retracted, it must be completely lowered in the trunk before the trunk lid can be closed (▷ page 242).



① Lock button



- ▶ Press lock button ① on the trunk lid.

With the trunk and all doors closed, all turn signals flash three times. The locking knobs in the doors move down.

The anti-theft alarm system is armed.

- i** You can also lock the vehicle using the lock button on an outside door handle (▷ page 64).

#### Checking the batteries



- ▶ Press button  or .

Battery check lamp ⑤ (▷ page 106) comes on briefly to indicate that the SmartKey batteries are in order.

- i** If battery check lamp ⑤ (▷ page 106) does not come on briefly during check, then the SmartKey batteries are discharged.

- Replace the batteries (▷ page 395).

You can obtain the required batteries at any authorized Mercedes-Benz Center.

- i** If the batteries are checked within signal range of the vehicle, pressing the  or  button will lock or unlock the vehicle accordingly.

#### Loss of SmartKey with KEYLESS-GO

If you lose your SmartKey with KEYLESS-GO, you should do the following:

- ▶ Have the SmartKey with KEYLESS-GO deactivated by an authorized Mercedes-Benz Center.
- ▶ Report the loss of the SmartKey with KEYLESS-GO or the mechanical key to your car insurance company immediately.
- ▶ Have the mechanical lock replaced if necessary.

Your authorized Mercedes-Benz Center will be glad to supply you with a replacement.

## Opening the doors from the inside

You can open a locked door from the inside. Open door only when conditions are safe to do so.



- ① Locking knob
- ② Inside door handle



► Pull on inside door handle ② in direction of arrow.

If the door was locked, locking knob ① will move up.

**i** If you open a door, the side windows on that side of the vehicle will lower slightly. The windows close again when you close the door.

**i** If the vehicle has previously been locked with the SmartKey or KEYLESS-GO\*, opening a door from the inside will trigger the anti-theft alarm system.

To cancel the alarm, do one of the following:

- Press button  or  on the SmartKey.
- Insert the SmartKey in the starter switch.

Vehicles with KEYLESS-GO\*:

- Grasp an outside door handle.  
The SmartKey with KEYLESS-GO must be within 3 ft. (1 m) of the vehicle.
- Press the KEYLESS-GO\* start/stop button (▷ page 40).  
The SmartKey with KEYLESS-GO must be inside the vehicle.

## Opening the trunk

You can open the trunk if the vehicle is stationary and the retractable hardtop is fully opened or closed.

### Warning!



Only drive with the trunk closed as, among other dangers such as blocked visibility, exhaust fumes may enter the vehicle interior.

A minimum height clearance of 6.2 ft (1.88 m) is required to open the trunk lid.

**i** If the trunk lid does not open, the trunk lid is still locked separately (▷ page 117).

**i** To facilitate trunk loading and unloading when the hardtop is retracted, you can raise the hardtop from its storage position in the trunk using the load assist feature (▷ page 241). You may also unhook the luggage cover.

Remember to re-secure the luggage cover after loading/unloading the trunk. Otherwise you will not be able to lower the retractable hardtop.



### Locking and unlocking

#### Opening the trunk from the outside

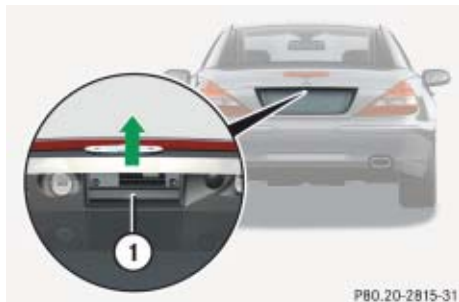

- ① Trunk lid handle

#### Vehicles without trunk opening/closing system\*

- ▶ Press button  on the SmartKey or SmartKey with KEYLESS-GO\*.

or

- ▶ Pull on handle ①.

In vehicles without KEYLESS-GO\*: The vehicle must be unlocked.

- ▶ Lift the trunk lid.

#### Vehicles with trunk opening/closing system\*

- ▶ Press and hold button  on the SmartKey or SmartKey with KEYLESS-GO\* until trunk unlocks and begins to open.

or

- ▶ Pull on handle ①.

Vehicles without KEYLESS-GO\*: The vehicle must be unlocked.

**!** The trunk lid swings open upwards automatically. Always make sure that there is sufficient overhead clearance.

**!** To stop the opening procedure, press button  on the SmartKey or SmartKey with KEYLESS-GO\* or pull the trunk lid handle.

#### Opening the trunk from the inside

#### Vehicles without trunk opening/closing system\*



- ① Remote trunk opening switch
- ② Indicator lamp

- ▶ Pull switch ① until the trunk begins to open.

The trunk lid unlocks. Indicator lamp ② comes on and remains lit until the trunk is closed again.

- ▶ Lift the trunk lid.

### Vehicles with trunk opening/closing system\*



- ① Remote trunk opening/closing\* switch
- ② Indicator lamp

- ▶ Pull and hold switch ① until the trunk unlocks and begins to open.

Indicator lamp ② comes on and remains lit until the trunk closed.

- ▶ Release switch ①.

**!** The trunk lid swings open upwards automatically. Always make sure that there is sufficient overhead clearance.

To interrupt the opening procedure:

- ▶ Press or pull switch ①.

### Closing the trunk

#### Warning!



Only drive with the trunk closed as, among other dangers such as blocked visibility, exhaust fumes may enter the vehicle interior.

**i** When the hardtop is retracted, it must be completely lowered in the trunk before the trunk can be closed (▷ page 199).

**i** Do not place the SmartKey in the open trunk. You may lock yourself out.

**i** If the vehicle was previously centrally locked, the trunk will lock automatically after closing it. All turn signal lamps flash three times to confirm locking.

Vehicles with KEYLESS-GO\*: To prevent a possible inadvertent lockout, the trunk will open automatically if a SmartKey with KEYLESS-GO is recognized inside the vehicle or in the trunk.

The vehicle is only locked when the turn signals flash three times. If you are carrying a second SmartKey with KEYLESS-GO with you, you can still lock the vehicle.

### Closing trunk from outside manually

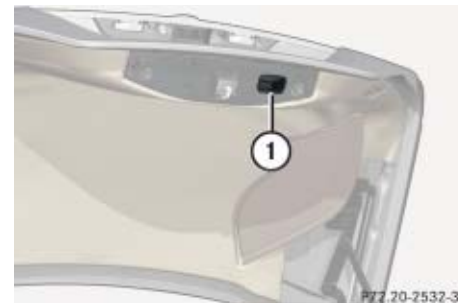

- ① Handle

- ▶ Lower trunk lid by pulling firmly on handle ①.
- ▶ Close trunk lid with hands placed flat on trunk lid.

The power closing assist automatically ensures that the lid is pulled closed completely (▷ page 118).

### Locking and unlocking

#### Warning!



To prevent possible personal injury, always keep hands and fingers away from the trunk lid opening when closing the trunk. Be especially careful when small children are around.

When leaving the vehicle, always remove the SmartKey or SmartKey with KEYLESS-GO\* from the starter switch, take it with you, and lock the vehicle. Do not leave children unattended in the vehicle, or with access to an unlocked vehicle. Unsupervised use of vehicle equipment may cause an accident and/or serious personal injury.

#### Closing trunk from inside automatically\*

#### Warning!



Maintain sight of trunk area while operating door mounted switch. Monitor the closing procedure carefully to make sure no one is in danger of being injured.

To interrupt the closing procedure, release the door mounted remote trunk opening/closing\* switch again.

Even with the SmartKey or SmartKey with KEYLESS-GO\* removed from the starter switch or the SmartKey with KEYLESS-GO\* removed from the vehicle, the remote trunk opening/closing\* switch can be operated. Therefore, do not leave children unattended in the vehicle, or with access to an unlocked vehicle. Unsupervised use of vehicle equipment may cause an accident and/or serious personal injury.

**i** If the trunk lid comes into contact with an object while closing (e.g. luggage that has been piled too high) in the upper motion sequence, the closing procedure is stopped and the trunk re-opens slightly.

In vehicles with trunk opening/closing system\* you can close the trunk from the inside using the remote trunk opening/ closing\* switch.



- ① Remote trunk opening/closing\* switch (vehicles with trunk opening/closing system\*)
- ② Indicator lamp

- ▶ Press and hold switch ① until the trunk is closed.

Indicator lamp ② in the switch goes out when the trunk is closed.

To interrupt the closing procedure:

- ▶ Release switch ①.

### Closing trunk from outside automatically\*

#### Warning!



Monitor the closing procedure carefully to make sure no one is in danger of being injured. To prevent possible personal injury, always keep hands and fingers away from the trunk lid opening when closing the trunk. Be especially careful when small children are around. To stop the closing procedure, do one of the following:

- Press button  on the SmartKey or SmartKey with KEYLESS-GO\*.
- Press the trunk opening/closing\* switch (on the driver's door).
- Press trunk closing switch.
- Press the KEYLESS-GO locking/closing switch\*.
- Pull the trunk lid handle.

Even with the SmartKey removed from the starter switch, the trunk opening/closing\* switch can be operated. Therefore, do not leave children unattended in the vehicle, or with access to an unlocked vehicle. Unsupervised use of vehicle equipment may cause an accident and/or serious personal injury.

In vehicles with trunk opening/closing system\* you can close the trunk separately from the outside using the trunk closing switch.

### Locking and unlocking

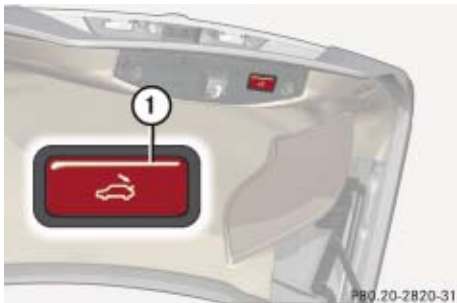

Vehicles without KEYLESS-GO\*

① Trunk closing switch



Vehicles with KEYLESS-GO\*

① Trunk closing switch

- ▶ Press trunk closing switch ① briefly.  
The trunk closes.

#### ***Closing trunk and locking vehicle from outside (vehicles with KEYLESS-GO\*)***

In vehicles with trunk opening/closing system\* and KEYLESS-GO\*, you can close the trunk and lock the vehicle simultaneously from the outside using the KEYLESS-GO locking/closing switch.



① KEYLESS-GO locking/closing switch

- ▶ Make sure you have the SmartKey with KEYLESS-GO with you.
- ▶ Press switch ① briefly.

With the doors closed, the locking knobs in the doors move down and the trunk starts to close automatically.

All turn signal lamps flash three times to confirm locking once the trunk has closed completely. The anti-theft alarm system is activated.

### Valet locking

**i** To deny any unauthorized person access to the trunk, e.g. when you valet park the vehicle, lock it separately with the mechanical key. Leave only the SmartKey or SmartKey with KEYLESS-GO\* less its mechanical key with the vehicle.

The lock is located next to the handle above the rear license plate recess.



- ① Neutral position
- ② Locked

- ▶ Close the trunk (▷ page 113).
- ▶ Pull the mechanical key out of the SmartKey (▷ page 391).
- ▶ Insert the mechanical key in the trunk lid lock.
- ▶ Turn the mechanical key clockwise to position ② and remove the mechanical key in that position to lock the trunk.

The trunk remains locked even when the vehicle is centrally unlocked.

**i** You can only cancel the separate trunk locking mode by means of the mechanical key.

- ▶ Insert the mechanical key in the trunk lid lock.
- ▶ Turn the mechanical key counterclockwise to neutral position ① and remove the mechanical key in that position to unlock the trunk.

You can now open the trunk (▷ page 111).

### Trunk lid emergency release

With the emergency release button, the trunk can be opened from inside the trunk.

The emergency release button is located on the left side of the trunk.



- ① Emergency release button
- ▶ Briefly press emergency release button ①.

The trunk opens.



### Locking and unlocking

- ▷▷ **i** *The emergency release button unlocks and opens the trunk while the vehicle is standing still or in motion.*

Illumination of the emergency release button:

- The button flashes for 30 minutes after opening the trunk.
- The button flashes for 60 minutes after closing the trunk.

**i** *The emergency release button does not open the trunk lid if the vehicle battery is discharged or disconnected.*

#### Power closing assist for trunk lid

It is not necessary to slam the trunk lid closed. A electrical power-assisted mechanism draws trunk lid closed quietly and automatically once trunk lid has been latched. When the pneumatic power-assisted mechanism has stopped, trunk can be re-opened.

#### Warning!



To prevent possible personal injury, always keep hands and fingers away from the trunk lid opening when closing the trunk. Be especially careful when small children are around.

In case of danger, pull the inside or outside door handle, or press the trunk lid lock.

To prevent personal injury, never actuate the closing assist mechanism by tampering with the door or trunk lid latch.

#### Power closing assist for trunk lid

- ▶ Press the trunk lid gently into its lock. The trunk closes automatically.

#### Warning!



Only drive with the trunk closed as, among other dangers such as blocked visibility, exhaust fumes may enter the vehicle interior.

### Automatic central locking

The doors and the trunk lid lock automatically when the vehicle is set into motion.

You can open a locked door from the inside. Open door only when conditions are safe to do so.

**i** The doors unlock automatically after an accident if the force of the impact exceeds a preset threshold.

The vehicle locks automatically when the ignition is switched on and the wheels are turning at vehicle speeds of approximately 9 mph (15 km/h) or more. You could therefore lock yourself out when the vehicle

- is pushed
- is on a test stand

You can deactivate the automatic locking using the control system (▷ page 162).

### Locking and unlocking from the inside

You can lock or unlock the vehicle from inside using the central locking switches. This can be useful, for example, if you want to unlock the passenger door from the inside or want to lock the vehicle before starting to drive.

The central locking switch does not lock or unlock the fuel filler flap.

#### Warning!



When leaving the vehicle, always remove the SmartKey or the SmartKey with KEYLESS-GO\* from the starter switch, take it with you, and lock the vehicle. Do not leave children unattended in the vehicle, or with access to an unlocked vehicle. Unsupervised use of vehicle equipment may cause an accident and/or serious personal injury.

#### Warning!



You can open a locked door from inside at any time. Open door only when conditions are safe to do so.

The switches are located above and between the center air vents of the air conditioning.



#### Central locking switches

- ① Locking
- ② Unlocking



### Locking and unlocking

#### Locking

- ▶ Press central locking switch ①.

If all the doors are closed, the vehicle locks.

#### Unlocking

- ▶ Press central unlocking switch ②.

The vehicle unlocks.

**i** *If the vehicle was previously centrally locked using the SmartKey or the SmartKey with KEYLESS-GO\*, it will not unlock using the central locking switch.*

*If the vehicle was previously locked with the central locking switch*

- *while in the global remote control mode, the complete vehicle is unlocked when a door is opened from the inside*
- *while in the selective remote control mode, only the door opened from the inside is unlocked*

## ▼ Seats

For more information on seat adjustment, see “Seat adjustment” (▷ page 43).

### Moving the seats forward and backward

You can move the seats forward and back to facilitate loading and unloading.

#### Warning!



When moving the seats, be sure that no one can be caught by them. Never place hands under seat or near any moving parts during a seat adjustment procedure. To stop the seat from moving when potential danger exists:

- press the switch again
- move the seat adjustment switch on the door (▷ page 42)

**!** *When moving the seats, make sure that there are no items in the footwell or behind the seats. Otherwise you could damage the seats.*

The switch is located on the top side of the seat.

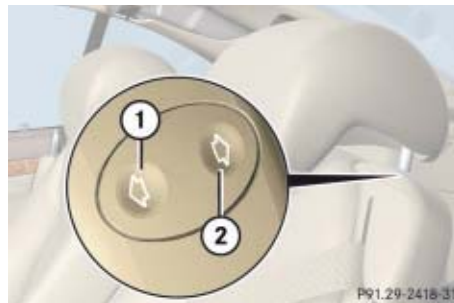

- ① Seat forward
- ② Seat backward

#### Moving the seat forward

- ▶ Press switch at ① and release.  
The seat moves forward automatically.

#### Moving the seat backward

- ▶ Press switch at ② and release.  
The seat moves backwards to its previous position automatically.

### Lumbar support

You can adjust the contour of the seat's lumbar support to help enhance support to your spine.

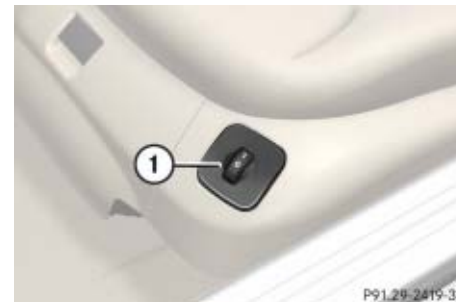

- ① Thumbwheel
- ▶ Switch on the ignition (▷ page 39).
- ▶ Set the lumbar support between 0 and 5.

### Seats

#### Multicontour backrest\*

The multicontour backrest has inflatable air cushions built into the seat backrest to provide additional lumbar and side support.

The seat backrest cushion height and curvature can be continuously varied with switches on the lower left side (driver's seat) or the lower right side (passenger side) of the seat when the ignition is switched on.



- ① Lumbar region support
- ② Shoulder region support
- ③ Side bolsters adjustment
- ④ Massage function (PULSE)

- ▶ Switch on the ignition (▷ page 39).

#### Shoulder region support

- ▶ Press **+** or **-** on switch ②.  
The air cushion inflates or deflates.

#### Lumbar region support

- ▶ Press **▽** or **△** on rocker switch ①.  
This selects the air cushion you wish to adjust.
- ▶ Press **+** or **-** on rocker switch ①.  
The air cushion inflates or deflates.

#### Side bolsters adjustment

- ▶ Press switch ③ to the right or left.  
The lateral support increases or decreases.

#### Massage function (PULSE)

You can reduce muscle tension during long trips by periodically using the massage function.

- ▶ Press button ④.

The indicator lamp on button ④ comes on. The air cushions in the lumbar region inflate and deflate rhythmically.

**i** The massage function switches off automatically after approximately 8 minutes. The indicator lamp goes out.

## Seat heating

### Vehicles without seat ventilation\*

The red indicator lamps on the switch indicate the selected heating level:

Level	
<b>2</b>	Two red indicator lamps on (rapid seat heating)  The seat heating automatically switches to level <b>1</b> after approximately 5 minutes.
<b>1</b>	One red indicator lamp on (normal seat heating)  The seat heating automatically switches off after approximately 30 minutes.
<b>off</b>	No red indicator lamp on

The switch is located on the door control panel.



- ① Normal heating
- ② Rapid heating

► Switch on the ignition (▷ page 39).

### Switching on seat heating

► Press lower switch position ①.

A red indicator lamp on the switch comes on.

### Switching off seat heating

► Press lower switch position ① once more.

### Switching on rapid seat heating

► Press upper switch position ②.

Both red indicator lamps on the switch come on.

### Switching off rapid seat heating

► Press upper switch position ② again.

**i** If one lamp or both lamps on the seat heating switch are flashing, there is insufficient voltage available since too many electrical consumers are turned on. The seat heating switches off automatically.

The seat heating will switch back on again automatically as soon as sufficient voltage is available.

## Seats

### Vehicles with seat ventilation\*

The red indicator lamps on the switch indicate the selected heating level:

Level	
2	Two red indicator lamps on (rapid seat heating) The seat heating automatically switches to level 1 after approximately 5 minutes.
1	One red indicator lamp on (normal seat heating) The seat heating automatically switches off after approximately 30 minutes.
off	No red indicator lamp on

The switch is located on the door control panel.



① Seat heating switch

- ▶ Switch on the ignition (▷ page 39).

### Switching on seat heating

- ▶ Press button ① repeatedly until the desired heating level is set.

One or two red indicator lamps on the button show the selected heating level.

### Switching off seat heating

- ▶ Press button ① repeatedly until all indicator lamps go out.

**i** If one or both of the lamps on the seat heating switch are flashing, there is insufficient voltage available since too many electrical consumers are turned on. The seat heating switches off automatically.

The seat heating will switch back on again automatically as soon as sufficient voltage is available.

**Seat ventilation\***

The blue indicator lamps on the switch indicate the selected ventilation level:

Level	
<b>3</b>	Three blue indicator lamps on (highest level)
<b>2</b>	Two blue indicator lamps on
<b>1</b>	One blue indicator lamp on (lowest level)
<b>off</b>	No blue indicator lamp on

The switch is located on the door control panel.



① Seat ventilation switch

- ▶ Switch on the ignition (▷ page 39).

**Switching on seat ventilation**

- ▶ Press switch ①.
- Three blue indicator lamps on the switch come on.
- ▶ Continue pressing switch ① until the desired seat ventilation level is reached.

**Switching off seat ventilation**

- ▶ Press switch ① repeatedly until all indicator lamps go out.

**i** If one or all of the lamps on the seat ventilation switch are flashing, there is insufficient voltage available since too many electrical consumers are turned on. The seat ventilation switches off automatically.

The seat ventilation will switch back on again automatically as soon as sufficient voltage is available.

### Memory function

Prior to operating the vehicle, the driver should check and adjust the seat height, seat position fore and aft, and seat backrest angle if necessary, to ensure adequate control, reach and comfort. The head restraint should also be adjusted for proper height. See also the section on air bags (▷ page 68) for proper seat positioning.

In addition, adjust the steering wheel to ensure adequate control, reach, operation and comfort. Both the interior and exterior rear view mirrors should be adjusted for adequate rear vision.

Fasten seat belts. Infants and small children should be seated in a properly secured restraint system that complies with U.S. Federal Motor Vehicle Safety Standard 213 and Canadian Motor Vehicle Safety Standard 213.

With the memory switch you can store up to three different settings.

The following settings are stored when using the buttons on the driver's door:

- Driver's seat and backrest position
- Steering wheel position
- Driver's side exterior rear view mirror position
- Passenger side exterior rear view mirror position

The following settings are stored when using the buttons on the passenger door:

- Passenger seat and backrest position

#### Warning!



Do not activate the memory function on the driver's side while driving. Activating the memory function while driving could cause the driver to lose control of the vehicle.

The memory switch is located on the door control panel.



**M** Memory button

**1, 2, 3** Stored positions

- ▶ Switch on the ignition (▷ page 39).
- or
- ▶ Open the respective door.

### Storing positions into memory

---

- ▶ Adjust the seats, steering wheel and exterior rear view mirrors to the desired position (▷ page 42).
- ▶ Press memory button **M**.
- ▶ Release memory button and press a stored position button **1**, **2**, or **3** within 3 seconds.

All the settings are stored at the selected position.

### Recalling positions from memory

---

- ▶ On memory switch, press and hold stored position button **1**, **2** or **3** until the seat, steering wheel and exterior rear view mirrors have fully moved to the stored positions.

 *Releasing the button immediately stops movement to the stored positions.*



### Lighting

For information on how to switch on the headlamps and use the turn signals, see “Switching on headlamps” (▷ page 55) and “Turn signals” (▷ page 56).

**i** *If you drive in countries where vehicles drive on the other side of the road than the country in which the vehicle is registered, you must have the headlamps modified for symmetrical low beams. Relevant information can be obtained at any authorized Mercedes-Benz Center.*

#### Exterior lamp switch

The exterior lamp switch is located on the dashboard to the left of the steering wheel.



- 0** Off  
Daytime running lamp mode  
(▷ page 130)
- AUTO** Automatic headlamp mode  
Daytime running lamp mode  
(▷ page 130)
- D** Parking lamps (also tail lamps, license plate lamps, side marker lamps, instrument panel lamps)

Canada only: When the engine is running, the low beam headlamps are also switched on.

- D** Low beam headlamps (or high beam headlamps when the combination switch is pushed forward) and parking lamps
- P<->** Standing lamps, right (turn left one stop)
- <-P** Standing lamps, left (turn left two stops)
- D** Indicator lamp for parking lamps
- D** Indicator lamp for front fog lamps
- 0** Indicator lamp for rear fog lamp

**i** *With the SmartKey removed from the starter switch or the engine turned off with KEYLESS-GO\* and the driver's door open, a warning sounds if the parking lamps or the low beam headlamps are switched on.*

The message **Turn off lamps** appears in the multifunction display.

### Manual headlamp mode

The low beam headlamps and parking lamps can be switched on or off with the exterior lamp switch (▷ page 55).

### Automatic headlamp mode

The following lamps switch on and off automatically depending on the brightness of the ambient light:

- Low beam headlamps
- Tail lamps
- Parking lamps
- License plate lamps
- Side marker lamps



#### Warning!



If the exterior lamp switch is set to **AUTO**,

- the headlamps may switch off unexpectedly when the system senses bright ambient light, for example light from oncoming traffic.
- the headlamps will not be automatically switched on under foggy conditions.

To minimize risk to you and to others, activate headlamps by turning exterior lamp switch to  when driving or when traffic and / or ambient lighting conditions require you to do so.

In low ambient lighting conditions, only switch from position **AUTO** to  with the vehicle at a standstill in a safe location. Switching from **AUTO** to  will briefly switch off the headlamps. Doing so while driving in low ambient lighting conditions may result in an accident.

The automatic headlamp feature is only an aid to the driver. The driver is responsible for the operation of the vehicle's lights at all times.

- ▶ Turn the exterior lamp switch to position **AUTO**.

With the SmartKey in starter switch position **1** or the KEYLESS-GO start/stop button pressed once, only the parking lamps and side marker lamps will switch on and off automatically.

When the engine is running, the low beam headlamps, the tail and parking lamps, the license plate lamps, and the side marker lamps will switch on and off automatically.

### Lighting

#### Daytime running lamp mode

- ▶ Turn the exterior lamp switch to position  or **AUTO**.

When the engine is running, the low beam headlamps are switched on automatically.

In low ambient light conditions, the following lamps will switch on additionally:



- Tail lamps
- Side marker lamps
- Parking lamps
- License plate lamps

#### Canada only:

The daytime running lamp mode is mandatory and therefore in a constant mode.

When the engine is running and you shift from a driving position to position **N** or **P**, the low beam headlamps will switch off with a three-minute delay.



When the engine is running and you

- turn the exterior lamp switch to position , the parking lamps switch on additionally
- turn the exterior lamp switch to position , the manual headlamp mode has priority over the daytime running lamp mode

The corresponding exterior lamps switch on (▷ page 128).

#### USA only:

By default, the daytime running lamp mode is deactivated. Activate the daytime running lamp mode using the control system, see “Setting daytime running lamp mode (USA only)” (▷ page 159).

When the engine is running and you turn the exterior lamp switch to position  or , the manual headlamp mode has priority over the daytime running lamp mode.



The corresponding exterior lamps switch on (▷ page 128).

#### Locator lighting and night security illumination



Locator lighting and night security illumination are described in the control system section, see “Setting locator lighting” (▷ page 160) and “Setting night security illumination” (▷ page 160).

## Fog lamps

**Warning!**

In low ambient lighting or foggy conditions, only switch from position **AUTO** to  with the vehicle at a standstill in a safe location. Switching from **AUTO** to  will briefly switch off the headlamps. Doing so while driving in low ambient lighting conditions may result in an accident.

 *Fog lamps will operate with the parking lamps and/or the low beam headlamps on. Fog lamps should only be used in conjunction with low beam headlamps. Consult your State or Province Motor Vehicle Regulations regarding permissible lamp operation.*

 *The fog lamps cannot be switched on with the exterior lamp switch in position **AUTO**. To switch on the fog lamps, turn the exterior lamp switch to position  first.*

**Front fog lamps**

- ▶ Switch on the low beam headlamps (▷ page 55).
- ▶ Pull out the exterior lamp switch to first stop.

The front fog lamps are switched on.

The green indicator lamp  in the exterior lamp switch comes on (▷ page 128).

- ▶ Push in the exterior lamp switch.

The front fog lamps are switched off.

The green indicator lamp  in the exterior lamp switch goes out.

**Rear fog lamp (driver's side only)**

- ▶ Switch on the front fog lamps (▷ page 131).
- ▶ Pull out the exterior lamp switch to second stop.

The rear fog lamp is switched on.

The yellow indicator lamp  in the lamp switch comes on (▷ page 128).

- ▶ Push in the exterior lamp switch to first stop.

The rear fog lamp is switched off.

The yellow indicator lamp  in the exterior lamp switch goes out.

The front fog lamps remain lit.

### Lighting

#### Corner-illuminating front fog lamps

The corner-illuminating front fog lamps improve illumination of the road into which you are turning.

The corner-illuminating front fog lamps will operate with the engine running and with

- the exterior lamp switch in position  (▷ page 128)  
or
- the exterior lamp switch in position **AUTO** (▷ page 128)  
or
- the daytime running lamp mode activated (▷ page 130)

**i** *Corner-illuminating front fog lamps will only come on in low ambient lighting conditions.*

*The corner-illuminating front fog lamps function is not available at a vehicle speed above 25 mph (40 km/h).*

#### Driving forward

##### **Switching on corner-illuminating front fog lamps**

- ▶ Depending on whether you are turning left or right, switch on the left or right turn signal (▷ page 56).

The respective front fog lamp comes on and illuminates the road onto which you are turning.

**i** *The corner-illuminating front fog lamps will come on automatically depending on the steering angle, even if you did not switch on either turn signal.*

*If the corner-illuminating front fog lamps came on automatically, they will also go out automatically depending on the steering angle.*

##### **Switching off corner-illuminating front fog lamps**

The combination switch for the turn signal resets automatically after major steering wheel movements. This will switch off the

corner-illuminating front fog lamps if they were activated by switching on the left or right turn signal.

If the turn signal should stay on after making the turn, the turn signal and corner-illuminating front fog lamp can be switched off by returning the combination switch to its original position.

#### Driving rearward

##### **Switching on corner-illuminating front fog lamps**

- ▶ Place the gear selector lever in position **R**.

The inverse front fog lamp comes on automatically depending on the steering direction and steering angle.

##### **Switching off corner-illuminating front fog lamps**

- ▶ Place the gear selector lever out of position **R**.

The respective front fog lamp goes out.

### Combination switch

The combination switch is located on the left of the steering column.



#### Combination switch

- ① High beam
- ② High beam flasher

### High beam

- ▶ Turn the exterior lamp switch to  or to **AUTO** (▷ page 128).
- ▶ Push the combination switch in direction of arrow ① to switch on the high beam headlamps.

The high beam indicator lamp  in the instrument cluster comes on.

- ▶ Pull the combination switch in direction of arrow ② to its original position to switch off the high beam headlamps.

The high beam indicator lamp  in the instrument cluster goes out.

### High beam flasher

- ▶ Pull the combination switch briefly in direction of arrow ②.

### Hazard warning flasher

The hazard warning flasher can be switched on at all times, even with the SmartKey removed from the starter switch or with the SmartKey with KEYLESS-GO\* removed from the vehicle.

The hazard warning flasher switches on automatically when an air bag deploys.

The switch is located on the dashboard between the center air vents.



- ① Hazard warning flasher switch

### Lighting

#### Switching on the hazard warning flasher

- ▶ Press hazard warning flasher switch ①.

All turn signals are flashing.

**i** With the hazard warning flasher activated and the combination switch set for either left or right turn, only the respective turn signals will operate when the ignition is switched on.

#### Switching off the hazard warning flasher

- ▶ Press hazard warning flasher switch ① again.

**i** If the hazard warning flasher was switched on automatically because of an air bag that has deployed, press hazard warning flasher switch ① once to switch it off.

#### Interior lighting

The interior lighting controls are located in the overhead control panel.



- ① Left reading lamp on/off
- ② Right reading lamp on/off
- ③ Interior lighting on/off
- ④ Slide switch for interior lighting control

**!** An interior lamp switched on manually does not go out automatically.

Leaving the interior lighting switch in the ON position for extended periods of time with the engine turned off could result in discharged batteries.

#### Deactivating automatic control

**i** The interior lighting is factory-set to automatic mode.

- ▶ Slide switch ④ to the right.

The interior lighting and the entry/exit lamps remain switched off in darkness, even when you

- unlock the vehicle
- remove the SmartKey from the starter switch
- open a door
- open the trunk

### Activating automatic control

- ▶ Slide switch ④ to the left.

The interior lighting switches on in darkness when you

- unlock the vehicle
- remove the SmartKey from the starter switch
- open a door
- open the trunk

In addition, the entry/exit lamps in the door trays come on when you open a door.

The interior lighting switches off after approximately 10 seconds if the interior lighting delayed switch-off feature is set to On in the control system (▷ page 161).

**i** *If a door remains open, the interior lighting switches off automatically after approximately 5 minutes.*

### Manual control

#### Switching interior lighting on and off

- ▶ Press switch ③.

The interior lighting switches on.

- ▶ Press switch ③ once more.

The interior lighting switches off.

#### Switching reading lamps on and off

- ▶ Press reading lamp switch ① or ② to switch on the desired reading lamp.
- ▶ Press reading lamp switch ① or ② again to switch off the respective reading lamp.

### Courtesy lighting

For better orientation in the dark, courtesy lamps will illuminate the interior of your vehicle as follows:

With parking lamps switched on:

- the door handles
- the driver and passenger footwells

With SmartKey in starter switch position 1:

- the door handles
- the center console

**i** *If you turn the SmartKey in the starter switch to position 0 and switch off the headlamps, the door handle lamps will remain lit for approximately 5 minutes.*

### Trunk lamp

The trunk lamp switches on when the trunk is opened.

If the trunk lid remains open, the trunk lighting switches off automatically after approximately 10 minutes.



### Instrument cluster

For a full view illustration of the instrument cluster, see “Instrument cluster” (▷ page 26).

The instrument cluster is activated when you

- open a door
- switch on the ignition
- press the reset button (▷ page 26)
- switch on the exterior lamps

Opening a door will activate the instrument cluster only for about 30 seconds.

You can change the instrument cluster settings in the Instrument cluster submenu of the control system (▷ page 156).

### Adjusting instrument cluster illumination

Use the reset button to adjust the illumination brightness for the instrument cluster and the switches on the center console.

**i** *The instrument cluster illumination is dimmed or brightened to suit ambient light conditions.*



① Reset button

### Warning!



No messages will be displayed if either the instrument cluster or the multifunction display is inoperative.

As a result, you will not be able to see information about your driving conditions, such as speed or outside temperature, warning/indicator lamps, malfunction/warning messages or the failure of any systems. Driving characteristics may be impaired.

If you must continue to drive, do so with added caution. Visit an authorized Mercedes-Benz Center as soon as possible.

### To brighten illumination

- ▶ Turn reset button ① in the instrument cluster clockwise.

The instrument cluster illumination will brighten.

### To dim illumination

- ▶ Turn reset button ① in the instrument cluster counterclockwise.

The instrument cluster illumination will dim.

### Coolant temperature gauge

#### Warning!



- Driving when your engine is overheated can cause some fluids which may have leaked into the engine compartment to catch fire. You could be seriously burned.
- Steam from an overheated engine can cause serious burns which can occur just by opening the hood. Stay away from the engine if you see or hear steam coming from it.



Turn off the engine, get out of the vehicle and do not stand near the vehicle until the engine has cooled down.

**!** Excessive coolant temperature triggers the coolant temperature warning lamp (▷ page 337) and a warning in the multifunction display (▷ page 371).

*The engine should not be operated with the coolant temperature above 248°F (120°C). Doing so may cause serious engine damage which is not covered by the Mercedes-Benz Limited Warranty.*

**i** During severe operating conditions, e.g. stop-and-go traffic, the coolant temperature may rise close to 248°F (120°C).

### Trip odometer

- ▶ Make sure you are viewing the trip odometer display (▷ page 139).
- ▶ If it is not displayed, press the  or  button on the multifunction steering wheel repeatedly until the trip odometer appears.
- ▶ Press and hold reset button ① (▷ page 136) until the trip odometer is reset.

#### Tachometer

The red marking on the tachometer denotes excessive engine speed.

**!** *Avoid driving at excessive engine speeds, as it may result in serious engine damage that is not covered by the Mercedes-Benz Limited Warranty.*

To help protect the engine, the fuel supply is interrupted if the engine is operated within the red marking.

#### Outside temperature indicator

##### Warning!



The outside temperature indicator is not designed to serve as an ice-warning device and is therefore unsuitable for that purpose.

Indicated temperatures just above the freezing point do not guarantee that the road surface is free of ice. The road may still be icy, especially in wooded areas or on bridges.

The outside temperature is displayed in the left or right multifunction display (▷ page 26), depending on the setting (▷ page 156).

The temperature sensor is located in the front bumper area. Due to its location, the sensor can be affected by road or engine heat during idling or slow driving. Therefore, the accuracy of the displayed temperature can only be verified by comparison to a thermometer placed next to the sensor, not by comparison to external displays, e.g. bank signs, etc.

When moving the vehicle into colder ambient temperatures (e.g. when leaving your garage), you will notice a delay before the lower temperature is displayed.

A delay also occurs when ambient temperatures rise. This prevents inaccurate temperature indications caused by heat radiated from the engine during idling or slow driving.

## ▼ Control system

The control system is activated as soon as the SmartKey in the starter switch is turned to position **1** or as soon as the KEYLESS-GO start/stop button is in position **1**. The control system enables you to

- call up information about your vehicle
- change vehicle settings

For example, you can use the control system to find out when your vehicle is next due for service, to set the language for messages in the instrument cluster display, and much more.

### Warning!



A driver's attention to the road and traffic conditions must always be his/her primary focus when driving.

For your safety and the safety of others, selecting features through the multifunction steering wheel should only be done by the driver when traffic and road conditions permit it to be done safely.

Bear in mind that at a speed of just 30 mph (approximately 50 km/h), your vehicle is covering a distance of 44 feet (approximately 14 m) every second.

The control system relays information to the multifunction display.

## Multifunction display

The multifunction display consists of the display fields in the speedometer and the tachometer. In its default state, the left multifunction display shows the main odometer and the outside temperature, while the trip odometer appears in the right multifunction display. This default setting is referred to as the standard display.

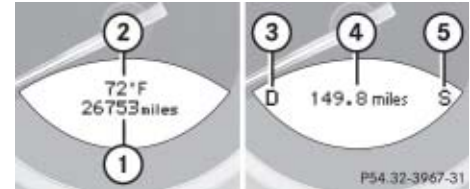

- ① Main odometer
- ② Outside temperature
- ③ Current gear selector lever position
- ④ Trip odometer
- ⑤ Automatic transmission program mode

## Control system

### Multifunction steering wheel

The displays in the multifunction display and the settings in the control system are controlled by the buttons on the multifunction steering wheel.

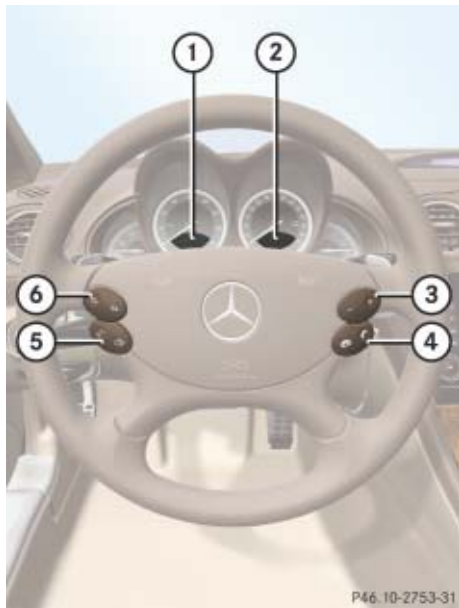

- ① Left multifunction display in the speedometer
- ② Right multifunction display in the tachometer

#### Operating the control system

- ③ Selecting the submenu or setting the volume:  
Press button
  - down / to decrease
  - + up / to increase
- ④ Telephone\*:  
Press button
  - ☎ to take a call
  - ☎ to end a call





- ⑤ Menu systems:  
Press button
  - ☰ for previous menu
  - ☰ for next menu
- ⑥ Moving within a menu:  
Press button
  - ⬆ for next display
  - ⬆ for previous display

Depending on the selected menu, pressing the buttons on the multifunction steering wheel will alter what appears in the multifunction display.

The information available in the multifunction display is arranged in menus, each containing a number of functions or sub-menus.

The individual functions are then found within the relevant menu (radio or CD operations under **AUDIO**, for example). These functions serve to call up relevant information or to customize the settings for your vehicle.

It is helpful to think of the menus, and the functions within each menu, as being arranged in a circular pattern.

- If you press button  or  repeatedly, you will pass through each menu one after the other.
- If you press button  or  repeatedly, you will pass through each function display, one after the other, in the current menu.

In the **Settings** menu, instead of functions you will find a number of submenus for calling up and changing settings. For instructions on using these submenus, see “Settings menu” (▷ page 153).

The number of menus available in the system depends on which optional equipment is installed in your vehicle.

The menus are described on the following pages.

## Control system

### Menus

This is what you will see when you scroll through the menus.

The table below provides an overview of the individual menus.

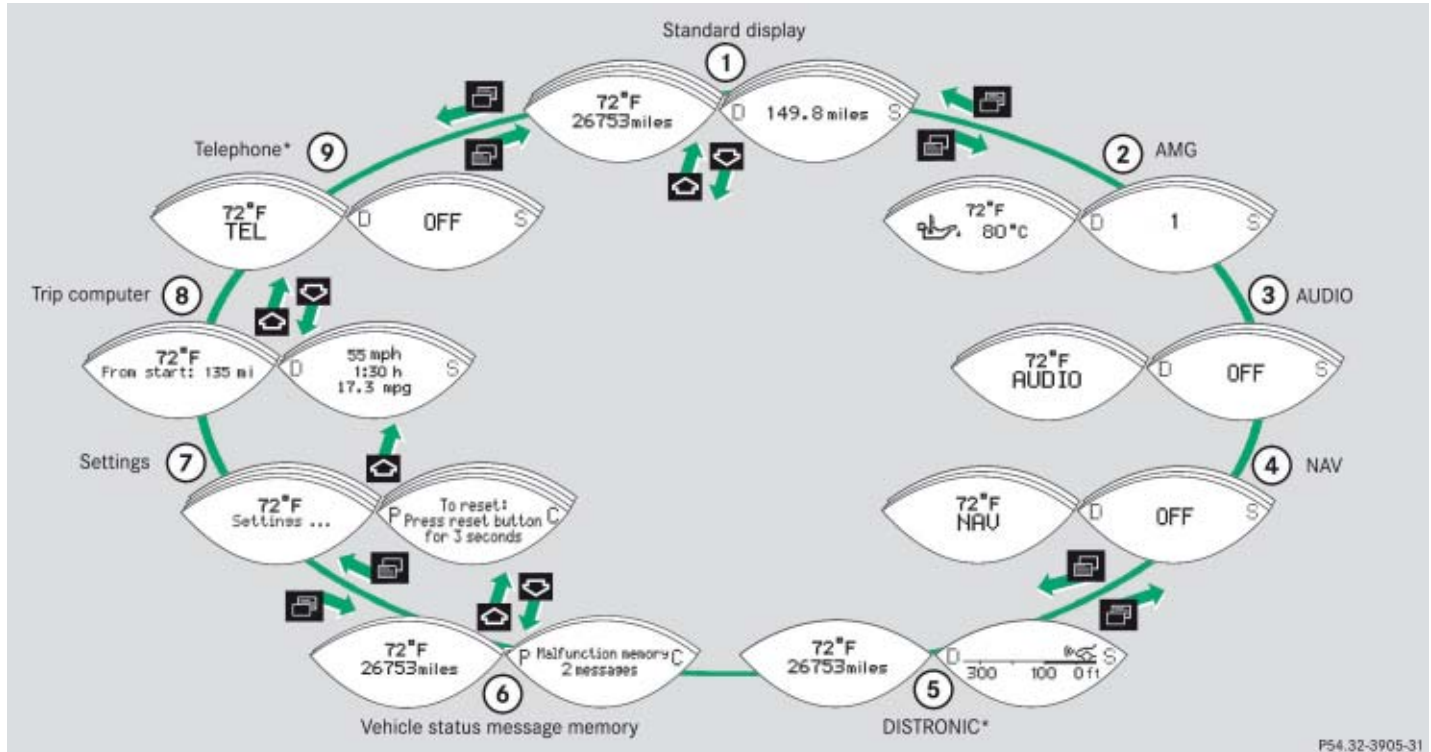

P54.32-3905-31

### Menus, submenus and functions

	<b>Menu ①</b> <b>Standard display</b> (▷ page 145)	<b>Menu ②</b> <b>AMG<sup>1</sup></b> (▷ page 146)	<b>Menu ③</b> <b>AUDIO</b> (▷ page 149)	<b>Menu ④</b> <b>NAV</b> (▷ page 151)	<b>Menu ⑤</b> <b>Distronic*</b> (▷ page 151)
<b>Commands/submenus</b>	Digital speedometer/Outside temperature  Calling up maintenance service indicator  Checking tire inflation pressure*  Checking engine oil level	Engine oil temperature  Vehicle supply voltage  RACETIMER  Overall analysis  Lap analysis	Selecting radio station  Selecting satellite radio station (USA only)  Operating CD player	Show route guidance instructions, current direction traveled	Calling up settings

<sup>1</sup> AMG vehicles only.

Table continued on next page.



## Control system

	<b>Menu ⑥</b> <b>Vehicle status message memory<sup>1</sup></b> (▷ page 152)	<b>Menu ⑦</b> <b>Settings</b> (▷ page 153)	<b>Menu ⑧</b> <b>Trip computer</b> (▷ page 163)	<b>Menu ⑨</b> <b>Telephone*</b> (▷ page 165)
<b>Commands/submenus</b>	Calling up vehicle malfunction, warning and system status messages stored in memory	Resetting to factory settings  Instrument cluster submenu  Time submenu Lighting submenu Vehicle submenu Convenience submenu	Fuel consumption statistics after start  Fuel consumption statistics since the last reset  Distance to empty	Loading phone book  Searching for name in phone book



<sup>1</sup> You will only see the message memory menu if there is a message.

**i** *The headings used in the menus table are designed to facilitate navigation within the system and are not necessarily identical to those shown in the control system displays.*

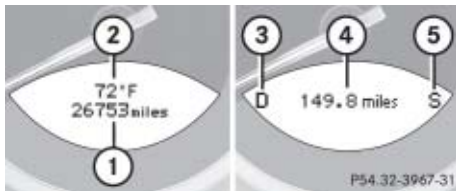

*The first function displayed in each menu will automatically show you which part of the system you are in.*

### Standard display menu



- ① Main odometer
  - ② Outside temperature
  - ③ Current gear selector lever position
  - ④ Trip odometer
  - ⑤ Automatic transmission program mode
- ▶ Press button  or  repeatedly until you see the standard display menu in the multifunction display.

You can modify the standard display menu. Instead of outside temperature ②, you can choose the digital speedometer to be displayed in the left multifunction display by changing the setting in the Select display function of the Inst. cluster sub-menu (▷ page 157).



- ▶ Press button  or  to select the functions in the standard display menu.

The following functions are available:

Function	Page
Calling up digital speedometer	145
Calling up maintenance service indicator	320
Checking tire inflation pressure	292
Checking engine oil level	276

### Display digital speedometer or outside temperature

**i** If you have selected the digital speedometer for the standard display (▷ page 157), select the outside temperature display here.

- ▶ Press button  or  until the digital speedometer or, depending on the chosen setting, the outside temperature appears in the right multifunction display.

## Control system

### AMG menu

**i** This function is only available in AMG vehicles.

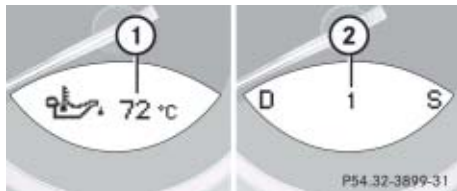

The main screen of the AMG menu shows you the gear currently engaged as well as the engine oil temperature.

- ▶ Press button  or  repeatedly until you see the AMG menu.



- ① Engine oil temperature
- ② Gear indicator



**i** The engine oil temperature symbol flashes if the engine oil temperature has not yet reached 80°C. During this time, avoid driving at full engine speed.

Use buttons  or  to select the following functions in the AMG menu:

Function	Page
Vehicle supply voltage	146
RACETIMER	147
Overall analysis	148
Lap analysis	149

**i** If the engine reaches the overspeed range in the manual shift program, the menu will be shown in red. In addition, you will see **UP** next to gear indicator ② as a reminder to upshift.

### Vehicle supply voltage

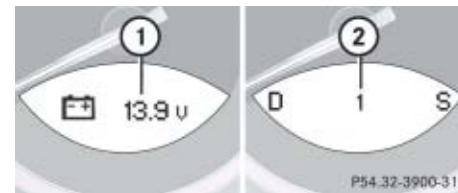

- ▶ Press button  or  repeatedly until you see the AMG menu.
- ▶ Press button  repeatedly until you see the vehicle supply voltage.



- ① Vehicle supply voltage
- ② Gear indicator

## RACETIMER

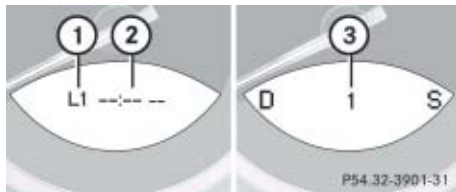

The RACETIMER allows you to time and save driving stretches in hours, minutes and seconds.

- ▶ Press button  or  repeatedly until you see the AMG menu.
- ▶ Press button  repeatedly until you see the RACETIMER.



- ① Lap
- ② RACETIMER
- ③ Gear indicator

**i** You can start the RACETIMER when the engine is running or the starter switch is in position 2 (▷ page 39).

**i** While the RACETIMER is being displayed, you cannot adjust the volume using buttons  or .

### Starting the RACETIMER

- ▶ Press button .
- The timer starts.

### Displaying intermediate time

- ▶ Press button  while the timer is running.
- The intermediate time is shown for 5 seconds.

### Stopping the RACETIMER

- ▶ Press button .
- The timer stops.

**i** When you stop the vehicle and turn the Smartkey to position 1 (▷ page 40) or, in vehicles with KEYLESS-GO\*, turn off the engine and do not open the driver's door, the RACETIMER stops timing. Timing is resumed when you switch the ignition back on (▷ page 39) or restart the engine (▷ page 52) and then press the  button.

### Saving lap time and starting a new lap

**i** You can save up to nine laps.

- ▶ Press button  while the timer is running.

The intermediate time will be shown for 5 seconds.



### Control system

- ▷▷ Press button **[-]** within the next 5 seconds.

The intermediate time shown will be saved as a lap time.

The RACETIMER begins timing the new lap. The new lap begins to be timed as soon as the intermediate time is called up.

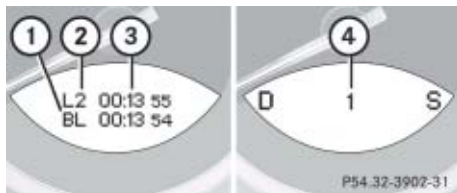

- ① Best lap time
- ② Lap number
- ③ RACETIMER
- ④ Gear indicator

#### Resetting current lap

- ▶ Press button **[+]** while the timer is running.

The timer stops.

- ▶ Press button **[-]**.

The lap time is reset to “0”.

#### Deleting all laps

**i** It is not possible to delete a single saved lap.

- ▶ Press button **[+]** while the timer is running.

The timer stops.

- ▶ Press the reset button twice (▷ page 27).

- ▶ Press button **[+]**.

The timer starts. The saved laps are deleted.

**i** When you switch off the engine, the RACETIMER will be reset to “0” after 30 seconds. All laps are deleted.

#### Overall analysis

**i** These functions are only available if you have saved at least one lap and have stopped the RACETIMER.

- ▶ Press button **[⏏]** or **[⏏]** repeatedly until you see the AMG menu.

- ▶ Press button **[⏏]** repeatedly until you see the overall analysis.

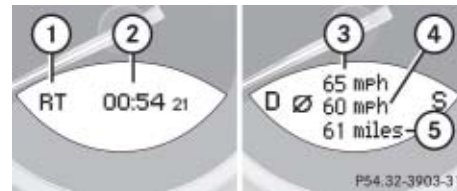

- ① Overall analysis of RACETIMER
- ② Overall driving time
- ③ Maximum speed
- ④ Average speed
- ⑤ Overall distance driven

### Lap analysis

**i** These functions are only available if you have saved at least two laps and have stopped the RACETIMER.

- ▶ Press button or repeatedly until you see the AMG menu.
- ▶ Press button repeatedly until you see the lap analysis.

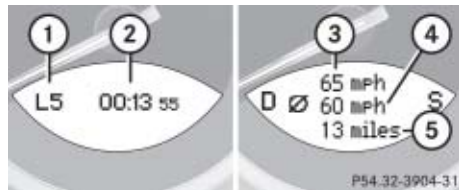

- ① Lap number
- ② Lap time
- ③ Maximum speed
- ④ Average speed during lap
- ⑤ Lap length

- ▶ Press button or to see other lap analyses.

**i** Each lap is shown in its own submenu. The fastest lap is indicated by flashing symbol ①.

### AUDIO menu

The functions in the AUDIO menu operate the audio equipment which you currently have turned on.

If no audio equipment is currently turned on, the message AUDIO OFF appears in the right multifunction display.

The following functions are available:

Function	Page
Selecting radio station	149
Selecting satellite radio station (USA only)	150
Operating CD player	150

### Selecting radio station

- ▶ Turn on COMAND and select radio. Refer to the separate operating instructions.
- ▶ Press button or repeatedly until you see the currently tuned station in the right multifunction display.

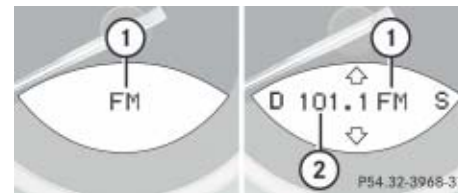

- ① Waveband setting
- ② Station frequency



- ▶ Press button or repeatedly until the desired station is found.

**i** You can only store new stations using the designated feature on the radio. Refer to the separate operating instructions.

### Control system



#### Selecting satellite radio station (USA only)

The satellite radio is treated as a radio application.

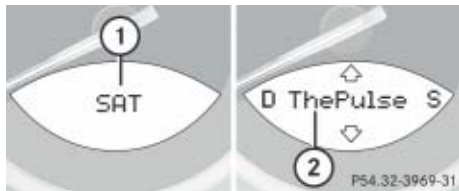
- ▶ Select satellite radio with the corresponding key on the COMAND control panel (SAT).
- ▶ Press button  or  repeatedly until you see the currently tuned station in the right multifunction display.



- ① SAT mode
- ② Channel name or number



- ▶ Press button  or  repeatedly until the desired channel is found.

**i** Additional optional satellite radio equipment and a subscription to satellite radio service provider are required for satellite radio operation. Contact an authorized Mercedes-Benz Center for details and availability for your vehicle.



For more information, refer to separate COMAND operating instructions.

#### Operating the CD player

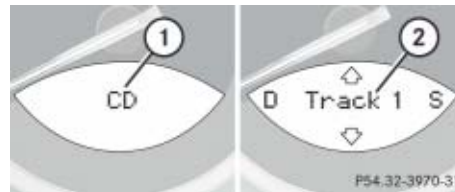

##### Selecting CD track

- ▶ Turn on COMAND and select CD. Refer to the separate COMAND operating instructions.
- ▶ Press button  or  repeatedly until the settings for the CD currently being played appear in the right multifunction display.



- ① Current CD (with additional number from 1 to 6 when running from CD changer)
  - ② Current track
- ▶ Press button  or  repeatedly until the desired track is selected.

### Selecting MP3-CD track

- ▶ Turn on COMAND and select MP3-CD. Refer to the separate COMAND operating instructions.
- ▶ Press button  or  repeatedly until the settings for the MP3-CD currently being played appear in the right multifunction display.

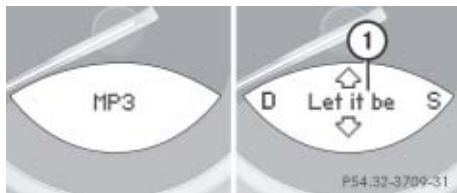



① Current track

- ▶ Press button  or  repeatedly until the desired track is selected.

### NAV menu

The NAV menu contains the functions needed to operate your navigation system.

- ▶ Press button  or  repeatedly until you see the message NAV in the left multifunction display.

The message shown in the multifunction display depends on the status of the navigation system:

- With COMAND switched off, the message NAV off appears in the multifunction display.
- With COMAND switched on but route guidance not activated, the direction of travel and, if applicable, the name of the street currently traveled on appear in the multifunction display.
- With COMAND switched on and route guidance activated, the direction of travel and maneuver instructions appear in the multifunction display.

Please refer to the COMAND manual for instructions on how to activate the route guidance system.

### Distronic\* menu

Use the Distronic menu (▷ page 217) to display the current settings for your Distronic system. The information shown in the multifunction display depends on whether the Distronic system is activated or deactivated.

Please refer to the “Driving systems” section of this manual (▷ page 213) for instructions on how to activate Distronic.

- ▶ Press button  or  repeatedly to select the Distronic menu in the multifunction display.



#### Vehicle status message memory menu



Use the vehicle status message memory menu to scan malfunction and warning messages that may be stored in the system. Such messages appear in the multifunction display and are based on conditions or system status the vehicle's system has recorded.

The vehicle status message memory menu only appears, if messages have been stored.

#### Warning!



Malfunction and warning messages are only indicated for certain systems and are intentionally not very detailed. The malfunction and warning messages are simply a reminder with respect to the operation of certain systems and do not replace the owner's and/or driver's responsibility to maintain the vehicle's operating safety by having all required maintenance and safety checks performed on the vehicle and by bringing the vehicle to an authorized Mercedes-Benz Center to address the malfunction and warning messages (▷ page 347).



- ▶ Press button  or  repeatedly until the vehicle status message memory menu appears in the multifunction display.

If the vehicle status message memory menu does not appear, no messages have been stored.

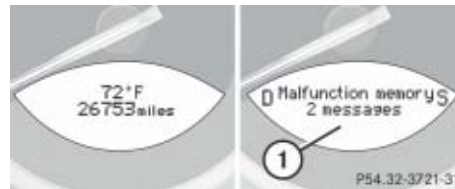
If conditions have occurred causing status messages to be recorded, the number of messages appears in the right multifunction display:



- ① Number of recorded status messages

- ▶ Press button  or .

The stored messages will now be displayed in the order in which they have occurred. For malfunction and warning messages, see “Vehicle status messages in the multifunction display” (▷ page 347).

- i** After you have scrolled through all recorded status messages, the first recorded message appears again.

Should the vehicle's system record any conditions while driving, the number of messages will reappear in the multifunction display

- when the SmartKey in the starter switch is turned to position **0** or removed from the starter switch  
or
- when you turn off the engine by pressing the KEYLESS-GO\* start/stop button on the gear selector lever once and open the driver's door (this puts the starter switch in position **0**, same as with the SmartKey removed from the starter switch)

**i** The vehicle status message memory will be cleared when you then turn the SmartKey in the starter switch to position **1** or **2**, or when you press the KEYLESS-GO\* start/stop button once or twice without depressing the brake pedal. You will then only see high priority messages in the multifunction display (▷ page 347).

### Settings menu

In the Settings menu there are two functions:

- The function Reset, with which you can reset most settings to those set at the factory.
- A collection of submenus with which you can make individual settings for your vehicle.



The following settings and submenus are available:

Function	Page
Resetting all settings	153
Submenus in the Settings menu	154
Instrument cluster submenu	156
Time submenu	157
Lighting submenu	159
Vehicle submenu	162
Convenience submenu	162

### Resetting all settings

You can reset the functions of most of the submenus to the factory settings.

For safety, the Light circuit Headlamp mode submenu in the Lighting menu can be reset with the vehicle at standstill only.

- ▶ Press button  or  repeatedly until the Settings... menu appears in the multifunction display.



### Control system

- ▶▶ Press the reset button in the instrument cluster for approximately 3 seconds.



In the right multifunction display you will see the request to press the reset button again to confirm.

- ▶ Press the reset button again.

The functions of all the submenus will reset to factory settings.

**i** *The settings you have changed will not be reset unless you confirm the action by pressing the reset button a second time.*

#### Submenus in the Settings menu

- ▶ Press button  or  repeatedly until the Settings... menu appears in the multifunction display.

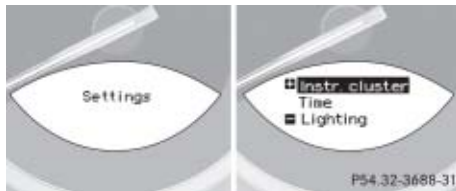

- ▶ Press button .

In the right multifunction display you see the collection of submenus. There are more submenus than can be simultaneously displayed.







- ▶ Press button .

The selection marker moves to the next submenu.

- ▶ Scroll down with the  button, scroll up with the .

- ▶ With the selection marker on the desired submenu, use the  button to access the individual functions within that submenu.

- ▶ Once within the submenu, use the  button to move to the next function or the  button to move to the previous function within that submenu.

- ▶ Use buttons  or  to change the settings of the respective function.

The table below shows what settings can be changed within the various menus. Detailed instructions on making individual settings can be found on the following pages.

<b>Instrument cluster</b> (▷ page 156)	<b>Time</b> (▷ page 157)	<b>Lighting</b> (▷ page 159)	<b>Vehicle</b> (▷ page 162)	<b>Convenience</b> (▷ page 162)
Selecting standard display	Synchronizing time with head unit	Setting daytime running lamp mode (USA only)	Setting automatic locking	Activating easy-entry/exit feature
Selecting speedometer display mode	Setting the time (hours)	Setting locator lighting		
Selecting language	Setting the time (minutes)	Setting night security illumination		
		Setting interior lighting delayed switch-off		

## Control system

### Instrument cluster submenu

Access the Inst. cluster submenu via the Settings menu. Use the Inst. cluster submenu to change the instrument cluster display settings. The following functions are available:

Function	Page
Selecting speedometer display mode	156
Selecting language	156
Selecting standard display	157

### Selecting speedometer display mode

- ▶ Move the selection marker with button **+** or **-** to the Inst. cluster submenu.
- ▶ Press button **↶** or **↷** repeatedly until you see this message in the left multifunction display:  
Digital speedometer.

The selection marker is on the current setting.



- ▶ Press **+** or **-** to set the speedometer units to Kilometers or Miles.

### Selecting language

- ▶ Move the selection marker with button **+** or **-** to the Inst. cluster submenu.
- ▶ Press button **↶** or **↷** repeatedly until the message Text appears in the multifunction display.

The selection marker is on the current setting.



- ▶ Press **+** or **-** to select the language to be used for the multifunction display messages.

Available languages:

- German
- English
- French
- Italian
- Spanish
- Dutch
- Swedish
- Danish
- Turkish
- Portuguese

### Selecting standard display

- ▶ Move the selection marker with button **+** or **-** to the Inst. cluster submenu.
- ▶ Press button **↶** or **↷** repeatedly until you see this message in the left multifunction display: *Select display*.

The selection marker is on the current setting.



- ▶ Press **+** or **-** to select the desired setting.

The selected option appears in the left multifunction display.

The option not selected will appear in the right multifunction display when scrolling through the standard display (▷ page 145).

### Time submenu

Access the Time submenu via the Settings menu. Use the Time submenu to change the time and date settings. The following functions are available:

Function	Page
Synchronizing time with head unit	157
Setting the time (hours)	158
Setting the time (minutes)	158

### Synchronizing time with head unit

- ▶ Move the selection marker with the **+** or **-** button to the Time submenu.
- ▶ Press button **↶** or **↷** repeatedly until the message *Time synchron. with head unit* appears in the multifunction display.

The selection marker is on the current setting.

### Control system



- ▶ Press **+** or **-** enable or disable this feature.

When you set this feature to On, the time displayed in the multifunction display is automatically synchronized with the time of the COMAND system.

**i** For information on setting the time, refer to the separate COMAND operating instructions.

#### Setting the time (hour)

This function is only available if the function Time synchron. with head unit (▷ page 157) has been set to Off. The time is then not set automatically by the COMAND and must be set manually if required.

- ▶ Move the selection marker with the **+** or **-** button to the Time submenu.
- ▶ Press button **▲** or **▼** repeatedly until the message Set time Hour appears in the multifunction display.

The selection marker is on the hour setting.



- ▶ Press button **+** or **-** to set the hour.

#### Setting the time (minutes)

This function is only available if the function Time sync. with head unit (▷ page 157) has been set to Off. The time is then not set automatically by the COMAND and must be set manually if required.

- ▶ Move the selection marker with the **+** or **-** button to the Time submenu.
- ▶ Press button **▲** or **▼** repeatedly until the message Set time Minute(s) appears in the multifunction display.

The selection marker is on the minute setting.

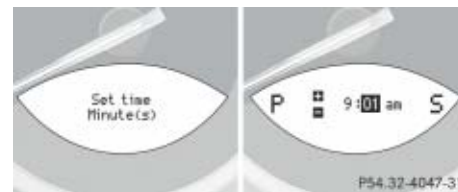

- ▶ Press button **+** or **-** to set the minutes.

### Lighting submenu

Access the Lighting submenu via the Settings menu. Use the Lighting submenu to change the lamp and lighting settings on your vehicle. The following functions are available:

Function	Page
Setting daytime running lamp mode (USA only)	159
Setting locator lighting	160
Setting night security illumination	160
Setting interior lighting delayed switch-off	161

### Setting daytime running lamp mode (USA only)

**i** This function is not available in countries where the daytime running lamp mode is mandatory and therefore in a constant mode.

- ▶ Move the selection marker with button **+** or **-** to the Lighting submenu.
- ▶ Press button **▲** or **▼** repeatedly until the message Light circuit Headlamp mode appears in the multifunction display.

The selection marker is on the current setting.

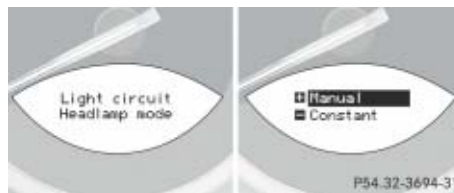

- ▶ Press button **+** or **-** to select manual operation (Manual) or daytime running lamp mode (Constant).

With daytime running lamp mode activated and the exterior lamp switch at position **0** or **AUTO** the low beam headlamps are switched on when the engine is running.

In low ambient light conditions the following lamps will switch on additionally:

- Parking lamps
- Tail lamps
- License plate lamps
- Side marker lamps

**i** For safety reasons, resetting to factory settings (▷ page 153) while driving will not deactivate the daytime running lamp mode.

The following message appears in the multifunction display: Cannot be fully reset to factory settings when driving.



### Control system

#### Setting locator lighting

With the locator lighting feature activated and the exterior lamp switch in position **AUTO**, the following lamps will switch on during darkness when the vehicle is unlocked with the SmartKey:

- Parking lamps
- Tail lamps
- License plate lamps
- Front fog lamps
- Side marker lamps

The locator lighting switches off when the driver's door is opened.

If you do not open a door after unlocking the vehicle with the SmartKey, the lamps will switch off automatically after approximately 40 seconds.

▶ Move the selection marker with button **+** or **-** to the Lighting sub-menu.

▶ Press button **▲** or **▼** repeatedly until the message *Locator lighting* appears in the multifunction display.

The selection marker is on the current setting.



▶ Press button **+** or **-** to switch the locator lighting feature to *On*.

▶ Turn the exterior lamp switch to position **AUTO** when exiting the vehicle.

The locator lighting feature is activated.

#### Setting night security illumination (Exterior lamps delayed switch-off feature)

Use this function to set whether you would like the exterior lamps to remain on for 15 seconds during darkness after exiting the vehicle and closing the doors.

With the delayed switch-off feature activated and the exterior lamp switch in position **AUTO** before the engine is turned off, the following lamps will switch on when the engine is turned off:

- Parking lamps
- Tail lamps
- License plate lamps
- Side marker lamps
- Front fog lamps

If after turning off the engine you do not open a door or do not close an opened door, the lamps will switch off automatically after 60 seconds.

- ▶ Move the selection marker with button **+** or **-** to the Lighting sub-menu.
- ▶ Press button **▲** or **▼** repeatedly until the message **Headlamps delayed switch-off** appears in the multifunction display.

The selection marker is on the current setting.



- ▶ Press button **+** or **-** to switch the delayed switch-off feature **On** or **Off**.
- ▶ Turn the exterior lamp switch to position **AUTO** before turning off the engine. The delayed switch-off feature is activated.

You can temporarily deactivate the delayed switch-off feature:

- ▶ Before exiting the vehicle turn the SmartKey in the starter switch to position **0**.
- ▶ Then turn it to position **2** and back to **0**.

The delayed switch-off feature is deactivated. It will reactivate as soon as you reinsert the SmartKey in the starter switch.

### **Setting interior lighting delayed switch-off**

Use this function to set whether you would like the interior lighting to remain on for 10 seconds during darkness after you have removed the SmartKey from the starter switch.

- ▶ Move the selection marker with button **+** or **-** to the Lighting sub-menu.
- ▶ Press button **▲** or **▼** repeatedly until the message **Int. lighting delayed switch-off** appears in the multifunction display.

The selection marker is on the current setting.



### Control system

- ▶ Press **+** or **-** to switch the interior lighting delayed switch-off feature On or Off.

#### Vehicle submenu



Access the Vehicle submenu via the Settings menu. Use the Vehicle submenu to make general vehicle settings. The following functions are available:

Function	Page
Setting automatic locking	162

#### Setting automatic locking

Use this function to activate or deactivate the automatic central locking. With the automatic central locking system activated, the vehicle is centrally locked at a vehicle speed of approximately 9 mph (15 km/h).

- ▶ Move the selection marker with the **+** or **-** button to the Vehicle submenu.

- ▶ Press button  or  repeatedly until you see this message in the left multifunction display: Automatic door lock.

The selection marker is on the current setting.



- ▶ Press **+** or **-** to switch Automatic door lock On or Off.

#### Convenience submenu

Access the Convenience submenu via the Settings menu. Use the Convenience submenu to change the settings for a number of convenience features. The following functions are available:

Function	Page
Activating easy-entry/exit feature	162

#### Activating easy-entry/exit feature

Use this function to activate and deactivate the easy-entry/exit feature (▷ page 46).

### Warning!



You must make sure no one can become trapped or injured by the moving steering wheel when the easy-entry/exit feature is activated.

To stop steering wheel adjustment, do one of the following:

- Move steering column stalk (> page 45).
- Press the memory button (> page 126).

Do not leave children unattended in the vehicle, or with access to an unlocked vehicle. Children could open the driver's door and unintentionally activate the easy-entry/exit feature, which could result in an accident and/or serious personal injury.

- ▶ Move the selection marker with the **+** or **-** button to the Convenience submenu.
  - ▶ Press button **▲** or **▼** repeatedly until you see **Activate Easy-entry feature** in the multifunction display.
- The selection marker is on the current setting.



- ▶ Press **+** or **-** to switch the easy-entry/exit feature On or Off.

### Trip computer menu





Use the trip computer menu to call up statistical data on your vehicle. The following information is available:

Function	Page
Fuel consumption statistics after start	164
Fuel consumption statistics since last reset	164
Distance to empty	165

**i** The last function called up will reappear the next time you enter the trip computer menu.

## Control system

### Fuel consumption statistics after start

- ▶ Press button  or  repeatedly until you see the first function of the trip computer menu.
- ▶ Press button  or  repeatedly until you see this message in the left multifunction display: From start.

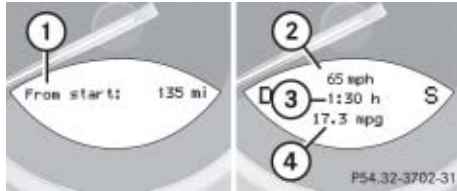





- ① Distance driven since start
- ② Average speed since start
- ③ Time elapsed since start
- ④ Average fuel consumption since start

**i** All statistics stored since the last engine start will be reset approximately 4 hours after the SmartKey in the starter switch is turned to position **0** or removed from the starter switch.

Resetting will not occur if you turn the SmartKey back to position **1** or **2** within this time period.



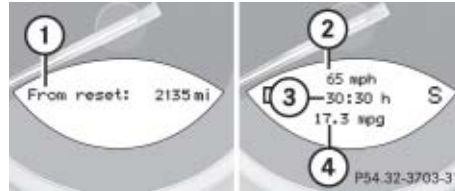

### Fuel consumption since last reset

- ▶ Press button  or  repeatedly until you see the first function of the trip computer menu.
- ▶ Press button  or  repeatedly until you see this message in the left multifunction display: From reset.



- ① Distance driven since last reset
- ② Average speed since last reset
- ③ Time elapsed since last reset
- ④ Average fuel consumption since last reset





### Resetting fuel consumption statistics

- ▶ Press button  or  repeatedly until you see the first function of the trip computer menu.
- ▶ Press button  or  repeatedly until you see the reading that you want to reset in the left multifunction display.
- ▶ Press and hold the reset button in the instrument cluster (▷ page 27) until the value is reset to 0.

**i** The fuel consumption statistics reset automatically to 0 when either of the following values is exceeded:

- distance covered: 100000 miles
- time elapsed: 10000 hours

### Distance to empty

- ▶ Press button  or  repeatedly until you see the first function of the trip computer menu.
- ▶ Press button  or  repeatedly until you see this message in the left multifunction display: Range.

In the right multifunction display you will see the calculated range based on the current fuel tank level.

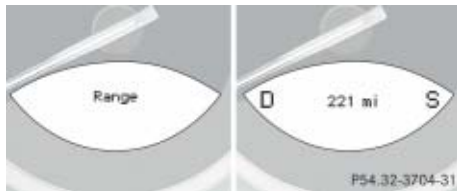

 If only very little fuel is left in the tank, a vehicle at the fuel pump is shown instead of the range.

### TEL menu\*

#### Warning!





A driver's attention to the road must always be his/her primary focus when driving. For your safety and the safety of others, we recommend that you pull over to a safe location and stop before placing or taking a telephone call. If you choose to use the telephone while driving, please use the hands-free device and only use the telephone when weather, road, and traffic conditions permit.

Some jurisdictions prohibit the driver from using a cellular telephone while driving a vehicle.

Bear in mind that at a speed of just 30 mph (approximately 50 km/h), your vehicle is covering a distance of 44 feet (approximately 14 m) every second.

Never operate radio transmitters equipped with a built-in or attached antenna (i.e. without being connected to an external antenna) from inside the vehicle while the engine is running. Doing so could lead to a malfunction of the vehicle's electronic system, possibly resulting in an accident and/or personal injury.

You can use the functions in the TEL menu to operate your telephone, provided it is connected to a hands-free system and switched on.

- ▶ Switch on the telephone and COMAND.
- ▶ Press button  or  on the steering wheel repeatedly until you see the TEL menu in the left multifunction display.

### Control system

Which messages will appear in the right multifunction display depends on whether your telephone is switched on or off:

- If the telephone is off, the message in the multifunction display is: TEL off.
- If the telephone is on:

The telephone will then search for a network. During this time the right multifunction display is empty.

As soon as the telephone has found a network, READY is indicated in the right multifunction display.

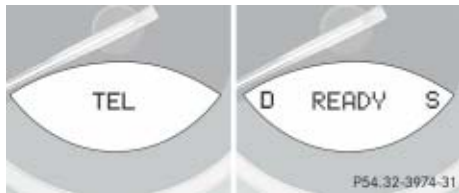

- This standby message indicates that your telephone is ready for use and you can operate it using the control system.

### Answering a call

When your telephone is ready to receive calls, you can answer a call at any time. In the right multifunction display you will then see the message:

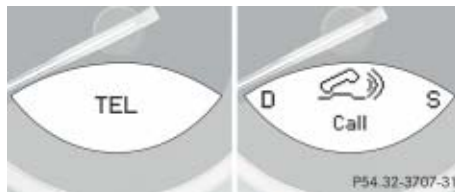

- ▶ Press button .

You have answered the call. In the right multifunction display you see the duration of the call.

**i** If you do not wish to accept a call, press button .



### Ending a call

- ▶ Press button .



You have ended the call. In the right multifunction display you will again see the standby message.

### Dialing a number from the phone book

If your telephone is ready to receive calls, you may select and dial a number from the phone book at any time.



- ▶ Press button  or  repeatedly until you see the TEL menu in the left multifunction display.

In the right multifunction display you will see the standby message.



- ▶ Press button  or .

The control system reads the phone book which is stored in the telephone. This may take several minutes. In the right multifunction display you will see the message `Please wait!`.

When the message `Please wait!` disappears, the phone book has been loaded.

- ▶ Press button  or  repeatedly until the desired name appears in the right multifunction display.

The stored names are displayed in ascending or descending alphabetical order.

**i** *If you press and hold  or  for longer than one second, the system scrolls rapidly through the list of names until you release the button again.*

*Cancel the quick search mode by pressing .*

- ▶ Press button .

The system dials the selected phone number.

- If the connection is successful and this feature is supported by your network provider, the name of the party you are calling (if stored in your phone book) and the duration of the call will appear in the display.

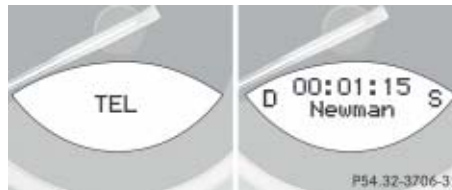

- If no connection is made, the control system stores the dialed number in the redial memory.

## Redialing



The control system stores the most recently dialed phone numbers. This eliminates the need to search through your entire phone book.

- ▶ Press button  or  repeatedly until you see the TEL menu in the left multifunction display.

In the right multifunction display you will see the standby message.

- ▶ Press button .

In the right multifunction display you see the first number in the redial memory.

- ▶ Press button  or  repeatedly until the desired name appears in the right multifunction display.

- ▶ Press button .

The control system dials the selected phone number.



### Automatic transmission

For more information on driving with an automatic transmission, see “Automatic transmission” (▷ page 52).

Your vehicle’s transmission adapts its gear shifting process to your individual driving style by continually adjusting the shift points up or down. These shift point adjustments are performed based on current operating and driving conditions.

If the operating conditions change, the automatic transmission reacts by adjusting its shift program.

**i** *During the brief warm-up, transmission upshifting is delayed. This allows the catalytic converter to heat up more quickly to operating temperature.*

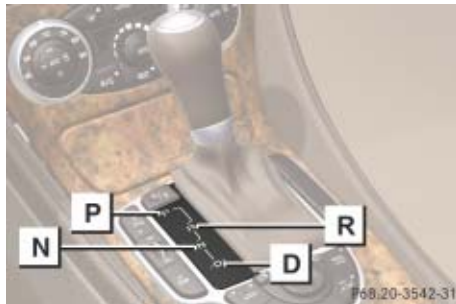

**Gearshift pattern for automatic transmission**

The automatic transmission selects individual gears automatically, depending on:

- the gear selector lever position **D** (▷ page 170) with gear ranges (▷ page 172)
- the selected program mode: **(C/S)** (▷ page 173)  
or  
**(MANUAL/C/S)** (SL 55 AMG and SL 65 AMG only) (▷ page 177)
- the position of the accelerator pedal (▷ page 171)
- the vehicle speed



- ① Current gear range/gear selector lever position
- ② Current program mode

The current gear range/gear selector lever position and program mode (C/S) or (M/C/S) appear in the right multifunction display.

### Warning!



It is dangerous to shift the gear selector lever out of **P** or **N** if the engine speed is higher than idle speed. If your foot is not firmly on the brake pedal, the vehicle could accelerate quickly forward or reverse. You could lose control of the vehicle and hit someone or something. Only shift into gear when the engine is idling normally and when your right foot is firmly on the brake pedal.

**!** Allow engine to warm up under low load use. Do not place full load on the engine until the operating temperature has been reached.

Shift into reverse gear **R** or parking position **P** only when the vehicle is stopped.

Avoid spinning of a drive wheel for an extended period when driving off on slippery road surfaces. This may cause serious damage to the drivetrain which is not covered by the Mercedes-Benz Limited Warranty.

When the gear selector lever is in position **D**, you can influence transmission shifting by:

- limiting the gear range
- changing gears manually

### Automatic transmission

#### Gear selector lever position

	Effect
<b>P</b>	<b>Park position</b> Gear selector lever position when the vehicle is parked. Place gear selector lever in position <b>P</b> only when vehicle is stopped. The park position is not intended to serve as a brake when the vehicle is parked. Rather, the driver should always set the parking brake in addition to placing the gear selector lever in position <b>P</b> to secure the vehicle.

	Effect
	The SmartKey can only be removed from the starter switch with the gear selector lever in position <b>P</b> . With the SmartKey removed, the gear selector lever is locked in position <b>P</b> .
<b>R</b>	<b>Reverse gear</b> Place gear selector lever in position <b>R</b> only when vehicle is stopped.

	Effect
<b>N</b>	<b>Neutral</b> No power is transmitted from the engine to the drive axle. When the brakes are released, the vehicle can be moved freely (pushed or towed).  To avoid damage to the transmission, never engage <b>N</b> while driving.  If the ESP® is deactivated or malfunctioning: Move gear selector lever to <b>N</b> only if the vehicle is in danger of skidding, e.g. on icy roads.
<b>D</b>	<b>Drive</b> The transmission shifts automatically. All forward gears are available.

**!** Coasting the vehicle, or driving for any other reason with gear selector lever in **N** can result in transmission damage that is not covered by the Mercedes-Benz Limited Warranty.

**Warning!**

Getting out of your vehicle with the gear selector lever not fully engaged in position **P** is dangerous. Also, position **P** alone is not intended to or capable of preventing your vehicle from moving, possibly hitting people or objects.

Always set the parking brake in addition to shifting to position **P** (▷ page 61).

When parked on an incline, turn the front wheels towards the road curb.

Do not park this vehicle in areas where combustible materials such as grass, hay or leaves can come into contact with the hot exhaust system, as these materials could be ignited and cause a vehicle fire.

**Warning!**

When leaving the vehicle, always remove the SmartKey or SmartKey with KEYLESS-GO\* from the starter switch, take it with you, and lock the vehicle. Do not leave children unattended in the vehicle, or with access to an unlocked vehicle. Children could move the gear selector lever from position **P**, which could result in an accident and/or serious personal injury.

**Driving tips****Accelerator position**

Your driving style influences the transmission's shifting behavior:

Less throttle	Earlier upshifting
More throttle	Later upshifting

**Kickdown**

Use kickdown when you want maximum acceleration.

- ▶ Press the accelerator past the point of resistance.  
The transmission shifts into the lowest possible gear.
- ▶ Ease on the accelerator when you have reached the desired speed.  
The transmission shifts up again.

### Automatic transmission

#### Stopping

When you stop briefly, e.g. at traffic lights:

- ▶ Leave the transmission in gear.
- ▶ Hold the vehicle with the brake.

When you stop longer with the engine idling and/or on a hill:

- ▶ Set the parking brake.
- ▶ Move the gear selector lever to position **P**.

#### Maneuvering

When you maneuver in tight areas, e.g. when pulling into a parking space:

- ▶ Control the vehicle speed by gradually releasing the brakes.
- ▶ Accelerate gently.
- ▶ Never abruptly step on the accelerator.

#### Working on the vehicle

##### Warning!



When working on the vehicle, set the parking brake and move gear selector lever to position **P**. Otherwise the vehicle could roll away.

#### Gear ranges

With the gear selector lever in position **D** and driving in the automatic shift program **C** or **S** (▷ page 173), you can select a gear range for the automatic transmission to operate within:

Gear selector lever (▷ page 174):

You can limit the gear range by pressing the gear selector lever to the left (**D-**), and reverse the gear range limit by pressing the gear selector lever to the right (**D+**).

Steering wheel gearshift control\* (▷ page 175):

You can limit the gear range by pulling the left gearshift paddle on the steering wheel gearshift control, and reverse the gear range limit by pulling the right gearshift paddle on the steering wheel gearshift control.

The selected gear range appears in the right multifunction display (▷ page 169). If you press on the accelerator when the engine has reached its rpm limit, the transmission will upshift beyond any gear range limit selected.

	Effect
<b>6</b>	The transmission shifts through sixth gear only (applies to vehicles with 7-speed automatic transmission only).
<b>5</b>	The transmission shifts through fifth gear only (applies to vehicles with 7-speed automatic transmission only).
<b>4</b>	The transmission shifts through fourth gear only.

	Effect
<b>3</b>	The transmission shifts through third gear only.  With this selection you can use the braking effect of the engine.
<b>2</b>	The transmission shifts through second gear only.  Allows the use of engine's braking power when driving: <ul style="list-style-type: none"> <li>• on steep downgrades</li> <li>• in mountainous regions</li> <li>• under extreme operating conditions</li> </ul>
<b>1</b>	The transmission operates in first gear only.  For maximum use of engine's braking effect on very steep or lengthy downgrades.

### Automatic shift program

The program mode selector switch is located on the lower part of the center console.



① Program mode selector switch

**C** Comfort      For comfort driving

**S** Sport          For standard driving

The current gear selector lever position and the selected program mode (C/S) are indicated in the right multifunction display (▷ page 169).

### Automatic transmission

**!** *Never change the program mode when the gear selector lever is out of position **P**. This could result in a change of driving characteristics for which you may not be prepared.*

**i** *The last selected program mode (**C** or **S**) is switched on when the engine is restarted.*

- ▶ Press program mode selector switch ① repeatedly until the letter of the desired program mode appears in the right multifunction display.

Select **C** for comfort driving:

- The vehicle starts out in second gear (both forward and reverse) for gentler starts. This does not apply if full throttle is applied or gear range **1** is selected.
- Traction and driving stability are improved on icy roads.
- Upshifts occur earlier even when you give more gas. The engine then operates at lower rpms and the wheels are less likely to spin.

### Gear selector lever one-touch gearshifting

Even with an automatic transmission, you can change the gears manually and limit or extend the gear range for automatic shifting with the gear selector lever in position **D** and driving in the automatic program mode **C** or **S**.

**!** *Allow engine to warm up under low load use. Do not place full load on the engine until the operating temperature has been reached.*

*Shift into reverse gear **R** or parking position **P** only when the vehicle is stopped.*

*Avoid spinning of a drive wheel for an extended period when driving off on slippery road surfaces. This may cause serious damage to the drivetrain which is not covered by the Mercedes-Benz Limited Warranty.*

### Downshifting

#### Warning!



On slippery road surfaces, never downshift in order to obtain braking action. This could result in drive wheel slip and reduced vehicle control. Your vehicle's ABS will not prevent this type of loss of control.

- ▶ Briefly press the gear selector lever to the left in the **D-** direction.

The transmission will shift from the current gear to the next lower gear as permitted by the shift program. This action simultaneously limits the gear range of the transmission (▷ page 172).

**i** *To avoid overrevving the engine when the gear selector lever is moved to the **D-** direction, the transmission will not shift to a lower gear if the engine's max. speed would be exceeded.*

### Upshifting

- ▶ Briefly press the gear selector lever to the right in the **D+** direction.

The transmission will shift from the current gear to the next higher gear as permitted by the shift program. This action simultaneously extends the gear range of the transmission.

### Canceling gear range limit

- ▶ Press and hold the gear selector lever in the **D+** direction until **D** reappears in the right multifunction display.

The transmission will shift from the current gear range directly to gear range **D**.

### Shifting into optimal gear range

- ▶ Press and hold the gear selector lever in the **D-** direction.

The transmission will automatically select the gear range suited for optimal acceleration and deceleration. This may involve shifting down one or more gears.

### Steering wheel gearshift control one-touch gearshifting\*

Steering wheel gearshift control is available on vehicles with Sport Package\*, on SL 55 AMG, and on SL 65 AMG only.

The steering wheel gearshift control provides an alternative method for changing the gears manually and limiting or extending the gear range for automatic shifting with the gear selector lever in position **D** and driving in the automatic program mode **C** or **S**.

**i** For information on using the steering wheel gearshift control in program mode **MANUAL** (SL 55 AMG and SL 65 AMG only), see "Manual shift program" (▷ page 177).

**i** To avoid overrevving the engine when downshifting with the steering wheel gearshift paddle, the transmission will not shift to a lower gear if the engine's max. speed would be exceeded.

**!** Allow engine to warm up under low load use. Do not place full load on the engine until the operating temperature has been reached.

Shift into reverse gear **R** or parking position **P** only when the vehicle is stopped.

Avoid spinning of a drive wheel for an extended period when driving off on slippery road surfaces. This may cause serious damage to the drivetrain which is not covered by the Mercedes-Benz Limited Warranty.

The gearshift paddles are located to the left and right of the steering wheel.

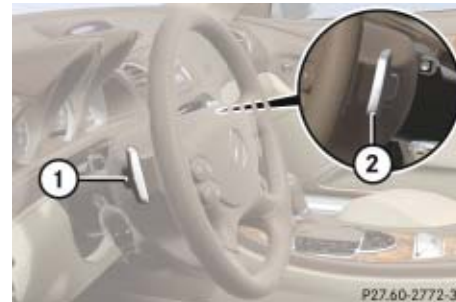

- ① Left shift paddle: downshift
- ② Right shift paddle: upshift



### Automatic transmission

**i** You cannot shift with the steering wheel gearshift paddle when the gear selector lever is in position **P**, **N** or **R**.

The last selected program mode (**C** or **S**) is switched on when the engine is restarted.

The following instructions describe operation of the steering wheel gearshift control when driving in the automatic program mode **C** or **S**.

For instructions on operating the steering wheel gearshift control and gear selector lever in the program mode **MANUAL**, see “Manual shift program (SL 55 AMG and SL 65 AMG only)” (▷ page 177).

#### Downshifting

##### Warning!



On slippery road surfaces, never downshift in order to obtain braking action. This could result in drive wheel slip and reduced vehicle control. Your vehicle's ABS will not prevent this type of loss of control.

- ▶ Briefly pull left shift paddle ① (▷ page 175).

The transmission will shift to the next lower gear as permitted by the shift program. This action simultaneously limits the gear range of the transmission (▷ page 172).

#### Upshifting

- ▶ Briefly pull right shift paddle ② (▷ page 175).

The transmission will shift to the next higher gear as permitted by the shift program. This action simultaneously extends the gear range of the transmission (▷ page 172).

#### Canceling gear range limit

- ▶ Pull and hold right shift paddle ② (▷ page 175) until **D** reappears in the right multifunction display.

The transmission will shift from the current gear range directly to gear range **D**.

#### Shifting into optimal gear range

- ▶ Pull and hold left shift paddle ① (▷ page 175).

The transmission will automatically select the gear range suited for optimal acceleration and deceleration. This will involve shifting down one or more gears.

### Manual shift program (SL 55 AMG and SL 65 AMG only)

In addition to the automatic shift program **C** or **S**, your vehicle is equipped with the manual shift program **MANUAL**.

In the **MANUAL** program mode, system-controlled automatic gearshifting is switched off and you need to change the gears by manually upshifting or downshifting using the steering wheel gearshift paddles (▷ page 175) or the gear selector lever.

**!** Allow engine to warm up under low load use. Do not place full load on the engine until the operating temperature has been reached.

Shift into reverse gear **R** or parking position **P** only when the vehicle is stopped.

Avoid spinning of a drive wheel for an extended period when driving off on slippery road surfaces. This may cause serious damage to the drivetrain which is not covered by the Mercedes-Benz Limited Warranty.

The program mode selector switch is located on the lower part of the center console.



#### Example illustration SL 65 AMG

① Program mode selector switch

<b>MANUAL</b>	For manual gear shifting
<b>C</b> Comfort	For comfort driving
<b>S</b> Sport	For standard driving

The current gear selector lever position and the selected program mode (M/C/S) are indicated in the right multifunction display (▷ page 169).

**i** For information on automatic program modes **C** or **S**, see “Automatic shift program” (▷ page 173), “Gear selector lever one-touch gearshifting” (▷ page 174), and “Steering wheel gearshift control one-touch gearshifting” (▷ page 175).

### Automatic transmission

#### Activating manual shift program

- ▶ Press program mode selector switch ① repeatedly until the M for **MANUAL** program mode appears in the right multifunction display.

The transmission switches to the **MANUAL** program mode. Automatic shifting is switched off. The gear range is not limited.

You can change the gears manually when the gear selector lever is in position **D**. You can upshift or downshift through the gears in succession.

**i** The **MANUAL** program mode will not be stored. When the engine is turned off with the **MANUAL** program mode selected, the transmission will go to the automatic program mode (**C** or **S**) when the engine is restarted.

#### Upshifting

**!** In the **MANUAL** program mode, the transmission will not upshift, even if the engine has reached its overrevving range. Shift up to the next gear before the engine has reached its overrevving range. Make absolutely certain that the engine speed does not reach the red marking on the tachometer (▷ page 26). Otherwise the engine could be damaged which is not covered by the Mercedes-Benz Limited Warranty.

- ▶ Briefly press the gear selector lever to the right in the **D+** direction.

or

- ▶ Briefly pull right shift paddle ② (▷ page 175).

The transmission shifts to the next higher gear.

If, instead of the manual program mode symbol M, the symbol  appears in the right multifunction display (▷ page 169), shift to the next higher gear. The fuel supply will otherwise be interrupted to prevent the engine from overrevving.

**i** If you have selected the AMG menu in the control system and the engine reaches the over-speed range in the manual shift program, the color of the display will switch to red and **UP** appears after the gear indicator, advising you to upshift.

## Downshifting

### Warning!



On slippery road surfaces, never downshift in order to obtain braking action. This could result in drive wheel slip and reduced vehicle control. Your vehicle's ABS will not prevent this type of loss of control.

- ▶ Briefly press the gear selector lever to the left in the **D**- direction.

or

- ▶ Briefly pull left shift paddle ① (▷ page 175).

The transmission shifts to the next lower gear.

**i** When you brake or stop, the transmission shifts down to a gear from which you can easily accelerate or take off.

## Kickdown

Using the kickdown when driving in the **MANUAL** program mode is not possible.

### Deactivating manual shift program

- ▶ Press the program mode selector switch (▷ page 177) repeatedly until **C** or **S** appears in the right multifunction display.

or

- ▶ Restart the engine.

The transmission will go to the automatic program mode (**C** or **S**).

The **MANUAL** program mode is not stored.

## Emergency operation (Limp-Home Mode)

If vehicle acceleration becomes less responsive or sluggish or the transmission no longer shifts, the transmission is most likely operating in limp-home (emergency operation) mode. In this mode only second gear and reverse gear can be activated.

- ▶ Stop the vehicle in a safe location.
- ▶ Move gear selector lever to **P**.
- ▶ Turn off the engine.
- ▶ Wait at least 10 seconds before restarting.
- ▶ Restart the engine.
- ▶ Move gear selector lever to drive position **D** (for second gear) or reverse gear **R**.
- ▶ Have the transmission checked at an authorized Mercedes-Benz Center as soon as possible.

### Good visibility

For information on windshield wiper operation, see “Windshield wipers” (▷ page 57).

#### Headlamp cleaning system

The button is located on the left side of the dashboard.



① Headlamp washer button

▶ Switch on the ignition (▷ page 39).

▶ Press button ①.

The headlamps are cleaned with a high-pressure water jet.

**i** *The headlamps will automatically be cleaned when you have*

- *switched on the headlamps and*
- *operated the windshield wipers with windshield washer fluid fifteen times*

*When you switch off the ignition, the counter resets.*

For information on filling up the washer fluid reservoir, see “Windshield washer system and headlamp cleaning system” (▷ page 282).

#### Rear view mirrors

For information on setting the rear view mirrors, see “Mirrors” (▷ page 47).

#### Auto-dimming rear view mirrors

The reflection brightness of the exterior rear view mirror on the driver's side and the interior rear view mirror will respond automatically to glare when

- the ignition is switched on and
- incoming light from headlamps falls on the sensor in the interior rear view mirror.

The interior rear view mirror will not react if

- reverse gear is engaged
- the interior lighting is switched on

**Warning!**

The auto-dimming function does not react if incoming light is not aimed directly at sensors in the interior rear view mirror.

The interior rear view mirror and the exterior rear view mirror on the driver's side do not react, for example, if the wind screen is installed.

Light hitting the mirror(s) at certain angles (incident light) could blind you. As a result, you may not be able to observe traffic conditions and could cause an accident.

**Warning!**

In case of an accident liquid electrolyte may escape from the mirror housing if the mirror glass breaks.

Electrolyte has an irritating effect. Do not allow the liquid to come into contact with eyes, skin, clothing, or respiratory system. In case it does, immediately flush affected area with water, and seek medical help if necessary.

**Warning!**

Exercise care when using the passenger-side exterior rear view mirror. The mirror surface is convex (outwardly curved surface for a wider field of view). Objects in mirror are closer than they appear. Check your interior rear view mirror or glance over your shoulder before changing lanes.

**!** *Electrolyte drops coming into contact with the vehicle paint finish can be completely removed only while in the liquid state by applying plenty of water.*

## Good visibility

### Sun visors

The sun visors protect you from sun glare while driving.

#### Warning!



Do not use the driver's-side vanity mirror while driving.

Keep the vanity mirrors in the sun visors closed while vehicle is in motion. Reflected glare can endanger you and others.

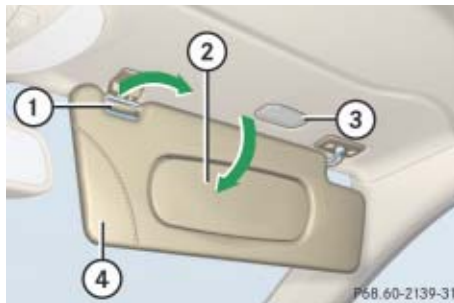

- ① Mounting
- ② Vanity mirror cover
- ③ Vanity mirror lamp
- ④ Holder for gas cards

### Glare through the windshield

- ▶ Make sure the sun visor is properly engaged in mounting ①.
- ▶ Swing the respective sun visor down.
- ▶ When you do not experience glare anymore, swing the sun visor up.

### Glare through a door window

- ▶ Swing respective sun visor down.
- ▶ Disengage the sun visor from mounting ①.

**i** When the sun visor is disengaged from mounting ①, vanity mirror lamp ③ switches off.

- ▶ Pivot the sun visor to the side.

**!** To avoid damage to vanity mirror cover ②, make sure it is closed before pivoting the sun visor to the side.

### Vanity mirror

- ▶ Swing respective sun visor down.
- ▶ Flip up vanity mirror cover ② to access the vanity mirror.  
Vanity mirror lamp ③ comes on.
- ▶ After using the vanity mirror, flip down vanity mirror cover ②.
- ▶ Swing the sun visor up.

## Rear window defroster

The rear window defroster uses a large amount of power. To keep the battery drain to a minimum, switch off the defroster as soon as the rear window is clear. The defroster is automatically deactivated after approximately 6 to 17 minutes of operation depending on the outside temperature.

### Warning!



Any accumulation of snow and ice should be removed from the rear window before driving. Visibility could otherwise be impaired, endangering you and others.

- ▶ Switch on the ignition (▷ page 39).

## Activating

- ▶ Press button  on the automatic climate control panel (▷ page 185).

The indicator lamp on the button comes on.

## Deactivating

- ▶ Press button  (▷ page 185) once more.

The indicator lamp on the button goes out.

**!** *The rear window defroster cannot be switched on when the retractable hardtop is open. The indicator lamp will start flashing if the hardtop is open.*

- Close the retractable hardtop.

*The rear window defroster can then be switched on.*

**!** *If the rear window defroster switches off too soon and the indicator lamp starts flashing, too many electrical consumers are operating simultaneously and there is insufficient voltage in the battery. The system responds automatically by switching the rear window defroster off.*

*As soon as the battery has sufficient voltage, the rear window defroster automatically switches back on automatically.*



### Automatic climate control

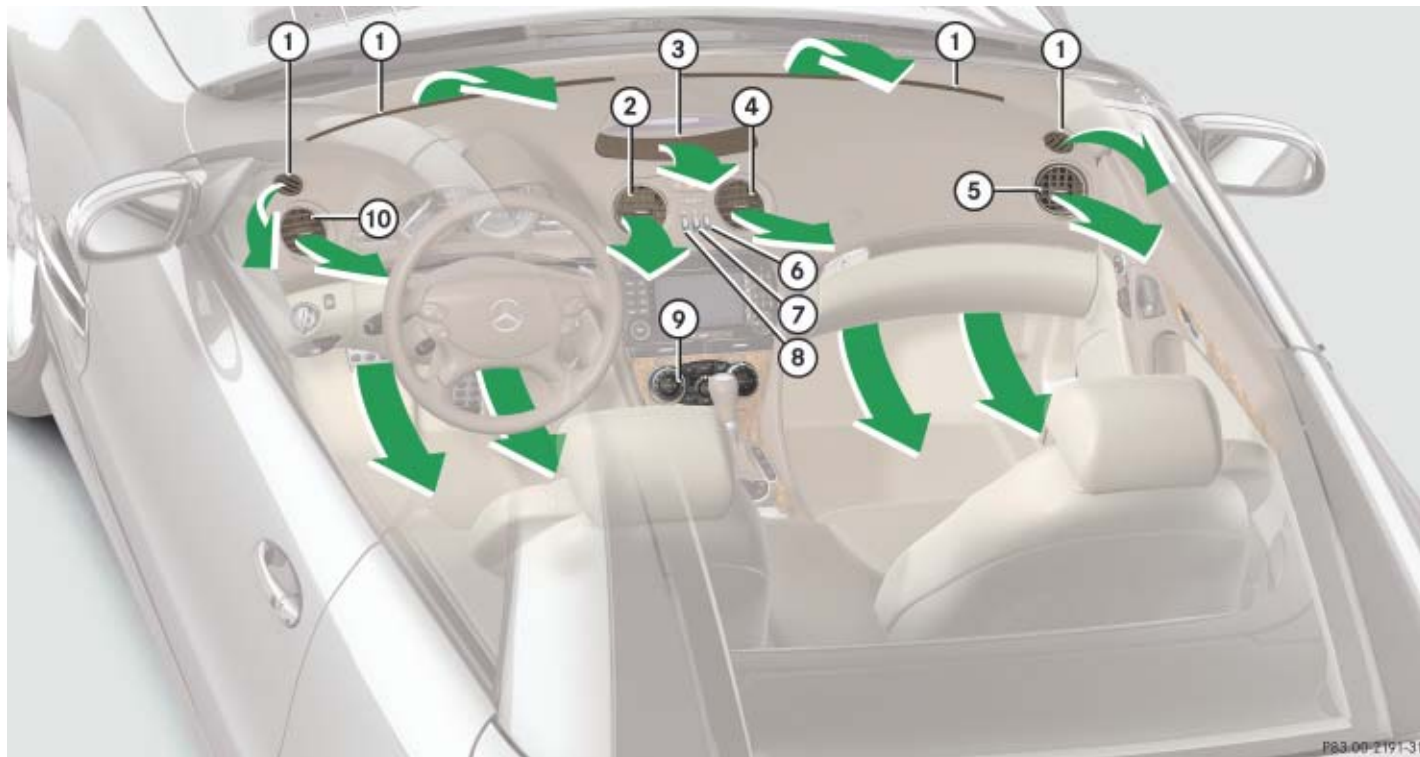

## Automatic climate control

Item
① Defroster air vents, fixed
② Left center air vent, adjustable
③ Cockpit air vent, fixed
④ Right center air vent, adjustable
⑤ Right side air vent, adjustable
⑥ Air volume control for right side air vent
⑦ Air volume control for center air vents
⑧ Air volume control for left side air vent
⑨ Automatic climate control panel
⑩ Left side air vent, adjustable



Automatic climate control panel

Item
① Air distribution, left
② Front defroster
③ Air recirculation
④ Rear window defroster
⑤ Air distribution, right
⑥ Temperature control, right
⑦ Automatic climate control on/off (entire system)
⑧ Residual heat/ventilation
⑨ Air volume control
⑩ AC cooling on/off
⑪ Temperature control, left

**i** For draft-free ventilation, move the sliders for center air vent and side air vents to the middle position.

### Automatic climate control

The automatic climate control is operational whenever the engine is running. You can operate the automatic climate control system in either the automatic or manual mode. The system cools or heats the interior depending on the selected interior temperature and the current outside temperature.

#### Warning!



When operating the automatic climate control, the air that enters the passenger compartment through the air vents can be very hot or very cold (depending on the set temperature). This may cause burns or frostbite on unprotected skin in the immediate area of the air vents. Always keep sufficient distance between unprotected parts of the body and the air vents. If necessary, use the air distribution control (▷ page 185) to direct the air to air vents in the vehicle interior that are not in the immediate area of unprotected skin.

Nearly all dust particles, pollutants and odors are filtered out before outside air enters the passenger compartment through the air distribution system.

The air conditioning will not engage (no cooling) if the **A/C** mode is deactivated (▷ page 193).

#### Warning!



Follow the recommended settings for heating and cooling given on the following pages. Otherwise the windows could fog up, impairing visibility and endangering you and others.

**i** *Severe conditions (e.g. strong air pollution) may require replacement of the filter before its scheduled interval. A clogged filter will reduce the air volume to the interior.*

*If the vehicle interior is hot, ventilate the interior before driving off. The automatic climate control will then adjust the interior temperature to the set value much faster.*

*Keep the air intake grille in front of the windshield free of snow and debris.*

*When the retractable hardtop is closed, do not obstruct air flow by placing objects on the air flow-through exhaust slots below the rear window.*

## Deactivating the automatic climate control system

### Deactivating

- ▶ Press button **OFF** (▷ page 185).  
The indicator lamp on the button comes on.

### Warning!



When the automatic climate control system is switched off, the outside air supply and circulation are also switched off. Only choose this setting for a short time when the retractable hardtop is closed. Otherwise the windows could fog up, impairing visibility and endangering you and others.

### Reactivating

- ▶ Press button **OFF** (▷ page 185).  
The indicator lamp on the button goes out.  
The previous settings are in effect again.
- or
- ▶ Turn one of the temperature controls on the automatic climate control panel (▷ page 185).  
The indicator lamp on button **OFF** goes out.

## Operating the automatic climate control system in automatic mode

Air distribution and air volume can be adjusted automatically by the automatic climate control system. You can also adjust the settings for air distribution and air volume manually.

 *When operating the automatic climate control system in automatic mode, you will only rarely need to adjust the temperature, air volume and air distribution.*

*In automatic mode, cooling with dehumidify is switched on. This function can be switched off if necessary (▷ page 185).*

### Automatic climate control

#### Air distribution in automatic mode

You can separately adjust the air distribution for each side of the passenger compartment.

#### Activating

- ▶ Press control button ① or ⑤ (▷ page 185).

The control button is engaged.

The **AUTO** symbol on the control button comes on. Air distribution for the respective side of the passenger compartment is adjusted automatically.

#### Deactivating

- ▶ Press control button ① or ⑤ (▷ page 185) once more.

The control button sticks up slightly.

The **AUTO** symbol on the control button goes out. Automatic air distribution for the respective side of the passenger compartment is switched off. Adjust the air distribution manually (▷ page 189).

#### Air volume in automatic mode

The air volume settings are the same for the entire passenger compartment.

#### Activating

- ▶ Press control button ⑨ (▷ page 185).

The control button is engaged.

The **AUTO** symbol on the control button comes on.

#### Deactivating

- ▶ Press control button ⑨ (▷ page 185) once more.

The control button sticks up slightly.

The **AUTO** symbol on the control button goes out. Adjust the air volume manually (▷ page 190).

#### Setting the temperature

Use temperature controls ⑥ and ⑪ (▷ page 185) to separately adjust the air temperature on each side of the passenger compartment. You should raise or lower the temperature setting in small increments, preferably starting at 72°F (22°C). The automatic climate control will adjust to the set temperature as fast as possible.

#### Increasing

- ▶ Turn temperature control ⑥ and/or ⑪ (▷ page 185) slightly clockwise.

The automatic climate control system will correspondingly adjust the interior air temperature.





#### Decreasing

- ▶ Turn temperature control ⑥ and/or ⑪ (▷ page 185) slightly counterclockwise.

The automatic climate control system will correspondingly adjust the interior air temperature.

### Adjusting air distribution

Use air distribution controls ① and ⑤ (▷ page 185) to separately adjust the air distribution on each side of the passenger compartment. The following symbols are found on the controls:

Symbol	Function
	Directs air through the center and side air vents
	Directs air to the windows
	Directs air into the entire vehicle interior
	Directs air to the footwells

- ▶ Press control button ① or ⑤ (▷ page 185) until the control button sticks up slightly and the **AUTO** symbol on the control button is out.

Automatic air distribution for the respective side of the passenger compartment is switched off.

- ▶ Turn control button to the desired symbol.

The air distribution is adjusted according to the chosen setting.

- i** You can also turn the air distribution control to a position between two symbols.

### Opening the center air vents

- ▶ Turn thumbwheel ⑦ (▷ page 184) upward to the first stop.

Center air vents ② and ④ (▷ page 184) are open.

### Opening the cockpit air vent and center air vents

- ▶ Turn thumbwheel ⑦ (▷ page 184) upward all the way.

Cockpit air vent ③ and center air vents ② and ④ (▷ page 184) are open.

### Closing the cockpit air vent and center air vents

- ▶ Turn thumbwheel ⑦ (▷ page 184) downward.

Cockpit air vent ③ and center air vents ② and ④ (▷ page 184) are closed.

### Opening the side air vents

- ▶ Turn thumbwheel ⑥ and ⑧ (▷ page 184) upward.

The corresponding side air vent is open.

### Closing the side air vents

- ▶ Turn thumbwheel ⑥ and ⑧ (▷ page 184) upward.

The corresponding side air vent is closed.

- i** The air vents are continuously variable.

### Automatic climate control

#### Adjusting air volume

Use air volume control ⑨ (▷ page 185) for both automatic (▷ page 187) and manual air volume adjustment. Nine blower speeds are available.

- ▶ Press control button ⑨ (▷ page 185).

The control button sticks up slightly. The **AUTO** symbol on the control button goes out. Automatic air volume control is switched off. The air volume is adjusted corresponding to the set blower speed.

#### Maximum cooling MAXCOOL

If the left and right air distribution controls as well as the airflow volume control are set to **AUTO** and there is a high need for cooling, MAXCOOL is activated.

“MAX COOL” appears on the temperature controls ⑥ and ⑪ (▷ page 185).

This provides the fastest possible cooling of the vehicle interior (when retractable hardtop is closed).



Automatic climate control panel with MAXCOOL activated

#### Front defroster

You can use this setting to defrost the windshield, for example if it is iced up. You can also defog the windshield and the side windows.

**i** *Keep this setting selected only until the windshield or the side windows are clear again.*

## Activating

- ▶ Press button  (▷ page 185).

The indicator lamp on the button comes on.

The air conditioning switches to the following functions automatically:

- cooling on to dehumidify
- maximum blower speed and heating power
- air flows onto the windshield and the front side windows
- the air recirculation mode is switched off

## Deactivating

- ▶ Press button  (▷ page 185).

The indicator lamp on the button goes out. Defrosting is turned off.

The previous settings are in effect again.



 *The cooling remains switched on.*

## Windshield fogged on the outside

 *Keep this setting selected only until the windshield is clear again.*

- ▶ Switch the windshield wipers on (▷ page 57).

If the automatic air distribution and air volume are switched off:

- ▶ Turn air distribution controls ① and ⑤ (▷ page 185) to position  or .

or

- ▶ Press control buttons ①, ⑤ and ⑨ (▷ page 185).

The control buttons are engaged. The **AUTO** symbol on the control buttons come on. Air distribution and air volume are adjusted automatically.

## Air recirculation mode

Switch to air recirculation mode to prevent unpleasant odors from entering the vehicle from the outside. This setting cuts off the intake of outside air and recirculates the air in the passenger compartment.

### Warning!



Fogged windows impair visibility, endangering you and others. If the windows begin to fog on the inside, switching off the air recirculation mode immediately should clear interior window fogging. If interior window fogging persists, make sure the air conditioning (▷ page 193) is activated, or press button .



### Automatic climate control

#### Activating

- ▶ Briefly press button  (▷ page 185).

The indicator lamp on the button comes on.

 *The air recirculation mode is activated automatically*

- at high outside temperatures
- if the concentration of carbon monoxide (CO) and/or nitrogen oxide (NO<sub>x</sub>) in the outside air increases, for example in a tunnel

The indicator lamp on button  is not lit when the air recirculation mode is automatically switched on.

A quantity of outside air is added after approximately 30 minutes.

#### Deactivating

- ▶ Briefly press button  (▷ page 185).

The indicator lamp on the button goes out.

 *The manually selected air recirculation mode is deactivated automatically*

- after 5 minutes if the outside temperature is below approximately 41 °F (5 °C)
- after 5 minutes if the air conditioning is turned off
- after 30 minutes if the outside temperature is above approximately 41 °F (5 °C)

At outside temperatures above 79 °F (26 °C) the system will not automatically switch back to outside air.

#### Air recirculation mode with convenience closing or opening feature

##### Warning!



Never operate the windows if there is the possibility of anyone being harmed by the closing procedure.

In the event that the procedure causes potential danger, the closing of the windows can be immediately halted by releasing the  button or by pressing and pulling the respective window switch.

#### Activating



- ▶ Press and hold button .

The indicator lamp on the button comes on. The air recirculation mode is activated. The windows will close.

### Deactivating

- ▶ Press and hold button .

The indicator lamp on the button goes out. The air recirculation mode is deactivated. The windows will return to their previous position.

 *A window will only return to its previous position if it has not moved to another position using the respective window switch after it was closed with button .*

### Air conditioning

The air conditioning (cooling) function is operational when the engine is running and cools the vehicle interior down to the selected temperature. In addition, the cooling function dehumidifies the air in the vehicle interior, thus preventing the windows from fogging up.

 *Condensation may drip out from underneath the vehicle. This is normal and not an indication of a malfunction.*

#### Warning!



If you turn off the cooling function, the vehicle will not be cooled when weather conditions are warm. The windows can fog up more quickly. Window fogging may impair visibility and endanger you and others.

### Deactivating

It is possible to deactivate the cooling function of the automatic climate control system. The air in the vehicle will then no longer be cooled or dehumidified.

- ▶ Press button  (▷ page 185).

The indicator lamp on the button goes out. The cooling function switches off after a short delay.

### Automatic climate control

#### Activating

Moist air can fog up the windows. You can dehumidify the air with the air conditioning.

- ▶ Press button **A/C** once more (▷ page 185).

The indicator lamp on the button comes on.

The air conditioning uses the refrigerant R134A. This refrigerant is free of CFCs which are harmful to the ozone layer.

**!** *If the **A/C** button on the automatic climate control panel starts to flash, this indicates that the air conditioning is losing refrigerant. The compressor has turned off. The air conditioning cannot be turned on again.*

- *Have the air conditioning checked at the nearest authorized Mercedes-Benz Center.*

#### Residual heat and ventilation

With the engine switched off, it is possible to continue to heat or ventilate the interior for up to 30 minutes. This feature makes use of the residual heat produced by the engine.

**i** *How long the system will provide heating depends on the coolant temperature and the selected temperature. The blower will run at low speed regardless of the air distribution control setting.*

#### Activating

With the SmartKey:

- ▶ Turn the SmartKey in the starter switch to position **1** or **0**, or remove it from the starter switch.
- ▶ Press button **REST** (▷ page 185).

The indicator lamp on the button comes on.

With KEYLESS-GO\*:

- ▶ Turn off the engine by pressing the KEYLESS-GO\* start/stop button and open the driver's door (with the driver's door open, the starter switch is in position **0**, same as with the SmartKey removed from the starter switch)
- ▶ Press button **REST** (▷ page 185).

The indicator lamp on the button comes on.

### Deactivating

- ▶ Press button **REST** (▷ page 185).

The indicator lamp on the button goes out.

The residual heat is automatically turned off:

- when the ignition is switched on
- after about 30 minutes
- if the battery voltage drops

### Ventilated glove box

The glove box has its own air vents that allow for cooling ventilation when the automatic climate control system is activated.

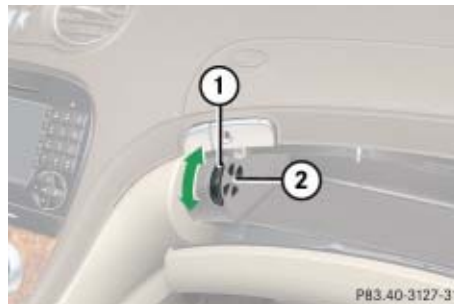

#### Glove box

- ① Thumbwheel
- ② Air vent

**i** You should keep air vent ② closed when outside temperatures are low.

### Opening the air vent

- ▶ Make sure the air vent in the glove box is unobstructed.
- ▶ Turn thumbwheel ① upwards.

### Closing the air vent

- ▶ Turn thumbwheel ① downwards.

### Power windows

#### Opening and closing the windows

The windows are opened and closed electrically. The switches for all the windows are on the driver's door. The switch for the passenger side windows is on the passenger door.



- ① Left door and rear side windows
- ② Right door and rear side windows

#### Warning!





When closing the windows, make sure that there is no danger of anyone being injured by the closing procedure.

The closing of the door windows can be immediately halted by releasing the switch or, if the switch was pulled past the resistance point and released, by either pressing or pulling the respective switch.

The closing of the rear side windows can be immediately halted by releasing the switch.

If a door window encounters an obstruction that blocks its path in a circumstance where you pulled the switch past the resistance point and released it to close the door window, the automatic reversal function will stop the door window and open it slightly.

If the door window encounters an obstruction that blocks its path in a circumstance where you are closing the door window by pulling and holding the switch, by pressing and holding button  on the SmartKey, by pressing and holding the lock button (vehicles with KEYLESS-GO\*) on an outside door handle, by pressing and holding the retractable hardtop switch, or by pressing and

holding button  on the climate control panel, the automatic reversal function will not operate.

When leaving the vehicle, always remove the SmartKey or the SmartKey with KEYLESS-GO\* from the starter switch, take it with you, and lock the vehicle. Do not leave children unattended in the vehicle, or with access to an unlocked vehicle. Unsupervised use of vehicle equipment can cause an accident and/or serious personal injury.

**i** Depending on the current position, the windows may also open or close when the air recirculation button  on the control panel of the automatic climate control (▷ page 191) is pressed and held.

**i** After switching off the ignition (▷ page 39) or removing the SmartKey from the starter switch, the windows can be operated

- until you open a door
  - for at least 5 minutes if no door was opened
- ▶ Switch on the ignition (▷ page 39).

### Opening the door windows

- ▶ Press switch ① or ② to the resistance point.

The corresponding door window will move downwards until you release the switch.

 *If the hardtop is open, the respective rear side window will also open automatically.*

### Opening the rear side windows when the hardtop is closed:

- ▶ Open the door window.
- ▶ Press switch ① or ② to the resistance point again.

The corresponding rear side window will open completely.

### Closing the door windows

- ▶ Pull switch ① or ② to the resistance point.

The corresponding door window will move upwards until you release the switch.

#### Warning!



If you pull and hold the switch up when closing the door window, and upward movement of the door window is blocked by some obstruction including but not limited to arms, hands, fingers, etc., the automatic reversal will not operate.

### Closing the rear side windows if the hardtop is closed:

- ▶ Close the door window.
- ▶ Pull and hold switch ① or ②.

The corresponding rear side window will move upwards until you release the switch.

### Fully opening the door windows (Express-open)

- ▶ Press switch ① or ② past the resistance point and release.

The corresponding door window opens completely.

 *If the hardtop is open, the respective rear side window will also open automatically.*

### Power windows

#### Fully closing the door windows (Express-close)

- ▶ Pull switch ① or ② past the resistance point and release.

The corresponding door window closes completely.

If the upward movement of the door window is blocked during the closing procedure, the door window will stop and open slightly.

#### Warning!



Driver's door only:

If within 5 seconds the switch is again pulled past the resistance point and released, the automatic reversal will not operate.

#### Stopping windows

- ▶ Press or pull the respective switch again.

#### Closing the windows with KEYLESS-GO\*

- ▶ Press and hold lock button on an outside door handle (▷ page 64) until the windows are closed.

#### Warning!



When closing the windows make sure that there is no danger of anyone being harmed by the closing procedure.

The windows will not automatically re-open if blocked during convenience closing.

If potential danger exists, proceed as follows:

- Release the lock button.
- Pull on the door handle and hold firmly. The side windows open for as long as the door handle is held but the door not opened.

#### Synchronizing power windows

The power window must be synchronized each time

- after the battery has been disconnected
- if the power windows cannot be fully opened (Express-open) or closed (Express-close)

#### Synchronizing the power windows

- ▶ Switch on the ignition (▷ page 39).
- ▶ Pull the power window switches until the side windows are closed.

Hold the switches for approximately 1 second.

The power windows are synchronized.

## ▼ Retractable hardtop

### Opening and closing the retractable hardtop

For safety reasons, the retractable hardtop can only be opened and closed when the vehicle is standing still.

#### Warning!



To prevent possible accidents, only drive the vehicle with the retractable hardtop either completely closed and locked, or fully lowered into its storage compartment.

If the retractable hardtop does not completely open or close, the roof hydraulics will lose pressure and the retractable hardtop is lowered

- after approximately 7 minutes when the ignition is switched on
- after approximately 15 seconds when the ignition is switched off

Shortly before the retractable hardtop is lowered, a warning will sound and in the left multifunction display you will see , in the right multifunction display you will see the message *being lowered*.

Lock the retractable hardtop again before driving any further (▷ page 202). Otherwise, the unlocked hardtop could open while the vehicle is in motion and cause you to lose control of the vehicle. You or others could be injured as a result.

#### Warning!



Before operating the retractable hardtop switch, make sure there is no danger of anyone being injured by the moving parts (retractable roof, roof frame, and trunk lid) due to inattention.

Hands must never be placed near the roof frame, upper windshield area, hardtop, shelf behind roll bars, or trunk lid while the retractable hardtop is being raised or lowered. Serious personal injury may occur.

If potential danger exists, release the retractable hardtop switch. This immediately interrupts the raising or lowering procedure. You then can operate the retractable hardtop switch to raise or lower the retractable hardtop away from the danger zone.



### Retractable hardtop

#### Warning!



When leaving the vehicle, always remove the SmartKey or the SmartKey with KEYLESS-GO\* from the starter switch, take it with you, and lock the vehicle. Do not leave children unattended in the vehicle, or with access to an unlocked vehicle. Unsupervised use of vehicle equipment can cause an accident and/or serious personal injury.

**!** Never sit or place heavy objects on the rear shelf. Doing so could cause damage to the retractable hardtop and the rear shelf.

**!** When opening and closing the retractable roof, make sure

- *there is sufficient clearance for the retractable hardtop to move up and for the trunk lid to move back*
- *the luggage cover is installed, extended and closed*
- *the trunk is loaded only to the height of the luggage cover*
- *luggage/cargo does not push up the closed luggage cover*
- *the trunk lid is closed*
- *the outside temperature is above +5°F (-15°C)*
- *the roof is dry and clean when opening*

*Otherwise the retractable hardtop and trunk as well as other parts of the vehicle could be damaged.*

### Opening/closing with retractable hardtop switch

#### Warning!



Before operating the retractable hardtop, make sure there is no danger of anyone being injured by the moving parts (retractable roof, roof frame, and trunk lid) due to inattention.

Hands must never be placed near the roof frame, upper windshield area, hardtop, shelf behind roll bars, or trunk lid while the retractable hardtop is being raised or lowered. Serious personal injury may occur.

If potential danger exists, release retractable hardtop switch immediately. This immediately interrupts the raising or lowering procedure.

The retractable hardtop switch is located on the lower part of the center console.



### Retractable hardtop switch

- ① Opening
- ② Closing

- ▶ Engage the parking brake (▷ page 54).
- ▶ Close the luggage cover, see “Luggage cover” (▷ page 205).
- ▶ Close the trunk lid.
- ▶ Switch on the ignition (▷ page 39).

### Opening

**i** Make sure the retractable hardtop is dry before you open it. Otherwise water may enter the trunk interior.

- ▶ Pull up on the retractable hardtop switch as indicated by arrow ① until the retractable hardtop is completely lowered into its trunk storage compartment.

The multifunction display will briefly show the message  in operation.

### Closing

- ▶ Press down on the retractable hardtop switch as indicated by arrow ② until the retractable hardtop is completely closed and locked.

The multifunction display will briefly show the message  in operation.



### Opening/closing with the SmartKey

#### Warning!



Before operating the retractable hardtop, make sure there is no danger of anyone being injured by the moving parts (retractable roof, roof frame, and trunk lid) due to inattention.

Hands must never be placed near the roof frame, upper windshield area, hardtop, shelf behind roll bars, or trunk lid while the retractable hardtop is being raised or lowered. Serious personal injury may occur.

If potential danger exists, release the respective button on the SmartKey. This immediately interrupts the raising or lowering procedure. You then can press button  or  to raise or lower the hardtop away from the danger zone.

### Retractable hardtop



- ▶ Engage the parking brake (▷ page 54).
- ▶ Close the luggage cover, see “Luggage cover” (▷ page 205).
- ▶ Close the trunk lid.

#### **Opening (Summer opening feature)**

**i** Make sure the retractable hardtop is dry before you open it. Otherwise water may enter the trunk interior.

- ▶ Aim the transmitter eye at an outside door handle.

The SmartKey must be in close proximity to the outside door handle.

- ▶ Press and hold button  until the retractable hardtop is completely open.

The seat ventilation\* for the driver's seat switches on. The rear side windows open.

- ▶ Release button  to interrupt procedure.

#### **Closing (Convenience feature)**

- ▶ Aim the transmitter eye at the outside door handle.

The SmartKey must be in close proximity to the outside door handle.

- ▶ Press and hold button  until the retractable hardtop is completely closed.



The retractable hardtop and the rear side windows close.

#### **Locking the retractable hardtop after raising/lowering**

##### **Warning!**



The hardtop is not fully closed and locked or not fully opened and locked if:

- the message  in operation appears in the multifunction display
- a warning sounds for 10 seconds and the message  Lock retractable roof appears in the multifunction display when starting to drive

If the retractable hardtop is not properly locked, lock it as follows.

**Unlocked status noticed when stopped**

- ▶ Switch on the ignition (▷ page 39).
- ▶ To lock the retractable hardtop in its fully closed position, press retractable hardtop switch forward (▷ page 200).

or:

- ▶ To lock the retractable hardtop in its fully opened position, pull up on the retractable hardtop switch (▷ page 200).

**Unlocked status noticed while driving****Warning!**

Stop the vehicle in a safe location or as soon as it is safe to do so and lock the hardtop before continuing to drive. You could otherwise endanger yourself and others.

- ▶ Stop the vehicle in a safe location or as soon as it is safe to do so.
- ▶ Leave the ignition switched on.
- ▶ To lock the retractable hardtop in its fully closed position, press retractable hardtop switch forward (▷ page 200).

or:

- ▶ To lock the retractable hardtop in its fully opened position, pull up on the retractable hardtop switch (▷ page 200).

**Problems when operating the retractable hardtop**

Several conditions may cause the retractable hardtop to not open, close, or lock properly:

- The luggage cover in the trunk is not closed.
  - ▶ Close the luggage cover in the trunk.
- The trunk lid is open.
  - ▶ Close the trunk lid.
- The battery voltage is too low.
  - ▶ Start engine and let run while opening/closing the retractable hardtop.

### Retractable hardtop

- The hardtop drive system has shut itself down. For safety reasons, no more than five consecutive attempts may be made to raise or lower the hardtop.
  - ▶ After about 10 minutes you may again attempt to open or close the retractable hardtop.
  - ▶ If the retractable hardtop still does not open, close, or lock properly, have the retractable hardtop system checked at an authorized Mercedes-Benz Center.
- There is a malfunction in the retractable hardtop system.
  - ▶ Notify an authorized Mercedes-Benz Center.

### Wind screen

#### Warning!



The wind screen can restrict the driver's vision to the rear of the vehicle. To prevent a possible accident when visibility is limited (e.g. in darkness), the upper part of the wind screen should be folded back.

The wind screen deflects drafts away from the driver and passenger when the retractable hardtop is lowered. It is stored in the trunk.

#### Installing

- ▶ Leave the wind screen folded and place it on the roll bar.



#### ① Guide tabs

- ▶ Slide the wind screen into the roll bar until guide tabs ① on each side latch underneath the roll bar.

Make sure the fastening straps do not get caught.

- ▶ Adjust the roll bar to a height (> page 81) that allows you to reach easily underneath it.

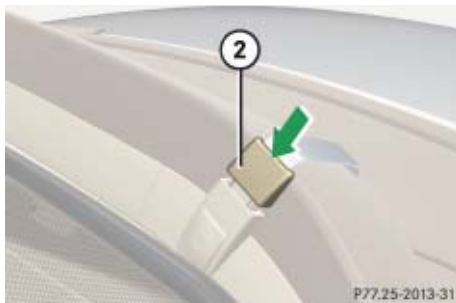

### ② Buckle

- ▶ Guide the fastening straps around the top of the roll bar and close buckles ②.
- ▶ Tighten the fastening straps if necessary.
- ▶ Lower the roll bar (▷ page 81).
- ▶ Fold the upper section of the wind screen up towards the head restraints until it stops.

### Removing

- ▶ Fold the upper section of the wind screen back.
- ▶ Adjust the roll bar to a height (▷ page 81) that allows you to reach easily underneath it.



### ① Release button

- ▶ Undo the buckles on the upper section of the roll bar by pressing release button ①.

- ▶ Lower the roll bar (▷ page 81).  
Make sure the fastening straps do not get caught.
- ▶ Pull the wind screen out towards the front of the vehicle.  
Be careful not to damage interior trim with the guide tabs.
- ▶ Store the wind screen in a safe place.

### Luggage cover

The luggage cover covers luggage/cargo in the trunk.

**!** *To prevent damage to the retractable hardtop or luggage/cargo when lowering:*

- *Load trunk only to the height of the luggage cover.*
- *Do not permit luggage/cargo to push up the closed luggage cover.*
- *Do not load anything on top of or in front of the luggage cover.*
- *Do not place anything on the shelf behind the roll bar.*

### Retractable hardtop

#### Closing luggage cover

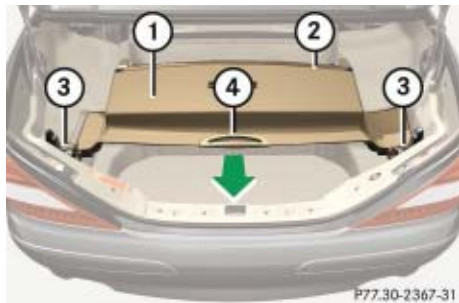

#### Closed luggage cover

- ① Luggage cover
- ② Zipper
- ③ Side holder
- ④ Handle

- ▶ Pull out luggage cover ① in direction of arrow using handle ④.
- ▶ Hook luggage cover ① into left and right side holders ③.

#### Opening luggage cover

- ▶ Unhook luggage cover ① from side holders ③.
- ▶ While holding on to handle ④, guide luggage cover ① in the opposite direction of arrow.

#### Removing luggage cover

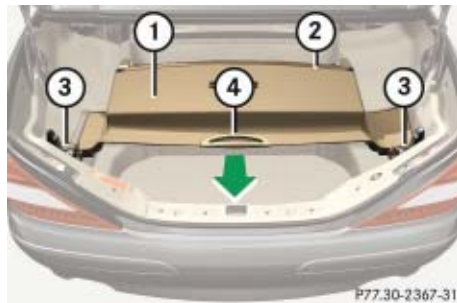

#### Closed luggage cover

- ① Luggage cover
- ② Zipper
- ③ Side holder
- ④ Handle

- ▶ Fold back the entire length of the zipper's cloth cover.

- ▶ Completely open zipper ② while the luggage cover is closed.
- ▶ Open luggage cover ① see "Opening luggage cover" (▷ page 206).

The tensioning clasps are on the left and right sides of the trunk.



#### Opened luggage cover

- ⑤ Tensioning clasp
- ⑥ Retainer spring

### Warning!



Only open the tensioning clasps when the luggage cover opened, see “Opening luggage cover” (▷ page 206).

You could otherwise be injured.

- ▶ Open tensioning clasps ⑤ by pulling them downward.
- ▶ Unhook retainer springs ⑥ from holders and flip retainer springs all the way up.



- ⑦ Luggage cover
- ⑧ Cloth end
- ⑨ Cloth holder

- ▶ Carefully tilt luggage cover ⑦ in direction of arrow towards rear of trunk.
- ▶ Roll up front end of cloth ⑧ in the trunk towards the front and fasten it in place in front of cloth holder ⑨.
- ▶ Completely remove luggage cover ⑦ from the trunk.

### Installing luggage cover

**!** Before installing the luggage cover, make sure that the cloth end is in front of the cloth holder. Otherwise, it could be damaged.

- ▶ Carefully place luggage cover in trunk.

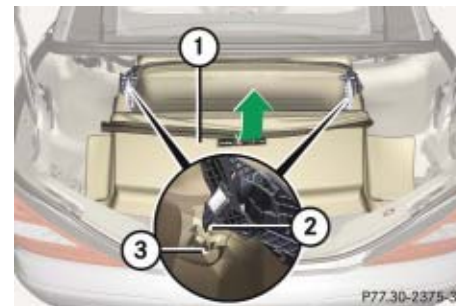

- ① Luggage cover
- ② Hook
- ③ Guide rail

- ▶ Insert luggage cover ① into guide rails ③ on both sides using hooks ②.
- ▶ Tilt luggage cover forward in direction of arrow.





### Retractable hardtop

- ▷▷▶ Fold retainer springs of tensioning clasps downward and clip them into holders on both sides (▷ page 206).
- ▶ Close tensioning clasps on both sides by pressing them upward.
- ▶ Pull handle of luggage cover towards the rear.
- ▶ Clip eyelets onto side trim panels.
- ▶ Close the zipper completely (▷ page 206).
- ▶ Fold back the zipper's cloth cover across the entire length of the luggage cover.

### Sunshade for panorama roof\*

The sunshade protects you from excessive sunlight coming in through the panorama roof.

#### Warning!



Do not operate the sunshade while driving. Adjusting the sunshade while driving could cause the driver to lose control of the vehicle.

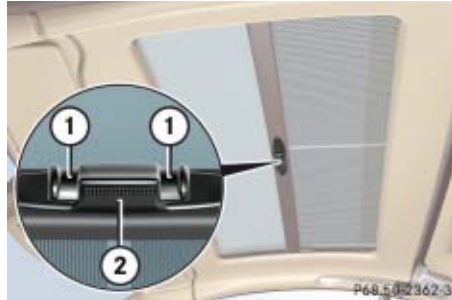

- ① Stop buttons
- ② Handle

### Opening

- ▶ Squeeze stop buttons ① and guide the sunshade towards the rear.

### Closing

- ▶ Using handle ②, slide the sunshade towards the front of the vehicle.

## ▼ Driving systems

The driving systems of your vehicle are described on the following pages:

- Cruise control and DISTRONIC\*, with which the vehicle can maintain a preset speed
- Distance warning function\* (only available with DISTRONIC\*), which warns of stationary objects or slower moving vehicles that you are closing in on too quickly
- ABC with vehicle level control systems, with which you can change vehicle suspension characteristics
- Parktronic\*, which assists the driver during parking maneuvers

For information on the BAS, ABS, ESP®, and the electro-hydraulic brake system, see “Driving safety systems” (▷ page 87).

### Cruise control

The cruise control automatically maintains the speed you set for your vehicle.

The use of the cruise control is recommended for driving at a constant speed for extended periods of time.

You can set or resume the cruise control at any speed above 20 mph (30 km/h).

The cruise control function is operated by means of the cruise control lever.

The cruise control lever is the uppermost lever on the left-hand side of the steering column (▷ page 24).

### Warning!



The cruise control is a convenience system designed to assist the driver during vehicle operation. The driver is and must always remain responsible for the vehicle's speed and for safe brake operation.

Only use the cruise control if the road, traffic, and weather conditions make it advisable to travel at a constant speed.

- The use of the cruise control can be dangerous on winding roads or in heavy traffic because conditions do not allow safe driving at a constant speed.
- The use of the cruise control can be dangerous on slippery roads. Rapid changes in tire traction can result in wheel spin and loss of control.
- Deactivate the cruise control when driving in fog.

The “Resume” function should only be operated if the driver is fully aware of the previously set speed and wishes to resume this particular preset speed.

### Warning!



The cruise control brakes automatically so that the set speed is not exceeded.

Keep in mind that the cruise control is a convenience system designed to assist the driver during vehicle operation. The driver is and must always remain responsible for the vehicle's speed and for safe brake operation.

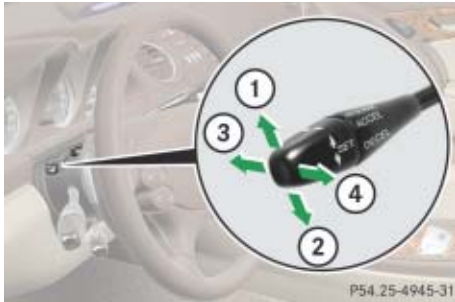

- ① Setting current or higher speed
- ② Setting current or lower speed
- ③ Canceling the cruise control
- ④ Activating the cruise control or resuming to last set speed

### Activating cruise control

You can activate the cruise control when the vehicle speed is above 20 mph (30 km/h).

In the following cases you cannot activate the cruise control:

- when you brake
- when you have set the parking brake
- when the gear selector lever is set to position **P**, **R**, or **N**
- when the ESP<sup>®</sup> is switched off

**i** The vehicle speed displayed in the speedometer can briefly vary from the speed setting for the cruise control system.

### Setting current speed

- ▶ Accelerate or decelerate to the desired speed.
- ▶ Briefly lift the cruise control lever in direction of arrow ① or depress in direction of arrow ②.

The current speed is set.

- ▶ Remove your foot from the accelerator pedal.

The cruise control is activated.

The currently set speed appears in the multifunction display.

**i** On uphill grades, the cruise control may not be able to maintain the set speed. Once the grade eases, the set speed will be resumed.

On downhill grades, the cruise control maintains the set speed by braking with the vehicle's brake system. In addition, on longer downhill grades the automatic transmission will downshift automatically.

### Canceling the cruise control

There are several ways to cancel the cruise control:

- ▶ Step on the brake pedal.

The cruise control is canceled. The last set speed is stored for later use.

or

- ▶ Briefly push the cruise control lever in direction of arrow ③.

The cruise control is canceled. The last set speed is stored for later use.

**i** The last stored speed is canceled when you turn off the engine.

**i** The cruise control switches off automatically when

- you step on the brake pedal
- you depress the parking brake pedal

The cruise control also switches off automatically when

- the vehicle speed is below 20 mph (30 km/h) (▷ page 209)
- the ESP® is in operation or switched off with the ESP® switch (▷ page 91)
- you move the gear selector lever to position **N** while driving

An acoustic warning sounds and the message **CC Off** appears in the multifunction display for approximately 5 seconds.

**!** Moving the gear selector lever to position **N** while driving cancels the cruise control. However, the gear selector lever should not be moved to position **N** while driving except to coast when the vehicle is in danger of skidding (e.g. on icy roads).

**i** Depressing the accelerator pedal does not deactivate the cruise control. After brief acceleration (e.g. for passing), the cruise control will resume the last speed set.

### Driving systems

#### Setting a higher speed

- ▶ Lift the cruise control in direction of arrow ① (▷ page 210) and hold it there until the desired speed is reached.
- ▶ Release the cruise control lever.  
The new speed is set.

#### Setting a lower speed

- ▶ Depress the cruise control in direction of arrow ② (▷ page 210) and hold it there until the desired speed is reached.
- ▶ Release the cruise control lever.  
The new speed is set.

**i** *When you use the cruise control lever to decelerate, the brake system will automatically brake the vehicle if the engine's braking power does not brake the vehicle sufficiently.*

#### Fine adjustment in 1 mph (Canada: 1 km/h) increments

##### **Faster**

- ▶ Briefly tip the cruise control lever in direction of arrow ① (▷ page 210).

##### **Slower**

- ▶ Briefly tip the cruise control lever in direction of arrow ② (▷ page 210).

#### Setting to last stored speed ("Resume" function)

##### **Warning!**



The set speed stored in memory should only be set again if prevailing road conditions permit. Possible acceleration or deceleration differences arising from returning to the preset speed could cause an accident and/or serious injury to you and others.

- ▶ Briefly pull the cruise control lever in direction of arrow ④ (▷ page 210).  
The cruise control resumes to the last set speed or, if no speed is stored, it will set and store the current speed.
- ▶ Remove your foot from the accelerator pedal.  
The selected speed appears in the multifunction display.

## Distronic\*

When activated, the DISTRONIC adaptive cruise control system increases the driving convenience afforded by the cruise control while traveling on expressways and other major roadways.

- If the DISTRONIC distance sensor detects a slower moving vehicle directly ahead, your vehicle's speed will be reduced so that you follow that vehicle at the pre-set following distance.
- If there is no vehicle directly ahead of you, DISTRONIC will function in the same way as standard cruise control (> page 209).

### Warning!



DISTRONIC adaptive cruise control is not a substitute for active driving involvement. It does not react to pedestrians or stationary objects, recognize or predict the lane curvature nor the movement of preceding vehicles.

DISTRONIC can only apply a maximum of 20% of the vehicle's braking power.

It is the driver's responsibility at all times to be attentive to the road, weather and traffic conditions. In addition, the driver must provide the steering, braking and other driving inputs necessary to remain in control of the vehicle.

### Warning!



DISTRONIC is a convenience system. Its speed adjustment reduction capability is intended to make cruise control more effective and usable when traffic speeds vary. It is not however, intended to, nor does it, replace the need for extreme care. The responsibility for the vehicle's speed, distance to the preceding vehicle and, most importantly, brake operation to assure a safe stopping distance, always rests with the driver.

### Warning!



DISTRONIC requires familiarity with its operational characteristics. We strongly recommend that you review the following information carefully before operating the system.

### Warning!



DISTRONIC cannot take street and traffic conditions into account. Only use DISTRONIC if the road, weather and traffic conditions make it advisable to travel at a constant speed.

#### Warning!



Use of Distronic can be dangerous on slippery roads. Rapid changes in tire traction can result in wheel spin and loss of control.

Distronic does not act upon adverse sight distance conditions. Do not use Distronic during conditions of fog, heavy rain, snow or sleet.

#### Warning!



Distronic cannot take weather conditions into account. Switch off Distronic or do not switch it on if:

- roads are slippery or covered with snow or ice  
The wheels could lose traction while braking or accelerating and the vehicle could skid.
- the sensor is dirty or visibility is diminished due to snow, rain or fog for example  
The distance control system functionality could be impaired.

Always pay attention to surrounding traffic conditions even while Distronic is switched on. Otherwise, you may not be able to recognize dangerous situations until it is too late. This could cause an accident in which you and/or others could be injured.

#### Warning!



Close attention to road and traffic conditions is imperative at all times, regardless of whether or not Distronic is activated.

Use of Distronic can be dangerous on winding roads or in heavy traffic because conditions do not allow safe driving at a constant speed.

Distronic will not react to stationary objects on the roadway (e.g. a stopped vehicle in a traffic jam or a disabled vehicle). Distronic will also not respond to oncoming vehicles.

Switch off Distronic:

- when changing from the left to the right lane if vehicles are moving more slowly in the left lane
- when entering a turn lane or highway off ramp
- in complex driving situations, such as in highway construction zones

In these situations, Distronic will continue to maintain the set speed unless deactivated.

Distronic is designed and intended only to maintain a set speed and keep a set distance from moving objects in front of your vehicle.

### Warning!



The “Resume” function should only be operated if the driver is fully aware of the previously set speed and wishes to resume this particular preset speed.

#### **i** USA only:

*This device has been approved by the FCC as a “Vehicle Radar System”. The radar sensor is intended for use in an automotive radar system only. Removal, tampering, or altering of the device will void any warranties, and is not permitted by the FCC. Do not tamper with, alter, or use in any non-approved way.*

*Any unauthorized modification to this device could void the user’s authority to operate the equipment.*

#### **i** Canada only:

*This device complies with RSS-210 of Industry Canada. Operation is subject to the following two conditions:*

- (1) *This device may not cause interference, and*
- (2) *this device must accept any interference received, including interference that may cause undesired operation of the device.*

*Removal, tampering, or altering of the device will void any warranties, and is not permitted by the FCC. Do not tamper with, alter, or use in any non-approved way.*

*Any unauthorized modification to this device could void the user’s authority to operate the equipment.*

### Distronic displays in the speedometer dial



- ① Red distance warning lamp 
- ② Set speed

When Distronic is activated, distance warning lamp ① and the set speed ② appear in the speedometer dial.

**i** *The vehicle speed displayed in the speedometer can briefly vary from the speed setting for the Distronic.*



### Driving systems

If Distronic detects a vehicle directly ahead, the Distronic indicator lamp  in the speedometer dial comes on white.

If Distronic calculates that there is a danger of collision:

- The distance warning lamp  in the speedometer comes on red.
- An intermittent warning sounds.
- ▶ Immediately apply the brake to avoid a collision.

Under no circumstances should the driver await the intermittent warning sound before braking. See the following warning note.

The intermittent warning sound ceases and the red distance warning lamp  goes out when the necessary distance to the vehicle ahead is established again.

#### Warning!



An intermittent warning sounds and the distance warning lamp (red)  in the speedometer dial is illuminated if the Distronic system calculates that the distance to the vehicle ahead and your vehicle's current speed indicate that Distronic will not be capable of slowing the vehicle sufficiently to maintain the preset following distance, which creates a danger of a collision.

Immediately brake the vehicle to increase the distance to the preceding vehicle. The warning sound is intended as a final caution that you have not interceded with your own braking inputs to avoid a potentially dangerous situation. Do not wait for the operation of the warning signal to intercede with your own braking, as that will result in potentially dangerous emergency braking which will not always result in an impact being avoided.

Tailgating increases the risk of an accident.

#### Warning!





Distronic brakes your vehicle with a maximum deceleration of  $6.5 \text{ ft/s}^2$  ( $2 \text{ m/s}^2$ ). This corresponds to about 20% of the maximum deceleration ability of your vehicle.

Distronic brakes the vehicle in an effort to restore the preset distance or to maintain the set speed.

### Distronic menu in the control system

Use the DISTRONIC menu to display the current settings for your DISTRONIC system. The information shown in the multifunction display depends on whether the DISTRONIC system is activated (▷ page 218) or deactivated (▷ page 220).

**i** For information on the distance warning function\*, see "Distance warning function\*" (▷ page 224).

- ▶ Press button  or  repeatedly until you see one of the following displays in the multifunction display.

### Distronic deactivated

When DISTRONIC is deactivated, you will see the standard display in the left multifunction display.

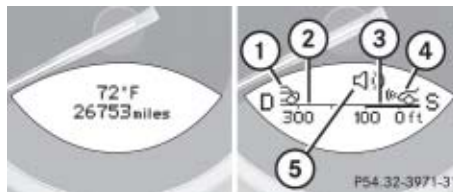

- ① Preceding vehicle, if detected
- ② Actual distance to preceding vehicle
- ③ Preset distance threshold to preceding vehicle
- ④ Your vehicle
- ⑤ Symbol for activated distance warning function

### Distronic activated

When DISTRONIC is activated, the DTR symbol and the set speed appear in the left multifunction display.

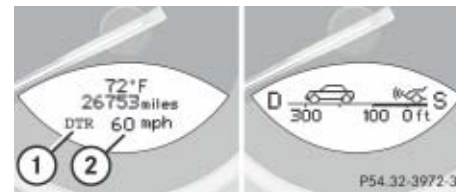

- ① Symbol for activated DISTRONIC
- ② Set speed

### Driving systems

#### Cruise control lever

The Distronic system is operated by means of the cruise control lever.

The cruise control lever is the uppermost lever found on the left-hand side of the steering column.

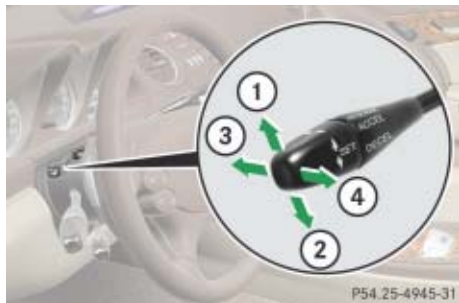

- ① Setting current or higher speed
- ② Setting current or lower speed
- ③ Deactivate Distronic
- ④ Activating Distronic or resuming at last set speed

#### Activating Distronic

You can activate Distronic when the vehicle speed is between 20 mph (30 km/h) and 110 mph (180 km/h).

When Distronic is activated, the left multifunction display will show a message such as DTR 55 mph.

If Distronic is not activated after the cruise control lever is pulled, the left multifunction display will show the message DTR --- mph.

In the following cases you cannot activate Distronic:

- up to 2 minutes after starting the engine
- when you brake
- when you have set the parking brake
- when the gear selector lever is set to position **P**, **R**, or **N**.
- when the ESP® is switched off



- ① White Distronic indicator lamp 
- ② Set speed

**i** The vehicle speed displayed in the speedometer can briefly vary from the speed setting for the Distronic.

### Setting the current speed

- ▶ Accelerate or decelerate to the desired speed.
- ▶ Briefly lift the cruise control lever in direction of arrow ① or depress in direction of arrow ② (▷ page 218).

Distronic is activated and the current speed is set.

- ▶ Remove your foot from the accelerator pedal.

**i** *If you do not take your foot off of the accelerator but continue to accelerate past the set speed, the following message will appear in the multifunction display:*

DTR override.

*The distance to slower moving vehicles in front of you will not be set. Your vehicle speed will then be determined only by the accelerator pedal position.*

### Setting a higher speed

- ▶ Briefly tip the cruise control lever in direction of arrow ① (▷ page 218) to increase the vehicle speed in increments of 5 mph (Canada: 10 km/h).

The new speed is set.

**i** *Depressing the accelerator pedal does not deactivate Distronic. After brief acceleration (e.g. for passing), the cruise control will resume the last speed set.*

### Setting a lower speed

- ▶ Briefly tip the cruise control lever in direction of arrow ② (▷ page 218) to decrease the vehicle speed in increments of 5 mph (Canada: 10 km/h).

The new speed is set.

**i** *When you use the cruise control lever to decelerate, the brakes will be applied to support deceleration.*

*In addition, the transmission will automatically downshift on long downhill grades.*

### Fine adjustment in 1 mph (Canada: 1 km/h) increments

#### **Faster**

- ▶ Briefly pull the cruise control lever in direction of arrow ④ (▷ page 218).

### Driving systems

#### Setting to last stored speed ("Resume" function)

##### Warning!



The set speed stored in memory should only be set again if prevailing road conditions permit. Possible acceleration or deceleration differences arising from returning to the preset speed could cause an accident and/or serious injury to you and others.

- ▶ Briefly pull the cruise control lever in direction of arrow ④ (▷ page 218).

Distronic resumes the last stored speed or, if no speed is stored, it will set and store the current speed.

- ▶ Remove your foot from the accelerator pedal.

#### Deactivating Distronic

There are several ways to deactivate the Distronic system:

- ▶ Step on the brake pedal.

or

- ▶ Briefly push the cruise control lever in direction of arrow ③ (▷ page 218).

Distronic will be deactivated. The last set speed will be stored into memory.

The following message appears in the multifunction display for approximately 5 seconds: DTR off

**i** *The last stored set speed is deleted when the engine is turned off.*

**i** *Distronic deactivates automatically when*

- *you depress the parking brake pedal*
- *the vehicle speed is below 20 mph (30 km/h) (▷ page 218)*
- *the ESP<sup>®</sup> is in operation or switched off with the ESP<sup>®</sup> switch (▷ page 91)*
- *you move the gear selector lever into position **N***

*An acoustic warning sounds and the message DTR off appears in the multifunction display for approximately 5 seconds.*

##### Warning!



Distronic switches off and releases the brakes when the vehicle decelerates below the minimum speed of 20 mph (30 km/h) by operation of the system. At that time the driver must apply the brakes in order to reduce vehicle speed further or bring it to a stop.

**!** Moving the gear selector lever to position **N** while driving cancels the Distronic. However, the gear selector lever should not be moved to position **N** while driving except to coast when the vehicle is in danger of skidding (e.g. on icy roads).

**i** Depressing the accelerator pedal does not deactivate the Distronic. After brief acceleration (e.g. for passing), the Distronic will resume the last speed set.

### Setting the following distance in Distronic

You can set the specified following distance for Distronic by varying the time setting between 1.0 and 2.0 seconds. Using this time setting and the current speed of your vehicle, Distronic calculates and sets the required following distance to the preceding vehicle. The set distance will appear in the right multifunction display (> page 217).

The distance setting thumbwheel for the time setting is located on the lower section of the center console.

### Warning!



It is up to the driver to exercise discretion to select the appropriate setting given road conditions, traffic, driver's preferred driving style and applicable laws and driving recommendations for safe following distance.



① Thumbwheel for setting following distance

### Increasing distance

Increasing the distance setting tells Distronic to maintain a greater following distance to the preceding vehicle.

- ▶ Turn thumbwheel ① towards .

### Decreasing distance

Decreasing the distance setting tells Distronic to maintain a shorter following distance to the preceding ahead.

- ▶ Turn thumbwheel ① towards .

### Driving systems

#### Driving with Distronic

This section describes a number of driving situations where special precaution is required on the part of the driver. Be prepared to brake in such situations. This will deactivate the Distronic system.

#### Warning!



Distronic works to maintain the speed selected by the driver unless a moving obstacle proceeding directly ahead of it in the same travel direction is detected (e.g. following another vehicle ahead of you at your set distance. This means that:

- Your vehicle can pass another vehicle after you have changed lanes.
- While in a sharp turn or if the preceding vehicle is in a sharp turn, Distronic could lose sight of the preceding vehicle. Your vehicle could then accelerate to the previously set speed.

Distronic regulates only the distance between your vehicle and those directly ahead of it, but does not register stationary objects in the road, e.g.:

- a stopped vehicle in a traffic jam
- a disabled vehicle
- an oncoming vehicle

The driver must always be alert, observe all traffic and intercede as required by means of steering or braking the vehicle.

#### Warning!



Distronic should not be used in snowy or icy road conditions.

The most likely cause for a malfunctioning system is a dirty sensor (located behind the hood grille), especially at times of snow and ice or heavy rain. In such a case, Distronic will switch off, and the message *Distronic Currently unavailable*. See *Oper. Manual* appears in the multifunction display.

**i** *If the message Distronic available again appears in the multifunction display during driving, the dirt (e.g. slush) has dissolved. Distronic is available again if you reactivate it (▷ page 218).*

For cleaning and care of the Distronic sensor, see “Cleaning the Distronic\* system sensor cover” (▷ page 325).

### *Turns and bends*

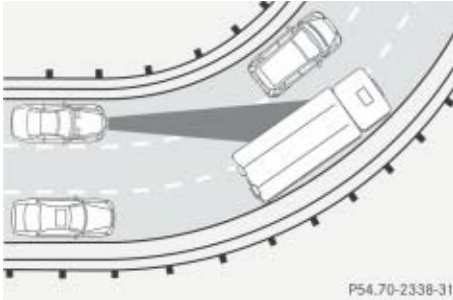

In turns or bends, Distronic may not detect a moving vehicle in front, or it may detect one too soon. This may cause your vehicle to brake late or unexpectedly.

### *Offset driving*

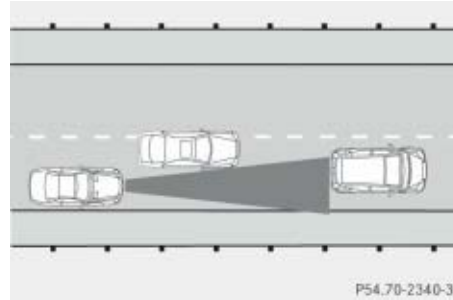

A vehicle traveling in your lane but offset from your direct line of travel may not be detected by Distronic. There will be insufficient distance to the vehicle ahead.

### *Lane changing*

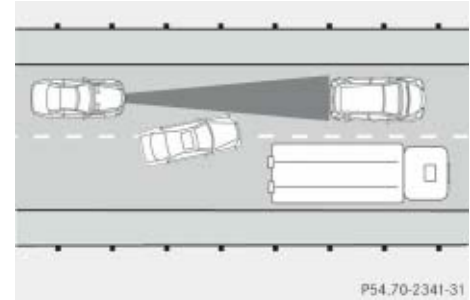

Distronic has not yet detected the vehicle changing lanes. There will be insufficient distance to the lane-changing vehicle.



### Narrow vehicles

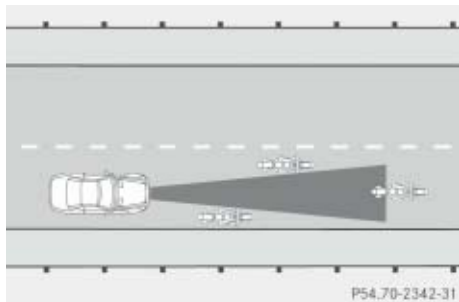

Because of their narrow profile, the vehicles traveling near the outer edges of the lane have not yet been detected by Distronic. There will be insufficient distance to the vehicles ahead.

### Distance warning function\*

When Distronic\* is deactivated, this function will continue to warn you when recognizing a stationary obstacle or a slower vehicle moving in your vehicle's path and the danger of a collision exists:

- The distance warning lamp  in the speedometer comes on red.
- An intermittent warning will sound if necessary.

If these warnings are issued, you must brake manually to maintain a safe distance and avoid a collision with the preceding vehicle.

When depressing the brake pedal, the warning sound ceases. The warning sound will also cease when the distance to the preceding vehicle is sufficient again without applying the brakes. In this case, the distance warning lamp will also go out.

### Warning!



If the distance warning lamp (red)  in the speedometer comes on while driving and/or an intermittent warning sounds, immediate attention on part of the driver is required.

As required by the traffic situation, apply the brakes and navigate around a possible obstacle. However, do not drive by relying on the distance warning function, as this will result in an emergency braking application. This will not always enable you to avoid a collision, especially when traveling on varying road surface conditions and with varying driver reaction.

 *Complex driving situations are not always fully recognized by the distance warning function. This could result in wrong or missing distance warnings.*



① Distance warning function switch

### Activating

- ▶ Press switch ①.

The indicator lamp on the switch comes on. A loudspeaker symbol appears in the right multifunction display (▷ page 217).

### Deactivating

- ▶ Press switch ① once more.

The indicator lamp on the switch goes out. No loudspeaker symbol appears in the right multifunction display.

### Active Body Control (ABC)

The ABC system is an active, computer-controlled system that hydraulically adjusts the suspension at all four wheels in response to various driving situations. It automatically selects the optimum suspension tuning and ride height for your vehicle.

### Vehicle level control

#### Warning!



To help avoid personal injury, keep hands and feet away from wheel housing area, and stay away from under the vehicle when lowering the vehicle chassis.

Your vehicle automatically adjusts its ride height to:

- increase vehicle safety
- reduce fuel consumption

### Driving systems

The vehicle chassis ride height is raised or lowered according to the selected level setting and to the vehicle speed:

- With increasing speed, ride height is reduced by up to approximately 0.5 inch (12 mm).
- With decreasing speed, the ride height is again raised to the selected vehicle level.

**i** *These height adjustments are so small that you may not notice any change.*

The following vehicle level settings can be selected when the vehicle is stationary:

Vehicle level	Use for	Indicator lamps
<b>Normal</b>	For driving on normal roads.	Both lamps off
<b>Level 1</b>	For driving on rough roads or with snow chains (▷ page 318).	One lamp on
<b>Level 2</b>	For driving on very rough road surface conditions.	Both lamps on

Select the level 1 and level 2 settings only when required by current driving conditions. Otherwise:

- Fuel consumption may increase.
- Handling may be impaired.

**i** *The selected vehicle level setting remains stored in memory, even if the engine is turned off and restarted.*

The ABC vehicle level control button with the indicator lamps is located in the lower section of the center console.



- ① Indicator lamp 1
- ② Indicator lamp 2
- ③ ABC vehicle level control button

- ▶ Start the engine (▷ page 52).
- ▶ Briefly press button ③ to change from one level setting to the next.
  - The normal level is selected if both indicator lamps are off.
  - At level 1, indicator lamp ① is on.
  - At level 2, both indicator lamps are on.

When the vehicle is at level 2, pressing the button will return the vehicle to normal level.

**i** Pressing the button twice in quick succession will cause the vehicle to immediately raise or lower to the new vehicle level as selected.

### Suspension tuning

The suspension tuning is set according to:

- Your driving style
- Road surface conditions
- The vehicle loading
- Your choice of suspension style

You can set the following suspension styles:

- Regular (Comfort)
- Sporty

**i** The selected setting is stored, even if the engine is turned off.

The ABC suspension tuning button with the indicator lamp is located in the lower section of the center console.



- ① ABC suspension tuning button
- ② Indicator lamp

▶ Start the engine (▷ page 52).

### Driving systems

#### *Suspension for sporty driving style*

The setting for sporty driving is selected when indicator lamp ② is illuminated.

- ▶ Press button ①.  
Indicator lamp ② comes on.

#### *Suspension for regular driving style*

The setting for regular driving is selected when the indicator lamp ② is off.

- ▶ Press button ①.  
Indicator lamp ② goes out.

#### Parktronic system\* (Parking assist)

##### Warning!



Parktronic is a supplemental system. It is not intended to, nor does it replace, the need for extreme care. The responsibility during parking and other critical maneuvers always rests with the driver.

Special attention must be paid to objects with smooth surfaces or low silhouettes (e.g. trailer couplings, painted posts, or road curbs). Such objects may not be detected by the system and can damage the vehicle.

The operational function of the Parktronic system can be affected by dirty sensors, especially at times of snow and ice. See “Cleaning the Parktronic\* system sensors” (▷ page 326).

##### Warning!



Make sure no persons or animals are in the area in which you are maneuvering. Otherwise you run the risk of causing injury.

**!** *Interference caused by other ultrasonic signals (e.g. working jackhammers, car wash, or the air brakes of trucks) can cause the system to send erratic indications, and should be taken into consideration.*

The Parktronic system is an electronic aid with ultrasonic sensors. It is designed to assist the driver during parking maneuvers. It visually and audibly indicates the relative distance between the vehicle and an obstacle.

The Parktronic system is automatically activated when you switch on the ignition, release the parking brake, or place the gear selector lever in position **D**, **R**, or **N**. The Parktronic system deactivates at speeds exceeding approximately 11 mph (18 km/h). At lower vehicle speeds the Parktronic system turns on again.

The Parktronic system also deactivates when you place the gear selector lever in position **P** or depress the parking brake pedal.

The Parktronic system monitors the surroundings of your vehicle with six sensors in the front bumper and four sensors in the rear bumper.



① Sensors in the front bumper

**i** To function properly, the sensors must be free of dirt, ice, snow and slush. Clean the sensors regularly, being careful not to scratch or damage the sensors, see “Cleaning the Parktronic system \* sensors” (▷ page 326).

### Range of the sensors

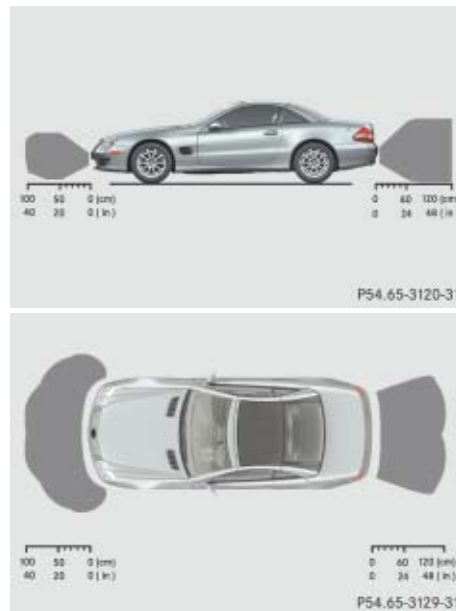

### Front sensors

Center	<b>approx. 40 in (100 cm)</b>
Corners	<b>approx. 24 in (60 cm)</b>

### Rear sensors

Center	<b>approx. 48 in (120 cm)</b>
Corners	<b>approx. 32 in (80 cm)</b>

**!** During parking maneuvers, pay special attention to objects located above or below the height of the sensors (e.g. planters or trailer hitches). The Parktronic system will not detect such objects at close range and damage to your vehicle or the object may result.

Ultrasonic signals from outside sources (e.g. truck air brakes, car wash, or jackhammers) may impair the operation of the Parktronic system.

### Driving systems

#### Minimum distance

Center	<b>approx. 8 in (20 cm)</b>
Corners	<b>approx. 6 in (15 cm)</b>

If the system detects an obstacle in this range, all the distance warning segments illuminate and you hear a warning signal. If the obstacle is closer than the minimum distance, the actual distance may no longer be indicated by the system.

#### Warning indicators

Visual signals indicate to the driver the relative distance between the sensors and an obstacle.

The warning indicator for the front area is located above the center air vents in the dashboard. The warning indicator for the rear area is integrated in the rear trim.



#### Front area warning indicator

- ① Left side of the vehicle
- ② Right side of the vehicle

Each warning indicator is divided into six yellow and two red distance segments for either side of the vehicle. The Parktronic system is ready when the border around the indicator is illuminated.

The position of the gear selector lever determines which warning indicators will be activated.

<b>Gear selector lever position</b>	<b>Warning indicator</b>
<b>D</b>	Front area activated
<b>R or N</b>	Front and rear area activated
<b>P</b>	Neither activated

As your vehicle approaches an object, one or more distance segments will illuminate, depending on the distance. When the eighth distance segment illuminates, you have reached the minimum distance.

- **Front area:** An intermittent acoustic warning will sound as the first red distance segment illuminates and a constant acoustic warning lasting a maximum of 2 seconds will sound for the second distance segment. The signal is canceled when the gear selector lever is placed in position **P** or the parking brake is set.
- **Rear area:** An intermittent acoustic warning will sound when the first distance segment illuminates. This signal quickens with each additional distance segment lit. When the eighth distance segment illuminates, the acoustic warning becomes a constant signal. The signal is canceled when the gear selector lever is placed in position **D** or **P** or the parking brake is set.

### Switching the Parktronic system on/off

You can switch off the Parktronic system manually.

The Parktronic switch is located in the lower part of the center console (▷ page 32).



- ① Parktronic switch
- ② Indicator lamp

### Switching off

- ▶ Press Parktronic switch ①.  
Indicator lamp ② comes on.

### Switching on

- ▶ Press Parktronic switch ① once more.  
Indicator lamp ② goes out.

**i** *The Parktronic system switches on automatically when you switch on the ignition (▷ page 39).*

### Parktronic system malfunction

If only the red distance segments illuminate and an acoustic warning sounds, there is a malfunction in the Parktronic system. The Parktronic system will automatically switch off after 20 seconds and the indicator lamp in the Parktronic switch comes on.

- ▶ Have the Parktronic system checked by an authorized Mercedes-Benz Center as soon as possible.



### Driving systems

If only the red distance segments illuminate and no acoustic warning sounds, the Parktronic system sensors are dirty or there is an interference from other radio or ultrasonic signals. The Parktronic system will automatically switch off after 20 seconds and the indicator lamp in the Parktronic switch comes on.

- ▶ Switch off the ignition (▷ page 39).
- ▶ Clean the Parktronic system sensors (▷ page 326).
- ▶ Switch on the ignition (▷ page 39).  
or
- ▶ Check the Parktronic system operation at another location to rule out interference from outside radio or ultrasonic signals.

## ▼ Useful features

### Storage compartments

#### Warning!



To help avoid personal injury during a collision or sudden maneuver, exercise care when storing objects in the vehicle. Put luggage or cargo in the trunk if possible. Do not pile luggage or cargo higher than the seat backs. Do not place anything on shelf behind roll bar.

Parcel nets cannot secure hard or heavy objects.

Keep compartment lids closed. This will help to prevent stored objects from being thrown about and injuring vehicle occupants during an accident.

### Glove box



- ① Glove box lid release
- ② Glove box lid

#### Opening glove box

- ▶ Press glove box lid release ①.  
Glove box lid ② opens downward.

#### Closing glove box

- ▶ Push glove box lid ② up to close.

### Door storage compartments

#### Warning!



Keep the door storage compartments closed while vehicle is in motion. Failure to do so may cause the seat belt to catch at the rear and prevent proper positioning of the seat belt.

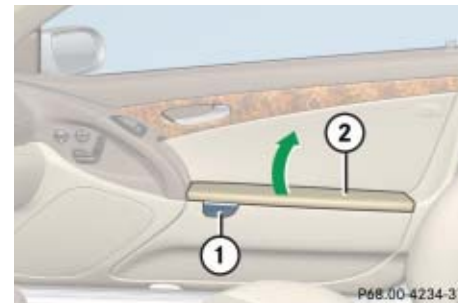

- ① Release button
- ② Storage compartment lid

### Useful features

#### Opening

- ▶ Press release button ①.



Storage compartment lid ② lid opens upwards.

#### Armrest storage compartments

The release buttons are located under the cushion of the armrest.



- ① Storage tray release
- ② Storage compartment release

**i** The Roadside Assistance button  (▷ page 247) and the Information button  (▷ page 248) are located in the storage tray.

#### Opening storage tray

- ▶ Press button ① and lift the armrest.

#### Opening storage compartment

- ▶ Press button ② and lift the armrest.

#### Seat storage compartments

Storage compartments are located in the seat base of each seat and are intended for storing small, light weight items.

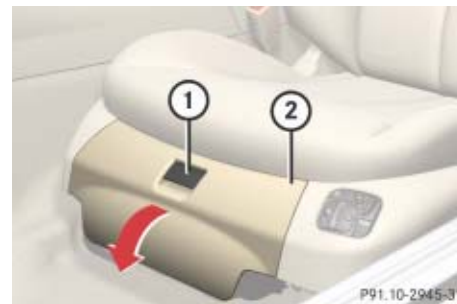

#### Passenger seat storage compartment

- ① Handle
- ② Storage compartment lid

- ▶ Pull handle ① up.
- ▶ Fold lid ② down.

**i** The driver's seat storage compartment contains the first-aid kit, (▷ page 388).

### Rear storage compartments

The CD changer is located in the driver's side storage compartment.

For instructions on the CD changer, see separate COMAND Operator's Manual.



#### Driver's side rear storage compartment

- ① Release button
- ② Storage compartment lid

► Press release button ①.

Storage compartment lid ② lid opens upwards.

### Locking storage compartments

The storage compartments are centrally locked when you lock the vehicle from the outside.

You can also lock the storage compartments separately, see "Locking the storage compartments separately" (► page 235).

### Locking the storage compartments separately

You can lock the storage compartments separately, e.g. when the vehicle is in the shop for service.

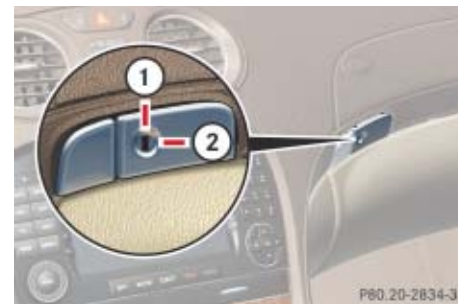

- ① Separately unlocking storage compartments
  - ② Separately locking storage compartments
- Remove the mechanical key from the SmartKey (► page 391). >>>

### Useful features

▷▷ Insert the mechanical key into the glove box lock.

- ▶ Turn the mechanical key to position ②.

The following storage compartments will be locked. They remain locked, even when the vehicle is unlocked with the SmartKey or with the SmartKey with KEYLESS-GO\*:

- Glove box
- Armrest storage compartments
- Rear storage compartments

**i** *The separate locking status of these storage compartments can only be canceled with the mechanical key.*

*The storage compartments in the doors cannot be locked.*

**i** *If the glove box cannot be unlocked using the SmartKey or SmartKey with KEYLESS-GO\*, see "Unlocking the glove box" (▷ page 392).*

### Unlocking the storage compartments separately

- ▶ Insert the mechanical key into the glove box lock.
- ▶ Turn the mechanical key to position ①.

You can now open the storage compartments.

### Parcel net in passenger footwell

A small convenience parcel net is located in the passenger footwell. It is for small and light items, such as road maps, mail, etc.

#### Warning!



The parcel net is intended for storing light-weight items only.

Heavy objects, objects with sharp edges or fragile objects may not be transported in the parcel net. In an accident, during hard braking, or sudden maneuvers, they could be thrown around inside the vehicle and cause injury to vehicle occupants.

The parcel net cannot protect transported goods in the event of an accident.

### Parcel nets in trunk

There are three nets available in the trunk to secure loads:

- a pocket net on each side of the right and left trunk side walls
- a trunk floor net
- ▶ Pull the trunk floor net from the trunk back wall towards the front over the luggage.
- ▶ Hang the hooks of the net on the eyes on the trunk floor.

### Luggage compartment in the rear

#### Warning!



Secure all pieces of luggage in the rear with the luggage straps. Unsecured pieces of luggage can otherwise cause injury during a braking maneuver and can increase the risk of injury in an accident.

Never allow anyone to ride in the rear.

The luggage straps can only secure light luggage items. Carry heavy pieces of luggage in the trunk.

The rear compartment area is not designed or intended to accommodate occupants. Severe personal injury or death may be the result in an accident.

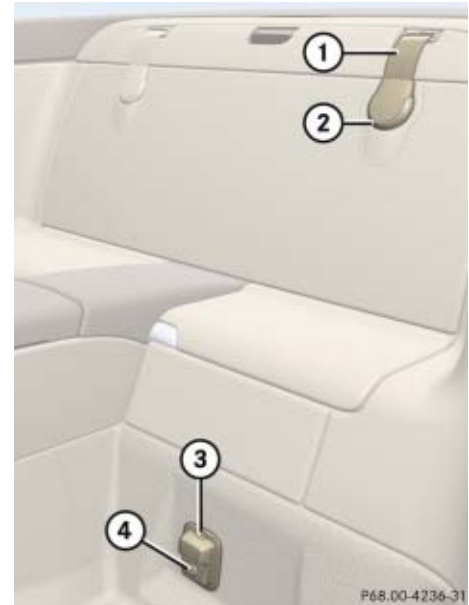

- ① Strap
- ② Holder
- ③ Latch
- ④ Release button

### Useful features

- ▶ Pull strap ① out of holder ②.
- ▶ Secure the luggage with the strap so that it cannot move.
- ▶ Insert strap ① into latch ③.

#### Releasing strap

- ▶ Press release button ④ and guide strap ① back to holder ②.

#### Warning!



The shelf below the rear window should not be used to carry objects. This will avoid such objects from being thrown about and injuring vehicle occupants during an accident or sudden maneuver.

The trunk is the preferred place to carry objects.

### Cup holders

#### Warning!



In order to help prevent spilling liquids on vehicle occupants and/or vehicle equipment, only use containers that fit into the cup holder. Use lids on open containers and do not fill containers to a height where the contents, especially hot liquids, could spill during braking, vehicle maneuvers, or in an accident. Liquids spilled on vehicle occupants may cause serious personal injury. Liquids spilled on vehicle equipment may cause damage not covered by the Mercedes-Benz Limited Warranty.

When not in use, keep the cup holder closed. An open cup holder may cause injury to or others when contacted during braking, vehicle maneuvers, or in an accident.

Keep in mind that objects placed in the cup holder may come loose during braking, vehicle maneuvers, or in an accident and be thrown around in the vehicle interior. Objects thrown around in the vehicle interior may cause an accident and/or serious personal injury.



- ① Left cup holder
- ② Right cup holder

#### Opening

- ▶ Briefly press cup holder cover.  
The cup holder opens automatically.

## Ashtray



- ① Cover plate
- ② Sliding knob

### Opening ashtray

- ▶ Briefly touch cover plate ①.  
The ashtray opens automatically.

### Closing ashtray

- ▶ Press cover plate ① down until it latches.

## Removing the ashtray insert

### Warning!



Remove ashtray only with vehicle standing still. Set the parking brake to secure vehicle from movement. Move gear selector lever to position **N**. With gear selector lever in position **N**, turn off the engine.

- ▶ Secure vehicle from movement by setting the parking brake. Move the gear selector lever to position **N**.
- Now you have more room to take out the insert.
- ▶ Press sliding knob ② to the right.  
The insert will eject a short distance.

### Replacing the ashtray insert

- ▶ Press the insert into the frame until it snaps into place.

## Cigarette lighter

### Warning!



Never touch the heating element or sides of the lighter; they are extremely hot. Hold the knob only.

Make sure that any children traveling with you do not injure themselves or start a fire with the hot cigarette lighter.

When leaving the vehicle, always remove the SmartKey or the SmartKey with KEYLESS-GO\* from the starter switch, take it with you, and lock the vehicle. Do not leave children unattended in the vehicle, or with access to an unlocked vehicle. Unsupervised use of vehicle equipment may cause serious personal injury.

- ▶ Switch on the ignition (▷ page 39). ▷▷



### Useful features



#### ① Cigarette lighter

- ▶ Push in cigarette lighter ①.

The lighter will pop out automatically when hot.

**!** *The lighter socket can accommodate 12V DC electrical accessories (up to a maximum of 85 W) designed for use with the standard “cigarette lighter” plug type. Keep in mind, however, that connecting accessories to the lighter socket (for example extensive connecting and disconnecting, or using plugs that do not fit properly) can damage the lighter socket. With the socket damaged, the lighter may no longer be able to be placed in the heating (pushed-in) position, or the lighter may pop out too early with the lighter not hot enough.*

*To help avoid damaging the cigarette lighter socket, we recommend connecting 12V DC electrical accessories designed for use with the standard “cigarette lighter” plug type to the 12V power outlet (▷ page 242) in your vehicle whenever possible.*

### Heated steering wheel\*

The steering wheel heating warms up the leather area of the steering wheel.

The stalk is located on the lower left-hand side of the steering wheel.



- ① Switching on
- ② Switching off
- ③ Indicator lamp

## Switching on

- ▶ Switch on the ignition (▷ page 39).
- ▶ Turn the switch at the tip of the stalk in direction of arrow ①.

The steering wheel is heated. Indicator lamp ③ comes on.

**i** The steering wheel heating is temporarily suspended while indicator lamp ③ remains on when

- the temperature of the vehicle interior is above 86°F (30°C)
- the temperature of the steering wheel is above 95°F (35°C)

*When these conditions do not apply anymore, steering wheel heating continues.*

## Switching off

- ▶ Turn switch at the tip of the stalk in direction of arrow ②.

The steering wheel heating is switched off. Indicator lamp ③ goes out.

**i** Indicator lamp ③ flashes or switches off

- in case of power surge or undervoltage
- in case of a steering wheel heating malfunction

**i** The steering wheel heating switches off automatically when you remove the SmartKey from the starter switch or, on vehicles with KEYLESS-GO\*, when you switch off the ignition (▷ page 40) and open the driver's door.

For more information on the steering wheel, see “Multifunction steering wheel” (▷ page 140).

## Load assist in the trunk

To facilitate trunk loading after opening the trunk lid, use the load assist feature to raise the retracted hardtop from its storage position in the trunk.

### Warning!



To prevent injuries, make sure that there is no possibility of body parts getting caught in moving parts. If potential danger exists, press the switch again. This will immediately stop the movement of the hardtop.

### Useful features

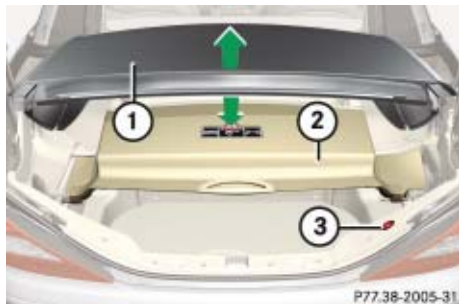

- ① Retracted hardtop
- ② Luggage cover
- ③ Load assist button

Hardtop ① can only be raised or lowered when

- luggage cover ② is closed
- the trunk lid is completely opened

#### Raising the hardtop

- ▶ Press button ③.

Hardtop ① rises a short distance. Button ③ comes on brightly. You can now open luggage cover ②.

#### Lowering the hardtop

- ▶ Close luggage cover ②.

- ▶ Press button ③.

Hardtop ① lowers. Button ③ is dimly lit.

**!** Only close the trunk if the hardtop is completely lowered. Otherwise you could damage the hardtop.

*If you begin to close the trunk lid before the hardtop is completely lowered, button ③ will flash and a warning will sound.*

#### Power outlet

A power outlet is located on the right side of the trunk.



- ▶ Switch on the ignition (▷ page 39).
- ▶ Flip up cover and insert electrical plug (cigar lighter type).

**i** The power outlet can be used to accommodate electrical consumers (e.g. air pump, auxiliary lamps) up to a maximum of 180 W.

## Telephone\*

### Warning!



Never operate radio transmitters equipped with a built-in or attached antenna (i.e. without being connected to an external antenna) from inside the vehicle while the engine is running. Doing so could lead to a malfunction of the vehicle's electronic system, possibly resulting in an accident and/or serious personal injury.

Radio transmitters, such as a portable telephone or a citizens band unit, should only be used inside the vehicle if they are connected to an antenna that is installed on the outside of the vehicle.

The external antenna must be approved by Mercedes-Benz. Please contact an authorized Mercedes-Benz Center for information on the installation of an approved external antenna. Refer to the radio transmitter operation instructions regarding use of an external antenna.

### Warning!





Please do not forget that your primary responsibility is to drive the vehicle. A driver's attention to the road must always be his/her primary focus when driving. For your safety and the safety of others, we recommend that you pull over to a safe location and stop before placing or taking a telephone call.

If you choose to use the telephone<sup>1</sup> while driving, please use the hands-free device and only use the telephone when road, weather, and traffic conditions permit. Some jurisdictions prohibit the driver from using a cellular telephone while driving a vehicle.

Only operate the COMAND (Cockpit Management and Data System)<sup>1</sup> if road, weather, and traffic conditions permit.

<sup>1</sup> Observe all legal requirements.

Bear in mind that at a speed of just 30 mph (approximately 50 km/h), your vehicle is covering a distance of 44 feet (approximately 14 m) every second.

You can take and place telephone calls using the  and  buttons on the steering wheel. To carry out other telephone functions, use the control system (> page 165).

See separate instruction manual for instructions on how to operate the telephone.

### Useful features

#### Tele Aid

**!** The initial activation of the Tele Aid system may only be performed by completing the subscriber agreement and placing an acquaintance call using the  button. Failure to complete either of these steps will result in a system that is not activated.

If you have any questions regarding activation, please call the Response Center at 1-800-756-9018 (in the USA) or 1-888-923-8367 (in Canada).



#### The Tele Aid system



(Telematic Alarm Identification on Demand)

The Tele Aid system consists of three types of response:



- Automatic and manual emergency
- Roadside Assistance
- Information

The Tele Aid system is operational providing that the vehicle's battery is charged, properly connected, not damaged and cellular and GPS coverage is available.

The speaker volume of a Tele Aid call can be adjusted when using the volume control on the multifunction steering wheel. To raise, press button  and to lower, press button  or use the volume knob on your COMAND headunit.

- ▶ To activate, press the SOS button, the Roadside Assistance button  or the Information button , depending on the type of response required.



**i** The SOS button is located above the interior rear view mirror (▷ page 246).

The Roadside Assistance button  and the Information button  are located below the center armrest cover (▷ page 234).

Shortly after the completion of your Tele Aid acquaintance call, you will receive a user ID and password. By visiting [www.mbusa.com](http://www.mbusa.com) and selecting “Tele Aid” (USA only), you will have access to account information, remote door unlock, and more.

**!** The Tele Aid system utilizes the cellular network for communication and the GPS (Global Positioning System) satellites for vehicle location. If either of these signals are unavailable, the Tele Aid system may not function and if this occurs, assistance must be summoned by other means.

#### System self-check

Initially, after switching on the ignition, malfunctions are detected and indicated (the indicator lamps in the SOS button, the Roadside Assistance button  and the Information button  stay on longer

than 10 seconds or do not come on). The message

TeleAid malfunction - Visit workshop appears for approximately 10 seconds in the multifunction display.

### Warning!



If the indicator lamps in the SOS button, in the Roadside Assistance button, and/or in the Information button do not come on during the system self-check, or if any of these indicators remain illuminated continuously in red and/or the message TeleAid malfunction - Visit workshop is displayed in the multifunction display after the system self-check, a malfunction in the system has been detected.

If a malfunction is indicated as outlined above, the system may not operate as expected. Have the system checked at the nearest Mercedes-Benz Center as soon as possible.

## Emergency calls

An emergency call is initiated automatically following an accident in which the emergency tensioning devices (ETDs) or air bags deploy.

An emergency call can also be initiated manually by opening the cover next to the interior rear view mirror labeled SOS, then briefly pressing the button located under the cover. See (▷ page 246) for instructions on initiating an emergency call manually.

Once the emergency call is in progress, the indicator lamp in the SOS button will begin to flash. The message Connecting call appears in the multifunction display and the audio system is muted. When the connection is established, the message Call connected appears in the multifunction display. All information relevant to the emergency, such as the location of the vehicle (determined by the GPS satellite location system), vehicle model, identification number and color are generated.

A voice connection between the Response Center and the occupants of the vehicle will be established automatically soon after the emergency call has been initiated. The Response Center will attempt to determine more precisely the nature of the emergency provided they can speak to an occupant of the vehicle.

The Tele Aid system is available if

- it has been activated and is operational
  - Activation requires a subscription for monitoring services, connection and cellular air time.
- the relevant cellular phone network and GPS signals are available and pass the information on to the Response Center

**i** Location of the vehicle on a map is only possible if the vehicle is able to receive signals from the GPS satellite network and pass the information on to the Response Center.

#### Warning!



If the indicator lamp in the SOS button is flashing continuously and there was no voice connection to the Response Center established, then the Tele Aid system could not initiate an emergency call (e.g. the relevant cellular phone network is not available). The message *Call failed* appears in the multifunction display for approximately 10 seconds.

Should this occur, assistance must be summoned by other means.

#### Initiating an emergency call manually

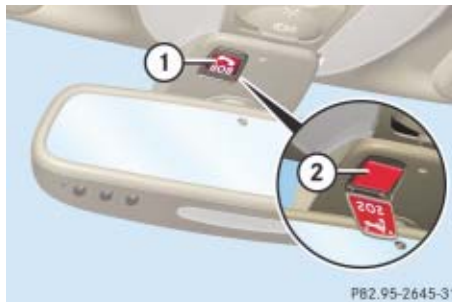

- ① Cover
- ② SOS button

- ▶ Briefly press on cover ①.  
The cover opens.
- ▶ Press SOS button ② briefly.  
The indicator lamp in SOS button ② will flash until the emergency call is concluded.
- ▶ Wait for a voice connection to the Response Center.
- ▶ Close cover ① after the emergency call is concluded.

#### Warning!



If you feel at any way in jeopardy when in the vehicle (e.g. smoke or fire in the vehicle, vehicle in a dangerous road location), please do not wait for voice contact after you have pressed the emergency button. Carefully leave the vehicle and move to a safe location. The Response Center will automatically contact local emergency officials with the vehicle's approximate location if they receive an automatic SOS signal and cannot make voice contact with the vehicle occupants.

**Roadside Assistance button** 

The Roadside Assistance button  is located below the center armrest cover.

① Roadside Assistance button 

- ▶ Press and hold button ① (for longer than 2 seconds)

A call to a Mercedes-Benz Roadside Assistance dispatcher will be initiated. The button will flash while the call is in progress. The message **Connecting call** will appear in the multifunction display and the audio system is muted.

When the connection is established, the message **Call connected** appears in the multifunction display. The Tele Aid system will transmit data generating the vehicle identification number, model, color and location (subject to availability of cellular and GPS signals).



A voice connection between the Roadside Assistance dispatcher and the occupants of the vehicle will be established.

- ▶ Describe the nature of the need for assistance.

The Mercedes-Benz Roadside Assistance dispatcher will either dispatch a qualified Mercedes-Benz technician or arrange to tow your vehicle to the nearest authorized Mercedes-Benz Center. For services such as labor and /or towing, charges may apply. Refer to the Roadside Assistance Manual for more information.

The following is only available in the USA:

- Sign and Drive services: Services such as jump start, a few gallons of fuel or the replacement of a flat tire with the vehicle spare tire are obtainable.

 *The indicator lamp in the Roadside Assistance button  remains illuminated in red for approximately 10 seconds during the system self-check after switching on the ignition (together with the SOS button and the Information button .*

*See system self-check (▷ page 244) if the indicator lamp does not come on in red or stays on longer than approximately 10 seconds.*

*If the indicator lamp in the Roadside Assistance button  is flashing continuously and there was no voice connection to the Response Center established, then the Tele Aid system could not initiate a Roadside Assistance call (e.g. the relevant cellular phone network is not available). The message **Call failed** appears in the multifunction display.*

*Roadside Assistance calls can be terminated using the  button on the multifunction steering wheel or the respective button for ending a telephone call on the COMAND headunit.*



### Useful features

#### Information button

The Information button  is located below the center armrest cover.



#### ① Information button



- ▶ Press and hold button ① (for longer than 2 seconds).

A call to the Customer Assistance Center will be initiated. The button will flash while the call is in progress. The message **Connecting call** will appear in the multifunction display and the audio system is muted.

When the connection is established, the message **Call connected** appears in the multifunction display. The Tele Aid system will transmit data generating the vehicle identification number, model, color and location (subject to availability of cellular and GPS signals).

A voice connection between the Customer Assistance Center representative and the occupants of the vehicle will be established. Information regarding the operation of your vehicle, the nearest Mercedes-Benz Center or Mercedes-Benz USA products and services is available to you.

For more details concerning the Tele Aid system, please visit [www.mbusa.com](http://www.mbusa.com) and use your ID and password (sent to you separately) to learn more (USA only).

**i** The indicator lamp in the Information button  remains illuminated in red for approximately 10 seconds during the system self-check after switching on the ignition (together with the SOS button and the Roadside Assistance button ).

See system self-check (▷ page 244) if the indicator lamp does not come on in red or stays on longer than approximately 10 seconds.

If the indicator lamp in the Information button  is flashing continuously and no voice connection to the

Response Center was established, then the Tele Aid system could not initiate an Information call (e.g. the relevant cellular phone network is not available). The message **Call failed** appears in the multifunction display.

Information calls can be terminated using the  button on the multifunction steering wheel or the respective button for ending a telephone call on the COMAND headunit.

**!** If the indicator lamps do not start flashing after pressing one of the buttons or remain illuminated (in red) at any time, the Tele Aid system has detected a malfunction or the service is currently not active, and may not initiate a call. Visit an authorized Mercedes-Benz Center and have the system checked or contact the Response Center at 1-800-756-9018 (in the USA) or 1-888-923-8367 (in Canada) as soon as possible.

### Call priority

If other service calls such as a Roadside Assistance call or Information call are active, an Emergency call is still possible. In this case, the Emergency call will take priority and override all other active calls.

**i** The indicator lamp in the respective button flashes until the call is concluded. Calls can only be terminated by a Response Center or Customer Assistance Center representative except Roadside Assistance and Information calls, which can also be terminated by pressing button  on the multifunction steering wheel or the respective button for ending a telephone call on the COMAND headunit.

**!** If the indicator lamp continues to flash or the system does not reset, contact the Response Center at 1-800-756-9018 (in the USA) or 1-888-923-8367 (in Canada), or Mercedes-Benz Customer Assistance at 1-800-FOR-MERCEdes (1-800-367-6372) in the USA or Customer Service at 1-800-387-0100 in Canada.

**i** When a Tele Aid call has been initiated, the COMAND system audio is muted and the selected mode (radio or CD) pauses. The optional cellular phone (if installed) switches off. If you must use this phone, the vehicle must be parked. Disconnect the coiled cord and place the call. The COMAND navigation system (if engaged) will continue to run. The display in the instrument cluster is available for use and spoken commands are only available by pressing the RPT button on the COMAND unit. A pop-up window will appear in the COMAND display to indicate that a Tele Aid call is in progress.

### Useful features

#### Remote door unlock

In case you have locked your vehicle unintentionally (e.g. SmartKey inside vehicle), and the reserve SmartKey is not handy:

- ▶ Contact the Mercedes-Benz Response Center at 1-800-756-9018 (in the USA) or 1-888-923-8367 (in Canada).

You will be asked to provide your password which you provided when you completed the subscriber agreement.

- ▶ Then return to your vehicle and pull the trunk recessed handle for a minimum of 20 seconds until the SOS button is flashing.

The message **Call connected** appears in the multifunction display.

As an alternative, you may unlock the vehicle via Internet using the ID and password sent to you shortly after the completion of your acquaintance call.

The Response Center will then unlock your vehicle with the remote door unlocking feature.

**i** *The remote door unlock feature is available if the relevant cellular phone network is available.*

*The SOS button will flash and the message **Call connected** will appear in the multifunction display to indicate receipt of the door unlock command.*

*Once the vehicle is unlocked, a Response Center specialist will attempt to establish voice contact with the vehicle occupants.*

*If the trunk recessed handle was pulled for more than 20 seconds before door unlock authorization was received by the Response Center, you must wait 15 minutes before pulling the trunk recessed handle again.*

#### Stolen Vehicle Recovery services

In the event your vehicle was stolen:

- ▶ Report the incident to the police.

The police will issue a numbered incident report.

- ▶ Pass this number on to the Mercedes-Benz Response Center along with your password issued to you when you subscribed to the service.

The Response Center will then attempt to covertly contact the vehicle's Tele Aid system. Once the vehicle is located, the Response Center will contact the local law enforcement and you. The vehicle's location will only be provided to law enforcement.

**i** *If the anti-theft alarm or the tow-away alarm stays on for more than 30 seconds, a call to the Response Center is initiated automatically by the Tele Aid system provided Tele Aid service was subscribed to and properly activated, and that necessary cellular service and GPS coverage are available. See anti-theft alarm system (▷ page 96) and tow away alarm (▷ page 98).*

## Garage door opener

The integrated remote control is capable of operating up to three separately controlled devices. It provides a convenient way to replace up to three hand-held remote controls used to operate devices such as garage door openers, gate openers, or other devices compatible with HomeLink® or some other systems.

Before the integrated remote control can be used, it must be programmed to the garage door opener, gate operator or other device you wish to operate. See the following instructions for programming information.

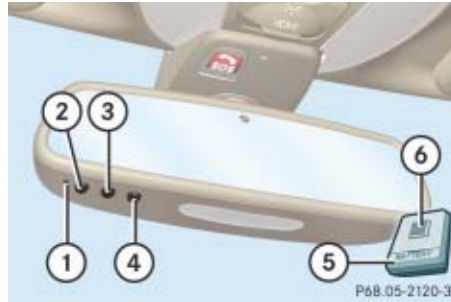

### Interior rear view mirror with integrated remote control

- ① Indicator lamp
- ② ③ ④ Signal transmitter button  
Needed for programming (not part of vehicle equipment):
- ⑤ Hand-held remote control of garage door opener, gate operator or other device
- ⑥ Hand-held remote control button

### Warning!



Before programming the integrated remote control to a garage door opener or gate operator, make sure people and objects are out of the way of the device to prevent potential harm or damage. When programming a garage door opener, the door moves up or down. When programming a gate operator, the gate opens or closes.

Do not use the integrated remote control with any garage door opener that lacks safety stop and reverse features as required by U.S. federal safety standards (this includes any garage door opener model manufactured before April 1, 1982). A garage door that cannot detect an object – signaling the door to stop and reverse – does not meet current U.S. federal safety standards.



### Useful features

▷▷ When programming a garage door opener, park the vehicle outside the garage.

Do not run the engine while programming the integrated remote control.

Inhalation of exhaust gas is hazardous to your health. All exhaust gas contains carbon monoxide (CO), and inhaling it can cause unconsciousness and possible death.

#### Programming the integrated remote control

Step 1:

- ▶ Switch on the ignition (▷ page 39).

Step 2:

- ▶ If you have previously programmed an signal transmitter button and wish to retain its programming, proceed to step 3.

If you are programming the integrated remote control for the first time, press and hold the two outer signal transmitter buttons ② and ④ and release them only when indicator lamp ① begins to flash after approximately 20 seconds (do not hold the button for longer than 30 seconds). This procedure erases any previous settings for all three channels and initializes the memory.

If you later wish to program a second and/or third hand-held transmitter to the remaining two signal transmitter buttons, do not repeat this step and begin directly with step 3.

Step 3:

- ▶ Hold the end of hand-held remote control ⑤ of the device you wish to train approximately 2 to 5 in (5 to 12 cm) away from the signal transmitter button (②, ③ or ④) to be programmed, while keeping indicator lamp ① in view.

Step 4:

- ▶ Using both hands, simultaneously press hand-held remote control button ⑥ and the desired signal transmitter button (②, ③ or ④). Do not release the buttons until step 5 is completed.

Indicator lamp ① will flash, first slowly and then rapidly.

**i** Indicator lamp ① flashes immediately the first time the signal transmitter button is programmed. If this button has already been programmed, the indicator lamp will only start flashing after 20 seconds.

## Step 5:

- ▶ After indicator lamp ① changes from a slow to a rapidly flashing light, release the hand-held remote control button and the signal transmitter button.

## Step 6:

- ▶ Press and hold the just-trained signal transmitter button (②, ③ or ④) and observe indicator lamp ①.

If indicator lamp ① stays on constantly, programming is complete and your device should activate when the respective signal transmitter button (②, ③ or ④) is pressed and released.

**i** If indicator lamp ① flashes rapidly for about 2 seconds and then turns to a constant light, continue with programming steps 8 through 12 as your garage door opener may be equipped with the “rolling code” feature.

## Step 7:

- ▶ To program the remaining two signal transmitter buttons, repeat the steps above starting with step 3.

**Rolling code programming**

To train a garage door opener (or other rolling code devices) with the rolling code feature, follow these instructions after completing the “Programming” portion (steps 1 through 6) of this text. (A second person may make the following training procedures quicker and easier.)

## Step 8:

- ▶ Locate “training” button on the garage door opener motor head unit.

Exact location and color of the button may vary by garage door opener brand. Depending on manufacturer, the “training” button may also be referred to as “learn” or “smart” button. If there is difficulty locating the transmitting button, refer to the garage door opener Operator’s Manual.

## Step 9:

- ▶ Press the “training” button on the garage door opener motor head unit.

The “training light” is activated.

You have 30 seconds to initiate the following step.

## Step 10:

- ▶ Return to the vehicle and firmly press, hold for 2 seconds and release the programmed signal transmitter button (②, ③ or ④).

## Step 11:

- ▶ Press, hold for 2 seconds and release same signal transmitter button a second time to complete the training process.

**i** Some garage door openers (or other rolling code equipped devices) may require you to press, hold for 2 seconds and release the same signal transmitter button a third time to complete the training process.



### Useful features

▷▷ Step 12:

- ▶ Confirm the garage door operation by pressing the programmed signal transmitter button (②), (③) or (④).

Step 13:

- ▶ To program the remaining two signal transmitter buttons, repeat the steps above starting with step 3.

#### **Gate operator/Canadian programming**

Canadian radio-frequency laws require transmitter signals to “time-out” (or quit) after several seconds of transmission which may not be long enough for the integrated signal transmitter to pick up the signal during programming. Similar to this Canadian law, some U.S. gate operators are designed to “time-out” in the same manner.

If you live in Canada or if you are having difficulties programming a gate operator (regardless of where you live) by using the programming procedures, replace step 4 with the following:

Step 4:

- ▶ Press and hold the signal transmitter button (②), (③) or (④). Do not release this button until it has been successfully trained.

- ▶ While still holding down the signal transmitter button (②), (③) or (④), “cycle” your hand-held remote control button (⑥) as follows: Press and hold button (⑥) for 2 seconds, then release it for 2 seconds, and again press and hold it for 2 seconds. Repeat this sequence on the hand-held remote control until the frequency signal has been learned. Upon successful training, indicator lamp (①) will flash slowly and then rapidly after several seconds.
- ▶ Proceed with programming step 5 and step 6 to complete.

**i** Upon completion of programming the integrated remote control, make sure you retain the hand-held remote control that came with the garage door opener, gate operator or other device. You may need it for use in other vehicles, for future programming of an integrated remote control, or simply for continued use as a hand-held remote control to operate the respective device in other situations.

### Reprogramming a single signal transmitter button

To program a device using a signal transmitter button previously trained, follow these steps:

- ▶ Switch on the ignition (▷ page 39).
- ▶ Press and hold the desired signal transmitter button (②, ③ or ④). Do not release the button.
- ▶ Indicator lamp ① will begin to flash after 20 seconds. Without releasing the signal transmitter button, proceed with programming starting with step 3.

### Operation of integrated remote control

- ▶ Switch on the ignition (▷ page 39).
- ▶ Select and press the appropriate integrated signal transmitter button (②, ③ or ④) to activate the remote controlled device.

The integrated remote control transmitter continues to send the signal as long as the button is pressed – up to 20 seconds.

### Erasing the integrated remote control memory

- ▶ Switch on the ignition (▷ page 39).
- ▶ Simultaneously press and hold outer signal transmitter buttons ② and ④, for approximately 20 seconds, until the indicator lamp ① flashes rapidly. Do not hold for longer than 30 seconds.

The codes of all three channels are erased.

**i** *If you sell your vehicle, erase the codes of all three channels.*

### Programming tips

If you are having difficulty programming the integrated remote control, here are some helpful tips:

- Check the frequency of hand-held remote control ⑤ (typically located on the reverse side of the remote). The integrated remote control is compatible with radio-frequency devices operating between 288-399 MHz.
- Put a new battery in hand-held remote control ⑤. This will increase the likelihood of the hand-held remote control sending a faster and more accurate signal to the integrated remote control.
- While performing step 3, hold hand-held remote control ⑤ at different lengths and angles from the signal transmitter button (②, ③ or ④) you are programming. Attempt varying angles at the distance of 2 to 5 inches (5 to 12 cm) away or the same angle at varying distances.



### Useful features

- If another hand-held remote control is available for the same device, try the programming steps again using that other hand-held remote control. Make sure new batteries are in the hand-held remote control before beginning the procedure.
- Straighten the antenna wire from the garage door opener assembly. This may help improve transmitting and/or receiving signals.

**i** *Certain types of garage door openers are incompatible with the integrated remote control. If you should experience further difficulties with programming the integrated remote control, contact an authorized Mercedes-Benz Center, or call Mercedes-Benz Customer Assistance Center (in the USA only) at 1-800-FOR-MERcedes, or Customer Service (in Canada) at 1-800-387-0100.*

**i** *USA only:*

*This device complies with Part 15 of the FCC Rules. Operation is subject to the following two conditions:*

- (1) This device may not cause harmful interference, and*
- (2) this device must accept any interference received, including interference that may cause undesired operation.*

*Any unauthorized modification to this device could void the user's authority to operate the equipment.*

**i** *Canada only:*

*This device complies with RSS-210 of Industry Canada. Operation is subject to the following two conditions:*

- (1) This device may not cause interference, and*
- (2) this device must accept any interference received, including interference that may cause undesired operation of the device.*

*Any unauthorized modification to this device could void the user's authority to operate the equipment.*

**The first 1000 miles (1500 km)**

**Driving instructions**

**At the gas station**

**Engine compartment**

**Tires and wheels**

**Winter driving**

**Maintenance**

**Vehicle care**



### The first 1000 miles (1500 km)

In the “Operation” section you will find detailed information on operating, maintaining and caring for your vehicle.

The more cautiously you treat your vehicle during the break-in period, the more satisfied you will be with its performance later on.

- Drive your vehicle during the first 1000 miles (1500 km) at varying but moderate vehicle and engine speeds.
- During this period, avoid heavy loads (full throttle driving) and excessive engine speeds (no more than  $\frac{2}{3}$  of maximum rpm in each gear).
- Avoid accelerating by kickdown.
- Do not attempt to slow the vehicle down by shifting to a lower gear using the gear selector lever.
- Select positions **3**, **2** or **1** only when driving at moderate speeds (for hill driving).
- Select **C** as the preferred shift program (▷ page 169) for the first 1000 miles (1500 km).

After 1000 miles (1500 km), you may gradually increase vehicle and engine speeds to the permissible maximum.

#### Additional instructions for AMG vehicles:

- During the first 1000 miles (1500 km), do not exceed a speed of 85 mph (140 km/h).
- During this period, avoid engine speeds above 4500 rpm (SL 55 AMG) or 4000 rpm (SL 65 AMG) in each gear.

All of the above instructions, as may apply to your vehicle type, also apply when driving the first 1000 miles (1500 km) after the engine or the rear differential has been replaced.

 Always obey applicable speed limits.

## ▼ Driving instructions

### Drive sensibly – save fuel

---

Fuel consumption, to a great extent, depends on driving habits and operating conditions.

To save fuel you should:

- Keep tires at the recommended inflation pressures.
- Remove unnecessary loads.
- Allow engine to warm up under low load use.
- Avoid frequent acceleration and deceleration.
- Have all maintenance work performed at the intervals specified in the Maintenance Booklet and as required by the maintenance system. Contact an authorized Mercedes-Benz Center.

Fuel consumption is also increased by driving in cold weather, in stop-and-go traffic, on short trips and in hilly area.

### Drinking and driving

---

#### Warning!



Drinking and driving and/or taking drugs and driving are a very dangerous combination. Even a small amount of alcohol or drugs can affect your reflexes, perceptions and judgment.

The possibility of a serious or even fatal accident are greatly increased when you drink or take drugs and drive.

Do not drink or take drugs and drive or allow anyone to drive who has been drinking or taking drugs.

### Pedals

---

#### Warning!



Make sure that absolutely no objects are obstructing the pedal's range of movement. Keep the driver's footwell clear of all obstacles. If there are any floor mats or carpets in the footwell, make sure the pedals still have sufficient clearance. This could lead to accidents or injury.

### Driving instructions

#### Power assistance

##### Warning!



The brake system requires electrical energy for operation.

A malfunction in the vehicle's power supply or electrical system may impair brake system operation and switch it into its emergency operation mode. In such a case, the red brake warning lamp (▷ page 335) and warning messages (▷ page 347) in the instrument cluster come on while driving. To brake, the driver must then apply significantly greater brake pedal pressure and depress the pedal much further to obtain the expected braking effect. If necessary, apply full pressure to the brake pedal. Brakes are only applied to the front wheels. Stopping distance is increased! If there is a malfunction in the electro-hydraulic brake system, we recommend that the vehicle be transported with all wheels off the ground using flatbed or appropriate wheel lift/dolly equipment.

A tow bar must be used if circumstances do not permit the use of the recommended towing methods and the vehicle requires towing with all four wheels on the ground.

Towing the vehicle with all four wheels on the ground is only permissible for distances up to 30 miles (50 km) and at a speed not to exceed 30 mph (50 km/h). For more information, see "Towing the vehicle" (▷ page 421).

With the engine not running, there is no power assistance for the brake and steering systems. In this case, it is important to keep in mind that a considerably higher degree of effort is necessary to brake and steer the vehicle.

#### Brakes

##### Warning!



After driving in heavy rain for some time without applying the brakes or through water deep enough to wet brake components, the first braking action may be somewhat reduced and increased pedal pressure may be necessary to obtain expected braking effect. Maintain a safe distance from vehicles in front.

Resting your foot on the brake pedal will cause excessive and premature wear of the brake pads.

It can also result in the brakes overheating thereby significantly reducing their effectiveness. It may not be possible to stop the vehicle in sufficient time to avoid an accident.

To help prevent brake disk corrosion after driving on wet road surfaces (particularly salted roads), it is advisable to brake the vehicle with considerable force prior to parking. The heat generated serves to dry the brakes.

If your brake system is normally only subjected to moderate loads, you should occasionally test the effectiveness of the brakes by applying above-normal braking pressure at higher speeds. This will also enhance the grip of the brake pads.

**Warning!**

Make sure not to endanger any other road users when carrying out these braking maneuvers.

Refer to the description of the Brake Assist System (BAS) (▷ page 89).

If the parking brake is released and the brake warning lamp in the instrument cluster stays on, there is a malfunction in the electro-hydraulic brake system (▷ page 92) or the brake fluid level in the reservoir is too low.

Brake pad wear or a leak in the system may be the reason for low brake fluid in the reservoir.

Have the brake system inspected immediately.

All checks and service work on the brake system should be carried out by qualified technicians only. Contact an authorized Mercedes-Benz Center.

Only install brake pads and brake fluid recommended by Mercedes-Benz.

**Warning!**

If other than recommended brake pads are installed, or other than recommended brake fluid is used, the braking properties of the vehicle can be degraded to an extent that safe braking is substantially impaired. This could result in an accident.

Be certain to read and observe the warning notices on brake pad replacement (▷ page 94).

**!** *When driving down long and steep grades, relieve the load on the brakes by shifting into a lower gear to use the engine's braking power. This helps prevent overheating of the brakes and reduces brake pad wear.*

After hard braking, it is advisable to drive on for some time, rather than to park immediately, so the air stream will cool down the brakes faster.

### Driving instructions

#### High-performance brake system (AMG vehicles only)

The high-performance brake system is designed to operate under the extremely high operating demands required to accommodate the performance capabilities of the vehicle. The brakes may produce a squeaking-type noise depending on the

- vehicle speed
- brake force applied
- ambient conditions, e.g. temperature and humidity

As with any brake system, the wear of individual brake system components such as brake pads or disks strongly depends on your driving style and the conditions under which you operate the vehicle. Thus, a driving style calling for high demand braking will cause your vehicle's brakes to wear more quickly.

#### Warning!



New vehicle brake pads and discs, and replacement brake pads and discs may take several hundred miles of driving until they provide optimum braking efficiency. Until that time, you may need to use increased brake pedal pressure while braking. Please be aware of this and adjust your driving and braking accordingly during this break-in period.

Excessive high demand braking will cause correspondingly high brake wear. Please be attentive to the brake warning lamp in the instrument cluster and brake condition messages in the multifunction display. Especially for high performance driving, it is important to maintain and have the brake system checked regularly.

#### Driving off

Apply the brakes to test them briefly after driving off. Perform this procedure only when the road is clear of other traffic.

Warm up the engine smoothly. Do not place full load on the engine until the operating temperature has been reached.

When starting off on a slippery surface, do not allow a drive wheel to spin for an extended period with the ESP® switched off. Doing so may cause serious damage to the drivetrain which is not covered by the Mercedes-Benz Limited Warranty.

**!** *Simultaneously depressing the accelerator pedal and applying the brake reduces engine performance and causes premature brake and drivetrain wear.*

## Parking

### Warning!



Do not park this vehicle in areas where combustible materials such as grass, hay or leaves can come into contact with the hot exhaust system, as these materials could be ignited and cause a vehicle fire.

To reduce the risk of personal injury as a result of vehicle movement, before turning off the engine and leaving the vehicle always:

- Keep right foot on brake pedal.
- Firmly depress parking brake pedal.
- Move the gear selector lever to position **P**.
- Slowly release brake pedal.

- When parked on an incline, turn front wheels towards the road curb.
- Turn the SmartKey in the starter switch to position **0** and remove the SmartKey from the starter switch, or press the start/stop button (vehicles with KEYLESS-GO\*).
- Take the SmartKey or the SmartKey with KEYLESS-GO\* and lock vehicle when leaving.

**!** *Set the parking brake whenever parking or leaving the vehicle. In addition, move gear selector lever to position **P**. When parking on hills, turn front wheels towards the road curb.*

## Tires

### Warning!



If you feel a sudden significant vibration or ride disturbance, or you suspect that possible damage to your vehicle has occurred, you should turn on the hazard warning flashers, carefully slow down, and drive with caution to an area which is a safe distance from the road.

Inspect the tires and the vehicle underbody for possible damage. If the vehicle or tires appear unsafe, have the vehicle towed to the nearest Mercedes-Benz Center or tire dealer for repairs.

Treadwear indicators (TWI) are required by law. These indicators are located in six places on the tread circumference and become visible at a tread depth of approximately  $\frac{1}{16}$  in (1.6 mm), at which point the tire is considered worn and should be replaced.



### Driving instructions

The treadwear indicator appears as a solid band across the tread.

#### Warning!



Although the applicable federal motor vehicle safety laws consider a tire to be worn when the treadwear indicators (TWI) become visible at approximately  $\frac{1}{16}$  in (1.6 mm), we recommend that you do not allow your tires to wear down to that level. As tread depth approaches  $\frac{1}{8}$  in (3 mm), the adhesion properties on a wet road are sharply reduced.

Depending upon the weather and/or road surface (conditions), the tire traction varies widely.

Specified tire inflation pressures must be maintained. This applies particularly if the tires are subjected to extreme operating conditions (e.g. high speeds, heavy loads, high ambient temperatures).

#### Warning!



Do not drive with a flat tire. A flat tire affects the ability to steer or brake the vehicle. You may lose control of the vehicle. Continued driving with a flat tire or driving at high speed with a flat tire will cause excessive heat build-up and possibly a fire.

### Hydroplaning

Depending on the depth of the water layer on the road, hydroplaning may occur, even at low speeds and with new tires. Reduce vehicle speed, avoid track grooves in the road and apply brakes cautiously in the rain.

## Tire traction

The safe speed on a wet, snow covered or icy road is always lower than on a dry road.

You should pay particular attention to the condition of the road whenever the outside temperatures are close to the freezing point.

### Warning!



If ice has formed on the road, tire traction will be substantially reduced. Under such weather conditions, drive, steer and brake with extreme caution.

Mercedes-Benz recommends winter tires (▷ page 316) with a minimum tread depth of approximately  $\frac{1}{6}$  in (4 mm) on all four wheels for the winter season to ensure normal balanced handling characteristics. On packed snow, they can reduce your stopping distance as compared with summer tires. Stopping distance, however, is still considerably greater than when the road is not covered with snow or ice. Exercise appropriate caution.

**!** *Avoid spinning of a drive wheel. This may cause serious damage to the drivetrain which is not covered by the Mercedes-Benz Limited Warranty.*

## Tire speed rating

Regardless of the tire speed rating, local speed limits should be obeyed. Use prudent driving speeds appropriate to prevailing conditions.

### Warning!



Even when permitted by law, never operate a vehicle at speeds greater than the maximum speed rating of the tires.

Exceeding the maximum speed for which tires are rated can lead to sudden tire failure, causing loss of vehicle control and possibly resulting in an accident and/or personal injury and possible death, for you and for others.

### Driving instructions

#### SL 550

Your vehicle is factory equipped with “W”-rated tires, which have a speed rating of 168 mph (270 km/h).

An electronic speed limiter prevents your vehicle from exceeding a speed of 155 mph (250 km/h).

#### SL 600

#### SL 55 AMG

#### SL 65 AMG

#### SL 550 (Sport Package\*)

#### SL 600 (Sport Package\*)

Your vehicle is factory equipped with “Y”-rated tires, which have a speed rating of 186 mph (300 km/h).

An electronic speed limiter prevents your vehicle from exceeding a speed of 155 mph (250 km/h).

#### SL 55 AMG (Performance Package\*)

Your vehicle is factory equipped with “Y”-rated tires, which have a speed rating of 186 mph (300 km/h).

An electronic speed limiter prevents your vehicle from exceeding a speed of 186 mph (300 km/h).

 For information on tire speed rating for winter tires, see “All-season and winter tires” (▷ page 306).

For additional general information on tire speed markings on tire sidewall, see “Tire speed rating” (▷ page 304).

### Winter driving instructions

The most important rule for slippery or icy roads is to drive sensibly and to avoid abrupt acceleration, braking and steering maneuvers. Do not use the cruise control system under such conditions.

When the vehicle is in danger of skidding, move gear selector lever to position **N**. Try to keep the vehicle under control by corrective steering action.

 For information on driving with snow chains, see “Snow chains” (▷ page 318).

#### Warning!



On slippery road surfaces, never downshift in order to obtain braking action. This could result in drive wheel slip and reduced vehicle control. Your vehicle’s ABS will not prevent this type of control loss.

Road salts and chemicals can adversely affect braking efficiency. Increased pedal force may become necessary to produce the normal brake effect.

Depressing the brake pedal periodically when traveling at length on salt-strewn roads can bring road-salt-impaired braking efficiency back to normal.

If the vehicle is parked after being driven on salt-treated roads, the braking efficiency should be tested as soon as possible after driving is resumed.

**Warning!**

Make sure not to endanger any other road users when carrying out these braking maneuvers.

**Warning!**

If the vehicle becomes stuck in snow, make sure that snow is kept clear of the exhaust pipe and from around the vehicle with the engine running. Otherwise, deadly carbon monoxide (CO) gases may enter vehicle interior resulting in unconsciousness and death.

To assure sufficient fresh air ventilation, open a window slightly on the side of the vehicle not facing the wind.

**Warning!**

The outside temperature indicator is not designed to serve as an Ice-Warning Device and is therefore unsuitable for that purpose. Indicated temperatures just above the freezing point do not guarantee that the road surface is free of ice.

For more information, see “Winter driving” (▷ page 316).

**Standing water**

**!** Do not drive through flooded areas or water of unknown depth. Before driving through water, determine its depth. Never accelerate before driving into water. The bow wave could force water into the engine and auxiliary equipment, thus damaging them.

*If you must drive through standing water, drive slowly to prevent water from entering the passenger compartment or the engine compartment. Water in these areas could cause damage to electrical components or wiring of the engine or transmission, or could result in water being ingested by the engine through the air intake, causing severe internal engine damage. Any such damage is not covered by the Mercedes-Benz Limited Warranty.*

### Driving instructions

#### Passenger compartment

##### Warning!



Always fasten items being carried as securely as possible.

In an accident, during hard braking or sudden maneuvers, loose items will be thrown around inside the vehicle, and cause injury to vehicle occupants unless the items are securely fastened in the vehicle.

The trunk is the preferred place to carry objects.

#### Driving abroad

Abroad, there is an extensive Mercedes-Benz service network at your disposal. If you plan to drive into areas which are not listed in the index of your Mercedes-Benz Center directory, you should request pertinent information from an authorized Mercedes-Benz Center.

#### Control and operation of radio transmitters

##### COMAND, radio and telephone

##### Warning!



Please do not forget that your primary responsibility is to drive the vehicle safely. Only operate the COMAND (Cockpit Management and Data System), radio or telephone<sup>1</sup> if road, weather, and traffic conditions permit.

Bear in mind that at a speed of just 30 mph (approximately 50 km/h), your vehicle is covering a distance of 44 feet (approximately 14 m) every second.

<sup>1</sup> Observe all legal requirements.

#### Telephones and two-way radios

##### Warning!



Never operate radio transmitters equipped with a built-in or attached antenna (i.e. without being connected to an external antenna) from inside the vehicle while the engine is running. Doing so could lead to a malfunction of the vehicle's electronic system, possibly resulting in an accident and/or personal injury.

Radio transmitters, such as a portable telephone or a citizens band unit should only be used inside the vehicle if they are connected to an antenna that is installed on the outside of the vehicle.

Refer to the radio transmitter operation instructions regarding use of an external antenna.

## Catalytic converter

---

Your Mercedes-Benz is equipped with monolithic-type catalytic converters, an important element in conjunction with the oxygen sensors to achieve substantial control of the pollutants in the exhaust emissions. Keep your vehicle in proper operating condition by following our recommended maintenance instructions as outlined in your Maintenance Booklet.

**!** *To prevent damage to the catalytic converters, only use premium unleaded gasoline in this vehicle.*

*Any noticeable irregularities in engine operation should be repaired promptly. Otherwise, excessive unburned fuel may reach the catalytic converter causing it to overheat and potentially start a fire.*

### Warning!



As with any vehicle, do not idle, park or operate this vehicle in areas where combustible materials such as grass, hay or leaves can come into contact with the hot exhaust system, as these materials could be ignited and cause a vehicle fire.

## Emission control

---

Certain systems of the engine serve to keep the toxic components of the exhaust gases within permissible limits required by law.

These systems, of course, will function properly only when maintained strictly according to factory specifications. Any adjustments on the engine should therefore be carried out only by qualified Mercedes-Benz Center authorized technicians. Engine adjustments should not be altered in any way. Moreover, the specified service jobs must be carried out regularly according to Mercedes-Benz servicing requirements. For details refer to the Maintenance Booklet.

### Driving instructions

#### Warning!



Inhalation of exhaust gas is hazardous to your health. All exhaust gas contains carbon monoxide (CO), and inhaling it can cause unconsciousness and possible death.

Do not run the engine in confined areas (such as a garage) which are not properly ventilated. If you think that exhaust gas fumes are entering the vehicle while driving, have the cause determined and corrected immediately. If you must drive under these conditions, drive only with at least one window fully open at all times.

#### Coolant temperature

During severe operating conditions, e.g. stop-and-go city traffic, the coolant temperature may rise close to approx. 266°F (130°C).

The engine should not be operated with the coolant temperature over 248°F (120°C). Doing so may cause serious engine damage which is not covered by the Mercedes-Benz Limited Warranty.

#### Warning!



- Driving when your engine is badly overheated can cause some fluids, which may have leaked into the engine compartment, to catch fire. You could be seriously burned.
- Steam from an overheated engine can cause serious burns and can occur just by opening the engine hood. Stay away from the engine if you see or hear steam coming from it. Turn off the engine, get out of the vehicle and do not stand near the vehicle until the engine has cooled down.

## ▼ At the gas station

### Refueling

#### Warning!



Gasoline is highly flammable and poisonous. It burns violently and can cause serious injury. Whenever you are around gasoline, avoid inhaling fumes and skin contact, extinguish all smoking materials. Never allow sparks, flame or smoking materials near gasoline!

Turn off the engine before refueling.

#### Warning!



Overfilling of the fuel tank may create pressure in the system which could cause a gas discharge. This could cause the gas to spray back out when removing the fuel pump nozzle, which could cause personal injury.

The fuel filler flap is located on the right-hand side of the vehicle towards the rear. Locking/unlocking the vehicle with the SmartKey or the SmartKey with KEYLESS-GO\* automatically locks/unlocks the fuel filler flap.



- ① Fuel filler flap
- ② Fuel filler cap
- ③ Holder

- ▶ Turn off the engine
  - by turning the SmartKey to position **0**. Remove the SmartKey from the starter switch.
  - by pressing the KEYLESS-GO\* start/stop button. Open the driver's door (with the driver's door open, starter switch is in position **0**, same as SmartKey removed from starter switch).
- ▶ Open fuel filler flap ① by pushing at the point indicated by the arrow. The fuel filler flap springs open.
- ▶ Turn fuel cap ② counterclockwise and hold on to it until possible pressure is released.
- ▶ Take off fuel cap ② and place it into holder ③ located on the inside of the fuel filler flap.
- ▶ Only fill your tank until the filler nozzle unit cuts out – **do not top up or over-fill.**





### At the gas station

▷▷ Insert fuel cap ② into fuel filler neck and turn fuel cap clockwise until it audibly engages.



▶ Close fuel filler flap ①.

You should hear the latch close shut.

**i** Only use premium unleaded gasoline with a minimum Posted Octane Rating of 91 (average of 96 RON/86 MON).

Information on gasoline quality can normally be found on the fuel pump.

For more information on gasoline, see “Premium unleaded gasoline” (▷ page 447) or the Factory Approved Service Pamphlet.

**i** Leaving the engine running and the fuel cap open can cause the engine malfunction indicator lamp  (USA only) or the engine malfunction indicator lamp  (Canada only) to illuminate.

For more information, see the “Practical hints” section (▷ page 336).

### Check regularly and before a long trip

For information on quantities and requirements of operating agents, see “Fuels, coolants, lubricants, etc.” (▷ page 444).

▶ Open the hood (▷ page 274).



① Windshield washer and headlamp cleaning system

② Brake fluid

③ Coolant level

### Windshield washer and headlamp cleaning system

For information on refilling the reservoir, see “Windshield washer system and headlamp cleaning system” (▷ page 282).

### Brake fluid

For information on brake fluid, see “Fuels, coolants, lubricants, etc.” (▷ page 444).

**!** If you find that the brake fluid in the brake fluid reservoir has fallen to the minimum mark or below, have the brake system checked for brake pad thickness and leaks immediately. Notify an authorized Mercedes-Benz Center immediately. Do not add brake fluid as this will not solve the problem. For more information, see the “Practical hints” section (▷ page 369).

**Coolant level**

For information on checking the coolant level, see “Coolant” (▷ page 280).

**Engine oil level**

For more information on checking the engine oil level, see “Engine oil” (▷ page 275).

**Vehicle lighting**

Check function and cleanliness. For more information, see “Replacing bulbs” (▷ page 397).

Exterior lamp switch, see “Switching on headlamps” (▷ page 55).

**Tire inflation pressure**

For information on checking the tire inflation pressure, see “Checking tire inflation pressure” (▷ page 292).

## Engine compartment

### Hood

#### Warning!



Do not pull the release lever while the vehicle is in motion. Otherwise the hood could be forced open by passing air flow.

This could cause the hood to come loose and injure you and/or others.

### Opening

#### Warning!



If you see flames or smoke coming from the engine compartment, or if the coolant temperature gauge indicates that the engine is overheated, do not open the hood. Move away from the vehicle and do not open the hood until the engine has cooled. If necessary, call the fire department.

#### Warning!



You could be injured when the hood is open – even when the engine is turned off.

Parts of the engine can become very hot. To prevent burns, only touch owner serviceable components described in the Operator's Manual and comply with all relevant safety precautions.

#### Warning!



To help prevent personal injury, stay clear of moving parts when the hood is open and the engine is running.

The radiator fan may continue to run for approximately 30 seconds or may even restart after the engine has been turned off. Stay clear of fan blades.

#### Warning!



The engine is equipped with a transistorized ignition system. Because of the high voltage it is dangerous to touch any components (ignition coils, spark plug sockets, diagnostic socket) of the ignition system

- with the engine running
- while starting the engine
- if ignition is “on” and the engine is turned manually



① Hood release

P88.40-2611-31

- ▶ Pull hood release ①.

The hood is unlocked.

**!** To avoid damage to the windshield wipers or hood, never open the hood if the wiper arms are folded forward away from the windshield.



- ② Lever for opening the hood

- ▶ Push lever ② on the hood upwards.
- ▶ Pull up on the hood and then release it.

The hood will be automatically held open at shoulder height by gas-filled struts.

## Closing

### Warning!



When closing the hood, use extreme caution not to catch hand or fingers. Be careful that you do not close the hood on anyone.

Make sure the hood is securely engaged before driving. Do not continue driving if the hood can no longer engage after an accident for example. The hood could otherwise come loose while the vehicle is in motion and injure you and/or others.

- ▶ Let the hood drop from a height of approximately  $1\frac{1}{2}$  ft (50 cm).  
The hood will lock audibly.
- ▶ Check to make sure the hood is fully closed.

If you can raise the hood at a point above the headlamps, then it is not properly closed. Open it again and let it drop with somewhat greater force.

## Engine oil

The amount of oil your engine needs will depend on a number of factors, including driving style. Higher oil consumption can occur when

- the vehicle is new
- the vehicle is driven frequently at higher engine speeds

Engine oil consumption checks should only be made after the vehicle break-in period.

**i** Do not use any special lubricant additives, as these may damage the drive assemblies. Using special additives not approved by Mercedes-Benz may cause damage not covered by the Mercedes-Benz Limited Warranty. More information on this subject is available at any Mercedes-Benz Center.

## Engine compartment



### Checking engine oil level with the control system

When checking the oil level

- the vehicle must be parked on level ground
- with the engine at operating temperature, the vehicle must have been stationary for at least 5 minutes with the engine turned off
- with the engine not at operating temperature, the vehicle must have been stationary for at least 30 minutes with the engine turned off

- ▶ Switch on the ignition (▷ page 39).



The standard display (▷ page 139) should appear in the multifunction display.

- ▶ Press button  or  on the steering wheel until the following message appears in the multifunction displays:



One of the following messages will subsequently appear in the right multifunction display:

- Engine oil level OK
- Add 1.0 qt. to reach max. oil level  
(Canada: 1.0 l)
- Add 1.5 qts. to reach max. oil level  
(Canada: 1.5 l)
- Add 2.0 qts. to reach max. oil level  
(Canada: 2.0 l)

**i** If you want to interrupt the checking procedure, press the  or  button on the multifunction steering wheel.

- ▶ If necessary, add engine oil.

For information on adding engine oil, see (▷ page 278).

For more information on engine oil, see the “Technical data” section (▷ page 444) and (▷ page 446).

### **Other display messages**

If the SmartKey or the KEYLESS-GO\* start/stop button is not in position **2**, the following message will appear:

Turn ignition on to  
measure engine  
oil level

- ▶ Switch on the ignition (▷ page 39).

If you see the message:

Observe  
waiting time

- ▶ If the engine is at operating temperature, wait 5 minutes before repeating the check procedure.
- ▶ If the engine is not at operating temperature yet, wait 30 minutes before repeating the check procedure.

If you see the message:

Engine oil level  
Not when  
engine on

- ▶ Turn off the engine.
- ▶ If the engine is at operating temperature, wait 5 minutes before checking oil.
- ▶ If the engine is at operating temperature yet, you must wait 30 minutes before checking oil.

If there is excess engine oil with the engine at normal operating temperature, the following message will appear:

Engine oil level  
Reduce  
oil level

- ▶ Have excess oil siphoned or drained off. Contact an authorized Mercedes-Benz Center.

**!** *Excess oil must be siphoned or drained off. It could cause damage to the engine and catalytic converter not covered by the Mercedes-Benz Limited Warranty.*

For more information on messages in the display concerning engine oil, see the “Practical hints” section (▷ page 375).

## Engine compartment

### Checking engine oil level with the oil dipstick (SL 550 only)

**i** In vehicles without an oil dipstick, the engine oil level is measured via the control system (▷ page 276).

When checking the oil level

- the vehicle must be parked on level ground
- the vehicle must have been stationary for at least 5 minutes with the engine turned off



- ① Oil dipstick
- ② Upper mark
- ③ Lower mark

- ▶ Open the hood (▷ page 274).
- ▶ Pull out oil dipstick ①.
- ▶ Wipe oil dipstick ① clean.
- ▶ Fully insert oil dipstick ① into the dipstick guide tube.
- ▶ Pull out oil dipstick ① again after approximately 3 seconds to obtain accurate reading.

The oil level is correct when it is between lower mark ③ (min.) and upper mark ② (max.) of the oil dipstick.

**i** The filling quantity between the upper and lower marks on the oil dipstick is approximately 2.1 US qt. (2.0 l).

- ▶ If necessary, add engine oil (▷ page 278).

For more information on engine oil, see “Technical data” section (▷ page 444) and (▷ page 446).

For information on messages in the multi-function display concerning engine oil, see the “Practical hints” section (▷ page 375).

### Adding engine oil

**!** Only use approved engine oils and oil filters required for vehicles with Maintenance System (U.S. vehicles) or FSS (Canada vehicles). For a listing of approved engine oils and oil filters, refer to the Factory Approved Service Products pamphlet in your vehicle literature portfolio, or contact an authorized Mercedes-Benz Center.

Using engine oils and oil filters of specification other than those expressly required for the Maintenance System (U.S. vehicles) or FSS (Canada vehicles), or changing of oil and oil filter at change intervals longer than those called for by the Maintenance System (U.S. vehicles) or FSS (Canada vehicles) will result in engine or emission control system damage not covered by the Mercedes-Benz Limited Warranty.



Example illustration SL 550

① Filler cap



Example illustration SL 55 AMG

① Filler cap

- ▶ Unscrew filler cap ① from filler neck.
- ▶ Add engine oil as required. Be careful not to overfill with oil.

Be careful not to spill any oil when adding. Avoid environmental damage caused by oil entering the ground or water.

**!** *Excess oil must be siphoned or drained off. It could cause damage to the engine and catalytic converter not covered by the Mercedes-Benz Limited Warranty.*

- ▶ Screw filler cap ① back on filler neck.

For more information on engine oil, see the “Technical data” section (▷ page 444) and (▷ page 446).

### Transmission fluid level

The transmission fluid level does not need to be checked. If you notice transmission fluid loss or gear shifting malfunctions, have an authorized Mercedes-Benz Center check the automatic transmission.

### Oil level in the ABC system

The oil level in the ABC system does not need to be checked. If there is visible oil loss or if malfunction messages appear in the display, have an authorized Mercedes-Benz Center check the ABC system.



## Engine compartment

### Coolant

#### Warning!



In order to avoid any possibly serious burns:

- Use extreme caution when opening the hood if there are any signs of steam or coolant leaking from the cooling system, or if the coolant temperature gauge indicates that the coolant is overheated.
- Do not remove pressure cap on coolant reservoir if coolant temperature is above 158°F (70°C). Allow engine to cool down before removing cap. The coolant reservoir contains hot fluid and is under pressure.
- Using a rag, slowly open the cap approximately 1/2 turn to relieve excess pressure. If opened immediately, scalding hot fluid and steam will be blown out under pressure.
- Do not spill antifreeze on hot engine parts. Antifreeze contains ethylene glycol which may burn if it comes into contact with hot engine parts.

The engine coolant is a mixture of water and anticorrosion/antifreeze. To check the coolant level, the vehicle must be parked on level ground and the engine must be cool.

The coolant expansion tank is located on the passenger side of the engine compartment.



#### ① Coolant expansion tank

- ▶ Using a rag, slowly turn the cap approximately one half turn counterclockwise to release any excess pressure.

- ▶ Continue turning the cap counterclockwise and remove it.

The coolant level is correct if the level

- for cold coolant: is up to the upper mark on the bracing rib of the coolant expansion tank (translucent)
- for warm coolant: is approx. 0.6 in (1.5 cm) higher
- ▶ Add coolant as required.
- ▶ Replace and tighten cap.

**!** *SL 600 and SL 65 AMG: Only open the cap on coolant expansion tank ①. Never open the cap between the two charge-air coolers. Otherwise, the engine could be damaged.*

For more information, see “Coolants” (▷ page 449).

## Battery

Your vehicle is equipped with two batteries:

- The starter battery (located in the engine compartment)
- The battery for electrical consumers (located in the trunk)

These batteries should always be sufficiently charged in order to achieve their rated service life. Refer to Maintenance Booklet for battery maintenance intervals.

If you use your vehicle mostly for short-distance trips, you will need to have the battery charge checked more frequently.

When replacing batteries, always use batteries approved by Mercedes-Benz.

If you do not intend to operate your vehicle for an extended period of time, consult an authorized Mercedes-Benz Center about steps you need to observe.

### Warning!



Observe all safety instructions and precautions when handling automotive batteries.



Risk of explosion.



Fire, open flames and smoking are prohibited when handling batteries. Avoid creating sparks.



Battery acid is caustic. Do not allow it to come into contact with skin, eyes or clothing.

Wear suitable protective clothing, especially gloves, apron and faceguard.



Wear eye protection.  
Rinse any acid spills immediately with clear water. Contact a physician if necessary.



Keep children away.



Follow the instructions in this Operator's Manual.

Batteries contain materials that can harm the environment if disposed of improperly. Recycling of batteries is the preferred method of disposal. Many states require sellers of batteries to accept old batteries for recycling.

### Engine compartment

#### Windshield washer system and headlamp cleaning system

The windshield washer reservoir is located in the engine compartment.



#### ① Washer fluid reservoir

Fluid for the windshield washer system and the headlamp cleaning system is supplied from the windshield washer reservoir. It has a capacity of approx. 7.4 US qt. (7 l).

During all seasons, add MB Windshield Washer Concentrate “MB SummerFit” to water. Premix the windshield washer fluid in a suitable container.

#### Warning!



Washer solvent/antifreeze is highly flammable. Do not spill washer solvent/antifreeze on hot engine parts, because it may ignite and burn. You could be seriously burned.

- ▶ Refill the reservoir with MB Windshield Washer Concentrate “MB SummerFit” and water (or commercially available premixed windshield washer solvent/antifreeze, depending on ambient temperatures).

Always use washer solvent/antifreeze where temperatures may fall below freezing point. Failure to do so could result in damage to the washer system/reservoir.

**!** Only use washer fluid which is suitable for plastic lenses. Improper washer fluid can damage the plastic lenses of the headlamps.

For more information, see “Windshield and headlamp washer system” (> page 452).

## ▼ Tires and wheels

See an authorized Mercedes-Benz Center for information on tested and recommended rims and tires for summer and winter operation. They can also offer advice concerning tire service and purchase.

### Warning!



Replace rims or tires with the same designation, manufacturer and type as shown on the original part. See an authorized Mercedes-Benz Center for further information. If incorrectly sized rims and tires are mounted:

- The wheel brakes or suspension components can be damaged.
- The operating clearance of the wheels and the tires may no longer be correct.

### Warning!



Worn, old tires can cause accidents. If the tire tread is badly worn, or if the tires have sustained damage, replace them.

When replacing rims, only use genuine Mercedes-Benz wheel bolts specified for the particular rim type. Failure to do so can result in the bolts loosening and possibly an accident.

Retreaded tires are not tested or recommended by Mercedes-Benz, since previous damage cannot always be recognized on re-treads. The operating safety of the vehicle cannot be assured when such tires are used.

## Important guidelines

- Only use sets of tires and rims of the same type and make.
- Tires must be of the correct size for the rim.
- Break in new tires for approximately 60 miles (100 km) at moderate speeds.
- Regularly check the tires and rims for damage. Dented or bent rims can cause tire inflation pressure loss and damage to the tire beads.
- If vehicle is heavily loaded, check tire inflation pressure and correct as required.
- Do not allow your tires to wear down too far. Adhesion properties on wet roads are sharply reduced at tread depths under  $\frac{1}{8}$  in (3 mm).
- When replacing individual tires, you should mount new tires on the front wheels first (on vehicles with same-sized wheels all around).

## Tires and wheels

### Tire care and maintenance

#### Warning!



Regularly check the tires for damage. Damaged tires can cause tire inflation pressure loss. As a result, you could lose control of your vehicle.

Worn, old tires can cause accidents. If the tire tread is badly worn, or if the tires have sustained damage, replace them.

Regularly check your tire inflation pressure at least once a month. For more information on checking tire inflation pressure, see “Recommended tire inflation pressure” (▷ page 291).

### Tire inspection

Every time you check your tire inflation pressure, you should also inspect your tires for the following:

- excessive treadwear (▷ page 285)
- cord or fabric showing through the tire’s rubber
- bumps, bulges, cuts, cracks or splits in the tread or side of the tire

Replace the tire if you find any of the above conditions.

Make sure you also inspect the spare tire periodically for condition and inflation. Spare tires will age and become worn over time even if never used, and thus should be inspected and replaced when necessary.

### Life of tire

The service life of a tire is dependent upon varying factors including but not limited to:

- Driving style
- Tire inflation pressure
- Distance driven

#### Warning!



Tires and spare tire should be replaced after 6 years, regardless of the remaining tread.

## Tread depth

Do not allow your tires to wear down too far. Adhesion properties on wet roads are sharply reduced at tread depths under  $\frac{1}{8}$  in (3 mm).

Treadwear indicators (TWI) are required by law. These indicators are located in six places on the tread circumference and become visible at a tread depth of approximately  $\frac{1}{16}$  in (1.6 mm), at which point the tire is considered worn and should be replaced.

Recommended minimum tire tread depth:

- Summer tires  $\frac{1}{8}$  in (3 mm)
- Winter tires  $\frac{1}{6}$  in (4 mm)

### Warning!



Although the applicable federal motor safety laws consider a tire to be worn when the treadwear indicators (TWI) become visible at approximately  $\frac{1}{16}$  in (1.6 mm), we recommend that you do not allow your tires

to wear down to that level. As tread depth approaches  $\frac{1}{8}$  in (3 mm), the adhesion properties on a wet road are sharply reduced.

Depending upon the weather and/or road surface (conditions), the tire traction varies widely.

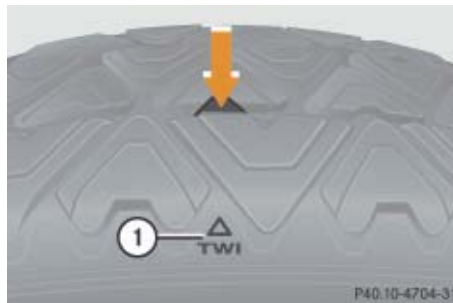

### ① TWI (Tread Wear Indicator)

The treadwear indicator appears as a solid band across the tread.

## Storing tires

**!** *Keep unmounted tires in a cool, dry place with as little exposure to light as possible. Protect tires from contact with oil, grease and gasoline.*

## Cleaning tires

**!** *Never use a round nozzle to power wash tires. The intense jet of water can result in damage to the tire.*

*Always replace a damaged tire.*

### Tires and wheels

#### Direction of rotation

Unidirectional tires offer added advantages, such as better hydroplaning performance. To benefit, however, you must make sure the tires rotate in the direction specified.

An arrow on the sidewall indicates the intended direction of rotation (spinning) of the tire.

**i** *Spare wheels may be mounted against the direction of rotation (spinning) even with a unidirectional tire for temporary use only until the regular drive wheel has been repaired or replaced. Always observe and follow applicable temporary use restrictions and speed limitations indicated on the spare wheel.*

#### Loading the vehicle

A label on your vehicle shows how much weight it may properly carry.

- The Tire and Loading Information placard can be found on the driver's door B-pillar. This placard tells you important information about the number of people that can be in the vehicle and the total weight that can be carried in the vehicle. It also contains information on the proper size and recommended tire inflation pressures for the original equipment tires on your vehicle.
- The Certification label, also found on the driver's door B-pillar tells you about the gross weight capacity of your vehicle, called the Gross Vehicle Weight Rating (GVWR). The GVWR includes the weight of the vehicle, all occupants, fuel and cargo. The Certification label also tells you about the front and rear axle weight capacity, called the Gross Axle Weight Rating (GAWR). The GAWR is the total allowable weight that can be

carried by a single axle (front or rear). Never exceed the GVWR or GAWR for either the front axle or rear axle.



#### ① Driver's door B-pillar

Following is a discussion on how to work with the information contained on the placard with regards to loading your vehicle.

## Tire and Loading Information

### Warning!



Do not overload the tires by exceeding the specified load limit or vehicle capacity weight as indicated on the placard on the driver's door B-pillar. Overloading the tires can overheat them, possibly causing a blowout. Overloading the tires can also result in handling or steering problems, or brake failure.

### Tire and Loading Information placard

**i** Data shown on placard example are for illustration purposes only. Load limit data are specific to each vehicle and may vary from data shown in the illustration below. Refer to placard on vehicle for actual data specific to your vehicle.

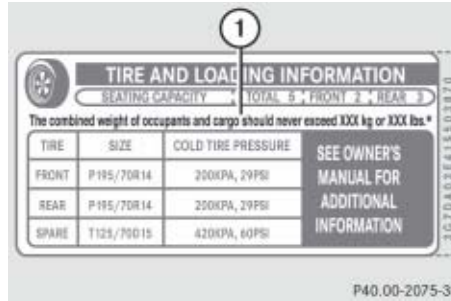

① Load limit information on the Tire and Loading Information placard

The placard showing the load limit information is located on the driver's door B-pillar.

► Locate the statement “The combined weight of occupants and cargo should never exceed XXX kilograms or XXX lbs.” on this placard.

The combined weight of all occupants, cargo/luggage and trailer tongue load (if applicable) should never exceed the weight referenced in that statement.

## Seating capacity

The seating capacity gives you important information on the number of occupants that can be in the vehicle. Observe front and rear seating capacity. The placard showing the load limit information is located on the driver's door B-pillar (▷ page 286).

**i** Data shown on placard example are for illustration purposes only. Seating data are specific to each vehicle and may vary from data shown in the illustration below. Refer to placard on vehicle for actual data specific to your vehicle.

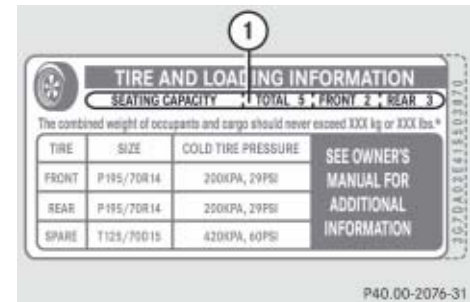

① Seating capacity information on the Tire and Loading Information placard



### Tires and wheels

#### *Steps for determining correct load limit*

The following steps have been developed as required of all manufacturers under Title 49, Code of U.S. Federal Regulations, Part 575 pursuant to the “National Traffic and Motor Vehicle Safety Act of 1966”.

##### **Step 1**

- ▶ Locate the statement “The combined weight of occupants and cargo should never exceed XXX kg or XXX lbs.” on your vehicle’s placard.

##### **Step 2**

- ▶ Determine the combined weight of the driver and passengers that will be riding in your vehicle.

##### **Step 3**

- ▶ Subtract the combined weight of the driver and passengers from XXX kilograms or XXX lbs.

##### **Step 4**

- ▶ The resulting figure equals the available amount of cargo and luggage load capacity. For example, if the “XXX” amount equals 1400 lbs. and there will be five 150 lbs. passengers in your vehicle, the amount of available cargo and luggage load capacity is 650 lbs. (1400 - 750 (5 x 150) = 650 lbs.)

##### **Step 5**

- ▶ Determine the combined weight of luggage and cargo being loaded on the vehicle. That weight may not safely exceed the available cargo and luggage load capacity calculated in step 4.

##### **Step 6** (if applicable)

- ▶ If your vehicle will be towing a trailer, load from your trailer will be transferred to your vehicle. Consult this manual to determine how this reduces the available cargo and luggage load capacity of your vehicle (▷ page 290).

The following table shows examples on how to calculate total and cargo load capacities with varying seating configurations and number and size of occupants. The following examples use a load limit of 1500 lbs. **This is for illustration purposes only.** Make sure you are using the actual load limit for your vehicle stated on the vehicle’s placard (▷ page 287).

Example	Combined weight limit of occupants and cargo from placard	Number of occupants (driver and passengers)	Occupants weight	Combined weight of all occupants	Available cargo/luggage and trailer tongue weight (total load limit or vehicle capacity weight from placard minus combined weight of all occupants)
1	1 500 lbs	1	Occupant 1: 175 lbs	175 lbs	1 500 lbs - 175 lbs = 1 325 lbs
2	1 500 lbs	2	Occupant 1: 175 lbs Occupant 2: 195 lbs	370 lbs	1 500 lbs - 370 lbs = 1 130 lbs

The higher the weight of all occupants, the less cargo and luggage load capacity is available.

For more information, see “Trailer tongue load” (▷ page 290).

### Tires and wheels

#### ***Certification label***

Even after careful determination of the combined weight of all occupants, cargo and the trailer tongue load (if applicable) (▷ page 290) as to not exceed the permissible load limit, you must make sure that your vehicle never exceeds the Gross Vehicle Weight Rating (GVWR) and the Gross Axle Weight Rating (GAWR) for either the front or rear axle. You can obtain the GVWR and GAWR from the Certification label. The Certification Label can be found on the driver's door B-pillar, see "Technical data" (▷ page 430).

**Gross Vehicle Weight Rating (GVWR):** The total weight of the vehicle, all occupants, all cargo, and the trailer tongue load (▷ page 290) must never exceed the GVWR.

**Gross Axle Weight Rating (GAWR):** The total allowable weight that can be carried by a single axle (front or rear).

To assure that your vehicle does not exceed the maximum permissible weight limits (GVWR and GAWR for front and rear axle), have the loaded vehicle (including driver, passengers and all cargo and, if applicable, trailer fully loaded) weighed on a suitable commercial scale.

#### ***Trailer tongue load***

The tongue load of any trailer is an important weight to measure because it affects the load you can carry in your vehicle. If a trailer is towed, the tongue load must be added to the weight of all occupants riding and any cargo you are carrying in the vehicle. The tongue load typically is 10 percent of the trailer weight and everything loaded in it.

Your Mercedes-Benz has been designed primarily to carry passengers and their cargo. Mercedes-Benz does not recommend trailer towing with your vehicle.

## Recommended tire inflation pressure

### Warning!



Follow recommended tire inflation pressures.

Do not underinflate tires. Underinflated tires wear excessively and/or unevenly, adversely affect handling and fuel economy, and are more likely to fail from being overheated.

Do not overinflate tires. Overinflated tires can adversely affect handling and ride comfort, wear unevenly, increase stopping distance, and result in sudden deflation (blowout) because they are more likely to become punctured or damaged by road debris, potholes etc.

Your vehicle is equipped with the Tire and Loading Information placard located on the driver's door B-pillar (▷ page 286).

The tire inflation pressure should be checked regularly and should only be adjusted on cold tires. The tires can be considered cold if the vehicle has been parked for at least 3 hours or driven less than 1 mile (1.6 km).

Follow recommended cold tire inflation pressures listed on placard.

Keeping the tires properly inflated provides the best handling, tread life and riding comfort.

In addition to the tire placard on the driver's door B-pillar, also consult the fuel filler flap for any additional information pertaining to special driving situations. For more information, see "Important notes on tire inflation pressure" (▷ page 292).

**i** Data shown on placard example are for illustration purposes only. Tire data are specific to each vehicle and may vary from data shown in the illustration below. Refer to placard on vehicle for actual data specific to your vehicle.

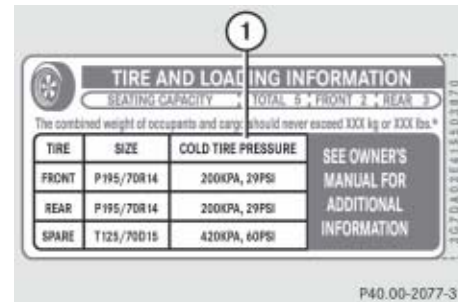

- ① Tire and Loading Information placard with recommended cold tire inflation pressures

The Tire and Loading Information placard lists the recommended cold tire inflation pressures for maximum loaded vehicle weight. The tire inflation pressures listed apply to the tires installed as original equipment.

### Tires and wheels

#### Important notes on tire inflation pressure

##### Warning!



If the tire inflation pressure repeatedly drops:

- Check the tires for punctures from foreign objects.
- Check to see whether air is leaking from the valves or from around the rim.

Tire temperature and tire inflation pressure are also increased while driving, depending on the driving speed and the tire load.

If you will be driving your vehicle at high speeds of 100 mph (160 km/h) or higher, where it is legal and conditions allow, consult the placard on the inside of the fuel filler flap on how to adjust the cold tire inflation pressure. If you do not adjust the tire inflation pressure, excessive heat can build up and result in sudden tire failure.

Be sure to readjust the tire inflation pressure for normal driving speeds. You should wait until the tires are cold before adjusting the tire inflation pressure.

Some vehicles may have supplemental tire pressure information for vehicle loads less than the maximum loaded vehicle condition. If such information is provided, it can be found on the placard located on the inside of the fuel filler flap.

Tire inflation pressure changes by approximately 1.5 psi (0.1 bar) per 18°F (10°C) of air temperature change. Keep this in mind when checking tire inflation pressure where the temperature is different from the outside temperature.

#### Checking tire inflation pressure

Regularly check your tire inflation pressure at least once a month.

Check and adjust the tire inflation pressure when the tires are cold. The tires can be considered cold if the vehicle has been parked for at least 3 hours or driven less than 1 mile (1.6 km).

If you check the tire inflation pressure when the tires are warm (the vehicle has been driven for several miles or sitting less than 3 hours), the reading will be approximately 4 psi (0.3 bar) higher than the cold reading. This is normal. Do not let air out to match the specified cold tire inflation pressure. Otherwise, the tire will be underinflated.

**Warning!**

Follow recommended tire inflation pressures.

Do not underinflate tires. Underinflated tires wear excessively and/or unevenly, adversely affect handling and fuel economy, and are more likely to fail from being overheated.

Do not overinflate tires. Overinflated tires can adversely affect handling and ride comfort, wear unevenly, increase stopping distance, and result in sudden deflation (blowout) because they are more likely to become punctured or damaged by road debris, potholes etc.

Do not overload the tires by exceeding the specified load limit or vehicle capacity weight as indicated on the placard on the driver's door B-pillar. Overloading the tires can overheat them, possibly causing a blowout. Overloading the tires can also result in handling or steering problems, or brake failure.

**Checking tire inflation pressure manually**

Follow the steps below to achieve correct tire inflation pressure:

- ▶ Remove the cap from the valve on one tire.
- ▶ Firmly press a tire gauge onto the valve.
- ▶ Read tire inflation pressure on tire gauge and check against the recommended tire inflation pressure on the placard on the driver's door B-pillar (▶ page 286). If necessary, add air to achieve the recommended tire inflation pressure.

**i** *If you have overfilled the tire, release tire inflation pressure by pushing the metal stem of the valve with e.g. a tip of a pen. Then recheck the tire inflation pressure with the tire gauge.*

- ▶ Install the valve cap.
- ▶ Repeat this procedure for each tire.

**Run Flat Indicator (Canada only)**

While the vehicle is being driven, the Run Flat Indicator monitors the set tire inflation pressures by evaluating each wheel's rotational speed. This allows the system to detect a significant loss of pressure in a tire. If a wheel's rotational speed changes due to falling tire inflation pressure, you will see a corresponding warning message in the multifunction display.

The Run Flat Indicator may function in a restricted manner or with a delay

- if snow chains are mounted to the vehicle
- in presence of ice and snow
- if you are driving on a loose surface (e.g. sand or gravel)
- if you are driving in a very sporty manner (involving rapid acceleration or high speeds in curves)

## Tires and wheels

### Warning!



When the multifunction display shows the message **Tire pressure Check tires**, one or more of your tires is significantly under-inflated. You should stop and check your tires as soon as possible, and inflate them to the proper tire inflation pressure as indicated on the vehicle's tire information placard. Driving on a significantly under-inflated tire causes the tire to overheat and can lead to tire failure. Under-inflation also reduces fuel efficiency and tire tread life, and may affect the vehicle's handling and stopping ability. Each tire, including the spare, should be checked monthly when cold and set to the recommended tire inflation pressure as specified on the Tire And Loading Information placard (▷ page 287) or on the tire inflation pressure label (▷ page 291).

### Warning!



The Run Flat Indicator does not provide a warning for wrongly selected tire inflation pressures. Always adjust tire inflation pressure according to the placard on the driver's door B-pillar or fuel filler flap.

The Run Flat Indicator does not replace regular checks of the tire inflation pressures since a gradual pressure loss in all four tires cannot be detected by the Run Flat Indicator.

The Run Flat Indicator is not able to issue a warning due to a sudden dramatic loss of tire inflation pressure (e.g. tire blowout caused by a foreign object). In this case bring the vehicle to a halt by carefully applying the brakes and avoiding abrupt steering maneuvers.

### *Reactivating the Run Flat Indicator*

The tire inflation pressure monitor must be reactivated in the following situations:

- if you have changed the tire inflation pressure
- if you have replaced the wheels or tires
- if you have installed new wheels or tires
- ▶ Using the tire placard on the driver's door B-pillar or, if available, the inside of the fuel filler flap, make sure the tire inflation pressure of all four tires is correct.

### Warning!





The Run Flat Indicator can only warn you in a reliable manner if you have set the correct tire inflation pressures for each tire.

If an incorrect tire inflation pressure was set, the system will monitor the pressure according to the incorrect value.

- ▶ Switch on the ignition (▷ page 39).

Make sure the standard display menu appears in the multifunction display (▷ page 145).

- ▶ Press button  or  repeatedly until the following message appears in the multifunction display:

Run Flat Indicator  
active  
Menu: R-Button

- ▶ Press the reset button (▷ page 27).

The following message will appear in the multifunction display:

Restart  
Run Flat Indicator?

If you wish to confirm activation:

- ▶ Press button .

The following message will appear in the multifunction display:

Run Flat Indicator  
restarted

After a certain “learning phase”, the Run Flat Indicator checks the set pressure values for all four tires.

If you wish to cancel activation:

- ▶ Press button .

### Checking tire pressure electronically with the Tire Pressure Monitoring System (TPMS), (USA only)

 *The Tire Pressure Monitoring System (TPMS) is equipped with a combination low tire pressure/TPMS malfunction telltale in the instrument cluster (▷ page 29). Depending on how the telltale illuminates, it indicates a low tire pressure condition or a malfunction in the TPMS system itself:*

- *If the telltale illuminates continuously, one or more of your tires is significantly under-inflated. There is no malfunction in the TPMS.*
- *If the telltale flashes for 60 seconds and then stays illuminated, the TPMS system itself is not operating properly.*



### Tires and wheels

The TPMS only functions on wheels that are equipped with the proper electronic sensors. It monitors the tire inflation pressure, as selected by the driver, in all four tires. A warning is issued to alert you to a decrease in pressure in one or more of the tires.

#### Warning!



The TPMS does not indicate a warning for wrongly selected inflation pressures. Always adjust tire inflation pressure according to the placard on the driver's door B-pillar or, if available, the supplemental tire pressure information on the inside of the fuel filler flap.

The TPMS is not able to issue a warning due to a sudden dramatic loss of pressure (e.g. tire blowout caused by a foreign object). In this case bring the vehicle to a halt by carefully applying the brakes and avoiding abrupt steering maneuvers.

#### Warning!



Each tire, including the spare (if provided), should be checked monthly when cold and inflated to the inflation pressure recommended by the vehicle manufacturer on the vehicle placard or the tire inflation pressure label. If your vehicle has tires of a different size than the size indicated on the vehicle placard or the tire inflation pressure label, you should determine the proper tire inflation pressure for those tires.

As an added safety feature, your vehicle has been equipped with a tire pressure monitoring system (TPMS) that illuminates a low tire pressure telltale when one or more of your tires is significantly underinflated. Accordingly, when the low tire pressure telltale illuminates, you should stop and check your tires as soon as possible, and inflate them to the proper pressure. Driving on a significantly underinflated tire causes the tire to overheat and can lead to tire failure.

Underinflation also reduces fuel efficiency and tire tread life, and may affect the vehicle's handling and stopping ability. Please note that the TPMS is not a substitute for proper tire maintenance, and it is the driver's responsibility to maintain correct tire pressure, even if under-inflation has not reached the level to trigger illumination of the TPMS low tire pressure telltale.

Your vehicle has also been equipped with a TPMS malfunction indicator to indicate when the system is not operating properly. The TPMS malfunction indicator is combined with the low tire pressure telltale. When the system detects a malfunction, the telltale will flash for approximately one minute and then remain continuously illuminated. This sequence will continue upon subsequent vehicle start-ups as long as the malfunction exists. When the malfunction indicator is illuminated, the system may not be able to detect or signal low tire pressure as intended.

TPMS malfunctions may occur for a variety of reasons, including the installation of incompatible replacement or alternate tires or wheels on the vehicle that prevent the TPMS from functioning properly. Always check the TPMS malfunction telltale after replacing one or more tires or wheels on your vehicle to ensure that the replacement or alternate tires and wheels allow the TPMS to continue to function properly.

**i** If a condition causing the TPMS to malfunction develops, it may take up to 10 minutes for the system to signal a malfunction using the TPMS telltale flashing and illumination sequence.

The telltale extinguishes after a few minutes driving if the malfunction has been corrected.

**i** Operating radio transmission equipment (e.g. wireless headsets, two-way radios) in or near the vehicle could cause the TPMS to malfunction.

### Reactivating the TPMS

#### Warning!







It is the driver's responsibility to calibrate the TPMS on the recommended cold inflation pressure. Underinflated tires affect the ability to steer or brake the vehicle. You might lose control over the vehicle.

The TPMS must be reactivated when you have adjusted the tire inflation pressure to a new level (e.g. because of different load or driving conditions). The TPMS is then recalibrated to the current tire inflation pressures.

- ▶ Using the tire placard on the driver's door B-pillar (▷ page 286) or, if available, the supplemental tire pressure information on the inside of the fuel filler flap (▷ page 271), make sure the tire inflation pressure of all four tires is correct.

**i** Reactivate the TPMS after adjusting the tire inflation pressure to the inflation pressure recommended for the vehicle operating condition. Tire pressure should only be adjusted on cold tires. Observe the recommended tire inflation pressure on the placard on the driver's door B-pillar (▷ page 286). Some vehicles may have supplemental tire pressure information for driving at high speeds (▷ page 292) or for vehicle loads less than the maximum loaded vehicle condition (▷ page 292). If such information is provided, it can be found on the inside of the fuel filler flap.

- ▶ Press button  or  on the multifunction steering wheel repeatedly until the standard display menu appears in the multifunction display (▷ page 145).
- ▶ Press the  or  button repeatedly until you see the following message:  
Tire pressure monitor  
active  
Menu: R-button



## Tires and wheels

- ▷▷ Press the reset button (▷ page 27).

The following message will appear in the multifunction display:

Restart tire  
pressure monitor?

- ▶ Press the **+** button.

The following message will appear in the multifunction display:

Tire pressure monitor restarted

After driving a few minutes the system verifies that the current tire inflation pressures are within the system's specified range. Afterwards the current tire inflation pressures are accepted as reference pressures and then monitored.

If you wish to cancel activation:

- ▶ Press the **-** button.

### Checking tire pressure electronically with the Advanced Tire Pressure Monitoring System (Advanced TPMS)\*, (Canada only)

The TPMS only functions on wheels that are equipped with the proper electronic sensors. It monitors the tire inflation pressure, as selected by the driver, in all four tires. A warning is issued to alert you to a decrease in pressure in one or more of the tires.

Tire pressure inquiries are made using the multifunction display. The present inflation pressures are displayed only after a few minutes' travel time.

**i** Possible differences between the readings of a tire pressure gauge of an air hose, e.g. gas station equipment, and the vehicle's control system can occur. Usually the readings issued by the control system are more precise.

- ▶ Switch on the ignition (▷ page 39).
- ▶ Press the **▲** or **▼** button until the current inflation pressures for each tire appear in the multifunction display.

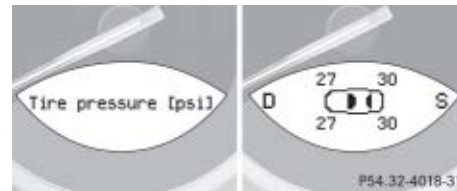

**i** When the message Tire pressure displayed after driving for a few minutes appears in the multifunction display, the individual inflation pressure values are matched with the tires. The individual values are displayed after a few minutes driving.

### Warning!



It is the driver's responsibility to calibrate the TPMS on the recommended cold inflation pressure. Underinflated tires affect the ability to steer or brake the vehicle. You might lose control over the vehicle.

**i** *With a spare wheel mounted, the system may still indicate the tire inflation pressure of the removed road wheel for some minutes. If this happens, keep in mind that the indicated value where the spare wheel is mounted does not reflect the actual spare tire inflation pressure.*

**Warning!**

The TPMS does not indicate a warning for wrongly selected inflation pressures. Always adjust tire inflation pressure according to the placard on the driver's door B-pillar or, if available, the supplemental tire pressure information on the inside of the fuel filler flap.

The TPMS is not able to issue a warning due to a sudden dramatic loss of pressure (e.g. tire blowout caused by a foreign object). In this case bring the vehicle to a halt by carefully applying the brakes and avoiding abrupt steering maneuvers.

**Warning!**

Each tire, including the spare (if provided), should be checked monthly when cold and inflated to the inflation pressure recommended by the vehicle manufacturer on the vehicle placard or the tire inflation pressure label. (If your vehicle has tires of a different size than the size indicated on the vehicle placard or the tire inflation pressure label, you should determine the proper tire inflation pressure for those tires).

As an added safety feature, your vehicle has been equipped with a tire pressure monitoring system (TPMS) that illuminates a low tire pressure telltale when one or more of your tires are significantly underinflated. Accordingly, when the low tire pressure telltale illuminates, you should stop and check your tires as soon as possible. Driving on a significantly underinflated tire causes the tire to overheat and can lead to tire failure.

Underinflation also reduces fuel efficiency and tire tread life, and may effect the vehicle's handling and stopping ability. Please note that the TPMS is not a substitute for proper tire maintenance, and it is the driver's responsibility to maintain correct tire pressure, even if under-inflation has not reached the level to trigger illumination of the TPMS low tire pressure telltale.

**i** *Operating radio transmission equipment (e.g. wireless headsets, two-way radios) in or near the vehicle could cause the TPMS to malfunction.*

## Tires and wheels

### Reactivating Advanced TPMS\*

The TPMS must be reactivated when you have adjusted the tire inflation pressure to a new level (e.g. because of different load or driving conditions). The TPMS is then recalibrated to the current tire inflation pressures.





#### Warning!



It is the driver's responsibility to calibrate the TPMS on the recommended cold inflation pressure. Underinflated tires affect the ability to steer or brake the vehicle. You might lose control over the vehicle.

- ▶ Using the tire placard on the driver's door B-pillar (▷ page 286) or, if available, the supplemental tire pressure information on the inside of the fuel filler flap (▷ page 292), make sure the tire inflation pressure of all four tires is correct.

**i** Reactivate the TPMS after adjusting the tire inflation pressure to the inflation pressure recommended for the vehicle operating condition. Tire pressure should only be adjusted on cold tires. Observe the recommended tire inflation pressure on the placard on the driver's door B-pillar (▷ page 286). Some vehicles may have supplemental tire pressure information for driving at high speeds (▷ page 292) or for vehicle loads less than the maximum loaded vehicle condition (▷ page 292). If such information is provided, it can be found on the inside of the fuel filler flap.

- ▶ Press button  or  on the multifunction steering wheel repeatedly until the standard display menu appears in the multifunction display (▷ page 139).
- ▶ Press the  or  button repeatedly until you see the current inflation pressures for each tire appear in the display or the following message appears in the display  
Tire pressure  
displayed after  
driving for  
a few minutes

- ▶ Press the reset button (▷ page 27).

The following message will appear in the multifunction display:

Restart tire  
pressure monitor?

- ▶ Press the  button.

The following message will appear in the multifunction display:

Tire pressure monitor restarted

After a few minutes driving, the current tire inflation pressure values are accepted as reference values and then monitored.

If you wish to cancel activation:

- ▶ Press the  button.

## Potential problems associated with underinflated and overinflated tires

### ***Underinflated tire inflation pressure***

Underinflated tires can:

- cause excessive and uneven tire wear
- adversely affect fuel economy
- lead to tire failure from being overheated
- adversely affect handling characteristics

### **Warning!**



Follow recommended tire inflation pressures.

Do not underinflate tires. Underinflated tires wear excessively and/or unevenly, adversely affect handling and fuel economy, and are more likely to fail from being overheated.

### ***Overinflated tire inflation pressure***

Overinflated tires can:

- adversely affect handling characteristics
- cause uneven tire wear
- be more prone to damage from road hazards
- adversely affect ride comfort
- increase stopping distance

### **Warning!**



Follow recommended tire inflation pressures.

Do not overinflate tires. Overinflated tires can adversely affect handling and ride comfort, wear unevenly, increase stopping distance, and result in sudden deflation (blowout) because they are more likely to become punctured or damaged by road debris, potholes etc.

### ***MOExtended system\****

The *MOExtended* system allows you to continue driving your vehicle even if there is a total loss of pressure in one or more tires.

You may only use the *MOExtended* system in conjunction with the Run Flat Indicator\* (Canada vehicles) (> page 293) or TPMS (U.S. vehicles) (> page 295).

For information on driving in case of pressure loss in one or more tires (emergency mode), see the “Operation” section (> page 413).

## Tires and wheels

### Tire labeling

Besides tire name (sales designation) and manufacturer name, a number of markings can be found on a tire.

Following are some explanations for the markings on your vehicle's tires:

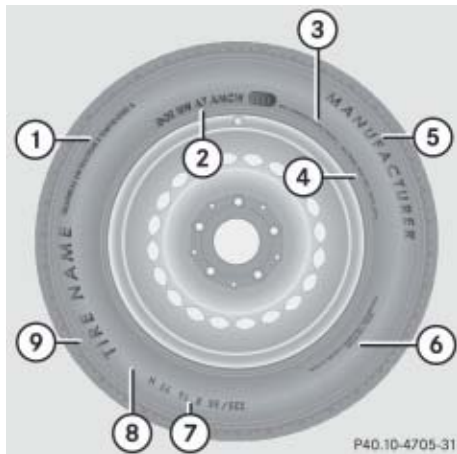

- ① Uniform Quality Grading Standards (▷ page 309)
- ② DOT, Tire Identification Number (TIN) (▷ page 307)
- ③ Maximum tire load (▷ page 308)
- ④ Maximum tire inflation pressure (▷ page 309)
- ⑤ Manufacturer
- ⑥ Tire ply material (▷ page 311)
- ⑦ Tire size designation, load and speed rating (▷ page 302)
- ⑧ Load identification (▷ page 306)
- ⑨ Tire name

**i** For illustration purposes only. Actual data on tires are specific to each vehicle and may vary from data shown in above illustration.

For more information, see “Rims and tires” (▷ page 435).

### Tire size designation, load and speed rating

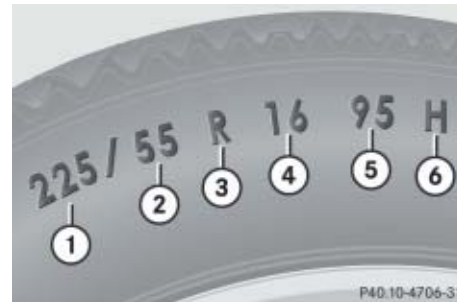

- ① Tire width
- ② Aspect ratio in %
- ③ Radial tire code
- ④ Rim diameter
- ⑤ Tire load rating
- ⑥ Tire speed rating

**i** For illustration purposes only. Actual data on tires are specific to each vehicle and may vary from data shown in above illustration.

**General:**

Depending on the design standards used, the tire size molded into the sidewall may have no letter or a letter preceding the tire size designation.

No letter preceding the size designation (as illustrated above): Passenger car tire based on European design standards.

Letter “P” preceding the size designation: Passenger car tire based on U.S. design standards.

Letter “LT” preceding the size designation: Light Truck tire based on U.S. design standards.

Letter “T” preceding the size designation: Temporary spare tires which are high pressure compact spares designed for temporary emergency use only.

***Tire width***

The tire width ① (▷ page 302) indicates the nominal tire width in mm.

***Aspect ratio***

The aspect ratio ② (▷ page 302) is the dimensional relationship between tire section height and section width and is expressed in percentage. The aspect ratio is arrived at by dividing section height by section width.

***Tire code***

The tire code ③ (▷ page 302) indicates the tire construction type. The “R” stands for radial tire type. Letter “D” means diagonal or bias ply construction; letter “B” means belted-bias ply construction.

At the tire manufacturer’s option, any tire with a speed capability above 149 mph (240 km/h) can include a “ZR” in the size designation (for example: 245/40 ZR 18). For additional information, see “Tire speed rating” (▷ page 304).

***Rim diameter***

The rim diameter ④ (▷ page 302) is the diameter of the bead seat, not the diameter of the rim edge. Rim diameter is indicated in inches (in).

***Tire load rating***

The tire load rating ⑤ (▷ page 302) is a numerical code associated with the maximum load a tire can support.

For example, a load rating of 91 corresponds to a maximum load of 1356 lbs (615 kg) the tire is designed to support. See also “Maximum tire load” (▷ page 308) where the maximum load associated with the load index is indicated in kilograms and lbs.



### Tires and wheels

#### Warning!



The tire load rating must always be at least half of the GAWR (▷ page 312) of your vehicle. Otherwise, tire failure may be the result which may cause an accident and/or serious personal injury to you or others.

Always replace rims and tires with the same designation, manufacturer and type as shown on the original part.

#### Warning!



Do not overload the tires by exceeding the specified load limit or vehicle capacity weight as indicated on the placard located on the driver's door B-pillar. Overloading the tires can overheat them, possibly causing a blowout. Overloading the tires can also result in handling or steering problems, or brake failure.

For additional information on tire load rating, see “Load identification” (▷ page 306).

**i** *Tire load rating ⑤ (▷ page 302) and tire speed rating ⑥ (▷ page 302) are also referred to as “service description”.*

#### **Tire speed rating**

The tire speed rating ⑥ (▷ page 302) indicates the approved maximum speed for the tire.

#### Warning!



Even when permitted by law, never operate a vehicle at speeds greater than the maximum speed rating of the tires.

Exceeding the maximum speed for which tires are rated can lead to sudden tire failure, causing loss of vehicle control and possibly resulting in an accident and/or personal injury and possible death, for you and for others.

**i** *Tire load rating ⑤ (▷ page 302) and tire speed rating ⑥ (▷ page 302) are also referred to as “service description”.*

## Summer tires

Index	Speed rating
Q	up to 100 mph (160 km/h)
R	up to 106 mph (170 km/h)
S	up to 112 mph (180 km/h)
T	up to 118 mph (190 km/h)
H	up to 130 mph (210 km/h)
V	up to 149 mph (240 km/h)
W	up to 168 mph (270 km/h)
Y	up to 186 mph (300 km/h)
(Y)	above 186 mph (300 km/h)
ZR	above 149 mph (240 km/h)

- At the tire manufacturer's option, any tire with a speed capability above 149 mph (240 km/h) can include a "ZR" in the size designation (for example: 245/40 ZR18). To determine the maximum speed capability of the tire, the service description for the tire must be referred to. The service description

is comprised of the tire load rating ⑤ (▷ page 302) and the tire speed rating ⑥ (▷ page 302).

If your tire includes "ZR" in the size designation and no service description ⑤ and ⑥ (▷ page 302) is given, the tire manufacturer must be consulted for the maximum speed capability.

If a service description ⑤ and ⑥ (▷ page 302) is given, the speed capability is limited by the speed symbol in the service description.

Example: 245/40 ZR18 97Y.

In this example, "97Y" is the service description. The letter "Y" designates the speed rating and the speed capability of the tire is limited to 186 mph (300 km/h).

- Any tire with a speed capability above 186 mph (300 km/h) must include a "ZR" in the size designation AND the service description must be placed in parenthesis. Example: 275/40 ZR 18 (99Y). The "(Y)" speed rating in parenthesis designates the maximum speed capability of the tire as being above 186 mph (300 km/h). Consult the tire manufacturer for the actual maximum permissible speed of the tire.

## Tires and wheels

All-season and winter tires

Index	Speed rating
Q M+S <sup>1</sup>	up to 100 mph (160 km/h)
T M+S <sup>1</sup>	up to 118 mph (190 km/h)
H M+S <sup>1</sup>	up to 130 mph (210 km/h)
V M+S <sup>1</sup>	up to 149 mph (240 km/h)

<sup>1</sup> or M+S  for winter tires

**i** Not all M+S rated tires provide special winter performance. Make sure the tires you use show M+S and the mountain/snowflake symbol  marking on the tire sidewall. These tires meet specific snow traction performance requirements of the Rubber Manufacturers Association (RMA) and the Rubber Association of Canada (RAC) and have been designed specifically for use in snow conditions.

### Load identification



① Load identification

**i** For illustration purposes only. Actual data on tires are specific to each vehicle and may vary from data shown in above illustration.

In addition to tire load rating, special load information may be molded into the tire sidewall following the letter designating the tire speed rating ① (▷ page 306).

No specification given: absence of any text (like in above example) indicates a standard load (SL) tire.

XL or Extra Load: designates an extra load (or reinforced) tire.

Light Load: designates a light load tire.

C, D, E: designates load range associated with the maximum load a tire can carry at a specified pressure.

## DOT, Tire Identification Number (TIN)

U.S. tire regulations require each new tire manufacturer or tire retreader to mold a TIN into or onto a sidewall of each tire produced.

The TIN is a unique identifier which facilitates efforts by tire manufacturers to notify purchasers in recall situations or other safety matters concerning tires and gives purchasers the means to easily identify such tires.

The TIN is comprised of “Manufacturer’s identification mark”, “Tire size”, “Tire type code” and “Date of manufacture”.



- ① DOT
- ② Manufacturer’s identification mark
- ③ Tire size
- ④ Tire type code (at the option of the tire manufacturer)
- ⑤ Date of manufacture

**i** For illustration purposes only. Actual data on tires are specific to each vehicle and may vary from data shown in above illustration.

## DOT (Department of Transportation)

A tire branding symbol ① (▷ page 307) which denotes the tire meets requirements of the U.S. Department of Transportation.

## Manufacturer’s identification mark

The manufacturer’s identification mark ② (▷ page 307) denotes the tire manufacturer.

New tires have a mark with two symbols.

Retreaded tires have a mark with four symbols. For more information on retreaded tires, see (▷ page 283).

## Tire size

The code ③ (▷ page 307) indicates the tire size.

### Tires and wheels

#### Tire type code

The code ④ (▷ page 307) may, at the option of the manufacturer, be used as a descriptive code for identifying significant characteristics of the tire.

#### Date of manufacture

The date of manufacture ⑤ (▷ page 307) identifies the week and year of manufacture.

The first two figures identify the week, starting with “01” to represent the first full week of the calendar year. The second two figures represent the year.

For example, “3202” represents the 32nd week of 2002.

#### Maximum tire load



#### ① Maximum tire load rating

**i** For illustration purposes only. Actual data on tires are specific to each vehicle and may vary from data shown in above illustration.

The maximum tire load is the maximum weight the tires are designed to support.

#### Warning!



Do not overload the tires by exceeding the specified load limit or vehicle capacity weight as indicated on the placard located on the driver's door B-pillar. Overloading the tires can overheat them, possibly causing a blowout. Overloading the tires can also result in handling or steering problems, or brake failure.

For more information on tire load rating (▷ page 303).

For information on calculating total and cargo load capacities (▷ page 288).

### Maximum tire inflation pressure



- ① Maximum permissible tire inflation pressure

**i** For illustration purposes only. Actual data on tires are specific to each vehicle and may vary from data shown in above illustration.

This is the maximum permissible tire inflation pressure for the tire.

Always follow the recommended tire inflation pressure (▷ page 291) for proper tire inflation.

### Warning!



Never exceed the max. tire inflation pressure. Follow recommended tire inflation pressures.

Do not underinflate tires. Underinflated tires wear excessively and/or unevenly, adversely affect handling and fuel economy, and are more likely to fail from being overheated.

Do not overinflate tires. Overinflated tires can adversely affect handling and ride comfort, wear unevenly, increase stopping distance, and result in sudden deflation (blowout) because they are more likely to become punctured or damaged by road debris, potholes etc.

### Uniform Tire Quality Grading Standards (U.S. vehicles)

Tire manufacturers are required to grade tires based on three performance factors: treadwear, traction and temperature resistance.

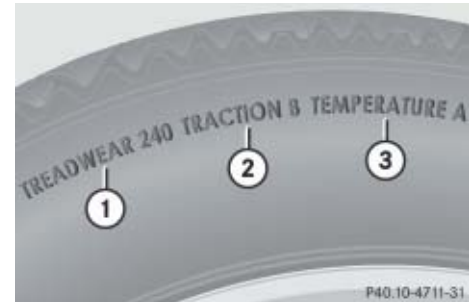

- ① Treadwear
- ② Traction
- ③ Temperature resistance

**i** For illustration purposes only. Actual data on tires are specific to each vehicle and may vary from data shown in above illustration.

### Tires and wheels

Quality grades can be found, where applicable, on the tire sidewall between tread shoulder and maximum section width. For example:

Treadwear	Traction	Temperature
200	AA	A

All passenger car tires must conform to federal safety requirements in addition to these grades.

#### Treadwear

The treadwear grade is a comparative rating based on the wear rate of the tire when tested under controlled conditions on a specified government test course. For example, a tire graded 150 would wear one and one-half ( $1\frac{1}{2}$ ) times as well on the government course as a tire graded 100. The relative performance of tires depends upon the actual conditions of their use, however, and may depart significantly from the norm due to variations in driving habits, service practices and differences in road characteristics and climate.

#### Traction

The traction grades, from highest to lowest, are AA, A, B, and C. Those grades represent the tire's ability to stop on wet pavement as measured under controlled conditions on specified government test surfaces of asphalt and concrete. A tire marked C may have poor traction performance.

#### Warning!



The traction grade assigned to this tire is based on straight-ahead braking traction tests, and does not include acceleration, cornering, hydroplaning, or peak traction characteristics.

## Temperature

The temperature grades are A (the highest), B, and C, representing the tire's resistance to the generation of heat and its ability to dissipate heat when tested under controlled conditions on a specified indoor laboratory test wheel. Sustained high temperature can cause the material of the tire to degenerate and reduce tire life, and excessive temperature can lead to sudden tire failure. The grade C corresponds to a level of performance which all passenger car tires must meet under the Federal Motor Vehicle Safety Standard No. 109.

Grades B and A represent higher levels of performance on the laboratory test wheel than the minimum required by law.

### Warning!



The temperature grade for this tire is established for a tire that is properly inflated and not overloaded. Excessive speed, underinflation, or excessive loading, either separately or in combination, can cause excessive heat build-up and possible tire failure.

## Tire ply material

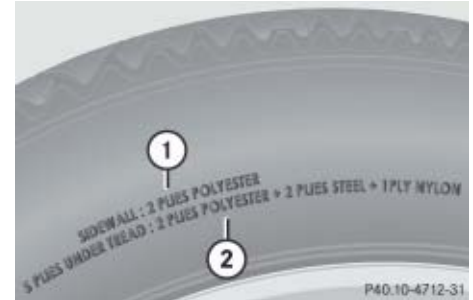

- ① Plies in sidewall
- ② Plies under tread

**i** For illustration purposes only. Actual data on tires are specific to each vehicle and may vary from data shown in above illustration.

This marking tells you about the type of cord and number of plies in the sidewall and under the tread.



### Tires and wheels

#### Tire and loading terminology

---

##### Accessory weight

The combined weight (in excess of those standard items which may be replaced) of automatic transmission, power steering, power brakes, power windows, power seats, radio, and heater, to the extent that these items are available as factory-installed equipment (whether installed or not).

##### Air pressure

The amount of air inside the tire pressing outward on each square inch of the tire. Air pressure is expressed in pounds per square inch (psi), or kilopascal (kPa) or bars.

##### Aspect ratio

Dimensional relationship between tire section height and section width expressed in percentage.

##### Bar

Another metric unit for air pressure. There are 14.5038 pounds per square inch (psi) to 1 bar; there are 100 kilopascals (kPa) to 1 bar.

##### Bead

The tire bead contains steel wires wrapped by steel cords that hold the tire onto the rim.

##### Cold tire inflation pressure

Tire inflation pressure when your vehicle has been sitting for at least 3 hours or driven no more than 1 mile (1.6 km).

##### Curb weight

The weight of a motor vehicle with standard equipment including the maximum capacity of fuel, oil, and coolant, and, if so equipped, air conditioning and additional optional equipment, but without passengers and cargo.

##### DOT (Department of Transportation)

A tire branding symbol which denotes the tire meets requirements of the U.S. Department of Transportation.

##### GAWR (Gross Axle Weight Rating)

The GAWR is the maximum permissible axle weight. The gross vehicle weight on each axle must never exceed the GAWR for the front and rear axle indicated on the certification label located on the driver's door B-pillar.

##### GVW (Gross Vehicle Weight)

The GVW comprises the weight of the vehicle including fuel, tools, spare wheel, installed accessories, passengers and cargo and, if applicable, trailer tongue load. The GVW must never exceed the GVWR indicated on the certification label located on the driver's door B-pillar.

**GVWR (Gross Vehicle Weight Rating)**

This is the maximum permissible vehicle weight of the fully loaded vehicle (weight of the vehicle including all options, passengers, fuel, and cargo and, if applicable, trailer tongue load). It is indicated on certification label located on the driver's door B-pillar.

**Kilopascal (kPa)**

The metric unit for air pressure. There are 6.9 kPa to 1 psi; another metric unit for air pressure is bars. There are 100 kilopascals (kPa) to 1 bar.

**Maximum load rating**

The maximum load in kilograms and pounds that can be carried by the tire.

**Maximum loaded vehicle weight**

The sum of curb weight, accessory weight, vehicle capacity weight and production options weight.

**Maximum tire inflation pressure**

This number is the greatest amount of air pressure that should ever be put in the tire under normal driving conditions.

**Normal occupant weight**

The number of occupants the vehicle is designed to seat, multiplied by 68 kilograms (150 lbs).

**Occupant distribution**

The distribution of occupants in a vehicle at their designated seating positions.

**Production options weight**

The combined weight of those installed regular production options weighing over 5 lbs (2.3 kilograms) in excess of those standard items which they replace, not previously considered in curb weight or accessory weight, including heavy duty brakes, ride levelers, roof rack, heavy duty battery, and special trim.

**PSI (Pounds per square inch)**

A standard unit of measure for air pressure -> bar, kilopascal (kPa).

**Recommended tire inflation pressure**

Recommended tire inflation pressure listed on placard located on driver's door B-pillar for normal driving conditions. Provides best handling, tread life and riding comfort.

**Rim**

A metal support for a tire or a tire and tube assembly upon which the tire beads are seated.

**Sidewall**

The portion of a tire between the tread and the bead.

### Tires and wheels

#### **TIN (Tire Identification Number)**

Unique identifier which facilitates efforts by tire manufacturers to notify purchasers in recall situations or other safety matters concerning tires and gives purchases the means to easily identify such tires. The TIN is comprised of “Manufacturer’s identification mark”, “Tire size”, “Tire type code” and “Date of manufacture”.

#### **Tire load rating**

Numerical code associated with the maximum load a tire can support.

#### **Tire ply composition and material used**

This indicates the number of plies or the number of layers of rubber-coated fabric in the tire tread and sidewall. Tire manufacturers also must indicate the ply materials in the tire and sidewall, which include steel, nylon, polyester, and others.

#### **Tire speed rating**

Part of tire designation; indicates the speed range for which a tire is approved.

#### **Traction**

Force exerted by the vehicle on the road via the tires. The amount of grip provided.

#### **Tread**

The portion of a tire that comes into contact with the road.

#### **Treadwear indicators**

Narrow bands, sometimes called “wear bars” that show across the tread of a tire when only  $\frac{1}{16}$  in (1.6 mm) of tread remains.

#### **Uniform Tire Quality Grading Standards**

A tire information system that provides consumers with ratings for a tire’s traction, temperature and treadwear. Ratings are determined by tire manufacturers using government testing procedures. The ratings are molded into the sidewall of the tire.

#### **Vehicle capacity weight**

Rated cargo and luggage load plus 68 kilograms (150 lbs) times the vehicle’s designated seating capacity.

#### **Vehicle maximum load on the tire**

Load on an individual tire that is determined by distributing to each axle its share of the maximum loaded vehicle weight and dividing it by two.

## Rotating tires

### Warning!



Rotate front and rear wheels only if the tires are of the same dimension.

If your vehicle is equipped with mixed-size tires (different tire dimensions front vs. rear), tire rotation is not possible.

Tire rotation can be performed on vehicles with tires of the same dimension all around. If your vehicle is equipped with tires of the same dimension all around, tires can be rotated, observing a front-to-rear rotation pattern that will maintain the intended rotation (spinning) direction of the tire (▷ page 286).

In some cases, such as when your vehicle is equipped with mixed-size tires (different tire dimension front vs. rear), tire rotation is not possible.

If applicable to your vehicle's tire configuration, tires can be rotated according to the tire manufacturer's recommended intervals in the tire manufacturer's warranty pamphlet located in your vehicle literature portfolio. If none is available, tires should be rotated every 3000 to 6000 miles (5000 to 10000 km), or sooner if necessary, according to the degree of tire wear. The same rotation (spinning) direction must be maintained (▷ page 286).

Rotate tires before the characteristic tire wear pattern becomes visible (shoulder wear on front tires and tread center wear on rear tires).

Thoroughly clean the mounting face of wheels and brake disks, i.e. the inner side of the wheels/tires, during each rotation. Check for and ensure proper tire inflation pressure.

### Warning!



Have the tightening torque checked after changing a wheel. Wheels could become loose if not tightened with a torque of 96 lb-ft (130 Nm).

Only use genuine Mercedes-Benz wheel bolts specified for your vehicle's rims.

For information on wheel change, see the "Practical hints" section (▷ page 388) and (▷ page 405).

### Winter driving

Before the onset of winter, have your vehicle winterized at an authorized Mercedes-Benz Center. This service includes:

- Check of anticorrosion and antifreeze concentration.
- Addition of cleaning concentrate to the water of the windshield and headlamp cleaning system. Add MB Concentrate “S” to a pre-mixed windshield washer solvent/antifreeze which is formulated for temperatures below freezing point (▷ page 451).
- Battery test. Battery capacity drops with decreasing ambient temperature. A well charged battery helps to ensure that the engine can be started and the electro-hydraulic brake system will be fully operational even at low ambient temperatures.
- Tire change.

**!** *When scraping ice or snow from the rear window, be careful not to damage the sealing strip or apertures along the side of the window.*

### Winter tires

---

Always use winter tires at temperatures below 45°F (7°C) and whenever wintry road conditions prevail. Not all M+S rated tires provide special winter performance. Make sure the tires you use show M+S and the mountain/snowflake symbol  marking on the tire sidewall.

These tires meet specific snow traction performance requirements of the Rubber Manufacturers Association (RMA) and the Rubber Association of Canada (RAC) and have been designed specifically for use in snow conditions. Use of winter tires is the only way to achieve the maximum effectiveness of the ABS and ESP® in winter operation.

For safe handling, make sure all winter tires mounted are of the same make and have the same tread design.

**Warning!**

Winter tires with a tread depth of less than  $\frac{1}{6}$  in (4 mm) must be replaced. They are no longer suitable for winter operation.

Always observe the speed rating of the winter tires installed on your vehicle. If the maximum speed for which your tires are rated is below the speed rating of your vehicle, you must place a notice to this effect where it will be seen by the driver. Such notices are available at your tire dealer or any authorized Mercedes-Benz Center.

**Warning!**

If you use your spare tire when winter tires are fitted on the other wheels, be aware that the difference in tire characteristics may very well impair turning stability and that overall driving stability may be reduced. Adapt your driving style accordingly.

Have the spare tire replaced with a winter tire at the nearest authorized Mercedes-Benz Center.

**Block heater (Canada only)**

The engine is equipped with a block heater.

The electrical cable may be installed at an authorized Mercedes-Benz Center.

 *Block heater not available for SL 55 AMG and SL 65 AMG.*

### Winter driving

#### Snow chains

---

**!** *When driving with snow chains, always select setting 1 of the level control system (▷ page 225). Other settings may result in damage to your vehicle.*

**!** *Some tire sizes do not leave adequate clearance for snow chains. To help avoid serious damage to your vehicle or tires, use of snow chains is not permissible with*

- 285/35 R18 97W
- 285/35 R18 97Y
- 285/35 ZR18 97Y
- 285/30 ZR19 98Y XL (Extra Load)

Snow chains should only be driven on snow-covered roads at speeds not to exceed 30 mph (50 km/h). Remove chains as soon as possible when driving on roads without snow.

Please observe the following guidelines when using snow chains:

- Use of snow chains is not permissible with all wheel/tire combinations (▷ page 435).
- Use snow chains in pairs and on rear wheels only. Follow the manufacturer's mounting instructions.

**!** *If snow chains are mounted to the front wheels, they may scrape against the body or axle components. The tires or the vehicle could be damaged as a result.*

- Only use snow chains that are approved by Mercedes-Benz. Any authorized Mercedes-Benz Center will be glad to advise you on this subject.

- Use of snow chains may be prohibited depending on location. Always check local and state laws before installing snow chains.
- Do not use snow chains on the spare wheel (▷ page 440).
- Do not use snow chains on wheels with MOExtended tires\* (▷ page 439).

**i** *When driving with snow chains, you may wish to deactivate the ESP® (▷ page 91) before setting the vehicle in motion. This will improve the vehicle's traction.*

## ▼ Maintenance

We strongly recommend that you have your vehicle serviced by an authorized Mercedes-Benz Center, in accordance with the Maintenance Booklet at the times called for by the maintenance service indicator.

Failure to have the vehicle maintained in accordance with the Maintenance Booklet and the maintenance service indicator at the designated times/mileage may result in vehicle damage not covered by the Mercedes-Benz Limited Warranty.

### Maintenance service indicator message

The maintenance service indicator message will notify you when your next maintenance service is due.

Starting approximately 1 month before your next maintenance service is due, one of the following messages will appear in the right multifunction display while you are driving or when you switch on the ignition (example service A):

Service A in XXXXX miles (km)

Service A in XXX days

Service A Due now

The type of maintenance service due is indicated in the left multifunction display:



Basic service (A)



Extended service (B)

**i** *Vehicles equipped with Maintenance System (U.S. vehicles) only: The Maintenance System tracks distance driven and the time elapsed since the last maintenance service, calculates other maintenance service work required, and calls for the next maintenance service accordingly.*

**i** *Vehicles equipped with FSS (Flexible Service System) only (Canada vehicles): The interval between maintenance services depends on your driving habits. A gentle driving style, moderate engine speeds and the avoidance of short-distance trips will lengthen the interval between services.*

### Clearing the maintenance service indicator message

The maintenance service indicator message is automatically cleared after approximately 30 seconds

- after you have switched on the ignition
- after you have reached the maintenance service threshold while driving

You can also clear the maintenance service indicator message yourself.





### ① Reset button

- ▶ Press reset button ① on the instrument cluster.

The maintenance service indicator message is cleared and the standard display appears in the multifunction display (▷ page 145).

### Maintenance service term exceeded

If you have exceeded the suggested maintenance service term, you will see the following message in the right multifunction display:

Service A exceeded by XXXX miles (km)  
Service A exceeded by XXX days







In addition, a signal sounds when the message appears.

Any authorized Mercedes-Benz Center will reset the maintenance service indicator following a completed maintenance service.

### Calling up the maintenance service indicator display

**i** The menu overview can be found on (▷ page 142).

You can call up the maintenance service indicator display at any time to check when the next maintenance service is due.

- ▶ Switch on the ignition (▷ page 39).
- ▶ Press button  or  on the multifunction steering wheel repeatedly until the standard display appears in the multifunction display (▷ page 145).
- ▶ Press button  or  on the multifunction steering wheel until the maintenance service indicator display with the maintenance service symbol  or  appears in the left multifunction display and the maintenance service deadline appears in the right multifunction display.

**i** *If the battery supplying the vehicle's electrical consumers is disconnected, the days of disconnection will not be included in the count shown by the maintenance service indicator. To arrive at the true maintenance service deadline, you will need to subtract these days from the days shown in the maintenance service indicator message or maintenance service indicator display.*

*Do not confuse the maintenance service indicator with the engine oil level indicator .*

## Resetting the maintenance service indicator

---

In the event that the maintenance service on your vehicle is not carried out by an authorized Mercedes-Benz Center, you can have the maintenance service indicator reset. The automotive maintenance facility carrying out the maintenance service will find the information for resetting the maintenance service indicator in the maintenance-relevant information for your vehicle. Such information is available either from an authorized Mercedes-Benz Center or directly from Mercedes-Benz.

**!** *If the maintenance service indicator was inadvertently reset, have an authorized Mercedes-Benz Center correct it.*

*Only reset if the proper maintenance service has been performed. Resetting the system without performing proper maintenance service as called for by the maintenance service indicator will result in engine damage and/or other vehicle damage not covered by the Mercedes-Benz Limited Warranty.*

### Cleaning and care of the vehicle

Regular and proper care will help to maintain the value of your vehicle. The best way to protect your vehicle from harmful environmental influences is to wash it and use protective treatments regularly.

#### Warning!



Many cleaning products can be hazardous. Some are poisonous, others are flammable. Always follow the instructions on the particular container. Always open your vehicle's doors or windows when cleaning the inside.

Never use fluids or solvents that are not designed for cleaning your vehicle.

Always lock away cleaning products and keep them out of reach of children.

While in operation, even while parked, your vehicle is subjected to varying external influences which, if gone unchecked, can attack the paintwork as well as the vehicle underbody and cause lasting damage.

Such damage is caused not only by extreme and varying climatic conditions, but also by:

- Air pollution
- Road salt
- Tar
- Gravel and stone chipping

To avoid paint damage, you should immediately remove:

- Grease and oil
- Fuel
- Coolant
- Brake fluid
- Bird droppings
- Insects
- Tree resins, etc.

Frequent washing reduces and/or eliminates the aggressiveness and potency of the above adverse influences.

More frequent washings are necessary to deal with unfavorable conditions:

- near the ocean
- in industrial areas (smoke, exhaust emissions)
- during winter operation

You should check your vehicle from time to time for stone chipping or other damage. Any damage should be repaired as soon as possible to prevent corrosion.

In doing so, do not neglect the underbody of the vehicle. A prerequisite for a thorough check is a washing of the underbody followed by a thorough inspection. Damaged areas need to be re-undercoated.

Your vehicle has been treated at the factory with a wax-base rustproofing in the body cavities which will last for the lifetime of the vehicle. Post-production treatment is neither necessary nor recommended by Mercedes-Benz because of the possibility of incompatibility between materials used in the production process and others applied later.

We have selected car-care products and compiled recommendations which are specially matched to our vehicles and which always reflect the latest technology. You can obtain Mercedes-Benz approved car-care products at an authorized Mercedes-Benz Center.

Scratches, corrosive deposits, corrosion or damage due to negligent or incorrect care cannot always be removed or repaired with the car-care products recommended here. In such cases it is best to seek aid at an authorized Mercedes-Benz Center.

The following topics deal with the cleaning and care of your vehicle and give important “how-to” information as well as references to Mercedes-Benz approved car-care products.

### Power washer

**!** Follow the instructions provided by the power washer manufacturer on maintaining a distance between the vehicle and the nozzle of the power washer.

*Never use a round nozzle to power-wash tires. The intense jet of water can result in damage to the tire.*

*Always replace a damaged tire.*

*Always keep the jet of water moving across the surface. Do not aim directly at electrical parts, electrical connectors, seals, or other rubber parts.*

**i** *Vehicles with KEYLESS-GO\*: If a door handle is hit by a strong jet of water, and a SmartKey with KEYLESS-GO\* is in close proximity, i.e. within approximately 3 ft (1 m), the vehicle could be inadvertently locked or unlocked.*

### Tar stains

Quickly remove tar stains before they dry and become more difficult to remove. A tar remover is recommended.

### Paintwork, painted body components

**!** *Affixing stickers, magnets, adhesive tape or similar materials to painted body components may damage the paintwork.*

Mercedes-Benz approved Paint Care should be applied when water drops on the paint surface do not “bead up”. This should normally be done every 3 to 5 months, depending on climate and washing detergent used.

Mercedes-Benz approved Paint Cleaner should be applied if the paint surface shows signs of embedded dirt (i.e. loss of gloss).

Do not apply any of these products or wax if your vehicle is parked in the sun or if the hood is still hot.

- ▶ Use the appropriate MB-Touch-Up Stick for quick and provisional repairs of minor paint damage (i.e. chips from stones, vehicle doors, etc.).

## Vehicle care

### Engine cleaning

Prior to cleaning the engine compartment, make sure to protect electrical components and connectors from contact with water and cleaning agents.

Corrosion protection, such as MB Anticorrosion Wax, should be applied to the engine compartment after every engine cleaning. Before applying, all control linkage bushings and joints should be lubricated. The poly-V-belt and all pulleys should be protected from any wax.

### Vehicle washing

In the winter, thoroughly remove all traces of road salt as soon as possible.

When washing the underbody, do not forget to clean the inner sides of the wheels.

**i** *Vehicles with KEYLESS-GO\*: If a door handle is hit by a strong jet of water, and a SmartKey with KEYLESS-GO\* is in close proximity, i.e. within approximately 3 ft (1 m), the vehicle could be inadvertently locked or unlocked.*

### Hand-wash

Do not use hot water or wash your vehicle in direct sunlight.

- ▶ Only use a mild car wash detergent, such as Mercedes-Benz approved Car Shampoo.
- ▶ Thoroughly spray the vehicle with a diffused jet of water.

Direct only a very weak spray towards the ventilation intake.

- ▶ Use plenty of water and rinse the sponge and chamois frequently.
- ▶ Rinse with clean water and thoroughly dry with a chamois.

Do not allow cleaning agents to dry on the finish.

**!** *Do not use scouring agents on these parts. Never apply strong force and only use a soft, non-scratching cloth when cleaning the vehicle. Do not attempt to wipe the surface with a dry cloth or sponge.*

*Otherwise you may scratch or damage the paint.*

### Automatic car wash

You can have your car washed in an automatic car wash from the start. Automatic car washes without brushes are preferable.

- ▶ To protect the filter system, switch the automatic climate control to air recirculation mode (▷ page 191).

**!** *Do not clean your vehicle in an automatic touchless car wash which uses caustic spray. Otherwise, the caustic spray will damage the paint or ornamental moldings.*

If the vehicle is very dirty, prewash it before running it through the automatic car wash.

**!** *Make sure that the windshield wiper switch is set to 0 (▷ page 57). Otherwise, the rain sensor could activate and cause the wipers to move unintentionally. This may lead to vehicle damage.*

*Due to the width of the vehicle, fold in exterior rear view mirrors prior to running the vehicle through an automatic car wash to prevent damage to the mirrors.*

**i** After running the vehicle through an automatic car wash, wipe any wax off of the windshield (▷ page 326). This will prevent smears and reduce wiping noise which can be caused by residual wax on the windshield.

When leaving the car wash, make sure that the mirrors are folded out. Otherwise they may vibrate.

### Ornamental moldings

For regular cleaning and care of ornamental moldings, use a damp cloth.

**!** Do not use chrome cleaner on ornamental moldings. Although ornamental moldings may have chrome appearance, they could be made of anodized aluminum that will be damaged when cleaned with chrome cleaner. Instead, use damp cloth to clean those ornamental moldings.

Very dirty ornamental moldings of which you are sure are chrome-plated, use a chrome cleaner. If in doubt whether an ornamental molding is chrome-plated, contact an authorized Mercedes-Benz Center.

### Headlamps, tail lamps, side markers, turn signal lenses

► Use a mild car wash detergent, such as Mercedes-Benz approved Car Shampoo, with plenty of water.

**!** Only use window cleaning solutions that are suitable for plastic lamp lenses. Window cleaning solutions which are not suitable may damage the plastic lamp lenses of the headlamps. Therefore, do not use abrasives, solvents or cleaners that contain solvents.

Never apply strong force and only use a soft, non-scratching cloth when cleaning the lenses. Do not attempt to wipe dirty lenses with a dry cloth or sponge.

Otherwise you may scratch or damage the lens surface.

### Cleaning the DISTRONIC\* system sensor cover



① DISTRONIC\* system sensor cover

- Switch off the ignition (▷ page 39).
- Use a mild car wash detergent, such as Mercedes-Benz approved Car Shampoo, with plenty of water and a non-scratching cloth to clean sensor cover ①.



### Vehicle care

▷▷ **!** To prevent scratches or damage, never apply strong force and only use a soft, non-scratching cloth when cleaning Distronic system sensor cover ①. Do not attempt to wipe dirty sensor with a dry cloth or sponge.

- ▶ Restart the engine after cleaning sensor cover ①.

#### Cleaning the Parktronic system\* sensors



- ① Parktronic system\* sensors in front bumper

- ▶ Use a mild car wash detergent, such as Mercedes-Benz approved Car Shampoo, with plenty of water and a soft, non-scratching cloth to clean sensors ① on the bumpers.

**!** Do not apply strong pressure to the sensor covers. Applying strong pressure may damage the sensor covers.

Follow the instructions provided by the power washer manufacturer on maintaining a distance between the vehicle and the nozzle of the power washer.

**!** To prevent scratches, never apply strong force and only use a soft, non-scratching cloth when cleaning the sensors. Do not attempt to wipe dirty sensors with a dry cloth or sponge.

#### Cleaning the windows and the wiper blades

**!** The windshield wipers must be in a vertical position before folding them away from the windshield. They could otherwise damage the hood.

Never open the hood when the wiper arms are folded forward.

- ▶ Make sure the hood is fully closed.
- ▶ Switch on the ignition (▷ page 39).
- ▶ Turn combination switch to wiper setting II (▷ page 57).
- ▶ With wiper arms in vertical position, switch off the ignition (▷ page 39).

**Warning!**

For safety reasons, switch off wipers and remove SmartKey from starter switch (vehicles with KEYLESS-GO\*: Make sure the vehicle's on-board electronics have status **0**.) before cleaning the windshield and/or the wiper blades. Otherwise, the wiper motor could suddenly turn on and cause injury.

- ▶ Fold the wiper arms forward until they snap into place.

**!** Do not pull on the wiper blade inserts. They could tear.

- ▶ Clean the wiper blade inserts with a clean cloth and detergent solution.
- ▶ Use a soft, clean cloth and a mild window cleaning solution on all outside and inside glass surfaces.

An automotive glass cleaner is recommended.

**!** Fold the windshield wiper arms back onto the windshield before turning the SmartKey in the starter switch or pressing the KEYLESS-GO start/stop button (vehicles with KEYLESS-GO\*).

*Hold on to the wiper when folding the wiper arm back. If released, the force of the impact from the tensioning spring could crack the windshield.*

**!** To clean the window interior, do not use a dry cloth, abrasives, solvents or cleaners containing solvents. Do not touch the inside of the front, rear or side windows with hard objects such as an ice scraper or ring. Doing so may damage the windows.

**Rear window cleaning**

Clean the rear window with the hardtop fully raised and closed.

**Warning!**

Do not clean the rear window with the hardtop in a position other than the fully raised and closed position. Otherwise, the hardtop may move unexpectedly which may result in personal injury to you or others.

- ▶ Use a soft, clean cloth and a mild window cleaning solution on all outside and inside glass surfaces.

An automotive glass cleaner is recommended.



### Vehicle care

#### Light alloy wheels

If possible, clean wheels once a week.

- ▶ Use Mercedes-Benz approved Wheel Care, a soft bristle brush and a strong spray of water for cleaning the light alloy wheels.

**!** Only use acid-free cleaning materials. Acid may cause corrosion or damage the clear coat.

**!** The vehicle should not be parked for an extended period of time immediately after it has been cleaned, especially not after the wheel rims have been cleaned with wheel rim cleaner.

Wheel rim cleaners can lead to increased corrosion of the brake disks and brake pads. Therefore, the vehicle's brake system should always be warmed-up before it is parked after cleaning. To do so, please drive your vehicle for several minutes to allow the brakes to dry.

When applying Mercedes-Benz approved Tire Care and Mercedes-Benz approved Wheel Care products, take care not to spray them on the brake disks.

#### Plastic and rubber parts

- ▶ Use a gentle dishwashing detergent or mild detergent for delicate fabrics as a washing solution.
- ▶ Wipe with a cloth moistened in a luke-warm solution.

The surface may temporarily change color. If this is the case, wait for it to dry.

#### Warning!



Do not use cleaners containing solvents or cockpit care sprays to clean the cockpit or the steering wheel boss. Cleaners containing solvents will make the surface porous and vehicle occupants could suffer serious injuries from plastic parts coming loose in the event of air bag deployment.

**!** Do not use oil, wax or scouring agents on these parts.

Never apply strong force and only use a soft, non-scratching cloth when cleaning the surface. Do not attempt to wipe the surface with a dry cloth or sponge.

Otherwise you may scratch or damage the surface.

#### Hard plastic trim items

- ▶ Use Mercedes-Benz approved Interior Care, a soft, lint-free cloth and apply with light pressure.

**!** Never apply strong force and only use a soft, non-scratching cloth when cleaning the surface. Do not attempt to wipe the surface with a dry cloth or sponge.

Otherwise you may scratch or damage the surface.

#### Steering wheel and gear selector lever

- ▶ Wipe with a damp cloth and dry thoroughly or clean with Mercedes-Benz approved Leather Care.

## Carpets

- ▶ Use Mercedes-Benz approved Carpet and Fabric Care for cleaning the carpets.

## Headliner

- ▶ Use a soft bristle brush or a dry-shampoo cleaner in case of excessive dirt.

## Seat belts

- ▶ Only use clear, lukewarm water and soap.

**!** *The seat belts must not be treated with chemical cleaning agents. Do not dry the seat belts at temperatures above 176 °F (80 °C) or in direct sunlight.*

### Warning!



Do not bleach or dye seat belts as this may severely weaken them. In a crash they may not be able to provide adequate protection.

## Upholstery

Using aftermarket seat covers or wearing clothing that have the tendency to give off coloring (e.g. when wet, etc.) may cause the upholstery to become permanently discolored. By lining the seats with a proper intermediate cover, contact-discoloration will be prevented.

### Warning!



Only use seat or head restraint covers which have been tested and approved by Mercedes-Benz for your vehicle model. Using other seat or head restraint covers may interfere with or prevent the activation of the active head restraints. Contact an authorized Mercedes-Benz Center for availability.

## Leather upholstery

- ▶ Wipe leather upholstery with a damp cloth and dry thoroughly or clean with Mercedes-Benz approved Leather Care.

Exercise particular care when cleaning perforated leather as its underside should not become wet.

## Wood trims

- ▶ Dampen cloth using water and use damp cloth to clean wood trims in your vehicle.

**!** *Do not use solvents like tar remover or wheel cleaner nor polishes or waxes as these may be abrasive.*





**What to do if ...**

**Where will I find ...?**

**Locking/unlocking in an emergency**

**Replacing SmartKey batteries**

**Replacing bulbs**

**Replacing wiper blades**

**Flat tire**

**Batteries**

**Jump starting**

**Towing the vehicle**

**Fuses**

## What to do if ...

### Lamps in the instrument cluster

General information:

If any of the following lamps in the instrument cluster fails to come on during the



bulb self-check when switching on the ignition, have the respective bulb checked and replaced if necessary.

Problem	Possible cause/consequence	Suggested solution
<p> The yellow ABS/ESP® warning lamp comes on while driving.</p>	<p>The ESP® has been switched off. Risk of accident!</p> <p>When the ESP® is switched off it will not stabilize the vehicle if the system recognizes that the vehicle starts to skid or that a wheel is spinning.</p>	<ul style="list-style-type: none"> <li>▶ Switch the ESP® back on (▷ page 92). Exceptions: (▷ page 91).</li> <li>▶ If leaving the ESP® switched off, adapt your speed and driving to the prevailing road and weather conditions.</li> </ul> <p>If the ESP® cannot be switched on:</p> <ul style="list-style-type: none"> <li>▶ Have the system checked at an authorized Mercedes-Benz Center as soon as possible.</li> </ul>
	<p>The ESP® is not operational due to a malfunction. Risk of accident!</p>	<ul style="list-style-type: none"> <li>▶ Observe additional messages in the multifunction display.</li> <li>▶ Continue driving with added caution.</li> <li>▶ Adapt your speed and driving to the prevailing road and weather conditions.</li> <li>▶ Have the system checked at an authorized Mercedes-Benz Center as soon as possible.</li> </ul>

Problem	Possible cause/consequence	Suggested solution
 <p>The yellow ABS/ESP® warning lamp flashes while driving.</p>	<p>The ESP®, ABS, or traction control has come into operation because of detected traction loss in at least one tire.</p> <p>The cruise control and the Distronic* system are deactivated.</p>	<ul style="list-style-type: none"> <li>▶ When driving off, apply as little throttle as possible.</li> <li>▶ While driving, ease up on the accelerator.</li> <li>▶ Adapt your speed and driving to the prevailing road and weather conditions.</li> <li>▶ Do not deactivate the ESP®. Exceptions: (▷ page 91).</li> </ul> <p>Failure to follow these instructions increases the risk of an accident.</p>

### What to do if ...

Problem	Possible cause/consequence	Suggested solution
 <p>The yellow ABS indicator lamp comes on while driving.</p>	<p>The ABS has detected a malfunction and has switched off. The BAS and the ESP® are also switched off (see messages in display).</p> <p>The electro-hydraulic brake system is still functioning normally but without ABS available.</p> <p>If the ABS control unit is malfunctioning, other systems such as Parktronic*, DISTRONIC*, or the automatic transmission may also be malfunctioning.</p> <p>The charging voltage has fallen below 10 volts and the ABS was switched off.</p> <p>The battery may not be sufficiently charged.</p>	<ul style="list-style-type: none"> <li>▶ Continue driving with added caution. Wheels may lock during hard braking, reducing steering capability.</li> <li>▶ Have the system checked at an authorized Mercedes-Benz Center as soon as possible.</li> </ul> <p>Failure to follow these instructions increases the risk of an accident.</p> <ul style="list-style-type: none"> <li>▶ Read and observe messages in the display (▷ page 347).</li> <li>▶ Switch off electrical consumers that are currently not needed, e.g. seat heating.</li> <li>▶ If necessary, have the generator and battery checked.</li> </ul> <p>When the voltage is above this value again, the ABS is operational again.</p>

Problem	Possible cause/consequence	Suggested solution
<p><b>BRAKE</b> (USA only)</p> <p> (Canada only)</p> <p>The red brake warning lamp comes on while driving and you hear a warning sound.</p>	<p>You are driving with the parking brake set.</p>	<p>▶ Release the parking brake (▷ page 54).</p>
<p><b>BRAKE</b> (USA only)</p> <p> (Canada only)</p> <p>The red brake warning lamp comes on when the engine is running and you hear a warning sound.</p>	<ul style="list-style-type: none"> <li>• There is a malfunction in the electro-hydraulic brake system.</li> <li>• There is insufficient brake fluid in the reservoir.</li> </ul>	<ul style="list-style-type: none"> <li>▶ Read and observe messages in the display (▷ page 347).</li> <li>▶ Risk of accident! Carefully stop the vehicle in a safe location or as soon as it is safe to do so and notify an authorized Mercedes-Benz Center. Do not add brake fluid! This will not solve the problem.</li> </ul>

**Warning!**





Driving with the brake warning lamp illuminated can result in an accident. Have your brake system checked immediately if the brake warning lamp stays on. Do not add brake fluid before checking the brake system.





Overfilling the brake fluid reservoir can result in spilling brake fluid on hot engine parts and the brake fluid catching fire. You can be seriously burned.

**!** *If you find that the brake fluid in the brake fluid reservoir has fallen to the minimum mark or below, have the brake system checked for brake pad thickness and leaks.*



### What to do if ...

Problem	Possible cause/consequence	Suggested solution
<p> (USA only)</p> <p> (Canada only)</p> <p>The yellow engine malfunction indicator lamp comes on while driving.</p>	<p>There is a malfunction in:</p> <ul style="list-style-type: none"> <li>• The fuel injection system</li> <li>• The ignition system</li> <li>• The emission control system</li> <li>• Systems which effect emissions</li> </ul> <p>Such malfunctions may result in excessive emissions values and may switch the engine to its limp-home (emergency operation) mode.</p> <p>The fuel cap is not closed tightly.</p>	<p>▶ Have the vehicle checked as soon as possible by an authorized Mercedes-Benz Center.</p> <p>An on-board diagnostic connector is used by the service station to link the vehicle to the shop diagnostics system. It allows the accurate identification of system malfunctions through the readout of diagnostic trouble codes. It is located in the front left area of the footwell next to the parking brake pedal.</p> <p>▶ Check the fuel cap (▷ page 271).</p> <p>If it is not closed properly:</p> <p>▶ Close the fuel cap.</p> <p>If it is closed properly:</p> <p>▶ Have the fuel system checked by an authorized Mercedes-Benz Center.</p>

Problem	Possible cause/consequence	Suggested solution
 (USA only)  (Canada only) The yellow engine malfunction indicator lamp comes on while driving.	Your fuel tank is empty.	<ul style="list-style-type: none"> <li>▶ After refueling, start, turn off, and re-start the engine three or four times in succession.</li> <li>The limp-home mode is canceled. You do not need to have your vehicle checked.</li> </ul>
 The red coolant warning lamp comes on when the engine is running.	There is insufficient coolant in the reservoir.  If this warning lamp comes on frequently, there is a leak in the cooling system.  If the coolant level is correct, the electric radiator fan may be broken.	<ul style="list-style-type: none"> <li>▶ Immediately add coolant to prevent engine from overheating (▷ page 280).</li> <li>▶ Have the cooling system checked.</li> <li>▶ If the coolant temperature is below 248 °F (120 °C), you can continue driving to the nearest authorized Mercedes-Benz Center.</li> <li>▶ Avoid high engine loads (e.g. driving uphill) and stop-and-go driving.</li> </ul>
 The red coolant warning lamp comes on while driving and you hear a warning sound.	The coolant temperature has exceeded 248 °F (120 °C).	<ul style="list-style-type: none"> <li>▶ Stop in a safe location as soon as possible and allow the engine and coolant to cool down.</li> </ul>

### What to do if ...

#### Warning!





Driving when your engine is overheated can cause some fluids which may have leaked into the engine compartment to catch fire. You could be seriously burned.

Steam from an overheated engine can cause serious burns and can occur just by opening the engine hood. Stay away from the engine if you see or hear steam coming from it.

Turn off the engine, get out of the vehicle and do not stand near the vehicle until the engine has cooled down.

During severe operating conditions, e.g. stop-and-go traffic, the coolant temperature may rise close to 248°F (120°C).

**!** *The engine should not be operated with the coolant temperature above 248°F (120°C). Doing so may cause serious engine damage which is not covered by the Mercedes-Benz Limited Warranty.*

Problem	Possible cause/consequence	Suggested solution
 <p>The white DISTRONIC* indicator lamp comes on while driving.</p>	<p>The DISTRONIC* distance sensor has recognized a preceding vehicle.</p>	
 <p>The red distance warning lamp comes on while driving and you hear a warning sound.</p>	<ul style="list-style-type: none"> <li>• You are gaining too rapidly on the vehicle ahead of you.</li> <li>• The distance warning system has recognized a stationary obstacle on your probable line of travel.</li> </ul>	<ul style="list-style-type: none"> <li>▶ Apply the brakes immediately.</li> <li>▶ Carefully observe the traffic situation. You may need to brake or maneuver to avoid hitting an obstacle.</li> </ul>
 <p>The yellow fuel tank reserve warning lamp lights while driving.</p>	<p>The fuel level has dropped below the reserve mark.</p>	<ul style="list-style-type: none"> <li>▶ Refuel at the next gas station (▷ page 271).</li> </ul>
	<p>The fuel cap is not closed tightly.</p>	<ul style="list-style-type: none"> <li>▶ Check the fuel cap (▷ page 271).</li> </ul>



### What to do if ...

Problem	Possible cause/consequence	Suggested solution
 The yellow roll bar warning lamp comes on or flickers when the engine is running.	The roll bar system is malfunctioning.	For safety reasons, always have the roll bar raised when driving with the retractable hardtop open. <ul style="list-style-type: none"><li>▶ Attempt to raise the roll bar manually (▷ page 81).</li><li>▶ Have the roll bar checked by an authorized Mercedes-Benz Center as soon as possible.</li></ul>

#### Warning!



If the roll bar warning lamp does not come on, does not go out after a long time, flickers or comes on while driving as described above, then the roll bar system is not operating properly and may not activate in an accident. In this case, raise the roll bar manually (▷ page 81) before continuing to drive.

Problem	Possible cause/consequence	Suggested solution
 The red seat belt telltale comes on and a warning chime sounds for approximately 6 seconds after starting the engine with all doors closed.	The seat belt telltale reminds you and your passengers to fasten your seat belts before driving off.	<ul style="list-style-type: none"> <li>▶ Fasten your seat belts.</li> </ul> <p>The seat belt telltale goes out.</p>
 The red seat belt telltale remains illuminated after driving off. The vehicle's speed does not exceed 15 mph (25 km/h).	You and/or your front passenger have forgotten to fasten your seat belts.	▶ Fasten your seat belts.
	There are items placed on the front passenger seat and therefore the system senses the front passenger seat as being occupied.	▶ Remove the items from the front passenger seat and put them in a safe place.
 The red seat belt telltale flashes and you additionally hear an intermittent warning chime with increasing intensity for a maximum of 60 seconds from the time the vehicle's speed exceeds 15 mph (25 km/h).	You and/or your front passenger have forgotten to fasten your seat belts.	▶ Fasten your seat belts.
	There are items placed on the front passenger seat and therefore the system senses the front passenger seat as being occupied.	▶ Remove the items from the front passenger seat and put them in a safe place.

**i** After 60 seconds with an unfastened seat belt, the warning chime stops sounding and the seat belt telltale illuminates continuously. The seat belt telltale will only go out if both, the driver and front passenger's seat belt are fastened, or

*the vehicle is standing still and a front door is opened.*



### What to do if ...

Problem	Possible cause/consequence	Suggested solution
<b>SRS</b> The red SRS indicator lamp comes on while driving.	There is a malfunction in the restraint systems. The air bags or Emergency Tensioning Devices (ETDs) could deploy unexpectedly or fail to activate in an accident.	► Drive with added caution to the nearest authorized Mercedes-Benz Center.

#### Warning!



In the event that a malfunction of the SRS is indicated as outlined above, the SRS may not be operational. For your safety, we strongly recommend that you visit an authorized Mercedes-Benz Center immediately to have the system checked; otherwise the SRS may not be activated when needed in an accident, which could result in serious or fatal injury, or it might deploy unexpectedly and unnecessarily which could also result in an accident and/or injury to you or to others.

Problem	Possible cause/consequence	Suggested solution
<p> USA only: Combination low tire pressure/TPMS malfunction telltale for the TPMS illuminates continuously.</p> <p>Canada only: Low tire pressure telltale for the Advanced TPMS* illuminates continuously.</p>	<p>The TPMS (USA only) or Advanced TPMS* (Canada only) detects a loss of pressure in at least one tire.</p>	<ul style="list-style-type: none"> <li>▶ Carefully bring the vehicle to a halt, avoiding abrupt steering and braking maneuvers. Observe the traffic situation around you.</li> <li>▶ Read and observe messages in the multifunction display.</li> </ul> <p>If the tire inflation pressure in the respective tire(s) has (have) been corrected, the combination low tire pressure/TPMS malfunction telltale goes out after few minutes driving.</p>
<p> USA only: Combination low tire pressure/TPMS malfunction telltale for the TPMS flashes for 60 seconds and then stays illuminated.</p>	<p>There is a malfunction in the TPMS.</p>	<ul style="list-style-type: none"> <li>▶ Read and observe messages in the multifunction display.</li> <li>▶ Have the TPMS checked by an authorized Mercedes-Benz Center.</li> </ul> <p>After the malfunction has been remedied the combination low tire pressure/TPMS malfunction telltale goes out after few minutes driving.</p>



### What to do if ...

#### Warning!



Each tire, including the spare (if provided), should be checked monthly when cold and inflated to the inflation pressure recommended by the vehicle manufacturer on the vehicle placard or the tire inflation pressure label. If your vehicle has tires of a different size than the size indicated on the vehicle placard or the tire inflation pressure label, you should determine the proper tire inflation pressure for those tires.

As an added safety feature, your vehicle has been equipped with a tire pressure monitoring system (TPMS) that illuminates a low tire pressure telltale when one or more of your tires is significantly under-inflated. Accordingly, when the low tire pressure telltale illuminates, you should stop and check your tires as soon as possible, and inflate them to the proper pressure. Driving on a significantly underinflated tire causes the tire to over-heat and can lead to tire failure.



Underinflation also reduces fuel efficiency and tire tread life, and may affect the vehicle's handling and stopping ability. Please note that the TPMS is not a substitute for proper tire maintenance, and it is the driver's responsibility to maintain correct tire pressure, even if underinflation has not reached the level to trigger illumination of the TPMS low tire pressure telltale.

USA only:

Your vehicle has also been equipped with a TPMS malfunction indicator to indicate when the system is not operating properly. The TPMS malfunction indicator is combined with the low tire pressure telltale. When the system detects a malfunction, the telltale will flash for approximately one minute and then remain continuously illuminated. This sequence will continue upon subsequent vehicle start-ups as long as the malfunction exists. When the malfunction indicator is illuminated, the system may not be able to detect or signal low tire pressure as intended.

TPMS malfunctions may occur for a variety of reasons, including the installation of incompatible replacement or alternate tires or wheels on the vehicle that prevent the TPMS from functioning properly. Always check the TPMS malfunction telltale after replacing one or more tires or wheels on your vehicle to ensure that the replacement or alternate tires and wheels allow the TPMS to continue to function properly.

## Air bag off indicator lamp

Problem	Possible cause/consequence	Suggested solution
  <p>The front passenger front air bag off indicator lamp illuminates and remains illuminated with the weight of a typical adult or someone larger than a small individual on the passenger seat.</p>	<p>The system is malfunctioning.</p>	<ul style="list-style-type: none"> <li>▶ Have the system checked as soon as possible by an authorized Mercedes-Benz Center.</li> <li>▶ Also read and observe any messages in the multifunction display and follow corrective steps (&gt; page 356).</li> </ul>

### Warning!



If the  indicator lamp illuminates and remains illuminated with the weight of a typical adult or someone larger than a small individual on the passenger seat, do not have any passenger use the passenger seat until the system has been repaired.

### What to do if ...

Problem	Possible cause/consequence	Suggested solution
 <p>The front passenger front air bag off indicator lamp does not illuminate and/or does not remain illuminated with the weight of a typical 12-month-old child in a standard child restraint or less on the passenger seat.</p>	<p>The system is malfunctioning.</p>	<ul style="list-style-type: none"> <li>▶ Make sure there is nothing between seat cushion and child seat and check installation of the child seat.</li> <li>▶ Make sure that no objects applying supplemental weight onto the seat are present.</li> <li>▶ If the front passenger front air bag off indicator lamp remains out, have the system checked as soon as possible by an authorized Mercedes-Benz Center. Do not transport a child on the passenger seat until the system has been repaired.</li> <li>▶ Also read and observe any messages in the multifunction display and follow corrective steps (▷ page 356).</li> </ul>

### Warning!



If the  indicator lamp does not illuminate or remains out with the

weight of a typical 12-month-old child in a standard child restraint or less on the front passenger seat, do not transport a child on the passenger seat until the system has been repaired.

## Vehicle status messages in the multifunction display





Warning and malfunction messages appear in the multifunction display located in the instrument cluster.





Certain warning and malfunction messages are accompanied by an audible signal.

Address these messages accordingly and follow the additional instructions given in this Operator's Manual.

Selecting the vehicle status message memory menu in the control system (▷ page 152) displays both cleared and uncleared messages.

High-priority messages appear in the multifunction display in red color.

Certain messages of high priority cannot be cleared from the multifunction display using the reset button (▷ page 26) or button , , , or  on the multifunction steering wheel.

Other messages of high priority and messages of less immediate priority can be cleared from the multifunction display using the reset button or button , , , or  on the multifunction steering wheel. They are then stored in the vehicle status message memory (▷ page 152). Remember that clearing a message will not correct the condition that caused the message to appear.

### Warning!



All categories of messages contain important information which should be taken note of and, where a malfunction is indicated, addressed as soon as possible at an authorized Mercedes-Benz Center.

Failure to repair condition noted may cause damage not covered by the Mercedes-Benz Limited Warranty, or result in property damage or personal injury.

### What to do if ...

#### Warning!



No messages will be displayed if either the instrument cluster or the multifunction display is inoperative. Contact your nearest authorized Mercedes-Benz Center.

As a result, you will not be able to see information about your driving conditions, such as speed or outside temperature, warning/indicator lamps, malfunction/warning messages or the failure of any systems. Driving characteristics may be impaired.

If you must continue to drive, do so with added caution. Visit an authorized Mercedes-Benz Center as soon as possible.

**i** *Switching on the ignition causes all instrument cluster lamps (except high beam headlamp indicator lamp and turn signal indicator lamps unless activated) as well as the multifunction display to come on. Make sure the lamps and the multifunction display are in working order before starting your journey.*

On the pages that follow, you will find a compilation of the most important warning and malfunction messages that may appear in the multifunction display.

For your convenience the messages are divided into two sections:

- Text messages (▷ page 349)
- Symbol messages (▷ page 365)

## Text messages

Left display	Right display	Possible cause/consequence	Possible solution
ABC	Malfunction Stop car	You have started driving although the vehicle level is still too low.	▶ Stop your vehicle in a safe location or as soon as it is safe to do so.
		The vehicle is being raised. The ABC message goes out after a few seconds.	▶ Wait until the message disappears from the multifunction display. You may then drive off.
		The vehicle is losing oil. The ABC message is continuously shown.	▶ Stop your vehicle in a safe location or as soon as it is safe to do so. ▶ Contact an authorized Mercedes-Benz Center.

### What to do if ...

Left display	Right display	Possible cause/consequence	Possible solution
ABC	Malfunction Stop car	ABC is malfunctioning.	<ul style="list-style-type: none"> <li>▶ Stop the vehicle in a safe location and press the vehicle level control button to select a higher vehicle level (▷ page 226).</li> <li>If the vehicle does not raise, observe the following when you continue to drive:               <ul style="list-style-type: none"> <li>▶ Do not turn steering wheel too far to avoid damaging the front fenders.</li> <li>▶ Listen for scraping noises.</li> <li>▶ Do not exceed a speed of 50 mph (80 km/h).</li> </ul> </li> <li>▶ Visit an authorized Mercedes-Benz Center as soon as possible.</li> </ul>
ABC	Malfunction	The capability of the ABC system is restricted. This can impair handling.	<ul style="list-style-type: none"> <li>▶ Do not exceed a speed of 50 mph (80 km/h).</li> <li>▶ Visit an authorized Mercedes-Benz Center as soon as possible.</li> </ul>
	Vehicle rising Please wait	The vehicle's level is too low while at a standstill. The vehicle will be raised.	<ul style="list-style-type: none"> <li>▶ Do not drive off.</li> <li>▶ Wait until the message disappears from the multifunction display.</li> </ul> <p>You may then drive off.</p>

Left display	Right display	Possible cause/consequence	Possible solution
ABS	ABS, ESP unavailable See Oper. Manual	<p>The ABS and ESP® are not available due to a malfunction. The BAS is also deactivated.</p> <p>The system's self-diagnosis may not be completed yet.</p> <p>The electro-hydraulic brake system is still functioning normally but without the ABS, the ESP®, and the BAS available.</p>	<p>► Drive a short distance with added caution at a vehicle speed of above 12 mph (20 km/h). When the message disappears, the ABS, the ESP®, and the BAS are available again.</p> <p>If the message does not disappear:</p> <p>► Continue driving with added caution. Wheels may lock during hard braking, reducing steering capability.</p> <p>► Have the system checked at an authorized Mercedes-Benz Center as soon as possible.</p> <p>Failure to follow these instructions increases the risk of an accident.</p>



### What to do if ...

Left display	Right display	Possible cause/consequence	Possible solution
ABS	ABS, ESP inoperative See Oper. Manual	<p>The ABS and ESP® have switched off due to a malfunction.</p> <p>The BAS is also deactivated.</p> <p>The electro-hydraulic brake system is still functioning normally but without the ABS, the ESP®, and the BAS available.</p>	<ul style="list-style-type: none"> <li>▶ Continue driving with added caution. Wheels may lock during hard braking, reducing steering capability.</li> <li>▶ Have the system checked at an authorized Mercedes-Benz Center as soon as possible.</li> </ul> <p>Failure to follow these instructions increases the risk of an accident.</p>
--- mph	Cruise control	You have attempted to set a speed below 20 mph (30 km/h).	▶ Accelerate to a speed exceeding 20 mph (30 km/h) and set the speed (▷ page 210).
		The ESP® is switched off.	▶ Switch on the ESP® (▷ page 92).
		The gear selector lever is set to position <b>P</b> , <b>R</b> , or <b>N</b> .	▶ Move the gear selector lever or position <b>D</b> .
		The vehicle is secured with the parking brake.	▶ Release the parking brake (▷ page 54).

Left display	Right display	Possible cause/consequence	Possible solution
--- mph	Distronic	You have attempted to set a speed below 20 mph (30 km/h).	▶ Accelerate to a speed exceeding 20 mph (30 km/h) and set the speed (▷ page 210).
		The ESP® is switched off.	▶ Switch on the ESP® (▷ page 92).
		The gear selector lever is set to position <b>P</b> , <b>R</b> , or <b>N</b> .	▶ Move the gear selector lever or position <b>D</b> .
		The vehicle is secured with the parking brake.	▶ Release the parking brake (▷ page 54).
DISTRONIC	Inoperative	Distronic* is malfunctioning or the display is malfunctioning.	▶ Visit an authorized Mercedes-Benz Center as soon as possible.
	Currently unavailable. See Oper. Manual	Distronic* is deactivated because the functionality is impaired by external interferences, e.g. high-frequency sources such as too stations, speed measuring systems etc.	▶ Leave the area of the external interference. ▶ Activate DISTRONIC* again (▷ page 218) when the message DISTRONIC available again appears.
		Distronic* is deactivated because the DISTRONIC* sensor has not sensed any other vehicles or objects, e.g. road sign or such, for a long time.	▶ Try to activate DISTRONIC* again (▷ page 218) when the message DISTRONIC available again appears.

### What to do if ...



Left display	Right display	Possible cause/consequence	Possible solution
DISTRONIC	Currently unavailable. See Oper. Manual	<p>Distrionic* is deactivated because</p> <ul style="list-style-type: none"> <li>• the Distrionic* cover in the radiator grille is dirty</li> <li>• the functionality is impaired by heavy precipitation or fog</li> </ul>	<ul style="list-style-type: none"> <li>▶ Clean the Distrionic* cover in the radiator grille (▷ page 325).</li> <li>▶ Restart the vehicle.</li> </ul> <p>Distrionic* becomes operational again without the engine being restarted when</p> <ul style="list-style-type: none"> <li>• dirt on the radiator grille has fallen off while driving (e.g. slush or snow)</li> <li>• the system recognizes full sensor availability due to lessening rain or because the road is drying, for example</li> <li>• the message in the multifunction display disappears</li> </ul> <p>You can then operate Distrionic* as usual again.</p>
	available again	Distrionic* had been deactivated and is available again.	<ul style="list-style-type: none"> <li>▶ Activate Distrionic* (▷ page 218).</li> </ul>

Left display	Right display	Possible cause/consequence	Possible solution
ESP	ESP inoperative See Oper. Manual	<p>The ESP® has detected a malfunction and switched off.</p> <p>The ABS may not be operational.</p> <p>The electro-hydraulic brake system is still functioning normally but without the ESP® available.</p>	<ul style="list-style-type: none"> <li>▶ Continue driving with added caution.</li> <li>▶ Have the system checked at an authorized Mercedes-Benz Center as soon as possible.</li> </ul> <p>Failure to follow these instructions increases the risk of an accident.</p>
	ESP unavailable See Oper. Manual	<p>The ESP® is deactivated because the power supply has been interrupted.</p> <p>The electro-hydraulic brake system is still functioning normally but without the ESP® available.</p>	<ul style="list-style-type: none"> <li>▶ Synchronize the ESP®. With the vehicle stationary, turn the steering wheel completely to the left and then to the right.</li> </ul> <p>If the ESP® message does not go out:</p> <ul style="list-style-type: none"> <li>▶ Continue driving with added caution.</li> <li>▶ Have the system checked at an authorized Mercedes-Benz Center as soon as possible.</li> </ul> <p>Failure to follow these instructions increases the risk of an accident.</p>

**!** When synchronizing the ESP®, make sure you can turn the steering wheel in both directions as far as it will go without the wheels hitting any objects, e.g. a road curb.

### What to do if ...

Left display	Right display	Possible cause/consequence	Possible solution
Front passenger airbag	enabled See Oper. Manual	The passenger front air bag is activated while driving even though a child, small individual, or object below the system's weight threshold is on the front passenger seat, or the front passenger seat is empty. Objects on the seat or forces acting on the seat may make the system sense supplemental weight.	<p>Stop the vehicle in a safe location as soon as possible and check the passenger seat for the following:</p> <ul style="list-style-type: none"> <li>▶ Switch off the ignition (▷ page 39).</li> <li>▶ Remove child and child restraint from passenger seat and properly secure the child in rear seat employing the child restraint if necessary.</li> <li>▶ Make sure that no objects which applying supplemental weight onto the seat are present. The system may recognize such supplemental weight and sense that an occupant on the passenger seat is of a greater weight than actually present.</li> <li>▶ Keep the seat unoccupied, close the passenger door and switch on the ignition (▷ page 39).</li> </ul> <p>Monitor the  indicator lamp between the center air vents and the multifunction display in the instrument cluster (▷ page 139) for the following: (Continued on next page)</p>

Left display	Right display	Possible cause/consequence	Possible solution
Front passenger airbag	enabled See Oper. Manual		<p>With the seat unoccupied and the ignition switched on,</p> <ul style="list-style-type: none"> <li>the  indicator lamp between the center air vents should illuminate and remain illuminated, indicating that the OCS (▷ page 72) has deactivated the air bag.</li> <li>the message <b>Front passenger airbag enabled See Oper. Manual</b> or the message <b>Front passenger airbag disabled See Oper. Manual</b> should not appear in the multifunction display at any time the seat is unoccupied. Wait at last 60 seconds for the system to complete the necessary check cycles and to make sure neither message appears in the multifunction display.</li> </ul> <p>If above conditions are met, you can occupy the passenger seat again. Depending on the passenger classification sensed by the OCS (▷ page 72), the  indicator lamp will remain illuminated or go out.</p> <p>If above conditions are not met, the system is not working properly. Have the system checked as soon as possible by an authorized Mercedes-Benz Center.</p>

**Warning!**





If the  indicator lamp remains

out even after performing the above corrective steps, do not have any children 12 years old and under and other small individuals

use the passenger seat until the system has been repaired.

### What to do if ...

Left display	Right display	Possible cause/consequence	Possible solution
Front passenger airbag	disabled See Oper. Manual	The passenger front air bag is deactivated while driving even though an adult or someone larger than a small individual is occupying the front passenger seat. Forces acting on the seat may make the system sense a decrease in weight.	<p>Stop the vehicle in a safe location as soon as possible and check the front passenger seat for the following:</p> <ul style="list-style-type: none"> <li>▶ Switch off the ignition (▷ page 39).</li> <li>▶ Have the passenger vacate the seat and exit the vehicle.</li> <li>▶ Keep the seat unoccupied, close the passenger door and switch on the ignition (▷ page 39).</li> </ul> <p>Monitor the  indicator lamp between the center air vents (▷ page 76) and the multifunction display in the instrument cluster (▷ page 139) for the following:</p> <p>(Continued on next page)</p>

Left display	Right display	Possible cause/consequence	Possible solution
Front passenger airbag	disabled See Oper. Manual		<p>With the seat unoccupied and the ignition switched on,</p> <ul style="list-style-type: none"> <li>the  indicator lamp between the center air vents should illuminate and remain illuminated, indicating that the OCS (▷ page 72) has deactivated the air bag.</li> <li>the message <b>Front passenger airbag enabled</b> See Oper. Manual or the message <b>Front passenger airbag disabled</b> See Oper. Manual should not appear in the multifunction display at any time the seat is unoccupied. Wait at last 60 seconds for the system to complete the necessary check cycles and to make sure neither message appears in the multifunction display.</li> </ul> <p>If above conditions are met, you can occupy the passenger seat again. Depending on the passenger classification sensed by the OCS (▷ page 72), the  indicator lamp will remain illuminated or go out.</p> <p>If above conditions are not met, the system is not working properly. Have the system checked as soon as possible by an authorized Mercedes-Benz Center.</p>

**Warning!**



If the  indicator lamp remains

illuminated with an adult occupant on the passenger seat even after performing the above corrective steps, do not have any

passenger use the passenger seat until the system has been repaired.



### What to do if ...

Left display	Right display	Possible cause/consequence	Possible solution
P	Gear selector lever to P	<p>You have tried to start the engine with the KEYLESS-GO* start/stop button with the gear selector lever not in position <b>P</b>.</p> <p>You have tried to turn off the engine with the KEYLESS-GO* start/stop button with the gear selector lever not in position <b>P</b>.</p>	▶ Place the gear selector lever in position <b>P</b> .
Retractable roof	open/close completely	The retractable hardtop is not locked properly.	▶ Push or pull on the retractable hardtop switch until the indicator lamp in the switch goes out and the retractable hardtop is completely open or closed (▷ page 199).

Left display	Right display	Possible cause/consequence	Possible solution
SRS	Restraint system malfunction Visit workshop	There is a malfunction in the supplemental restraint systems. The air bags or emergency tensioning devices (ETDs) could deploy unexpectedly or fail to activate in an accident.	► Drive with added caution and have the system checked at an authorized Mercedes-Benz Center immediately.

**Warning!**



In the event a malfunction of the SRS is indicated as outlined above, the SRS may not be operational. For your safety, we strongly recommend that you visit an authorized Mercedes-Benz Center immediately to have the system checked; otherwise the SRS may not be activated when needed in an accident, which could result in serious or fatal injury, or it might deploy unexpectedly and unnecessarily which could result in an accident and/or injury to you or to others.

### What to do if ...

Left display	Right display	Possible cause/consequence	Possible solution
	Check tires Then restart Run Flat Indicator	There was a warning message about a loss in the tire inflation pressure and the Run Flat Indicator has not been reactivated yet.	<ul style="list-style-type: none"> <li>▶ Make sure that the correct tire inflation pressure is set for each tire.</li> <li>▶ Then reactivate the Run Flat Indicator.</li> </ul>
Run Flat Indicator	inoperative	<p>The Run Flat Indicator is malfunctioning.</p> <p>The Run Flat Indicator has been switched off due to an error.</p>	<ul style="list-style-type: none"> <li>▶ Have the Run Flat Indicator checked by an authorized Mercedes-Benz Center.</li> </ul>
	Tire pressure Check tires	The Run Flat Indicator indicates that the pressure is too low in one or more tires.	<ul style="list-style-type: none"> <li>▶ Carefully bring the vehicle to a halt, avoiding abrupt steering and braking maneuvers. Observe the traffic situation around you.</li> <li>▶ Check and adjust tire inflation pressure as required (▷ page 292).</li> <li>▶ If necessary, change the wheel (▷ page 405).</li> <li>▶ Reactivate the Run Flat Indicator after adjusting the tire inflation pressure values (▷ page 294).</li> </ul>

Left display	Right display	Possible cause/consequence	Possible solution
Tire pressure	displayed after driving for a few minutes	Vehicles with Advanced TPMS*: The tire inflation pressure is being checked.	▶ Drive the vehicle for a few minutes.
Tire pressure monitor	inoperative	The TPMS or Advanced TPMS* is malfunctioning.	▶ Have the TPMS or Advanced TPMS* checked by an authorized Mercedes-Benz Center.
Tire pressure monitor	inoperative No wheel sensors	There are wheels without appropriate wheel sensors mounted (e.g. winter tires).	▶ Have the TPMS or Advanced TPMS* checked by an authorized Mercedes-Benz Center.  ▶ Have appropriate wheel sensors installed by an authorized Mercedes-Benz Center.
Tire pressure monitor Wheel sensor missing		One or more sensors defect (e.g. empty sensor battery).  One or more wheels without appropriate wheel sensors mounted (e.g. spare wheel).	▶ Have the TPMS or Advanced TPMS* checked by an authorized Mercedes-Benz Center.  ▶ Have appropriate wheel sensors installed by an authorized Mercedes-Benz Center.  Vehicles with Advanced TPMS*: The tire pressure for the respective tire is indicated in the multifunction display.

### What to do if ...

Left display	Right display	Possible cause/consequence	Possible solution
Tire pressure monitor	currently unavailable	The TPMS or Advanced TPMS* is unable to monitor the tire pressure due to <ul style="list-style-type: none"><li>• a nearby radio interference source.</li><li>• excessive wheel sensor temperatures.</li></ul>	As soon as the causes for the malfunction are no longer present, the TPMS or Advanced TPMS* automatically becomes active again after a few minutes driving.



#### Warning!







Do not drive with a flat tire. A flat tire affects the ability to steer or brake the vehicle.

You may lose control of the vehicle. Continued driving with a flat tire will cause excessive heat build-up and possibly a fire.

Symbol messages

Left display	Right display	Possible cause/consequence	Possible solution
		<p>The battery is no longer charging. Possible causes:</p> <ul style="list-style-type: none"> <li>• alternator malfunctioning</li> <li>• broken poly-V-belt</li> </ul> <p>Do not forget that the brake system requires electrical energy and may be operating with restricted capability. Considerably greater brake pedal force is required and the stopping distance is increased.</p>	<p>▶ Stop the vehicle immediately in a safe location and check the poly-V-belt.</p> <p>If it is broken:</p> <ul style="list-style-type: none"> <li>▶ Do not continue to drive. Otherwise, the engine will overheat due to an inoperative water pump which may result in damage to the engine. Notify an authorized Mercedes-Benz Center.</li> </ul> <p>If it is in order:</p> <ul style="list-style-type: none"> <li>▶ Contact an authorized Mercedes-Benz Center immediately. Adjust driving to be consistent with reduced braking responsiveness.</li> </ul>
		<p>There is a malfunction in the electronic system.</p>	<ul style="list-style-type: none"> <li>▶ Have the system checked at an authorized Mercedes-Benz Center as soon as possible.</li> </ul>

### What to do if ...

Left display	Right display	Possible cause/consequence	Possible solution
	Battery/Alternator Stop car	The battery is malfunctioning. The electro-hydraulic brake system requires electrical energy and therefore has only limited operation. Considerably greater brake pedal force is required and the stopping distance is increased.	<ul style="list-style-type: none"> <li>▶ Stop the vehicle in a safe location. Adjust driving to be consistent with reduced braking responsiveness.</li> <li>▶ Contact an authorized Mercedes-Benz Center.</li> </ul>
	Brake wear	The brake pads have reached their wear limit.	▶ Have the brake pads replaced as soon as possible.
USA only:  Canada only: 	Reduced brake effect Start engine	The battery has insufficient voltage and cannot supply sufficient power to the electro-hydraulic brake system.	▶ Start the engine.  The message disappears when sufficient voltage is available.

**!** Brake pad thickness must be visually checked by a qualified technician at the intervals specified in the Maintenance Booklet.

### Warning!



Inhalation of exhaust gas is hazardous to your health. All exhaust gas contains carbon monoxide (CO), and inhaling it can cause unconsciousness and lead to death.

Do not run the engine in confined areas (such as a garage) which are not properly ventilated.

Left display	Right display	Possible cause/consequence	Possible solution
	<p>Reduced brake effect Depress brake pedal fully!</p>	<p>The electro-hydraulic brake system is in emergency operation mode. Considerably greater brake pedal force is required and the stopping distance is increased.</p> <p>The maximum speed is limited to 55 mph (90 km/h).</p>	<ul style="list-style-type: none"> <li>▶ Stop the vehicle in a safe location or as soon as it is safe to do so.</li> <li>▶ Apply the parking brake (▷ page 61).</li> <li>▶ Do <b>not</b> drive any further.</li> <li>▶ Prevent the vehicle from rolling away by blocking the wheels with wheel chocks or other sizable objects.</li> <li>▶ Contact an authorized Mercedes-Benz Center or call for Roadside Assistance (▷ page 247).</li> </ul>

**Warning!**



Driving while this message is displayed can result in an accident. Have your brake system checked immediately.

If the electro-hydraulic brake system enters its emergency operation mode, the driver must apply significantly greater brake pedal pressure and depress the pedal much further than normal to obtain braking effect.

If necessary, apply full pressure to the brake pedal. Brakes are only applied to the front wheels. Stopping distance is increased!



If there is a malfunction in the electro-hydraulic brake system, we recommend that the vehicle be transported with all wheels off the ground using flatbed or appropriate wheel lift/dolly equipment.

A tow bar must be used if circumstances do not permit the use of the recommended towing methods and the vehicle requires towing with all four wheels on the ground.

Towing the vehicle with all four wheels on the ground is only permissible for distances up to 30 miles (50 km) and at a speed not to exceed 30 mph (50 km/h). For more information, see “Towing the vehicle” (▷ page 421).



### What to do if ...

Left display	Right display	Possible cause/consequence	Possible solution
USA only:  Canada only: 	Reduced brake effect Visit workshop	The electro-hydraulic brake system is in emergency operation mode. Considerably greater brake pedal force is required and the stopping distance is increased.	<ul style="list-style-type: none"> <li>▶ Stop the vehicle in a safe location or as soon as it is safe to do so.</li> <li>▶ Apply the parking brake (▷ page 61).</li> <li>▶ Do <b>not</b> drive any further.</li> <li>▶ Prevent the vehicle from rolling away by blocking the wheels with wheel chocks or other sizable objects.</li> <li>▶ Contact an authorized Mercedes-Benz Center or call for Roadside Assistance (▷ page 247).</li> </ul>

### Warning!



Driving while this message is displayed can result in an accident. Have your brake system checked immediately.



If the electro-hydraulic brake system enters its emergency operation mode, the driver must apply significantly greater brake pedal pressure and depress the pedal much further than normal to obtain braking effect.

If necessary, apply full pressure to the brake pedal. Brakes are only applied to the front wheels. Stopping distance is increased!

If there is a malfunction in the electro-hydraulic brake system, we recommend that the vehicle be transported with all wheels off the ground using flatbed or appropriate wheel lift/dolly equipment.

A tow bar must be used if circumstances do not permit the use of the recommended towing methods and the vehicle requires towing with all four wheels on the ground.

Towing the vehicle with all four wheels on the ground is only permissible for distances up to 30 miles (50 km) and at a speed not to exceed 30 mph (50 km/h). For more information, see "Towing the vehicle" (▷ page 421).

Left display	Right display	Possible cause/consequence	Possible solution
USA only:  Canada only: 	Check brake fluid level	There is insufficient brake fluid in the reservoir.	Risk of accident! <ul style="list-style-type: none"> <li>▶ Stop the vehicle in a safe location or as soon as it is safe to do so.</li> <li>▶ Do <b>not</b> drive any further.</li> <li>▶ Contact an authorized Mercedes-Benz Center.</li> </ul> Do not add brake fluid! This will not solve the problem.





**Warning!**



Driving with the message **Check brake fluid level** displayed can result in an accident. Have your brake system checked immediately. Do not add brake fluid before checking the brake system. Overfilling the brake fluid reservoir can result in spilling brake fluid on hot engine parts and the brake fluid catching fire. You can be seriously burned.

**!** *If you find that the brake fluid in the brake fluid reservoir has fallen to the minimum mark or below, have the brake system checked for brake pad thickness and leaks.*

### What to do if ...

Left display	Right display	Possible cause/consequence	Possible solution
USA only:  Canada only: 	Service brake Visit workshop	There are malfunctions, but the electro-hydraulic brake system is operating normally.	▶ Contact an authorized Mercedes-Benz Center as soon as possible.
	Brakes overheated Drive on, but with even greater care	The brake system is overheated due to an excessive load on the brakes.	▶ Relieve the load on the brake system: <ul style="list-style-type: none"> <li>▶ Drive more smoothly and think ahead to avoid unnecessary braking.</li> <li>▶ When driving down steep grades, shift into a lower gear to use the engine's braking power (▷ page 174).</li> <li>▶ Cautiously continue driving so that the air stream will cool down the brakes.</li> </ul>
USA only:  Canada only: 	Release parking brake	You are driving with the parking brake set.	▶ Release the parking brake (▷ page 61).

Left display	Right display	Possible cause/consequence	Possible solution
	<p>Coolant Stop car - Turn engine off</p>	<p>The coolant is too hot.  Among other possible causes, the poly-V-belt could be broken.</p>	<ul style="list-style-type: none"> <li>▶ Stop the vehicle in a safe location or as soon as it is safe to do so.</li> <li>▶ Turn off the engine.</li> <li>▶ Check the poly-V-belt.</li> </ul> <p>If it is broken:</p> <ul style="list-style-type: none"> <li>▶ Do not continue to drive. Otherwise, the engine will overheat due to an inoperative water pump which may result in damage to the engine. Contact an authorized Mercedes-Benz Center.</li> </ul> <p>If it is intact:</p> <ul style="list-style-type: none"> <li>▶ Wait for the message to disappear before re-starting the engine.</li> </ul> <p>Doing otherwise could result in serious engine damage that is not covered by the Mercedes-Benz Limited Warranty.</p> <p>(Continued on next page)</p>

### What to do if ...

Left display	Right display	Possible cause/consequence	Possible solution
			<ul style="list-style-type: none"> <li>▶ Observe the coolant temperature gauge in the instrument cluster (▷ page 27). If the temperature rises again:</li> <li>▶ Contact an authorized Mercedes-Benz Center immediately.</li> </ul>

#### Warning!





Driving when your engine is overheated can cause some fluids which may have leaked into the engine compartment to catch fire. You could be seriously burned.

Steam from an overheated engine can cause serious burns and can occur just by opening the engine hood. Stay away from the engine if you see or hear steam coming from it.

Turn off the engine, get out of the vehicle and do not stand near the vehicle until the engine has cooled down.

During severe operating conditions, e.g. stop-and-go traffic, the coolant temperature may rise close to 248°F (120°C).

**!** *The engine should not be operated with the coolant temperature above 248°F (120°C). Doing so may cause serious engine damage which is not covered by the Mercedes-Benz Limited Warranty.*

Left display	Right display	Possible cause/consequence	Possible solution
	Top up coolant See Oper. Manual	The coolant level is too low.	<ul style="list-style-type: none"> <li>▶ Add coolant (▷ page 280). Comply with all warnings while doing so.</li> <li>▶ If you have to add coolant frequently, have the cooling system checked by an authorized Mercedes-Benz Center.</li> </ul>
		The cooling fan for the coolant is malfunctioning.	<ul style="list-style-type: none"> <li>▶ Observe the coolant temperature gauge in the instrument cluster (▷ page 27). If the coolant temperature is under 120°C, you may continue driving to the nearest specialist workshop.</li> <li>▶ Avoid placing heavy loads on the engine (e.g. by driving uphill) as well as stop-and-go traffic.</li> <li>▶ Have the fan replaced as soon as possible.</li> </ul>



**Warning!**





Do not spill antifreeze on hot engine parts. Antifreeze contains ethylene glycol which may burn if it comes into contact with hot engine parts. You can be seriously burned.

**!** Do not ignore the low engine coolant level warning. Extended driving with this message and symbol displayed may cause serious engine damage not covered by the Mercedes-Benz Limited Warranty. Do not drive without sufficient amount of coolant in the cooling system. The engine will overheat, causing major engine damage.

### What to do if ...

Left display	Right display	Possible cause/consequence	Possible solution
Check doors		<p>You are attempting to drive with one or more doors open.</p> <p>Vehicles with KEYLESS-GO*: You are pressing the lock button on the door handle and at least one door is open.</p>	<p>► Close the doors.</p>
	Visit workshop	<p>Certain electronic systems are unable to relay information to the control system. The following systems may have failed:</p> <ul style="list-style-type: none"> <li>• Coolant temperature gauge</li> <li>• Tachometer</li> </ul>	<p>► Have the electronic systems checked by an authorized Mercedes-Benz Center (▷ page 336).</p>
	Engine Service	<p>There may be a malfunction in the</p> <ul style="list-style-type: none"> <li>• fuel injection system</li> <li>• ignition system</li> <li>• exhaust system</li> <li>• fuel system</li> </ul>	<p>► Have the engine checked as soon as possible by an authorized Mercedes-Benz Center (▷ page 336).</p>

Left display	Right display	Possible cause/consequence	Possible solution
	Entry position Do not drive	The steering wheel has not yet moved into its stored driving position.	<ul style="list-style-type: none"> <li>▶ Wait until the steering wheel has moved to its driving position.</li> <li>The message disappears.</li> </ul>
	<p>USA only: Add 1 qt. engine oil at next refueling</p> <p>Canada only: Add 1 liter engine oil at next refueling</p>	Vehicles with engine oil measuring system only: The engine oil level is too low.	<ul style="list-style-type: none"> <li>▶ Add engine oil (▷ page 278) and check the engine oil level (▷ page 276).</li> </ul>
	Engine oil level Stop car - turn engine off	Vehicles with engine oil measuring system only: There is no oil in the engine. There is a danger of engine damage.	<ul style="list-style-type: none"> <li>▶ Stop the vehicle in a safe location or as soon as it is safe to do so.</li> <li>▶ Turn off the engine.</li> <li>▶ Add engine oil (▷ page 278) and check the engine oil level (▷ page 276).</li> </ul>
	Engine oil level Reduce oil level	Vehicles with engine oil measuring system only: You have added too much engine oil. There is a risk of damaging the engine or the catalytic converter.	<ul style="list-style-type: none"> <li>▶ Have excess oil siphoned or drained off. Observe all legal requirements with respect to its disposal.</li> </ul>



### What to do if ...



Left display	Right display	Possible cause/consequence	Possible solution
	Engine oil level Cannot measure engine oil level	Vehicles with engine oil measuring system only: The measuring system is malfunctioning.	▶ Have the measuring system checked by an authorized Mercedes-Benz Center.
	Engine oil level Check level	Vehicles with oil dipstick only: The engine oil has dropped to a critical level.	▶ Check the engine oil level (▷ page 276) and add oil as required (▷ page 278). ▶ If you must add engine oil frequently, have the engine checked for possible leaks.

When the message Add 1 qt engine oil at next refueling (Canada: 1 l) appears while the engine is running and at operating temperature, the engine oil level has dropped to approximately the minimum level.



When this occurs, the warning will first come on intermittently and then stay on if the oil level drops further.

If no oil leaks are noted, continue to drive to the nearest service station where the engine oil should be topped to the required level with an approved oil specified in the Factory Approved Service Products pamphlet.

**!** *The engine oil level warnings should not be ignored. Extended driving with the symbol displayed could result in serious engine damage that is not covered by the Mercedes-Benz Limited Warranty.*



Left display	Right display	Possible cause/consequence	Possible solution
	Fuel cap open	A loss of pressure has been detected in the fuel system. The fuel cap may not be closed properly or the fuel system may be leaky.	<ul style="list-style-type: none"> <li>▶ Check the fuel cap (▷ page 271).</li> </ul> If it is not closed properly: <ul style="list-style-type: none"> <li>▶ Close the fuel cap.</li> </ul> If it is closed properly: <ul style="list-style-type: none"> <li>▶ Have the fuel system checked by an authorized Mercedes-Benz Center.</li> </ul>
	being lowered	The retractable hardtop is not completely opened or closed. The roof hydraulics will start to lose pressure.	<ul style="list-style-type: none"> <li>▶ Make sure the retractable hardtop is completely opened or closed (▷ page 199).</li> </ul>
	locked in driving mode	You have attempted to open the retractable hardtop while driving.	<ul style="list-style-type: none"> <li>▶ Stop the vehicle in a safe location and try to open the hardtop again.</li> </ul>
		You are driving with the hood open.	Risk of accident! <ul style="list-style-type: none"> <li>▶ Stop the vehicle in a safe location or as soon as it is safe to do so.</li> <li>▶ Close the hood (▷ page 275).</li> </ul>

### What to do if ...

Left display	Right display	Possible cause/consequence	Possible solution
	Remove key	You have forgotten to remove the SmartKey from the starter switch.	▶ Remove the SmartKey from the starter switch.
	Replace key	The SmartKey is no longer functional.	▶ Contact an authorized Mercedes-Benz Center.
	Change key batteries	The batteries in the SmartKey with KEYLESS-GO* are discharged.	▶ Replace the batteries (> page 395).

Left display	Right display	Possible cause/consequence	Possible solution
	Key not detected	<p>The SmartKey with KEYLESS-GO* is not recognized while the engine is running because:</p> <ul style="list-style-type: none"> <li>• The SmartKey with KEYLESS-GO* is not in the vehicle.</li> <li>• There is strong radio-frequency interference.</li> </ul>	<ul style="list-style-type: none"> <li>▶ Stop the vehicle in a safe location or as soon as it is safe to do so.</li> <li>▶ Search for the SmartKey with KEYLESS-GO*. Otherwise the vehicle cannot be centrally locked nor can the engine be started again after the engine is stopped.</li> <li>▶ Operate the vehicle with the SmartKey with KEYLESS-GO* in the starter switch</li> </ul>
	Key not detected	<p>The SmartKey with KEYLESS-GO* is not recognized when attempting to start the engine with the KEYLESS-GO start/stop button* on the gear selector lever because:</p> <ul style="list-style-type: none"> <li>• The SmartKey with KEYLESS-GO* is not in the vehicle.</li> <li>• The battery in the SmartKey with KEYLESS-GO* is not inserted properly or completely discharged.</li> </ul>	<ul style="list-style-type: none"> <li>▶ Change the position of the SmartKey with KEYLESS-GO* in the vehicle.</li> <li>▶ Make sure the batteries in the SmartKey with KEYLESS-GO* are properly inserted (▷ page 395) and are not discharged (▷ page 110).</li> <li>▶ Start the engine with the SmartKey with KEYLESS-GO* in the starter switch if necessary.</li> </ul>

### What to do if ...

Left display	Right display	Possible cause/consequence	Possible solution
	Key still in vehicle	A SmartKey with KEYLESS-GO* left in the vehicle was recognized while locking the vehicle from the outside.	▶ Take the SmartKey with KEYLESS-GO* out of the vehicle.
	3rd brake lamp	The high mounted brake lamp is malfunctioning.	▶ Contact an authorized Mercedes-Benz Center as soon as possible.
	AUTO light inoperative	The light sensor is malfunctioning. The headlamps switch on automatically.	▶ In the control system, set lamp operation to manual mode (▷ page 159). ▶ Switch on headlamps using the exterior lamp switch. ▶ Contact an authorized Mercedes-Benz Center as soon as possible.
	Brake lamp left Auxiliary bulb on	The left brake lamp is malfunctioning. An auxiliary bulb has been brought into use.	▶ Contact an authorized Mercedes-Benz Center as soon as possible.
	Brake lamp Right Substitute bulb on	The right brake lamp is malfunctioning. A substitute bulb has been brought into use.	▶ Contact an authorized Mercedes-Benz Center as soon as possible.
	Front foglamp left	The left front fog lamp or left corner-illuminating front fog lamp is malfunctioning.	▶ Contact an authorized Mercedes-Benz Center as soon as possible.

Left display	Right display	Possible cause/consequence	Possible solution
	Front foglamp right	The right front fog lamp or right corner-illuminating front fog lamp is malfunctioning.	► Contact an authorized Mercedes-Benz Center as soon as possible.
	High beam left	The left high beam lamp is malfunctioning.	► Replace the bulb as soon as possible (▷ page 397).
	High beam right	The right high beam lamp is malfunctioning.	► Replace the bulb as soon as possible (▷ page 397).
	License plate lamp - left	The left license plate lamp is malfunctioning.	► Replace the bulb as soon as possible (▷ page 397).
	License plate lamp - right	The right license plate lamp is malfunctioning.	► Replace the bulb as soon as possible (▷ page 397).
	Low beam left	The left low beam lamp is malfunctioning.	► Contact an authorized Mercedes-Benz Center as soon as possible.
	Low beam right	The right low beam lamp is malfunctioning.	► Contact an authorized Mercedes-Benz Center as soon as possible.
	Marker lamp front left	The front left side marker lamp is malfunctioning.	► Contact an authorized Mercedes-Benz Center as soon as possible.
	Marker lamp front right	The front right side marker lamp is malfunctioning.	► Contact an authorized Mercedes-Benz Center as soon as possible.
	Marker lamp rear left	The rear left side marker lamp is malfunctioning.	► Contact an authorized Mercedes-Benz Center as soon as possible.







### What to do if ...

Left display	Right display	Possible cause/consequence	Possible solution
	Marker lamp rear right	The rear right side marker lamp is malfunctioning.	▶ Contact an authorized Mercedes-Benz Center as soon as possible.
	Parking lamp front left Auxiliary bulb on	The front left parking or standing lamp is malfunctioning. An auxiliary bulb has been brought into use.	▶ Replace the bulb as soon as possible (▷ page 397).
	Parking lamp front right Auxiliary bulb on	The front right parking or standing lamp is malfunctioning. An auxiliary bulb has been brought into use.	▶ Replace the bulb as soon as possible (▷ page 397).
	Rear foglamp left	The left rear fog lamp is malfunctioning.	▶ Contact an authorized Mercedes-Benz Center as soon as possible.
	Reverse lamp left	The left backup lamp is malfunctioning.	▶ Replace the bulb as soon as possible (▷ page 397).
	Reverse lamp right	The right backup lamp is malfunctioning.	▶ Replace the bulb as soon as possible (▷ page 397).
	Turn signal left mirror	The turn signal in the driver's side exterior rear view mirror is malfunctioning. This message will only appear if all light emitting diodes have stopped working.	▶ Contact an authorized Mercedes-Benz Center as soon as possible.

Left display	Right display	Possible cause/consequence	Possible solution
	Turn signal right mirror	The turn signal in the passenger side exterior rear view mirror is malfunctioning. This message will only appear if all light emitting diodes have stopped working.	▶ Contact an authorized Mercedes-Benz Center as soon as possible.
	Tail lamp left Auxiliary bulb on	The left tail lamp is malfunctioning. An auxiliary bulb has been brought into use.	▶ Contact an authorized Mercedes-Benz Center as soon as possible.
	Tail lamp right Auxiliary bulb on	The right tail lamp is malfunctioning. An auxiliary bulb has been brought into use.	▶ Contact an authorized Mercedes-Benz Center as soon as possible.
	Turn off lights	You have removed the SmartKey from the starter switch and opened the driver's door or removed the SmartKey with KEYLESS-GO* from the vehicle and left the headlamps on.	▶ Turn the exterior lamp switch to <b>0</b> or <b>AUTO</b> .
	Turn signal front left Auxiliary bulb on	The left front turn signal lamp is malfunctioning. An auxiliary bulb has been brought into use.	▶ Replace the bulb as soon as possible (▷ page 397).
	Turn signal front right Auxiliary bulb on	The right front turn signal lamp is malfunctioning. An auxiliary bulb has been brought into use.	▶ Replace the bulb as soon as possible (▷ page 397).



### What to do if ...

Left display	Right display	Possible cause/consequence	Possible solution
	Turn signal rear left Auxiliary bulb on	The left rear turn signal lamp is malfunctioning. An auxiliary bulb has been brought into use.	▶ Replace the bulb as soon as possible (▷ page 397).
	Turn signal rear right Auxiliary bulb on	The right rear turn signal lamp is malfunctioning. An auxiliary bulb has been brought into use.	▶ Replace the bulb as soon as possible (▷ page 397).
	Raise roll-over bar	The roll bar is malfunctioning.	<p>For safety reason, always have the roll bar raised when driving with the retractable hardtop open.</p> <p>▶ Attempt to raise the roll bar using the roll bar button (▷ page 81).</p> <p>▶ Have the roll bar checked by an authorized Mercedes-Benz Center.</p>
	TeleAid inoperative	One or more main functions of the Tele Aid system are malfunctioning.	▶ Have the Tele Aid system checked by an authorized Mercedes-Benz Center.
	Function unavailable	This display appears if button  or  on the multifunction steering wheel is pressed and the vehicle is not equipped with a telephone.	

Left display	Right display	Possible cause/consequence	Possible solution
	Please correct the tire pressure	The tire inflation pressure is too low in one or more tires.	▶ Check and correct tire inflation pressure as required (▷ page 292).
	Tire pressure Caution Tire defect	One or more tires are deflating.	▶ Carefully bring the vehicle to a halt, avoiding abrupt steering and braking maneuvers. ▶ If necessary, change the wheel (▷ page 405).
	Caution Tire defect	Vehicles with Advanced TPMS*: One or more tires are deflating.  The respective tire is indicated in the multifunction display.	▶ Carefully bring the vehicle to a halt, avoiding abrupt steering and braking maneuvers. ▶ If necessary, change the wheel (▷ page 405).

**Warning!**



Do not drive with a flat tire. A flat tire affects the ability to steer or brake the vehicle.

You may lose control of the vehicle. Continued driving with a flat tire will cause excessive heat build-up and possibly a fire.

### What to do if ...



Left display	Right display	Possible cause/consequence	Possible solution
	Tire pressure Check tires	The tire pressure in one or more tires is already below the minimum value.	<ul style="list-style-type: none"> <li>▶ Carefully bring the vehicle to a halt, avoiding abrupt steering and braking maneuvers.</li> <li>▶ Check and adjust tire pressure as required.</li> <li>▶ If necessary, change the wheel.</li> </ul>
	Check tires	<p>Vehicles with Advanced TPMS*: The tire pressure in one or more tires is already below the minimum value.</p> <p>The respective tire is indicated in the multifunction display.</p>	<ul style="list-style-type: none"> <li>▶ Carefully bring the vehicle to a halt, avoiding abrupt steering and braking maneuvers.</li> <li>▶ Check and adjust tire pressure as required.</li> <li>▶ If necessary, change the wheel.</li> </ul>

### Warning!



Do not drive with a flat tire. A flat tire affects the ability to steer or brake the vehicle.

You may lose control of the vehicle. Continued driving with a flat tire will cause excessive heat build-up and possibly a fire.

Left display	Right display	Possible cause/consequence	Possible solution
		This message will appear when the trunk lid is open and you are trying to open or close the retractable hardtop.	▶ Close the trunk lid.
	Close trunk partition	You are trying to open or close the retractable hardtop even though the luggage cover in the trunk is not closed and/or properly engaged.	▶ Close the luggage cover and engage it into side holders (▷ page 205).
	Washer fluid Please refill	The washer fluid in the washer fluid reservoir has fallen below the minimum level.	▶ Add washer fluid (▷ page 282).

**Warning!**



Do not spill antifreeze on hot engine parts. Antifreeze contains ethylene glycol which may ignite when it comes into contact with hot engine parts. You could be seriously burned.

### Where will I find ...?

#### First aid kit

The first aid kit is located in storage compartment under the passenger seat.



① Handle

② Lid

► Pull handle ① up.

► Fold lid ② down.

You can now remove the first-aid kit.

**i** Check expiration dates and contents for completeness at least once a year and replace missing/expired items.

#### Vehicle tool kit, jack, and spare wheel

The vehicle tool kit, jack, and spare wheel are stored in the space underneath the trunk floor.

#### Warning!



The jack is designed exclusively for jacking up the vehicle at the jack tubes built into both sides of the vehicle. To help avoid personal injury, use the jack only to lift the vehicle during a wheel change. Never get beneath the vehicle while it is supported by the jack. Keep hands and feet away from the area under the lifted vehicle. Always firmly set parking brake and block wheels before raising vehicle with jack.

Do not disengage parking brake while the vehicle is raised. Be certain that the jack is always vertical (plumb line) when in use, especially on hills. Always try to use the jack on a hard level surface. Be sure that the jack

arm is fully inserted in the jack tube. Always lower the vehicle onto sufficient capacity jackstands before working under the vehicle.

► Lift up the trunk floor cover.

You can now remove the tools and accessories.

The vehicle tool kit includes

- One pair of universal pliers
- Two open-end wrenches
- One hex-socket wrench
- One interchangeable slot/Phillips screwdriver
- One towing eye bolt
- One alignment bolt
- One fuse extractor
- One fuse chart
- Spare fuses



- ① Spare wheel
- ② Electric air pump
- ③ Vehicle tool kit
- ④ Storage well casing

▶ Take spare wheel ① out of the trunk, see “Removing the spare wheel” (▷ page 389), to access jack ⑤ and wheel wrench ⑥.



- ⑤ Jack
- ⑥ Wheel wrench

### Removing the spare wheel

- ▶ Open the trunk (▷ page 111).
- ▶ Lift up the trunk floor cover.
- ▶ Remove storage well casing that contains the vehicle tool kit and the electric air pump.



- ① Spare wheel
  - ② Tensioning strap (vehicles with 19" spare wheel only)
  - ③ Retaining screw
  - ④ Storage well casing base
- ▶ Remove storage well casing base ④.
  - ▶ Remove retaining screw ③ by turning it counterclockwise.
  - ▶ Remove spare wheel ①.

### Where will I find ...?

#### Storing the spare wheel after use

If you wish to store the spare wheel after use, carry out the following steps. Otherwise, the spare wheel may not fit the spare wheel well.

**!** Make sure the spare wheel is dry before storing it.

- ▶ Unscrew the valve cap from the valve of the collapsible tire.
- ▶ Take the valve extractor from the vehicle tool kit (▷ page 388).
- ▶ Unscrew the valve insert from the valve and allow the air to escape.

**i** It may take a few minutes for the collapsible tire to deflate completely.

- ▶ Screw the valve insert back into the valve.
- ▶ Screw the valve cap back onto the valve.

**i** Vehicles with 19" spare wheel only: Before storing the spare wheel in trunk fasten tensioning straps, see "Compressing the collapsible tire (vehicles with 19" spare wheel only)" (▷ page 390).

- ▶ Store the spare wheel by carrying out the steps described in "Removing the spare wheel" (▷ page 389) in reverse order.

#### Compressing the collapsible tire (vehicles with 19" spare wheel only)

The collapsible tire on a 19" spare wheel must be compressed with two tensioning straps before you can store it back in the trunk.

**i** The tensioning straps are shown in red for illustration purposes. The tensioning straps on the spare wheel of your vehicle are black.



- ▶ Extend the tensioning strap by pulling the slider.
- ▶ Place tensioning strap around spare wheel rim and collapsible tire with the buckle facing the inside of the rim.
- ▶ Close the buckle.
- ▶ Pull the loose end of the tensioning strap.

The tensioning strap must be pulled as tight as possible.

## Locking/unlocking in an emergency

## ▼ Locking/unlocking in an emergency

## Unlocking the vehicle

If you cannot unlock the vehicle using the SmartKey or KEYLESS-GO\*, unlock the driver's door and the trunk using the mechanical key.

**i** *Unlocking the vehicle with the mechanical key and opening the driver's door or the trunk will trigger the anti-theft alarm system (▷ page 96).*

*To cancel the alarm, insert the SmartKey or the SmartKey with KEYLESS-GO\* in the starter switch.*

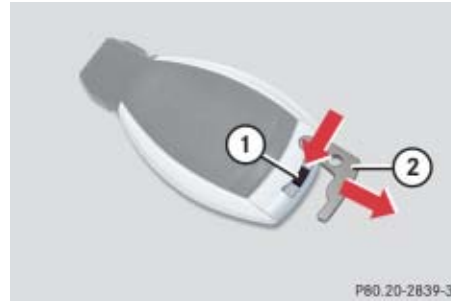

- ① Mechanical key locking tab
- ② Mechanical key

- ▶ Move locking tab ① direction of arrow and slide the mechanical key ② out of the housing.

## Unlocking the driver's door

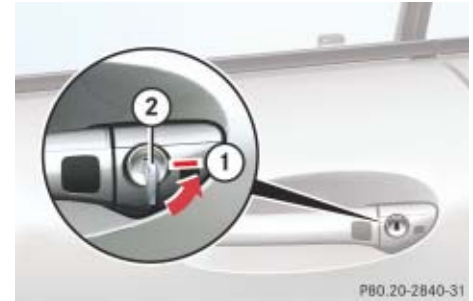

- ① Unlocking
- ② Mechanical key

- ▶ Insert mechanical key ② into the lock until it stops.
- ▶ Turn mechanical key ② counterclockwise to position ①.

The driver's door is unlocked. You can now open the driver's door.



### Locking/unlocking in an emergency

#### Unlocking the trunk

A minimum height clearance of 6.2 ft (1.89 m) is required to open the trunk lid.

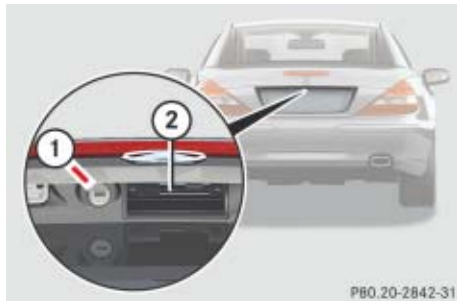

① Unlocking in an emergency

② Handle

- ▶ Insert the mechanical key into the trunk lid lock until it stops.
- ▶ Turn the mechanical key counterclockwise to position ①.

The trunk is unlocked

- ▶ Pull handle ② and lift lid.
- ▶ Turn the mechanical key back and remove it from the trunk lid lock.

#### Unlocking the glove box

Lockable storage areas in the passenger compartment include:

- the glove box
- the storage compartment under the armrest
- the rear storage compartments

If these cannot be unlocked by means of the SmartKey or the SmartKey with KEYLESS-GO\*, use the mechanical key to unlock the glove box.

**i** To unlock the remaining storage compartments, the cause for the malfunction of the SmartKey or the SmartKey with KEYLESS-GO\* must be determined and corrected, see (> page 104) and (> page 109).





① Separately unlocking the glove box

- ▶ Slide mechanical key out of SmartKey housing (> page 391).
- ▶ Insert the mechanical key into the glove box lock and turn it to position ①.

You can now open the glove box.

## Locking/unlocking in an emergency

**i** Unlocking the glove box with the mechanical key will trigger the anti-theft alarm system. To cancel the alarm, do one of the following:

- Press button  or  on the SmartKey.
- Insert the SmartKey in the starter switch.
- Press the KEYLESS-GO\* start/stop button (▷ page 40).
- Grasp an outside door handle (vehicles with KEYLESS-GO\* only).

### Locking the vehicle

If you cannot lock the vehicle with the SmartKey, lock it with the mechanical key as follows:

- ▶ Close the passenger door and the trunk.
- ▶ Press the central locking switch in the center console (▷ page 119).
- ▶ Check whether the locking knob on the passenger door has moved down.
- ▶ If necessary push it down manually.
- ▶ Remove the mechanical key from of the SmartKey (▷ page 391).
- ▶ Check whether the trunk is locked.
- ▶ If necessary, lock the trunk with the mechanical key (▷ page 117).

Except for the driver's door, the vehicle should now be locked.

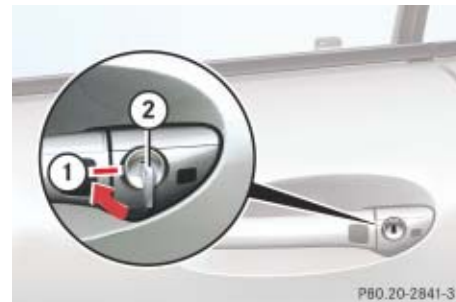

① Locking

② Mechanical key

- ▶ Insert mechanical key ② (▷ page 391) into the driver's door lock until it stops.
- ▶ Turn mechanical key ② clockwise to position ①.

The driver's door is locked.

**i** This procedure does not arm the anti-theft alarm system, nor does it lock the fuel filler flap and the storage compartments.

The storage compartments can be locked separately (▷ page 235).

### Locking/unlocking in an emergency

#### Lowering the load assist manually

If the load assist feature does not fully lower the retractable hardtop into the trunk compartment and you are unable to close the trunk lid, follow the instructions below.

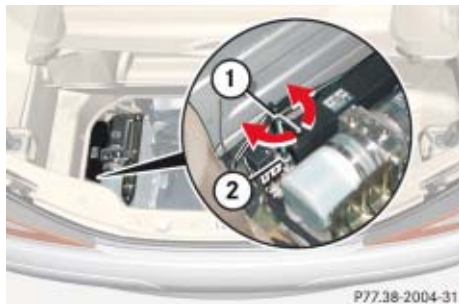

① Hex-socket wrench

② Locking screw

- ▶ Remove the trunk floor from the trunk.
- ▶ Lift up the lid located at the lower left side of the trunk.
- ▶ Have a second person lift and hold the retracted hardtop.

- ▶ Using hex-socket ① wrench provided in the vehicle tool kit, carefully turn the locking screw ② approximately one quarter of a turn.
- ▶ Hook luggage cover into holders (▷ page 205).
- ▶ Let go of the hardtop.  
It should gradually lower into the trunk.
- ▶ When top is completely lowered, return locking screw ② to its original position.

**!** Do not overtighten the screw.

- ▶ Close the lid.
- ▶ Replace the trunk floor.
- ▶ Visit an authorized Mercedes-Benz Center as soon as possible.

## Replacing SmartKey batteries

## ▼ Replacing SmartKey batteries

If the batteries in the SmartKey or the SmartKey with KEYLESS-GO\* are discharged, the vehicle can no longer be locked or unlocked. It is recommended to have the batteries replaced at an authorized Mercedes-Benz Center.

**Warning!**

Batteries contain poisonous and corrosive substances. Therefore keep the batteries out of reach of children.

If a battery is swallowed, seek medical help immediately.

Batteries contain materials that can harm the environment if disposed of improperly. Recycling of batteries is the preferred method of disposal. Many states require sellers of batteries to accept old batteries for recycling.

**i** When inserting batteries, make sure they are clean and free of lint.

**i** When replacing batteries, always replace both batteries.

*The required replacement batteries (Lithium, type CR 2025 or equivalent) are available at any authorized Mercedes-Benz Center.*

- ▶ Remove the mechanical key from the SmartKey or SmartKey with KEYLESS-GO\* (▷ page 391).

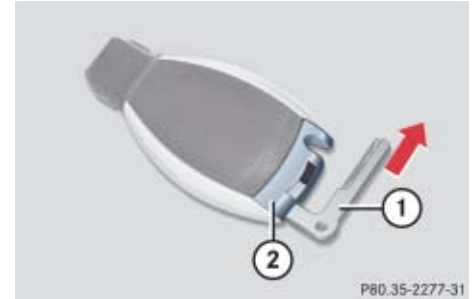

- ① Mechanical key
- ② Battery compartment
- ▶ Insert mechanical key ① into opening.
- ▶ Press mechanical key ① in direction of arrow.  
The battery compartment is unlatched.
- ▶ Pull battery compartment ② out of the housing.



### Replacing SmartKey batteries

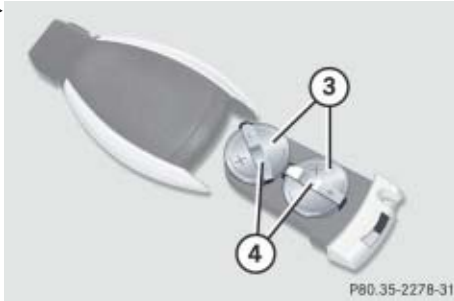

③ Batteries

④ Contact spring

- ▶ Pull out batteries ③.
  - ▶ Using a lint-free cloth, insert new batteries ③ under contact springs ④ with the positive terminal (+) side facing up.
  - ▶ Return battery compartment ② into housing until it locks into place.
- ▶ Slide mechanical key ① back into SmartKey or SmartKey with KEYLESS-GO\*.
  - ▶ Check the operation of the SmartKey or SmartKey with KEYLESS-GO\* as well as the KEYLESS-GO\* function.

## ▼ Replacing bulbs

### Warning!



Bulbs and bulb sockets can be very hot. Allow the lamp to cool down before changing a bulb.

Keep bulbs out of reach of children.

Halogen lamps contain pressurized gas. A bulb can explode if you:

- touch or move it when hot
- drop the bulb
- scratch the bulb

Wear eye and hand protection.

Because of high voltage in Xenon lamps, it is dangerous to replace the bulb or repair the lamp and its components. We recommend that you have such work done by a qualified technician.

### Bulbs

Safe vehicle operation depends on proper exterior lighting and signaling. It is therefore essential that all bulbs and lamp assemblies are in good working order at all times.

Correct headlamp adjustment is extremely important. Have headlamps checked and readjusted at regular intervals and when a bulb has been replaced. See an authorized Mercedes-Benz Center for headlamp adjustment.

**i** *If the headlamps or front fog lamps are fogged up on the inside as a result of high humidity, driving the vehicle a distance with the lights on should clear up the fogging.*

**i** *Auxiliary bulbs will be brought into use when the following lamps malfunction:*

- *Turn signal lamps*
- *Brake lamps*
- *Parking lamps*
- *Tail lamps*

*Observe the messages in the multifunction display (▷ page 347).*

## Replacing bulbs

### Front lamps

	Lamp	Type
①	Additional turn signal	LED
②	Turn signal lamp	1156 NA
③	Low beam <sup>1</sup>	D2S-35 W
④	Xenon headlamp: High beam, high beam flasher	H7 (55W)
	Bi-Xenon headlamp*: High beam flasher	H7 (55W)
	Parking and standing lamp	W 5 W
⑤	Front fog lamp, Corner-illuminating front fog lamp	H11 (55W)
⑥	Side marker lamp	W 5 W

<sup>1</sup> Vehicles with Xenon or Bi-Xenon\* headlamps: Low beam and high beam use the same D2S-35W lamp. Do not replace the Xenon and Bi-Xenon\* bulbs yourself. Contact an authorized Mercedes-Benz Center.



### Rear lamps

	Lamp	Type
⑦	Rear fog lamp (driver's side only)	P 21 W
⑧	High mounted brake lamp	LED
⑨	Backup lamp	P 21 W
⑩	Tail, parking and standing lamp, side marker lamp	LED
⑪	Brake lamp	LED
⑫	License plate lamp	C 5 W
⑬	Turn signal lamp	PY 21 W

### Notes on bulb replacement

- Only use 12-volt bulbs of the same type and with the specified watt rating.
- Switch the lights off before changing a bulb to prevent short circuits.
- Always use a clean lint-free cloth when handling bulbs.
- Your hands should be dry and free of oil and grease.
- If the newly installed bulb does not come on, visit an authorized Mercedes-Benz Center.

Have the LEDs and bulbs for the following lamps replaced by an authorized Mercedes-Benz Center:

- the additional turn signals in the exterior rear view mirrors
- the high mounted brake lamp
- the brake lamps
- the parking lamps and the side marker lamps in the tail lamp unit
- the rear fog lamps
- the low beam (Xenon or Bi-Xenon\*) lamps
- the front fog lamps
- the front side marker lamps

**i** Have the headlamp adjustment checked regularly.

### Replacing bulbs for front lamps

Before you start to replace a bulb for a front lamp, do the following first:

- ▶ Turn the exterior lamp switch to position **0** (▷ page 128).
- ▶ Open the hood (▷ page 274).

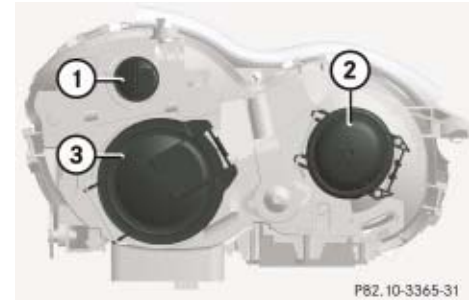

- ① Bulb socket for turn signal lamp
- ② High beam headlamp cover
- ③ Low beam headlamp cover (Xenon or Bi-Xenon\* lamp). **Do not remove.**



### Replacing bulbs



- ④ High beam bulbs
- ⑤ Locking mechanism
- ⑥ Parking and standing lamps

#### Warning!



Do not remove the cover for the Xenon or Bi-Xenon\* headlamp. Because of high voltage in Xenon and Bi-Xenon\* lamps, it is dangerous to replace the bulb or repair the lamp and its components. We recommend that you have such work done by a qualified technician.

#### Front turn signal bulb

- ▶ Turn bulb socket ① counterclockwise and pull it out.
- ▶ Push the bulb into socket ①, turn socket ① counterclockwise and remove it.
- ▶ Insert the new bulb in socket ①, push and turn bulb socket ① clockwise.
- ▶ Reinsert bulb socket ① in lamp and turn bulb socket ① clockwise.

#### High beam/ high beam flasher bulbs

- ▶ Press ends of headlamp cover tab together and remove high beam headlamp cover ②.
- ▶ Pull the electrical connector off.
- ▶ Turn locking mechanism ⑤ counterclockwise and take out the bulb.
- ▶ Insert the new bulb so that the base locates in the recess on the holder.
- ▶ Turn locking mechanism ⑤ clockwise.
- ▶ Plug the connector onto the bulb.
- ▶ Align high beam headlamp cover ② and click it into place.

### Parking and standing lamp bulbs

- ▶ Press ends of cover tab together and remove high beam headlamp cover ②.
- ▶ Pull out bulb socket ⑥ with the bulb.
- ▶ Pull the bulb out of bulb socket ⑥.
- ▶ Insert a new bulb in bulb socket ⑥.
- ▶ Reinstall bulb socket ⑥.
- ▶ Align high beam headlamp cover ② and click it into place.

### Additional turn signal lamp bulbs

The additional turn signal lamps in the exterior rear view mirrors have LEDs.

If a malfunction occurs or LEDs fail to function, the entire turn signal unit must be replaced. Have the turn signal unit replaced by an authorized Mercedes-Benz Center.

### Front side marker lamp bulbs

Since replacing the side marker lamp bulbs is a technically highly demanding process, we recommend you have the side marker lamp bulbs replaced by an authorized Mercedes-Benz Center.

### Replacing bulbs

#### Replacing bulbs for rear lamps

Before you start to replace a bulb for a rear lamp, do the following first:

- ▶ Turn the exterior lamp switch to position **0** (▷ page 128).
- ▶ Open the trunk (▷ page 111).

#### Tail lamp unit

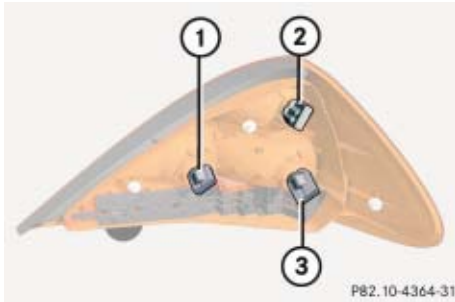

- ① Backup lamp
- ② Driver's side: Rear fog lamp  
Passenger's side: Substitute lamp
- ③ Turn signal lamp

- ▶ Fold the trim to the side and remove it.
- ▶ Turn the bulb socket counterclockwise and pull it out.
- ▶ Gently push the bulb into the socket, turn it counterclockwise and remove it.
- ▶ Insert the new bulb and reinstall the bulb socket.

The bulb socket should audibly click into place.

- ▶ Reinstall the trim.

#### License plate lamp

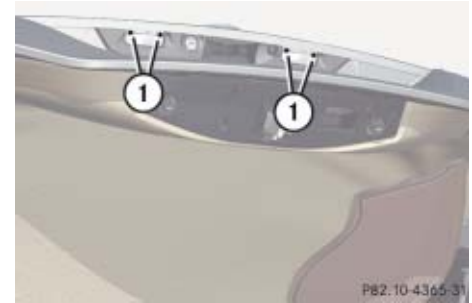

- ① Screws

- ▶ Loosen both screws ①.
- ▶ Remove the license plate lamp.
- ▶ Replace the bulb.
- ▶ Reinstall the license plate lamp.
- ▶ Retighten screws ①.

## ▼ Replacing wiper blades

### Warning!



For safety reasons, switch off wipers and remove SmartKey from starter switch (vehicles with KEYLESS-GO\*): Make sure the vehicle's on-board electronics have status **0** before replacing a wiper blade. Otherwise the wiper motor could suddenly turn on and cause injury.

### Warning!



Wiper blades are components that are subject to wear and tear. Change the wiper blades twice a year, preferably in the spring and fall. Otherwise the windows will not be properly wiped. As a result, you may not be able to observe surrounding traffic conditions and could cause an accident.

**!** To avoid damage to the hood:

- The wiper arms should only be folded forward when in the vertical position.
- Never open the hood when the wiper arm is folded forward.

**!** Never open the hood when the wiper arms are folded forward.

*Hold on to the wiper when folding the wiper arm back. If released, the force of the impact from the tensioning spring could crack the windshield.*

*Do not allow the wiper arms to contact the windshield glass without a wiper blade inserted.*

*Make sure the wiper blades are properly installed. Improperly installed wiper blades may cause windshield damage.*

*For your convenience, we recommend that you have this work carried out by an authorized Mercedes-Benz Center.*

## Placing wiper arms in vertical position



### Wiper blades in vertical position

#### Vehicles with SmartKey

- ▶ Turn SmartKey to starter switch position **1** (▷ page 39).
- ▶ Turn combination switch to wiper setting **II** (▷ page 57).
- ▶ With wiper arms in the vertical position, turn SmartKey in starter switch to position **0**.
- ▶ Remove SmartKey from starter switch.

### Replacing wiper blades

#### Vehicles with KEYLESS-GO\*

- ▶ Turn off the engine (▷ page 62).  
With the driver's door closed, the starter switch is now in position **1**.
- ▶ Turn combination switch to wiper setting **II** (▷ page 57).
- ▶ With wiper arms in the vertical position, open the driver's door.  
The starter switch is set to position **0**, same as SmartKey removed from starter switch.
- ▶ Turn combination switch to wiper setting **0** (▷ page 57).

#### Removing wiper blades

- ▶ Fold the wiper arm forward until it snaps into place.

**!** *Do not pull on the wiper blade inserts. They could tear.*



- ▶ Turn wiper blade at a right angle to the wiper arm.
- ▶ Slide the wiper blade sideways out of the retainer.

#### Installing wiper blades

- ▶ Slide the wiper blade onto the wiper arm in opposite direction of arrow.
- ▶ Rotate the wiper blade into a position parallel to the wiper arm.
- ▶ Fold the wiper arm backward to rest on the windshield. Make sure you hold on to the wiper when folding the wiper arm back.

## ▼ Flat tire

### Preparing the vehicle

- ▶ Park the vehicle in a safe distance from moving traffic on a hard, flat surface when possible.
- ▶ Turn on the hazard warning flashers.
- ▶ Turn the steering wheel so that the front wheels are in a straight ahead position.
- ▶ Set the parking brake.
- ▶ Move the gear selector lever to **P**.

#### Vehicles with SmartKey:

- ▶ Turn off the engine (▷ page 62).

- ▶ Remove the SmartKey from the starter switch.

#### Vehicles with KEYLESS-GO\*:

- ▶ Turn off the engine by pressing the KEYLESS-GO\* button on the gear selector lever once (▷ page 62).
- ▶ Open the driver's door (this puts the starter switch in position **0**, same as with the SmartKey removed from the starter switch). The driver's door then can be closed again.

 *Open door only when conditions are safe to do so.*

- ▶ Have any passenger exit the vehicle at a safe distance from the roadway.

### Mounting the spare wheel

#### Warning!



The dimensions of the spare wheel are different from those of the road wheels. As a result, the vehicle handling characteristics change when driving with a mounted spare wheel. Adapt your driving style accordingly.

The spare wheel is for temporary use only. When driving with spare wheel mounted, ensure proper tire inflation pressure and do not exceed vehicle speed of 50 mph (80 km/h).

Drive to the nearest Mercedes-Benz Center as soon as possible to have the spare wheel replaced with a regular road wheel.

Never operate the vehicle with more than one spare wheel mounted.

Do not switch off the ESP® when a spare wheel is mounted.

### Flat tire

#### Preparing the vehicle

Prepare the vehicle as described (▷ page 405).

- ▶ Turn spare wheel bracket counter-clockwise to loosen.
- ▶ Take the spare wheel out of the trunk (▷ page 389).

#### Removing tensioning straps (vehicles with 19" spare wheel only)

A 19" spare wheel has two tensioning straps on it that must both be removed before mounting the spare wheel.

**i** The tensioning straps are shown in red for illustration purposes. The tensioning straps on the spare wheel of your vehicle are black.

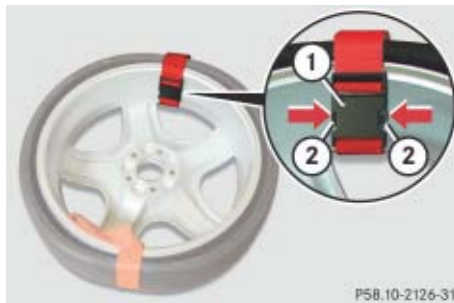

① Buckle

② Clip

- ▶ Press on both clips ② simultaneously to release buckle ①.

**i** Keep the tensioning straps in a safe place. You will need them to store the spare wheel in the trunk after use (▷ page 390).

#### Lifting the vehicle

- ▶ Prevent the vehicle from rolling away by blocking wheels with wheel chocks (not included) or other sizable objects.

When changing wheel on a level surface:

- ▶ Place one wheel chock or other sizable object in front of and another wheel chock or sizable object behind the wheel that is diagonally opposite to the wheel being changed.

Always try lifting the vehicle using the jack on a level surface. However, should circumstances require you to do so on a hill, place a wheel chock or other sizable object and the other wheel chock or sizeable object as follows:

- ▶ Place wheel chocks or other sizable objects on the downhill side blocking both wheels of the axle not being worked on.

- ▶ Take the vehicle tool kit and the jack out of the storage compartment under the trunk floor (▷ page 388).

**Warning!**

The jack is designed exclusively for jacking up the vehicle at the jack tubes built into both sides of the vehicle. To help avoid personal injury, use the jack only to lift the vehicle during a wheel change. Never get beneath the vehicle while it is supported by the jack. Keep hands and feet away from the area under the lifted vehicle. Always firmly set parking brake and block wheels before raising vehicle with jack.

Do not disengage parking brake while the vehicle is raised. Be certain that the jack is always vertical (plumb line) when in use, especially on hills. Always try to use the jack on level surface. Be sure that the jack arm is fully inserted in the jack tube. Always lower the vehicle onto sufficient capacity jack-stands before working under the vehicle.

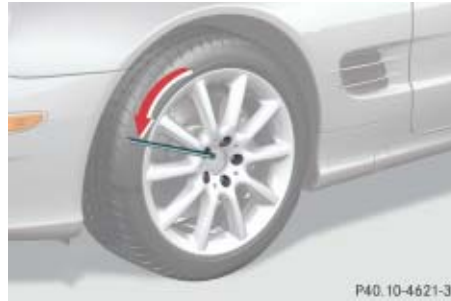

- ▶ On wheel to be changed, loosen but do not yet remove the wheel bolts (approximately one full turn with wrench).

The jack support tubes are located behind the front wheel housings and in front of the rear wheel housings.

**Warning!**

When turning the wheel wrench to loosen the wheel bolts, make sure you position hands on the wrench in such a way that you avoid injury to yourself, such as scraping your hands against the wheel. Make sure turning the wheel wrench will not scratch or damage the wheel rim.





### Flat tire

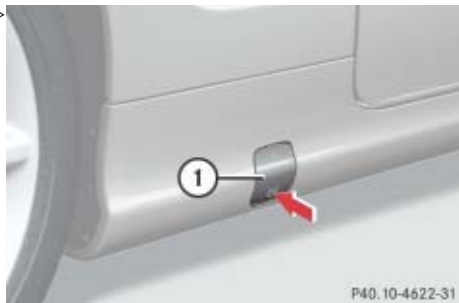

① Jack support tube cover (except SL 55 AMG, SL 65 AMG and vehicles with Sport Package\*)

- ▶ Open cover ① by pressing at point indicated by arrow.
- ▶ Remove cover ①, taking care not to damage the locking tabs.

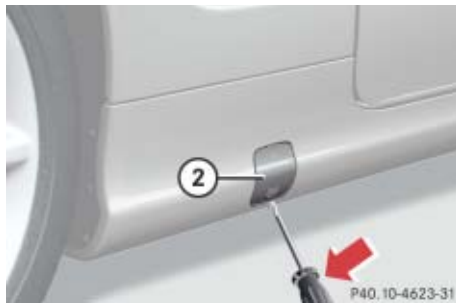

② Jack support tube cover (SL 55 AMG, SL 65 AMG and vehicles with Sport Package\* only)

- ▶ Insert a flat blade screwdriver in the opening of cover ② and pry it out.
- ▶ Remove cover ②, taking care not to damage the locking tabs.

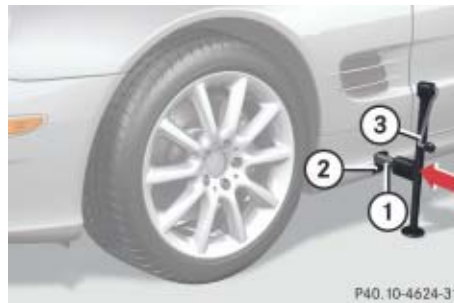

① Jack arm  
② Jack support tube hole  
③ Crank

- ▶ Insert jack arm ① fully into tube hole ② up to the stop.

#### Warning!



Insert the jack arm fully into the jack support tube hole up to the stop. Otherwise the vehicle may fall from the jack and cause personal injury or damage to the vehicle.

- ▶ Keeping jack in this position, turn crank ③ clockwise until the jack base meets the ground. Make sure the jack is vertical (plumb line).
- ▶ Continue to turn the crank until the tire is a maximum of 1.2 in (3 cm) from the ground.

### Removing the wheel

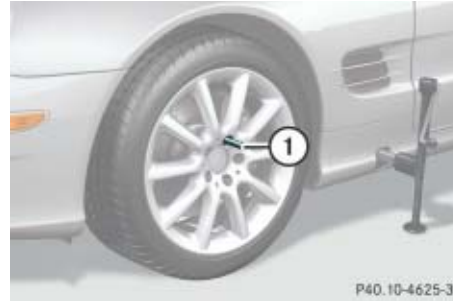

- ① Alignment bolt
- ▶ Unscrew upper-most wheel bolt and remove.
- ▶ Replace this wheel bolt with alignment bolt ① supplied in the tool kit.
- ▶ Remove the remaining bolts.

**!** *Do not place wheel bolts in sand or dirt. This could result in damage to the bolt and wheel hub threads.*

- ▶ Remove the wheel.

### Mounting the new wheel

#### Warning!



Inflate spare wheel tire only after the wheel is properly mounted.

Inflate the spare wheel tire using the electric pump (▷ page 410) before lowering the vehicle.

- ▶ Clean contact surfaces of wheel and wheel hub.
- ▶ Guide the spare wheel onto the alignment bolt and push it on.
- ▶ Insert wheel bolts and tighten them slightly.

### Flat tire

#### Warning!



Always replace wheel bolts that are damaged or rusted.

Never apply oil or grease to wheel bolts.

Damaged wheel hub threads should be repaired immediately. Do not continue to drive under these circumstances! Contact an authorized Mercedes-Benz Center or call Roadside Assistance.

Incorrect wheel bolts or improperly tightened wheel bolts can cause the wheel to come off. This could cause an accident. Be sure to use the correct wheel bolts.

#### Warning!



Only use genuine equipment Mercedes-Benz wheel bolts. They are identified by the Mercedes star. Other wheel bolts may come loose.

Do not tighten the wheel bolts when the vehicle is raised. Otherwise the vehicle could fall off the jack.

- ▶ Unscrew the alignment bolt, install last wheel bolt and tighten slightly.

#### Inflating the spare tire (collapsible tire)

**!** Do not lower the vehicle before inflating the spare wheel tire. Otherwise the rim may be damaged.

- ▶ Take the electric air pump out of the trunk (> page 388).

#### Warning!



Observe instructions on air pump label.

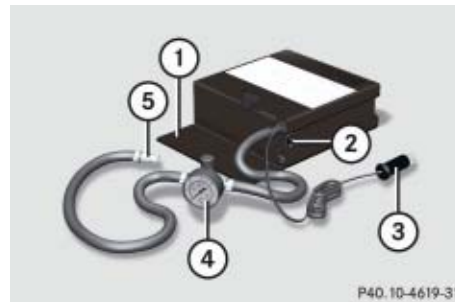

P40.10-4619-31

- ① Flap
  - ② Air pump switch
  - ③ Electrical plug
  - ④ Air hose with pressure gauge and vent screw
  - ⑤ Union nut
- ▶ Open flap ① on air pump.
  - ▶ Pull out electrical plug ③ and air hose with the pressure gauge ④.
  - ▶ Remove the valve cap from the tire valve.
  - ▶ Screw union nut ⑤ onto the tire valve.
  - ▶ Insert electrical plug ③ into vehicle cigar lighter socket.

- ▶ Turn the SmartKey in the starter switch to position **1**.

or

- ▶ Press the KEYLESS-GO\* start/stop button on the gear selector lever once without depressing the brake pedal.
- ▶ Press **I** on the electric air pump switch ②.

The electric air pump should now switch on and inflate the tire.

- ▶ Inflate the spare tire:
  - SL 550 to 36 psi (2.5 bar)
  - SL 600, SL 55 AMG, SL 55 AMG (Performance Package\*), and SL 65 AMG to 51 psi (3.5 bar)

This takes about 5 minutes.

Air hose ④ and union nut ⑤ can become hot during inflation. Exercise proper caution to avoid burning yourself when using the equipment.

**!** Compare the recommended tire inflation pressure for your vehicle with the tire inflation pressure on the yellow label located on the spare wheel rim.

*If the tire inflation pressure on the yellow label on the spare wheel rim differs from the values given in this Operator's Manual, inflate the tire to the recommended tire inflation pressure given on the yellow label on the spare wheel rim.*

**!** Do not operate the electric air pump longer than 8 minutes without interruption. Otherwise it may overheat.

*You may operate the air pump again after it has cooled off.*

- ▶ Press **0** on the electric air pump switch ②.
- ▶ Turn the SmartKey in the starter switch to position **0**.
- or
- ▶ Press KEYLESS-GO\* start/stop button on the gear selector lever twice without depressing the brake pedal.

The electric air pump should now be switched off.

- ▶ If the spare tire inflation pressure is above the recommended tire inflation pressure for the respective collapsible tire (▷ page 440), release excess spare tire inflation pressure using the vent screw.

### Warning!



Follow recommend inflation pressures.

Do not overinflate tires. Overinflating tires can result in sudden deflation (blowout) because they are more likely to become punctured or damaged by road debris, potholes, etc.

Do not underinflate tires. Underinflated tires wear unevenly, adversely affect handling and fuel economy, and are more likely to fail from being overheated.

- ▶ Detach the electric air pump.
- ▶ Stow the electrical plug and the air hose behind the flap and place the air pump back in the trunk.



### Flat tire

- ▷▷ **i** The flat tire may be transported in the trunk when the retractable hardtop is raised. If available, use a protective sheet on the spare wheel.

Vehicles with TPMS or Advanced TPMS\*:

Do not activate the tire inflation pressure monitor until a full size wheel/tire with functioning sensor has been placed back into service on the vehicle.

#### Lowering the vehicle

- ▶ Lower vehicle by turning crank counterclockwise until the full weight of the vehicle is resting on the ground.
- ▶ Pull the jack out of the jack support tube.

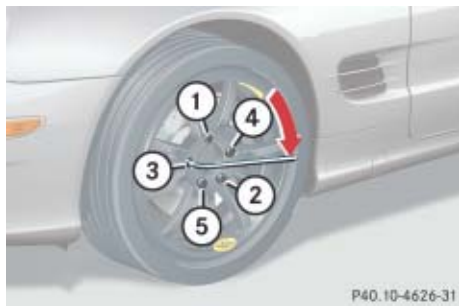

① - ⑤ Wheel bolts

- ▶ Tighten the five wheel bolts evenly, following the diagonal sequence illustrated (① to ⑤), until all bolts are tight. Observe a tightening torque of 96 lb-ft (130 Nm).

#### Warning!



Have the tightening torque checked after changing a wheel. The wheels could come loose if they are not tightened to a torque of 96 lb-ft (130 Nm).

#### Warning!



When turning the wheel wrench to tighten the wheel bolts, make sure you position your hands on the wrench in such a way that you avoid injury to yourself, such as scraping your hands against the wheel. Make sure turning the wheel wrench will not scratch or damage the wheel rim.

- ▶ Before storing the jack in the trunk, crank back to storage position and fold in the arm.

**i** For information on storing the spare wheel back into the trunk, see “Storing the spare wheel after use” (▷ page 390).

#### Replacing jack support tube cover

- ▶ Slide tongue of cover under the upper edge of the tube opening.
- ▶ Applying even pressure, press cover until it snaps into place.

Be careful not to damage the locking tabs or clamp the plastic retaining strap.

## MOExtended system\*

The MOExtended system allows you to continue driving your vehicle even if there is a total loss of pressure in one or more tires.

You may only use the MOExtended system in conjunction with the Run Flat Indicator\* (Canada vehicles) (▷ page 293) or TPMS (U.S. vehicles) (▷ page 295).

**!** *The maximum distance in emergency mode depends on the vehicle's load. It is 30 miles (50 km) if the vehicle is partially loaded and 18 miles (30 km) if the vehicle is fully loaded.*

*The point at which the maximum driving distance begins in emergency mode is when the warning message appears in the multifunction display indicating that there is a loss of tire inflation pressure.*

*Do not exceed the maximum speed of 50 mph (80 km/h).*

### Warning!



In emergency mode, your vehicle's driving characteristics are diminished in such situations as:

- driving around curves
- while braking
- while accelerating rapidly

Therefore, your driving style must be adapted accordingly. Avoid abrupt steering and driving maneuvers, as well as driving over obstacles (road curbs, potholes, or off-road areas). This is especially important if the vehicle is heavily loaded.

The emergency driving distance that can be achieved greatly depends on the demands placed on the vehicle. Depending on speed, load, driving maneuvers, road conditions, outside temperature, etc., the distance can be significantly shorter or, if the vehicle is driven cautiously, somewhat longer.

Do not continue driving in emergency mode if

- you notice knocking sounds
- the vehicle starts to shake
- smoke develops and you smell rubber
- ESP® is intervening continuously
- you notice tears on the tire sidewalls

After driving in emergency mode, you must have the rims inspected by an authorized Mercedes-Benz Center to check if they are suitable for further use. The failed tire must be replaced in any case.

**i** *When replacing individual or all tires on the vehicle, make sure only matching tires marked with "MOExtended" are mounted in the size specified for your vehicle (▷ page 439).*

### Batteries

For more information on batteries, see “Battery” (▷ page 281).

Your vehicle is equipped with two batteries:

- The starter battery
- The battery for electrical consumers (consumer battery), located in the trunk

The starter battery is located on the right-hand side of the engine compartment.

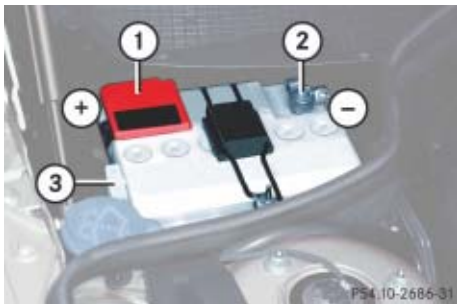

- ① Positive terminal
- ② Negative terminal
- ③ Battery ventilation

**!** The starter battery, its filler caps, and the ventilation hose must always be securely installed when the vehicle is in operation.

The consumer battery is located on the right-hand side of the trunk.



- ④ Positive terminal
- ⑤ Negative terminal

**!** The consumer battery located in the trunk is a valve-regulated lead acid (VRLA) battery, also referred to as “fleece” battery. Such batteries do not require topping-up of the electrolyte level. VRLA batteries therefore do not have cell caps and the battery cover is non-removable. Do not attempt to open the consumer battery as otherwise the battery will be damaged.

Even though VRLA batteries do not require topping-up of the electrolyte level and cannot be opened to check the electrolyte level, the battery condition must be checked periodically by performing a battery conductance test. Refer to Maintenance Booklet for battery condition testing intervals.

As with any other battery, disconnect the consumer battery if you do not intend to operate your vehicle for an extended period of time to prevent battery discharge or connect an accessory battery charge unit expressly approved by Mercedes-Benz for your vehicle model to maintain the battery charge. Contact an authorized Mercedes-Benz Center for further information.

**!** *The factory-equipped VRLA battery is leak-proofed. Only use a battery as replacement that has the same security features and is of identical size, voltage, and capacity as the factory-equipped battery.*

*The battery, the battery ventilation and the lateral plug must always be securely installed when the vehicle is in operation.*

### Warning!



Failure to follow these instructions can result in severe injury or death.

Never lean over batteries while connecting, you might get injured.

Battery fluid contains sulfuric acid. Do not allow this fluid to come in contact with eyes, skin or clothing. In case it does, immediately flush affected area with water and seek medical help if necessary.

A battery will also produce hydrogen gas, which is flammable and explosive. Keep flames or sparks away from battery, avoid improper connection of jumper cables, smoking, etc.

**!** *Never loosen or detach battery terminal clamps while the engine is running or the SmartKey is in the starter switch. Otherwise the alternator and other electronic components could be severely damaged.*

*Have the starter battery checked regularly by an authorized Mercedes-Benz Center.*

*Refer to Maintenance Booklet for maintenance intervals or contact an authorized Mercedes-Benz Center for further information.*

### Warning!



Do not place metal objects on the battery as this could result in a short circuit.

Use leak-proof batteries only to avoid the risk of acid burns in the event of an accident.

### Warning!



The brake system requires electrical power to operate.

A malfunction in the vehicle's power supply or electrical system may impair brake system operation and switch it into its emergency operation mode. The same applies if battery is disconnected. To brake, the driver must then apply significantly greater brake pedal pressure and depress the pedal much further to obtain the expected braking effect. If necessary, apply full pressure to the brake pedal. Brakes are only applied to the front wheels. Stopping distance is increased! Adjust your driving style accordingly. For more information, see "Electro-hydraulic brake system" (> page 92).



#### Warning!



With a disconnected battery

- you will no longer be able to turn the SmartKey in the starter switch and pressing the KEYLESS-GO\* start/stop button on the gear selector lever will have no effect
- the gear selector lever will remain locked in position **P**

#### Disconnecting the batteries

**!** *Always disconnect the batteries in the order described below, even if you only want to charge the starter battery, for example. Otherwise the vehicle's electronics can be damaged.*

- ▶ Apply the parking brake (▷ page 61).
- ▶ Make sure the gear selector lever is set to position **P** (▷ page 168).
- ▶ Close the retractable hardtop (▷ page 199).
- ▶ Turn off all electrical consumers.
- ▶ Turn off the engine (▷ page 62).
- ▶ Remove the SmartKey from the starter switch.
  - ▶ Vehicles with KEYLESS-GO\*: Open the driver's door.

- ▶ Open the trunk.
- ▶ Read and observe safety instructions and precautions (▷ page 281).
- ▶ Open the luggage cover in the trunk (▷ page 206).

- ▶ Remove the trunk floor.

The battery for electrical consumers is located in the right hand area of the trunk (▷ page 388).

- ▶ Use the 10 mm open-end wrench from the vehicle tool kit to disconnect the negative lead from negative terminal ⑤ of the consumer battery (▷ page 414).

- ▶ Open the hood (▷ page 274).
- ▶ Use the 10 mm open-end wrench from the vehicle tool kit to disconnect the negative lead from negative terminal ② of the starter battery (▷ page 414).
- ▶ Remove the covers from the positive terminals ① and ④ (▷ page 414).
- ▶ Disconnect the positive lead from positive terminal ④ of the consumer battery (▷ page 414).
- ▶ Disconnect the positive lead from positive terminal ① of the starter battery (▷ page 414).

## Removing the batteries

### Removing the consumer battery

- ▶ Remove the screws securing the battery in the trunk.
- ▶ Remove the battery support and bracket.
- ▶ Pull out the battery ventilation hose from the battery.

Depending on battery arrangement in your vehicle model, the ventilation tube is located either on the left or right side of the battery.

- ▶ Take out the battery.

### Removing the starter battery

- ▶ Remove the screws securing the starter battery in the engine compartment.
- ▶ Pull battery ventilation ③ (▷ page 414) out of the battery.
- ▶ Lift the retaining bracket.
- ▶ Remove the battery.

## Charging and reinstalling batteries

### Warning!



Never charge a battery while still installed in the vehicle unless the accessory battery charge unit approved by Mercedes-Benz is being used. Gases may escape during charging and cause explosions that may result in paint damage, corrosion or personal injury.

An accessory battery charge unit specially adapted for Mercedes-Benz vehicles and tested and approved by Mercedes-Benz is available, permitting the charging of the battery in its installed position. Contact an authorized Mercedes-Benz Center for information and availability. Charge battery in accordance with the separate instructions for the accessory battery charger.

### Batteries

- ▶ Charge batteries in accordance with the instructions of the battery charger manufacturer.
- ▶ Reinstall the charged batteries. Follow the previously described steps in reverse order.

#### Reconnecting the batteries

---

**!** *Always connect the batteries in the order described below. Otherwise the vehicle's electronics can be damaged.*

- ▶ Turn off all electrical consumers.
- ▶ Install starter battery in the designated location in the engine compartment.
- ▶ Install consumer battery in the designated location in the trunk.
- ▶ Attach supports and brackets.
- ▶ Tighten support and bracket screws.

**!** *Never invert the terminal connections!*

- ▶ Connect positive lead ④ (▷ page 414) of the consumer battery and positive lead ① (▷ page 414) of the starter battery and fasten covers.
- ▶ Connect negative lead ② (▷ page 414) of the starter battery.
- ▶ Connect negative lead ⑤ (▷ page 414) of the consumer battery.
- ▶ Reinstall the trunk floor.
- ▶ Close trunk luggage cover (▷ page 206).

**i** *The following procedures must be carried out following any interruption of battery power (e.g. due to reconnection):*

- *Resynchronize the ESP® (▷ page 355).*
- *Resynchronize side windows (▷ page 198).*

## ▼ Jump starting

### Warning!



Failure to follow these directions will cause damage to the electronic components, and can lead to a battery explosion and severe injury or death.

Never lean over batteries while connecting or jump starting, you might get injured.

Battery fluid contains sulfuric acid. Do not allow this fluid to come in contact with eyes, skin or clothing. In case it does, immediately flush affected area with water, and seek medical help if necessary.

A battery will also produce hydrogen gas, which is flammable and very explosive. Keep flames or sparks away from battery, avoid improper connection of jumper cables, smoking, etc.

Attempting to jump start a frozen battery can result in it exploding, causing personal injury.

Read all instructions before proceeding.

**!** Do not tow-start the vehicle.

**!** Jump starting may only be performed on the battery installed in the engine compartment.

*Avoid repeated and lengthy starting attempts.*

*Do not attempt to start the engine using a battery quick charge unit.*

*If the engine does not run after several unsuccessful starting attempts, have it checked at the nearest authorized Mercedes-Benz Center.*

*Excessive unburned fuel generated by repeated failed starting attempts may damage the catalytic converter and may present a fire risk.*

*Make sure the jumper cables do not have loose or missing insulation.*

*Make sure the cable clamps do not touch any other metal part while the other end is still attached to a battery.*

If the starter battery is discharged, the engine can be started with jumper cables and the battery of another vehicle. Observe the following:

- Jump starting should only be performed when the engine and catalytic converter are cold.
- Do not start the engine if the battery is frozen. Let the battery thaw out first.
- Only jump start from batteries with the same voltage rating (12V). Jump starting with a more powerful battery could damage the vehicle's electrical system, which will not be covered by the Mercedes-Benz Limited Warranty.
- Only use jumper cables with sufficient cross section and insulated terminal clamps.
- Always make sure the jumper cables are not on or near pulleys, fans, or other parts that move when an engine is started or running.

### Jump starting

#### Warning!



Keep flames or sparks away from battery.  
Do not smoke.

Observe all safety instructions and precautions when handling automotive batteries (▷ page 281).

The starter battery is located on the right side of the engine compartment.

- ▶ Make sure the two vehicles do not touch.
- ▶ Turn off all electrical consumers.
- ▶ Apply the parking brake (▷ page 61).
- ▶ Make sure the gear selector lever is set to position **P** (▷ page 168).
- ▶ Open the hood (▷ page 274).
- ▶ Remove the red cover from positive terminal on both vehicles (▷ page 414).

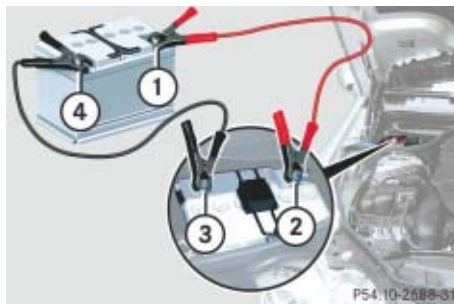

- ① Positive terminal of charged battery
  - ② Positive terminal of discharged battery
  - ③ Negative terminal of discharged battery
  - ④ Negative terminal of charged battery
- ▶ Connect positive terminals ① and ② of the batteries with the red jumper cable. Clamp cable to charged battery ① first.

**!** *Never invert the terminal connections.*

- ▶ Start the engine of the vehicle with the charged battery and run at idle speed.
- ▶ Connect negative terminals ③ and ④ of the batteries with the black jumper cable. Clamp cable to charged battery ③ first.
- ▶ Start the engine of the disabled vehicle.

You can now turn on the electrical consumers. Do not turn on the lights under any circumstances.

- ▶ Remove the jumper cables first from negative terminals ④ and ③ and then from positive terminals ② and ①.

You can now turn on the lights.

- ▶ Have the battery checked at the nearest Mercedes-Benz Center.

## ▼ Towing the vehicle

Mercedes-Benz recommends that the vehicle be transported with all wheels off the ground using flatbed or appropriate wheel lift/dolly equipment.

**!** Use flatbed or wheel lift/dolly equipment with SmartKey in starter switch turned to position **0**.

*Do not tow with sling-type equipment. Towing with sling-type equipment over bumpy roads will damage radiator and supports.*

*To prevent damage during transport, do not tie down vehicle by its chassis or suspension parts.*

*Switch off the tow-away alarm and the automatic central locking.*

When circumstances do not permit the recommended towing methods, the vehicle may be towed with all wheels on the ground or front wheels raised only so far as necessary to have the vehicle moved to a safe location where the recommended towing methods can be employed.

**!** *If the vehicle is towed with the front axle raised, the gear selector lever must be in position **N** and the engine must be shut off (SmartKey in starter switch position **0** or **1**). Otherwise, the ESP® will immediately be engaged and will apply the rear wheel brakes.*

*When towing the vehicle with all wheels on the ground, the gear selector lever must be in position **N** and the SmartKey must be in starter switch position **2**.*

*When towing the vehicle with all wheels on the ground or the front axle raised, the vehicle may be towed only for distances up to 30 miles (50 km) and at a speed not to exceed 30 mph (50 km/h).*

*To be certain to avoid a possibility of damage to the transmission, however, we recommend the drive shaft be disconnected at the rear axle drive flange for any towing beyond a short tow to a nearby garage.*

### Warning!



If circumstances require towing the vehicle with all wheels on the ground, always tow with a tow bar if:

- the engine will not run
- there is a malfunction in the electro-hydraulic brake system
- there is a malfunction in the power supply or in the vehicle's electrical system

as that will be necessary to adequately control the towed vehicle.

Prior to towing the vehicle with all wheels on the ground, make certain that the SmartKey is in starter switch position **2**.

If the SmartKey is left in starter switch position **0** for an extended period of time, it can no longer be turned in the switch. In this case, the steering is locked. To unlock, remove SmartKey from starter switch and re-insert.

### Towing the vehicle

#### Warning!



The brake system requires electrical power to operate.

A malfunction in the vehicle's power supply or electrical system may impair brake system operation and switch it into its emergency operation mode. To brake, the driver must then apply significantly greater brake pedal pressure and depress the pedal much further to obtain the expected braking effect. If necessary, apply full pressure to the brake pedal. Brakes are only applied to the front wheels. Stopping distance is increased! Adapt your driving style accordingly. For more information, see "Electro-hydraulic brake system" (▷ page 92).

With the engine not running, there is no power assistance for the brake and steering systems. In this case, it is important to keep in mind that a considerably higher degree of effort is necessary to brake and steer the vehicle. Adapt your driving accordingly.

**!** When towing the vehicle with all wheels on the ground, please note the following:

*With the automatic central locking activated and the SmartKey in starter switch position 2, or KEYLESS-GO\* start/stop button in position 2, the vehicle doors lock if the left front wheel as well as the right rear wheel are turning at vehicle speeds of approx. 9 mph (15 km/h) or more.*

*To prevent the vehicle door locks from locking, deactivate the automatic central locking (▷ page 119).*

*Towing of the vehicle should only be done using the properly installed towing eye bolt. Never attach tow cable, tow rope or tow rod to the vehicle chassis, frame or suspension parts.*

**i** To signal turns while being towed with the hazard warning flasher in use, turn SmartKey in starter switch to position 2 and activate the combination switch for the left or right turn signal in the usual manner – only the selected turn signal will operate.

*Upon canceling the turn signal, the hazard warning flasher will operate again.*

**i** If the battery is disconnected or discharged

- the SmartKey will not turn in the starter switch
- the gear selector lever will remain locked in position P.

For more information, see "Batteries" (▷ page 414) and "Jump starting" (▷ page 419).

## Installing towing eye bolt

### Front



#### Example illustration (SL 550 and SL 600 without Sport Package)

- ① Cover on passenger side of front bumper

To remove cover:

- ▶ Press mark on cover ① in direction of arrow.
- ▶ Lift cover ① off to reveal the threaded hole for towing eye bolt.

To reinstall cover:

- ▶ Fit locking tabs of cover under the lower edge of the opening in the bumper.
- ▶ Apply even pressure on the upper part of the cover until it snaps into place.

### Rear

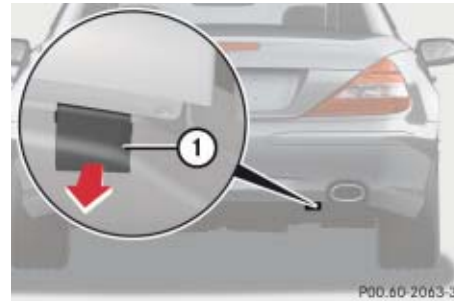

- ① Cover on passenger side of rear bumper

To remove cover:

- ▶ Insert flat, blunt object as a lever into upper left or right recess of cover ①.
- ▶ Loosen cover ① using the lever.

- ▶ Fold cover ① down in direction of arrow to reveal the threaded hole for the towing eye bolt.

To reinstall cover:

- ▶ Fit cover ① and snap into place.

### Installing towing eye bolt

- ▶ Take the towing eye bolt and the wheel wrench from the vehicle tool kit (▷ page 388).
- ▶ Screw towing eye bolt into threaded hole to its stop.
- ▶ Insert wheel wrench into towing eye and tighten towing eye bolt by turning it clockwise.

### Removing towing eye bolt

- ▶ Take the wheel wrench from the vehicle tool kit (▷ page 388).
- ▶ Insert wheel wrench into towing eye and loosen towing eye bolt by turning it counterclockwise.
- ▶ Remove towing eye bolt.



### Fuses

The electrical fuses in your vehicle serve to switch off malfunctioning power circuits.

If a fuse is blown, the components and systems secured by that fuse will stop operating.

#### Warning!



Only use fuses approved by Mercedes-Benz with the specified amperage for the system in question and do not attempt to repair or bridge a blown fuse. Using other than approved fuses or using repaired or bridged fuses may cause an overload leading to a fire, and/or cause damage to electrical components and/or systems. Have the cause determined and remedied by an authorized Mercedes-Benz Center

**i** A blown fuse must be replaced by an appropriate spare fuse (recognizable by its color or the fuse rating given on the fuse) of the amperage recommended in the fuse chart. Any Mercedes-Benz Center will be glad to advise you on this subject.

If a newly inserted fuse blows again, have the cause determined and rectified by an authorized Mercedes-Benz Center.

The following aids are available to help you replace fuses. They are located in the trunk with the vehicle tool kit (▷ page 388).

- Fuse chart
- Spare fuses
- Fuse extractor

The fuse chart explains the fuse allocation and fuse amperages.

The electrical fuses are located in different fuse boxes:

- on the driver's side of the engine compartment (▷ page 425)
- on the passenger side of the engine compartment (▷ page 425)
- under passenger-side rear storage compartment (▷ page 426)
- in the trunk (▷ page 426)

Before replacing fuses:

- ▶ Apply the parking brake (▷ page 61).
- ▶ Make sure the gear selector lever is set to position **P** (▷ page 168).
- ▶ Turn off all electrical consumers.
- ▶ Turn off the engine (▷ page 62).
- ▶ Remove the SmartKey from the starter switch.
- ▶ Vehicles with KEYLESS-GO\*: Open the driver's door.

### Fuse boxes in engine compartment

- ▶ Open the hood (▷ page 274).

The fuse boxes are located on the driver's and passenger side in front of the bulk-head (wall separating the engine and passenger compartment).

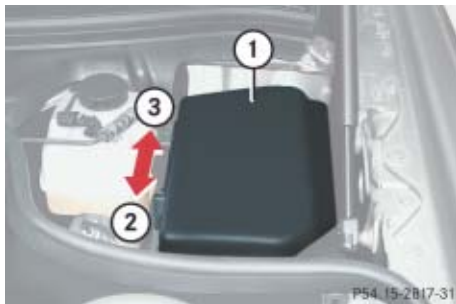

#### Fuse box on driver's side

- ① Fuse box cover
- ② Locking
- ③ Unlocking



#### Fuse box on passenger side

- ① Fuse box cover
- ② Locking
- ③ Unlocking

### Opening

- ▶ Move slide to position ③ and lift cover ①.

### Closing

- ▶ Hook cover ① onto tabs and close it.
- ▶ Move slide to position ②.

**!** The fuse box cover must be properly positioned with the slide at the **🔒** symbol to prevent moisture or dirt from entering the fuse box and possibly impairing fuse operation.

- ▶ Close the hood after checking or replacing fuses (▷ page 275).

### Fuses

#### Fuse box in passenger compartment

The fuse box is located under the rear passenger-side storage compartment.



① Clips

② Storage compartment floor

- ▶ Open the rear passenger-side storage compartment (▷ page 235).
- ▶ Lift both clips ①.

- ▶ Remove storage compartment floor ② in direction of arrow.

You can now access the fuses.

- ▶ To reinstall storage compartment floor ② after checking or replacing fuses, follow the procedure in reverse order.

#### Fuse in trunk

The fuse in the trunk is located on the right-hand side of the trunk.

- ▶ Lift up the trunk floor cover.



#### Emergency engine shut-down

If the engine cannot be turned off as described, you may use the following emergency procedure.

- ▶ Take the fuse chart from the vehicle tool kit (▷ page 388).
- ▶ Find row “Engine emergency stop” in the fuse chart table to identify the fuses that have to be removed as well as their locations.
- ▶ Remove the respective fuses.



**Parts service**

**Warranty coverage**

**Identification labels**

**Layout of poly-V-belt drive**

**Engine**

**Rims and tires**

**Electrical system**

**Main dimensions**

**Weights**

**Fuels, coolants, lubricants, etc.**

The “Technical data” section provides the necessary technical data for your vehicle.

All authorized Mercedes-Benz Centers maintain a stock of Genuine Mercedes-Benz parts required for maintenance and repair work. In addition, strategically located parts distribution centers provide quick and reliable parts service.

More than 300 000 different parts for Mercedes-Benz models are available.

Genuine Mercedes-Benz parts are subjected to stringent quality inspections. Each part has been specifically developed, manufactured or selected for and adapted to Mercedes-Benz vehicles.

Therefore, Genuine Mercedes-Benz parts should be installed.

**!** *The use of non-genuine Mercedes-Benz parts and accessories not authorized by Mercedes-Benz could damage the vehicle, which is not covered by the Mercedes-Benz Limited Warranty, or could compromise the vehicle’s durability or safety.*

### ▼ Warranty coverage

Your vehicle is covered under the terms of the warranties printed in the Service and Warranty Information booklet. Your authorized Mercedes-Benz Center will exchange or repair any defective parts originally installed in the vehicle in accordance with the terms of the following warranties:

- New Vehicle Limited Warranty
- Emission System Warranty
- Emission Performance Warranty
- California, Maine, Massachusetts, and Vermont Emission Control Systems Warranty

Replacement parts and accessories are covered by the Mercedes-Benz Parts and Accessories warranties, copies of which are available at any Mercedes-Benz Center.

### Loss of Service and Warranty Information Booklet

---

Should you lose your Service and Warranty Information booklet, have an authorized Mercedes-Benz Center arrange for a replacement. It will be mailed to you.

## Identification labels



- ① Certification label  
(includes Paintwork code)



### Example certification label (U.S. vehicles)

- ② Vehicle Identification Number (VIN)
- ③ Paintwork code



### Example certification label (Canada vehicles)

- ② Vehicle Identification Number (VIN)
- ③ Paintwork code

**i** Data shown on certification labels are for illustration purposes only. These data are specific to each vehicle and may vary from data shown in the illustration. Refer to certification label on vehicle for actual data specific to your vehicle.

The vehicle identification number (VIN) is also embossed under a trim below the passenger-side rear storage compartment lid.

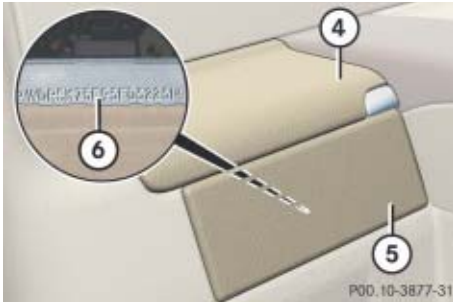

- ④ Storage compartment lid
- ⑤ Trim
- ⑥ Vehicle Identification Number (VIN)  
(below right rear storage compartment)

- ▶ Open storage compartment lid ④.
- ▶ Remove storage compartment trim ⑤.

The VIN ⑥ is located on the metal strap above the floor carpet.

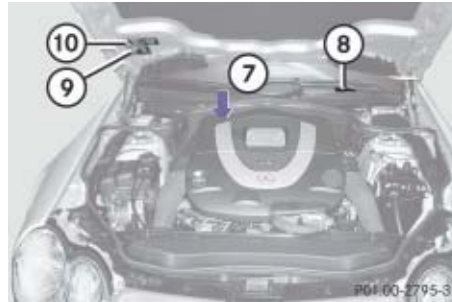

- ⑦ Engine number (engraved on engine)
- ⑧ VIN, visible (lower edge of windshield)
- ⑨ Emission control information label, includes both federal and California certification exhaust emission standards
- ⑩ Vacuum line routing diagram label

**i** When ordering parts, please specify vehicle identification and engine number.



## Layout of poly-V-belt drive

SL 550

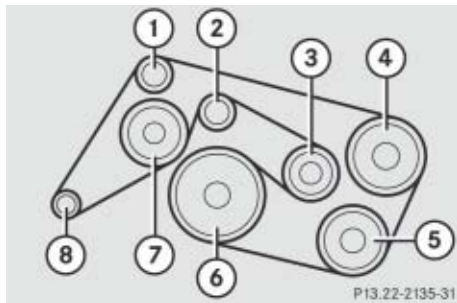

- ① Idler pulley
- ② Idler pulley
- ③ Automatic belt tensioner
- ④ ABC tandem pump (pump for power-steering assistance and ABC chassis)
- ⑤ Air conditioning compressor
- ⑥ Crankshaft
- ⑦ Coolant pump
- ⑧ Generator (alternator)

SL 55 AMG

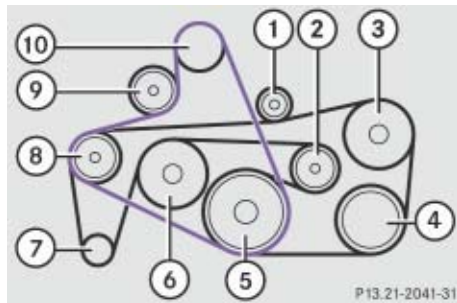

**The SL 55 AMG has two poly-V-belts (belt one shown in purple/belt two shown in black).**

- ① Idler pulley
- ② Automatic belt tensioner
- ③ ABC tandem pump (pump for power-steering assistance and ABC chassis)
- ④ Air conditioning compressor
- ⑤ Crankshaft
- ⑥ Coolant pump
- ⑦ Generator (alternator)
- ⑧ Idler pulley
- ⑨ Automatic belt tensioner
- ⑩ Supercharger

SL 600, SL 65 AMG

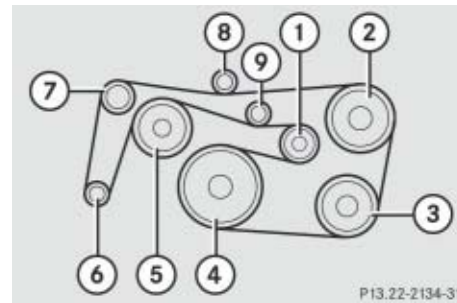

- ① Automatic belt tensioner
- ② ABC tandem pump (pump for power-steering assistance and ABC chassis)
- ③ Air conditioning compressor
- ④ Crankshaft
- ⑤ Coolant pump
- ⑥ Generator (alternator)
- ⑦ Idler pulley
- ⑧ Idler pulley
- ⑨ Idler pulley

▼ Engine

Model	SL 550 (230.471) <sup>1</sup>	SL 600 (230.477) <sup>1</sup>
Engine	273	275
Mode of operation	4-stroke engine, gasoline injection	4-stroke engine, gasoline injection
No. of cylinders	8	12
Bore	3.82 in (97.00 mm)	3.23 in (82.00 mm)
Stroke	3.31 in (84.00 mm)	3.43 in (87.00 mm)
Total piston displacement	333.3 cu in (5461 cm <sup>3</sup> )	336.4 cu in (5513 cm <sup>3</sup> )
Compression ratio	10.7:1	9:1
Output acc. to SAE J 1349	382 hp/6000 rpm <sup>2</sup> (285 kW/6000 rpm)	510 hp/5000 rpm <sup>2</sup> (380 kW/5000 rpm)
Maximum torque acc. to SAE J 1349	391 lb-ft/2700 rpm (530 Nm/2800 - 4800 rpm)	612 lb-ft/1900 - 3500 rpm (830 Nm/1900 - 3500 rpm)
Maximum engine speed	6500 rpm	5950 rpm
Firing order	1-5-4-2-6-3-7-8	1-12-5-8-3-10-6-7-2-11-4-9
Poly-V-belt	2404 mm	2335 mm

<sup>1</sup> The quoted data apply only to the standard vehicle. See an authorized Mercedes-Benz Center for the corresponding data of all special bodies and special equipment.

<sup>2</sup> Premium fuel required. Performance may vary with fuel octane rating.

**Engine**

<b>Model</b>	<b>SL 55 AMG (230.474)<sup>1</sup></b>	<b>SL 65 AMG (230.479)<sup>1</sup></b>
<b>Engine</b>	113	275
<b>Mode of operation</b>	4-stroke engine, gasoline injection	4-stroke engine, gasoline injection
<b>No. of cylinders</b>	8	12
<b>Bore</b>	3.25 in (82.60 mm)	3.25 in (82.60 mm)
<b>Stroke</b>	3.66 in (93.00 mm)	3.66 in (93.00 mm)
<b>Total piston displacement</b>	331.8 cu in (5439 cm <sup>3</sup> )	364.9 cu in (5980 cm <sup>3</sup> )
<b>Compression ratio</b>	11:1	9:1
<b>Output acc. to SAE J 1349</b>	510 hp/6 100 rpm <sup>2</sup> (380 kW/6 100 rpm)	603 hp/4 800-5 100 rpm <sup>2</sup> (450 kW/4 800-5 100 rpm)
<b>Maximum torque acc. to SAE J 1349</b>	530 lb-ft/2 600-4 000 rpm (720 Nm/2 600-4 000 rpm)	738 lb-ft/2 000-4 000 rpm (1 000 Nm/2 000-4 000 rpm)
<b>Maximum engine speed</b>	6 500 rpm	5 950 rpm
<b>Firing order</b>	1-5-4-2-6-3-7-8	1-12-5-8-3-10-6-7-2-11-4-9
<b>Poly-V-belt</b>	2 462 mm/1 289 mm	2 335 mm

<sup>1</sup> The quoted data apply only to the standard vehicle. See an authorized Mercedes-Benz Center for the corresponding data of all special bodies and special equipment.

<sup>2</sup> Premium fuel required. Performance may vary with fuel octane rating.

▼ Rims and tires

**!** Only use tires which have been tested and approved by Mercedes-Benz. Tires approved by Mercedes-Benz are developed to provide best possible performance in conjunction with the driving safety systems on your vehicle such as ABS or ESP®. Tires specially developed for your vehicle and tested and approved by Mercedes-Benz can be identified by finding the following on the tire's sidewall:

- MO = Mercedes-Benz Original equipment tires  
AMG vehicles:  
Does not apply to all approved tires on AMG vehicles. For information on tested and approved tires for AMG vehicles, contact an authorized Mercedes-Benz Center.
- MOE = Mercedes-Benz Original Extended (tires with limited run-flat characteristics) original equipment tires

Using tires other than those approved by Mercedes-Benz may result in damage that is not covered by the Mercedes-Benz Limited Warranty.

**i** For information on driving with MOExtended tires, see "MOExtended system"(> page 301).

**!** Using tires other than those approved by Mercedes-Benz can have detrimental effects, such as

- poor handling characteristics
- increased noise
- increased fuel consumption

Moreover, tires and rims not approved by Mercedes-Benz may, under load, exhibit dimensional variations and different tire deformation characteristics that could cause them to come into contact with the vehicle body or axle parts. Damage to the tires or the vehicle may be the result.

**i** Further information on tires and rims is available at any authorized Mercedes-Benz Center. A placard with the recommended tire inflation pressures is located on the driver's door B-pillar. Some vehicles may have supplemental tire inflation pressure information for driving at high speeds (> page 292) or for vehicle loads less than the maximum loaded vehicle condition (> page 292). If such information is provided, it can be found on the placard located on the inside of the fuel filler flap.

The tire inflation pressure should be checked regularly and should only be adjusted on cold tires. Follow tire manufacturer's maintenance recommendation included with vehicle.

**i** The following pages also list the approved wheel rim and tire sizes for equipping your vehicles with winter tires. Winter tires are not available as standard or optional factory equipment, but can be purchased from an authorized Mercedes-Benz Center.

Depending on vehicle model and the standard or optional factory-equipped wheel rim/tire configuration on your vehicle (Performance Package, Sport Package etc.), equipping your vehicle with winter tires approved for your vehicle model may also require the purchase of two or four wheel rims of the recommended size for use with these winter tires. See an authorized Mercedes-Benz Center for more information.

## Rims and tires

### Same size tires

#### 18" tires

	SL 550	SL 600	SL 55 AMG
<b>Rims (light alloy)</b>	8.5 J x 18 H2	8.5 J x 18 H2	8.5 J x 18 H2
<b>Wheel offset</b>	1.38 in (35 mm)	1.38 in (35 mm)	1.18 in (30 mm)
<b>Summer tires</b> <sup>1</sup>	-	-	-
<b>Winter tires</b> <sup>1,2</sup>	255/40 R18 95V M+S 	255/40 R18 95V M+S 	255/40 R18 95V M+S 

<sup>1</sup> Radial-ply tires

<sup>2</sup> Not available as factory equipment.

#### 19" tires

	SL 55 AMG (Performance Package*) SL 65 AMG
<b>Rims (light alloy)</b>	8.5 J x 19 EH2
<b>Wheel offset</b>	1.18 in (30 mm)
<b>Summer tires</b>	-
<b>Winter tires</b> <sup>1,2</sup>	255/35 R19 96V XL (Extra Load) M+S 

<sup>1</sup> Radial-ply tires

<sup>2</sup> Not available as factory equipment.

Mixed size tires

	SL 550	SL 600
<b>Front axle:</b>		
<b>Rims (light alloy)</b>	8.5 J x 18 H2	8.5 J x 18 H2
<b>Wheel offset</b>	1.38 in (35 mm)	1.38 in (35 mm)
<b>Summer tires<sup>1</sup></b>	255/40 R18 95W	255/40 R18 95Y
<b>Rear axle:</b>		
<b>Rims (light alloy)</b>	9.5 J x 18 H2	9.5 J x 18 H2
<b>Wheel offset</b>	1.57 in (40 mm)	1.57 in (40 mm)
<b>Summer tires<sup>1,2</sup></b>	285/35 R18 97W	285/35 R18 97Y

<sup>1</sup> Radial-ply tires

<sup>2</sup> Must not be used with snow chains.

## Rims and tires

	SL 55 AMG* SL 550 (Sport Package*) SL 600 (Sport Package*)	SL 55 AMG SL 55 AMG (Performance Package*) SL 65 AMG
--	--	--

### Front axle:

<b>Rims (light alloy)</b>	8.5 J x 18 H2	8.5 J x 19 EH2
<b>Wheel offset</b>	1.18 in (30 mm)	1.18 in (30 mm)
<b>Summer tires<sup>1</sup></b>	255/40 ZR18 95Y	255/35 ZR19 96Y XL (Extra Load)

### Rear axle:

<b>Rims (light alloy)</b>	9.5 J x 18 H2	9.5 J x 19 EH2
<b>Wheel offset</b>	1.30 in (33 mm)	1.22 in (31 mm)
<b>Summer tires<sup>1,2</sup></b>	285/35 ZR18 97Y	285/30 ZR19 98Y XL (Extra Load)

<sup>1</sup> Radial-ply tires

<sup>2</sup> Must not be used with snow chains.

**MOExtended tires\***

	<b>SL 550</b> <b>SL 550 (Sport Package*)</b> <b>SL 600</b> <b>SL 600 (Sport Package*)</b> <b>SL 55 AMG</b>
--	--

**Front axle:**

<b>Rims (light alloy)</b>	8.5 J x 18 H2
<b>Wheel offset</b>	1.18 in (30 mm)
<b>Summer tires</b> <sup>1,2</sup>	255/40 R18 95Y <i>MOExtended</i>
<b>Winter tires</b> <sup>1,2,4</sup>	255/40 R18 95V M+S  <i>MOExtended</i>

**Rear axle:**

<b>Rims (light alloy)</b>	9.5 J x 18 H2
<b>Wheel offset</b>	1.30 in (33 mm)
<b>Summer tires</b> <sup>1,2,3</sup>	285/35 R18 97Y <i>MOExtended</i>
<b>Winter tires</b> <sup>1,2,3,4</sup>	285/35 R18 97V M+S  <i>MOExtended</i>

<sup>1</sup> Radial-ply tires

<sup>2</sup> Must be used in conjunction with Tire Pressure Monitoring System (U.S. vehicles), Run Flat Indicator (Canada vehicles), or Advanced Tire Pressure Monitoring System\* (Canada vehicles) only.

<sup>3</sup> Must not be used with snow chains.

<sup>4</sup> Not available as factory equipment.



## Rims and tires

### Spare wheel

	SL 550	SL 600 SL 55 AMG	SL 55 AMG (Performance Package*) SL 65 AMG
<b>Rim</b>	6 B x 17 H2	6 B x 18	6.5 B x 19
<b>Wheel offset</b>	0.98 in (25 mm)	0.98 in (25 mm)	0.55 in (14 mm)
<b>Collapsible tire<sup>1</sup></b>	185/60-17 93P	175/55-18 95P	175/50-19 97P
<b>Recommended tire inflation pressure</b>	36 psi (2.5 bar)	51 psi (3.5 bar)	51 psi (3.5 bar)

<sup>1</sup> Must not be used with snow chains.

**!** Please compare the recommended tire inflation pressure for your vehicle with the tire inflation pressure on the yellow label located on the spare wheel rim.

If the tire inflation pressure on the yellow label on the spare wheel rim differs from the values given in this Operator's Manual, inflate the collapsible tire to the recommended tire inflation pressure given on the yellow label on the spare wheel rim.

**i** Please note that the tire inflation pressure of the collapsible tire differs from the tire inflation pressure of the road tires.

▼ Electrical system

Model	SL 550	SL 600	SL 55 AMG	SL 65 AMG
Generator (alternator)	14 V/150 A	14 V/180 A	14 V/180 A	14 V/180 A
Starter motor	12 V/1.7 kW	12 V/1.7 kW	12 V/1.7 kW	12 V/1.7 kW
Starter battery	12 V/35 Ah	12 V/35 Ah	12 V/35 Ah	12 V/35 Ah
Battery for electrical consumers	12 V/70 Ah	12 V/70 Ah	12 V/70 Ah	12 V/70 Ah
Spark plugs	Bosch Y 7 MPP 33 NGK PLKR6A	NGK IFR6QG	NGK ILFR6A	NGK IFR6QG
Electrode gap	0.031 in (0.8 mm)	0.028 in (0.7 mm)	0.031 in (0.8 mm)	0.028 in (0.7 mm)
Tightening torque	15 – 18 lb-ft (20 – 25 Nm)	18 – 22 lb-ft (25 – 30 Nm)	18 – 22 lb-ft (25 – 30 Nm)	18 – 22 lb-ft (25 – 30 Nm)

### Main dimensions

Model	SL 550	SL 600	SL 55 AMG	SL 65 AMG
<b>Overall vehicle length</b>	178.5 in (4540 mm)	178.5 in (4540 mm)	178.5 in (4535 mm)	178.5 in (4535 mm)
<b>Overall vehicle length when opening/closing hardtop</b>	185.6 in (4713 mm)	185.6 in (4713 mm)	185.6 in (4713 mm)	185.6 in (4713 mm)
<b>Overall vehicle width (exterior rear view mirrors folded out)</b>	80.0 in (2033 mm)	80.0 in (2033 mm)	80.0 in (2033 mm)	80.0 in (2033 mm)
<b>Overall vehicle width (exterior rear view mirrors folded in)</b>	71.9 in (1827 mm)	71.9 in (1827 mm)	71.9 in (1827 mm)	71.9 in (1827 mm)
<b>Overall vehicle height</b>	51.0 in (1295 mm)	51.0 in (1295 mm)	51.0 in (1295 mm)	51.0 in (1295 mm)
<b>Overall vehicle height when opening/closing hardtop</b>	65.9 in (1674 mm)	65.9 in (1674 mm)	65.9 in (1674 mm)	65.9 in (1674 mm)
<b>Wheelbase</b>	100.8 in (2560 mm)	100.8 in (2560 mm)	100.8 in (2560 mm)	100.8 in (2560 mm)
<b>Track, front</b>	61.4 in (1559 mm)	61.4 in (1559 mm)	61.8 in (1569 mm)	61.8 in (1569 mm)
<b>Track, rear</b>	60.5 in (1537 mm)	60.5 in (1537 mm)	61.2 in (1555 mm)	61.1 in (1551 mm)
<b>Turning circle</b>	36.1 ft (11.0m)	36.1 ft (11.0m)	36.1 ft (11.0m)	36.1 ft (11.0m)

▼ **Weights**

**Trunk load max.** 220 lbs (100 kg)

### Fuels, coolants, lubricants, etc.

#### Capacities

Vehicle components and their respective lubricants must match. Therefore use only products tested and approved by Mercedes-Benz.

Please refer to the Factory Approved Service Products pamphlet, or inquire at your Mercedes-Benz Center.

#### Warning!



Comply with all valid regulations with respect to handling, storing and disposing of service fluids. Otherwise you could endanger persons or the environment.

Keep service fluids out of the reach of children.

If a service fluid is swallowed, contact a physician immediately.

	Model	Capacity	Fuels, coolants, lubricants, etc.
Engine with oil filter	SL 550	9.0 US qt (8.5 l)	Approved engine oils
	SL 600	8.5 US qt (8.0 l)	
	SL 55 AMG	9.0 US qt (8.5 l)	
	SL 65 AMG	8.5 US qt (8.0 l)	
Automatic transmission	SL 550	9.5 US qt (9.0 l)	MB Automatic Transmission Fluid
	SL 600	8.0 US qt (7.5 l)	
	SL 55 AMG	9.1 US qt (8.6 l)	
	SL 65 AMG	8.0 US qt (7.5 l)	

Fuels, coolants, lubricants, etc.

	Model	Capacity	Fuels, coolants, lubricants, etc.
Rear axle	SL 550	1.3 US qt (1.2 l)	Hypoid gear oil SAE 85 W 90
	SL 600	1.3 US qt (1.2 l)	Hypoid gear oil SAE 85 W 90
	SL 55 AMG	1.3 US qt (1.2 l)	Hypoid gear oil SAE 85 W 90
	SL 65 AMG	1.3 US qt (1.2 l)	Hypoid gear oil SAE 75 W 140
Hydraulic system for active body control (ABC)		approx. 4.0 US qt (3.8 l)	MB Hydraulic Fluid
Power steering		approx. 1.1 US qt (1.0 l)	MB Power Steering Fluid (Pentosin CHF 11S)
Front wheel hubs		approx. 3.0 oz (85 g) each	High temperature roller bearing grease
Brake system		1.1 US qt (1.05 l)	MB Brake Fluid (DOT 4+)
Cooling system	SL 550	approx. 12.3 US qt (11.6 l)	MB 325.0 Anticorrosion/Antifreeze
	SL 600	approx. 13.6 US qt (12.9 l)	
	SL 55 AMG	approx. 12.7 US qt (12.0 l)	
	SL 65 AMG	approx. 16.4 US qt (15.5 l)	
Low temperature cooling system	SL 600	approx. 2.2 US qt (2.1 l)	MB 325.0 Anticorrosion/Antifreeze
	SL 65 AMG	approx. 3.1 US qt (2.9 l)	
Fuel tank including a reserve of	All models	21.1 US gal (80.0 l)	Premium unleaded gasoline: Minimum Posted Octane 91 (Avg. of 96 RON/86 MON)
	SL 550	2.6 US gal (10.0 l)	
	SL 600	2.6 US gal (10.0 l)	
	SL 55 AMG	3.7 US gal (14.0 l)	
	SL 65 AMG	3.7 US gal (14.0 l)	

### Fuels, coolants, lubricants, etc.

	Model	Capacity	Fuels, coolants, lubricants, etc.
Air conditioning system			R-134a refrigerant and special PAG lubricant oil (never R-12)
Hydraulic system for retractable hardtop		0.42 US qt (0.4 l)	MB Hydraulic Fluid
Windshield washer and headlamp cleaning system		7.4 US qt (7 l)	MB Windshield Washer Concentrate <sup>1</sup>

<sup>1</sup> Use MB Windshield Washer Concentrate “S” and water for temperatures above freezing or MB Windshield Washer Concentrate “S” and commercially available pre-mixed windshield washer solvent/antifreeze for temperatures below freezing. Follow suggested mixing ratios (▷ page 452).

### Engine oils

Engine oils are specifically tested for their suitability in our engines and durability for our service intervals. Therefore, only use approved engine oils and oil filters required for vehicles with Maintenance System (U.S. vehicles) or FSS (Canada vehicles). For a listing of approved engine oils and oil filters, refer to the Factory Approved Service Products pamphlet, or contact an authorized Mercedes-Benz Center.

**!** *Using engine oils and oil filters of specification other than those expressly required for the Maintenance System (U.S. vehicles) or FSS (Canada vehicles), or changing oil and oil filter at change intervals longer than those called for by the Maintenance System (U.S. vehicles) or FSS (Canada vehicles) will result in engine or emission control system damage not covered by the Mercedes-Benz Limited Warranty.*

*Please follow Maintenance System (U.S. vehicles) or FSS (Canada vehicles) recommendations for scheduled oil changes. Failure to do so could result in engine or emission control system damage not covered by the Mercedes-Benz Limited Warranty.*

### Engine oil additives

Do not blend oil additives with engine oil. They may damage the engine.

Damage or malfunctions resulting from blending oil additives are not covered by the Mercedes-Benz Limited Warranty.

### Air conditioning refrigerant

R-134a (HFC) refrigerant and special PAG lubricating oil are used in the air conditioner system.

Never use R-12 (CFC) or mineral-based lubricating oil. Otherwise damage to the system will occur.

### Brake fluid

During vehicle operation, the boiling point of the brake fluid is continuously reduced through the absorption of moisture from the atmosphere.

#### Warning!



Under extremely strenuous operating conditions, this moisture content can lead to the formation of bubbles in the system, thus reducing the system's efficiency.

Therefore, the brake fluid must be replaced regularly. Refer to your vehicle's Maintenance Booklet for replacement interval.

Only brake fluid approved by Mercedes-Benz is recommended. Your authorized Mercedes-Benz Center will provide you with additional information.

### Premium unleaded gasoline

#### Warning!



Gasoline is highly flammable and poisonous. It burns violently and can cause serious injury. Whenever you are around gasoline, avoid inhaling fumes and skin contact, extinguish all smoking materials. Never allow sparks, flame or smoking materials near gasoline!

**!** To maintain the engine's durability and performance, premium unleaded gasoline must be used. If premium unleaded is not available and low octane fuel is used, follow these precautions:

- have the fuel tank only partially filled with unleaded regular and fill up with premium unleaded as soon as possible
- avoid full throttle driving and abrupt acceleration
- do not exceed an engine speed of 3000 rpm if the vehicle is loaded with a light load such as two occupants and no luggage
- do not exceed  $\frac{2}{3}$  of maximum accelerator pedal position if the vehicle is fully loaded or operating in mountainous terrain



### Fuels, coolants, lubricants, etc.

#### Fuel requirements

---

Only use premium unleaded fuel:

- The octane number (posted at the pump) must be 91 min. It is an average of both the Research (R) octane number and the Motor (M) octane number:  $(R+M)/2$ . This is also known as the ANTI-KNOCK INDEX.

Unleaded gasoline containing oxygenates such as ethanol, IPA, IBA and TBA can be used provided the ratio of any one of these oxygenates to gasoline does not exceed 10%; MTBE must not exceed 15%.

The ratio of methanol to gasoline must not exceed 3% plus additional cosolvents.

Using mixtures of ethanol and methanol is not allowed. Gasohol, which contains 10% ethanol and 90% unleaded gasoline, can be used.

These blends must also meet all other fuel requirements, such as resistance to spark knock, boiling range, vapor pressure, etc.

#### Gasoline additives

---

A major concern among engine manufacturers is carbon build-up caused by gasoline. Mercedes-Benz recommends only the use of quality gasoline containing additives that prevent the build-up of carbon deposits.

After an extended period of using fuels without such additives carbon deposits can build up, especially on the intake valves and in the combustion area, leading to engine performance problems such as:

- Warm-up hesitation
- Unstable idle
- Knocking/pinging
- Misfire
- Power loss

## Fuels, coolants, lubricants, etc.

In areas where carbon deposits may be encountered due to lack of availability of gasolines which contain these additives, Mercedes-Benz recommends the use of additives approved by us for use on Mercedes-Benz vehicles. Refer to Factory Approved Service Products pamphlet for a listing of approved product(s). Follow directions on product label.

Do not blend other fuel additives with fuel. This only results in unnecessary cost and may be harmful to the engine operation.

Damage or malfunction resulting from poor fuel quality or from blending additional fuel additives other than those tested and approved by us for use on Mercedes-Benz vehicles listed in the Factory Approved Service Products pamphlet are not covered by the Mercedes-Benz Limited Warranty.

### Coolants

The engine coolant is a mixture of water and anticorrosion/antifreeze, which provides:

- corrosion protection
- freeze protection
- boiling protection (by increasing the boiling point)

The cooling system was filled at the factory with a coolant providing freeze protection to approximately  $-22^{\circ}\text{F}$  ( $-30^{\circ}\text{C}$ ) and corrosion protection.

**!** *Add premixed coolant solution only. Adding water and MB 325.0 Anticorrosion/Antifreeze separately from each other, could cause engine damage not covered by the Mercedes-Benz Limited Warranty.*

If the antifreeze mixture is effective to  $-22^{\circ}\text{F}$  ( $-30^{\circ}\text{C}$ ), the boiling point of the coolant in the pressurized cooling system is reached at approximately  $266^{\circ}\text{F}$  ( $130^{\circ}\text{C}$ ).

The coolant solution must be used year round to provide the necessary corrosion protection and increase in the boil-over protection. Refer to Maintenance Booklet for replacement interval.

Coolant system design and coolant used stipulate the replacement interval. The replacement interval published in the Maintenance Booklet is only applicable if MB 325.0 anticorrosion/antifreeze solution or other Mercedes-Benz approved products of equal specification (see Factory Approved Service Products pamphlet) are used to renew the coolant concentration or bring it back up to the proper level.

### Fuels, coolants, lubricants, etc.

To provide important corrosion protection, the solution must be at least 45% anticorrosion/antifreeze (equivalent to freeze protection to approx. - 22°F [-30°C]). If you use a solution that is more than 55% anticorrosion/antifreeze (freeze protection to approx. - 49°F [-45°C]), the engine temperature will increase due to the lower heat transfer capability of the solution. Therefore, do not use more than this amount of anticorrosion/antifreeze.

If the coolant level is low, water and MB 325.0 Anticorrosion/Antifreeze should be used to bring it up to the proper level (have cooling system checked for signs of leakage). Please make sure the mixture is in accordance with label instructions.

The water in the cooling system must meet minimum requirements, which are usually satisfied by normal drinking water. If you are not sure about the water quality, consult an authorized Mercedes-Benz Center.

**Fuels, coolants, lubricants, etc.**

**Anticorrosion/antifreeze**

Your vehicle contains a number of aluminum parts. The use of aluminum components in motor vehicle engines necessitates that anticorrosion/antifreeze coolant used in such engines be specifically formulated to protect the aluminum

parts. (Failure to use such anticorrosion/antifreeze coolant will result in a significantly shortened service life.)

Therefore, the following product is strongly recommended for use in your vehicle: Mercedes-Benz 325.0 anticorrosion/antifreeze agent.

Before the start of the winter season (or once a year in hot southern regions), you should have the anticorrosion/antifreeze concentration checked. The coolant is also regularly checked each time you bring your vehicle to an authorized Mercedes-Benz Center for service.

**Anticorrosion/antifreeze quantity**

Model	Approx. freeze protection	
	- 35°F (- 37°C)	- 49°F (- 45°C)
SL 550	6.1 US qt (5.8 l)	6.8 US qt (6.4 l)
SL 600 (main cooling system)	6.9 US qt (6.5 l)	7.5 US qt (7.1 l)
SL 600 (low temperature cooling system)	1.2 US qt (1.1 l)	1.3 US qt (1.2 l)
SL 55 AMG	6.3 US qt (6.0 l)	7.0 US qt (6.6 l)
SL 65 AMG (main cooling system)	8.2 US qt (7.75 l)	9.0 US qt (8.5 l)
SL 65 AMG (low temperature cooling system)	1.5 US qt (1.45 l)	1.7 US qt (1.6 l)

### Fuels, coolants, lubricants, etc.

#### Windshield and headlamp washer system

---

Both the windshield and headlamp washer systems are supplied from the windshield washer fluid reservoir.

The windshield and headlamp washer fluid reservoir has a capacity of approx. 7.4 US qt (7 l).

- ▶ Refill the reservoir with MB Windshield Washer Concentrate and water (or concentrate and commercially available premixed windshield washer solvent/antifreeze, depending on ambient temperatures).

#### Warning!



Washer solvent/antifreeze is highly flammable. Do not spill washer solvent/antifreeze on hot engine parts because it may ignite and burn. You could be seriously burned.

#### Windshield and headlamp washer fluid mixing ratio

For temperatures above freezing point, use MB Windshield Washer Concentrate “MB SummerFit” and water:

- 1 part “MB SummerFit” to 100 parts water  
(1.34 fl oz [40 ml] “MB SummerFit” to 1 gal [4.0 l] water)

For temperatures below freezing point, use MB Windshield Washer Concentrate “MB SummerFit” and commercially available premixed windshield washer solvent/antifreeze:

- 1 part “MB SummerFit” to 100 parts solvent  
(1.34 fl oz [40 ml] “MB SummerFit” to 1 gal [4.0 l] solvent)

- A**
- ABC 225
    - Messages in display 349
    - Oil level 279
  - ABS 87
    - Indicator lamp 29, 334
    - Messages in the multifunction display 351, 352
    - Warning lamp 27, 332
  - Accelerator position, automatic transmission 171
  - Accessory weight 312
  - Accident 59
  - Active Body Control see ABC
  - Air bags 68
    - Children in the vehicle 83
    - Front 71
    - Front passenger front air bag off indicator lamp 76
    - Head-thorax 72
    - Knee bag 72
    - Occupant Classification System (OCS) 72
    - Passenger 72
  - Air conditioning system see Automatic climate control system
  - Air distribution 188, 189
  - Air pressure 312
    - Tire inflation pressure 291
  - Air pump 410
  - Air recirculation mode 191
  - Air vents 185
  - Air volume 188, 190
  - Alarm system see Anti-theft systems
  - Alignment bolt (vehicle tool kit) 409
  - Anticorrosion/antifreeze 445, 451
  - Antiglare, Interior rear view mirror 180
  - Antilock Brake System see ABS
  - Anti-theft systems
    - Anti-theft alarm system 96
    - Immobilizer 96
    - Tow-away alarm 98
  - Aquaplaning see Hydroplaning
  - Armrest 234
  - Ashtray 31, 239
  - Aspect ratio 312
  - ATF 279
  - Auto-dimming, Rear view mirrors 180
  - Automatic central locking 119
    - Control system 162
  - Automatic climate control system 184
    - Air conditioning, Cooling 193
    - Air conditioning refrigerant 446
    - Air distribution 188, 189
    - Air recirculation mode 191
    - Air vents 185
    - Air volume 188, 190
    - Control panel 185
    - Deactivating system 187
    - Defrosting 183, 190
    - Residual heat utilization 194
    - Temperature 188
    - Temperature sensor 33
    - Ventilated glove box 195
  - Automatic lighting control, Interior lighting 135
  - Automatic locking when driving 119
  - Automatic shift program 173
  - Automatic transmission 168
    - Accelerator position 171
    - Comfort program mode 173
    - Emergency operation (Limp-Home Mode) 179
    - Gear ranges 172
    - Gear selector lever 32, 168
    - Gear selector lever position 168, 170

- Gear shifting malfunctions 179
  - Kickdown 171
  - Manual shifting 174
  - One-touch gearshifting 174
  - Program mode selector switch 32, 173
  - Starting the engine 52
  - Transmission fluid level 279
  - Automatic Transmission Fluid see ATF
- B**
- Backrest
    - Lumbar support 122
    - Multicontour seat\* 122
    - Power seat 44
    - Shoulder region support 122
  - Backup lamp
    - Messages in the multifunction display 382
    - Replacing bulb 398, 402
  - Bar 312
  - BAS 89
  - Batteries, SmartKey
    - Checking battery condition 105
    - Replacing 395
  - Batteries, SmartKey with KEYLESS-GO\*
    - Checking battery condition 110
    - Replacing 395
  - Batteries, Vehicle 281
    - Charging 417
    - Consumer battery 281, 389, 414
    - Jump starting 419
    - Messages in the multifunction display 366
    - Starter battery 281, 414
  - Bead 312
  - Bi-Xenon headlamps\* 398
  - Block heater (Canada only) 317
  - Brake Assist System see BAS
  - Brake lamps 398
    - High mounted 398
    - Messages in the multifunction display 380
  - Brake pads
    - Messages in the multifunction display 366
  - Brake system
    - Messages in the multifunction display 370
  - Brakes 260
    - BAS 89
    - Brake fluid 272, 445, 447
    - Electro-hydraulic brake system 92
    - High-performance brake system (AMG vehicles only) 262
    - Warning lamp 335
  - Break-in period 258
  - Bulbs
    - Messages in the multifunction display 380
    - Replacing 397
- C**
- California retail buyers and lessees, important notice for 11
  - Call priority, Tele Aid 249
  - Capacities and recommended fuel/lubricants 444
  - Cargo area see Trunk
  - Carpets, cleaning 329
  - Catalytic converter 269
  - CD changer 150
  - CD player 150
    - Operating 151

- Center console
  - Lower part 32
  - Upper part 31
- Central locking
  - Automatic 119, 162
  - Central locking/unlocking switch 31, 119
  - Locking/unlocking from inside 119
- Certification label 430
- Check engine see Lamps, indicator and warning
- Checking tire pressure electronically with the Advanced Tire Pressure Monitoring System (Advanced TPMS)\*, (Canada only) 298
- Children in the vehicle
  - Air bags 83
  - Front passenger front air bag off indicator lamp 76, 345
  - Infant and child restraint systems 83
  - Occupant Classification System (OCS) 72
- Cigarette lighter 239
- Clock 25, 157
- Cockpit 24
- Cold tire inflation pressure 312
- COMAND system 31
  - Driving instructions 268
- Combination switch
  - High beam 56, 133
  - Turn signals 56
  - Windshield wipers 57
- Consumer battery 281
- Control and operation of radio transmitters 268
- Control system 139, 142
- Control system menus
  - AMG Menu 146
  - AUDIO 149
  - NAV 151
  - Settings 153
  - Standard display 145
  - TEL\* 165
  - Trip computer 163
  - Vehicle status message memory 152
- Control system submenus 143
  - Convenience 162
  - Instrument cluster 156
  - Lighting 159
  - Time 157
  - Vehicle 162
- Convenience feature 201
- Coolant 449
  - Anticorrosion/antifreeze mixing ratio and quantity 451
  - Checking coolant level 280
  - Coolant warning lamp 337
  - Messages in the multifunction display 371, 373
  - Temperature 270
  - Temperature gauge 137
- Corner-illuminating front fog lamps 132
- Corner-illuminating front fog lamps\*
  - Replacing bulbs 397
- Courtesy lighting 135
- Cruise control 209
  - Messages in the multifunction display 352, 353
- Cup holder 238
- Curb weight 312
- D**
- Daytime running lamp mode 130
  - Setting 159
- Deep water see Standing water
- Defogging, Windshield 191
- Defrosting, Front 190
- Defrosting, Rear 183



- Delayed switch-off
  - Exterior lamps 160
  - Interior lighting 161
- Department of Transportation see DOT
- Difficulties
  - While driving 59
  - With starting the engine 53
- Digital clock see Clock
- Digital speedometer 145
- Dimensions, Vehicle 442
- Dipstick see Oil dipstick
- Direction of rotation (tires) 286
- Displays
  - Digital speedometer 145
  - Distronic\* 215
  - Maintenance service indicator 319
  - Multifunction display 139
  - Outside temperature 138, 145
  - Symbol messages 365
  - Text messages 349
  - Vehicle status message memory 152
  - Vehicle status messages 347
- Distance to empty (range), Trip computer 165
- Distance warning function\* 224
  - Activating 225
  - Deactivating 225
  - Intermittent warning sound 224
  - Symbol 217
- Distronic indicator lamp\* 27
- Distronic\* 213
  - “Resume” function 220
  - Activating 218
  - Cleaning system sensor cover 325
  - Control system 151, 217
  - Distance warning function 224
  - Driving hints 222
  - System sensor cover 325
  - Warning and indicator lamps 215, 216, 224, 339
- Door
  - Control panel 36
  - Handle, Inside 36
  - Locking/unlocking, KEYLESS-GO\* 39, 64
  - Locking/unlocking, Mechanical key 391, 393
  - Locking/unlocking, SmartKey 38, 63
  - Messages in the multifunction display 374
  - Opening from inside 111
  - Storage compartment 233
- Door control panel 36
- Door handle 36
- DOT 312
- Drinking and driving 259
- Driving
  - Abroad 268
  - Driving off 262
  - Electro-hydraulic brake system 95
  - Hydroplaning 264
  - In winter 266, 316
  - Instructions 54, 259
  - Problems 59
  - Safety systems 87
  - Systems 209
  - Through standing water 267
  - With Dronic\* 222
- Driving safety systems 87
  - ABS 87
  - BAS 87, 89
  - Electro-hydraulic brake system 87, 92
  - Electronic traction system 91
  - ESP® 87, 89

- Driving systems 209
  - ABC 225
  - Cruise control 209
  - Distronic\* 213
  - Parktronic\* 228
- DTR see DISTRONIC\*
- E**
- Easy-entry/exit feature 46, 162
  - Messages in the multifunction display 375
- Electric air pump 389, 410
- Electrical outlet see Power outlet
- Electro-hydraulic brake system 87, 92
  - Activation 93
  - Deactivation 94
  - Driving hints 95
  - Messages in the multifunction display 367, 368
  - Self-check 94
  - Warning lamp 92
- Electronic Stability Program see ESP®
- Emergency calls
  - Tele Aid 244, 245
- Emergency engine shut-down 426
- Emergency operation (Limp-Home Mode) 179
- Emergency operations
  - Automatic transmission (Limp-Home Mode) 179
  - Glove box, Unlocking 392
  - Load assist, Lowering 394
  - Locking/unlocking the vehicle 391, 393
  - Remote door unlock, Tele Aid 250
  - Trunk lid, Releasing from the inside 117
  - Trunk lid, Unlocking 392
- Emergency Tensioning Device see ETD
- Emission control 269
  - Information label 431
  - System warranties 10
  - Vacuum line routing diagram label 431
- Engine
  - Block heater (Canada only) 317
  - Break-in recommendations 258
  - Cleaning 324
  - Compartment 274
  - Malfunction indicator lamp 29, 336
  - Number 431
  - Poly-V-belt layout 432
  - Starting 52
  - Tachometer 29
  - Technical data 433
  - Turning off 62
- Engine coolant see Coolant
- Engine oil 275, 446
  - Adding 278, 444
  - Additives 446
  - Checking level, With control system 276
  - Checking level, With oil dipstick 278
  - Consumption 275
  - Filler neck 278, 279
  - Messages in the multifunction display 277, 375
  - Oil dipstick 278
- ESP® 87, 89
  - Switch 32
  - Switching off 91
  - Switching on 92
  - Synchronizing 355
  - Warning lamp 27, 332
- ETD 81
  - Safety guidelines 70
  - Warning and indicator lamps 342
- Exterior lamp switch 128
- Exterior rear view mirrors 48, 180

## F

Filler neck, Engine oil 278, 279

First aid kit 388

Flat tire 405

    Preparing the vehicle 405

    Spare wheel 388, 405

Flexible Service System see FSS

Fluids

    Automatic climate control  
    system 444

    Automatic transmission 279, 444

    Brake system 272, 444, 447

    Capacities 444

    Engine coolant 280, 444, 449

    Engine oil 275, 444, 446

    Power steering 444

    Retractable hardtop, Hydraulics 444

    Windshield washer and headlamp  
    cleaning system 444

Fog lamps 131

    Messages in the multifunction  
    display 380, 382

    Replacing bulbs 398

Front air bags 71

Front lamps see Headlamps

Front passenger front air bag

    Messages in the multifunction  
    display 356–359

Front passenger front air bag off indicator  
    lamp 76, 345

FSS (Canada only) 319

Fuel 271

    Additives 448

    Capacity, Fuel tank 444

    Consumption statistics 163

    Filler flap 271

    Fuel reserve warning lamp 29, 339

    Gasoline additives 448

    Gauge 29

    Premium unleaded gasoline 272,  
    445, 447

    Refueling 271

    Requirements 448

Fuel filler flap

    Opening 271

Fuels, coolants, lubricants etc.

    Capacities 444

Functions (control system) 141

Fuse chart see Vehicle tool kit

Fuses 424

## G

Garage door opener 251

Gasoline see Fuel

GAWR 312

Gear range

    Automatic transmission 172

    Canceling limit 175

    Indicator 29

    Limiting 172

    Shifting into optimal 175

Gear selector lever 32, 168

    Cleaning 328

    Lock 52

    Position 168, 170

Global locking/unlocking see Key

Glove box 233

Good visibility 180

Gross Axle Weight Rating see GAWR

Gross Vehicle Weight Rating see GVWR

Gross Vehicle Weight see GVW

GVW 312

GVWR 313

**H**

- Hard plastic trim items, cleaning 328
- Hardtop see Retractable hardtop
- Hazard warning flasher 133
- Head restraints 44
- Headlamp switch-off delay see Delayed switch-off, exterior lamps
- Headlamps
  - Automatic mode 129
  - Cleaning lenses 325
  - Cleaning system 180
  - Manual mode 129
  - Messages in the multifunction display 380
  - Replacing bulbs 397
  - Switch 55, 128
- Headliner, cleaning 329
- Head-thorax air bag 72
- Heated steering wheel\* 240
- High beam flasher 56, 133
- High beam headlamps 56, 128, 398
  - Indicator lamp 29
  - Messages in the multifunction display 380
  - Replacing bulbs 397, 400
  - Switching on 133

- High mounted brake lamp 398
- High-performance brake system (AMG vehicles only) 262
- Hood 274
  - Messages in display 377
  - Opening 274
- Horn 25
- HVAC see Automatic climate control
- Hydroplaning 264
- I**
- Identification labels 430
- Identification number, Vehicle (VIN) 431
- Ignition 40
- Immobilizer 96
- Indicator lamps see Lamps, indicator and warning
- Infant and child restraint systems 83
- Infant and child restraint systems see Children in the vehicle
- Inflation pressure see Tires, Inflation pressure
- Inside door handle 111

- Instrument cluster 26, 136
  - Illumination brightness 136
  - Lamps 332
  - Language 156
  - Messages in the multifunction display 26, 347
  - Multifunction display 139
- Instrument lighting see Instrument cluster, Illumination brightness
- Instrument panel see Instrument cluster
- Instruments and controls see Cockpit
- Interior lighting 134
  - Delayed switch-off 161
- Interior rear view mirror 48
  - Antiglare position 180
  - Auto-dimming 180
- J**
- Jack 389
- Jacking up the vehicle 406
- Jump starting 419

**K**

- Key, Mechanical 391
  - Valet locking 117
- Key, SmartKey
  - Battery check lamp 102
  - Factory setting 103
  - Locking/unlocking 38, 63, 102
  - Messages in the multifunction display 378
  - Opening retractable hardtop 201
  - Remote control 102
  - Replacing batteries 395
  - Selective setting 104
  - Starter switch positions 40
  - Turning off the engine 62
  - Unlocking, Trunk lid 111
- Key, SmartKey with KEYLESS-GO\* 105
  - Battery check lamp 106
  - Closing, Trunk 116
  - Factory setting 108
  - Locking/unlocking 39, 63, 105
  - Messages in the multifunction display 378
  - Opening retractable hardtop 201
  - Remote control 105
  - Replacing battery 395

- Selective setting 109
  - Starter switch positions 40
  - Turning off the engine 62
  - Unlocking, Trunk lid 111
- KEYLESS-GO\***
- Closing windows 198
  - Important notes 107
  - Locking/unlocking 39, 63, 105
  - Messages in the multifunction display 378
  - Start/stop button 31, 40, 53
  - Starter switch positions 40
  - Starting the engine 53
  - Turning off the engine 62
  - Unlocking, Trunk lid 111

- Kickdown 171
- Kilopascal 313
- Knee bag 72

**L**

- Labels, identification 430
- Lamp bulbs, exterior 397
- Lamps, exterior
  - Delayed switch-off 160
  - Exterior lamp switch 25, 55
  - Front 398
  - Light sensor 380

- Replacing bulbs for rear 398, 402
- Switching off 128
- Switching on 128

**Lamps, indicator and warning**

- ABS 29, 334
- ABS/ESP® 332
- Brakes 335
- CHECK ENGINE 336, 337
- Coolant 337
- DTR\* 216
- Electro-hydraulic brake system 92
- Engine diagnostics 336, 337
- Engine malfunction 29
- ESP® 89
- Front passenger front
  - air bag off 72, 76, 345
- Fuel reserve 339
- Seat belts 341
- SRS 67, 342
- Turn signals 27

**Language**

- Multifunction display 156

**Leather upholstery**

- Cleaning 329

**License plate lamps 159, 398, 402**

- Light alloy wheels, cleaning 328

- Light sensor 380
- Lighter see Cigarette lighter
- Lighting
  - Instruments 136
  - Interior 134
  - Settings (control system) 159
  - Trunk 135
- Limiting the gear range 172
- Limp-Home Mode 179
- Load assist 241
  - Lowering manually 394
- Loading terminology 312
- Loading the vehicle 286
- Lock buttons 38
  - Door handle (KEYLESS-GO\*) 64
  - Trunk (KEYLESS-GO\*) 110
- Locking the vehicle 60
  - In an emergency 393
- Low beam headlamps 55, 128, 398
  - Replacing bulbs 400
- Lowering
  - Load assist manually 394
  - Roll bar 82
- Luggage compartment, rear 237
- Luggage cover 205
  - Messages in display 387
- Lumbar support adjustment 121
- M**
- Main fuse box 425, 426
- Maintenance
  - Calling up maintenance service indicator display 320
  - Clearing maintenance service indicator message 319
  - Maintenance service indicator message 319
  - Maintenance service term exceeded 320
  - Resetting maintenance service indicator 321
- Maintenance service
  - When due 319
- Maintenance service indicator 319
- Maintenance System (U.S. vehicles) 319
- Malfunction memory 152
  - Calling up 152
  - Clearing 153
- Manual operation
  - Interior lighting control 135
  - Locking the vehicle 393
  - Lowering load assist 394
  - Unlocking storage compartments 392
  - Unlocking the driver's door 391
  - Unlocking the trunk 392
- Manual shift program SL 55 AMG and SL 65 AMG 177
- Massage function 122
- Maximum cooling MAXCOOL 190
- Maximum inflation pressure 313
- Maximum load rating 313
- Maximum loaded vehicle weight 313
- Menus 141
  - AMG 146
  - AUDIO 149
  - Distronic\* 151
  - NAV 151
  - Standard display 145
  - TEL\* 165
  - Trip computer 163
  - Vehicle status message memory 152
- Menus see Control system menus
- Miles/kilometers in speedometer 156

- Minimum distance (Parktronic\*) 230
  - Mirrors 47, 180
    - Adjusting interior rear view mirror 48
    - Exterior rear view mirrors 48
  - Misfiring 59
  - MOE tires\* see *MOExtended* system\*
  - MOExtended* system\* 301, 413
    - MOExtended* tires\* 439
  - MON 272
  - Mph or km/h in speedometer 156
  - Multifunction display 139
    - Displaying gear range 173
    - Left display field 27
    - Right display field 29
    - Selecting language 156
    - Standard display 139
  - Multifunction display messages
    - ABC 349
    - ABS 351, 352
    - Battery 366
    - Brake pads 366
    - Brake system 370
    - CHECK ENGINE 374
    - Coolant 371
    - Coolant level 373
    - Display malfunction 374
  - Doors 374
  - Easy-entry/exit feature 375
  - Electro-hydraulic brake system 367, 368
  - Front passenger front air bag 358
  - Hood 377
  - Luggage cover 387
  - Restraint systems 361
  - Roll bar 384
  - SmartKey 378
  - SmartKey with KEYLESS-GO\* 379
  - SRS 361
  - Tele Aid 384
  - Telephone\* 384
  - Tires 385
  - Trunk 387
  - Washer fluid 387
  - Multifunction steering wheel 30, 140
    - Buttons 140
- N**
- Navigation system
    - Operating 151
  - Night security illumination 160
  - Normal occupant weight 313
- O**
- Occupant Classification System see OCS
  - Occupant distribution 313
  - Occupant safety
    - Front passenger front air bag off indicator lamp 76
    - OCS 72
    - SRS 66
  - OCS 72
    - Self-test 76
  - Odometer, main 27
  - Oil
    - Adding 278
    - Consumption 275
  - Oil dipstick 278
  - Oil see Engine oil
  - One-touch gearshifting 174
    - Canceling gear range limit 175
    - Downshifting 174
    - Upshifting 175
  - Ornamental moldings 325
  - Overdue maintenance service 320
  - Overhead control panel 33
  - Overspeed range 138

- P**
- Paintwork code see Certification label
  - Panic alarm 86
    - Panic button on SmartKey 86
  - Panorama roof\*
    - Sunshade 208
    - Sunshade closing 208
    - Sunshade opening 208
  - Parcel net
    - In front passenger footwell 236
  - Parcel net in trunk 237
  - Parking 263
  - Parking assistance (Parktronic\*) 228
  - Parking brake
    - Engaging 61
    - Releasing 54
  - Parking brake pedal 25
  - Parking lamps 398
    - Switching on 128
  - Parktronic\* 32, 228
    - Activating 231
    - Cleaning system sensors 326
    - Malfunctioning 231
    - Minimum distance 230
    - Range 229
    - Rear sensors 230
    - System sensors 326
    - Warning indicators 25, 230
  - Parktronic\* deactivation switch 32
  - Parts service 428
  - PASS AIR BAG OFF indicator lamp see
    - Front passenger front air bag off indicator lamp
  - Passenger side
    - Front air bag 72
  - Pedals 259
  - Phone book\* 166
    - Loading 167
    - Quick search 167
  - Phone number\*
    - Dialing 166
    - Redialing 167
  - Plastic parts, cleaning 328
  - Poly-V-belt drive
    - Layout 432
  - Potential problems associated with under-inflated and overinflated tires 301
  - Power assistance 260
  - Power closing assist for trunk lid 118
  - Power outlet 242
  - Power seat
    - Adjusting backrest tilt 44
    - Adjusting head restraint height 44
    - Adjusting head restraint tilt 44
    - Adjusting seat cushion depth 44
    - Adjusting seat cushion tilt 44
    - Adjusting seat height 44
  - Power windows 196
    - Cleaning 326
    - Closing with KEYLESS-GO\* 198
    - Side windows 196
    - Synchronizing 198
  - Problems while driving 59
  - Production options weight 313
  - Program mode selector switch
    - Automatic transmission 32, 173
  - PSI 313
  - PULSE function (Massage function) 122
- Q**
- Quick search
    - Phone book\* 167



**R**

- RACETIMER see Control system menus, AMG menu
  - Radio
    - Operating 149
    - Satellite 150
    - Selecting station 149
  - Radio transmitters
    - Control and operation 268
  - Range (distance to empty)
    - Calling up 165
  - Reading lamp 33
  - Rear lamps see Tail lamps
  - Rear luggage compartment 237
  - Rear view mirrors see Mirrors
  - Recommended inflation pressure 313
  - Redial memory 167
  - Refueling 271
  - Regular checks 272
  - Regular driving style 228
  - Remote
    - Trunk opening/closing\* switch 114
  - Remote trunk opening switch 112
  - Remote trunk opening/closing\* switch 113
  - Replacing
    - Batteries (SmartKey) 395
    - High beam bulbs 400
    - Low beam bulbs 400
    - Rear lamp bulbs 398, 402
    - Wiper blades 403
  - Reset button 27
  - Resetting
    - All functions (control system) 153
    - Fuel consumption statistics 164
    - Trip odometer 137
  - Restraint systems 66
    - Emergency Tensioning Device (ETD) 81
    - Messages in the multifunction display 361
    - Seat belts 66, 77
  - Resume function
    - Cruise control 212
    - Distronic\* 220
  - Retractable hardtop
    - Closing (SmartKey) 201
    - Closing (switch) 200
    - Convenience feature 201
    - Locking after raising/lowering 202
    - Opening (SmartKey) 201
    - Opening (switch) 200
    - Problems when operating 203
    - Summer opening feature 201
  - Rim 313
  - Roll bar 81
    - Lowering 82
    - Messages in display 384
    - Raising 82
    - Warning lamp 29
  - Roll bar buttons 32
  - RON 272
  - Rubber parts, cleaning 328
  - Run Flat Indicator (Canada only) 293
- S**
- Satellite radio 150
  - Seat belt force limiter 81
  - Seat belts 49, 66, 77
    - Cleaning 329
    - Messages in the multifunction display 361
    - Warning lamp 341
  - Seat heating
    - Switching on 123
  - Seat ventilation\* 125
    - Switching on 125

- Seating capacity 287
- Seats
  - Adjusting height 43
  - Adjusting lumbar support 122
  - Adjusting shoulder support 122
  - Heating 123
  - Massage function 122
  - Moving 121
- Self-test
  - OCS 76
- Service
  - Basic service (Service A) 319
  - Batteries 414
  - Extended service (Service B) 319
  - Types 319
- Service life (tires) 284
- Service System see Maintenance
- Settings
  - Clock 157
  - Convenience functions 162
  - Cruise control 212
  - Daytime running lamp mode 159
  - Interior lighting delayed
    - switch-off 161
  - Lamps and lighting
    - (control system) 159
  - Language, multifunction display 157
  - Locator lighting 160
  - Miles/kilometers in
    - speedometer 156
  - Night security illumination 160
  - Resetting all (control system) 153
  - Selective (SmartKey with
    - KEYLESS-GO\*) 109
  - Selective (SmartKey) 104
  - Speedometer display mode 156
  - Time 157
  - Units in speedometer 156
- Shifting
  - Gear selector lever 168
  - Gear selector lever positions 170
  - Into optimal gear range (Automatic
    - transmission) 175
- Shoulder support
  - Seat adjustment 122
- Side marker lamps 398
  - Cleaning lenses 325
- Side windows
  - Automatic closing 198
  - Automatic opening 197
  - Closing 196, 197
  - Closing fully 198
  - Closing with KEYLESS-GO\* 198
  - Express-close 198
  - Express-open 197
  - Opening 196, 197
  - Opening fully 197
  - Stopping 198
  - Synchronizing power windows 198
- Sidewall 313
- SmartKey 102
  - Batteries 395
  - Checking the batteries 105
  - Closing retractable hardtop 201
  - Global locking 103, 104
  - Global unlocking 103
  - Loss of 105
  - Positions in starter switch 40
  - Restoring factory settings 104, 109
  - Selective setting 104
  - Starter switch positions 40
  - Starting the engine 52
  - Turning off the engine 62
- SmartKey with KEYLESS-GO\*
  - Checking the batteries 110
  - Global locking 108, 109
  - Global unlocking 108
  - Locking 110

- Loss of 110
- Messages in display 379
- Reprogramming 109
- Selective setting 109
- Unlocking 106
- Snow chains 318
- Spare fuses 424
- Spare fuses see Vehicle tool kit
- Spare tire see Spare wheel 405
- Spare wheel 388, 389, 405, 440
  - Collapsible tire 410, 440
  - Inflating collapsible tire 410
  - Tire inflation pressure 410
- Speed settings
  - Cruise control 212
- Speedometer 27
  - Setting units 156
- Sporty driving style 228
- SRS
  - Indicator lamp 342
  - Messages in the multifunction display 361
- Standing lamps 128, 398
- Standing water
  - Driving instructions 267
- Starter battery 281, 414
- Starter switch 25, 40
- Starter switch positions 39
- Starting difficulties 53
- Starting position 40
- Starting the engine
  - With the SmartKey 52
  - With the SmartKey with KEYLESS-GO\* 53
- Steering column
  - In/out adjustment 46
  - Length adjustment 46
  - Up/down adjustment 46
- Steering wheel
  - Adjusting 45
  - Buttons 30
  - Cleaning 328
  - Heating\* 240
  - Height adjustment 46
- Steering wheel adjustment lever 25
- Steering wheel gearshift control\* 175
- Stopping
  - Windows 198
- Storage compartment
  - Center console 234
- Storage compartments 233
  - Armrest 234
  - Cup holder 238
  - Glove box 233
  - In door 233
  - Locking compartments separately 235
  - Locking storage compartments 235
  - Parcel net 236
  - Rear 235
  - Seats 234
  - Storage tray 234
  - Unlocking compartments separately 236
  - Unlocking storage compartments 236, 392
  - Ventilated glove box 195
- Storing tires 285
- Submenus 143
  - Convenience 162
  - Instrument cluster 156, 157
  - Lighting 159
  - Selecting 154
  - Settings menus 154
  - Time 157
  - Vehicle 162

- Submenus see Control system submenus
- Summer opening feature 201
- Sun blind see Sunshade
- Sun visors 182
- Sunshade 208
  - Closing 208
  - Opening 208
- Suspension tuning
  - For regular driving style 228
  - For sporty driving style 228
- Suspension tuning (ABC) 225
- Switching on headlamps 55
- Symbol
  - Distance warning function\* 217
- Synchronizing
  - ESP® 355
  - Power windows 198
- Synchronizing time with head unit 157
- T**
- Tachometer 29, 138
- Tail lamps 398, 402
  - Cleaning lenses 325
- Technical data
  - Electrical system 441
  - Main dimensions 442
  - Rims and tires 435
- Weights 443
- Windshield and headlamp washer
  - system 452
- Tele Aid 244
  - Emergency calls 245
  - Information 248
  - Initiating an emergency call
    - manually 246
  - Messages in display 384
  - Roadside Assistance 247
  - SOS button 33, 246
  - Tele Aid system 244
- Telephone\* 30, 243
  - Answering a call 166
  - Dialing 166
  - Ending a call 167
  - Loading phone book\* 167
  - Messages in display 384
  - Operating 165
  - Redialing 167
- Telephones and two-way radios 268
- Temperature
  - Outside temperature indicator 138
  - Sensor, Interior 33
  - Tires 292
- Tightening torque 412
- Time
  - Settings (control system) 157
- TIN 314
- Tire
  - Vehicle maximum load on 314
- Tire and Loading Information 287
- Tire and loading terminology 312
- Tire care and maintenance 284
- Tire Identification Number see TIN
- Tire inflation pressure
  - Checking 273, 291, 292
  - Checking tire pressure electronically
    - with the Advanced Tire Pressure Monitoring System (Advanced TPMS)\*, (Canada only) 298
- Tire inflation pressure see the placard on the fuel filler flap
- Tire inspection 284
- Tire load rating 314
- Tire ply composition and material used 314
- Tire speed rating 265, 304, 314
- Tire terminology 312
- Tire traction 265

- Tires 283
    - Advanced Tire Pressure Monitoring System (Advanced TPMS)\*, (Canada only) 298
    - Cleaning 285
    - Direction of rotation 286
    - Driving instructions 263
    - Low tire pressure telltale 343
    - Messages in display 385
    - Messages in the multifunction display 364
    - MO*Extended*\* 413
    - Retreads 283
    - Rims and tires 435
    - Rotating 315
    - Run Flat Indicator 293
    - Service life 284
    - Temperature 292, 311
    - TPMS malfunction telltale 343
    - Tread depth 285, 317
    - Wear pattern 315
    - Winter 316
  - Tools 388
  - Tow-away alarm 98
  - Tow-away alarm switch 32
  - Towing eye bolt (vehicle tool kit)
    - Installing 423
  - Towing eye bolt see Vehicle tool kit
  - Towing the vehicle 421
  - TPMS (USA only) 295
  - Traction 91, 174, 314
  - Transmission see Automatic transmission
  - Tread 314
  - Tread depth 285
  - Treadwear indicators 314
  - Trip computer 163
  - Trip odometer 27
    - Resetting 137
  - Trunk
    - Closing the lid 113
    - Lighting 135
    - Load assist 241
    - Lock button (KEYLESS-GO\*) 110
    - Messages in display 387
    - Opening from inside vehicle 111
    - Opening/closing system\* 113, 114
    - Parcel net 237
    - Power closing assist for trunk lid 118
    - Unlocking 111
    - Unlocking (KEYLESS-GO\*) 111
  - Unlocking in an emergency 392
  - Unlocking separately 111
  - Valet locking 117
  - Trunk lid
    - Opening 112
  - Turn signal lamps
    - Cleaning lenses 325
    - Replacing bulbs 398, 401
  - Turn signals 25, 56
    - Exterior rear view mirrors 398, 401
    - Front bulbs 398
    - Indicator lamps 27
    - Rear bulbs 398
  - Turning off the engine 62
- U**
- Uniform Tire Quality Grading Standards 314
  - Units
    - Setting speedometer units 156
  - Unlocking the vehicle 38
    - In an emergency 391
  - Upholstery
    - Cleaning 329
  - Upshifting 175

- V**
- Vehicle
    - Locking 31
    - Locking in an emergency 393
    - Minimum distance (Parktronic\*) 230
    - Towing 421
    - Unlocking 31
    - Unlocking in an emergency 391
  - Vehicle capacity weight 314
  - Vehicle care
    - Leather upholstery 329
    - Ornamental moldings 325
    - Upholstery 329
    - Wood trims 329
  - Vehicle Identification Number see VIN
  - Vehicle level
    - Changing 227
    - Setting 227
  - Vehicle level control (ABC) 225
  - Vehicle level control switch 32
  - Vehicle lighting
    - Checking 273
  - Vehicle loading terminology 312
  - Vehicle maximum load on the tire 314
  - Vehicle status messages 347
  - Vehicle tool kit 388
- VIN 431
- Voice control system\* 25
- W**
- Warning sounds
    - Distance warning function\* 224
    - Distronic\* 216
    - Drivers seat belts 80
    - Parking brake 55
  - Warranty coverage 429
  - Washing the vehicle 324
  - Wear pattern (tires) 315
  - Wheel bolts
    - Tightening torque 412
  - Wheel change 405
    - Tightening torque 412
  - Wheel wrench 389
  - Wheels
    - Tires and wheels 283
  - Wind screen 204
    - Installing 204
    - Removing 205
  - Windows see Side windows
  - Windows, cleaning 326
  - Windshield
    - Cleaning wiper blades 326
    - Defogging 191
    - Refilling washer fluid 282
    - Washer fluid 58, 282
    - Washer system 282
    - Windshield and headlamp washer system 452
    - Windshield washer and headlamp cleaning system 272, 273
    - Windshield washer fluid 58
      - Filler neck 282
      - Messages in display 387
      - Mixing ratio 452
      - Refilling 282
    - Windshield wipers 25, 57
      - Fast wiper speed 57
      - Intermittent wiping 57
      - Replacing wiper blades 403
      - Wiping with windshield washer fluid 58
  - Winter driving
    - Snow chains 318
    - Tires 316
  - Winter driving instructions 266
  - Winter tires 316
  - Wood trims
    - Cleaning 329



## Service and Literature

Your authorized Mercedes-Benz Center has trained technicians and Genuine Mercedes-Benz Parts to service your vehicle properly. For expert advice and quality service, contact an authorized Mercedes-Benz Center.

If you are interested in obtaining service literature for your vehicle, please contact an authorized Mercedes-Benz Center. We consider this the best way for you to obtain accurate information for your vehicle.

For further information you can find us on the Mercedes-Benz web-site [www.mbusa.com](http://www.mbusa.com) or [www.mercedes-benz.ca](http://www.mercedes-benz.ca).

### Warning!



To help avoid personal injury, be extremely careful when performing any service work or repairs. Improper or incomplete service or the use of incorrect or inappropriate parts or materials may damage the vehicle or its equipment, which may in turn result in personal injury.

If you have any questions about carrying out any type of service, turn to the advice of an authorized Mercedes-Benz Center.

We reserve the right to modify the technical details of the vehicle as given in the data and illustrations of this Operator's Manual. Reprinting, translation and copying, even of excerpts, are not permitted without our prior authorization in writing.

Press time February 07, 2006

GSP/TIP

Printed in Germany



