



SL

Operator's Manual

Symbols

Trademarks®:

- Bluetooth® is a registered trademark of Bluetooth SIG Inc.
- ESP® is a registered trademark of Daimler.
- HomeLink® is a registered trademark of Prince, a Johnson Controls Company.

The following symbols are found in this Operator's Manual:

Warning!

Warning notices draw your attention to hazards that may endanger your health or life, or the health or life of others.

 Highlights hazards that may result in damage to your vehicle.

 Helpful hints or further information you may find useful.

 This symbol points to instructions for you to follow.

 A number of these symbols appearing in succession indicates a multiple-step procedure.

 page This symbol tells you where to look for further information on a topic.

 This continuation symbol marks a warning or procedure which is continued on the next page.

Display Text in displays, such as the control system, are printed in the type shown here.

Our company and staff congratulate you on the purchase of your new Mercedes-Benz.

Your selection of our product is a demonstration of your trust in our company name. Furthermore, it exemplifies your desire to own an automobile that will be as easy as possible to operate and provide years of service.

Your Mercedes-Benz represents the efforts of many skilled engineers and craftsmen. To help assure your driving pleasure, and also the safety of you and your passengers, we ask you to make a small investment of time:

- Please read this manual carefully, then return it to your vehicle where it will be handy for your reference.
- Please follow the recommendations contained in this manual. They are designed to acquaint you with the operation of your Mercedes-Benz.
- Please pay attention to the warnings and cautions contained in this manual. They are designed to help improve the safety of the vehicle operator and occupants.

We extend our best wishes for many miles of safe, pleasurable driving.

Mercedes-Benz USA, LLC

A Daimler Company

Index 3

Introduction 18

At a glance 25

Safety and security 43

Controls in detail 75

Operation 199

Practical hints 251

Technical data 337

- A**
- ABC**
see Active Body Control (ABC)
- ABS (Antilock Brake System)** 64
Indicator lamp 293
Messages in the multifunction display 256
- Accessory weight** 230
- Accidents** 113
Air bag deployment 45
Distance warning function 155
Emergency calls (Tele Aid) 188
- Active Bi-Xenon headlamps**
Messages in the multifunction display 286
see Headlamps
- Active Body Control (ABC)** 157
- Additives**
Engine oil 353
Gasoline 355
- Address change** 20
- Advanced Tire Pressure Monitoring System (Advanced TPMS)** 220
Messages in the multifunction display 266, 291
- Air bags** 45
Children 45
Emergency call upon deployment 188
Front, driver 48
Front, passenger 48
Head-thorax 49
Knee bag 49
Messages in the multifunction display 258
Passenger front air bag off indicator lamp 38, 52, 305
Safety guidelines 47
- Air conditioning refrigerant and lubricant** 354
- Air distribution** 170
- Air pressure**
see Tire inflation pressure
- Air pressure (tires)** 230
- Air pump (electric)** 322
- Air recirculation mode** 172
- AIRSCARF neck-level heating** 94
- Air vents** 168
- Air volume** 171
- Alarm system**
see Anti-theft systems
- Alignment bolt (vehicle tool kit)** 252, 321
- Alternator** 348
Messages in the multifunction display 283
- AMG menu** 130
- Anticorrosion/antifreeze** 356
- Antilock Brake System**
see ABS
- Anti-theft systems** 71
Anti-theft alarm system 71
Immobilizer 71
Tow-away alarm 72
- Aquaplaning**
see Hydroplaning
- Ashtray** 186
- Aspect ratio (tires)** 230
- Audio/DVD menu** 132
- Auto-dimming rear view mirrors** 97
- Automatic central locking** 81, 140
- Automatic headlamp mode** 99
- Automatic interior lighting control** 104
- Automatic locking when driving** 140
- Automatic shift program** 118
- Automatic transmission** 115
Automatic shift program 118
Emergency operation (limp-home mode) 124
Gear range indicator 118
Gear ranges 118
Gear selector lever 115
Gearshifting malfunctions 124
Hill start assist system 157
Kickdown 117
Kickdown (manual shift program) 123
Manual shift program 121
One-touch gearshifting 120
Program mode indicator 119

- Program mode selector dial
(SL 63 AMG) 119, 121
 - Program mode selector switch
. 118, 119, 122
 - Shifting procedure 116
 - Steering wheel gearshift control . . 120
 - Transmission position indicator . . . 116
 - Transmission positions 116
 - AUX socket** 181
 - Axle oils** 351
- B**
- Backrest**
see Seats
 - Backup lamps**
Messages in the multifunction display 286
 - Replacing bulbs 311
 - Bar (air pressure unit)** 231
 - BAS (Brake Assist System)** 64
 - Batteries, SmartKey**
Checking condition 80
 - Replacing 309
 - Battery, Vehicle**
Charging 327
 - Jump starting 328
 - Messages in the multifunction display 283
 - Bead (tire)** 231
- Beverage holders**
see Cup holders
 - Brake fluid**
Messages in the multifunction display 272
 - Brake lamps**
Cleaning lenses 246
 - High-mounted brake lamp 311
 - Replacing bulbs 311
 - Brake pads**
Messages in the multifunction display 271
 - Brakes** 237
 - High-performance brake system . . 239
 - Warning lamp 295
 - Break-in period** 200
 - Bulbs**
see Replacing bulbs
- C**
- CAC (Customer Assistance Center)** . . 22
 - California retail buyers and lessees, important notice for** 19
 - Calls (phone)** 142
 - Can holders**
see Cup holders
 - Capacities and recommended fuel/lubricants** 350
 - Carpets, cleaning** 249
- Central locking**
Automatic 81, 140
 - Locking/unlocking from inside 81
 - Central locking/unlocking switch** . . . 81
 - Certification label** 339
 - Children in the vehicle** 60
 - Air bags 45
 - Indicator lamp, passenger front
air bag off 52
 - Infant and child restraint systems . . 60
 - Occupant Classification System
(OCS) 50
 - Safety notes 60
 - Child safety**
see Children in the vehicle
 - Chrome-plated exhaust tip, cleaning** 249
 - Cigarette lighter** 186
 - Climate control system**
Air conditioning, cooling 167
 - Air conditioning refrigerant 354
 - Air recirculation mode 172
 - Air vents 168
 - Air volume 170, 171
 - Automatic mode 168
 - Deactivating system 167
 - Front defroster 171
 - Maximum cooling MAX COOL 171
 - Residual engine heat (REST) 172
 - Temperature 168

- Cockpit** 28
 - Cold tire inflation pressure** 231
 - Collapsible tire (spare wheel)** 347
 - COMAND system**
see separate COMAND system
operating instructions
 - Combination switch** 101
 - Control system** 126
 - Multifunction display 127
 - Multifunction steering wheel 126
 - Resetting to factory settings 135
 - Control system menus** 128
 - AMG 130
 - Audio/DVD 132
 - DISTRONIC 134
 - Navigation 134
 - Settings 135
 - Standard display 129
 - Telephone 142
 - Trip computer 141
 - Vehicle status message memory 134
 - Control system submenus** 128
 - Convenience 140
 - Instrument cluster 136
 - Lighting 138
 - Vehicle 140
 - Convenience submenu**
Easy-entry/exit feature 140
 - Coolant**
 - Anticorrosion/antifreeze 356
 - Capacities 351
 - Checking level 207
 - Messages in the multifunction display 279, 280, 282
 - Temperature gauge 125
 - Warning lamp 303
 - Cruise control** 144
 - Last stored speed 146
 - Resume function 146
 - Cup holders** 185
 - Curb weight** 231
 - Customer Assistance Center**
see CAC
- D**
- Dashboard**
see Instrument cluster
 - Data recording** 23
 - Daytime running lamp mode** 100, 138
 - Deep water**
see Standing water
 - Defogging (windshield)** 171
 - Defroster**
 - Rear window 173
 - Windshield 171
 - Delayed shut-off**
 - Exterior lamps 139
 - Interior lighting 140
 - Department of Transportation**
see DOT
 - Difficulties**
 - While driving 112
 - With starting 110
 - Digital speedometer** 129
 - Dimensions (vehicle)** 349
 - Direction of rotation (tires)** 212
 - Displays**
 - Digital speedometer 129
 - DISTRONIC 149
 - Maintenance service indicator 242
 - Messages in the multifunction display 255
 - Multifunction display 127
 - Outside temperature 127
 - Symbol messages 269
 - Text messages 256
 - Trip computer 127, 141
 - Vehicle status message memory 134
 - Vehicle system settings 135
 - DISTRONIC**
 - Cleaning system sensor 246
 - Control system 134
 - Distance warning function 155
 - Driving hints 154
 - Last stored speed 152

- Menu 150
 - Messages in the multifunction display 263
 - Resume function 152
 - Sensor cover 246
 - Warning and indicator lamps . . 149, 300
 - Door control panel** 41
 - Doors**
 - Locking/unlocking (SmartKey) 76
 - Locking/unlocking (SmartKey with KEYLESS-GO) 78
 - Locking/unlocking from outside . . . 76
 - Messages in the multifunction display 275
 - Opening from inside 80
 - Remote door unlock (Tele Aid) 192
 - Unlocking (Mechanical key) 307
 - DOT (Department of Transportation)** 231
 - Drinking and driving** 236
 - Driving**
 - Abroad 240
 - Hydroplaning 240
 - Instructions 109, 236
 - In winter 235
 - Problems 112
 - RACE START (SL 63 AMG) 156
 - Safety systems 63
 - Systems 144
 - Through standing water 240
 - With Distronic 154
 - Driving and parking**
 - Safety notes 109
 - Driving off** 111, 239
 - Driving safety systems** 63
 - ABS 64
 - BAS 64
 - ESP® 65
 - ETS 65
 - Driving systems**
 - Active Body Control (ABC) 157
 - Cruise control 144
 - Distronic 147
 - Parktronic system 160
 - RACE START (SL 63 AMG) 156
 - Driving tips, automatic transmission** 117
- E**
- Easy-entry/exit feature** 95, 140
 - Messages in the multifunction display 279
 - Electrical system**
 - Improper work on or modifications . . 21
 - Power outlet 187
 - Technical data 348
 - Electronic Stability Program**
 - see ESP®
 - Emergency, in case of**
 - Battery, jump starting 328
 - First aid kit 252
 - Flat tire 317
 - Hazard warning flasher 102
 - Roadside Assistance 20
 - Towing the vehicle 330
 - Emergency calls**
 - Tele Aid 188
 - Emergency operations**
 - Limp-home mode 124
 - Locking/unlocking the vehicle . . . 307
 - Remote door unlock 192
 - Trunk lid, emergency release 86
 - Trunk lid, unlocking 307
 - Emergency Tensioning Device**
 - see ETD
 - Emission control** 241
 - Information label 340
 - System warranties 19
 - Engine**
 - Brake-in recommendations 200
 - Cleaning 245
 - Compartment 203
 - Malfunction indicator lamp 33, 302
 - Maximum engine speed 341
 - Messages in the multifunction display 279
 - Number 340

Starting	109
Technical data	341
Turning off	114
Engine coolant	
see Coolant	
Engine oil	
Adding	206
Additives	353
Checking level	204
Consumption	204
Messages in the multifunction display	284
Oil dipstick	205
Recommended engine oils and oil filter	353
ESP® (Electronic Stability Program)	65
ETS	65
Messages in the multifunction display	257
Warning lamp	298
ETD (Emergency Tensioning Device)	57
Safety guidelines	47
ETS (Electronic Traction System)	65
Express operation	
Power windows	107
Exterior lamp switch	99
Exterior rear view mirrors	96
Exterior view of vehicle	26

F

Fastening the seat belts	55
First aid kit	252
Flat tire	317
Lowering the vehicle	324
Mounting the spare wheel	318
Preparing the vehicle	318
Spare wheel	318, 347
Floormats	197
Fluids	
ABC fluid	207, 351
Automatic transmission fluid	350
Brake fluid	351
Capacities	350
Engine coolant	351
Engine oil	350
Hydraulic fluid	352
Power steering fluid	351
Washer and headlamp cleaning system	352
Fog lamps	101
Messages in the multifunction display	287, 288
Replacing bulbs	311
Front air bags	
see Air bags	
Front lamps	
see Headlamps	

Fuel	201, 236
Additives	355
Capacities, fuel tank	352
Fuel consumption statistics	141
Fuel filler flap and cap	201
Fuel tank reserve warning lamp	33, 301
Premium unleaded gasoline	201, 352, 354
Requirements	354
Fuel filler flap	201
Locking/unlocking	201
Opening	202
Fuels, coolants, lubricants etc.	
Capacities	350
Fuel tank	
Capacity	352
Filler flap	201
Fuses	334

G

Garage door opener	40, 193
Gasoline	
see Fuel	
GAWR (Gross Axle Weight Rating)	231
Gear range	
Automatic transmission	118
Indicator	118
Limiting	120
Shifting into optimal	121

- Gear selector lever** 115
 Cleaning 249
 Gearshift pattern 115
 Lock 110, 115
 Messages in the multifunction display 265
 Shifting procedure 116
 Transmission position indicator ... 116
 Transmission positions 116
- Generator**
 see Alternator
- Global locking/unlocking**
 see Key, SmartKey
- Glove box** 181
- Gross Axle Weight Rating**
 see GAWR
- Gross Vehicle Weight**
 see GVW
- Gross Vehicle Weight Rating**
 see GVWR
- GVW (Gross Vehicle Weight)** 231
- GVWR (Gross Vehicle Weight Rating)** 231
- H**
- Hard plastic trim items, cleaning** .. 248
- Hazard warning flasher** 102
- Headlamp cleaning system** 103
- Headlamps**
 Active Bi-Xenon headlamps 98
 Automatic headlamp mode 99
 Bi-Xenon 98, 311
 Cleaning lenses 246
 Cleaning system 103
 Delayed shut-off 139
 High-beam flasher 102
 High-beam headlamps 101
 Low-beam headlamps 99
 Replacing bulbs 311
 Switch 99
- Headliner, cleaning and care of** 249
- Head restraints** 89
- Head-thorax air bags** 49
- Heated seats** 93
- Height adjustment**
 Seats 90
- High-beam flasher** 102
- High-beam headlamps** 101, 311
 Indicator lamp 33
 Replacing bulbs 311
- High-mounted brake lamp** 311
 Replacing bulbs 311
- High-performance brake system** ... 239
- Hill start assist system** 157
- Hood** 203
 Messages in the multifunction display 275
- Horn** 29
- Hydroplaning** 240
- I**
- Identification labels** 339
- Identification number, vehicle (VIN)** 339
- Ignition** 87, 89, 110
- Immobilizer** 71
- Indicator lamps**
 see Lamps, indicator and warning
- Infant and child restraint systems**
 see Children in the vehicle
- Inflation pressure**
 see Tires, Inflation pressure
- Inside door handle** 41, 80
- Instrument cluster** 30, 124
 Illumination 125
 Lamps 293
 Multifunction display 127
- Instrument lighting**
 see Instrument cluster, Illumination
- Instrument panel**
 see Instrument cluster
- Instruments and controls**
 see Cockpit
- Interior lighting** 104
 Delayed shut-off 140
 Reading lamps 104

- Interior rear view mirror** 96
 - Auto-dimming rear view mirrors 97
- Interior storage spaces**
 - see Storage compartments
- Intermittent wiping**
 - Windshield wipers 105

J

- Jack** 253
- Jump starting** 328

K

- Key, Mechanical** 307
 - Loss of 80
 - Valet locking 86
- Key, SmartKey**
 - Battery check lamp 77
 - Checking batteries 80
 - Factory setting 77, 79
 - Global locking (SmartKey) 77
 - Global locking (SmartKey with KEYLESS-GO) 79
 - Global unlocking (SmartKey) 77
 - Global unlocking (SmartKey with KEYLESS-GO) 79
 - Important notes on KEYLESS-GO . . . 78
 - Locking/unlocking 76
 - Loss of 80

- Messages in the multifunction display 277
- Opening, Trunk 82
- Remote control 76
- Replacing batteries 309
- Restoring to factory setting 77, 79
- Selective setting 77, 79
- Starter switch positions 87

Key, SmartKey with KEYLESS-GO

- Starter switch positions 88

KEYLESS-GO

- Starter switch positions 88

Kickdown 117**Kickdown (manual shift program)** . . 123**Kilopascal (air pressure unit)** 231**Knee bag** 49**L****Labels**

- Certification 339
- Emission control information 340

Lamps, exterior

- Exterior lamp switch 99
- Front 311
- Messages in the multifunction display 286
- Rear 311
- Switching on/off 99

Lamps, indicator and warning

- ABS 33, 293
- Battery (SmartKey) 77
- Brakes 295
- Coolant 303
- Distance warning lamp 149, 155, 300
- Engine malfunction 33, 302
- ESP® 31, 298
- Fog lamps 101
- Fuel tank reserve 33, 301
- High-beam headlamps 33
- Instrument cluster 293
- Passenger front air bag off
 - 38, 49, 305
- Roll bar 300
- Seat belt telltale 33, 296
- SRS 45, 297
- Turn signals 31

Language, Selecting 137**License plate lamps** 311

- Messages in the multifunction display 288
- Replacing bulbs 311

Light alloy wheels, cleaning 248**Lighter**

- see Cigarette lighter

Lighting 98

- Daytime running lamp mode 100
- Exterior 99
- Interior 104

- Limp-home mode** 124
 - Load assist** 184
 - Locator lighting** 138
 - Lock button**
 - Door handle (KEYLESS-GO) 79
 - Locking the vehicle** 76, 78
 - Manually 308
 - Loss of**
 - Key 80
 - Service and Warranty Information booklet 339
 - Low-beam headlamps** 99
 - Replacing bulbs 311
 - Switching on 99
 - Lubricants** 350
 - Luggage cover** 178
 - Lumbar support** 91
-
- M**
- Maintenance** 19
 - Maintenance System** 241
 - Calling up service indicator 242
 - Clearing service indicator message 242
 - Resetting service indicator 243
 - Service indicator 242
 - Service indicator message 242
 - Service term exceeded 242
 - Manual headlamp mode (Low-beam headlamps)** 99
 - Manual shift program** 121
 - Maximum loaded vehicle weight** 231
 - Maximum load rating (tires)** 231
 - Maximum permissible tire inflation pressure** 231
 - Mechanical key** 307
 - Media interface** 181
 - Memory function** 97
 - Menus**
 - see Control system menus
 - Mirrors**
 - Auto-dimming rear view mirrors 97
 - Exterior rear view mirrors 96
 - Interior rear view mirror 96
 - Memory function 97
 - MOExtended system** 325
 - MOExtended tires** 325, 343
 - MON (Motor Octane Number)** 201, 354
 - Motor Octane Number**
 - see MON
 - Multicontour seats** 92
 - Multifunction display** 127
 - Symbol messages 269
 - Text messages 256
 - Vehicle status messages 255
 - Multifunction display messages**
 - ABS 256
 - Active headlamps 286
 - Advanced TPMS 266, 291
 - Air bags 258
 - Alternator 283
 - Automatic transmission 265
 - Battery 283
 - Brake fluid 272
 - Brake pads 271
 - Check engine 279
 - Coolant 279, 280, 282
 - Corner-illuminating lamps 289
 - Cruise control 263
 - Display malfunction 255
 - Distronic 263
 - Doors 275
 - Easy-entry/exit feature 279
 - Engine oil 284
 - Engine service 279
 - ESP® 257
 - Fog lamps 287, 288
 - Gas cap 286
 - Gear selector lever 265
 - High-beam lamps 288
 - Hood 275
 - License plate lamps 288
 - Light sensor 288
 - Low-beam lamps 288
 - Parking brake 273
 - Parking lamps 287
 - Passenger front air bag 258
 - Reserve fuel 285

- Retractable hardtop 276
 - Reverse lamp 286
 - Roll bar 59, 274
 - Side marker lamps 287
 - SmartKey 277
 - SmartKey with KEYLESS-GO 277
 - SRS 274
 - Tail lamps 289
 - Tele Aid 274
 - Tire pressure 266, 291
 - Tire pressure monitor 266
 - Tires 266, 291
 - TPMS 266, 291
 - Trunk 275
 - Turn signals 290
 - Washer fluid 278
- Multifunction steering wheel**
- Adjusting 95
 - Buttons 126
 - Cleaning 249
 - Easy-entry/exit feature 95, 140
 - Gearshift control 120
 - Memory function 97
 - Overview 36
- N**
- Navigation menu** 134
 - Nets, parcel** 180
 - Night security illumination** 101, 139
 - Normal occupant weight** 231
- Number, vehicle identification (VIN)** 339
- O**
- Occupant Classification System**
see OCS
- Occupant distribution** 231
- Occupant safety** 44
- Air bags 45
 - Children and air bags 45
 - Children in the vehicle 60
 - Fastening the seat belts 55
 - Infant and child restraint systems 60
 - OCS 50
 - Passenger front air bag off indicator lamp 50, 305
 - Roll bar 59
 - Seat belts 47, 53
- OCS (Occupant Classification System)** 50
- Self-test 52
- Odometer** 127
- Oil**
see Engine oil
- Oil level**
see Engine oil, Checking level
- On-board computer**
see Control system
- One-touch gearshifting** 120
- Operating safety** 21
- Ornamental moldings, cleaning** 246
- Overhead control panel** 40
- P**
- Paintwork, cleaning** 245
- Paintwork code** 339
- Panic alarm** 62
- Panorama roof**
Sunshade 180
- Parcel nets** 180
- Parking** 113
- Parktronic 160
- Parking brake** 113
- Messages in the multifunction display 273
- Parking position**
Transmission position 116
- Parktronic**
Cleaning system sensors 247
- Malfunctions 163
 - Minimum distance 161
 - Range 161
 - System sensors 160, 247
 - Warning indicators 29, 161
- Parts service** 338
- PASS AIR BAG OFF indicator lamp**
see Passenger front air bag off indicator lamp

- Passenger front air bag** 48
 Messages in the multifunction display 258
- Passenger front air bag off indicator lamp** 38, 49, 305
- Passenger safety**
 see Occupant safety
- Pedals** 236
- Phone**
 see Telephone
- Plastic parts, cleaning** 248
- Power assistance** 237
- Power closing assist for trunk lid** 87
- Power outlet** 187
- Power seats**
 see Seats
- Power washer** 244
- Power windows** 107
 Cleaning 247
 Door windows 107
 Operation 107
 Rear side windows 108
 Synchronizing 108
- Practical hints** 252
- Problems**
 While driving 112
 With vehicle 22
- Product information** 18
- Production options weight** 232
- Program mode selector dial (SL 63 AMG)**
 Automatic shift program 119
 Manual shift program 121
- Program mode selector switch**
 Automatic shift program 118, 119
 Manual shift program 122
- Proximity key**
 see Key, SmartKey
- PSI (air pressure unit)** 232
- Push-start**
 see Tow-start
- R**
- RACE START (SL 63 AMG)** 156
- RACETIMER** 130
- Radio**
 Selecting stations 133
- Radio transmitters** 240
- Rear axle oil** 351
- Rear fog lamp**
 see Fog lamps
- Rear lamps**
 see Tail lamps
- Rear window defroster** 173
- Recommended tire inflation pressure** 215, 232
- Recovery services, Stolen vehicle (Tele Aid)** 193
- Refrigerant, air conditioning** 354
- Refueling** 201
- Regular checks** 202
- Reminder, Seat belt**
 see Seat belts, Telltale
- Remote control**
 see Key, SmartKey
- Remote door unlock (Tele Aid)** 192
- Replacing bulbs** 311
 Brake lamps 311
 Headlamps 311
 High-beam headlamps 311
 High-mounted brake lamp 311
 License plate lamps 311
 Low-beam headlamps 311
 Parking lamps 311
 Side marker lamps 311
 Standing lamps 311
 Tail lamps 311
 Turn signal lamps 311
- Reporting safety defects** 22
- Research Octane Number**
 see RON
- Reserve fuel**
 Messages in the multifunction display 285
 Warning lamp 33, 301
- Reset button** 31, 124, 135
- Restraint systems**
 see Occupant safety

Retractable hardtop	173
Locking	176
Luggage cover	178
Messages in the multifunction display	276
Sunshade	180
Wind screen	176
Rims	232, 343
Roadside Assistance	20, 190
Roll bar	59
Lowering	59
Messages in the multifunction display	274
Raising	59
Warning lamp	300
RON (Research Octane Number)	201, 354
Roof	
see Retractable hardtop	
Route guidance	
see Navigation system	
Rubber parts, cleaning	248
Run-flat tires	
see MOExtended tires	

S

Safety

Driving safety systems	63
Occupant safety	44
Reporting defects	22

Safety belts

 see Seat belts

Seat belt force limiter

57

Seat belts

53

Automatic comfort-fit feature	57
Children in the vehicle	60
Cleaning	249
Fastening	55
Proper use of	54
Safety guidelines	47
Safety notes	53
Telltale	33, 296
Warning lamp	296

Seating capacity

213

Seats

89

Adjusting	90
Easy-entry/exit feature	95
Heating	93
Memory function	97
Multicontour seat	92
Ventilation	92

Selective setting

 see Key, SmartKey

Selector lever

 see Gear selector lever

Self-test

OCS	52
Tele Aid	188

Service

 see Maintenance

Service, parts

338

Service and warranty information

19

Service intervals

 see Maintenance System, Service indicator

Service life (tires)

211

Settings

Control system menus and sub-menus	128
Factory setting (SmartKey)	77, 79
Individual (vehicle)	135
Memory function	97
Menu	135
Selective setting (SmartKey)	77, 79

Side marker lamps

Cleaning lenses	246
---------------------------	-----

Messages in the multifunction display	287
Replacing bulbs	311

Sidewall (tires)

232

Side windows

 see Power windows

- SmartKey**
 - see Key, SmartKey
 - SmartKey with KEYLESS-GO**
 - see Key, SmartKey
 - Snow chains** 234
 - Snow tires**
 - see Winter tires
 - Spare wheel** 253, 343
 - Mounting 318
 - Speedometer** 149
 - Speed settings**
 - Distronic 151
 - Resume function 152
 - SRS** 45
 - Indicator lamp 33, 297
 - Messages in the multifunction display 274
 - Standing water, driving through** . . . 240
 - Starter switch positions** 87, 88
 - Starting difficulties (engine)** 110
 - Starting the engine** 109
 - Steering column**
 - see Multifunction steering wheel, Adjusting
 - Steering wheel**
 - see Multifunction steering wheel
 - Steering wheel gearshift control** . . . 120
 - Stolen Vehicle Recovery services** . . 193
 - Storage compartments** 34, 181
 - Storing tires** 211
-
- Submenu**
 - see Control system submenu
 - Sunshade** 180
 - Sun visors** 185
-
- T**
- Tachometer** 125
 - Overspeed range 125
 - Tail lamps** 311
 - Cleaning lenses 246
 - Messages in the multifunction display 289
 - Replacing bulbs 311
 - Tar stains** 245
 - Technical data**
 - Air conditioning refrigerant 354
 - Brake fluid 354
 - Capacities fuels, coolants, lubricants etc. 350
 - Coolant 355
 - Dimensions 349
 - Electrical system 348
 - Engine 341
 - Engine oil additives 353
 - Engine oils 353
 - Fuel requirements 354
 - Gasoline additives 355
 - Identification labels 339
 - Premium unleaded gasoline 354
 - Rims and tires 343
 - Spare wheel 347
 - Washer and headlamp cleaning system 352
 - Weights 350
 - Tele Aid** 187
 - Emergency calls 188
 - Information button 191
 - Initiating an emergency call manually 189
 - Messages in the multifunction display 274
 - Remote door unlock 192
 - Roadside Assistance button 190
 - SOS button 189
 - Stolen Vehicle Recovery services . . 193
 - System self-test 188
 - Telephone** 36
 - Answering/ending a call 143
 - Hands-free microphone 40
 - Menu 142
 - Operation 142
 - Phone book 143
 - Redialing 144
 - Temperature**
 - Coolant 125
 - Interior temperature 168
 - Outside 129
 - Tightening torque**
 - Spark plugs 348
 - Wheels 324

- TIN (Tire Identification Number)** . . . 232
- Tire and Loading Information Placard** 212
- Tire and loading terminology** 230
- Tire Identification Number**
see TIN
- Tire inflation pressure**
Checking 217
Important notes on 216
Placard on driver's door B-pillar . . . 212
- Tire labeling** 223
- Tire load rating** 232
- Tire ply composition and material used** 232
- Tire Pressure Monitoring System (TPMS)** 218
Messages in the multifunction display 266, 291
- Tires** 209, 343
Advanced Tire Pressure Monitoring System (Advanced TPMS) . . . 220
Advanced TPMS low tire pressure telltale 303
Air pressure 215
Care and maintenance 210
Cleaning 211
Direction of rotation, spinning 212
Important notes on tire inflation pressure 216
Inflation pressure 216, 217
Information placard 212
Inspection 210
Labeling 223
Load rating 232
Messages in the multifunction display 266, 291
MOExtended 343
Ply composition and material used . . . 232
Problems under-/overinflation 216
Retreads 209
Rims and tires (technical data) 343
Rotation 233
Service life 211
Sizes 343
Snow chains 234
Speed rating 225, 232
Storing 211
Temperature 216, 230
Terminology 230
Tire Identification Number 232
Tire Pressure Monitoring System (TPMS) 218
TPMS low tire pressure/malfunction telltale 33, 303
Traction 229, 232
Tread 232
Tread depth 211, 234
Treadwear indicators 211, 232
Vehicle maximum load on 233
Wear pattern 233
Winter tires 234, 343
- Tire speed rating** 225, 232
- Top tether**
Children in the vehicle 60
- Total load limit** 232
- Tow-away alarm** 72
- Towing eye bolt** 331
- Towing the vehicle** 330
- Tow-start** 328, 330
- Traction** 232
- Transmission**
see Automatic transmission
- Transmission fluid level** 207
- Transmission gear selector lever**
see Gear selector lever
- Transmission positions** 116
- Traveling abroad** 240
- Tread (tires)** 232
- Tread depth (tires)** 211, 234
- Treadwear indicators (tires)** 211, 232
- Trip computer menu** 141
- Trip odometer, resetting** 125
- Trunk**
Closing 83
Load assist 184
Messages in the multifunction display 275
Opening 82

- Opening/closing system 82, 83, 85
- Trunk lid emergency release 86
- Unlocking in an emergency 307
- Valet locking 86
- Turning off the engine** 114
- Turn signals** 102
 - Additional in mirrors 311
 - Bulbs 311
 - Cleaning lenses 246
 - Indicator lamps 31
 - Messages in the multifunction display 290
 - Replacing bulbs 311

U

- Uniform Tire Quality Grading Standards** 229, 233
- Units, Settings**
 - Speedometer 137
- Unleaded gasoline, premium** 354
- Unlocking the vehicle** 76, 78
 - Manually 307
- Upholstery, cleaning** 249
- Useful features** 185

V

- Valet locking** 86
- Vehicle**
 - Battery 326
 - Care 243
 - Control system 126
 - Dimensions 349
 - Individual settings 135
 - Locking/unlocking 76, 78
 - Locking/unlocking manually 307
 - Lowering (wheel change) 324
 - Modifications and alterations, Operating safety 21
 - Towing 330
- Vehicle jack**
 - see Jack
- Vehicle lighting** 98
- Vehicle loading**
 - Load limit 213
 - Terminology 230
- Vehicle maximum load on the tire** 233
- Vehicle Recovery services, Stolen (Tele Aid)** 193
- Vehicle status message memory** 134
- Vehicle tool kit** 252
- Vehicle washing**
 - see Vehicle care

W

- Warning lamps**
 - see Lamps, Indicator and warning
- Warning sounds**
 - Distance warning function 155
 - Distronic 149
 - Driver's or passenger's seat belt 56
 - Parking brake 273
 - Parktronic system 163
 - Seat belt telltale 296
- Warranty coverage** 338
- Washer fluid**
 - Messages in the multifunction display 278
 - Mixing ratio 357
 - Refilling 208
 - Wiping 106
- Washer system** 357
- Washing the vehicle** 243
- Wear pattern (tires)** 233
- Wheel**
 - Changing 318
 - Removing 321
 - Spare 318
 - Tightening torque 324
- Wheels, sizes** 343
- Wheels, Tires and** 209
- Windows**
 - see Power windows

Windows, cleaning	247
Wind screen	176
Windshield	
Cleaning wiper blades	247
Defogging	171
Washer fluid	106, 357
Wipers	105
Windshield wipers	
Replacing wiper blades	316
Winter driving	
Snow chains	234
Tires	234
Winter driving instructions	235
Winter tires	234, 343
Wood trims, cleaning	249

Operator's Manual

Product Information

Please observe the following in your own best interest:

We recommend using Genuine Mercedes-Benz Parts as well as conversion parts and accessories explicitly approved by us for your vehicle model.

We have tested these parts to determine their reliability, safety and special suitability for Mercedes-Benz vehicles.

We are unable to make an assessment for other products and therefore cannot be held responsible for them, even if in individual cases an official approval or authorization by governmental or other agencies should exist. Use of such parts and accessories could adversely affect the safety, performance or reliability of your vehicle. Please do not use them.

Genuine Mercedes-Benz Parts and pre-approved conversion parts and accessories are available at any authorized Mercedes-Benz Center. In addition, you will receive comprehensive information on permissible technical modifications and expert installations.

Operator's Manual

Notes

This Operator's Manual contains a great deal of useful information. We urge you to read it carefully and familiarize yourself with the vehicle before driving.

For your own safety and longer service life of the vehicle, we urge you to follow the instructions and warnings contained in this Operator's Manual. Ignoring them could result in damage to the vehicle or personal injury to you or others. Vehicle damage caused by failure to follow instructions is not covered by the Mercedes-Benz Limited Warranty.

We continuously strive to improve our product, and ask for your understanding that we reserve the right to make changes in design and equipment. Therefore, information, illustrations and descriptions in this Operator's Manual might differ from your vehicle.

Vehicle equipment

Your vehicle may have some or all of the equipment described in this manual. Therefore, you may find explanations for optional equipment not installed in your vehicle. If you have any questions about operating any equipment, any authorized Mercedes-Benz Center will be glad to demonstrate the proper procedures.

Optional equipment is also described in this manual, including operating instructions wherever necessary. Since they are special-order items, the descriptions and illustrations herein may vary slightly from the actual equipment of your vehicle.

If there are any equipment details that are not shown or described in this Operator's Manual, any authorized Mercedes-Benz Center will be glad to inform you of correct care and operating procedures. The Operator's Manual and Maintenance Booklet are important documents and should be kept with the vehicle.

Service and warranty information

The Service and Warranty Information booklet contains detailed information about the warranties covering your Mercedes-Benz, including:

- New Car Limited Warranty
- Emission System Warranty
- Emission Performance Warranty
- California, Connecticut, Maine, Massachusetts, New York, Pennsylvania, Rhode Island, and Vermont Emission Control System Warranty
- State Warranty Enforcement Laws (Lemon Laws)

Important notice for California retail buyers and lessees of Mercedes-Benz automobiles

Under California law you may be entitled to a replacement of your vehicle or a refund of the purchase price or lease price, if after a reasonable number of repair attempts Mercedes-Benz USA, LLC and/or its authorized repair or service facilities fail to fix one or more substantial defects or malfunctions in the vehicle that are covered by its express warranty. During the period of 18 months from original delivery of the vehicle or the accumulation of 18 000 miles (approximately 29 000 km) on the odometer of the vehicle, whichever occurs first, a reasonable number of repair attempts is presumed for a retail buyer or lessee if one or more of the following occurs:

- (1) the same substantial defect or malfunction results in a condition that is likely to cause death or serious bodily injury if the vehicle is driven, that defect or malfunction has been subject to repair two or more times, and you have directly notified Mercedes-Benz USA, LLC in writing of the need for its repair,
- (2) the same substantial defect or malfunction of a less serious nature than cate-

gory (1) has been subject to repair four or more times and you have directly notified us in writing of the need for its repair, or

- (3) the vehicle is out of service by reason of repair of the same or different substantial defects or malfunctions for a cumulative total of more than 30 calendar days.

Written notification should not be sent to a dealer, it should be addressed to Mercedes-Benz USA, LLC Customer Assistance Center One Mercedes Drive Montvale, NJ 07645-0350

Maintenance

The Maintenance Booklet describes all the necessary maintenance work which should be performed at regular intervals.

Always have the Maintenance Booklet with you when you take the vehicle to an authorized Mercedes-Benz Center for service. The service advisor will record each service in the booklet for you.

Operator's Manual

Roadside Assistance

The Mercedes-Benz Roadside Assistance Program provides factory-trained technical help in the event of a breakdown. Calls to the toll-free Roadside Assistance number

1-800-FOR-MERCEdes (in the USA)
1-800-387-0100 (in Canada)

will be answered by Mercedes-Benz Customer Assistance Representatives 24 hours a day, 365 days a year.

For additional information refer to the Mercedes-Benz Roadside Assistance Program brochure (in the USA) or the Roadside Assistance section of the Service and Warranty Information Booklet (in Canada) in your vehicle literature portfolio.

Change of address or ownership

If you change your address, be sure to send in the "Change of Address Notice" found in the Service and Warranty Information Booklet, or simply call the Mercedes-Benz Customer Assistance Center (in the USA) at 1-800-FOR-MERCEdes, or Customer Service (in Canada) at 1-800-387-0100. This will assist us in contacting you in a timely manner should the need arise.

If you sell your Mercedes, please leave all literature with the vehicle to make it available to the next operator.

If you bought this vehicle used, be sure to send in the "Notice of Purchase of Used Car" found in the Service and Warranty Information Booklet, or call the Mercedes-Benz Customer Assistance Center (in the USA) at 1-800-FOR-MERCEdes, or Customer Service (in Canada) at 1-800-387-0100.

Operating your vehicle outside the USA or Canada

If you plan to operate your vehicle in foreign countries, please be aware that:

- service facilities or replacement parts may not be readily available,
- unleaded gasoline for vehicles with catalytic converters may not be available; the use of leaded fuels will damage the catalysts,
- gasoline may have a considerably lower octane rating, and improper fuel can cause engine damage.

Certain Mercedes-Benz models are available for delivery in Europe under our European Delivery Program. For details, consult an authorized Mercedes-Benz Center or write to:

In the USA:

Mercedes-Benz USA, LLC
European Delivery Department
One Mercedes Drive
Montvale, NJ 07645-0350

In Canada:

Mercedes-Benz Canada, Inc.
European Delivery Department
98 Vanderhoof Avenue
Toronto, Ontario M4G 4C9

Operating safety

Warning!

Work improperly carried out on electronic components and associated software could cause them to cease functioning. Because the vehicle's electronic components are interconnected, any modifications made may produce an undesired effect on other systems. Electronic malfunctions could seriously impair the operating safety of your vehicle.

Contact an authorized Mercedes-Benz Center for repairs or modifications to electronic components.

Other improper work or modifications on the vehicle could also have a negative impact on the operating safety of the vehicle.

Some safety systems only function while the engine is running. You should therefore never turn off the engine while driving.

Warning!

Heavy blows against the vehicle underbody or tires/wheels, for example when running over an obstacle, road debris or a pothole, may cause serious damage and impair the

operating safety of your vehicle. If you feel a sudden significant vibration or ride disturbance, or you suspect that damage to your vehicle has occurred, you should turn on your hazard warning flashers, carefully slow down, and drive with caution to an area which is a safe distance from the road. Inspect the vehicle underbody and tires/wheels for possible damage. If the vehicle appears unsafe, have it towed to the nearest authorized Mercedes-Benz Center or other qualified maintenance or repair facility for further inspection or repairs.

Proper use of the vehicle

Proper use of the vehicle requires that you are familiar with the following information and rules:

- the safety precautions in this manual
- the "Technical data" section in this manual
- traffic rules and regulations
- motor vehicle laws and safety standards

Warning!

Various warning labels are attached to your vehicle. These warning labels are intended

to make you and others aware of various risks. You should not remove any of these warning labels unless explicitly instructed to do so by information on the label itself. Removal of any of these labels may cause you and others to be unaware of certain risks which may result in an accident and/or personal injury.

Reporting safety defects

Problems with your vehicle

If you should experience a problem with your vehicle, particularly one that you believe may affect its safe operation, we urge you to contact an authorized Mercedes-Benz Center immediately to have the problem diagnosed and corrected if required. If the matter is not handled to your satisfaction, please discuss the problem with the Mercedes-Benz Center management or, if necessary, contact us at one of the following addresses:

In the USA:

Customer Assistance Center
Mercedes-Benz USA, LLC
One Mercedes Drive
Montvale, NJ 07645-0350

In Canada:

Customer Relations Department
Mercedes-Benz Canada, Inc.
98 Vanderhoof Avenue
Toronto, Ontario M4G 4C9

Reporting safety defects

For the USA only:

The following text is published as required of manufacturers under Title 49, Code of U.S. Federal Regulations, Part 575 pursuant to the “National Traffic and Motor Vehicle Safety Act of 1966”.

Reporting safety defects

If you believe that your vehicle has a defect which could cause a crash or could cause injury or death, you should immediately inform the National Highway Traffic Safety Administration (NHTSA) in addition to notifying Mercedes-Benz USA, LLC.

If NHTSA receives similar complaints, it may open an investigation, and if it finds that a safety defect exists in a group of vehicles, it may order a recall and remedy campaign. However, NHTSA cannot become involved in individual problems between you, your dealer, or Mercedes-Benz USA, LLC.

To contact NHTSA, you may call the Vehicle Safety Hotline toll-free at 1-888-327-4236 (TTY: 1-800-424-9153); go to <http://www.safercar.gov>; or write to: Administrator, NHTSA Headquarters,

1200 New Jersey Avenue, SE, West Building,
Washington, DC 20590.

You can also obtain other information about motor vehicle safety from <http://www.safercar.gov>.

Vehicle data recording

Information regarding electronic recording devices

(Including notice pursuant to California Code § 9951)

Please note that your vehicle is equipped with devices that can record vehicle systems data and, if equipped with the Tele Aid system, may transmit some data in certain accidents.

This information helps, for example, to diagnose vehicle systems after a collision and to continuously improve vehicle safety. Daimler may access the information and share it with others

- for safety research or vehicle diagnosis purposes
- with the consent of the vehicle owner or lessee
- in response to an official request by law enforcement or other government agency
- for use in dispute resolution involving Daimler, its affiliates or sales/service organization and/or
- as otherwise required or permitted by law.

Please check the Tele Aid subscription service agreement for details regarding the infor-

mation that may be recorded or transmitted via that system.

Exterior view	26
Cockpit	28
Instrument cluster	30
Storage compartments	34
Multifunction steering wheel	36
Center console	38
Overhead control panel	40
Door control panel	41



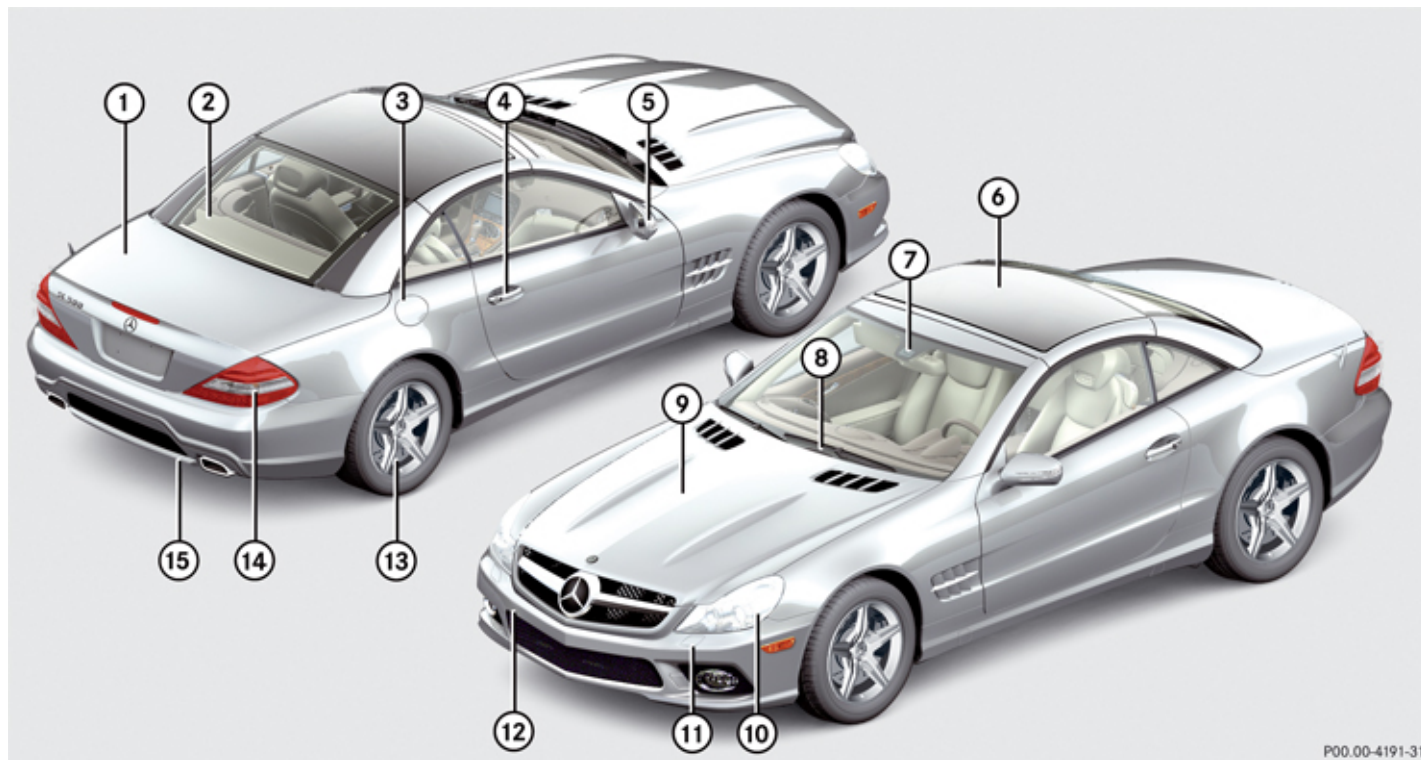

P00.00-4191-31

Exterior view

i This Operator's Manual describes all features, standard or optional, potentially available for your vehicle at the time of purchase. Please be aware that your vehicle might not be equipped with all features described in this manual.

	Function	Page
①	Trunk	
	Locking and unlocking	76
	Opening and closing	82, 83
	Valet locking	86
	Vehicle tool kit	252
②	Rear window defroster	173
③	Fuel filler flap	201
	Fuel requirements	354
④	Doors	
	Locking and unlocking	76
	Opening	80
	Locking and unlocking manually	308
⑤	Exterior rear view mirrors	96

	Function	Page
⑥	Retractable hardtop	173
⑦	Windshield	
	Cleaning with wiper fluid	106
	Cleaning	247
⑧	Wipers	105
	Wiper blades, replacing	316
	Wiper blades, cleaning	247
⑨	Hood	203
	Engine oil	204
	Coolant	207
⑩	Front lamps	311
⑪	Headlamp cleaning system	103
⑫	Front towing eye	331

	Function	Page
⑬	Tires and wheels	209, 343
	Checking tire inflation pressure	217
	Spare wheel	346
	Flat tire	317
⑭	Rear lamps	311
⑮	Rear towing eye	331

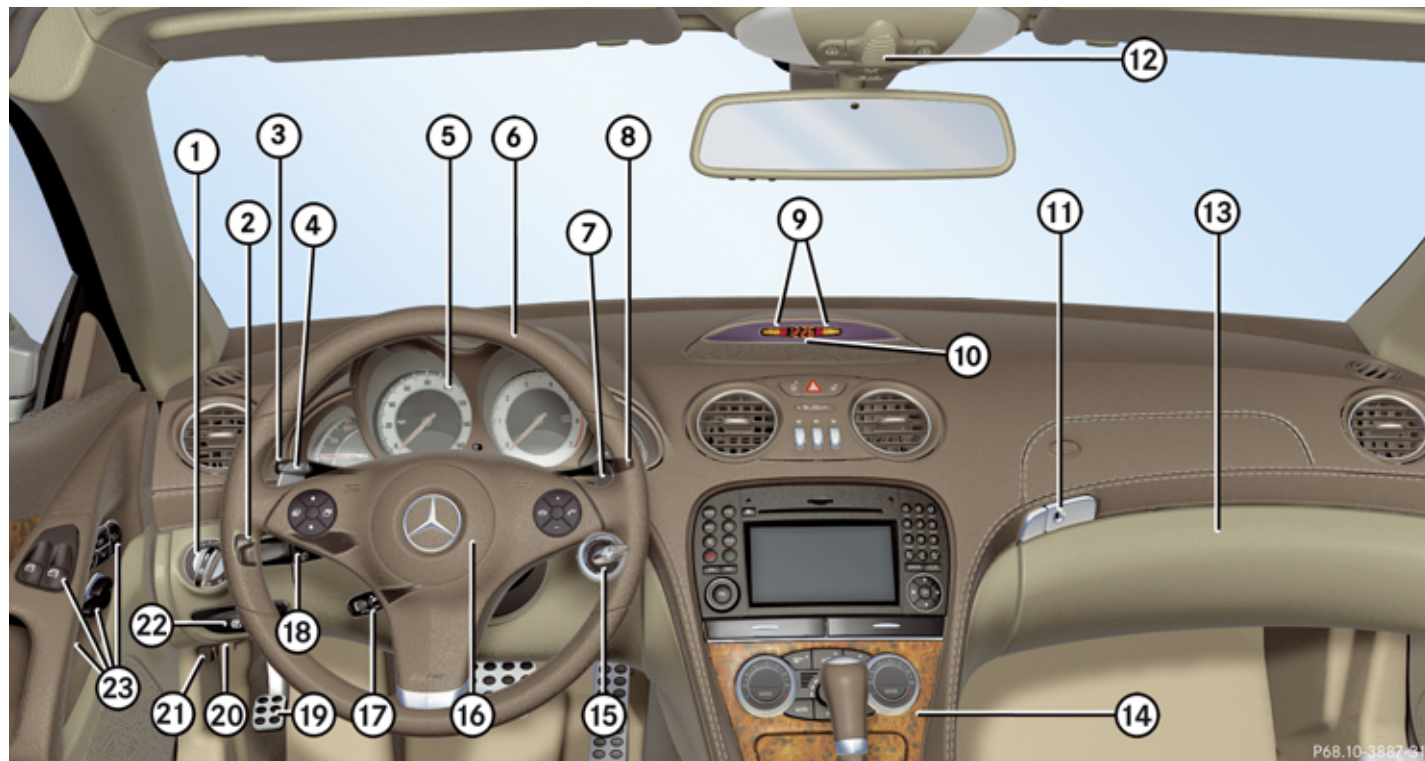

P68.10-3887-01





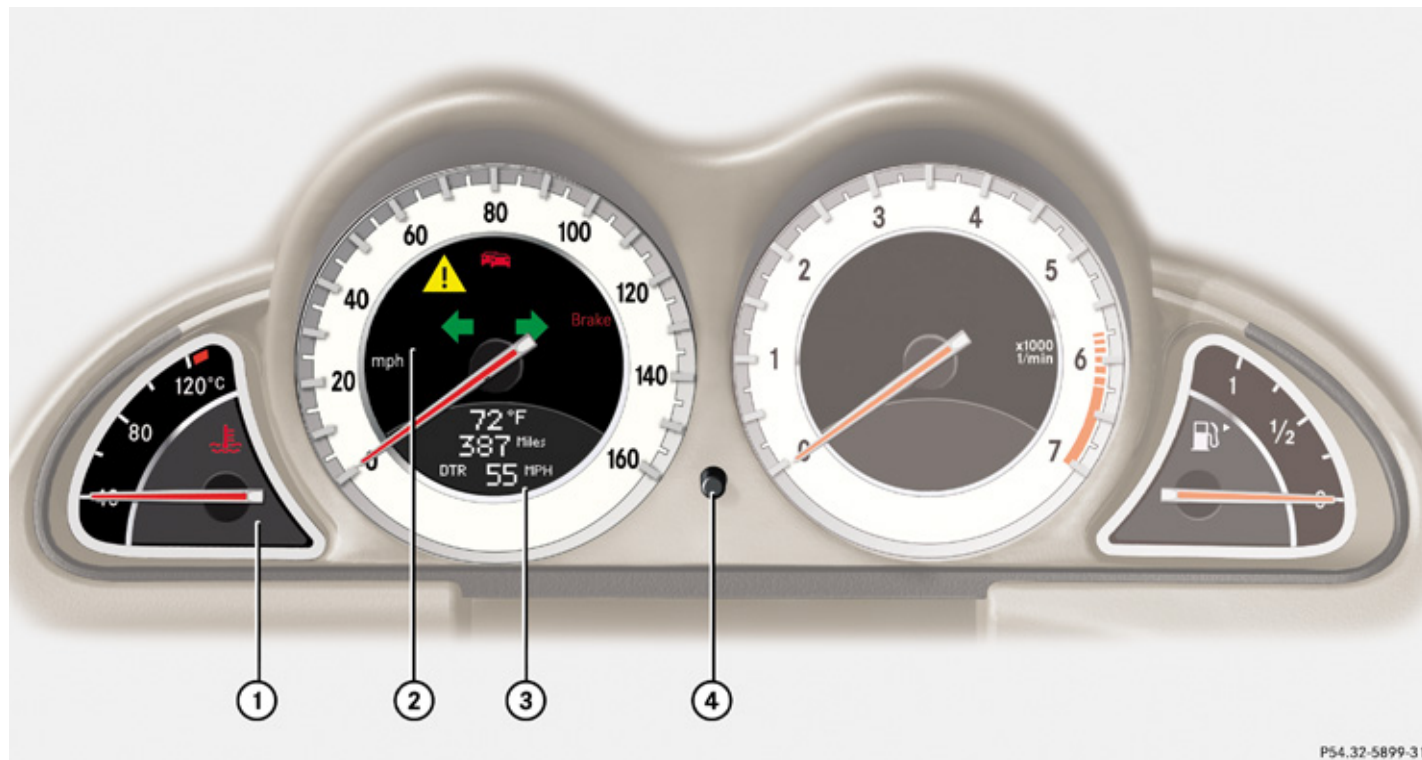

Cockpit

	Function	Page
①	Exterior lamp switch	99
②	Headlamp cleaning button	103
③	Cruise control lever	
	• Cruise control	145
	• Distronic	150
④	Left gearshift control	120
⑤	Instrument cluster	30, 124
⑥	Multifunction steering wheel	36, 126
⑦	Right gearshift control	120
⑧	Lever for Voice Control System, see separate operating instructions	
⑨	Front Parktronic warning indicators	161
⑩	Digital clock	

	Function	Page
⑪	Interior storage compartments (locking/unlocking)	182
⑫	Overhead control panel	40
⑬	Glove box	169, 181
⑭	Center console	38
⑮	Starter switch	87
⑯	Horn	
⑰	Steering wheel adjustment stalk	95
⑱	Combination switch	
	• Turn signals	102
	• Wipers	105
	• High beam	101
⑲	Parking brake pedal	113
⑳	On-board diagnostics (OBD) socket	

	Function	Page
㉑	Hood lock release lever	203
㉒	Parking brake release	113
㉓	Door control panel	41



	Function	Page
①	Coolant temperature gauge	125
	 Coolant temperature warning lamp	303
②	Speedometer with:	
	 Left turn signal indicator lamp	
	 ABS/ESP® warning lamp	296
	 Distrionic indicator lamp (white) or distance warning lamp (red) ¹	149, 150
	 BRAKE Brake warning lamp, USA only	295
	 Brake warning lamp, Canada only	295
	 Right turn signal indicator lamp	







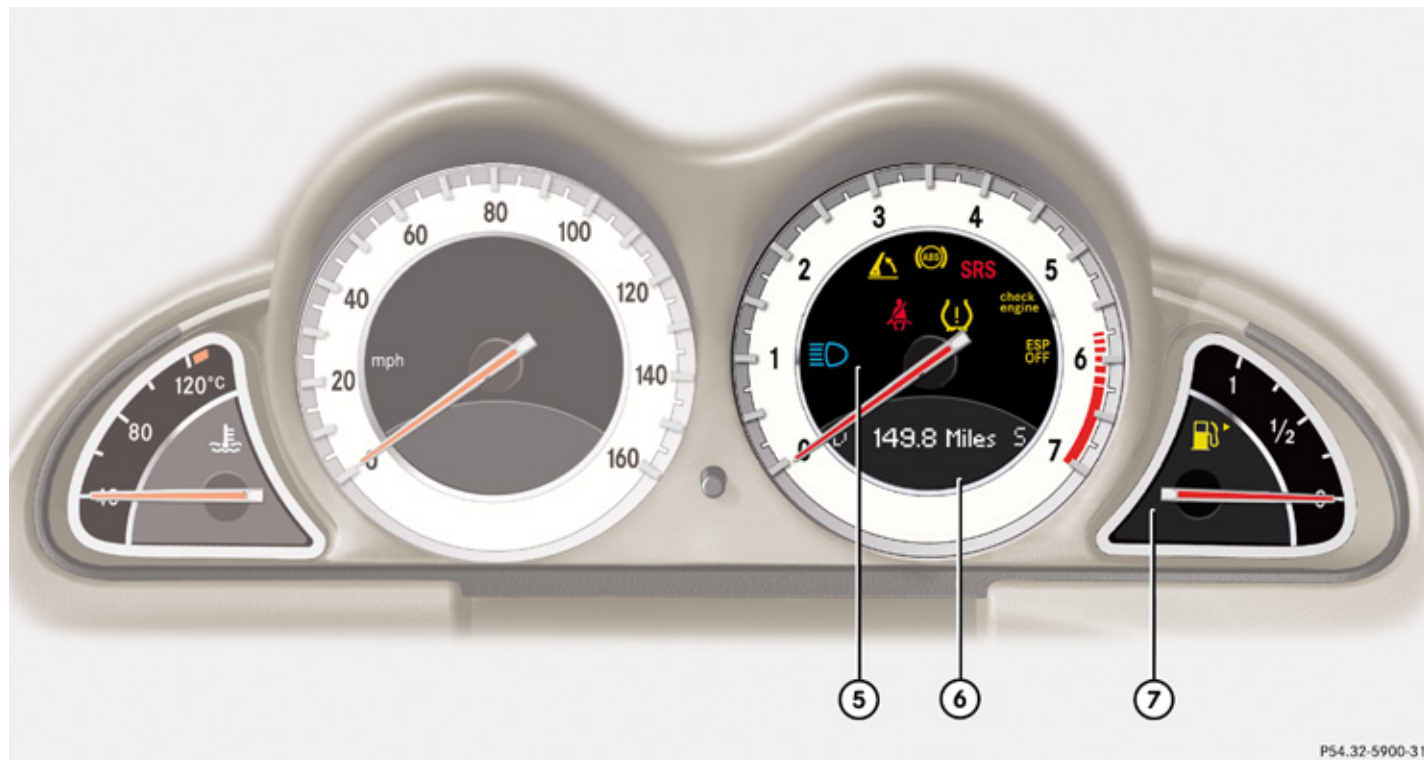

	Function	Page
③	Left multifunction display with:	
	Outside temperature indicator or digital speedometer (depending on selected setting in the control system)	129, 136
	Main odometer	127
	Set speed for cruise control or Distrionic	144, 150
④	Reset button for:	
	Resetting trip odometer	125
	Resetting individual settings	135
	Adjusting instrument cluster illumination	125



¹ Vehicles without Distrionic: Warning/indicator lamp without function. It illuminates when the ignition is switched on. It should go out when the engine is running.

Instrument cluster



P54.32-5900-31

	Function	Page
⑤	Tachometer with:	
	 High-beam headlamp indicator lamp	101
	 Seat belt telltale	56, 296
	 Roll bar warning lamp	300
	 Antilock Brake System (ABS) indicator lamp	64, 293
	 Supplemental Restraint System (SRS) indicator lamp	45, 297
	 Engine malfunction indicator lamp, USA only	302
	 Engine malfunction indicator lamp, Canada only	302
	 Combination low tire pressure/TPMS malfunction telltale, USA only	218, 303
	 Low tire pressure telltale, Canada only	220, 303

	Function	Page
	 ESP OFF warning lamp, SL 63 AMG only	67, 299
⑥	Right multifunction display with:	
	Trip odometer	125
	Transmission position indicator	116
	Gear range indicator	118
	Transmission program mode indicator	118
⑦	Fuel gauge with:	
	 Fuel tank reserve warning lamp (the arrow indicates that the fuel filler flap is on the right-hand side)	301

Storage compartments

Storage compartments

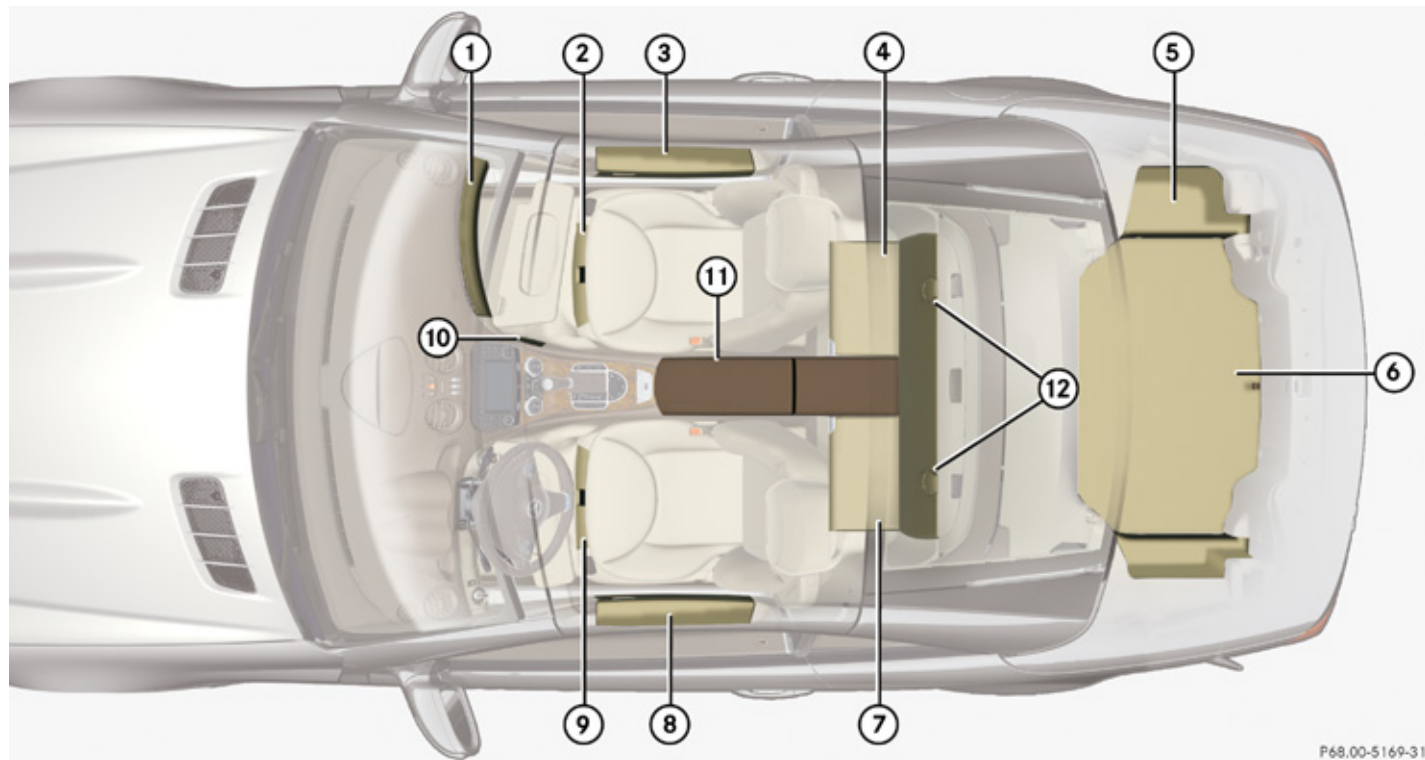

Storage compartments



	Function	Page
①	Glove box	181
②	Passenger seat storage compartment	182
	First aid kit	252
③	Door storage compartment	182
④	Rear storage compartment, passenger side	182
⑤	Side storage compartment in trunk, parcel net	180
⑥	Trunk	
	Load assist	184
	Luggage cover	178
⑦	Rear storage compartment, driver's side	182
⑧	Door storage compartment	182
⑨	Driver's seat storage compartment	182



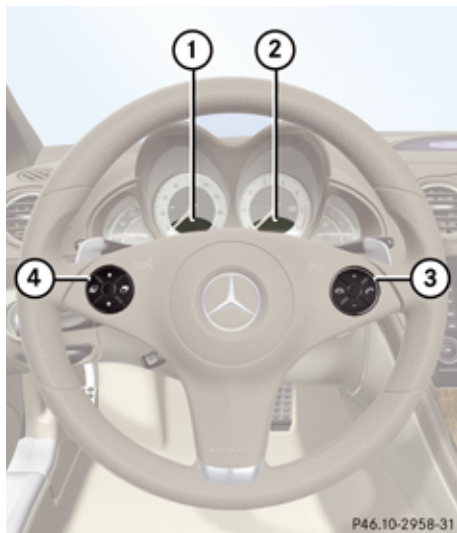

	Function	Page
⑩	Parcel net in passenger footwell	180
⑪	Storage/telephone compartment	181
⑫	Luggage straps	183

Multifunction steering wheel

Multifunction steering wheel





	Function	Page
①	Left multifunction display	127
②	Right multifunction display	127
③	Press button 	
	<ul style="list-style-type: none"> to take a call to dial² to redial² 	142
	Press button 	
	<ul style="list-style-type: none"> to end a call to reject an incoming call 	142



	Function	Page
	Press button  or 	
	<ul style="list-style-type: none"> to select submenus in the Settings menu to set values to operate the RACE-TIMER³ to set the volume 	136
④	Press button  or  to select next/previous menu	130
		126

² Function only available in telephone menu.

³ AMG vehicles only.

Multifunction steering wheel

Function	Page
Press button  or  briefly <ul style="list-style-type: none"> to move within a menu to select previous or next track, scene or stored station within Audio/DVD menu to switch to the phone book and select a name or number within Telephone menu 	132 142

Function	Page
Press and hold button  or  <ul style="list-style-type: none"> to select previous or next track with quick search or to select previous or next station in station list or wave band within Audio/DVD menu to start the quick search in the phone book within Telephone menu 	132 142

Center console

Center console

Upper part



	Function	Page
①	Central locking switch	81
	Alarm system indicator lamp	71
②	Hazard warning flasher switch	102
③	Central locking switch	81
④	Passenger front air bag off indicator lamp	50
⑤	Center and side air vent adjustment	168
⑥	COMAND system, see separate operating instructions	
⑦	Cup holder	185
⑧	KEYLESS-GO start/stop button	88
⑨	Automatic climate control panel	164
⑩	Ashtray	186

	Function	Page
	Cigarette lighter	186
⑪	Cup holder	185

Center console

Lower part



	Function	Page
①	Gear selector lever	115
②	Parktronic system deactivation switch	162
③	Exterior rear view mirror adjustment	96
④	ABC suspension tuning button	159
⑤	Tow-away alarm off switch	73
⑥	Retractable hardtop switch Roll bar buttons	173 59
⑦	ABC vehicle level control button	158
⑧	Electronic Stability Program (ESP®) switch ⁴	65
⑨	Thumbwheel for setting following distance for Distronic ⁴	147, 153

	Function	Page
⑩	Distance warning function switch ⁴	147, 155
⑪	Program mode selector switch ⁴	118

⁴ Layout in SL 63 AMG differs.

Overhead control panel

Overhead control panel

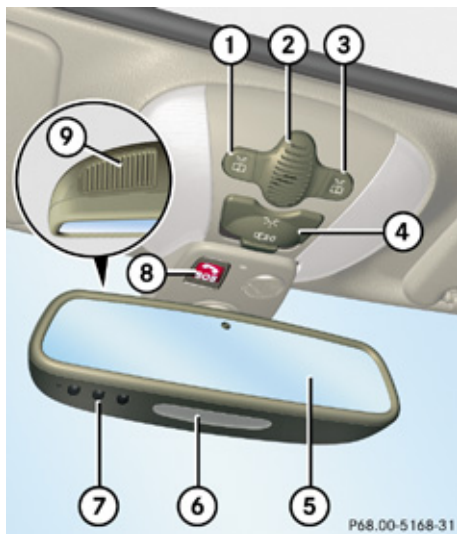

	Function	Page
①	Left reading lamp switch	104
②	Temperature sensor for automatic climate control	
③	Right reading lamp switch	104
④	Automatic interior lighting control	104
⑤	Interior rear view mirror	96
⑥	Reading lamp	96
⑦	Garage door opener	193
⑧	Tele Aid (emergency call system) button	189
⑨	Hands-free microphone for Tele Aid (emergency call system) and telephone	187

Door control panel

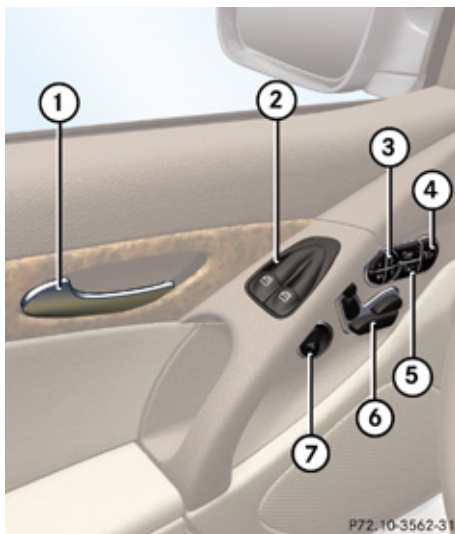

	Function	Page
①	Inside door handle	80
②	Power window switch	107
③	Memory function	97
	Memory position buttons	97
	Memory button	97
④	AIRSCARF switch	94
⑤	Seat heating switch	93
	Seat ventilation switch	92
⑥	Seat adjustment switch	90
⑦	Remote trunk opening switch	82
	Remote trunk opening/ closing switch	82, 83

Vehicle equipment	44
Occupant safety	44
Panic alarm	62
Driving safety systems	63
Anti-theft systems	71



Occupant safety

Vehicle equipment

i This Operator's Manual describes all features, standard or optional, potentially available for your vehicle at the time of purchase. Please be aware that your vehicle might not be equipped with all features described in this manual.

Occupant safety

Introduction

In this section you will learn the most important facts about the restraint system components of the vehicle.

The restraint systems are

- Seat belts
- Child restraints

Additional protection potential is provided by:

- Supplemental Restraint System (SRS) with
 - Air bags
 - Air bag control unit (with crash sensors)
 - Emergency Tensioning Device (ETD) for seat belts
 - Seat belt force limiter
- Roll bar
- Air bag system components with
 - Passenger front air bag off indicator lamp
 - Passenger seat with Occupant Classification System (OCS)

Although the systems are independent, their protective functions work in conjunction with each other.

Warning!

Modifications to or work improperly conducted on restraint system components or their wiring, as well as tampering with interconnected electronic systems, can lead to the restraint systems no longer functioning as intended.

Air bags or Emergency Tensioning Devices (ETDs), for example, could deploy inadvertently or fail to deploy in accidents although the deceleration threshold for air bag deployment is exceeded. Therefore, never modify the restraint systems. Do not tamper with electronic components or their software.

i For information on infants and children traveling with you in the vehicle and restraint systems for infants and children, see "Children in the vehicle" (▷ page 60).

SRS indicator lamp

The SRS system conducts a self-test when the ignition is switched on and in regular intervals while the engine is running. This facilitates detection of system malfunctions.

The **SRS** indicator lamp in the instrument cluster comes on when the ignition is switched on and goes out no later than a few seconds after the engine has been started. The SRS components are in operational readiness if the **SRS** indicator lamp is not lit when the engine is running.

A malfunction in the system has been detected if the **SRS** indicator lamp:

- fails to go out after approximately 4 seconds after the engine is started
- does not come on at all
- comes on after the engine was started or while driving

Warning!

In the event that the **SRS** indicator lamp comes on while driving or does not come on at all, the SRS self-check has detected a malfunction. For your safety, we strongly recommend that you contact an authorized Mercedes-Benz Center immediately to

have the system checked; otherwise the SRS may not deploy when needed in an accident, which could result in serious or fatal injury, or it might deploy unexpectedly and unnecessarily which could also result in injury.

In addition, improper work on the SRS creates a risk of rendering the SRS inoperative or causing unintended air bag deployment. Work on the SRS must therefore only be performed by qualified technicians. Contact an authorized Mercedes-Benz Center. If it is necessary to modify an air bag system to accommodate a person with disabilities, contact an authorized Mercedes-Benz Center or call our Customer Assistance Center at 1-800-FOR-MERCEdes (1-800-367-6372) for details.

Air bags

Warning!

Air bags are designed to reduce the potential of injury and fatality in certain frontal impacts (front air bags, driver side knee bags) or side impacts (head-thorax air bags). However, no system available today can completely eliminate injuries and fatalities.

The deployment of the air bags temporarily releases a small amount of dust from the air bags. This dust, however, is neither injurious to your health, nor does it indicate a fire in the vehicle. The dust might cause some temporary breathing difficulty for people with asthma or other breathing trouble. To avoid this, you may wish to get out of the vehicle as soon as it is safe to do so. If you have any breathing difficulty but cannot get out of the vehicle after the air bag inflates, then get fresh air by opening a window or door.

Warning!

To reduce the risk of injury when the front air bags inflate, it is very important for the driver and passenger to always be in a prop-

Occupant safety

erly seated position and to wear their seat belts.

For maximum protection in the event of a collision always be in normal seated position with your back against the seat backrest. Fasten your seat belt and make sure it is properly positioned on your body.

Since the air bag inflates with considerable speed and force, a proper seating position and correct positioning of the hands on the steering wheel will help to keep you at a safe distance from the air bag. Occupants who are not wearing their seat belt, are not seated properly or are too close to the air bag can be seriously injured or killed by an air bag as it inflates with great force instantaneously:

- Sit with the seat belt properly fastened in a position that is as upright as possible with your back against the seat backrest.
- Move the driver seat as far back as possible, still permitting proper operation of vehicle controls. The distance from the center of the driver's chest to the center of the air bag cover on the steering wheel must be at least 10 inches (25 cm) or more. You should be able to accomplish this by adjusting the seat and steering

wheel. If you have any difficulties, please contact an authorized Mercedes-Benz Center.

- Do not lean your head or chest close to the steering wheel or dashboard.
- Keep hands on the outside of the steering wheel rim. Placing hands and arms inside the rim can increase the risk and potential severity of hand/arm injury when the driver's front air bag inflates.
- Adjust the passenger seat as far as possible rearward from the dashboard when the seat is occupied.
- Occupants, especially children, should never place their bodies or lean their heads in the area of the door where the head-thorax air bag inflates. This could result in serious injuries or death should the head-thorax air bag be deployed. Always sit as upright as possible, wear the seat belt properly and use an appropriately sized infant restraint, toddler restraint, or booster seat recommended for the size and weight of the child.

Failure to follow these instructions can result in severe injuries to you or other occupants.

If you sell your vehicle, it is important that you make the buyer aware of this safety information. Be sure to give the buyer this Operator's Manual.

Warning!

There is a possibility of a head-thorax air bag related injury if occupants, especially children, are not properly seated or restrained when next to a head-thorax air bag which needs to deploy rapidly in a side impact in order to do its job.

To help avoid the possibility of injury, please follow these guidelines:

- (1) Occupants, especially children, should never place their bodies or lean their heads in the area of the door where the head-thorax air bag inflates. This could result in serious injuries or death should the head-thorax air bag be deployed.
- (2) Always sit as upright as possible, properly use the seat belts, and for children 12 years old and under, use an appropriately sized infant restraint, toddler restraint, or booster seat recom-

mended for the size and weight of the child.

(3) Always wear seat belts properly.

If you believe that, even with the use of these guidelines, it would be safer for your passenger seat occupants to have the passenger side head-thorax air bag deactivated, then deactivation can be carried out upon your written request at an authorized Mercedes-Benz Center at an additional cost.

Please contact an local authorized Mercedes-Benz Center or call the Customer Assistance Center (in the USA) at 1-800-FOR-MERCEdes (1-800-367-6372), or Customer Service (in Canada) at 1-800-387-0100 for details.

Air bags are designed to deploy only in certain frontal impacts (front air bags, driver side knee bag) and in side impacts (head-thorax air bags) which exceed preset deployment thresholds. Only in the event of such a situation will they provide their supplemental protection.

The driver and passenger should always wear their seat belts. Otherwise it is not possible for the air bags to provide their supplemental protection.

In case of other types of impacts and impacts below air bag deployment thresholds, air bags will not deploy. The driver and passenger will then be protected to the extent possible by a properly fastened seat belt. A properly fastened seat belt is also needed to provide the best possible protection in a rollover.

Air bags are not a substitute for seat belts. Always wear your seat belt, regardless of whether or not your vehicle is equipped with air bags.

It is important to your safety and that of your passenger that you replace deployed air bags and repair any malfunctioning air bags to make sure the vehicle will continue to provide supplemental crash protection for occupants.

Safety guidelines for the seat belt, Emergency Tensioning Device (ETD) and air bag

Warning!

- Damaged seat belts or seat belts that have been subjected to stress in an accident must be replaced and their anchoring points must also be checked. Only

use seat belts installed or supplied by an authorized Mercedes-Benz Center.

- Air bags and ETDs contain Perchlorate material, which may require special handling and regard for the environment. Check with your local government's disposal guidelines. California residents, see <http://www.dtsc.ca.gov/HazardousWaste/Perchlorate/index.cfm>.
- Air bags and ETDs are designed to function on a one-time-only basis. An air bag or ETD that is deployed must be replaced.
- Do not pass seat belts over sharp edges. They could tear.
- Do not make any modification that could change the effectiveness of the seat belts.
- Do not bleach or dye seat belts as this may severely weaken them. In a crash they may not be able to provide adequate protection.
- No modifications of any kind may be made to any components or wiring of the SRS. This includes changing or removing any component or part of the SRS, the installation of additional trim material, seat covers, badges, etc. over the steer-



Occupant safety

ing wheel hub, passenger front air bag cover, outboard sides of the seat backrests, door trim panels, or door frame trims, and installation of additional electrical/electronic equipment on or near SRS components and wiring. Keep area between air bags and occupant free of objects (e.g. packages, purses, umbrellas, etc.).

- Air bag system components will be hot after an air bag has inflated. Do not touch them.
- Never place your feet on the instrument panel, dashboard, or on the seat. Always keep both feet on the floor in front of the seat.
- In addition, improper repair work on the SRS creates a risk of rendering the SRS inoperative or causing unintended air bag deployment. Work on the SRS must therefore only be performed by qualified technicians. Contact an authorized Mercedes-Benz Center.
- For your protection and the protection of others, when scrapping the air bag unit or ETD, our safety instructions must be followed. These instructions are available

from any authorized Mercedes-Benz Center.

- Given the considerable deployment speed, required inflation volume, and the material of the air bags, there is the possibility of abrasions or other, potentially more serious injuries resulting from air bag deployment.

If you sell your vehicle, we strongly recommend that you inform the subsequent owner that the vehicle is equipped with SRS and refer them to the applicable section in the Operator's Manual.

Front air bags

 **Observe Safety notes, see page 47.**



- ① Driver air bag
- ② Passenger air bag
- ③ Knee bag

The front air bags are designed to provide increased protection for the driver and passenger against the risk of injuries to the head and thorax.

Driver and passenger air bags and driver's side knee bag are deployed:

- in the event of certain frontal impacts
- if impact exceeds a preset deployment threshold

- if the system determines that air bag deployment can offer additional protection to that provided by the seat belt
- depending on whether the seat belt is in use
- independently of the head-thorax air bags

The front air bags in this vehicle have been designed to inflate in two stages. This allows the air bags to have different rates of inflation that are based on the vehicle deceleration rate as assessed by the air bag control unit.

On the passenger side, the front air bag deployment is additionally influenced by the passenger's weight category as identified by the Occupant Classification System (OCS) (▷ page 50).

The lighter the passenger side occupant, the higher the vehicle deceleration rate required for second stage inflation of the air bag.

The air bags will not deploy in impacts which do not exceed the system's preset deployment thresholds. You will then be protected by the fastened seat belts.

The front air bags will not be deployed in the event of a rollover unless the vehicle's rate of longitudinal deceleration or acceleration exceeds the preset deployment threshold for the front air bags.

The passenger air bag ② will only be deployed if:

- the system, based on OCS weight sensor readings, detects that the passenger seat is occupied
- the  indicator lamp in the center console is not lit (▷ page 52)
- the impact exceeds a preset deployment threshold

Knee bag

The knee bag ③ is located on the driver side lower instrument panel. It is designed to operate together with the driver front air bag in certain frontal impacts exceeding a preset deployment threshold. The knee bag ③ operates best in conjunction with a properly positioned and fastened seat belt.

Head-thorax air bags

 **Observe Safety notes, see page 47.**

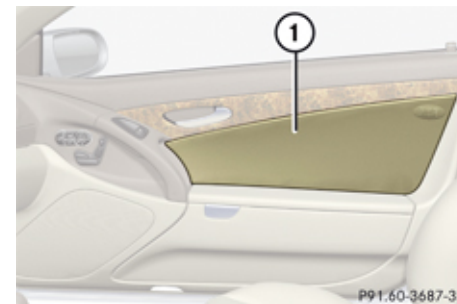

① Head-thorax air bag

When deployed, the head-thorax air bags are designed to provide increased protection for the head and thorax (but not for the arms) on the side of the vehicle on which the impact occurs.

The head-thorax air bags are deployed:

- on the impacted side of the vehicle
- in side impacts exceeding a preset deployment threshold
- if the system determines that air bag deployment can offer additional protection to that provided by the seat belt



Occupant safety

- depending on whether the seat belt is in use
- independently of the front air bags
- independently of the ETDs

The passenger head-thorax air bag  will only deploy if the OCS senses that the passenger seat is occupied and the impact exceeds a preset deployment threshold.

The head-thorax air bags are not deployed in side impacts which do not exceed the system's deployment threshold.

Occupant Classification System

The Occupant Classification System (OCS) automatically turns the passenger front air bag on or off based on the classified occupant weight category determined by weight sensor readings from the passenger seat.

The system does not deactivate the passenger head-thorax air bag and the Emergency Tensioning Devices (ETDs).

Occupants must sit with the seat belt properly fastened in a position that is as upright as possible with their back against the seat backrest and feet on the floor to be correctly classified. If the occupant's weight is transferred to another object in the vehicle (e.g. by



leaning on armrests), the OCS may not be able to properly approximate the occupant's weight category.

 If your seat, including the trim cover and cushion, needs to be serviced in any way, take the vehicle to an authorized Mercedes-Benz Center.

Only seat accessories approved by Mercedes-Benz may be used.

Both the driver and the passenger should always use the  indicator lamp as an indication of whether or not the passenger is properly positioned.

Warning!



If the  indicator lamp illuminates when an adult or someone larger than a small individual is in the passenger seat, have the passenger re-position himself or herself in the seat until the  indicator lamp goes out.

In the event of a collision, the air bag control unit will not allow passenger front air bag deployment when the OCS has classified the passenger seat occupant as weighting as much as or less than a typical 12-month-old child in a standard child restraint or if

the passenger seat is classified as being empty.

When the OCS senses that the passenger seat occupant is classified as being up to or less than the weight of a typical 12-month-old child in a standard child restraint, the  indicator lamp will illuminate when the engine is started and remain illuminated, indicating that the passenger front air bag is deactivated.

When the OCS senses that the passenger seat is classified as being empty, the  indicator lamp will illuminate when the engine is started and remain illuminated, indicating that the passenger front air bag is deactivated.

When the OCS senses that the passenger seat occupant is classified as being heavier than the weight of a typical 12-month-old child seated in a standard child restraint or as being a small individual (such as a young teenager or a small adult), the  indicator lamp will illuminate for approximately 6 seconds when the engine is started and then, depending on occupant weight sensor readings from the seat, remain illuminated or go out. With the  indicator lamp illuminated, the

passenger front air bag is deactivated. With the  indicator lamp out, the passenger front air bag is activated.

When the OCS senses that the passenger seat occupant is classified as an adult or someone larger than a small individual, the  indicator lamp will illuminate for approximately 6 seconds when the engine is started and then go out, indicating that the passenger front air bag is activated.

If the  indicator lamp is illuminated, the passenger front air bag is deactivated and will not be deployed.

If the  indicator lamp is not illuminated, the passenger front air bag is activated and will be deployed:

- in the event of certain frontal impacts
- if impact exceeds a preset deployment threshold
- independently of the head-thorax air bag

If the passenger front air bag is deployed, the rate of inflation will be influenced by:

- the rate of relevant vehicle deceleration as assessed by the air bag control unit
- the passenger's weight category as identified by the OCS.

For information about air bag display messages (▷ page 258).

Warning!

Children 12 years old and under must be seated and properly secured in an appropriate infant restraint, toddler restraint, or booster seat recommended for the size and weight of the child.





The infant or child restraint must be properly secured with the vehicle's seat belt fully in accordance with the child seat manufacturer's instructions.

Occupants, especially children, should always sit as upright as possible, wear the seat belt properly and use an appropriately sized infant restraint, toddler restraint, or booster seat recommended for the size and weight of the child.

Children can be killed or seriously injured by an inflating air bag. Note the following important information:

- Your vehicle is equipped with air bag technology designed to deactivate the passenger front air bag in your vehicle when the system senses the weight of a typical 12-month-old child or less along

with the weight of a standard appropriate child restraint on the passenger seat.

- A child in a rear-facing child restraint on the passenger seat will be seriously injured or even killed if the passenger front air bag inflates in a collision which could occur under some circumstances, even with the air bag technology installed in your vehicle.
- If you install a rear-facing child restraint on the passenger seat, make sure the  indicator lamp is illuminated, indicating that the passenger front air bag is deactivated. Should the  indicator lamp not illuminate or go out while the restraint is installed, please check installation. Periodically check the  indicator lamp while driving to make sure the  indicator lamp is illuminated. If the  indicator lamp goes out or remains out, do not transport a child on the passenger seat until the system has been repaired.

A child in a rear-facing child restraint on the passenger seat will be seriously

Occupant safety

injured or even killed if the passenger front air bag inflates.

- If you place a child in a forward-facing child restraint on the passenger seat, move the seat as far back as possible, use the proper child restraint recommended for the age, size and weight of the child, and secure child restraint with the vehicle's seat belt according to the child seat manufacturer's instructions. For children larger than the typical 12-month-old child, the passenger front air bag may or may not be activated.

Deployment of the driver front air bag does not mean that the passenger front air bag also should have deployed.

The OCS may have determined:

- that the seat was empty or occupied by the weight up to or less than that of a typical 12-month-old child seated in a standard child restraint – both instances where the system suppresses deployment of the passenger front air bag even though the impact met the criteria and was of sufficient severity to deploy the driver front air bag
- that the seat was occupied by a small individual (such as a young teenager or a small adult) or a child who weighs more than the



weight of a typical 12-month-old child in a standard child restraint – both of which are instances where the system may suppress deployment of the passenger front air bag even though the impact met the criteria and was of sufficient severity to deploy the driver front air bag



① Passenger front air bag off indicator lamp

The  indicator lamp ① will be illuminated, except with the SmartKey removed from the starter switch or with the starter switch in position 0.

Warning!

If the  indicator lamp and the  indicator lamp are lit at the same time, there is a malfunction in the OCS. The

passenger front air bag will be deactivated in this case. Have the system checked as soon as possible by qualified technicians. Contact an authorized Mercedes-Benz Center.



Only have the seat repaired or replaced at an authorized Mercedes-Benz Center.

In order to ensure proper operation of the air bag system and OCS

- Sit with the seat belt properly fastened in a position that is as upright as possible with your back against the seat backrest.
- While seated, an occupant should not position him/herself in such a way as to cause the occupant's weight to be lifted from the seat bottom as this may result in the OCS being unable to correctly approximate the occupant's weight category.
- Read and observe all warnings in this chapter.

Occupant Classification System Self-test

After turning the SmartKey in the starter switch to position 1 or 2 or pressing the KEY-LESS-GO start/stop button once or twice, the

 indicator lamp illuminates. If an adult occupant is properly sitting on the passenger seat and the system classifies the occupant as an adult, the  indicator lamp will illuminate and go out after approximately 6 seconds.

If the seat is not occupied and the system classifies the passenger seat as being empty, the  indicator lamp will illuminate and not go out.

Warning!

If the  indicator lamp does not illuminate, the system is not functioning. You must contact an authorized Mercedes-Benz Center before seating any child on the passenger seat.

For more information, see the “Practical hints” section (▷ page 305).

Warning!

Never place anything between seat cushion and child seat (e.g. pillow), since it reduces the effectiveness of the OCS. The bottom of the child seat must make full contact with the passenger seat cushion. An incorrectly mounted child seat could cause injuries to the child in case of an accident,

instead of increasing protection for the child.

Follow the manufacturer’s instructions for installation of child seats.

Seat belts

Safety notes

The use of seat belts and infant and child restraint systems is required by law in all 50 states, the District of Columbia, the U.S. territories and all Canadian provinces.

Even where this is not the case, all vehicle occupants should have their seat belts fastened whenever the vehicle is in motion.

For information on infants and children traveling with you in the vehicle and restraint systems for infants and children, see “Children in the vehicle” (▷ page 60).

Warning!

Always fasten your seat belt before driving off. Always make sure your passenger is properly restrained. You and your passenger should always wear seat belts.

Failure to wear and properly fasten and position your seat belt greatly increases

your risk of injuries and their likely severity in an accident.

If you are ever in an accident, your injuries can be considerably more severe without your seat belt properly buckled. Without your seat belt buckled, you are much more likely to hit the interior of the vehicle or be ejected from it. You can be seriously injured or killed.

In the same crash, the possibility of injury or death is lessened if you are properly wearing your seat belt. The air bags can only protect as intended if the occupants are properly wearing their seat belts.

Warning!

Never ride in a moving vehicle with the seat backrest in an excessively reclined position as this can be dangerous. You could slide under the seat belt in a collision. If you slide under it, the seat belt would apply force at the abdomen or neck. That could cause serious or even fatal injuries. The seat backrest and seat belt provide the best restraint when the wearer is in a position that is as upright as possible and the seat belt is properly positioned on the body.

Occupant safety

Warning!

Never let more people ride in the vehicle than there are seat belts available. Make sure everyone riding in the vehicle is correctly restrained with a separate seat belt. Never use a seat belt for more than one person at a time.

Warning!

Keep the door storage compartments closed while vehicle is in motion. Failure to do so may cause the seat belt to catch at the rear and prevent proper positioning of the seat belt.

Warning!

Damaged seat belts or seat belts that were highly stressed in an accident must be replaced and their anchoring points must also be checked.

Only use seat belts which have been approved by Mercedes-Benz.

Do not make any modifications to the seat belts. This can lead to unintended activation of the ETDs or to their failure to activate when necessary.

Do not bleach or dye seat belts as this may severely weaken them. In a crash they may not be able to provide adequate protection. Have all work carried out only by qualified technicians. Contact an authorized Mercedes-Benz Center.

Proper use of seat belts

Warning!

USE SEAT BELTS PROPERLY

- Seat belts can only work when used properly. Never wear seat belts in any other way than as described in this section, as that could result in serious injuries in case of an accident.
- Each occupant should wear their seat belt at all times, because seat belts help reduce the likelihood of and potential severity of injuries in accidents, including rollovers. The integrated restraint system includes SRS (driver front air bag, driver side knee bag, passenger front air bag, head-thorax air bags), Emergency Tensioning Device (ETD) and seat belt force limiters. The system is designed to enhance the protection offered to prop-

erly belted occupants in certain frontal (front air bags, driver side knee bag and ETD) and side (head-thorax air bags and ETD) impacts which exceed preset deployment thresholds.

- Never wear the shoulder belt under your arm, against your neck or off your shoulder. In a frontal crash, your body would move too far forward. That would increase the chance of head and neck injuries. The seat belt would also apply too much force to the ribs or abdomen, which could severely injure internal organs such as your liver or spleen. Adjust the seat belt so that the shoulder section is located as close as possible to the middle of the shoulder (it should not touch the neck). Never pass the shoulder portion of the seat belt under your arm.
- Position the lap belt as low as possible on your hips and not across the abdomen. If the lap belt is positioned across your abdomen, it could cause serious injuries in a crash.
- Never wear seat belts over rigid or breakable objects in or on your clothing, such as eyeglasses, pens, keys etc., as these might cause injuries.

- Make sure the seat belt is always fitted snugly. Take special care of this when wearing loose clothing.
- Never use a seat belt for more than one person at a time. Do not fasten a seat belt around a person and another person or other objects at the same time.
- Seat belts should not be worn twisted. In a crash, you would not have the full width of the seat belt to distribute impact forces. The twisted seat belt against your body could cause injuries.
- Pregnant women should also always use a lap-shoulder belt. The lap belt portion should be positioned as low as possible on the hips to avoid any possible pressure on the abdomen.
- Place the seat backrest in a position that is as upright as possible.
- Check your seat belt during travel to make sure it is properly positioned.
- Never place your feet on the instrument panel, dashboard, or on the seat. Always

keep both feet on the floor in front of the seat.

- When using a seat belt to secure infant restraints, toddler restraints, or children in booster seats, always follow the child seat manufacturer's instructions.

Warning!

Do not pass seat belts over sharp edges. They could tear.

Do not allow the seat belt to get caught in the door or in the seat adjustment mechanism. This could damage the seat belt.

Never attempt to make modifications to seat belts. This could impair the effectiveness of the seat belts.

Do not bleach or dye seat belts as this may severely weaken them. In a crash, they may not be able to provide adequate protection. Damaged seat belts or seat belts that were highly stressed in an accident must be replaced. Contact an authorized Mercedes-Benz Center.

Fastening the seat belts

Warning!

Always fasten your seat belt before driving off. Always make sure your passengers is properly restrained. You and your passenger should always wear seat belts.

Failure to wear and properly fasten and position your seat belt greatly increases your risk of injuries and their likely severity in an accident.

If you are ever in an accident, your injuries can be considerably more severe without your seat belt properly buckled. Without your seat belt buckled, you are much more likely to hit the interior of the vehicle or be ejected from it. You can be seriously injured or killed.

In the same crash, the possibility of injury or death is lessened if you are properly wearing your seat belt. The air bags can only protect as intended if the occupants are properly wearing their seat belts.

Warning!

Children 12 years old and under must be seated and properly secured in an appropriately sized infant restraint, toddler restraint, or booster seat recommended for



Occupant safety

the size and weight of the child. For additional information, see section “Children in the vehicle”.

A child’s risk of serious or fatal injuries is significantly increased if the child restraints are not properly secured in the vehicle and/or the child is not properly secured in the child restraint.

⚠ Warning!

Never let more people ride in the vehicle than there are seat belts available. Make sure everyone riding in the vehicle is correctly restrained with a separate seat belt. Never use a seat belt for more than one person at a time.

⚠ Warning!

Never ride in a moving vehicle with the seat backrest in an excessively reclined position as this can be dangerous. You could slide under the seat belt in a collision. If you slide under it, the seat belt would apply force at the abdomen or neck. That could cause serious or even fatal injuries. The seat backrest and seat belt provide the best restraint when the wearer is in a position that is as upright as possible and the seat belt is properly positioned on the body.

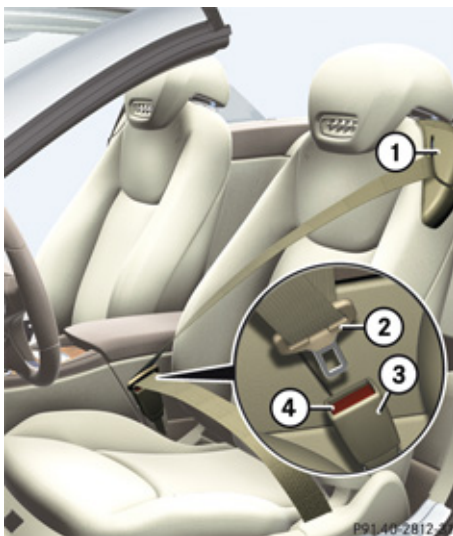

- ① Seat belt outlet
- ② Latch plate
- ③ Buckle
- ④ Seat belt release button

- ▶ With a smooth motion, pull the seat belt out of seat belt housing ①.
- ▶ Place the shoulder portion of the seat belt across the top of your shoulder and the lap portion across your hips.

- ▶ Push latch plate ② into buckle ③ until it clicks.
- ▶ If necessary, tighten the lap portion to a snug fit by pulling shoulder portion up.

Releasing the seat belts

- ▶ Press the seat belt release button (▷ page 56).

Allow the retractor to completely rewind the seat belt by guiding the latch plate.



- !** Make sure the seat belt retracts fully so that the seat belt and/or latch plate cannot get caught or pinched in the door or in the seat mechanism. This can damage the seat belt and impair its effectiveness, and/or cause damage to the door and/or door trim panel. Such damage is not covered by the Mercedes-Benz Limited Warranty. Damaged seat belts must be replaced. Contact an authorized Mercedes-Benz Center.

Enhanced seat belt reminder system

When the engine is started, the seat belt tell-tale  will always illuminate for 6 seconds

to remind you and your passenger to fasten your seat belts.

If the driver's seat belt is not fastened when the engine is started, an additional warning chime will also sound for a maximum of 6 seconds or until the driver's seat belt is fastened. If after these 6 seconds the driver's or the passenger's seat belt (with the passenger seat occupied) is not fastened with both doors closed,

- the seat belt telltale  remains illuminated for as long as either the driver's or passenger's seat belt is not fastened.
- and if the vehicle speed once exceeds 15 mph (25 km/h), the seat belt telltale  starts flashing and a warning chime sounds with increasing intensity for a maximum of 60 seconds or until the driver's and passenger's seat belt are fastened.

If you and/or your passenger release the seat belt during driving, the seat belt telltale  starts flashing and the warning chime sounds as described before.

If the driver's or the passenger's seat belt remains unfastened after 60 seconds, the warning chime stops sounding, the seat belt telltale  stops flashing but continues to be illuminated.

After a vehicle standstill, the warning chime is reactivated and the seat belt telltale  is flashing again if the vehicle speed once exceeds 15 mph (25 km/h).

The seat belt telltale  will only go out if both the driver's and the passenger's seat belt (with the passenger seat occupied) are fastened, or the vehicle is standing still and a door is opened.

For more information, see "Practical hints" (▷ page 296).

Emergency Tensioning Device (ETD), seat belt force limiter

The seat belts are equipped with ETDs and seat belt force limiters.

The ETD is designed to activate in the following cases:

- in frontal or rear-end impacts exceeding the system's preset deployment threshold
- if the restraint systems are operational and functioning correctly, see **SRS** indicator lamp (▷ page 45)
- in certain vehicle rollovers if the system determines an additional degree of protection

The ETDs will only activate if the seat belts are fastened (latch plate properly inserted into buckle).

In an impact, ETDs remove slack from the seat belts in such a way that the seat belts fit more snugly against the body. Seat belt force limiters, when activated, are employed to help reduce the peak force exerted by the seat belts on occupants during a crash.

- **i** ETDs do not correct an incorrect seat position or incorrectly worn seat belts. ETDs do not pull occupants back toward the backrest.

Warning!

An ETD that was activated must be replaced.

For your safety, when disposing of the ETD always follow our safety instructions. These are available at any authorized Mercedes-Benz Center.

Automatic comfort-fit feature seat belt

The automatic comfort-fit feature reduces the retracting force of the seat belts when they are in normal use.

Occupant safety

Correct driver seat adjustment

⚠ Warning!

In order to avoid possible loss of vehicle control all seat, head restraint, steering wheel, and rear view mirror adjustments, as well as fastening of seat belts, must be done before the vehicle is put into motion.



① Steering wheel

② Seat belt

③ Seat

- ▶ Properly position seat ③ (▷ page 90) and head restraint (▷ page 90).

⚠ Observe Safety notes, see page 89.

Observe the following points:

- Always be in a properly seated position.
- The position should be as far rearward from the front air bag in steering wheel ① as possible, while still permitting proper operation of vehicle controls.
- Adjust seat ③ to a comfortable seating position that still allows you to reach the accelerator/brake pedal safely.
- Seat ③ must be adjusted so that you can correctly fasten and position your seat belt ②.
- The seat backrest must be in a position that is as nearly upright as possible.
- Adjust the seat cushion so that the front edge of the seat cushion lightly supports your legs.
- Adjust the head restraint so that it is as close to the head as possible and the cen-

ter of the head restraint supports the back of the head at eye level.

- Never place hands under seat ③ or near any moving parts while seat ③ is being adjusted.
- ▶ Properly position steering wheel ① (▷ page 95).

⚠ Observe Safety notes, see page 95.

Make sure:

- You can reach steering wheel ① with your arms slightly bent at the elbows.
- You can move your legs freely.
- All displays (including malfunction and indicator lamps) on the instrument cluster are clearly visible.
- ▶ Correctly fasten and position your seat belt ② (▷ page 55).

⚠ Observe Safety notes, see page 53.

Make sure:

- Seat belt ② is always fitted snugly.
- Adjust seat belt ② so that the shoulder section is located as close as possible to the middle of the shoulder.
- Place the lap portion of seat belt ② as low as possible on your hips.

Roll bar

⚠ Warning!

This vehicle is a two occupant vehicle. The rear storage area is not equipped to properly seat or restrain occupants and therefore is not permitted for use by any persons.

Make sure that the roll bar's path of motion is clear and no persons are injured by the moving roll bar. Raising or lowering of the roll bar could injure someone in its proximity.

For your own safety, we recommend to drive with the roll bar raised if the outside temperature is below +5°F (-15°C).

! If the outside temperature falls below +5°F (-15°C), the roll bar must be raised manually using the buttons provided to avoid damaging the hydraulics.

The roll bar raises automatically in an accident or in a critical driving situation.

i When the roll bar is raised automatically, you will hear a ratcheting sound.

You can also raise and lower the roll bar manually using the buttons provided.

The buttons for the roll bar are on the center console under the retractable hardtop switch.

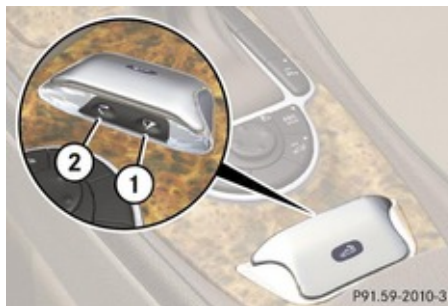

- ① Raise roll bar
- ② Lower roll bar

The roll bar can be moved manually when the ignition is switched on.

⚠ Warning!

If the yellow roll bar warning lamp  in the instrument cluster does not go out after starting the engine, or if it comes on while driving, the roll bar system is not operating properly and may not activate in an accident. At the same time, the message **Raise Roll-over Bar** appears in the multifunction display. In this case, raise the roll bar manually before continuing to drive.

For safety reasons, drive only with the roll bar raised until the malfunction is repaired. Have your vehicle checked at an authorized Mercedes-Benz Center.

- ▶ **Raising:** Lift the switch for the retractable hardtop.
- ▶ Press and hold button ① until the roll bar is raised.
- ▶ **Lowering:** Lift the switch for the retractable hardtop.

If the roll bar was raised manually:

- ▶ Press and hold button ② until the roll bar is lowered.

If the roll bar was raised automatically:

Occupant safety

- ▶ Press and hold button ① until you hear the roll bar lock into place.
- ▶ Press and hold button ② until the roll bar is lowered.
- ❗ If you have raised the roll bar manually using the button, the roll bar will automatically be lowered and then raised again when you close and open the retractable hardtop.

Children in the vehicle

Safety notes

If an infant or child is traveling with you in the vehicle:

- ▶ Secure the child using an infant or child restraint appropriate to the age and size of the child.
- ▶ Make sure the infant or child is properly secured at all times while the vehicle is in motion.

Warning!

When leaving the vehicle, always remove the SmartKey from the starter switch. Always take the SmartKey with you and lock the vehicle. Do not leave children unattended in the vehicle, even if they are secured in a child restraint system, or with access to an unlocked vehicle. A child's unsupervised access to a vehicle could result in an accident and or serious personal injury. The children could

- injure themselves on parts of the vehicle
- be seriously or fatally injured through excessive exposure to extreme heat or cold
- injure themselves or cause an accident with vehicle equipment that can be operated even if the SmartKey is removed from the starter switch or removed from the vehicle, such as seat adjustment, steering wheel adjustment, or the memory function.

If children open a door, they could injure other persons or get out of the vehicle and injure themselves or be injured by following traffic.

Do not expose the child restraint system to direct sunlight. The child restraint system's metal parts, for example, could become very hot, and the child could be burned on these parts.

Warning!

Do not carry heavy or hard objects in the passenger compartment unless they are firmly secured in place.

Unsecured or improperly positioned cargo increases a child's risk of injury in the event of:

- strong braking maneuvers
- sudden changes of direction
- an accident

For more information on loading, please refer to the "Storage compartments" (▷ page 181) chapter.

Infant and child restraint systems

 **Observe Safety notes, see page 60.**

We recommend all infants and children be properly restrained at all times while the vehicle is in motion.

Occupant safety

The passenger lap-shoulder belt has a special seat belt retractor for secure fastening of child restraints.

To fasten a child restraint, follow child restraint instructions for mounting. Then pull the shoulder belt out completely and let it retract. During seat belt retraction, a ratcheting sound can be heard to indicate that the special seat belt retractor is activated. The seat belt is now locked. Push down on child restraint to take up any slack.

To deactivate, release the seat belt buckle and let the seat belt retract completely. The seat belt can again be used in the usual manner.

 **Warning!**

Never release the seat belt buckle while the vehicle is in motion, since the special seat belt retractor will be deactivated.

The use of infant or child restraints is required by law in all 50 states, the District of Columbia, the U.S. territories and all Canadian provinces.

Infants and small children should be seated in an appropriate infant or child restraint system, which is properly secured by a lap-shoulder belt in accordance with the manufacturer's instructions for the child restraint,

that complies with U.S. Federal Motor Vehicle Safety Standards 213 and 225 and Canadian Motor Vehicle Safety Standards 213 and 210.2.

A statement by the child restraint manufacturer of compliance with these standards can be found on the instruction label on the restraint and in the instruction manual provided with the restraint.

When using any infant restraint, toddler restraint, or booster seat, make sure to carefully read and follow all manufacturer's instructions for installation and use.

Please read and observe warning labels affixed to the inside of the vehicle and to infant or child restraints.

 **Warning!**



Children 12 years old and under must be seated and properly secured in an appropriate infant restraint, toddler restraint, or booster seat recommended for the size and weight of the child.

The infant or child restraint must be properly secured with the vehicle's seat belt fully in accordance with the child seat manufacturer's instructions.

Occupants, especially children, should always sit as upright as possible, wear the



seat belt properly and use an appropriately sized infant restraint, toddler restraint, or booster seat recommended for the size and weight of the child.

Children can be killed or seriously injured by an inflating air bag. Note the following important information:

- Your vehicle is equipped with air bag technology designed to deactivate the passenger front air bag in your vehicle when the system senses the weight of a typical 12-month-old child or less along with the weight of a standard appropriate child restraint on the passenger seat.
- A child in a rear-facing child restraint on the passenger seat will be seriously injured or even killed if the passenger front air bag inflates in a collision which could occur under some circumstances, even with the air bag technology installed in your vehicle.
- If you install a rear-facing child restraint on the passenger seat, make sure the  indicator lamp is illuminated, indicating that the passenger front air bag is deactivated. Should the  indicator lamp not illuminate or go out while the restraint is installed,



Panic alarm

please check installation. Periodically check the  indicator lamp while driving to make sure the  indicator lamp is illuminated. If the  indicator lamp goes out or remains out, do not transport a child on the passenger seat until the system has been repaired.

A child in a rear-facing child restraint on the passenger seat will be seriously injured or even killed if the passenger front air bag inflates.

- If you place a child in a forward-facing child restraint on the passenger seat, move the seat as far back as possible, use the proper child restraint recommended for the age, size and weight of the child, and secure child restraint with the vehicle's seat belt according to the child seat manufacturer's instructions. For children larger than the typical 12-month-old child, the passenger front air bag may or may not be activated.

Warning!

Infants and small children should never share a seat belt with another occupant.

During an accident, they could be crushed between the occupant and seat belt.

A child's risk of serious or fatal injuries is significantly increased if the child restraints are not properly secured in the vehicle and/or the child is not properly secured in the child restraint.

Children too big for a toddler restraint must ride in seats using regular seat belts. Position shoulder belt across chest and shoulder, not face or neck. A booster seat may be necessary to achieve proper seat belt positioning for children over 41 lbs until they reach a height where a lap/shoulder belt fits properly without a booster.

When the child restraint is not in use, remove it from the vehicle or secure it with the seat belt to prevent the child restraint from becoming a projectile in the event of an accident.

Panic alarm



① **PANIC** button

i USA only:

This device complies with Part 15 of the FCC Rules. Operation is subject to the following two conditions:

1. This device may not cause harmful interference, and
2. this device must accept any interference received, including interference that may cause undesired operation.

Any unauthorized modification to this device could void the user's authority to operate the equipment.

Driving safety systems

i Canada only:

This device complies with RSS-210 of Industry Canada. Operation is subject to the following two conditions:

1. This device may not cause interference, and
2. this device must accept any interference received, including interference that may cause undesired operation of the device.

Any unauthorized modification to this device could void the user's authority to operate the equipment.

- ▶ **Activating:** Press and hold button ① for at least 1 second.

An audible alarm and flashing exterior lamps will operate briefly.

- ▶ **Deactivating:** Press button ① again.

or

- ▶ Insert the SmartKey in the starter switch.

or

- ▶ Press the KEYLESS-GO start/stop button.

The SmartKey with KEYLESS-GO must be inside the vehicle.

Driving safety systems

Introduction

This section contains information about the following driving safety systems:

- ABS (Antilock Brake System)
- BAS (Brake Assist System)
- ESP® (Electronic Stability Program)
- Electro-hydraulic brake system

- i** In winter operation, the maximum effectiveness of most of the driving systems described in this section is only achieved with winter tires, or snow chains as required.

Safety notes

 **Warning!**

The following factors increase the risk of accidents:

- Excessive speed, especially in turns
- Wet and slippery road surfaces
- Following another vehicle too closely

The driving safety systems described in this section cannot reduce these risks or pre-

vent the natural laws of physics from acting on the vehicle. They cannot increase braking or steering efficiency beyond that afforded by the condition of the vehicle brakes and tires or the traction afforded.

Only a safe, attentive, and skillful driver can prevent accidents.

The capabilities of a vehicle equipped with the driving safety systems described in this section must never be exploited in a reckless or dangerous manner which could jeopardize the user's safety or the safety of others.

Always adjust your driving style to the prevailing road and weather conditions and keep a safe distance to other road users and objects on the street.

If a driving system malfunctions, other driving safety systems may also switch off. Observe indicator and warning lamps that may come on as well as messages in the multifunction display that may appear.

Driving safety systems

ABS

 **Observe Safety notes, see page 63.**

Warning!

Do not pump the brake pedal. Use firm, steady brake pedal pressure instead. Pumping the brake pedal defeats the purpose of the ABS and significantly reduces braking effectiveness.

The Antilock Brake System (ABS) regulates the brake pressure so that the wheels do not lock during braking. This allows you to maintain the ability to steer your vehicle.

The ABS is functional above a speed of approximately 5 mph (8 km/h) independent of road surface conditions.

On slippery road surfaces, the ABS will respond even to light brake pressure.

The  indicator lamp in the instrument cluster comes on when you switch on the ignition. It goes out when the engine is running.

Braking

If the ABS activates during braking, the ABS/ESP[®] warning lamp  in the instrument cluster flashes. Because of the electro-

hydraulic brake system, you will not feel any pulsation in the brake pedal.

- ▶ Keep firm and steady pressure on the brake pedal.

Continuous, steady brake pedal pressure yields the advantages provided by the ABS, namely braking power and the ability to steer the vehicle.

The ABS/ESP[®] warning lamp  flashes whenever the ABS is activated. It can be an indication for hazardous road conditions and functions as a reminder to take extra care while driving.

Emergency brake maneuver

- ▶ Keep continuous full pressure on the brake pedal.

Warning!

If the ABS malfunctions, other driving safety systems such as the BAS or the ESP[®] are also switched off. Observe indicator and warning lamps that may come on as well as messages in the multifunction display that may appear.

If the ABS malfunctions, the wheels may lock during hard braking, reducing steering

capability and extending the braking distance.

For more information, see “What to do if ...?” (▷ page 293).

BAS

 **Observe Safety notes, see page 63.**

The Brake Assist System (BAS) operates in emergency situations. If you apply the brakes very quickly, the BAS automatically provides full brake boost, thereby potentially reducing the braking distance.

- ▶ Apply continuous full braking pressure until the emergency braking situation is over. The ABS will prevent the wheels from locking.

When you release the brake pedal, the brakes function again as normal. The BAS is then deactivated.

Warning!

If the BAS malfunctions, the brake system still functions, but without the additional brake boost available that the BAS would normally provide in an emergency braking

Driving safety systems

maneuver. Therefore, the braking distance may increase.

ESP®

 **Observe Safety notes, see page 63.**

The Electronic Stability Program (ESP®) is operational as soon as the engine is running and monitors the vehicle's traction (force of adhesive friction between the tires and the road surface) and handling.

The ESP® recognizes when a wheel is spinning or if the vehicle starts to skid. By applying brakes to the appropriate wheel and by limiting the engine output, the ESP® works to stabilize the vehicle. The ESP® is especially useful while driving off and on wet or slippery road surfaces. The ESP® also stabilizes the vehicle during braking and steering maneuvers.

The ABS/ESP® warning lamp  in the instrument cluster comes on when you switch on the ignition. It goes out when the engine is running.

The ABS/ESP® warning lamp  in the instrument cluster flashes when the ESP® is engaged.

 **Warning!**

Never switch off the ESP® when you see the ABS/ESP® warning lamp  flashing in the instrument cluster. In this case proceed as follows:

- When driving off, apply as little throttle as possible.
- While driving, ease up on the accelerator pedal.
- Adapt your speed and driving style to the prevailing road conditions.

Failure to observe these guidelines could cause the vehicle to skid. The ESP® cannot prevent accidents resulting from excessive speed.

-  Because the ESP® operates automatically, the engine and ignition must be shut off (SmartKey in starter switch position **0** or **1** or KEYLESS-GO start/stop button in position **0** or **1**) when the parking brake is being tested on a brake test dynamometer or when the vehicle is being towed with the front axle raised.

Active braking action through the ESP® may otherwise seriously damage the brake system which is not covered by the Mercedes-Benz Limited Warranty.

-  The ESP® will only function properly if you use wheels of the recommended tire size as specified in the “Technical data” section of this Operator’s Manual.

-  The DISTRONIC system and cruise control switch off automatically when the ESP® engages.

For more information, see the “Practical hints” section (▷ page 256) and (▷ page 296).

Electronic Traction System (ETS)

 **Observe Safety notes, see page 63.**

The ETS (Electronic Traction System) is a component of the ESP®. The ETS improves the vehicle's ability to utilize available traction, especially under slippery road conditions by applying the brakes to a spinning wheel.

When you switch off the ESP®, the ETS is still enabled.

Driving safety systems

Switching the ESP® off or on (except SL 63 AMG)

Warning!

The ESP® should not be switched off during normal driving other than in the circumstances described below. Disabling the system will reduce vehicle stability in driving maneuvers.

Do not switch off the ESP® when a spare wheel is mounted.

To improve the vehicle's traction, switch off the ESP® in driving situations in which it would be advantageous to have the drive wheels spin and thus cut into surfaces for better grip such as:

- when driving with snow chains
- in deep snow
- in sand or gravel

Warning!

Switch on the ESP® immediately if the aforementioned circumstances do not apply anymore. Otherwise the ESP® will not stabilize the vehicle when it is starting to skid or a wheel is spinning.

When you switch off the ESP®

- the ESP® will not stabilize the vehicle
- the engine output is not limited, which allows the drive wheels to spin and thus cut into surfaces for better grip
- the ETS will still apply the brakes to a spinning wheel
- the ESP® continues to operate when you are braking
- you cannot activate the cruise control or the DISTRONIC system
- the cruise control or the DISTRONIC system switch off if activated

i When the ESP® is switched off and one or more drive wheels are spinning, the ABS/ESP® warning lamp  in the instrument cluster flashes. However, the ESP® will then not stabilize the vehicle.



① ESP® switch

► **Switching off:** With the engine running, press ESP® switch ① until the ABS/ESP® warning lamp  in the instrument cluster comes on.

The ESP® is switched off.



Warning!

When the ABS/ESP® warning lamp  is illuminated continuously, the ESP® is switched off or is not operational due to a malfunction. Vehicle stability in standard driving maneuvers is reduced.

Adapt your speed and driving to the prevailing road conditions and to the non-operating status of the ESP®.

Driving safety systems

! Avoid spinning of a drive wheel for an extended period with the ESP® switched off. This may cause serious damage to the drivetrain which is not covered by the Mercedes-Benz Limited Warranty.

► **Switching on:** Press ESP® switch  until the ABS/ESP® warning lamp  in the instrument cluster goes out.

You are now again in normal driving mode with the ESP® switched on.

SL 63 AMG

Switching ESP® SPORT on or off

 Warning!

ESP® SPORT should not be switched on during normal driving.

Switching ESP® SPORT on will result in the following:

- no restriction to engine torque
- system supported traction control is limited

ESP® SPORT is designed for driving on closed tracks when the vehicle's natural oversteer and understeer characteristics are desired and requires a highly skilled and

experienced driver able to handle these critical driving situations.

You could lose control of your vehicle and cause an accident.

Please be aware of these limits when you switch on ESP® SPORT.

Do not switch on ESP® SPORT when a spare wheel is mounted.

To improve the vehicle's traction, switch on ESP® SPORT in driving situations in which it would be advantageous to have the drive wheels spin and thus cut into surfaces for better grip such as:

- when driving with snow chains
- in deep snow
- in sand or gravel

 Warning!

Switch off ESP® SPORT and switch on the ESP® immediately if the aforementioned circumstances do not apply anymore. Otherwise ESP® SPORT will only stabilize the vehicle to a limited extent when it is starting to skid or a wheel is spinning.

When you switch on ESP® SPORT



- the ESP® stabilizes the vehicle only to a limited extent
- the engine output is limited, but only to the extent that allows the drive wheels to spin and thus cut into surfaces for better grip
- the ETS will still apply the brakes to a spinning wheel
- the ESP® continues to operate when you are braking hard
- you cannot activate the cruise control or the DISTRONIC system
- the cruise control or the DISTRONIC system switch off if activated

i When ESP® SPORT is switched on and one or more drive wheels are spinning, the ABS/ESP® warning lamp  in the instrument cluster flashes. However, the ESP® will then stabilize the vehicle only to a limited extent.

Driving safety systems



① ESP® SPORT switch

- ▶ **Switching on:** With the engine running, press ESP® SPORT switch ① briefly. The ABS/ESP® warning lamp  in the instrument cluster comes on. The message ESP-SPORT appears in the multifunction display.
- ▶ **Switching off:** With the engine running, press ESP® SPORT switch ① briefly. The ABS/ESP® warning lamp  in the instrument cluster goes out. The message ESP-ON appears in the multifunction display.

ESP® SPORT switches off automatically when you turn off the engine. When starting the engine, the ESP® is activated automatically.

Switching the ESP® off or on

Warning!

The ESP® should not be switched off during normal driving.

Disabling of the system will result in the following:

- no restriction to engine torque
- loss of system supported traction control

“ESP® OFF” is designed for driving on closed tracks when the vehicle’s natural oversteer and understeer characteristics are desired and requires a highly skilled and experienced driver able to handle these critical driving situations.

You could lose control of your vehicle and cause an accident.

Please be aware of these limits when you switch off the ESP®.

Do not switch off the ESP® when a spare wheel is mounted.

To improve the vehicle’s traction, switch off the ESP® in driving situations in which it would be advantageous to have the drive wheels spin and thus cut into surfaces for better grip such as:

- when driving with snow chains
- in deep snow
- in sand or gravel

Warning!

Switch on the ESP® immediately if the aforementioned circumstances do not apply anymore. Otherwise the ESP® will not stabilize the vehicle when it is starting to skid or a wheel is spinning.

When you switch off the ESP®

- the ESP® will not stabilize the vehicle
- the engine output is not limited, which allows the drive wheels to spin and thus cut into surfaces for better grip
- the ETS will still apply the brakes to a spinning wheel
- the ESP® continues to operate when you are braking hard

Driving safety systems

- you cannot activate the cruise control or the DISTRONIC system
- the cruise control or the DISTRONIC system switch off if activated

i When the ESP® is switched off and one or more drive wheels are spinning, the ABS/ESP® warning lamp  in the instrument cluster does not flash. The ESP® will then not stabilize the vehicle.





① ESP® switch

► **Switching off:** With the engine running, press ESP® switch ① until the ABS/ESP® warning lamp  and the ESP OFF warn-

ing lamp  in the instrument cluster come on.

The message ESP-OFF appears in the multifunction display.



Warning!

When the ABS/ESP® warning lamp  and the ESP OFF warning lamp  are illuminated continuously, the ESP® is switched off. Vehicle stability in standard driving maneuvers is reduced.

Adapt your speed and driving to the prevailing road conditions and to the non-operating status of the ESP®.

! Avoid spinning of a drive wheel for an extended period with the ESP® switched off. This may cause serious damage to the drivetrain which is not covered by the Mercedes-Benz Limited Warranty.

► **Switching on:** With the engine running, press ESP® switch ① briefly.

The ABS/ESP® warning lamp  and the ESP OFF warning lamp  in the instrument cluster go out. The message ESP-ON appears in the multifunction display.

Electro-hydraulic brake system

The electro-hydraulic brake system combines a hydraulic brake circuit with electronically controlled brake servo assistance. You have increased braking safety and improved braking comfort.

Warning!

Never ignore a brake malfunction indicated in the speedometer display, for example by the **BRAKE** (USA only) or  (Canada only) indicator lamp. Refer to the “Practical hints” section. Also read and observe the messages in the instrument cluster multifunction display.

For information on warning and indicator lamps, see the “Practical hints” section (▷ page 293). For information on the messages that may appear in the multifunction display, see the “Practical hints” section (▷ page 269).

Warning!

The electro-hydraulic brake system requires electrical power to operate.

A malfunction in the vehicle’s power supply or electrical system may impair brake system operation and switch it into its emergency operation mode. In such a case, the



Driving safety systems

red brake warning lamp comes on and warning messages appear in the multifunction display while driving. To brake, the driver must then apply significantly greater brake pedal pressure and depress the pedal much further to obtain the expected braking effect. If necessary, apply full pressure to the brake pedal. Brakes are only applied to the front wheels. Stopping distance is increased!

If there is a malfunction in the electro-hydraulic brake system, we recommend that the vehicle be transported with all wheels off the ground using flatbed or appropriate wheel lift/dolly equipment. A tow bar must be used if circumstances do not permit the use of the recommended towing methods and the vehicle requires towing with all four wheels on the ground. Towing the vehicle with all four wheels on the ground is only permissible for distances up to 30 miles (50 km) and at a speed not to exceed 30 mph (50 km/h). For more information, see the “Towing the vehicle” section in this Operator’s Manual.

The electro-hydraulic brake system is automatically activated when you

- unlock the vehicle with the SmartKey or with KEYLESS-GO
- open the driver’s or passenger door
- turn the SmartKey in the starter switch to position **1**
- press the start/stop button on the gear selector lever once (vehicles with KEYLESS-GO)
- depress the brake pedal
- release the parking brake

If the electro-hydraulic brake system is activated as the brake pedal is first depressed, you may feel a reduced pedal resistance and longer pedal travel than normal. When releasing the pedal, you may also feel the brake pedal pulsate and you may hear a sound which is caused by the activation of the electro-hydraulic brake system pump. This is normal and not an indication of a malfunction. Pedal travel returns to normal when you release the brake pedal and the sound soon ceases.

If you experience the above while driving and the red brake warning lamp illuminates and/or warning messages appear in the mul-

tifunction display, the brake system is malfunctioning. Follow the instructions of the warning message(s) and have the brake system checked immediately.

Warning!

Have brake pad replacement and other work on the electro-hydraulic brake system carried out by qualified technicians only. Contact an authorized Mercedes-Benz Center for further information.

The electro-hydraulic brake system must be deactivated prior to working on the system. High pressure is intermittently built up in the system as part of its automatic self-test.

In addition, the system is automatically activated when the vehicle is unlocked by remote control, when the driver or passenger door is opened, when the SmartKey in the starter switch is turned to position **1** or the KEYLESS-GO start/stop button is pressed once, when the brake pedal is depressed or when the parking brake is released. Failure to deactivate the system prior to maintenance will cause brake pistons to extend and brake fluid to leak, which may result in injuries (contusions and acid burns). Extended brake pistons may also cause injury.

Anti-theft systems

The electro-hydraulic brake system switches off automatically

- approximately 2 minutes after you turned the SmartKey in the starter switch to position **0** or removed the SmartKey
- approximately 2 minutes after you pressed the KEYLESS-GO start/stop button to turn off the engine or power supply and opened the driver's door (with driver's door open, the starter switch is set to position **0**, same as SmartKey removed from starter switch)
- approximately 20 seconds after you locked the vehicle from outside

For more information on your vehicle's brakes, see the "Driving instructions" section (▷ page 237).

Anti-theft systems

Immobilizer

The immobilizer prevents unauthorized persons from starting your vehicle.

When leaving the vehicle, always take the SmartKey with you and lock the vehicle. The engine can be started by anyone with a valid SmartKey that is left inside the vehicle.

Activating

- ▶ **With the SmartKey:** Remove the SmartKey from the starter switch.
- ▶ **With KEYLESS-GO:** Turn off the engine and open the driver's door.

Deactivating

- ▶ Switch on the ignition.

1 Starting the engine will also deactivate the immobilizer.

In the event that the engine cannot be started (yet the vehicle's battery is charged), the system is not operational. Contact an authorized Mercedes-Benz Center or call 1-800-FOR-MERCEdes (in the USA), or 1-800-387-0100 (in Canada).

Anti-theft alarm system

Once the alarm system has been armed, a visual and audible alarm is triggered when someone opens:

- a door
- the trunk
- the hood
- a storage compartment in the rear
- the glove box
- the storage compartment under the armrest

The alarm will stay on even if the activating element (a door, for example) is immediately closed.

The alarm system will also be triggered when

- the vehicle is raised
- the vehicle is opened with the mechanical key
- a door is opened from the inside
- the trunk is opened with the emergency release button

To cancel the alarm after it has been triggered, see "Canceling the alarm" (▷ page 73).



Anti-theft systems

- i** If the alarm stays on for more than 30 seconds, a call to the Response Center is initiated automatically by the Tele Aid system provided that you have subscribed to the Tele Aid service and that it has been activated properly, and that the necessary mobile phone, power supply and GPS coverage are available.



① Indicator lamp

- ▶ **Arming:** Lock the vehicle with the SmartKey or with KEYLESS-GO.
The turn signal lamps flash three times and an acoustic warning sounds three times to indicate that the vehicle is locked. Indicator

lamp ① flashes to indicate that the alarm system is armed.

- i** If the turn signal lamps do not flash three times and the acoustic warning does not sound three times, a door or the trunk may not be properly closed.
Close the respective element and lock the vehicle again.

- ▶ **Disarming:** Unlock the vehicle with the SmartKey or with KEYLESS-GO.

The turn signal lamps flash once and an acoustic warning sounds once to indicate that the alarm system is disarmed.

- i** The vehicle will lock and the alarm system will rearm automatically again after approximately 40 seconds unless you open a door or the trunk.

Tow-away alarm

Once the tow-away alarm is armed, a visual and audible alarm will be triggered when someone attempts to raise the vehicle.

To cancel the alarm after it has been triggered, see “Canceling the alarm” (▷ page 73).

- i** If the alarm stays on for more than 30 seconds, a call to the Response Center is initiated automatically by the Tele Aid system provided that you have subscribed to the Tele Aid service and that it has been activated properly, and that the necessary mobile phone, power supply and GPS coverage are available.

- ▶ **Arming:** Lock the vehicle with the SmartKey or with KEYLESS-GO.

The tow-away alarm is armed automatically after about 30 seconds.

- ▶ **Disarming:** Unlock the vehicle with the SmartKey or with KEYLESS-GO.

The tow-away alarm remains disarmed until you lock the vehicle again.

Disabling tow-away alarm

To prevent triggering the tow-away alarm, disable the tow-away alarm feature before towing the vehicle, or when parking on a surface subject to movement, such as a ferry or auto train.

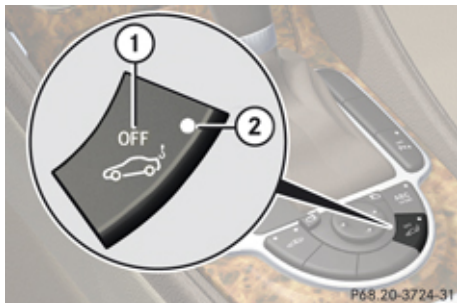

① Tow-away alarm off switch

② Indicator lamp

- ▶ Switch off the ignition.
- ▶ Remove the SmartKey from the starter switch.



i You cannot disable the tow-away alarm feature with the ignition switched on.

- ▶ Press switch ①.
Indicator lamp ② comes on briefly.
- ▶ Exit and lock the vehicle.

The tow-away alarm remains disabled until you lock the vehicle again.

Canceling the alarm

To cancel the alarm, do one of the following:

- ▶ Insert the SmartKey in the starter switch.
- ▶ Press the  or  button on the SmartKey.

In vehicles with KEYLESS-GO:

- ▶ Grasp an outside door handle.
The SmartKey must be within 3 ft (1 m) of the vehicle.
- ▶ Press the KEYLESS-GO start/stop button.
The SmartKey must be inside the vehicle.

Vehicle equipment	76	Driving and parking	109
Locking and unlocking	76	Automatic transmission	115
Starter switch positions	87	Instrument cluster	124
Seats	89	Control system	126
Multifunction steering wheel	95	Driving systems	144
Mirrors	96	Climate control system	163
Memory function	97	Rear window defroster	173
Lighting	98	Retractable hardtop	173
Wipers	105	Loading and storing	180
Power windows	107	Useful features	185



Locking and unlocking

Vehicle equipment

i This Operator's Manual describes all features, standard or optional, potentially available for your vehicle at the time of purchase. Please be aware that your vehicle might not be equipped with all features described in this manual.

Locking and unlocking

Notes

⚠ Observe Safety notes, see page 60.

When unlocking or locking the vehicle with the SmartKey an acoustic signal sounds. The acoustic signal is activated at the factory. If you wish to deactivate the feature, or adjust its signal volume, contact an authorized Mercedes-Benz Center.

When unlocking the vehicle, all turn signal lamps flash once, an acoustic signal sounds once, the locking knobs in the doors move up, and the anti-theft alarm system is disarmed.

When locking the vehicle, all turn signal lamps flash three times, an acoustic signal sounds three times, the locking knobs in the doors move down, and the anti-theft alarm system is armed.

All doors and the trunk must be closed.

! If you cannot lock or unlock the vehicle with the SmartKey, the batteries in the SmartKey are discharged, the SmartKey is malfunctioning, or the vehicle battery is drained.

- Check the batteries in the SmartKey and replace them if necessary.
- Use the mechanical key to unlock the driver's door and the trunk.
- Use the mechanical key to lock the vehicle.
- Have the vehicle battery and the vehicle battery connections checked at an authorized Mercedes-Benz Center.

If the SmartKey is malfunctioning, contact Roadside Assistance or an authorized Mercedes-Benz Center.

SmartKey

Your vehicle comes supplied with two SmartKeys, each with remote control and a removable mechanical key.

The SmartKey locks and unlocks centrally:

- the doors
- the trunk lid
- the fuel filler flap
- the glove box
- the storage compartment under the armrest
- the rear storage compartments

Locking and unlocking



P80.35-2337-31

SmartKey

- ① Lock button
- ② Unlock button for trunk lid
- ③ Unlock button
- ④ Battery check lamp

i USA only:

This device complies with Part 15 of the FCC Rules. Operation is subject to the following two conditions:

1. This device may not cause harmful interference, and
2. this device must accept any interference received, including interference that may cause undesired operation.

Any unauthorized modification to this device could void the user's authority to operate the equipment.

i Canada only:

This device complies with RSS-210 of Industry Canada. Operation is subject to the following two conditions:

1. This device may not cause interference, and
2. this device must accept any interference received, including interference that may cause undesired operation of the device.

Any unauthorized modification to this device could void the user's authority to operate the equipment.

Factory setting

- ▶ **Global unlocking:** Press button . The vehicle will lock again automatically and rearm the anti-theft alarm system within approximately 40 seconds of unlocking if neither door nor trunk is opened.
- ▶ **Global locking:** Press button .

Selective setting

If you frequently travel alone, you may wish to reprogram the SmartKey so that pressing button only unlocks the driver's door, interior lockable storage compartments and the fuel filler flap.

- ▶ **Switching on/off:** Press and hold buttons and simultaneously for approximately 5 seconds until battery check lamp ④ (> page 77) flashes twice.

The SmartKey will then function as follows:

- ▶ **Unlocking driver's door and fuel filler flap:** Press button once.
- ▶ **Global unlocking:** Press button twice.
- ▶ **Global locking:** Press button .

Locking and unlocking

KEYLESS-GO

Vehicles equipped with KEYLESS-GO come with two SmartKeys with KEYLESS-GO, each with remote control and a removable mechanical key.

The KEYLESS-GO function is integrated into the SmartKey. On these vehicles, the validity of the SmartKey with KEYLESS-GO is checked every time you grasp an outside door handle.

If the SmartKey with KEYLESS-GO is valid, your vehicle unlocks

- the doors
- the fuel filler flap
- the trunk lid
- the glove box
- the storage compartment under the armrest
- the rear storage compartments

i USA only:

This device complies with Part 15 of the FCC Rules. Operation is subject to the following two conditions:

1. This device may not cause harmful interference, and
2. this device must accept any interference received, including interference that may cause undesired operation.

Any unauthorized modification to this device could void the user's authority to operate the equipment.

i Canada only:

This device complies with RSS-210 of Industry Canada. Operation is subject to the following two conditions:

1. This device may not cause interference, and
2. this device must accept any interference received, including interference that may cause undesired operation of the device.

Any unauthorized modification to this device could void the user's authority to operate the equipment.

Important notes on using KEYLESS-GO

- You can also use the SmartKey with KEYLESS-GO like a normal SmartKey (▷ page 76).
- You can combine KEYLESS-GO functions with normal SmartKey functions (e.g. unlocking with KEYLESS-GO and locking with button ).
- Always carry the SmartKey with KEYLESS-GO with you.
- Never store the SmartKey with KEYLESS-GO together with:
 - Electronic items such as a mobile phone or another SmartKey with KEYLESS-GO
 - Metallic objects such as coins or metal foilDoing so could impair the function of the KEYLESS-GO system.
- To lock or unlock the vehicle, the SmartKey with KEYLESS-GO must be located outside the vehicle within approximately 3 ft (1 m) of a door or the trunk.
- If the vehicle has been parked for more than 72 hours, you must pull an outside door handle in order to activate the KEYLESS-GO function.

Locking and unlocking

- If the SmartKey with KEYLESS-GO is positioned farther away from the vehicle, the system may no longer recognize the SmartKey with KEYLESS-GO. The vehicle cannot be locked or the engine started via the KEYLESS-GO system.
- If the SmartKey with KEYLESS-GO is removed from the vehicle while the engine is running (e.g. if a passenger exits the vehicle with the SmartKey with KEYLESS-GO), the message **Key Not Detected** appears in the multifunction display while driving off.
Find the SmartKey with KEYLESS-GO or change its present location immediately (e.g. place it on the passenger seat or insert it in shirt pocket).
- If you have started the engine with the KEYLESS-GO start/stop button, you can only turn it off again with this button, even if you have put the SmartKey in the starter switch in the meantime.
- This does not apply if, after starting, the automatic transmission is still in park position **P** and the SmartKey is then inserted in the starter switch. The SmartKey will then have priority over the KEYLESS-GO function and the vehicle's electrical system will operate according to the position of the

SmartKey in the starter switch, even stopping the engine.

- The vehicle could be inadvertently unlocked if the SmartKey with KEYLESS-GO is within 3 ft (1 m) of the vehicle and
 - an outside door handle is splashed with water
or
 - you attempt to clean an outside door handle
- Remember that the engine can be started by anyone with a SmartKey with KEYLESS-GO that is left inside the vehicle. If you leave the SmartKey with KEYLESS-GO behind when exiting and locking the vehicle, the message **Key Detected In Vehicle** appears in the multifunction display.

Factory setting

- ▶ **Global unlocking:** Grasp an outside door handle.

The vehicle will lock again automatically and rearm the anti-theft alarm system within approximately 40 seconds if neither door nor trunk is opened.

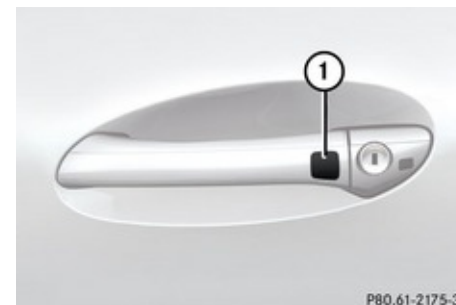



① Lock button on the outside door handle

- ▶ **Global locking:** Press lock button ① on an outside door handle.

Selective setting

If you frequently travel alone, you may wish to reprogram the SmartKey with KEYLESS-GO so when you grasp the driver's outside door handle, only the driver's door, interior lockable storage compartments and the fuel filler flap unlocks.

- ▶ **Switching on/off:** Press and hold buttons  and  simultaneously for approx-

Locking and unlocking

imately 5 seconds until battery check lamp ④ (▷ page 77) flashes twice.

The SmartKey with KEYLESS-GO will then function as follows:

- ▶ **Unlocking driver's door and fuel filler flap:** Grasp the driver's outside door handle.
- ▶ **Global unlocking:** Grasp the outside door handle on the passenger side.
- ▶ **Global locking:** Press lock button ① on an outside door handle.

Checking SmartKey batteries



- ▶ Press button  or .

Battery check lamp ④ (▷ page 77) comes on briefly to indicate that the SmartKey batteries are in order.

If the battery check lamp does not come on briefly during check, the SmartKey batteries are discharged.

- ▶ Replace the batteries (▷ page 309).

i You can obtain the required batteries at any authorized Mercedes-Benz Center.

- 1** If the batteries are checked within signal range of the vehicle, pressing button  or  will lock or unlock the vehicle accordingly.

Loss of the SmartKey

If you lose your SmartKey or mechanical key, you should do the following:

- ▶ Have the SmartKey deactivated by an authorized Mercedes-Benz Center.
- ▶ Report the loss of the SmartKey or the mechanical key to your car insurance company immediately.
- ▶ Have the mechanical lock replaced if necessary.

Any authorized Mercedes-Benz Center will be glad to supply you with a replacement.

Opening the doors from the inside

You can open a locked door from the inside. Open door only when conditions are safe to do so.

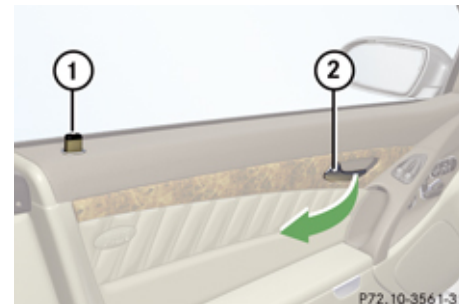

① Locking knob

② Inside door handle

If the vehicle has previously been locked with the SmartKey or with KEYLESS-GO, opening a door from the inside will trigger the anti-theft alarm system.

To cancel the alarm, see (▷ page 73).

- ▶ Pull on inside door handle ② on the respective door.

If the door was locked, locking knob ① will move up.

Opening a door causes its window to open slightly. It will fully close when the door is shut.

! A side window will not work if it is blocked with ice or if the vehicle battery is discharged. If you cannot shut a door, do not force it or you could damage the door or side window. Fix whatever is affecting the window before trying to shut the door.

Automatic central locking

The doors and the trunk lock automatically when the vehicle is set into motion.

You can open a locked door from the inside. Open door only when conditions are safe to do so.

The doors are designed to unlock automatically after an accident if the force of the impact exceeds a preset threshold.

The vehicle locks automatically when the ignition is switched on and the wheels are turning at vehicle speeds of approximately 9 mph (15 km/h) or more. You could therefore lock yourself out when the vehicle is pushed or towed or is on a test stand.

You can deactivate the automatic central locking using the control system (▷ page 140).

Locking and unlocking from the inside

! Observe Safety notes, see page 60.

You can lock or unlock the vehicle from inside using the central locking switches. This can be useful, for example, if you want to lock the vehicle before starting to drive.

The central locking switches do not lock or unlock the fuel filler flap or the interior storage compartments, such as the glove box.



- ① Central locking switch
- ② Central unlocking switch

Locking and unlocking

- ▶ **Locking:** Press central locking switch ①. If all doors are closed, the vehicle locks.
- ▶ **Unlocking:** Press central unlocking switch ②.

You can open a locked door from inside at any time. Open door only when conditions are safe to do so.

If the vehicle was previously locked with the central locking switch:

- and the SmartKey is set to factory settings, the complete vehicle is unlocked when a door is opened from the inside
- and the SmartKey is set to selective settings, only the door opened from inside is unlocked

If the vehicle was previously centrally locked with the SmartKey or with KEYLESS-GO, it will not unlock using the central unlocking switch.

Locking and unlocking

Opening the trunk

Warning!

Make sure the trunk is closed when the engine is running and while driving. Among other dangers, deadly carbon monoxide (CO) gases may enter vehicle interior resulting in unconsciousness and death.

You can open the trunk when the vehicle is stationary and the retractable hardtop is fully opened or closed.

A minimum height clearance of 6.2 ft (1.88 m) is required to open the trunk lid.

! Vehicles with trunk opening/closing system:

The trunk lid swings open upwards automatically. Always make sure there is sufficient overhead clearance.

i To facilitate trunk loading and unloading when the hardtop is retracted, you can raise the hardtop from its storage position in the trunk using the load assist feature (> page 184). You may also unhook the luggage cover.

Remember to re-secure the luggage cover after loading/unloading the trunk. Other-

wise you will not be able to lower the retractable hardtop.

Opening the trunk from the outside

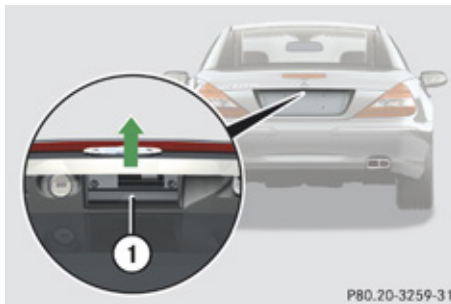

① Trunk lid handle

Vehicles without trunk opening/closing system

▶ Press button  on the SmartKey.

or

▶ Pull on handle.

In vehicles without KEYLESS-GO: The vehicle must be unlocked.

If the trunk does not open, it is still locked separately (> page 86).

Vehicles with trunk opening/closing system

▶ Press and hold button  on the SmartKey until trunk unlocks and begins to open.

or

▶ Pull on handle.

In vehicles without KEYLESS-GO: The vehicle must be unlocked.

If the trunk does not open, it is still locked separately (> page 86).

▶ **Stopping the opening procedure:** Press button  on the SmartKey or pull the trunk lid handle.

Locking and unlocking

Opening the trunk from the inside

Vehicles without trunk opening/closing system

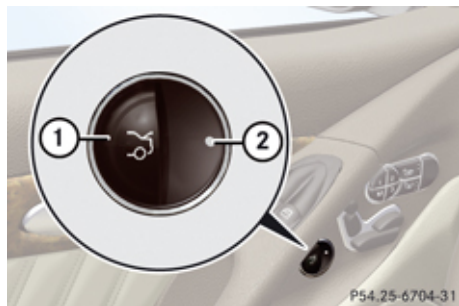

① Remote trunk opening switch

② Indicator lamp

- ▶ Pull switch ① until the trunk unlocks and opens slightly.
Indicator lamp ② comes on and remains lit until the trunk is closed.
- ▶ Lift the trunk lid.

Vehicles with trunk opening/closing system

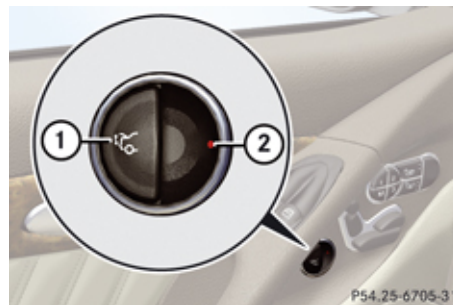

① Remote trunk opening/closing switch

② Indicator lamp

- ▶ Pull and hold switch ① until the trunk unlocks and begins to open.
Indicator lamp ② comes on and remains lit until the trunk is closed.
- ▶ Release switch ①.
- ▶ **To interrupt the opening procedure:**
Press or pull switch ①.

Closing the trunk

⚠ Warning!

Make sure the trunk is closed when the engine is running and while driving. Among other dangers, deadly carbon monoxide (CO) gases may enter vehicle interior resulting in unconsciousness and death.

⚠ Warning!

To prevent possible personal injury, always keep hands and fingers away from the trunk opening when closing the trunk lid. Be especially careful when small children are around.

⚠ Observe Safety notes, see page 60.

Do not leave the SmartKey in the open trunk. You may lock yourself out.

If the vehicle was previously centrally locked with the SmartKey or KEYLESS-GO, the trunk lid will lock automatically when closed. All turn signal lamps flash three times and an acoustic signal sounds three times to confirm locking.

Vehicles with KEYLESS-GO:

To prevent a possible inadvertent lockout, the trunk lid will open automatically if a SmartKey



Locking and unlocking

with KEYLESS-GO is recognized inside the vehicle or in the trunk.

The vehicle is only locked when the turn signal lamps flash three times and an acoustic signal sounds three times. If you are carrying a second SmartKey with KEYLESS-GO with you, you can still lock the vehicle.

- ① When the hardtop is retracted, it must be completely lowered in the trunk before the trunk can be closed (▷ page 173).

Closing the trunk from the outside manually

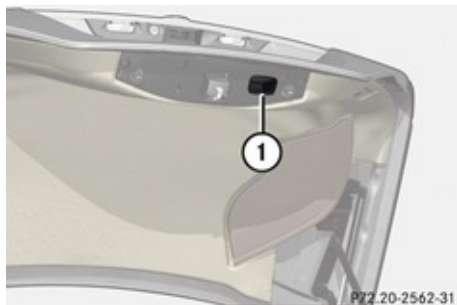

- ① Handle

- ▶ Lower trunk lid by pulling firmly on handle ①.
- ▶ Close trunk with hands placed flat on trunk lid.

The power closing assist automatically ensures that the trunk lid is pulled completely close (▷ page 87).

Closing the trunk from the inside automatically

⚠ Warning!

Maintain sight of the area around the rear of the vehicle while operating the trunk lid with the door mounted switch. Monitor the closing procedure carefully to make sure no one is in danger of being injured.

To interrupt the closing procedure, release the door mounted remote trunk opening/closing switch again.

Even with the SmartKey removed from the starter switch or the SmartKey with KEYLESS-GO removed from the vehicle, the remote trunk opening/closing switch can be operated. Therefore, do not leave children unattended in the vehicle, or with access to an unlocked vehicle. A child's unsupervised access to a vehicle could

result in an accident and/or serious personal injury.

If the trunk lid comes into contact with an object while closing (e.g. luggage that has been piled too high) in the upper motion sequence, the closing procedure is stopped and the trunk reopens slightly.

In vehicles with trunk opening/closing system you can close the trunk from the inside using the remote trunk opening/ closing switch.

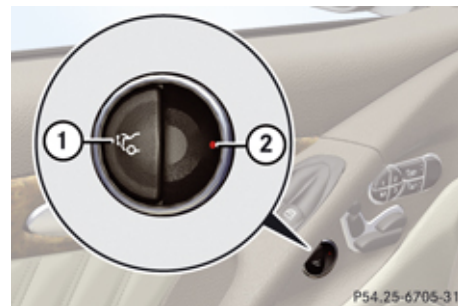

- ① Remote trunk opening/closing switch
- ② Indicator lamp

- ▶ Press and hold switch ① until the trunk is closed.

Indicator lamp ② in the switch goes out when the trunk is closed.

Locking and unlocking

To interrupt the closing procedure:

- ▶ Release switch ①.

Closing the trunk from the outside automatically

Warning!

Monitor the closing procedure carefully to make sure no one is in danger of being injured. To prevent possible personal injury, always keep hands and fingers away from the trunk opening when closing the trunk lid. Be especially careful when small children are around. To stop the closing procedure, do one of the following:

- Press button  on the SmartKey.
- Press the remote trunk opening/closing switch (on the driver's door).
- Press the trunk closing switch.
- Press the KEYLESS-GO locking/closing switch.
- Pull the trunk lid handle.

Even with the SmartKey removed from the starter switch or the SmartKey with KEYLESS-GO removed from the vehicle, the remote trunk opening/closing switch can

be operated. Therefore, do not leave children unattended in the vehicle, or with access to an unlocked vehicle. A child's unsupervised access to a vehicle could result in an accident and/or serious personal injury.

In vehicles with trunk opening/closing system you can close the trunk separately from the outside using the trunk closing switch.

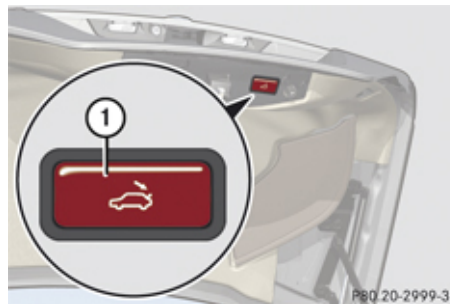

Vehicles without KEYLESS-GO

- ① Trunk closing switch

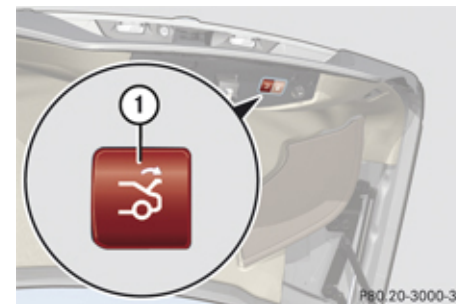

Vehicles with KEYLESS-GO

- ① Trunk closing switch

- ▶ Press switch ① briefly.

Closing the trunk and locking vehicle from outside

In vehicles with trunk opening/closing system and KEYLESS-GO, you can close the trunk and lock the vehicle simultaneously from the outside using the KEYLESS-GO locking/closing switch.

Locking and unlocking



① KEYLESS-GO locking/closing switch

- ▶ Make sure you have the SmartKey with KEYLESS-GO with you.
- ▶ Press switch ① briefly.

With all doors closed:

- The locking knobs in the doors move down.
- The trunk lid starts to close automatically.
- All turn signal lamps flash three times once the trunk has closed completely.
- An acoustic signal sounds three times once the trunk has closed completely.
- The anti-theft alarm system is armed.

Trunk lid emergency release

With the emergency release button, the trunk lid can be opened from inside the trunk.



① Emergency release button

- ▶ Briefly press emergency release button ①.
The trunk lid unlocks and opens slightly.
- ▶ Push up the trunk lid to fully open.

The emergency release button unlocks the trunk while the vehicle is standing still or in motion.

Illumination of the emergency release button:

- The button flashes for 30 minutes after opening the trunk.
- The button flashes for 60 minutes after closing the trunk.

The emergency release button does not unlock the trunk, if the vehicle battery is discharged or disconnected.

Valet locking

To deny any unauthorized person access to the trunk, e.g. when you valet park the vehicle, lock it separately with the mechanical key. Leave only the SmartKey less its mechanical key with the vehicle.

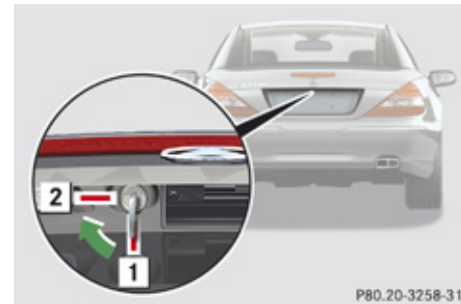

- ① Neutral position
- ② Locked

- ▶ Close the trunk.
- ▶ Remove the mechanical key from the SmartKey (▶ page 307).

Starter switch positions

- ▶ Insert the mechanical key in the trunk lid lock.
- ▶ Turn the mechanical key clockwise to position **2** and remove the mechanical key in that position to lock the trunk.

The trunk remains locked even when the vehicle is centrally unlocked.

You can only cancel the separate trunk locking mode by means of the mechanical key.

- ▶ Insert the mechanical key in the trunk lid lock.
 - ▶ Turn the mechanical key counterclockwise to neutral position **1** and remove the mechanical key in that position to unlock the trunk.
- You can now open the trunk.

Power closing assist for trunk lid

It is not necessary to slam the trunk lid closed. An electrical power-assisted mechanism draws the trunk lid closed quietly and automatically once the trunk lid has been latched. When the electrical power-assisted mechanism has stopped, the trunk can be reopened.

Warning!

To prevent possible personal injury, always keep hands and fingers away from the trunk opening when closing the trunk lid. Be especially careful when small children are around.

In case of danger, pull the inside or outside door handle, or press the trunk lid lock.

To prevent personal injury, never actuate the closing assist mechanism by tampering with the door or trunk lid latch.

Warning!

Make sure the trunk is closed when the engine is running and while driving. Among other dangers, deadly carbon monoxide (CO) gases may enter vehicle interior resulting in unconsciousness and death.

- ▶ Press the trunk lid gently into its lock.

Starter switch positions

SmartKey

Warning! Observe Safety notes, see page 60.



- 0** For removing SmartKey (gear selector lever must be in park position **P**)
- 1** Power supply for some electrical consumers, e.g. radio
- 2** Ignition (power supply for all electrical consumers) and driving position
- 3** Starting position

When you switch on the ignition, all lamps (except high-beam headlamp indicator lamp, and turn signal indicator lamps unless activated) in the instrument cluster come on. If a lamp in the instrument cluster fails to come on when the ignition is switched on, have it



Starter switch positions

checked and replaced if necessary. If a lamp in the instrument cluster remains on after starting the engine or comes on while driving, refer to “Lamps in instrument cluster” (▷ page 293).

! If the SmartKey cannot be turned in the starter switch, the vehicle battery may not be sufficiently charged.

- Check the vehicle battery and charge it if necessary.
- Get a jump start.

To prevent accelerated vehicle battery discharge or a completely discharged vehicle battery, always remove the SmartKey from the starter switch when the engine is not in operation.

KEYLESS-GO

⚠ Observe Safety notes, see page 60.

Vehicles equipped with the KEYLESS-GO feature are supplied with a SmartKey with integrated KEYLESS-GO function.

With the SmartKey with KEYLESS-GO present in the vehicle, pressing the KEYLESS-GO start/stop button

- without the brake pedal depressed corresponds to the various starter switch positions (▷ page 87)
- with the brake pedal firmly depressed will start the engine (▷ page 109)

The SmartKey with KEYLESS-GO must be located in the vehicle.

- ▶ Make sure the automatic transmission is in park position **P**.
- ▶ Do not depress the brake pedal.

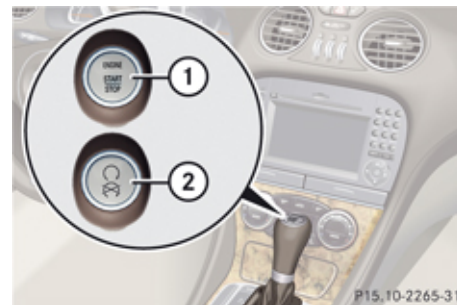

KEYLESS-GO start/stop button

- ① USA only
- ② Canada only

Position 0

Before you press the KEYLESS-GO start/stop button, the vehicle's on-board electronics have status **0** (as with SmartKey removed).

Position 1

- ▶ Press the KEYLESS-GO start/stop button once.

This supplies power for some electrical consumers, such as radio functions.

i If you now press the KEYLESS-GO start/stop button

- once more, the ignition (position **2**) is switched on
- twice more the power supply is again switched off

Ignition (or position 2)

▶ Press the KEYLESS-GO start/stop button twice.

This supplies power for all electrical consumers.

All lamps (except high-beam headlamp indicator lamp and turn signal indicator lamps unless activated) in the instrument cluster come on. If a lamp in the instrument cluster fails to come on when the ignition is switched on, have it checked and replaced if necessary. If a lamp in the instrument cluster remains on after starting the engine or comes on while driving, refer to “Lamps in instrument cluster” (▷ page 293).

i If you now press the KEYLESS-GO start/stop button once, the power supply is again switched off.

Seats

Safety notes

Warning!

In order to avoid possible loss of vehicle control all seat, head restraint, steering wheel, and rear view mirror adjustments, as well as fastening of seat belts, must be done before the vehicle is put into motion.

Warning!

Do not adjust the driver’s seat while driving. Adjusting the seat while driving could cause the driver to lose control of the vehicle.

Never ride in a moving vehicle with the seat backrest in an excessively reclined position as this can be dangerous. You could slide under the seat belt in a collision. If you slide under it, the seat belt would apply force at the abdomen or neck. That could cause serious or fatal injuries. The seat backrest and seat belts provide the best restraint when the wearer is in a position that is as upright as possible and seat belts are properly positioned on the body.

Warning!

Your seat must be adjusted so that you can correctly fasten your seat belt.

Observe the following points:

- Adjust the seat backrest until your arms are slightly angled when holding the steering wheel.
- Adjust the seat to a comfortable seating position that still allows you to reach the accelerator/brake pedal safely. The position should be as far back as possible with the driver still able to operate the controls properly.
- Adjust the head restraint so that it is as close to the head as possible and the center of the head restraint supports the back of the head at eye level.
- Never place hands under the seat or near any moving parts while a seat is being adjusted.

Failure to do so could result in an accident and/or serious personal injury.

Warning!

The power seats can be operated at any time. Therefore, do not leave children unattended in the vehicle, or with access to an

Seats

unlocked vehicle. A child's unsupervised access to a vehicle could result in an accident and/or serious personal injury.

Warning!

Children 12 years old and under must be seated and properly secured in an appropriately sized infant restraint, toddler restraint, or booster seat recommended for the size and weight of the child. For additional information, see section "Children in the vehicle".

A child's risk of serious or fatal injuries is significantly increased if the child restraints are not properly secured in the vehicle and/or the child is not properly secured in the child restraint.

Seat adjustment

 When moving the seats, make sure there are no items in the footwell or behind the seats. Otherwise, you could damage the seats.

Power seat

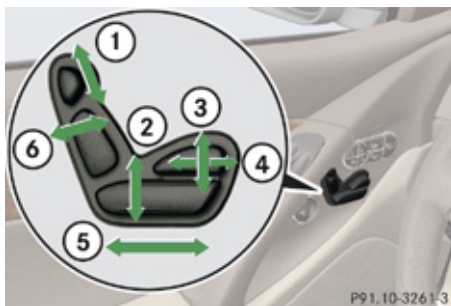

- ① Head restraint height
- ② Seat height
- ③ Seat cushion tilt
- ④ Seat cushion depth
- ⑤ Seat fore and aft adjustment
- ⑥ Seat backrest tilt

 The memory function (▷ page 97) lets you store the settings for the seat position

together with the settings for the steering wheel and the exterior rear view mirrors.

▶ **Seat fore and aft adjustment:** Press the switch forward or backward in direction of arrow ⑤.

 When moving the seat fore or aft, the head restraints may readjust automatically.

▶ **Seat height:** Press the switch up or down in direction of arrow ②.

▶ **Seat cushion tilt:** Press the switch up or down in direction of arrow ③ until your upper legs are lightly supported.

▶ **Seat cushion depth:** Press the switch forward or backward in direction of arrow ④ until your legs are supported comfortably.

▶ **Seat backrest tilt:** Press the switch forward or backward in direction of arrow ⑥.

▶ **Head restraint height:** Press the switch up or down in direction of arrow ①.

Warning!

For your protection, drive only with properly positioned head restraints.

Adjust the head restraint so that it is as close to the head as possible and the center

of the head restraint supports the back of the head at eye level. This will reduce the potential for injury to the head and neck in the event of an accident or similar situation. Do not drive the vehicle without the seat head restraints. Head restraints are intended to help reduce injuries during an accident.

Moving the seats forward and backward

You can move the seats forward and backward to facilitate loading and unloading.

⚠ Warning!

When moving the seats, make sure no one can be caught by them. Never place hands under seat or near any moving parts during a seat adjustment procedure. To stop the seat from moving when potential danger exists:

- Press the switch once more.
- Move the seat adjustment switch on the door.

! When moving the seats, make sure there are no items in the footwell or behind the

seats. Otherwise, you could damage the seats.

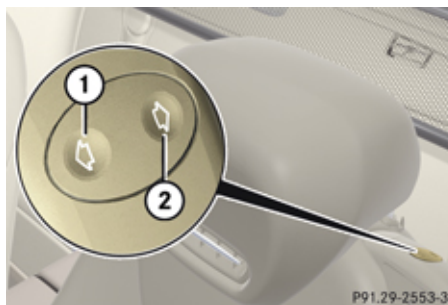

- ① Seat forward
- ② Seat backward

- ▶ **Moving the seat forward:** Press switch at ① and release. The seat moves forward automatically.
- ▶ **Moving the seat backward:** Press switch at ② and release. The seat moves backwards to its previous position automatically.

Lumbar support

You can adjust the contour of the seat's lumbar support to help enhance support to your spine.

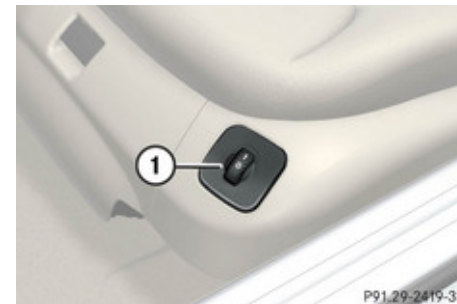

- ① Thumbwheel
- ▶ Switch on the ignition.
- ▶ Set the lumbar support between 0 and 5.

Seats

Multicontour seat

The multicontour seat backrest has inflatable air cushions built into the seat backrest to provide additional lumbar and side support. The seat backrest cushion height and curvature can be continuously varied with switches on the lower left side (driver's seat) or the lower right side (passenger side) of the seat when the ignition is switched on.



- ① Lumbar region support
- ② Shoulder region support
- ③ Side bolsters adjustment
- ④ Massage function (PULSE)

- ▶ Switch on the ignition.
- ▶ **Shoulder region support:** Press **+** or **-** on switch ②. The air cushion inflates or deflates.
- ▶ **Lumbar region support:** Press **↙** or **↘** on rocker switch ①. This selects the air cushion you wish to adjust.
- ▶ Press **+** or **-** on rocker switch ①. The air cushion inflates or deflates.
- ▶ **Side bolsters adjustment:** Press switch ③ to the right or left. The lateral support increases or decreases.

Massage function (PULSE)

You can reduce muscle tension during long trips by periodically using the massage function.

- ▶ Press button ④. The indicator lamp in the button comes on. The air cushions in the lumbar region inflate and deflate rhythmically.
- ⓘ The massage function switches off automatically after approximately 8 minutes. The indicator lamp goes out.

Seat ventilation



- ① Seat ventilation switch
- The blue indicator lamps in the switch come on to show which ventilation level you have selected.
- ⓘ The seat ventilation for the driver's seat can be activated using summer opening feature (▷ page 175).
 - ▶ Switch on the ignition.
 - ▶ **Switching on:** Press switch ①. Three blue indicator lamps in the switch come on.
 - ▶ Press switch ① repeatedly until the desired ventilation level is set.
 - ▶ **Switching off:** Press switch ① repeatedly until all indicator lamps go out.

If one or more of the indicator lamps in the seat ventilation switch ① are flashing, there is insufficient voltage available since too many electrical consumers are turned on. The seat ventilation switches off automatically.

The seat ventilation will switch back on again automatically as soon as sufficient voltage is available.

Seat heating

The seat heating will switch back on again automatically as soon as sufficient voltage is available.

Vehicles without seat ventilation



- ① Rapid heating
- ② Normal heating

The red indicator lamps in the switch come on to show which heating level you have selected.

The seat heating switches from level 2 (rapid seat heating) to level 1 (normal seat heating) after approximately 5 minutes.

The seat heating automatically switches off after approximately 30 minutes.

- ▶ Switch on the ignition.
- ▶ **Switching on seat heating:** Press lower switch position ②. A red indicator lamp in the switch comes on.
- ▶ **Switching off seat heating:** Press lower switch position ② once more.

- ▶ **Switching on rapid seat heating:** Press upper switch position ①. Both red indicator lamps in the switch come on.
- ▶ **Switching off rapid seat heating:** Press upper switch position ① once more.

If one or both of the indicator lamps in the seat heating switch are flashing, there is insufficient voltage available since too many electrical consumers are turned on. The seat heating switches off automatically.

The seat heating will switch back on again automatically as soon as sufficient voltage is available.

Vehicles with seat ventilation



- ① Seat heating switch

The red indicator lamps in the switch come on to show which heating level you have selected.

The seat heating switches from level 2 (rapid seat heating) to level 1 (normal seat heating) after approximately 8 minutes.

The seat heating automatically switches off after approximately 30 minutes.

Seats

- ▶ Switch on the ignition.
- ▶ **Switching on seat heating:** Press switch ①.
Both red indicator lamps in switch ① come on.
- ▶ **Switching off seat heating:** Press switch ① repeatedly until all red indicator lamps go out.

If one or both of the indicator lamps in the seat heating switch are flashing, there is insufficient voltage available since too many electrical consumers are turned on. The seat heating switches off automatically.

The seat heating will switch back on again automatically as soon as sufficient voltage is available.

AIRSCARF neck-level heating

The AIRSCARF neck-level heating provides the area surrounding the occupants' necks with a heated air stream flowing from openings in the head restraints.

Warning!

When switching on the AIRSCARF neck-level heating, the air streaming from the openings may be very hot. When in close proximity to the openings, you could be seriously burned. To help avoid serious personal injuries, switch the AIRSCARF to a lower heating level.



① AIRSCARF switch

- ▶ Switch on the ignition.
- ▶ **Switching on:** Press AIRSCARF switch ① for the desired side.
All three indicator lamps on respective AIRSCARF switch ① come on. After a pre-heating time of approximately 10 seconds, the blower starts.
- ▶ Press AIRSCARF switch ① repeatedly until the desired AIRSCARF heating level for the corresponding seat is reached.
- ▶ **Switching off:** Press AIRSCARF switch ① repeatedly until all indicator lamps on AIRSCARF switch ① go out.

After switching off the AIRSCARF neck-level heating, the AIRSCARF fan continues to operate for approximately 7 seconds to cool down the heater elements.

Multifunction steering wheel

Safety notes

Warning!

Do not adjust the steering wheel while driving. Adjusting the steering wheel while driving could cause the driver to lose control of the vehicle.

The electrical steering wheel adjustment feature can be operated at any time. Therefore, do not leave children unattended in the vehicle, or with access to an unlocked vehicle. A child's unsupervised access to a vehicle could result in an accident and/or serious personal injury.

Make sure

- you can reach the steering wheel with your arms slightly bent at the elbows
- you can move your legs freely
- all displays (including malfunction and indicator lamps) on the instrument cluster are clearly visible

Steering wheel adjustment

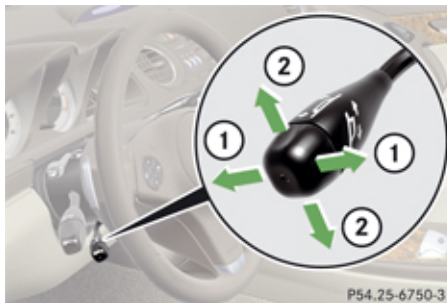

- ① Adjusting steering wheel, in or out
- ② Adjusting steering wheel, up or down

► **Adjusting steering wheel in or out:** Move stalk in direction of arrows ①.

► **Adjusting steering wheel up or down:** Move stalk in direction of arrows ②.

-  The memory function (▷ page 97) lets you store the settings for the steering wheel together with the settings for the seat position and the exterior rear view mirrors.

Multifunction steering wheel

Easy-entry/exit feature

This feature allows for easier entry into and exit from the vehicle. When entering and exiting the vehicle, the steering wheel is in its uppermost position.

The easy-entry/exit feature can be activated or deactivated in the Convenience submenu of the control system (▷ page 140).

Warning!

You must make sure no one can become trapped or injured by the moving steering wheel when the easy-entry/exit feature is activated.

To stop steering wheel movement, move steering wheel adjustment stalk or press one of the memory position buttons or memory button **M**.

Do not leave children unattended in the vehicle, or with access to an unlocked vehicle. Children could open the driver's door and unintentionally activate the easy-entry/exit feature, which could result in an accident and/or serious personal injury.

With the easy-entry/exit feature activated, the steering wheel will return to its last set position when you close the driver's door with the ignition switched on. The steering wheel will also return to its last set position when

Mirrors

you insert the SmartKey into the starter switch or press the KEYLESS-GO start/stop button once with the driver's door closed.

- i** The last set steering wheel position is stored when the ignition is switched off or the position is stored in memory (> page 98).

With the easy-entry/exit feature activated, the steering wheel tilts upwards when you remove the SmartKey from the starter switch. The steering wheel also tilts upwards when you open the driver's door with the SmartKey in starter switch position **0** or **1** or the KEYLESS-GO start/stop button in position **1**.

- i** When the current position for the steering wheel is in the uppermost tilt position, the steering wheel will no longer be able to move upward when the easy-entry/exit feature is activated.

The adjustment procedure is briefly interrupted when the engine is started.

Warning!

Let the system complete the adjustment procedure before setting the vehicle in motion. All steering wheel adjustment must be completed before setting the vehicle in motion. Driving off with the steering wheel

still adjusting could cause the driver to lose control of the vehicle.

Mirrors

Notes

Adjust the interior and exterior rear view mirrors before driving so that you have a good view of the road and traffic conditions.

Interior rear view mirror

- ▶ Adjust the interior rear view mirror manually.

For more information, see “Auto-dimming rear view mirrors” (> page 97).

Exterior rear view mirrors

Warning!

Exercise care when using the passenger-side exterior rear view mirror. The mirror surface is convex (outwardly curved surface for a wider field of view). Objects in mirror are closer than they appear. Check your interior rear view mirror or glance over your shoulder before changing lanes.

Memory function

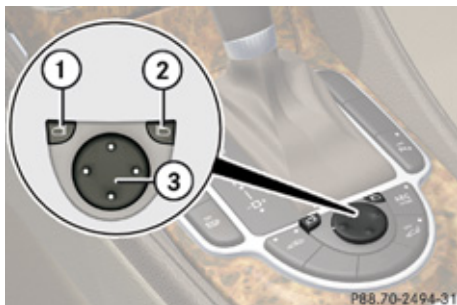

- ① Driver's side exterior rear view mirror button
- ② Passenger-side exterior rear view mirror button
- ③ Adjustment button

- ▶ Switch on the ignition.
- ▶ Press button ① for the driver's side exterior rear view mirror or button ② for the passenger-side exterior rear view mirror.
- ▶ Press adjustment button ③ up, down, left or right according to the desired setting.

! If an exterior rear view mirror was forcibly hit from the front, manually snap it back into place.

- ① At low ambient temperatures, the exterior rear view mirrors will be heated automatically.

Auto-dimming rear view mirrors

The reflection brightness of the exterior rear view mirror on the driver's side and the interior rear view mirror will respond automatically to glare when the ignition is switched on and incoming light from headlamps falls on the sensor in the interior rear view mirror.

The rear view mirrors will not react if the automatic transmission is set to reverse gear **R** or the interior lighting is switched on.

⚠ Warning!

The auto dimming function does not react if incoming light is not aimed directly at sensors in the interior rear view mirror.

The interior rear view mirror and the exterior rear view mirror on the driver's side do not react, for example, if the wind screen is installed.

Light hitting the mirror(s) at certain angles (incident light) could blind you. As a result, you may not be able to observe traffic conditions and could cause an accident.

Memory function

Notes

With the memory function you can store up to three different configurations.

Each stored position on the driver's side includes the following settings:

- Seat position and lumbar support
- Steering wheel position
- Exterior rear view mirrors' position

⚠ Warning!

Do not activate the memory function while driving. Activating the memory function while driving could cause the driver to lose control of the vehicle.

Each stored position on the passenger side includes the following settings:

- Seat position and lumbar support
- Multicontour seat: previously saved setting

Lighting



- ① Memory position button
- ② Memory button **M**

Storing positions into memory

- ▶ Adjust the seats, on the driver's side also the steering wheel and exterior rear view mirrors, to the desired positions.
- ▶ Press memory button **M**.
- ▶ Release memory button **M** and press memory position button **1**, **2** or **3** within 3 seconds.

When the settings are stored to the selected position, an acknowledgement signal sounds.

Recalling positions from memory

- ▶ Press and hold desired memory position button **1**, **2** or **3** until the seat, on the driver's side also the steering wheel and exterior rear view mirrors, have completely moved to the stored positions.
- ① Releasing the memory position button stops movement to the stored positions immediately.

Lighting

Notes

- ① If you drive in countries where vehicles drive on the other side of the road than the country where the vehicle is registered, you must have the headlamps modified for symmetrical low beams. Relevant information can be obtained at any authorized Mercedes-Benz Center.
- ① The active Bi-Xenon headlamps monitor the vehicle's steering angle and speed, then automatically shift their beams to either side to better follow the curvature of the road ahead, increasing usable illumination over conventional headlamps.

Exterior lamp switch



- 1 Standing lamps, left
- 2 Standing lamps, right
- 3 Off
Daytime running lamp mode
- 4 Automatic headlamp mode
Daytime running lamp mode
- 5 Parking lamps (also tail lamps, license plate lamps, side marker lamps and instrument panel lamps)
- 6 Low-beam headlamps or high-beam headlamps
- 7 Front fog lamps
- 8 Rear fog lamp

i The exterior lamps go out automatically when you remove the SmartKey from the

starter switch or open the driver's door with the ignition switched off.

When the parking lamps or the rear fog lamp are switched on and you remove the SmartKey from the starter switch or open the driver's door, an acoustic signal sounds.

In addition the message **Lights Are Still On** appears in the multifunction display.

Switch off the parking lamps or the rear fog lamp manually.

! Failure to switch off the parking lamps when leaving the vehicle may result in a discharged battery.

Low-beam headlamps

The low-beam headlamps can be switched on and off with the exterior lamp switch using the manual headlamp mode.

- ▶ Switch on the ignition.
- ▶ **Switching on:** Turn the exterior lamp switch to position .

The following lamps come on:

- Low-beam headlamps
- Tail and parking lamps

- License plate lamps
- Side marker lamps
- Instrument panel lamps
- Green indicator lamp in the exterior lamp switch

- ▶ **Switching off:** Turn the exterior lamp switch to position .

Automatic headlamp mode

The following lamps come on and go out automatically depending on the brightness of the ambient light:

- Low-beam headlamps
- Tail and parking lamps
- License plate lamps
- Side marker lamps



Warning!

If the exterior lamp switch is set to **AUTO**, the headlamps will not automatically come on under foggy conditions.

To minimize risk to you and to others, activate headlamps by turning exterior lamp switch to when driving or when traffic

Lighting

and/or ambient lighting conditions require you to do so.

In low ambient lighting conditions, only switch from position **AUTO** to  with the vehicle at a standstill in a safe location. Switching from **AUTO** to  will briefly switch off the headlamps. Doing so while driving in low ambient lighting conditions may result in an accident.

The automatic headlamp feature is only an aid to the driver. The driver is responsible for the operation of the vehicle's lights at all times.

- ▶ **Switching on:** Turn the exterior lamp switch to position **AUTO**.

With the SmartKey in starter switch position **1** or the KEYLESS-GO start/stop button pressed once, the tail and parking lamps, the license plate lamps and the side marker lamps will come on and go out depending on the brightness of the ambient light.

When the engine is running the low-beam headlamps, the tail and parking lamps, the license plate lamps and the side marker lamps will come on and go out depending on the brightness of the ambient light.

Canada only:

High-beam headlamps are only available with the exterior lamp switch in position .

Daytime running lamp mode

In Canada the daytime running lamp mode is mandatory and therefore in a constant mode. In the USA the daytime running lamp mode is deactivated by default. Activate the daytime running lamp mode using the control system, see "Setting daytime running lamp mode (USA only)" (▷ page 138).

- ▶ Turn the exterior lamp switch to position **0** or **AUTO**.

When the engine is running, the low-beam headlamps come on.

In low ambient lighting conditions, the following lamps will come on additionally:

- Tail and parking lamps
- License plate lamps
- Side marker lamps



With the daytime running lamp mode activated and the engine running, you cannot switch off the low-beam headlamps manually.

Canada only

With the exterior lamp switch in position **0** or **AUTO**, you cannot switch on the high-beam headlamps.



The high-beam flasher is available at all times. For nighttime driving turn the exterior lamp switch to position  to permit activation of the high-beam headlamps.

When the engine is running, and you

- shift from a driving position to neutral position **N** or park position **P** with the vehicle at a standstill, the low-beam headlamps will go out with a delay of 3 minutes.
- turn the exterior lamp switch to position , the low-beam headlamps, the tail and parking lamps, the license plate lamps and the side marker lamps come on.
- turn the exterior lamp switch to position , the manual headlamp mode has priority over the daytime running lamp mode. The corresponding exterior lamps come on (▷ page 99).

USA only

You can only switch on the high-beam headlamps in low ambient lighting conditions.

When the engine is running, and you turn the exterior lamp switch to position  or , the manual headlamp mode has priority over the daytime running lamp mode.

The corresponding exterior lamps come on (▷ page 99).

Fog lamps





Fog lamps cannot be switched on with the exterior lamp switch in position **AUTO**. To switch on the fog lamps, turn the exterior lamp switch to position  first.

Warning!

In low ambient lighting or foggy conditions, only switch from position **AUTO** to  with the vehicle at a standstill in a safe location.

Switching from **AUTO** to  will briefly switch off the headlamps. Doing so while driving in low ambient lighting conditions may result in an accident.

Fog lamps will operate with the parking lamps and/or the low-beam headlamps on. Fog lamps should only be used in conjunction with low-beam headlamps. Consult your State or Province Motor Vehicle Regulations regarding permissible lamp operation.

- ▶ Switch on the ignition.
- ▶ Turn the exterior lamp switch to position  or  (▷ page 99).
- ▶ **Switching on front fog lamps:** Pull out the exterior lamp switch to first stop. The green indicator lamp  in the exterior lamp switch comes on.
- ▶ **Switching on rear fog lamp:** Pull out the exterior lamp switch to second stop. The rear fog lamp, the front fog lamps and the yellow indicator lamp  in the exterior lamp switch come on.
- ▶ **Switching off front fog lamps/rear fog lamp:** Push in the exterior lamp switch to its stop.

Locator lighting and night security illumination

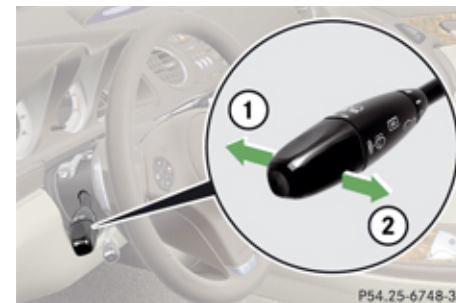

Locator lighting and night security illumination are described in the “Control system” section, see “Setting locator lighting” (▷ page 138) and “Setting night security illumination (Headlamps delayed shut-off feature)” (▷ page 139).

Combination switch



- ① High beam
- ② High-beam flasher

High beam

- ▶ Turn the exterior lamp switch to position  (▷ page 99).
- ▶ **Switching on:** Push the combination switch in direction of arrow ①. The high-beam headlamp indicator lamp  in the instrument cluster comes on.
- ▶ **Switching off:** Pull the combination switch in direction of arrow ② to its original position.

Lighting

High-beam flasher

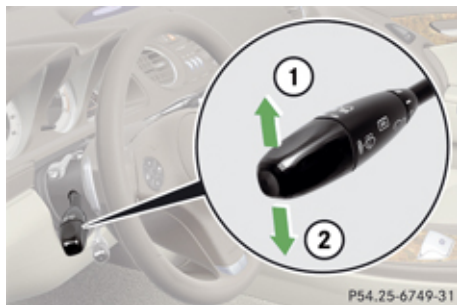

- ▶ **Switching on:** Pull the combination switch briefly in direction of arrow ②.

Turn signals



- ① Turn signals, right
- ② Turn signals, left

- ▶ Press the combination switch in direction of arrow ① or ②.

The corresponding turn signal indicator lamp  or  in the instrument cluster flashes.

The combination switch resets automatically after major steering wheel movements.

- ① To signal minor directional changes such as changing lanes, press combination switch only to point of resistance and release. The corresponding turn signal lamps will flash three times.

Hazard warning flasher

The hazard warning flasher can be switched on at all times, even with the SmartKey removed from the starter switch or with the SmartKey with KEYLESS-GO removed from the vehicle.

The hazard warning flasher comes on automatically when an air bag deploys.

The hazard warning flasher switch is located on the upper part of the center console.



- ① Hazard warning flasher switch

- ▶ **Switching on:** Press hazard warning flasher switch ①.

All turn signal lamps are flashing.

- ① With the hazard warning flasher activated and the combination switch set for either left or right turn, only the respective left or right turn signals will operate when the ignition is switched on.

- ▶ **Switching off:** Press hazard warning flasher switch ① again.

- ① If the hazard warning flasher has been activated automatically, press hazard warning flasher switch ① once to switch off.

Headlamp cleaning system



① Headlamp cleaning button

- ▶ Switch on the ignition.
- ▶ Press button ①.

The headlamps are cleaned with a high-pressure water jet.

The headlamps will automatically be cleaned when you have

- switched on the headlamps and
- the windshield wipers have wiped the windshield with washer fluid fifteen times

When you switch off the ignition, the counter resets.

For information on filling up the washer reservoir, see “Washer system and headlamp cleaning system” (▷ page 208).

Corner-illuminating lamps

The corner-illuminating lamps improve illumination of the area in the direction into which you are turning.

The corner-illuminating lamps will only operate in low ambient lighting conditions.

If you are driving faster than 43 mph (70 km/h) the corner-illuminating function is not available.

Switching on

- ▶ Make sure the engine is running.
- ▶ Turn the exterior lamp switch to position  or **AUTO** (▷ page 99).

or

- ▶ Activate the daytime running lamp mode (▷ page 100).
- ▶ Switch on the left or right turn signal, depending on whether you are turning left or right.

The respective corner-illuminating lamp comes on. If you have switched on the turn

signal for one side but turn the steering wheel in the other direction, the corner-illuminating lamp comes on on the side of the turn signal.

or

- ▶ Turn steering wheel in desired direction. Driving forward: The corner-illuminating lamp on the side of your steering direction comes on.

Driving in reverse: The corner-illuminating lamp opposite to your steering direction comes on.

The corner-illuminating lamps will come on automatically depending on the steering angle, even if you did not switch on either turn signal. If the corner-illuminating lamps came on automatically, they will also go out automatically depending on the steering angle and vehicle speed.

The corner-illuminating lamps temporarily come on on both sides of the vehicle if you turn the steering wheel in one direction and then again in the other direction shortly thereafter.

The corner-illuminating lamp remains lit for a maximum of 3 minutes. Afterward, it goes out even if the turn signal is still switched on.

Lighting

Switching off

▶ Switch off the left or right turn signal.

or

▶ Steer straight ahead.





The corner-illuminating lamp goes out.

i There may be a brief delay before the corner-illuminating lamps go out.

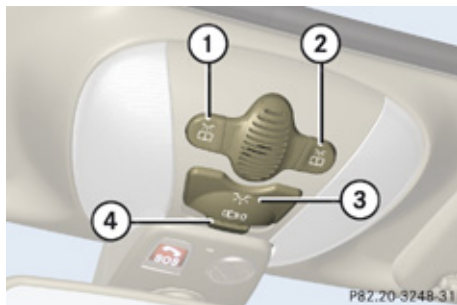
Interior lighting

The interior lighting controls are located in the overhead control panel.



- ①  Left reading lamp on/off
- ②  Right reading lamp on/off
- ③  Interior lighting on/off
- ④  Slide switch for automatic control

Automatic control

▶ **Activating:** Slide switch ④ to the left.

The interior lighting and the entry/exit lamps come on in darkness, when you:

- unlock the vehicle
- remove the SmartKey from the starter switch
- open a door
- open the trunk

▶ **Deactivating:** Slide switch ④ to the right.

The interior lighting goes out after a preset time (▶ page 140).

i If a door remains open, the interior lamps go out automatically after approximately 5 minutes.

Manual control

! An interior lamp switched on manually does not go out automatically.

Leaving an interior lamp switch in the ON position for extended periods of time with the engine turned off could result in a discharged battery.

▶ **Switching on/off interior lighting:** Press switch .

▶ **Switching on/off reading lamps:** Press respective switch .

Courtesy lighting

For better orientation in the dark, courtesy lamps will illuminate the interior of your vehicle as follows:

With parking lamps switched on:

- the door handles
- the driver and passenger footwells

With SmartKey in starter switch position 1:

- the door handles
- the center console

i If you turn the SmartKey in the starter switch to position 0 and switch off the headlamps, the door handle lamps will remain lit for approximately 5 minutes.

Wipers

Notes

- ❗ Do not operate the wipers when the windshield is dry. Dust that accumulates on a windshield might scratch the glass and/or damage the wiper blades when wiping occurs on a dry windshield. If it is necessary to operate the wipers in dry weather conditions, always operate the wipers with washer fluid.

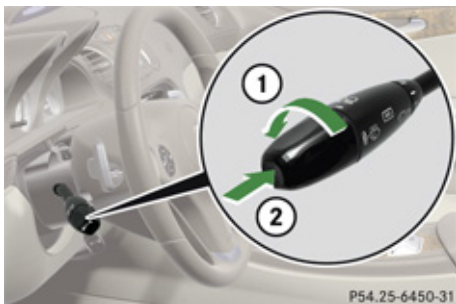

Combination switch

- ① Switching on windshield wipers
 ② Single wipe
 Wiping with washer fluid

- Switch on the ignition.

Windshield wipers

Switching windshield wipers on/off

0	Windshield wipers off
I	Intermittent wiping
II	Normal wiper speed
III	Fast wiper speed

- Turn the combination switch in direction of arrow ① to the desired position, depending on the intensity of the rain.

Intermittent wiping

Only switch on intermittent wiping under wet weather conditions or in the presence of precipitation.

- ❗ Do not leave windshield wipers on an intermittent setting when the vehicle is taken to an automatic car wash or during windshield cleaning. Windshield wipers will operate in the presence of water sprayed on the windshield, and windshield wipers may be damaged as a result.

- ❗ If you have set intermittent wiping, dirt on the surface of the rain sensor or optical effects may cause the windshield wipers to wipe in an undesired fashion. This could then damage the windshield wiper blades or scratch the windshield. You should therefore switch off the windshield wipers when weather conditions are dry.

Intermittent wiping interval is dependent on wetness of windshield. After the initial wipe, pauses between wipes are automatically controlled by the rain sensor.

- Turn the combination switch to position **I**.

Intermittent wiping is interrupted when the vehicle is at a standstill and a door is opened. This protects persons getting into or out of the vehicle from being sprayed.

Intermittent wiping will be continued when all doors are closed and

- the automatic transmission is in drive position **D** or reverse gear **R**
or
- the wiper setting is changed using the combination switch

Wipers

Single wipe

- ▶ Press the combination switch briefly in direction of arrow ② to the resistance point.
The windshield wipers wipe one time without washer fluid.

Wiping with washer fluid

- ▶ Press the combination switch in direction of arrow ② past the resistance point.
The windshield wipers operate with washer fluid.

i To prevent smears on the windshield or noisy/chattering wiper blades, wipe with washer fluid every now and then even when it is raining.

For information on filling up the washer reservoir, see “Washer system and headlamp cleaning system” (▷ page 208).

For information on cleaning the headlamps with washer fluid, see “Headlamp cleaning system” (▷ page 103).

Problems with wipers

! If anything blocks the windshield wipers (leaves, snow, etc.), switch them off immediately.

- For safety reasons, stop the vehicle in a safe location and
 - remove the SmartKey from the starter switch
 - or
 - turn off the engine by pressing the KEYLESS-GO start/stop button and open the driver’s door (with the driver’s door open, starter switch is in position **0**, same as with SmartKey removed from starter switch)
 - engage the parking brakebefore attempting to remove any blockage.
- Remove blockage.
- Turn the windshield wipers on again.

If the windshield wipers fail to function at all with the combination switch in position **I**,

- set the combination switch to the next higher wiper speed
- have the windshield wipers checked at the nearest authorized Mercedes-Benz Center

Power windows

Power windows

Opening and closing

The windows are opened and closed electrically. The switches for all windows are located on the driver's door. The switch for operating the passenger-side windows is located on the passenger door.

⚠ Warning!

When closing the windows, make sure there is no danger of anyone being harmed by the closing procedure.

The door windows are equipped with the express operation and automatic reversal function. If in express operation mode a door window encounters an obstruction that blocks its path, the automatic reversal function will stop the door window and open it slightly.

The door windows operate differently when the switch is pressed and held. See the "Closing when a door window is blocked" section for details.

The closing of the door windows can be immediately halted by releasing the switch or, if the switch was pressed past the resistance point and released, by pressing or pulling the respective switch.

The closing of the rear side windows can be immediately halted by releasing the switch. If a window encounters an obstruction that blocks its path in a circumstance where you are closing the windows by pressing and holding button  on the SmartKey or by pressing and holding the lock button (vehicles with KEYLESS-GO) on an outside door handle the automatic reversal function will not operate.

⚠ Observe Safety notes, see page 60.

- i** You can also open or close the windows using the SmartKey, see "Summer opening feature" (▷ page 175) and "Convenience closing feature" (▷ page 175).
- i** After switching off the ignition or removing the SmartKey from the starter switch, you can operate the windows until you open a door. If no door was opened you can operate the windows for up to 5 minutes.



- ① Left door and rear side window
- ② Right door and rear side window

Door windows

- i** When you open the door windows while the hardtop is open, the rear side windows will also open automatically.
 - ▶ Switch on the ignition.
 - ▶ **Opening/Closing:** Press or pull and hold switch ① or ② to the resistance point. The corresponding door window will move downwards or upwards until you release the switch.

Power windows

- ▶ **Express operation:** Press or pull switch ① or ② past the resistance point and release.
The corresponding door window opens or closes completely.
- ▶ **Stopping during Express operation:**
Press or pull the respective switch again.

Closing when a door window is blocked

Warning!

Make sure that nobody can become trapped and be seriously or even fatally injured when closing a door window with greater force or without automatic reversal function.

If the upward movement of a door window is blocked during the closing procedure, the door window will stop and open slightly. However, the door window will exert greater force before reversing than when the door window is closed in express operation. Please exercise caution!

- ▶ Immediately after the door window has stopped because it was blocked, pull the respective switch upwards until the door window is fully closed.

If the door window is blocked again and opens slightly:

- ▶ Immediately after the door window was blocked, pull the respective switch upwards until the door window is fully closed.

Warning!

Pressing and holding the switch to close the door window immediately after it had been blocked two times will cause the door window to close without any reversal function for as long as you hold the switch.

Opening and closing the rear side windows

- ▶ **Opening:** Open the door window.
- ▶ Press switch ① or ② again.
The corresponding rear side window will open completely.
- ▶ **Closing:** Close the door window.
- ▶ Pull and hold switch ① or ②.
The corresponding rear side window will move upwards until you release the switch.

Closing with KEYLESS-GO

When locking the vehicle, you can simultaneously close the windows.

- ▶ Press and hold the lock button on an outside door handle (▷ page 79) until the windows are completely closed.
- ▶ Release the lock button on the outside door handle to interrupt the closing procedure.

Synchronizing power windows

The windows must be synchronized after the battery has been disconnected or if the windows cannot be fully closed (Express operation).

Each power window must be synchronized separately.

- ▶ Close all doors.
- ▶ Switch on the ignition.
- ▶ Pull and hold switch ① or ② (▷ page 107) until the respective window is closed.

The window opens again slightly.

- ▶ Pull and hold the respective switch once more immediately until the window is completely closed.
- ▶ Hold the respective switch for approximately 1 second.
The window is synchronized.

Driving and parking

Safety notes

Warning!

Make sure absolutely no objects are obstructing the pedals' range of movement. Keep the driver's footwell clear of all obstacles. If there are any floor mats or carpets in the footwell, make sure the pedals still have sufficient clearance.

During sudden driving or braking maneuvers the objects could get caught between the pedals. You could then no longer brake or accelerate. This could lead to accidents and injury.

Warning!

With the engine not running, there is no power assistance for the brake and steering systems. In this case, it is important to keep in mind that a considerably higher degree of effort is necessary to brake and steer the vehicle. Adapt your driving accordingly.

Starting the engine

Warning!

Inhalation of exhaust gas is hazardous to your health. All exhaust gas contains carbon monoxide (CO), and inhaling it can cause unconsciousness and possible death.

Do not run the engine in confined areas (such as a garage) which are not properly ventilated. If you think that exhaust gas fumes are entering the vehicle while driving, have the cause determined and corrected immediately. If you must drive under these conditions, drive only with at least one window fully open at all times.

Driving and parking

Automatic transmission

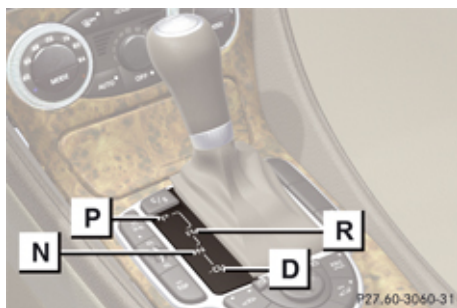

Gearshift pattern for automatic transmission

- P** Park position with gear selector lever lock
- R** Reverse gear
- N** Neutral position
- D** Drive position

For more information, see “Automatic transmission” (▷ page 115).

- ▶ Make sure the automatic transmission is in park position **P**.

Starting with the SmartKey

- ▶ Do not depress the accelerator pedal.

- ▶ Turn the SmartKey in the starter switch to position **3** (▷ page 87) and release it. The engine starts automatically.

Starting with KEYLESS-GO

⚠ Warning!

As long as the SmartKey is in your vehicle, the vehicle can be started. Therefore, never leave children unattended in the vehicle, as they could otherwise accidentally start the engine.

When leaving the vehicle, always take the SmartKey with you and lock the vehicle. Do not leave children unattended in the vehicle, or with access to an unlocked vehicle. A child's unsupervised access to a vehicle could result in an accident and/or serious personal injury.

You can start your vehicle without the SmartKey in the starter switch using the KEYLESS-GO start/stop button on the gear selector lever.

The SmartKey must be located in the vehicle.

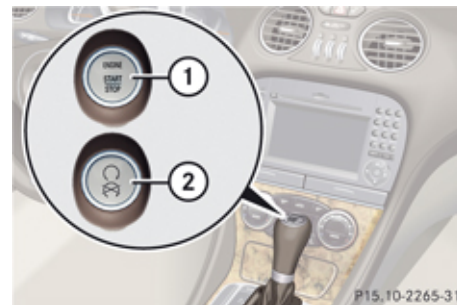

KEYLESS-GO start/stop button

- ① USA only
- ② Canada only

- ▶ Depress the brake pedal during the starting procedure.
- ▶ Do not depress the accelerator pedal.
- ▶ Press the KEYLESS-GO start/stop button once. The engine starts automatically.

Starting difficulties

- !** Remember that extended starting attempts can drain the battery.

Driving and parking

The engine does not start. You can hear the starter.

There could be a malfunction in the engine electronics or in the fuel supply system.

Carry out the following steps:

- ▶ If you are starting the engine with the SmartKey: Turn the SmartKey in the starter switch to position **0** and repeat the starting procedure.
- ▶ If you are starting the engine with KEYLESS-GO: Close any doors that may be open to allow for better detection of the SmartKey.

or

- ▶ Start the engine with the SmartKey as radio signals from another source may be interfering with the KEYLESS-GO function.
- ▶ Repeat the starting procedure.

If the engine does not start after several starting attempts:

- ▶ Contact an authorized Mercedes-Benz Center or call Roadside Assistance.

The engine does not start. You cannot hear the starter.

The battery may not be sufficiently charged.

- ▶ Get a jump start (▷ page 328).

If the engine will not start despite a jump start:

- ▶ Contact an authorized Mercedes-Benz Center or call Roadside Assistance.

The starter has been exposed to excessive temperatures.

- ▶ Let the starter cool for about two minutes.
- ▶ Repeat the starting procedure.

If the engine does not start after several starting attempts:

- ▶ Contact an authorized Mercedes-Benz Center or call Roadside Assistance.

Driving off** Warning!**

On slippery road surfaces, never downshift in order to obtain braking action. This could result in drive wheel slip and reduced vehicle control. Your vehicle's ABS will not prevent this type of loss of control.

- ▶ Do not run cold engine at high engine speeds. Running a cold engine at high engine speeds may shorten the service life

of the engine. This is not covered by the Mercedes-Benz Limited Warranty.

SL 63 AMG: At engine temperatures below 68°F (20°C), the engine's maximum speed is restricted in order to protect it from damage. Avoid driving your vehicle at full speed when the engine is cold to prevent premature engine wear and/or diminished comfort.

- ▶ **!** If you hear a warning signal and the message **Release Parking Brake** appears in the multifunction display when driving off, you have forgotten to release the parking brake.

Release the parking brake.

- ▶ **!** Avoid spinning of a drive wheel. This may cause serious damage to the drivetrain which is not covered by the Mercedes-Benz Limited Warranty.

- ▶ **!** Simultaneously depressing the accelerator pedal and applying the brakes reduces engine performance and causes premature brake and drivetrain wear which is not covered by the Mercedes-Benz Limited Warranty.

Driving and parking

- i** Once the vehicle is in motion, the automatic central locking system engages and the locking knobs in the doors move down. The automatic door lock feature can be deactivated (▷ page 140).

Automatic transmission

Warning!

It is dangerous to shift the automatic transmission out of park position **P** or neutral position **N** if the engine speed is higher than idle speed. If your foot is not firmly on the brake pedal, the vehicle could accelerate quickly forward or in reverse. You could lose control of the vehicle and hit someone or something. Only shift into gear when the engine is idling normally and when your right foot is firmly on the brake pedal.

- !** Only shift the automatic transmission into reverse gear **R** or park position **P** when the vehicle is stopped. Otherwise the automatic transmission could be damaged.
- ▶ Depress the brake pedal.
The gear selector lever lock is released.
 - ▶ Shift the automatic transmission into drive position **D** or reverse gear **R**.

- i** Shifting the automatic transmission out of park position **P** is only possible with the brake pedal depressed.

Only depressing the brake pedal releases the gear selector lever lock.

- ▶ Wait for the gear selection process to complete before setting the vehicle in motion.
- ▶ Release the brake pedal.
- ▶ If engaged, release the parking brake.
- ▶ Carefully depress the accelerator pedal.

After a cold start, the automatic transmission shifts at a higher engine revolution. This allows the catalytic converter to reach its operating temperature earlier.

For more information on driving, see “Driving instructions” (▷ page 236).

Problems while driving

The engine runs erratically and misfires

- An ignition cable may be damaged.
 - The engine electronics may not be operating properly.
 - Unburned gasoline may have entered the catalytic converter and damaged it.
- ▶ Give very little gas.
 - ▶ Have the problem checked at an authorized Mercedes-Benz Center as soon as possible.

The coolant temperature is above 248°F (120°C)

The coolant is too hot and is no longer cooling the engine.

- ▶ Stop the vehicle in a safe location as soon as possible.
- ▶ Turn off the engine immediately.
- ▶ Allow the engine and coolant to cool off.
- ▶ Check the coolant level and add coolant if necessary (▷ page 207).

In case of accident

If the vehicle is leaking fuel:

- ▶ Do not start the engine under any circumstances.
- ▶ Exit the vehicle at a safe distance from the roadway.
- ▶ Notify local fire and/or police authorities.

If the extent of the damage cannot be determined:

- ▶ Contact an authorized Mercedes-Benz Center or call Roadside Assistance.

If no damage can be determined on the

- major assemblies
- fuel system
- engine mount:
- ▶ Start the engine in the usual manner.

Parking

Warning!

Do not park this vehicle in areas where combustible materials such as grass, hay or leaves can come into contact with the hot exhaust system, as these materials could be ignited and cause a vehicle fire.

To reduce the risk of serious personal injury, or damage to the vehicle or the vehicle drivetrain, as a result of vehicle movement, always do the following before turning off the engine and leaving the vehicle:

- Keep right foot on the brake pedal.
- Engage the parking brake.
- Shift the automatic transmission into park position **P**.
- Slowly release the brake pedal.
- When parked on an incline, always turn the front wheels towards the road curb.
- Turn the SmartKey in the starter switch to position **0** and remove the SmartKey

from the starter switch, or press the KEY-LESS-GO start/stop button.

- Take the SmartKey with you and lock the vehicle when leaving.

Parking brake

Warning!

Engaging the parking brake while the vehicle is in motion can cause the rear wheels to lock up. You could lose control of the vehicle and cause an accident. In addition, the vehicle's brake lights do not light up when the parking brake is engaged.

Warning!

When leaving the vehicle, always remove the SmartKey from the starter switch, take it with you, and lock the vehicle. Do not leave children unattended in the vehicle, or with access to an unlocked vehicle. Children could release the parking brake and/or shift the automatic transmission out of park position **P**, either of which could result in an accident and/or serious personal injury.

Driving and parking

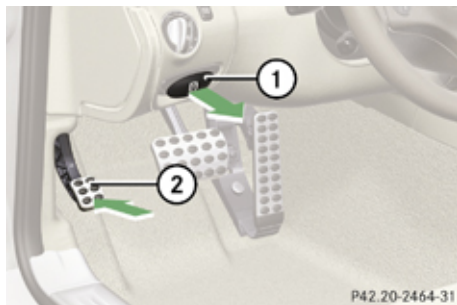

- ① Release handle
- ② Parking brake pedal

► **Releasing:** Pull on release handle ①.

When the ignition is switched on or the engine is running, the brake warning lamp **BRAKE** (USA only) or **(P)** (Canada only) in the instrument cluster goes out.

► **Engaging:** Step firmly on parking brake pedal ②.

When the engine is running, the brake warning lamp **BRAKE** (USA only) or **(P)** (Canada only) in the instrument cluster comes on.

Turning off the engine

⚠ Warning!

Do not turn off the engine before the vehicle has come to a complete stop. With the engine not running, there is no power assistance for the brake and steering systems. In this case, it is important to keep in mind that a considerably higher degree of effort is necessary to brake and steer the vehicle.

► Shift the automatic transmission into park position **P**.

► Engage the parking brake.

i Always engage the parking brake in addition to shifting the automatic transmission into park position **P**.

When parked on an incline, also turn the front wheels towards the road curb.

Turning off with SmartKey

► Turn the SmartKey in the starter switch to position **0**.

► Remove the SmartKey from the starter switch.

The immobilizer is activated.

The SmartKey can only be removed from the starter switch with the automatic transmission in park position **P**.

Turning off with KEYLESS-GO

► Press the KEYLESS-GO start/stop button. With the driver's door closed, the starter switch is now in position **1**. With the driver's door opened, the starter switch is set to position **0**, same as the SmartKey removed from the starter switch (► page 87).

If you hear a warning signal, you have tried to turn off the engine with the KEYLESS-GO start/stop button while the automatic transmission was not in park position **P**.

Read and observe messages that may appear in the multifunction display (► page 265).

Automatic transmission

Automatic transmission

Introduction

For information on driving with an automatic transmission, see “Driving and parking” (▷ page 109).

Warning!

Make sure absolutely no objects are obstructing the pedals’ range of movement. Keep the driver’s footwell clear of all obstacles. If there are any floor mats or carpets in the footwell, make sure the pedals still have sufficient clearance.

During sudden driving or braking maneuvers the objects could get caught between the pedals. You could then no longer brake or accelerate. This could lead to accidents and injury.

! Allow engine to warm up under low load use. Do not place full load on the engine until the operating temperature has been reached.

Avoid spinning of a drive wheel for an extended period when driving off on slippery road surfaces.

This may cause serious damage to the engine and the drivetrain which is not cov-

ered by the Mercedes-Benz Limited Warranty.

- i** During the brief warm-up, transmission upshifting is delayed. This allows the catalytic converter to heat up more quickly to operating temperature.

Gear selector lever



Gearshift pattern for automatic transmission

- P** Park position with gear selector lever lock
- R** Reverse gear
- N** Neutral position
- D** Drive position

Warning!

It is dangerous to shift the automatic transmission out of park position **P** or neutral position **N** if the engine speed is higher than idle speed. If your foot is not firmly on the brake pedal, the vehicle could accelerate quickly forward or in reverse. You could lose control of the vehicle and hit someone or something. Only shift into gear when the engine is idling normally and when your right foot is firmly on the brake pedal.

! Only shift the automatic transmission into reverse gear **R** or park position **P** when the vehicle is stopped. Otherwise the automatic transmission could be damaged.

- i** Shifting the automatic transmission out of park position **P** is only possible with the brake pedal depressed.

Only depressing the brake pedal releases the gear selector lever lock.

- i** The current gear selector lever position corresponds with the current transmission position.

The current transmission position **P**, **R**, **N**, or **D** appears in the right multifunction display (▷ page 116).

Automatic transmission

There are additional indicators on the cover of the shifting gate showing the current gear selector lever position.

The indicators come on when you insert the SmartKey into the starter switch, and go out when you remove the SmartKey from the starter switch.

Shifting procedure

The automatic transmission selects individual gears automatically, depending on:

- drive position **D** (▷ page 117) with gear ranges (▷ page 118)
- the selected program mode:
C/S (▷ page 118)
or
M (SL 63 AMG and SL 65 AMG only) (▷ page 121)
- the position of the accelerator pedal
- the vehicle speed

With drive position **D** selected, you can influence transmission shifting by:

- limiting the gear range
- extending the gear range
- changing the gears manually (SL 63 AMG and SL 65 AMG only)

Transmission positions

The current transmission position appears in the right multifunction display.



① Transmission position indicator

Effect

P

Park position

Shift the automatic transmission into park position **P** only when the vehicle is stopped. The park position is not intended to serve as a brake when the vehicle is parked. Rather, the driver should always engage the parking brake in addition to shifting the automatic transmission into park position **P** to secure the vehicle.

The SmartKey can only be removed from the starter switch with the gear selector lever in park position **P**. With the SmartKey removed from the starter switch, the gear selector lever is locked in park position **P**.

If the vehicle's electrical system is malfunctioning, the gear selector lever could remain locked in park position **P**.

- ▶ Have the vehicle's electrical system checked as soon as pos-

Automatic transmission

	Effect
	sible at an authorized Mercedes-Benz Center.
R	Reverse gear Shift the automatic transmission into reverse gear R only when the vehicle is stopped.

	Effect
N	Neutral position No power is transmitted from the engine to the drive axle. When the brakes are released, the vehicle can be moved freely (pushed or towed). To avoid damage to the transmission, never shift the automatic transmission into neutral position N while driving. If the ESP® is deactivated or malfunctioning: Shift the automatic transmission into neutral position N only if the vehicle is in danger of skidding, e.g. on icy roads. ! Coasting the vehicle, or driving for any other reason with the automatic transmission in neutral position N can result in transmission damage that is not covered by the Mercedes-Benz Limited Warranty.
D	Drive position

	Effect
	The automatic transmission shifts automatically. All forward gears are available.

Driving tips

Kickdown

Use the kickdown when you want maximum acceleration.

- Fully depress the accelerator pedal.
Depending on the engine speed the automatic transmission shifts into a lower gear.

You may encounter a resistance point. If so, depress the accelerator pedal past this resistance point.

Working on the vehicle

Warning!

When working on the vehicle, engage the parking brake and shift the automatic transmission into park position **P**. Otherwise the vehicle could roll away which could



Automatic transmission

result in an accident and/or serious personal injury.

Gear ranges

With the automatic transmission in drive position **D** and driving in automatic program mode **C** or **S**, you can limit or extend the gear range, see “One-touch gearshifting” (▷ page 120).

The current gear range appears in the right multifunction display.



① Gear range indicator

Effect

- ③ With this selection you can use the braking effect of the engine.
- ② Allows the use of engine's braking power when driving
 - on steep downgrades
 - in mountainous regions
 - under extreme operating conditions
- ① For maximum use of engine's braking effect on very steep or lengthy downgrades.

Automatic shift program



Program mode selector switch

C Comfort	For comfort driving
S Sport	For standard driving

Automatic transmission



Program mode selector dial on SL 63 AMG

C Comfort	For standard driving
S Sport	For sporty driving
S+ Sport Plus	For sporty driving with shorter shift times
M Manual	For manual gearshifting (> page 121)
RS RACE START	For optimum acceleration from a standing start

i Program mode **RS** cannot be selected while driving. For more information, see

“RACE START (SL 63 AMG)” (> page 156).



Program mode selector switch on SL 65 AMG

C Comfort	For comfort driving
S Sport	For standard driving
M MANUAL	For manual gearshifting (> page 121)

The current program mode appears in the right multifunction display.

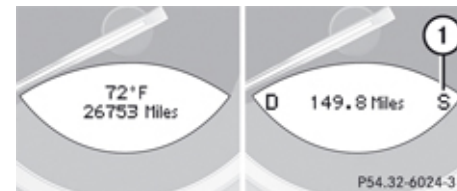

① Program mode indicator

i **SL 63 AMG:** In addition, the currently selected program mode is indicated in red on the program mode selector dial.

! Never change the program mode when the automatic transmission is out of park position **P**. This could result in a change of driving characteristics for which you may not be prepared.

i The last selected automatic program mode (**C** or **S**) is switched on when the engine is restarted.

i **SL 63 AMG:** Automatic program mode **S+** will not be stored. When the engine is turned off with automatic program mode **S+** selected, the automatic transmission



Automatic transmission

will go to automatic program mode (**C** or **S**) when the engine is restarted.

- ▶ **All models except SL 63 AMG:** Press the program mode selector switch repeatedly until the letter of the desired program mode appears in the right multifunction display.
- ▶ **SL 63 AMG:** Turn the program mode selector dial until the letter of the desired program mode appears in the right multifunction display.

Selecting program mode **C** means:

- The vehicle starts out more gentle, both forward and reverse, except when driving off with full throttle.
- Traction and driving stability are improved on icy roads.
- Upshifts occur earlier even when you give more gas. The engine then operates at lower rpms and the wheels are less likely to spin.

Selecting program mode **S** means that upshifts occur later.

One-touch gearshifting

With the automatic transmission in drive position **D** and driving in automatic program mode **C** or **S**, you can limit or extend the gear range using the gear selector lever or the steering wheel gearshift control.

U.S. vehicles: Steering wheel gearshift control is available on vehicles with AMG Sport Package, on SL 63 AMG, and on SL 65 AMG only.

SL 63 AMG and SL 65 AMG: For information on using the gear selector lever or the steering wheel gearshift control in manual program mode **M**, see “Manual shift program” (▷ page 121).

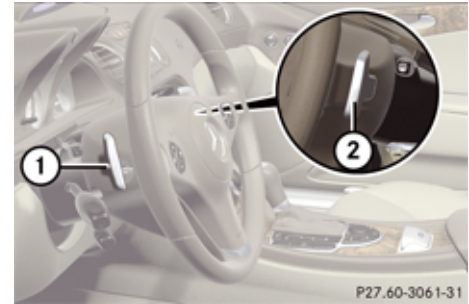

Steering wheel gearshift control (example illustration)

- ① Limiting gear range Downshift (in manual program mode **M**)
 - ② Extending gear range Upshift (in manual program mode **M**)
- i** You cannot shift with the steering wheel gearshift control when the automatic transmission is in park position **P**, neutral position **N**, or reverse gear **R**.

Limiting gear range

⚠ Warning!

On slippery road surfaces, never downshift in order to obtain braking action. This could result in drive wheel slip and reduced vehi-

Automatic transmission

cle control. Your vehicle's ABS will not prevent this type of loss of control.

- ▶ Briefly press the gear selector lever to the left in the **D-** direction.

or

- ▶ Briefly pull left gearshift control ①.

The automatic transmission will shift into the next lower gear as permitted by the shift program. This action simultaneously limits the gear range of the automatic transmission.

- ❗ To avoid overrevving the engine when downshifting, the automatic transmission will not shift into a lower gear if the engine's max. speed would be exceeded.

Extending gear range

- ▶ Briefly press the gear selector lever to the right in the **D+** direction.

or

- ▶ Briefly pull right gearshift control ②.

The automatic transmission will shift into the next higher gear as permitted by the shift program. This action simultaneously

extends the gear range of the automatic transmission.

- ❗ If you press on the accelerator pedal when the engine has reached its rpm limit, the automatic transmission will upshift beyond any gear range limit selected.

Canceling gear range limit

- ▶ Press and hold the gear selector lever to the right in the **D+** direction until **D** reappears in the right multifunction display.

or

- ▶ Pull and hold right gearshift control ② until **D** reappears in the right multifunction display.

The automatic transmission will shift from the current gear range directly into drive position **D**.

Shifting into optimal gear range

- ▶ Press and hold the gear selector lever to the left in the **D-** direction.

or

- ▶ Pull and hold left gearshift control ①.

The automatic transmission will automatically select the gear range suited for opti-

mal acceleration and deceleration. This will involve shifting down one or more gears.

Manual shift program

The manual shift program is available on SL 63 AMG and on SL 65 AMG only.

Manual program mode **M** differs with regard to spontaneity, response time, and shifting smoothness from automatic program modes **S** or **S+** (SL 63 AMG only).

In manual program mode **M**, system-controlled automatic gearshifting is switched off. You need to change the gears by manually upshifting or downshifting using the gear selector lever or the steering wheel gearshift control.



Program mode selector dial on SL 63 AMG

Automatic transmission

C Comfort	For standard driving
S Sport	For sporty driving
S+ Sport Plus	For sporty driving with shorter shift times
M Manual	For manual gearshifting
RS RACE START	For optimum acceleration from a standing start

- i** Program mode **RS** cannot be selected while driving. For more information, see “RACE START (SL 63 AMG)” (▷ page 156).



Program mode selector switch on SL 65 AMG

C Comfort	For comfort driving
S Sport	For standard driving
M MANUAL	For manual gearshifting

The current program mode appears in the right multifunction display (▷ page 119).

- i** **SL 63 AMG:** In addition, the currently selected program mode is indicated in red on the program mode selector dial.

For information on automatic program mode (**C** or **S**), see “Automatic shift program” (▷ page 118) and “One-touch gearshifting” (▷ page 120).

Activating manual shift program

- ▶ **All models except SL 63 AMG:** Press the program mode selector switch repeatedly until **M** appears in the right multifunction display.
- ▶ **SL 63 AMG:** Turn the program mode selector dial until **M** appears in the right multifunction display.

The automatic transmission switches to manual program mode **M**. Automatic shift-

ing is switched off. The gear range is not limited.

You can change the gears manually with drive position **D** selected. You can upshift or downshift through the gears in succession.

- i** Manual program mode **M** will not be stored. When the engine is turned off with manual program mode **M** selected, the automatic transmission will go to automatic program mode (**C** or **S**) when the engine is restarted.

Upshifting

- !** In manual program mode **M**, the automatic transmission will not upshift, even if the engine has reached its overrevving range. Shift up into the next gear before the engine has reached its overrevving range. Make absolutely certain that the engine speed does not reach the red marking on the tachometer. Otherwise the engine could be damaged which is not covered by the Mercedes-Benz Limited Warranty.

- ▶ Briefly press the gear selector lever to the right in the **D+** direction.

or

- ▶ Briefly pull right gearshift control ② (▷ page 120).

The automatic transmission shifts into the next higher gear.

Upshift indicator

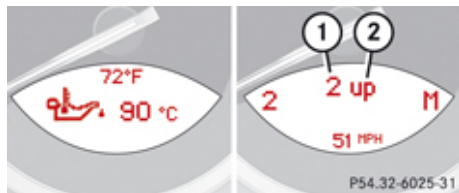

- ① Current gear
- ② Upshift indicator

In manual program mode **M**, upshift indicator ② in the right multifunction display advises you to upshift before the engine reaches the overspeed range. In addition, symbol **^** may appear instead of manual program mode symbol **M** in the right multifunction display. Thus you can drive at the maximum engine speed for each gear without overrevving the engine.

- ▶ Shift the automatic transmission from current gear ① into the next higher gear.

The fuel supply will otherwise be interrupted to prevent the engine from overrevving.

Downshifting

Warning!

On slippery road surfaces, never downshift in order to obtain braking action. This could result in drive wheel slip and reduced vehicle control. Your vehicle's ABS will not prevent this type of loss of control.

- ▶ Briefly press the gear selector lever to the left in the **D-** direction.

or

- ▶ Briefly pull left gearshift control ① (▷ page 120).

The automatic transmission shifts into the next lower gear.

- ① For maximum acceleration, press and hold the gear selector lever to the left in the **D-** direction or pull and hold the left gearshift control. Depending on the engine speed the automatic transmission selects

Automatic transmission

the optimal gear for maximum acceleration.

- ① When you brake or stop, the automatic transmission shifts down into a gear from which you can easily accelerate or take off.

Kickdown

Using the kickdown when driving in manual program mode **M** is not possible.

Deactivating manual shift program

- ▶ **All models except SL 63 AMG:** Press the program mode selector switch repeatedly until **C** or **S** appears in the right multifunction display.
- ▶ **SL 63 AMG:** Turn the program mode selector dial until **C** or **S** appears in the right multifunction display.

or

- ▶ Restart the engine.

The automatic transmission will go to automatic program mode (**C** or **S**).

Manual program mode **M** is not stored.

Instrument cluster

Emergency operation (limp-home mode)

If vehicle acceleration becomes less responsive or sluggish or the automatic transmission no longer shifts, the automatic transmission is most likely operating in limp-home (emergency operation) mode. In this mode only second gear and reverse gear **R** can be selected.

- ▶ Stop the vehicle in a safe location.
- ▶ Shift the automatic transmission into park position **P**.
- ▶ Turn off the engine.
- ▶ Wait at least 10 seconds before restarting.
- ▶ Restart the engine.
- ▶ Shift the automatic transmission into drive position **D** (for second gear) or reverse gear **R**.
- ▶ Have the automatic transmission checked at an authorized Mercedes-Benz Center as soon as possible.

Instrument cluster

Introduction

For a full view illustration of the instrument cluster, see “Instrument cluster” (▷ page 30).

Warning!

No messages will be displayed if either the instrument cluster or the multifunction display is inoperative.

As a result, you will not be able to see information about your driving conditions, such as speed or outside temperature, warning/indicator lamps, malfunction/warning messages or the failure of any systems. Driving characteristics may be impaired.

If you must continue to drive, please do so with added caution. Contact an authorized Mercedes-Benz Center as soon as possible.



① Reset button

Activating the instrument cluster

The instrument cluster is activated when you

- open a door
- switch on the ignition
- press reset button ①
- switch on the exterior lamps (▷ page 99)

i Opening a door activates the instrument cluster illumination only for about 30 seconds.

For information on changing the instrument cluster settings, e.g. the language, see (▷ page 136).

Adjusting the instrument cluster illumination

Use reset button ① to adjust the illumination brightness for the instrument cluster and the switches on the center console..

i The instrument cluster illumination is dimmed or brightened automatically to suit ambient light conditions.

- ▶ **To brighten illumination:** Turn reset button ① clockwise until the desired level of illumination is reached.
- ▶ **To dim illumination:** Turn reset button ① counterclockwise until the desired level of illumination is reached.

Coolant temperature gauge

The coolant temperature gauge is on the left side in the instrument cluster (▷ page 30).

Warning!

Driving when your engine is overheated can cause some fluids which may have leaked into the engine compartment to catch fire. You could be seriously burned.

Steam from an overheated engine can cause serious burns which can occur just

by opening the engine hood. Stay away from the engine if you see or hear steam coming from it.

Stop the vehicle in a safe location away from other traffic. Turn off the engine, get out of the vehicle and do not stand near the vehicle until the engine has cooled down.

During severe operating conditions, e.g. stop-and-go traffic, the coolant temperature may rise close to 248°F (120°C).

! Excessive coolant temperature triggers a warning in the multifunction display and the red coolant temperature warning lamp  in the instrument cluster comes on.

The engine should not be operated with a coolant temperature above 248°F (120°C). Doing so may cause serious engine damage which is not covered by the Mercedes-Benz Limited Warranty.

Resetting trip odometer

- ▶ Make sure you are viewing the standard display (▷ page 129) in the multifunction display.
- ▶ Press and hold the reset button in the instrument cluster (▷ page 124) until the trip odometer is reset.

Tachometer

The red marking on the tachometer (▷ page 30) denotes excessive engine speed.

! Avoid driving at excessive engine speeds, as it may result in serious engine damage that is not covered by the Mercedes-Benz Limited Warranty.

To help protect the engine, the fuel supply is interrupted if the engine is operated within the red marking.

Control system

Control system

Introduction

The control system is activated as soon as the starter switch is in position 1 (▷ page 87).

The control system enables you to call up information about your vehicle and to change vehicle settings.

For example, you can use the control system to find out when your vehicle is next due for maintenance service, to set the language for messages in the instrument cluster display, and much more.

Warning!

A driver's attention to the road and traffic conditions must always be his/her primary focus when driving.

For your safety and the safety of others, selecting features through the multifunction steering wheel should only be done by the driver when traffic and road conditions permit it to be done safely.









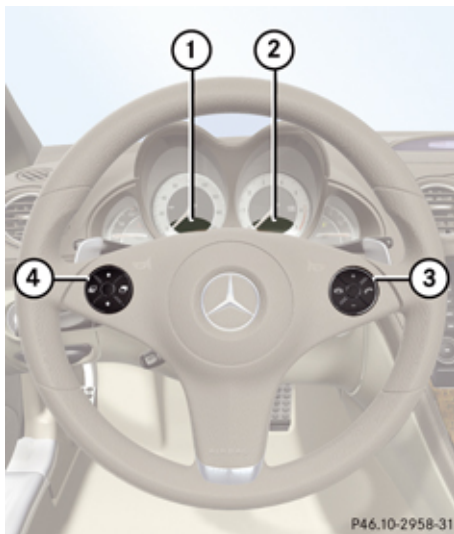

Bear in mind that at a speed of just 30 mph (approximately 50 km/h), your vehicle is covering a distance of 44 feet (approximately 14 m) every second.

The control system relays information to the multifunction display.

Multifunction steering wheel

The displays in the multifunction display and the settings in the control system are controlled by the buttons on the multifunction steering wheel.



- ① Left multifunction display in the speedometer
- ② Right multifunction display in the tachometer
- ③ Press button
 -  to take a call
 -  to dial⁵
 -  to redial⁵
 -  to end a call
 -  to reject an incoming call
- Press button
 -  to select submenus in the Settings menu
 -  to set values
 -  to operate the RACETIMER⁶
 -  to set the volume
- ④ Press button
 -  to select next or previous menu

⁵ Function only available in telephone menu.

⁶ AMG vehicles only.

Control system

Press button briefly



to move within a menu



Within **Audio/DVD** menu to select previous or next track, scene or stored station.

Within **Telephone** menu to switch to the phone book and select a name or number.

Press and hold button



Within **Audio/DVD** menu to select previous or next track with quick search or to select previous or next station in station list or wave band.

Within **Telephone** menu to start the quick search in the phone book.

Depending on the selected menu, pressing the buttons on the multifunction steering wheel will alter what appears in the multifunction display.

The information available in the multifunction display is arranged in menus and accompanying functions and submenus.

The individual functions are then found within the relevant menu (radio or CD operations under **Audio/DVD** menu, for example). These functions serve to call up relevant information or to customize the settings for your vehicle.

It is helpful to think of the menus, and the functions within each menu, as being arranged in a circular pattern.

- ▶ Press button or repeatedly to pass through each menu one after the other.
- ▶ Press button or repeatedly to pass through each function display, one after the other, in the current menu.

In the Settings menu, instead of functions, you will find a number of submenus for calling up and changing settings. For instructions on using these submenus, see “Settings menu” (▷ page 135).

The number of menus available in the system depends on which optional equipment is installed in your vehicle.

Multifunction display

The multifunction display consists of the display fields in the speedometer and the tachometer. In its default state, the left multifunction display shows the main odometer and the outside temperature, while the trip odometer appears in the right multifunction display. This default setting is referred to as the standard display.



- ① Outside temperature indicator
- ② Transmission position/gear range indicator
- ③ Trip odometer
- ④ Automatic transmission program mode indicator
- ⑤ Main odometer

For more information on menus displayed in the multifunction display, see “Menus and submenus” (▷ page 127).

Control system

Menus and submenus

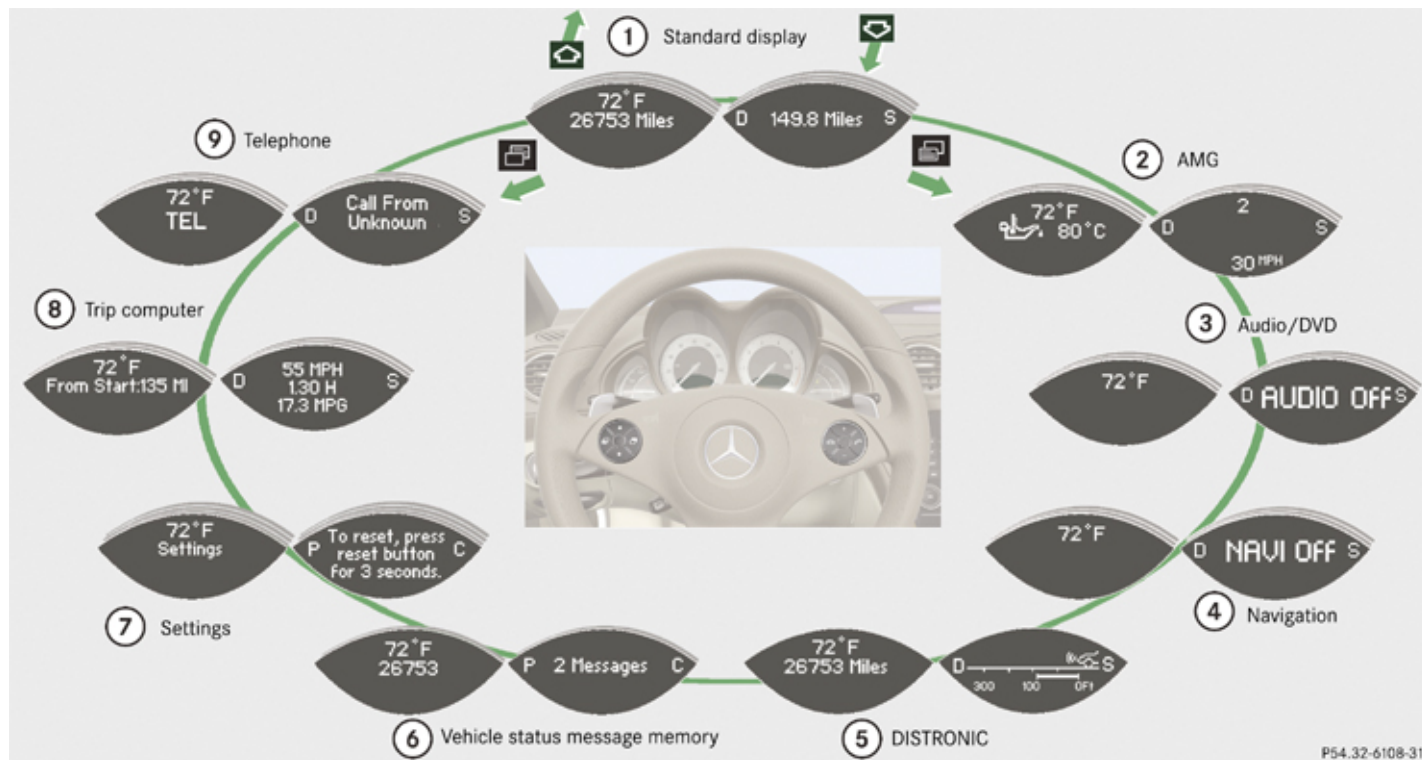

P54.32-6108-31

Control system

i The headings used in the menus table are designed to facilitate navigation within the system and are not necessarily identical to those shown in the multifunction display. The first function displayed in each menu will automatically show you which part of the system you are in.

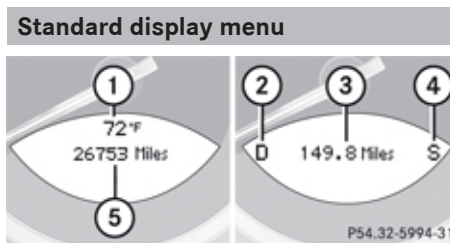

	Function
①	Standard display menu (▷ page 129)
②	AMG⁷ menu (▷ page 130)
③	Audio/DVD menu (▷ page 132)
④	Navigation menu (▷ page 134)
⑤	Distronic menu (▷ page 134)
⑥	Vehicle status message memory⁸ menu (▷ page 134)
⑦	Settings menu (▷ page 135)

	Function
⑧	Trip computer menu (▷ page 141)
⑨	Telephone menu (▷ page 142)



Standard display

- ① Outside temperature
- ② Transmission position
- ③ Trip odometer
- ④ Automatic transmission program mode
- ⑤ Main odometer

▶ If you see another display, press button  or  repeatedly until the standard display appears.

You can select whether the digital speedometer or the outside temperature appears in the left multifunction display (▷ page 137).

▶ Press button  or  to select the functions in the **Standard display** menu.

The following functions are available:

- Checking tire inflation pressure (▷ page 217)
- Calling up digital speedometer or outside temperature (▷ page 129)
- Calling up maintenance service indicator (▷ page 242)
- Checking engine oil level (▷ page 205)

Calling up digital speedometer or outside temperature

If you have selected the digital speedometer for the standard display (▷ page 137), select the outside temperature display here.

Warning!



The outside temperature indicator is not designed to serve as an ice-warning device and is therefore unsuitable for that purpose.

⁷ AMG vehicles only.

⁸ The vehicle status message memory menu is only displayed if there is a message stored.

Control system



Indicated temperatures just above the freezing point do not guarantee that the road surface is free of ice. The road may still be icy, especially in wooded areas or on bridges.

- ▶ Press button  or  repeatedly until the digital speedometer or, depending on the chosen setting, the outside temperature appears in the right multifunction display.

AMG menu

This function is only available in AMG vehicles.

The main screen of the **AMG** menu shows you the gear currently engaged as well as the engine oil temperature.

- ▶ Press button  or  repeatedly until the **AMG** menu appears in the multifunction display.

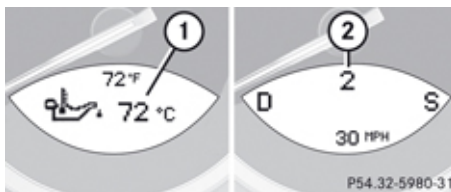

- ① Engine oil temperature indicator
- ② Gear indicator



The engine oil temperature flashes if the engine oil temperature has not yet reached 80°C. During this time, avoid driving at full engine speed.

If the engine reaches the overspeed range in the manual shift program, the menu will be shown in red. In addition, you will see **UP** next to gear indicator ② as a reminder to upshift.

Use buttons  or  to select the following functions in the **AMG** menu:

- **SETUP** (▶ page 130)
- **RACETIMER** (▶ page 130)
- Overall analysis (▶ page 132)
- Lap analysis (▶ page 132)

SETUP

- ▶ Press button  or  repeatedly until the **AMG** menu appears in the multifunction display.
 - ▶ Press button  repeatedly until the **SETUP** appears in the multifunction display.
- or
- ▶ Press **AMG** button on the center console (SL 63 AMG only) (▶ page 159).

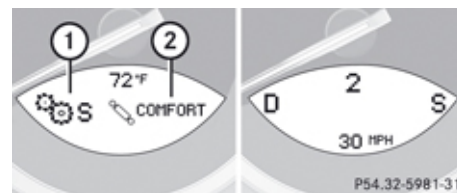

- ① Automatic transmission program mode indicator
- ② Suspension style indicator

RACETIMER

Warning!

The **RACETIMER** feature is only for use on roads and in conditions where high speed driving is permitted. Racing on public roads

Control system

is prohibited under all circumstances and the driver is and must always remain responsible for following posted speed limits.

The RACETIMER allows you to time and save driving stretches.

- ▶ Press button or repeatedly until the **AMG** menu appears in the multifunction display.
- ▶ Press button repeatedly until the RACETIMER appears in the multifunction display.

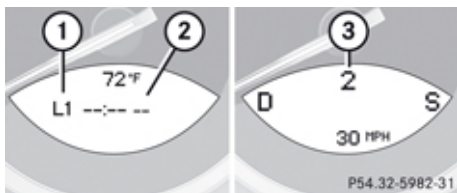

- ① Lap number
- ② RACETIMER
- ③ Gear indicator

You can start the RACETIMER when the engine is running or the starter switch is in position **2** (▷ page 87).

While the RACETIMER is being displayed, you cannot adjust the audio volume using buttons or .

- ▶ **Starting:** Press button .
- ▶ **Displaying intermediate time:** Press button while the timer is running. The intermediate time is shown for 5 seconds.
- ▶ **Stopping:** Press button .

When you stop the vehicle and turn the SmartKey to position **1** (▷ page 87) or, in vehicles with KEYLESS-GO, turn off the engine and do not open the driver's door, the RACETIMER stops timing. Timing is resumed when you switch the ignition back on or restart the engine and then press the button.

Saving lap time and starting a new lap

You can save up to nine laps.

- ▶ Press button while the timer is running. The intermediate time will be shown for 5 seconds.
- ▶ Press button within 5 seconds. The intermediate time shown will be saved as a lap time.

The RACETIMER begins timing the new lap. The new lap begins to be timed as soon as the intermediate time is called up.

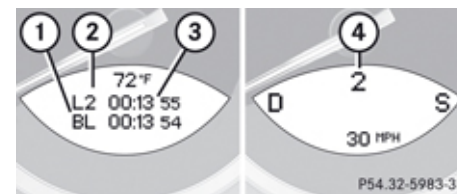

- ① Best lap time
- ② Lap number
- ③ RACETIMER
- ④ Gear indicator

Resetting current lap



- ▶ Press button while the timer is running. The timer stops.
- ▶ Press button . The lap time is reset to "0".

Deleting all laps

It is not possible to delete a single saved lap. When you turn off the engine, the RACETIMER will be reset to "0" after 30 seconds. All laps are deleted.





Control system

- ▶ Press button  while the timer is running.
The timer stops.
- ▶ Press the reset button in the instrument cluster twice (▷ page 30).
- ▶ Press button .
The timer starts. The saved laps are deleted.

Overall analysis

This function is only available if you have saved at least one lap and have stopped the RACETIMER.

- ▶ Press button  or  repeatedly until the **AMG** menu appears in the multifunction display.
- ▶ Press button  repeatedly until the overall analysis appears in the multifunction display.

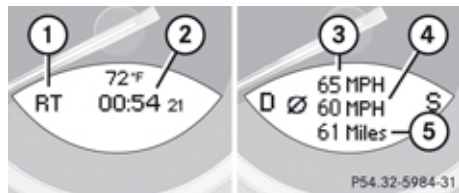



① Overall analysis of RACETIMER

- ② Overall driving time
- ③ Maximum speed
- ④ Average speed
- ⑤ Overall distance driven

Lap analysis

This function is only available if you have saved at least two laps and have stopped the RACETIMER.

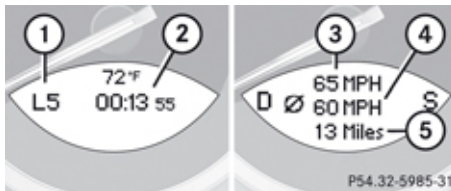

- ▶ Press button  or  repeatedly until the **AMG** menu appears in the multifunction display.
- ▶ Press button  repeatedly until the lap analysis appears in the multifunction display.

Each lap is shown in its own submenu. The fastest lap is indicated by flashing symbol ①.



- ① Lap number
- ② Lap time

- ③ Maximum speed during lap
- ④ Average speed during lap
- ⑤ Lap length

- ▶ Press button  or  to see other lap analyses.

Audio/DVD menu

The functions in the **Audio/DVD** menu operate the audio or video equipment which you currently have turned on.



If no audio equipment is currently turned on, the message **AUDIO Off** appears in the multifunction display.

The following functions are available:

- Selecting radio station (▷ page 133)
- Operating audio devices/audio media (▷ page 133)
- Operating video DVD (▷ page 133)



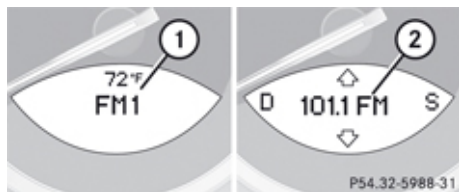

Control system

Selecting radio station

- ▶ Turn on the COMAND system and select radio. Refer to separate COMAND system operating instructions.
- ▶ Press button  or  repeatedly until the currently tuned station appears in the multifunction display.



Example illustration

- ① Wave band setting and stored memory position
 - ② Station frequency
- ▶ **Select next or previous stored station:** Press  or  briefly to select a stored station.
 - ▶ **Select next or previous station in the station list:** Press and hold  or  to select a station.
 - ▶ **Select next or previous station in wave band** (Only if no station list is available):



Press and hold  or  to select a station.

You can only store new stations using the corresponding feature on the radio. Refer to separate COMAND system operating instructions.

Additional optional satellite radio equipment and a subscription to satellite radio service provider are required for satellite radio operation. Contact an authorized Mercedes-Benz Center for details and availability for your vehicle.

For more information, refer to separate COMAND system operating instructions.



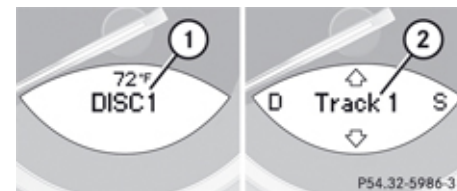

Operating audio devices/audio media

- ▶ Turn on the COMAND system and select the audio device or audio media. Refer to separate COMAND system operating instructions.
- ▶ Press button  or  repeatedly until **Audio/DVD** menu appears in the multifunction display.





Example illustration

- ① Disc number
- ② Current track

- ▶ **Selecting previous or next track:** Press button  or  briefly.
- ▶ **Selecting a track from the track list (quick search):** Press and hold button  or .

The current track does not appear during Audio AUX mode operation.

Operating video DVD

- ▶ Turn on the COMAND system and select DVD-Video. Refer to separate COMAND system operating instructions.
- ▶ Press button  or  repeatedly until **Audio/DVD** menu appears in the multifunction display.

Control system





- ① Disc number
- ② Current scene

▶ Press button  or  to select a scene.

Navigation menu

The **Navigation** menu contains the functions needed to operate your navigation system.

▶ Press button  or  repeatedly until the **Navigation** menu appears in the multifunction display.

The message shown in the multifunction display depends on the status of the navigation system:

- With the COMAND system switched off, the message NAVI Off appears in the multifunction display.
- With the COMAND system switched on but route guidance not activated, the direction of travel and, if applicable, the

name of the street currently traveled on appear in the multifunction display.

- With the COMAND system switched on and route guidance activated, the direction of travel and maneuver instructions appear in the multifunction display.

Please refer to the COMAND system operating instructions for instructions on how to activate the route guidance system.

Distronic menu

Use the **Distronic** menu to display the current settings for your Distronic system. The information shown in the multifunction display depends on whether the Distronic system is activated or deactivated.

Please refer to the “Driving systems” section of this manual (▶ page 147) for instructions on how to activate Distronic.



Vehicle status message memory menu

Use the **Vehicle status message memory** menu to scan malfunction and warning messages that may be stored in the memory. Such messages appear in the multifunction display and are based on conditions or system status the vehicle’s system has recorded. The **Vehicle status message memory** menu only appears, if messages have been stored.

Warning!

Malfunction and warning messages are only indicated for certain systems and are intentionally not very detailed. The malfunction and warning messages are simply a reminder with respect to the operation of certain systems. They do not replace the owner’s and/or driver’s responsibility to maintain the vehicle’s operating safety. Have all required maintenance and safety checks performed on the vehicle. Bring the vehicle to an authorized Mercedes-Benz Center to address the malfunction and warning messages.

Control system

- ▶ Press button  or  repeatedly until the **Vehicle status message memory** menu appears in the multifunction display. If conditions have occurred causing status messages to be recorded, the number of messages appears in the right multifunction display:

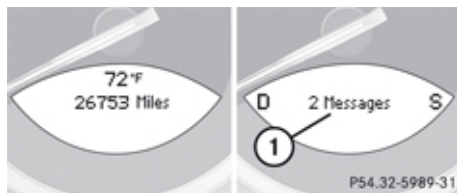

① Number of recorded status messages

- ▶ Press button  or .

The stored messages will now be displayed in the order in which they have occurred. For malfunction and warning messages, see “Vehicle status messages in the multifunction display” (▷ page 255).

- i** After you have scrolled through all recorded status messages, the first recorded message appears again.

Should the vehicle’s system record any conditions while driving, the number of messages will reappear in the multifunction display

when the SmartKey in the starter switch is turned to position **0** or removed from the starter switch. With KEYLESS-GO the number of messages will reappear when you turn off the engine by pressing the KEYLESS-GO start/stop button and open the driver’s door. Except for high-priority messages, the vehicle status message memory will be cleared when you turn off the ignition.

Settings menu

Introduction

In the Settings menu there are two functions: The function To reset, press reset button for 3 seconds, with which you can reset all the settings to the original factory settings and a collection of submenus with which you can make individual settings for your vehicle.

The following settings and submenus are available in the Settings menu:



- Resetting to factory settings (▷ page 135)
- Submenus in the Settings menu (▷ page 136)
- Instrument cluster submenu (▷ page 136)

- Lighting submenu (▷ page 138)
- Vehicle submenu (▷ page 140)
- Convenience submenu (▷ page 140)

Resetting to factory settings

You can reset the functions of all submenus to the factory settings.

For safety reasons, the function Light Circuit Headlamp Mode in the Lighting submenu cannot be reset while driving.

- ▶ Press button  or  repeatedly until the Settings menu appears in the multifunction display.

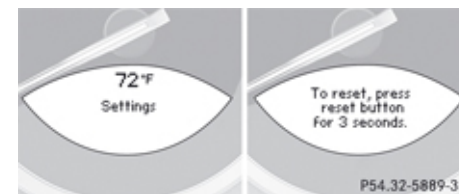

- ▶ Press the reset button in the instrument cluster for approximately 3 seconds. The request to press the reset button once more to confirm appears in the right multifunction display.



Control system

- ▶ Press the reset button once more.

The functions of all the submenus will be reset to factory settings.









The settings you have changed will not be reset unless you confirm the action by pressing the reset button a second time.

Submenus in the Settings menu

- ▶ Press button  or  repeatedly until the Settings menu appears in the multifunction display.
- ▶ Press button .

The collection of the submenus appears in the right multifunction display. There are more submenus than can be simultaneously displayed.



- ▶ Press button . The selection marker moves to the next submenu.
- ▶ Scroll down with button , scroll up with button .
- ▶ With the selection marker on the desired submenu, use button  to access the individual functions within that submenu.
- ▶ Once within the submenu, use button  to move to the next function or button  to move to the previous function within that submenu.
- ▶ Use button  or  to change the settings of the respective function.

The following lists show what settings can be changed within the various menus. Detailed instructions on making individual settings can be found on the following pages.

Instrument cluster submenu

- Selecting speedometer display mode (▷ page 137)
- Selecting language (▷ page 137)
- Selecting standard display (▷ page 137)

Lighting submenu

- Setting daytime running lamp mode (USA only) (▷ page 138)
- Setting locator lighting (▷ page 138)
- Setting night security illumination (Headlamps delayed shut-off feature) (▷ page 139)
- Setting interior lighting delayed shut-off (▷ page 140)

Vehicle submenu

- Setting automatic locking (▷ page 140)

Convenience submenu

- Activating easy-entry/exit feature (▷ page 140)

Instrument cluster submenu

Access the Instr. Cluster submenu via the Settings menu. Use the Instr. Cluster submenu to change the instrument cluster display settings.

The following functions are available:

- Selecting speedometer display mode (▷ page 137)
- Selecting language (▷ page 137)
- Setting standard display (▷ page 137)

Selecting speedometer display mode

- ▶ Move the selection marker with button **+** or **-** to the Instr. Cluster sub-menu.
- ▶ Press button **↕** or **↓** repeatedly until the message **Digital Speedometer** appears in the multifunction display. The selection marker is on the current setting.



- ▶ Press button **+** or **-** to set speedometer unit to Kilometers or Miles.

Selecting language

- ▶ Move the selection marker with button **+** or **-** to the Instr. Cluster sub-menu.
- ▶ Press button **↕** or **↓** repeatedly until the message **Language** appears in the multifunction display. The selection marker is on the current setting.

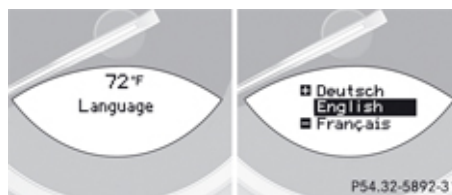

- ▶ Press button **+** or **-** to select the language to be used for the multifunction display messages.

Setting standard display

- ▶ Move the selection marker with button **+** or **-** to the Instr. Cluster sub-menu.
- ▶ Press button **↕** or **↓** repeatedly until the message **Select Display** appears in the multifunction display. The selection marker is on the current setting.

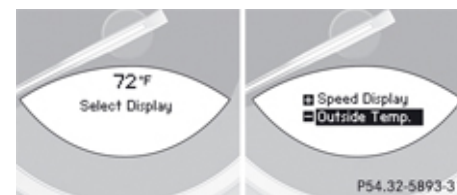

- ▶ Press button **+** or **-** to select the desired setting. The selected display appears in the left multifunction display. The other display now appears in the right multifunction display when scrolling through the **Standard display** menu (▷ page 129).

Control system

Lighting submenu

Access the Lighting submenu via the Settings menu. Use the Lighting submenu to change the lamp and lighting settings on your vehicle.

The following functions are available:

- Setting daytime running lamp mode (USA only) (▷ page 138)
- Setting locator lighting (▷ page 138)
- Setting night security illumination (▷ page 139)
- Setting interior lighting delayed shut-off (▷ page 140)

Setting daytime running lamp mode (USA only)

- ▶ Move the selection marker with button **+** or **-** to the Lighting submenu.
- ▶ Press button **↶** or **↷** repeatedly until the message Light Circuit Headlamp Mode appears in the multifunction display. The selection marker is on the current setting.

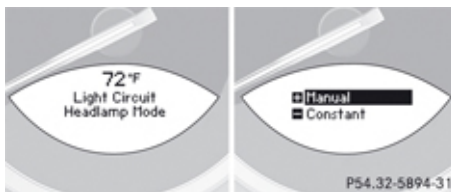

- ▶ Press button **+** or **-** to select manual operation (Manual) or daytime running lamp mode (Constant).

With daytime running lamp mode activated and the exterior lamp switch in position **0** or **AUTO**, the low-beam headlamps are switched on when the engine is running.

In low ambient light conditions the following lamps will come on additionally:

- Parking lamps
- Tail lamps
- License plate lamps
- Side marker lamps

For more information on the daytime running lamp mode, see “Lighting” (▷ page 100).

For safety reasons, resetting all the functions of all submenus to the factory settings while driving (▷ page 135) will not deactivate the daytime running lamp mode.

The following message appears in the multifunction display:

Lighting Cannot be fully reset to factory settings while driving.

Setting locator lighting

With the locator lighting feature activated and the exterior lamp switch in position **AUTO**, the following lamps will come on during darkness when the vehicle is unlocked using button

🔑 on the SmartKey:

- Parking lamps
- Tail lamps
- License plate lamps
- Side marker lamps
- Front fog lamps

The locator lighting goes out when the driver's door is opened.

If you do not open the driver's door after unlocking the vehicle with the SmartKey, the lamps will go out automatically after approximately 40 seconds.

Control system

- ▶ Move the selection marker with button **+** or **-** to the Lighting submenu.
- ▶ Press button **▲** or **▼** repeatedly until the message Locator Lighting appears in the multifunction display.

The selection marker is on the current setting.



- ▶ Press button **+** or **-** to switch the locator lighting function On or Off.
 - ▶ Turn the exterior lamp switch to position **AUTO** when exiting the vehicle.
- The locator lighting feature is activated.

Setting night security illumination (Headlamps delayed shut-off feature)

Use this function to set whether you would like the exterior lamps to remain on for 15 seconds during darkness after exiting the vehicle and closing all doors.

With the headlamps delayed shut-off feature activated and the exterior lamp switch in position **AUTO** before the engine is turned off, the following lamps will come on when the engine is turned off:

- Parking lamps
- Tail lamps
- License plate lamps
- Side marker lamps
- Front fog lamps

If, after turning off the engine, you do not open a door or do not close an opened door, the lamps will automatically go out after 60 seconds.

- ▶ Move the selection marker with button **+** or **-** to the Lighting submenu.
 - ▶ Press button **▲** or **▼** repeatedly until the message Headlamps Delayed Switch-off appears in the multifunction display.
- The selection marker is on the current setting.



- ▶ Press button **+** or **-** to switch the headlamps delayed shut-off feature On or Off.
 - ▶ Turn the exterior lamp switch to position **AUTO** before turning off the engine.
- The headlamps delayed shut-off feature is activated.

You can temporarily deactivate the headlamps delayed shut-off feature:

- ▶ Before exiting the vehicle, turn the Smart-Key in the starter switch to position **0**.
 - ▶ Then turn it to position **2** and back to position **0**.
- The headlamps delayed shut-off feature is deactivated. It will reactivate as soon as you start the engine.

Control system

Setting interior lighting delayed shut-off

Use this function to set whether you would like the interior lighting to remain on for 10 seconds during darkness after you have removed the SmartKey from the starter switch.

- ▶ Move the selection marker with button **+** or **-** to the Lighting submenu.
- ▶ Press button **↶** or **↷** repeatedly until the message Interior Lighting Delayed Switch-off appears in the multifunction display.

The selection marker is on the current setting.



- ▶ Press button **+** or **-** to switch the interior lighting delayed shut-off feature On or Off.

Vehicle submenu

Access the Vehicle submenu via the Settings menu. Use the Vehicle submenu to set the automatic locking.

Setting automatic locking

Use this function to activate or deactivate the automatic central locking. With the automatic central locking system activated, the vehicle is centrally locked at vehicle speeds of approximately 9 mph (15 km/h).

- ▶ Move the selection marker with button **+** or **-** to the Vehicle submenu.
- ▶ Press button **↶** or **↷** repeatedly until the message Automatic Door Lock appears in the multifunction display. The selection marker is on the current setting.



- ▶ Press button **+** or **-** to switch the automatic central locking On or Off.

Convenience submenu

Access the Convenience submenu via the Settings menu. Use the Convenience submenu to activate the easy-entry/exit feature.

Activating easy-entry/exit feature

Use this function to activate and deactivate the easy-entry/exit feature (▷ page 95).

Warning!

You must make sure no one can become trapped or injured by the moving steering wheel when the easy-entry/exit feature is activated.

To stop steering wheel movement, move steering wheel adjustment stalk or press one of the memory position buttons or memory button **M**.

Do not leave children unattended in the vehicle, or with access to an unlocked vehicle. Children could open the driver's door and unintentionally activate the easy-entry/exit feature, which could result in an accident and/or serious personal injury.

- ▶ Move the selection marker with button **+** or **-** to the Convenience sub-menu.
- ▶ Press button **▲** or **▼** repeatedly until the message **Easy-entry Function** appears in the multifunction display. The selection marker is on the current setting.



- ▶ Press button **+** or **-** to switch the easy-entry feature On or Off.

Trip computer menu

Use the **Trip computer** menu to call up statistical data on your vehicle.

The following information is available:

- Fuel consumption statistics since start (▶ page 141)
- Fuel consumption statistics since last reset (▶ page 141)
- Resetting fuel consumption statistics (▶ page 142)
- Distance to empty (▶ page 142)

The last function called up will reappear the next time you enter the trip computer menu.

Fuel consumption statistics since start

- ▶ Press button **☰** or **☷** repeatedly until the first function of the **Trip computer** menu appears in the multifunction display.
- ▶ Press button **▲** or **▼** repeatedly until the message **From Start** appears in the left multifunction display.

Control system

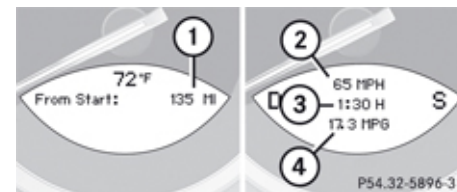

- ① Distance driven since start
- ② Average speed since start
- ③ Time elapsed since start
- ④ Average fuel consumption since start

All statistics stored since the last engine start will be reset approximately 4 hours after the SmartKey in the starter switch is turned to position **0** or removed from the starter switch. Resetting will not occur if you turn the SmartKey back to position **1** or **2** within this time period.

Fuel consumption statistics since last reset

- ▶ Press button **☰** or **☷** repeatedly until the first function of the **Trip computer** menu appears in the multifunction display.
- ▶ Press button **▲** or **▼** repeatedly until the message **From Reset** appears in the left multifunction display.

Control system

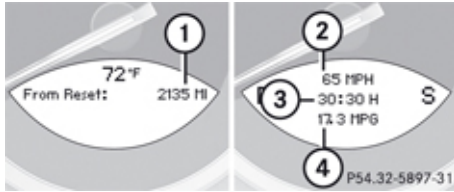

- ① Distance driven since last reset
- ② Average speed since last reset
- ③ Time elapsed since last reset
- ④ Average fuel consumption since last reset

Resetting fuel consumption statistics

- ▶ Press button or repeatedly until the first function of the **Trip computer** menu appears in the multifunction display.
- ▶ Press button or repeatedly until the reading that you want to reset appears in the multifunction display.
- ▶ Press and hold the reset button in the instrument cluster until the respective values are reset to 0.

The fuel consumption statistics reset automatically to 0 after 99 999 miles or 9 999 hours, whichever occurs first.

Distance to empty

- ▶ Press button or repeatedly until the first function of the **Trip computer** menu appears in the multifunction display.
- ▶ Press button or repeatedly until the message Range: appears in the left multifunction display.

The calculated remaining driving range based on the current fuel tank level appears in the right multifunction display. If only very little fuel is left in the tank, a vehicle at the fuel pump is shown instead of the range.

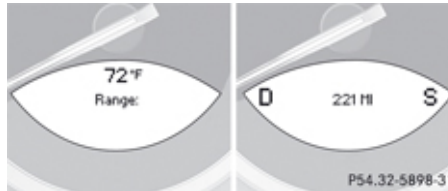

Telephone menu

Warning!

A driver's attention to the road must always be his/her primary focus when driving. For your safety and the safety of others, we recommend that you pull over to a safe location and stop before placing or taking a telephone call. If you choose to use the telephone while driving, please use the hands-free device and only use the telephone when weather, road and traffic conditions permit.



Some jurisdictions prohibit the driver from using a mobile phone while driving a vehicle.

Bear in mind that at a speed of just 30 mph (approximately 50 km/h), your vehicle is covering a distance of 44 feet (approximately 14 m) every second.

Never operate radio transmitters equipped with a built-in or attached antenna (i.e. without being connected to an external antenna) from inside the vehicle while the engine is running. Doing so could lead to a malfunction of the vehicle's electronic system, possibly resulting in an accident and/or personal injury.

Control system

You can connect your telephone via Bluetooth® to the COMAND system, see separate COMAND system operating instructions.

- ▶ Switch on the COMAND system.
See separate COMAND system operating instructions.
- ▶ Press button  or  on the multifunction steering wheel repeatedly until the message TEL appears in the left multifunction display.

One of the following messages will appear in the multifunction display:

- No Service: No network is available.
- Bluetooth Ready: The telephone has not been connected to the COMAND system via Bluetooth® yet.
 - ▶ Connect the telephone to the COMAND system via Bluetooth®.
- Ready or name of the network provider (if available): The telephone has found a network and is ready for use. You can operate it using the control system.

Answering a call

When your telephone is ready to receive calls, you can answer a call at any time. In the right

multifunction display you will then see the message, or if available, the caller ID (number and name):

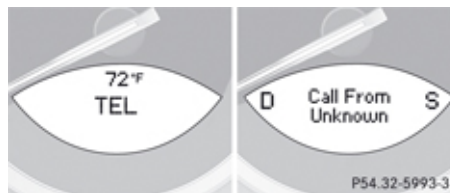



- ▶ Press button .
You have answered the call.

Ending a call or rejecting an incoming call



- ▶ Press button .



Dialing a number from the phone book

If your telephone is ready to receive calls, you may select and dial a number from the phone book. You can add new numbers to the phone book with the telephone, see separate operating instructions.

- ▶ Press button  or  on the multifunction steering wheel repeatedly until the

message TEL appears in the left multifunction display.

- ▶ Press button  or  repeatedly until the desired name appears in the right multifunction display.

If you press and hold button  or  for longer than 1 second, the system scrolls rapidly through the list of names until you release the button again.

The stored names are displayed in ascending or descending alphabetical order.

- ▶ Press button .

The control system dials the selected phone number.

If the connection is successful and this feature is supported by your network provider, the name of the party (if stored in your phone book) you are calling will appear in the multifunction display.

The control system stores the dialed number in the redial memory.

or

- ▶ Press button  if you do not want to make the call.

Driving systems

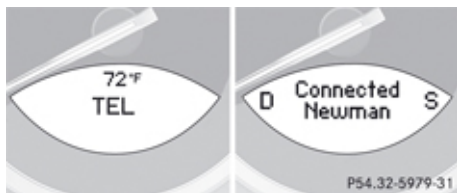

Redialing

The control system stores the most recently dialed phone numbers. This eliminates the need to search through your entire phone book.

▶ Press button or on the multifunction steering wheel repeatedly until the message TEL appears in the left multifunction display.

▶ Press button .

The first number in the redial memory appears in the right multifunction display.

▶ Press button or repeatedly until the desired number or name appears in the multifunction display.

▶ Press button .

The control system dials the selected phone number.

Driving systems

Introduction

This section describes the following driving systems of your vehicle:

- Cruise control and Distronic
- Distance warning function is only available with Distronic
- Active Body Control (ABC)
- Parktronic system
- Hill start assist system (SL 63 AMG)
- RACE START (SL 63 AMG)

The ABS, BAS, ESP® and the electro-hydraulic brake system are described in the “Safety and security” section (▶ page 63).

Cruise control

The cruise control automatically maintains the speed you set for your vehicle.

The use of the cruise control is recommended for driving at a constant speed for extended periods of time.

The currently set speed or last set speed (“Resume” function) appears in the status indicator of the multifunction display:

- USA only: e.g. CC 55 MPH
- Canada only: e.g. 90 Km/h

Warning!

The cruise control is a convenience system designed to assist the driver during vehicle operation. The driver is and must always remain responsible for the vehicle’s speed and for safe brake operation.

Only use the cruise control if the road, traffic, and weather conditions make it advisable to travel at a constant speed.

- The use of the cruise control can be dangerous on winding roads or in heavy traffic because conditions do not allow safe driving at a constant speed.
- The use of the cruise control can be dangerous on slippery roads. Rapid changes

Driving systems

in tire traction can result in wheel spin and loss of control.

- Deactivate the cruise control when driving in fog.

The “Resume” function should only be operated if the driver is fully aware of the previously set speed and wishes to resume this particular preset speed.

Warning!

The cruise control brakes automatically so that the set speed is not exceeded.

Keep in mind that the cruise control is a convenience system designed to assist the driver during vehicle operation. The driver is and must always remain responsible for the vehicle’s speed and for safe brake operation.

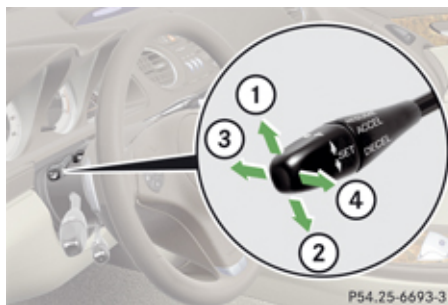

- ① Setting current or higher speed
- ② Setting current or lower speed
- ③ Canceling the cruise control
- ④ Activating the cruise control or resuming to last set speed

Activating cruise control

You can activate the cruise control at vehicle speeds above 20 mph (30 km/h).

You cannot activate the cruise control:

- when you brake
- when you have engaged the parking brake

- when the automatic transmission is in park position **P**, reverse gear **R**, or neutral position **N**
- the ESP® is switched off or has switched off due to a malfunction

The vehicle speed displayed in the speedometer can briefly vary from the speed setting for the cruise control system.

Setting current speed

- ▶ Accelerate or decelerate to the desired speed.
- ▶ Briefly lift the cruise control lever in direction of arrow ① or depress in direction of arrow ②.
- ▶ Remove your foot from the accelerator pedal.

i On uphill grades, the cruise control may not be able to maintain the set speed. Once the grade eases, the set speed will be resumed.

On downhill grades, the cruise control maintains the set speed by braking with the vehicle’s brake system. In addition, on longer downhill grades the automatic transmission will automatically downshift.

Driving systems

Canceling cruise control

- ▶ Depress the brake pedal.

or

- ▶ Briefly push the cruise control lever in direction of arrow ③.

The last set speed is stored for later use.

The last stored set speed is canceled when the engine is turned off.

The cruise control switches off automatically when you depress the brake pedal or you engage the parking brake.

The cruise control also switches off automatically when

- the vehicle speed falls below 20 mph (30 km/h).
- the ESP® is in operation.
- the ESP® is switched off with the ESP® switch.
- the ESP® has switched off due to a malfunction.
- you shift the automatic transmission into neutral position **N** while driving.

An acoustic warning will sound. Observe additional messages in the multifunction display that may appear.

Depressing the accelerator pedal does not deactivate the cruise control. After a brief acceleration (e.g. for passing), the cruise control will resume the last set speed.

Changing the set speed

Warning!

Keep in mind that it may take a brief moment until the vehicle has made the necessary adjustments.

Increase or decrease the set vehicle speed to a value that the prevailing road conditions and legal speed limits permit. Otherwise, sudden and unexpected acceleration or deceleration of the vehicle could cause an accident and/or serious injury to you and others.

When you use the cruise control lever to decelerate, the brake system will automatically brake the vehicle if the engine's braking power does not brake the vehicle sufficiently.

- ▶ Lift the cruise control lever in direction of arrow ① and hold it up to increase, or depress the cruise control lever in direction

of arrow ② and hold it down to decrease, until the desired speed is reached.

- ▶ Release the cruise control lever. The new speed is set and the vehicle will accelerate or decelerate.

Fine adjustment in 1 mph (Canada: 1 km/h) increments

- ▶ Briefly tip the cruise control lever in direction of arrow ① to increase or in direction of arrow ② to decrease.

Resume last stored speed

Warning!

The set speed stored in memory should only be set again if prevailing road conditions and legal speed limits permit. Possible acceleration or deceleration differences arising from returning to the preset speed could cause an accident and/or serious injury to you and others.

- ▶ Briefly pull the cruise control lever in direction of arrow ④.

If no speed is stored, the current speed is set and stored.

- ▶ Remove your foot from the accelerator pedal.

The last stored set speed is canceled when the engine is turned off.

Distronic

Safety notes

When activated, the DISTRONIC adaptive cruise control increases the driving convenience afforded by the cruise control while traveling on expressways and other major roadways.

- If the DISTRONIC distance sensor detects a slower moving vehicle directly ahead, your vehicle speed will be reduced so that you follow that vehicle at your preset following distance.
- If there is no vehicle directly ahead of you, the DISTRONIC will function in the same way as standard cruise control (▷ page 144).

Warning!

The DISTRONIC is a convenience system. Its speed adjustment reduction capability is intended to make cruise control more effective and usable when traffic speeds vary. It is not however, intended to, nor does it, replace the need for extreme care. The responsibility for the vehicle's speed, distance to the preceding vehicle and, most importantly, brake operation to ensure a safe stopping distance, always remains with the driver.

Complex driving situations are not always fully recognized by the DISTRONIC. This could result in wrong or missing distance warnings.

Warning!

The DISTRONIC adaptive cruise control is not a substitute for active driving involvement. It does not react to pedestrians or on stationary objects, nor does it recognize or predict the lane curvature or the movement of preceding vehicles.

The DISTRONIC can only apply 20% of the maximum braking power of the vehicle.

It is the driver's responsibility at all times to be attentive to the road, weather and traffic

conditions. Additionally, the driver must provide the steering, braking and other driving inputs necessary to remain in control of the vehicle.

High-frequency sources such as toll stations, speed measuring systems etc. can cause the DISTRONIC system to malfunction.

Warning!

The DISTRONIC requires familiarity with its operational characteristics. We strongly recommend that you review the following information carefully before operating the system.

Warning!

The DISTRONIC cannot take road and traffic conditions into account. Only use the DISTRONIC if the road, weather and traffic conditions make it advisable to travel at a constant speed.

Warning!

Use of the DISTRONIC can be dangerous on slippery roads. Rapid changes in tire traction can result in wheel spin and loss of control.

The DISTRONIC does not function in adverse sight and distance conditions. Do not use



Driving systems

the Distronic during conditions of fog, heavy rain, snow or sleet.

Warning!

The Distronic cannot take weather conditions into account. Switch off the Distronic or do not switch it on if:

- roads are slippery or covered with snow or ice. The wheels could lose traction while braking or accelerating, and the vehicle could skid.
- the Distronic system sensor cover is dirty or visibility is diminished due to snow, rain or fog, for example. The distance control system functionality could be impaired.

Always pay attention to surrounding traffic conditions even while the Distronic is switched on. Otherwise, you may not be able to recognize dangerous situations until it is too late. This could cause an accident in which you and/or others could be injured.

Warning!

The “Resume” function should only be operated if the driver is fully aware of the

previously set speed and wishes to resume this particular preset speed.

Warning!

Close attention to road and traffic conditions is imperative at all times, regardless of whether or not the Distronic is activated. Use of the Distronic can be dangerous on winding roads or in heavy traffic because conditions do not allow safe driving at a constant speed.

The Distronic will not react to stationary objects in the roadway (e.g. a stopped vehicle in a traffic jam or a disabled vehicle). The Distronic will also not respond to oncoming vehicles.

Switch off the Distronic:

- when changing from the left to the right lane if vehicles are moving more slowly in the left lane
- when entering a turn lane or highway off ramp
- in complex driving situations, such as in highway construction zones

In these situations, the Distronic will continue to maintain the set speed unless deactivated.

The Distronic is designed and intended only to maintain a set speed and keep a set distance from moving objects in front of it.

USA only:

This device has been approved by the FCC as a “Vehicular Radar System”. The radar sensor is intended for use in an automotive radar system only. Removal, tampering, or altering of the device will void any warranties, and is not permitted by the FCC. Do not tamper with, alter, or use in any non-approved way.

Any unauthorized modification to this device could void the user’s authority to operate the equipment.

Canada only:

This device complies with RSS-210 of Industry Canada. Operation is subject to the following two conditions:

1. This device may not cause interference, and
2. this device must accept any interference received, including interference that may cause undesired operation of the device.

Removal, tampering, or altering of the device will void any warranties, and is not permitted. Do not tamper with, alter, or use in any non-approved way.

Any unauthorized modification to this device could void the user's authority to operate the equipment.

Distrionic displays in the speedometer



- ① Red distance warning lamp
- ② Set speed

If the Distrionic is activated, the set speed ② and distance warning lamp ① appear in the speedometer.

The vehicle speed displayed on the speedometer can briefly vary from the speed setting on the Distrionic system.

If the Distrionic detects a vehicle directly ahead, the Distrionic indicator lamp  in the speedometer dial comes on white.

If the Distrionic calculates that there is a danger of collision, the distance warning lamp  in the speedometer comes on red and an intermittent warning sounds.

- ▶ Immediately apply the brakes to avoid a collision.

Under no circumstances should the driver await the intermittent warning sound before braking.

The intermittent warning sound ceases and the red distance warning lamp  goes out when the necessary distance to the vehicle ahead is established again.

Warning!

An intermittent warning sounds and the distance warning lamp (red)  in the speedometer dial is illuminated if the Distrionic system calculates that the distance

to the vehicle ahead and your vehicle's current speed indicate that the Distrionic will not be capable of slowing the vehicle sufficiently to maintain the preset following distance, which creates a danger of a collision. Immediately brake the vehicle to increase your distance to the preceding vehicle. The warning sound is intended as a final caution in which you should intercede with your own braking inputs to avoid a potentially dangerous situation. Do not wait for the operation of the warning signal to intercede with your own braking. This will result in potentially dangerous emergency braking which will not always result in an impact being avoided.

Tailgating increases the risk of an accident.

Warning!

The Distrionic brakes your vehicle with a maximum deceleration of 6.5 ft/s² (2 m/s²). This corresponds to approximately 20% of the maximum deceleration of your vehicle.

The Distrionic brakes the vehicle in an effort to restore the preset distance or to maintain the set speed.



Driving systems

Distronic menu in the control system

The information shown in the multifunction display depends on whether the DISTRONIC system and/or the distance warning function are activated or deactivated.

i To activate or deactivate the DISTRONIC system, see (> page 150) or see (> page 152).

To activate or deactivate the Distance warning function, see (> page 156).

▶ Press button  or  repeatedly until one of the following two displays appears in the multifunction display.

Distronic deactivated

When the DISTRONIC is deactivated, you will see the standard display in the left multifunction display.

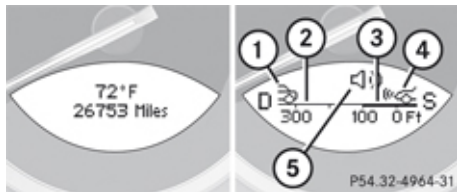

- ① Preceding vehicle, if detected
- ② Actual distance to the preceding vehicle

- ③ Preset distance threshold to the preceding vehicle
- ④ Your vehicle
- ⑤ Symbol for activated distance warning function (> page 155)

Distronic activated

When the DISTRONIC is activated, the DTR symbol and the set speed appear in the left multifunction display.

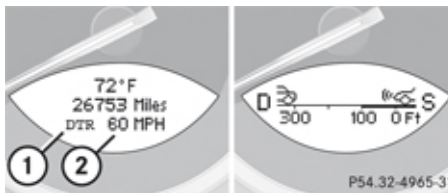

- ① DISTRONIC activated
- ② Set vehicle speed

Cruise control lever

The DISTRONIC system is operated by means of the cruise control lever.

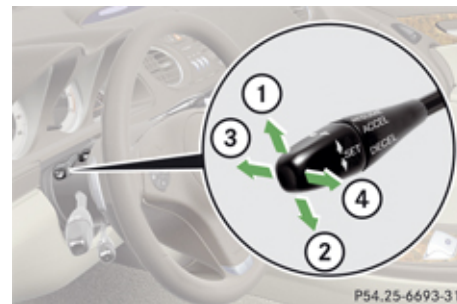

- ① Setting current or higher speed
- ② Setting current or lower speed
- ③ Deactivating the DISTRONIC
- ④ Activating the DISTRONIC, resuming to the last set speed or increasing speed in 1 mph (Canada: 1 km/h) increments

Activating DISTRONIC

You can activate the DISTRONIC when the vehicle speed is between 20 mph (30 km/h) and 110 mph (180 km/h).

When the DISTRONIC is activated, the left multifunction display will show a message such as DTR 55 MPH (Canada: DTR 90 Km/h).

If the DISTRONIC is not activated after the cruise control lever is pulled in direction of arrow ④ (> page 150), you will see the mes-

sage DTR --- MPH (Canada: DTR --- Km/h) in the left multifunction display.

In the following cases you cannot activate the DISTRONIC:

- up to 2 minutes after starting the engine
- when you brake
- when you have engaged the parking brake
- when the automatic transmission is in park position **P**, reverse gear **R**, or neutral position **N**
- when the ESP® is switched off or has switched off due to a malfunction



- ① White DISTRONIC indicator lamp 
- ② Set speed

The vehicle speed displayed on the speedometer can briefly vary from the speed setting on the DISTRONIC system.

Setting the current speed

- ▶ Accelerate or decelerate to the desired speed.
- ▶ Briefly lift the cruise control lever in direction of arrow ① or depress in direction of arrow ② (▷ page 150).
- ▶ Remove your foot from the accelerator pedal.

i If you do not take your foot off of the accelerator pedal and continue to accelerate past the set speed, the following message will appear in the multifunction display:

DTR Override

The distance to a slower moving vehicle in front of you will not be set. Your vehicle speed will then be determined only by the accelerator pedal position.

Setting a higher speed

Warning!

Keep in mind that it may take a brief moment until the vehicle has made the necessary adjustments.

Driving systems

Increase the set vehicle speed to a value that the prevailing road conditions and legal speed limits permit. Otherwise, sudden and unexpected acceleration of the vehicle could cause an accident and/or serious injury to you and others.

You can increase the set speed in two ways.

Adjustment in 5 mph (Canada: 10 km/h) increments

- ▶ Briefly lift the cruise control lever up in direction of arrow ① (▷ page 150).

The new speed is set and the vehicle will accelerate. Keep in mind that it may take a brief moment until the vehicle has reached the set speed.

Fine adjustment in 1 mph (Canada: 1 km/h) increments

- ▶ Briefly pull the cruise control lever in direction of arrow ④ (▷ page 150).

Setting a lower speed

Warning!

Keep in mind that it may take a brief moment until the vehicle has made the necessary adjustments.

Decrease the set vehicle speed to a value that the prevailing road conditions and legal speed limits permit. Otherwise, sudden and unexpected deceleration of the vehicle could cause an accident and/or serious injury to you and others.

-  When you use the cruise control lever to decelerate, the brake system will automatically brake the vehicle if the engine's braking power does not brake the vehicle sufficiently.

Adjustment in 5 mph (Canada: 10 km/h) increments

- ▶ Briefly press the cruise control lever down in direction of arrow ② (▷ page 150).

The new speed is set and the vehicle will decelerate. Keep in mind that it may take a brief moment until the vehicle has reached the set speed.

Setting stored speed (Resume function)

Warning!

The set speed stored in memory should only be set again if prevailing road conditions and legal speed limits permit. Possi-

ble acceleration or deceleration differences arising from returning to the preset speed could cause an accident and/or serious injury to you and others.

- ▶ Briefly pull the cruise control lever in direction of arrow ④ (▷ page 150).
If no speed is stored, the current speed is set and stored.
- ▶ Remove your foot from the accelerator pedal.

Deactivating Distronic

- ▶ Depress the brake pedal.

or

- ▶ Briefly push the cruise control lever in direction of arrow ③ (▷ page 150).

The following message appears briefly in the multifunction display: DTR Off

The last set speed is stored for later use.

The last stored set speed is deleted when the engine is turned off.

The Distronic switches off automatically when you depress the brake pedal or you engage the parking brake.

The Distronic switches off automatically and an acoustic warning will sound when

- the vehicle speed falls below 20 mph (30 km/h).
- the ESP® is in operation.
- the ESP® is switched off with the ESP® switch.
- the ESP® has switched off due to a malfunction.
- you shift the automatic transmission into neutral position **N** while driving.

Observe additional messages in the multifunction display that may appear.

Warning!

Distronic switches off and releases the brakes when the vehicle decelerates below the minimum speed of 20 mph (30 km/h) by operation of the system. At that time the driver must apply the brakes in order to reduce vehicle speed further or bring it to a stop.

Depressing the accelerator pedal does not deactivate the Distronic. After a brief acceleration (e.g. for passing), the Distronic will resume the last set speed.

Setting the following distance in Distronic

You can set the specified following distance for Distronic by varying the time setting between 1.0 and 2.0 seconds. Using this time setting and the current speed of your vehicle, Distronic calculates and sets the required following distance to the preceding vehicle.

The set distance will be shown in the right multifunction display.

Warning!

It is up to the driver to exercise discretion to select the appropriate setting given road conditions, traffic, driver's preferred driving style and applicable laws and driving recommendations for safe following distance.



Example illustration (except SL 63 AMG)

① Thumbwheel for setting distance

SL 63 AMG:

The thumbwheel for adjusting the following distance is located on the right side of the center console.

► **Increasing distance:** Turn thumbwheel

① towards .

Increasing the distance setting tells Distronic to maintain a greater following distance to the preceding vehicle.

► **Decreasing distance:** Turn thumbwheel

① towards .

Decreasing the distance setting tells Distronic to maintain a shorter following distance to the preceding vehicle.

Driving systems

Driving with Distronic

This section describes a number of driving situations where special precaution is required on the part of the driver. Be prepared to brake in such situations. Braking will deactivate the Distronic system.

Warning!

Distronic works to maintain the speed selected by the driver unless a moving obstacle proceeding directly ahead of it in the same travel direction is detected (e.g. following another vehicle ahead of you at your set distance).

This means that:

- Your vehicle can pass another vehicle after you have changed lanes.
- While in a sharp turn or if the preceding vehicle is in a sharp turn, Distronic could lose sight of the preceding vehicle. Your vehicle could then accelerate to the previously selected speed.

Distronic regulates only the distance between your vehicle and those directly ahead of it, but does not register stationary objects in the road, e.g.:

- a stopped vehicle in a traffic jam
- a disabled vehicle
- an oncoming vehicle

The driver must always be alert, observe all traffic and intercede as required by means of steering or braking the vehicle.

Warning!

Distronic should not be used in snowy or icy road conditions.

The most likely cause for a malfunctioning system is a dirty Distronic system sensor cover (located in the hood grille), especially at times of snow and ice or heavy rain.

In such a case, Distronic will switch off, and the message **DISTRONIC Currently Unavailable - See Oper. Manual** appears in the multifunction display.

For cleaning and care of the Distronic system sensor cover, see (> page 246).

- i** If the message **DISTRONIC Currently Unavailable - See Oper. Manual** dis-

appears during driving, the dirt (e.g. slush) has dissolved. Distronic is available again if you reactivate it (> page 150).

Turns and bends

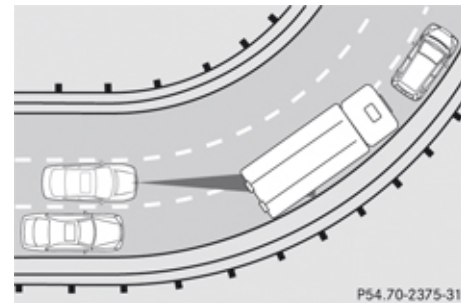

In turns or bends, Distronic may not detect a moving vehicle in front, or it may detect one too soon. This may cause your vehicle to brake late or unexpectedly.

Offset driving

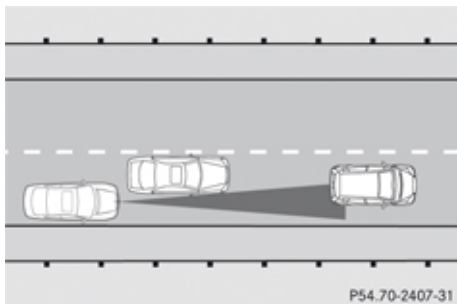

P54.70-2407-31

A vehicle traveling in your lane but offset from your direct line of travel may not be detected by DISTRONIC. There will be insufficient distance to the preceding vehicle.

Lane changing

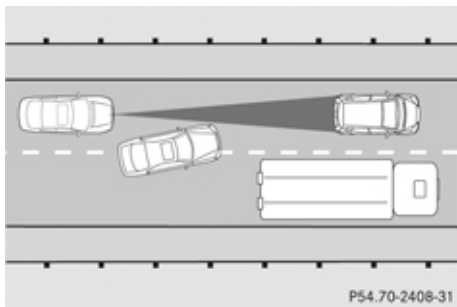

P54.70-2408-31

DISTRONIC has not yet detected the vehicle changing lanes. There will be insufficient distance to the lane-changing vehicle.

Narrow vehicles

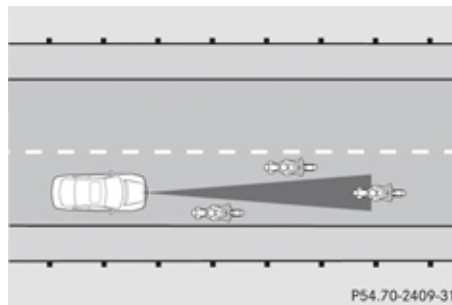

P54.70-2409-31

Because of their narrow profile, the vehicles traveling near the outer edges of the lane have not yet been detected by DISTRONIC. There will be insufficient distance to the preceding vehicles.

Distance warning function

When the DISTRONIC is deactivated, this function will continue to warn you when recognizing a stationary obstacle or a slower vehicle moving in your vehicle's path and the danger of a collision exists:

- The distance warning lamp  in the speedometer comes on red.
- An intermittent warning will sound if necessary.

If these warnings are issued, you must brake manually to maintain a safe distance and avoid a collision with the preceding vehicle.

When depressing the brake pedal, the warning sound ceases. The warning sound will also cease when the distance to the preceding vehicle is sufficient again without applying the brakes. In this case, the distance warning lamp  will also go out.

Warning!

If the distance warning lamp (red)  in the speedometer comes on while driving and/or an intermittent warning sounds, immediate attention on the part of the driver is required. As required by the traffic situation, apply the brakes and navigate around a possible obstacle. However, do



Driving systems

not drive by relying on the distance warning function, as this will result in an emergency braking application. This will not always enable you to avoid a collision, especially when traveling on varying road surface conditions and with varying driver reaction.

Complex driving situations are not always fully recognized by the distance warning function. This could result in wrong or missing distance warnings.

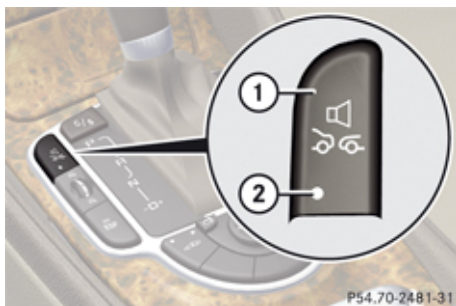

Example illustration (except SL 63 AMG)

- ① Distance warning function on/off switch
- ② Indicator lamp

SL 63 AMG:

The distance warning function on/off switch is located on the right side of the center console.

- ▶ **Activating/deactivating:** Press switch ①.

When the distance warning function is activated, indicator lamp ② in switch ① comes on. A loudspeaker symbol appears in the right multifunction display (▷ page 150).

RACE START (SL 63 AMG)

RACE START enables optimum acceleration from a standing start with suitable high-grip road surface conditions.

⚠ Warning!

RACE START is only available when the ESP® SPORT mode is switched on. ESP® SPORT stabilizes the vehicle only to a limited extent if the vehicle starts to skid or when a wheel is spinning.

RACE START should be used only on closed tracks. Always adapt your speed and driving to the prevailing road and weather conditions.

Conditions for activation

RACE START can be activated when

- the doors are closed
- the engine is running and has reached its operating temperature of approximately 80 °C. This is the case when the engine oil temperature indicator in the multifunction display stops flashing.
- ESP® SPORT is switched on (▷ page 67)
- the multifunction steering wheel is in the straight-ahead position
- the vehicle is standing still and the brake pedal is depressed (left foot)
- the automatic transmission is in drive position **D**

Activating RACE START

- ▶ Depress the brake pedal with your left foot and keep it depressed.
- ▶ Turn the program mode selector dial counterclockwise (▷ page 118) until the **RS** lamp on the dial comes on.

The message RACE START Cancel: Pad-
dle DOWN appears in left multifunction display and the message RACE START Con-

firm: Paddle UP appears in the right multifunction display.

- ▶ To cancel: Pull left steering wheel gearshift control (▷ page 120).

or

- ▶ To confirm: Pull right steering wheel gearshift control (▷ page 120).

The message RACE START appears in left multifunction display and the message Available Depress Gas Pedal appears in the right multifunction display.

- ▶ Depress the accelerator pedal fully.

The engine speed rises to approximately 4000 rpm.

The message RACE START appears in left multifunction display and the message Release Brake To Start appears in the right multifunction display.

- ▶ Take your foot off the brake pedal while keeping the accelerator pedal depressed. The vehicle pulls away at maximum acceleration.

The message RACE START appears in left multifunction display and the message Active appears in the right multifunction display.

RACE START deactivates at a vehicle speed of approximately 50 km/h. The automatic transmission switches to program mode **S+**. ESP® SPORT remains switched on.

- ❗ If RACE START is used repeatedly in a short period of time, it is only available again after having driven the vehicle a certain distance.

Hill start assist system

Warning!

The hill start assist system is not designed to function as a parking brake and does not prevent the vehicle from moving when parked on an incline.

Always engage the parking brake in addition to shifting the automatic transmission into park position **P**.

On uphill grades with a gradient angle of more than 5°, the hill start assist system maintains the pressure in the brake system for approximately 1 second after you have released the brake pedal. Therefore, you can start off smoothly without the vehicle moving immediately after releasing the brake pedal.

- ▶ Depress the brake pedal.
- ▶ Shift the automatic transmission into drive position **D** or reverse gear **R**.
- ▶ Release the brake pedal.
- ▶ Carefully depress the accelerator pedal.

The hill start assist system is inactive

- when starting off on a level road or downhill grades
- with the automatic transmission in neutral position **N**
- with the parking brake engaged
- if the ESP® has switched off due to a malfunction

Active Body Control (ABC)

The ABC system is an active, computer-controlled system that hydraulically adjusts the suspension at all four wheels in response to various driving situations. It automatically selects the optimum suspension tuning and ride height for your vehicle.

Driving systems

Vehicle level control

Warning!

To help avoid personal injury, keep hands and feet away from wheel housing area, and stay away from under the vehicle when lowering the vehicle chassis.

Your vehicle adjusts its ride height automatically to increase vehicle safety and to reduce fuel consumption.

The vehicle chassis ride height is raised or lowered according to the selected level setting and to the vehicle speed. With increasing speed, the ride height is reduced by up to approximately 0.5 in (12 mm). With decreasing speed, the ride height is again raised to the selected vehicle level.

These height adjustments are so small that you may not notice any change.

The following vehicle level settings can be selected when the vehicle is stationary:

Level	Use for	Indicator lamps
Normal	For driving on normal roads.	Both lamps off
Level 1	For driving on rough roads or with snow chains (▷ page 234).	One lamp on
Level 2	For driving on very rough road surface conditions.	Both lamps on

Select the level 1 and level 2 settings only when required by current driving conditions. Otherwise the fuel consumption may increase and/or the handling may be impaired.

- ① The selected vehicle level setting remains stored in memory, even when the engine is turned off and restarted.

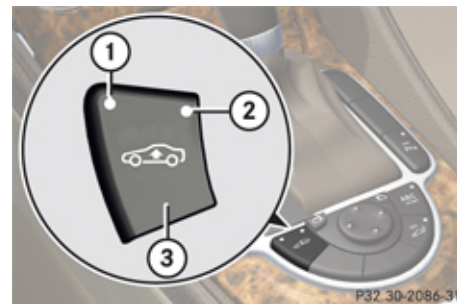

- ① Indicator lamp
- ② Indicator lamp
- ③ Vehicle level control button

- ▶ Start the engine.
- ▶ Press button ③ briefly to change from one level setting to the next.
 - The normal level is selected if both indicator lamps are off.
 - At level 1, indicator lamp ① is on.
 - At level 2, both indicator lamps ① and ② are on.

When the vehicle is at level 2, pressing button ③ will return the vehicle to normal level.

- i** Pressing button ③ twice in quick succession will cause the vehicle to immediately raise or lower to the new vehicle level as selected.

Suspension tuning

The suspension tuning is set according to:

- your driving style
- road surface conditions
- the vehicle loading
- your choice of suspension style

You can set the following suspension styles:

- Regular (Comfort)
- Sporty

- i** The selected setting is stored, even when the engine is turned off.

Setting suspension tuning (except SL 63 AMG)



- ① ABC suspension tuning button
② Indicator lamp

- ▶ Start the engine.

Suspension for sporty driving style

The setting for sporty driving is selected when the indicator lamp ② is on.

- ▶ Press button ①.
Indicator lamp ② comes on.

Suspension for regular driving style

The setting for regular driving is selected when the indicator lamp ② is off.

- ▶ Press button ①.
Indicator lamp ② goes out.

SL 65 AMG: You can display the current settings in the **AMG SETUP** menu (▷ page 130).

Setting suspension tuning SL 63 AMG

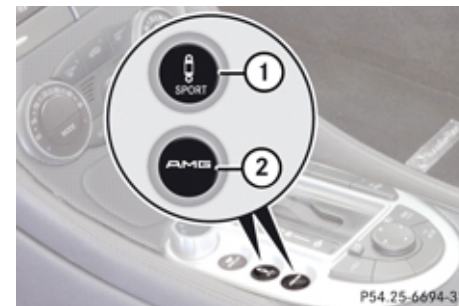

- ① ABC suspension tuning button
② AMG button

- ▶ Start the engine.

Suspension for sporty driving style

The suspension tuning for a sporty driving style is selected when button ① comes on in red.

- ▶ Press button ①.
Button ① comes on in red.

Driving systems

Suspension for regular driving style

The suspension tuning for a regular driving style is selected when button ① is not on in red.

- ▶ Press button ①.

The red illumination on button ① goes out.

When you have selected the suspension tuning and the program mode (▷ page 118), you can store, call up, and display the settings using AMG button ② when the engine is running. Pressing AMG button ② when the ignition is switched on, displays the current settings only.

You can also call up the settings via the control system (▷ page 130)

- ▶ **Storing:** Press and hold AMG button ② until an acoustic signal sounds.

The current setting is stored and appears in the multifunction display.

- ▶ **Calling up and displaying:** Press AMG button ②.

The stores suspension tuning and program mode are in effect and the settings appear in the multifunction display.

- ▶ **Displaying:** Tap AMG button ②.

The stored and/or currently active settings appear in the multifunction display.

Parktronic system (Parking assist)

The Parktronic system is an electronic parking aid with ultrasonic sensors designed to assist the driver during parking maneuvers. It visually and audibly indicates the relative distance between the vehicle and an obstacle.

The Parktronic system is automatically activated when you switch on the ignition, release the parking brake, and the automatic transmission is in drive position **D**, reverse gear **R**, or neutral position **N**.

The Parktronic system deactivates at speeds over approximately 11 mph (18 km/h). At lower speeds the Parktronic system turns on again.

The Parktronic system also deactivates when you shift the automatic transmission into park position **P** or engage the parking brake.

The Parktronic system monitors the surroundings of your vehicle with six sensors in the front bumper and four sensors in the rear bumper.

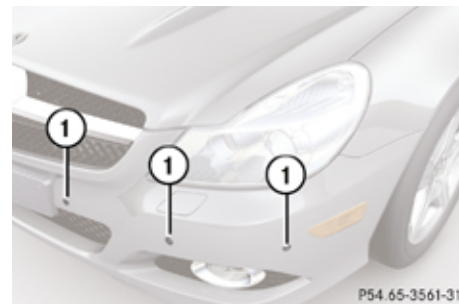

- ① Sensors in the front bumper

To function properly, the sensors must be free of dirt, ice, snow and slush. Clean the sensors regularly, being careful not to scratch or damage the sensors, see “Cleaning the Parktronic system sensors” (▷ page 247).

Warning!

The Parktronic is a supplemental system. It is not intended to, nor does it replace, the need for extreme care. The responsibility during parking and other critical maneuvers always remains with the driver.

Warning!

Make sure no persons or animals are in the area in which you are maneuvering. You could otherwise injure them.

! Special attention must be paid to objects with smooth surfaces or low silhouettes (e.g. trailer couplings, painted posts, elevated crossbars or road curbs). Such objects may not be detected by the system and can damage the vehicle.

During parking maneuvers, pay special attention to objects located above or below the height of the sensors (e.g. street curbs, painted posts, or trailer hitches etc.). The Parktronic system will not detect such objects at close range and damage to your vehicle or the object may result.

! Ultrasonic signals from outside sources (e.g. truck air brakes, car wash, or jackhammers) may impair the operation of the Parktronic system.

Range of the sensors

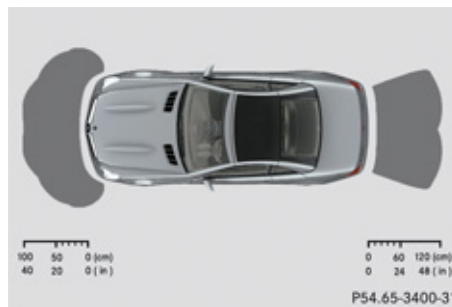
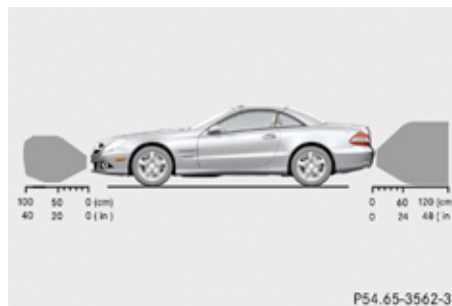

Front sensors

Center	approx. 40 in (100 cm)
Corners	approx. 24 in (60 cm)

Rear sensors

Center	approx. 48 in (120 cm)
Corners	approx. 32 in (80 cm)

Minimum distance

Center	approx. 8 in (20 cm)
Corners	approx. 6 in (15 cm)

If the Parktronic system detects an obstacle in this range, all the distance warning segments illuminate and you hear a warning signal. If the obstacle is closer than the minimum distance, the actual distance may no longer be indicated by the Parktronic system.

Warning indicators

Visual signals indicate to the driver the relative distance between the sensors and an obstacle.



Driving systems



Front area warning indicator

- ① Left side of the vehicle
- ② Right side of the vehicle

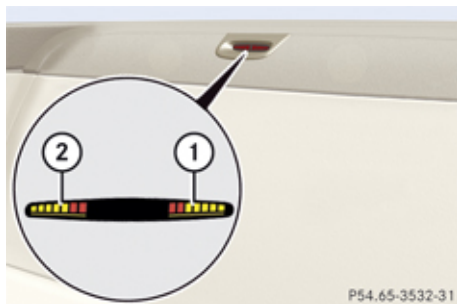

Rear area warning indicator

- ① Left side of the vehicle
- ② Right side of the vehicle

Each warning indicator is divided into six yellow and two red distance segments for either side of the vehicle. The Parktronic system is ready to measure when the border around the indicator is illuminated.

The current transmission position determines which warning indicator will be activated.

Current transmission position	Warning indicator
D	Front area activated
R or N	Front and rear area activated

As your vehicle approaches an object, one or more distance segments will illuminate, depending on the distance. When the eighth distance segment illuminates, you have reached the minimum distance.

- **Front area:** An intermittent acoustic warning will sound as the first red distance segment illuminates and a constant acoustic warning lasting a maximum of 2 seconds will sound for the second red distance segment. The signal is canceled when the auto-

matic transmission is shifted into park position **P** or the parking brake is engaged.

- **Rear area:** An intermittent acoustic warning will sound when the first distance segment illuminates. This signal quickens with each additional distance segment lit. When the eighth distance segment illuminates, the acoustic warning becomes a constant signal. The signal is canceled when the automatic transmission is shifted into drive position **D**, or park position **P**, or the parking brake is engaged.

Switching the Parktronic system on/off

The Parktronic system is automatically switched on when the ignition is switched on.



- ① Parktronic switch
- ② Indicator lamp

- ▶ **Switching off Parktronic system:** Press Parktronic switch ①. Indicator lamp ② comes on.
- ▶ **Switching on Parktronic system:** Press Parktronic switch ① again.

Parktronic system malfunction

There is a malfunction in the Parktronic system, if only the red distance segments illuminate and an acoustic warning sounds. The Parktronic system will automatically switch off after 20 seconds and the indicator lamp ② in the Parktronic switch ① comes on.

- ▶ Have the Parktronic system checked at an authorized Mercedes-Benz Center as soon as possible.

If only the red distance segments illuminate and no acoustic warning sounds, the Parktronic system sensors are dirty (e.g. dirt, ice, snow and slush) or there is an interference from other radio or ultrasonic signals (e.g. truck air brakes, car wash, or jackhammers). The Parktronic system will automatically switch off after 20 seconds and the indicator lamp in the Parktronic switch comes on.

- ▶ Switch off the ignition.
- ▶ Clean the Parktronic system sensors (▷ page 247).
- ▶ Switch on the ignition.
or
- ▶ Check the Parktronic system operation at another location to rule out interference from outside radio or ultrasonic signals.

Climate control system

Climate control system





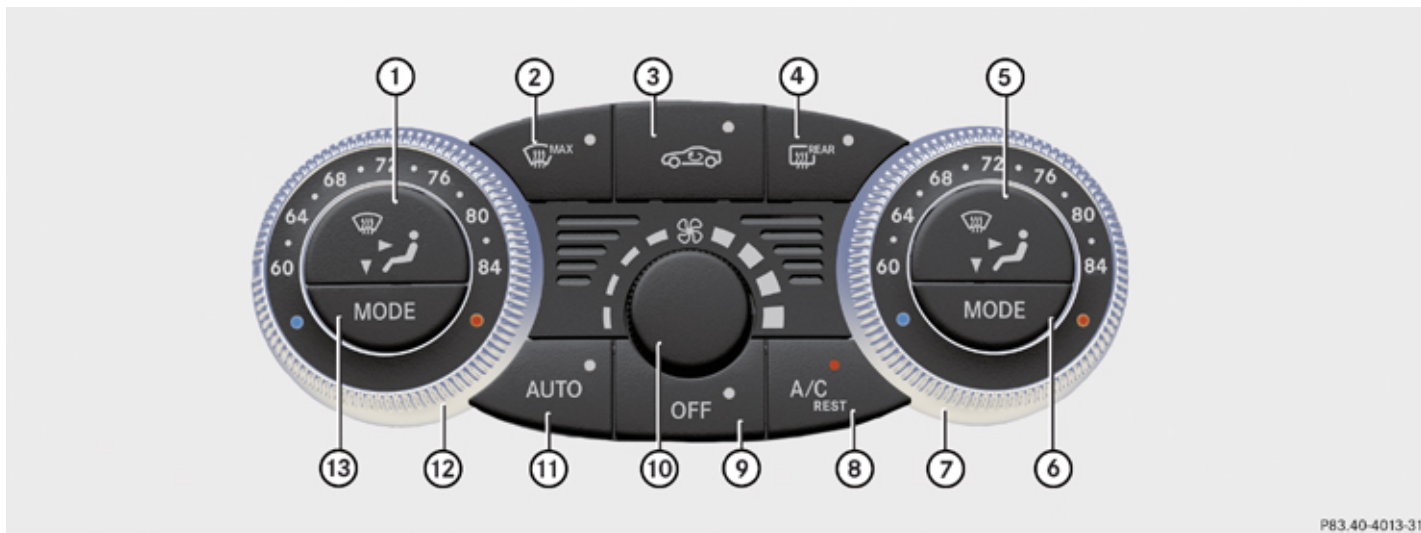

Control panels

Automatic climate control



P83.40-4013-31

Climate control system

	Function	Recommendation/Notes	
①	Air distribution display, driver's side		
②	 MAX Front defroster	i Keep this setting selected only until the windshield or the side windows are clear again.	(▷ page 171)
③	 Air recirculation	i Only use this function for a short time, e.g. in a tunnel. Otherwise, the windows can fog up due to lack of fresh air.	(▷ page 172)
④	 REAR Rear window defroster	i At very low temperatures, rear window defroster operation is delayed until the vehicle interior has warmed up.	(▷ page 173)
⑤	Air distribution display, passenger side		
⑥	MODE Air distribution, passenger side		(▷ page 170)
⑦	Temperature control, passenger side	i Set the temperature to 72°F (22°C).	(▷ page 168)
⑧	 A/C REST AC cooling on/off	i Switch on the air conditioning. The indicator lamp in button  comes on.	(▷ page 167)
	 A/C REST Residual heat/ventilation	i With the engine turned off, it is possible to continue to heat or ventilate the interior.	(▷ page 172)
⑨	OFF Climate control on/off	i Switch on the climate control system. The indicator lamp in button OFF goes out.	(▷ page 167)



Climate control system

	Function	Recommendation/Notes	
⑩	 Air volume control		(▷ page 171)
⑪	AUTO Air distribution and air volume (automatic mode)	i Switch on the automatic mode. The indicator lamp in button AUTO comes on.	(▷ page 168)
⑫	Temperature control, driver's side	i Set the temperature to 72°F (22°C).	(▷ page 168)
⑬	MODE Air distribution, driver's side		(▷ page 170)

Notes on climate control system

The climate control system is operational whenever the engine is running. You can operate the climate control system in either the automatic or manual mode. The system cools or heats the interior depending on the selected interior temperature and the current outside temperature.

It can only function optimally when you are driving with the windows and the retractable hardtop closed.

Nearly all dust particles, pollutants and odors are filtered out before outside air enters the passenger compartment through the air distribution system.

Warning!

Severe conditions (e.g. strong air pollution) may require replacement of the filter before its scheduled replacement interval. A clogged filter will reduce the air volume to the interior and the windows could fog up, impairing visibility and endangering you and others. Have a clogged filter replaced as soon as possible at an authorized Mercedes-Benz Center.

The air conditioning will not engage (no cooling) if the **A/C** mode (▷ page 167) is deactivated.

Warning!

Follow the recommended settings for heating and cooling given on the following

pages. Otherwise the windows could fog up, impairing visibility and endangering you and others.

Keep the air intake grille in front of the windshield free of snow and debris.

When the retractable hardtop is closed, do not obstruct air flow by placing objects on the air flow-through exhaust slots below the rear window.

i If the vehicle interior is hot, ventilate the interior before driving off. The climate control will then adjust the interior temperature to the set value much faster.

Climate control system

Deactivating the climate control system**⚠ Warning!**

When the climate control is switched off, the outside air supply and circulation are also switched off. Only choose this setting for a short time when the retractable hard-top is closed. Otherwise the windows could fog up, impairing visibility and endangering you and others.

- ▶ **Deactivating:** Press button **OFF**.
The indicator lamp in the button comes on.
 - ▶ **Reactivating:** Press button **OFF** again.
The indicator lamp in the button goes out. The previous settings are once again in effect.
- or
- ▶ Turn temperature controls ⑦ or ⑫ (> page 164) clockwise or counterclockwise.
The indicator lamp in button **OFF** goes out.

or

- ▶ Press button **AUTO**.
The indicator lamp in button **AUTO** comes on. The air volume and air distribution are adjusted automatically.
- or
- ▶ Press button **MAX**.
The indicator lamp in button **OFF** goes out.

Air conditioning

The air conditioning is operational while the engine is running and cools the interior air to the temperature set by the operator. In addition, the air conditioning dehumidifies the interior air and helps prevent window fogging.

⚠ Warning!

If you switch off the cooling function, the vehicle will not be cooled when weather conditions are warm. The windows can fog up more quickly. Window fogging may impair visibility and endanger you and others.

- ▶ **i** Condensation may drip out from underneath the vehicle. This is normal and not an indication of a malfunction.

Deactivating

It is possible to deactivate the cooling function of the climate control system. The interior air will then no longer be cooled or dehumidified.

- ▶ Press button **A/C REST**.
The indicator lamp in the button goes out. The cooling function switches off after a short delay.

Activating

Moist air can fog up the windows. You can dehumidify the interior air with the air conditioning.

- ▶ Press button **A/C REST** again.
The indicator lamp in the button comes on.
- The air conditioning uses the refrigerant R134A. This refrigerant is free of CFCs which are harmful to the ozone layer.

Climate control system

Automatic mode

Air distribution and air volume can be adjusted automatically by the climate control system. You can also adjust the settings for air distribution and air volume manually.

When operating the climate control system in automatic mode, the interior air temperature, air volume and air distribution are adjusted automatically.

In automatic mode, cooling with dehumidification is switched on. This function can be switched off if necessary.

Warning!

If you switch off the cooling function, the vehicle will not be cooled when weather conditions are warm. The windows can fog up more quickly. Window fogging may impair visibility and endanger you and others.

▶ **Activating:** Press button .

The indicator lamp in the button comes on. The air volume and air distribution are adjusted automatically.

▶ **Deactivating:** Press button .

The indicator lamp in the button goes out. The blower will run at speed setting **3**. The

air flows through the center and side air vents.

or

▶ Press one button .

The indicator lamp in button  goes out. The climate control settings for the respective side of the passenger compartment is adjusted manually.

or

▶ Turn air volume control clockwise or counterclockwise.

The indicator lamp in button  goes out. Automatic air volume is switched off and is controlled according to the desired position. The automatic air distribution remains switched on.

Setting the temperature

You can adjust the air temperature on each side of the passenger compartment. You should raise or lower the temperature setting in small increments, preferably starting at 72°F (22°C).

▶ **Increasing/decreasing:** Turn temperature control and/or (▷ page 164) slightly clockwise or counterclockwise.

Adjusting air vents

Warning!

When operating the climate control, the air that enters the passenger compartment through the air vents can be very hot or very cold (depending on the set temperature). This may cause burns or frostbite to unprotected skin in the immediate area of the air vents.

Always keep sufficient distance between unprotected parts of the body and the air vents. If necessary, use the air distribution adjustment to direct the air to air vents in the vehicle interior that are not in the immediate area of unprotected skin.

Climate control system

Please comply with the following instructions in order for the climate control to function optimally:

- ▶ Keep the air intake grille in front of the windshield free of snow, leaves, sticks, and any other debris.
 - ▶ Always keep all air vents and grilles in the passenger compartment free from obstruction.
- i** For draft-free ventilation, move the adjustable center and side air vents to the middle position.

Center air vents

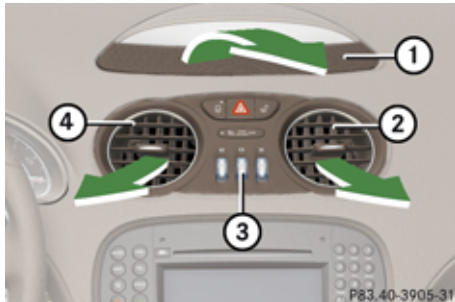

- ① Cockpit air vent, fixed
- ② Right center air vent, adjustable

- ③ Thumbwheel for air volume control for center air vents
- ④ Left center air vent, adjustable

▶ **Opening/closing adjustable center air vents:** Turn thumbwheel ③ upward to the first stop or downward.

Center air vents ② and ④ are open or closed.

▶ **Opening/closing cockpit air vent:** Turn thumbwheel ③ upward all the way or downward.

Cockpit air vent ① is open or closed.

Side air vents

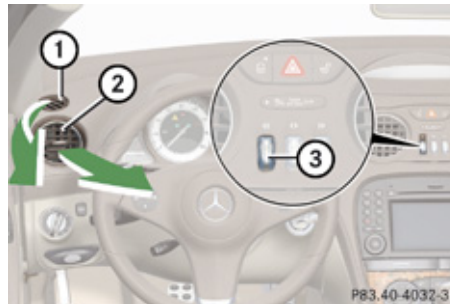

- Example illustration driver's side
- ① Left side defroster air vent, fixed

- ② Left side air vent, adjustable
- ③ Thumbwheel for air volume control for adjustable left side air vent

▶ **Opening/closing:** Turn thumbwheel ③ upward or downward.

Ventilated glove box

The glove box can be ventilated, for instance to cool its contents, when the automatic climate control system is activated. The level of airflow to the glove box depends on the airflow and air distribution settings. The temperature of the air is approximately the same as that of the air flowing from the center air vents.

! Close the glove box air vent when heating the vehicle interior. Activate the air conditioning (cooling function) when the outside temperature is high. Otherwise, temperature-sensitive items stored in the glove box could be damaged.

Climate control system

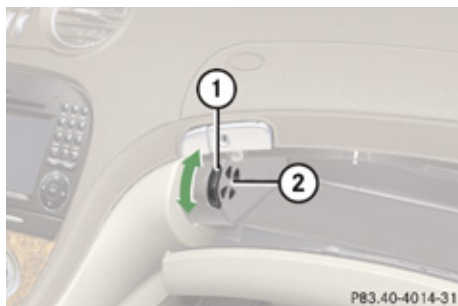

- ① Thumbwheel
- ② Air vent

i You should keep air vent ② closed when outside temperatures are low.

- ▶ **Opening the air vent:** Make sure air vent ② is unobstructed.
- ▶ Turn thumbwheel ① upwards.
- ▶ **Closing the air vent:** Turn thumbwheel ① downwards.

AIRSCARF vent

⚠ Warning!

When switching on the AIRSCARF neck-level heating, the air streaming from the

openings may be very hot. When in close proximity to the openings, you could be seriously burned. To help avoid serious personal injuries, switch the AIRSCARF to a lower heating level.



- ① AIRSCARF vent

You can switch on the AIRSCARF neck-level heating with the AIRSCARF switch (> page 94).

Adjusting air distribution

The air distribution can be adjusted separately on each side of the passenger compartment with buttons **MODE**.

The symbols on the controls represent the following functions:

Symbol	Function
	Directs air through the defroster air vents to the windshield and side windows
	Directs air through the center and side air vents
	Directs air to the footwells
	Directs air through the center, side air vents and to the footwells
	Directs air through the defroster air vents to the windshield, side windows and footwells

- ▶ Press one button **MODE** until the desired setting for the respective side of the pas-

senger compartment appears in air distribution display ① or ⑤ (▷ page 164).

Adjusting air volume

- ▶ **Decrease/increase:** Turn air volume control ⑩ (▷ page 164) clockwise or counterclockwise.

Front defroster

You can use this setting to defrost the windshield, for example if it is iced up.

You can also defog the windshield and the side windows.

- ❗ Keep this setting selected only until the windshield or the side windows are clear again.

- ▶ **Activating:** Press button .

The indicator lamp in the button comes on.

The climate control switches to the following functions automatically:

- cooling on to dehumidify
- most efficient blower speed and heating power, depending on outside temperature

- air flows onto the windshield and the front side windows
- the air recirculation mode is switched off
- ▶ **Deactivating:** Press button  again. The indicator lamp in the button goes out. The previous settings are once again in effect. The cooling remains switched on. The air recirculation remains switched off.

or

- ▶ Press button **AUTO**.

The indicator lamp in button  goes out. Air volume and air distribution are adjusted automatically.

or



- ▶ Turn temperature controls ⑦ and ⑫ (▷ page 164) clockwise or counterclockwise.

or

- ▶ Turn air volume control ⑩ (▷ page 164) clockwise or counterclockwise.

Windshield fogged on the outside

- ❗ Keep this setting selected only until the windshield is clear again.

- ▶ Switch the windshield wipers on (▷ page 105).
- ▶ Press one button **MODE** until the setting ,  or  appears in air distribution display ① or ⑤ (▷ page 164).

Maximum cooling MAX COOL

If the air distribution controls as well as the air volume control are set to **AUTO** and there is a high need for cooling, MAX COOL is activated. “MAX COOL” appears in temperature controls ⑦ and ⑫ (▷ page 164).

This provides the fastest possible cooling of the vehicle interior (when retractable hardtop is closed).

Climate control system



Automatic climate control panel with MAX COOL activated

Air recirculation mode

Switch to air recirculation mode to prevent unpleasant odors from entering the vehicle from the outside (e.g. before driving through a tunnel). This setting cuts off the intake of outside air and recirculates the air in the passenger compartment.

Warning!

Fogged windows impair visibility, endangering you and others. If the windows begin to fog on the inside, switching off the air recirculation mode immediately should clear interior window fogging. If interior window fogging persists, make sure the air

conditioning is activated, or press button



- ▶ **Activating:** Press button . The indicator lamp in the button comes on.

i The air recirculation mode is activated automatically at high outside temperatures.

The indicator lamp in button  is not lit when the air recirculation mode is automatically switched on.

A quantity of outside air is added after approximately 30 minutes.

- ▶ **Deactivating:** Press button  again. The indicator lamp in the button goes out.

i The manually selected air recirculation mode is deactivated automatically:

- after 5 minutes if the outside temperature is below approximately 41°F (5°C)
- after 5 minutes if the air conditioning is turned off
- after 30 minutes if the outside temperature is above approximately 41°F (5°C)

Residual heat and ventilation

With the engine switched off, it is possible to continue to heat or ventilate the interior for up to 30 minutes. This feature makes use of the residual heat produced by the engine.

i If you switch on the residual heat function when outside temperatures are high, only the ventilation will be switched on.

i How long the system will provide heating depends on the coolant temperature and the selected temperature. The blower will run at low speed regardless of the air distribution control setting.

- ▶ **Activating:** Switch off the ignition.

▶ Press button .

The indicator lamp in the button comes on.

- ▶ **Deactivating:** Press button .

The indicator lamp in the button goes out.

The residual heat is automatically turned off:

- when the ignition is switched on
- after approximately 30 minutes
- if the battery voltage drops

Retractable hardtop

Rear window defroster

⚠ Warning!

Any accumulation of snow and ice should be removed from the rear window before driving. Visibility could otherwise be impaired, endangering you and others.

The rear window defroster uses a large amount of power. To keep the battery drain to a minimum, switch off the defroster as soon as the rear window is clear. The defroster is automatically switched off after some time of operation depending on the outside temperature.

► Switch on the ignition.

► **Switching on:** Press button .

The indicator lamp in the button comes on.

! The rear window defroster cannot be switched on when the retractable hardtop is open. The indicator lamp will start flashing if the hardtop is open.

- Close the retractable hardtop.

The rear window defroster can then be switched on.

► **Switching off:** Press button  again.

! If the rear window defroster switches off too soon and the indicator lamp starts flashing, too many electrical consumers are operating simultaneously and there is insufficient voltage in the battery. The system responds automatically by switching the rear window defroster off.

As soon as the battery has sufficient voltage, the rear window defroster switches back on automatically.

Retractable hardtop

Safety notes

For safety reasons, the retractable hardtop can only be opened and closed when the vehicle is standing still.

⚠ Observe Safety notes, see page 60.

⚠ Warning!

To prevent possible accidents, only drive the vehicle with the retractable hardtop either completely closed and locked, or fully lowered into its storage compartment. If the retractable hardtop does not completely open or close, the roof hydraulics will lose pressure and the retractable hardtop is lowered

- after approximately 7 minutes when the ignition is switched on
- after approximately 15 seconds when the ignition is switched off

Shortly before the retractable hardtop is lowered, a warning will sound. In the multi-function display you will see  and the message Retractable Roof Lowering.





Retractable hardtop

Properly lock the retractable hardtop before continuing to drive. Otherwise, the unlocked hardtop could open while the vehicle is in motion and cause you to lose control of the vehicle. You or others could be injured as a result.

Warning!

Before operating the retractable hardtop, make sure there is no danger of anyone being injured by the moving parts (retractable hardtop, roof frame, and trunk lid).

Hands must never be placed near the roof frame, upper windshield area, hardtop, shelf behind roll bars, or trunk lid while the retractable hardtop is being raised or lowered. Serious personal injury may occur.

If potential danger exists, release the retractable hardtop switch or button  or  on the SmartKey. This immediately interrupts the raising or lowering procedure. You then can operate the retractable hardtop switch or press button  or  on the SmartKey to raise or lower the retractable hardtop away from the danger zone

 Never sit or place heavy objects on the rear shelf. Doing so could cause damage to the retractable hardtop and the rear shelf.

 Please keep in mind that weather conditions can sometimes change rapidly. Make sure to close the retractable hardtop when leaving the vehicle. If water enters the vehicle interior, vehicle electronics could be damaged which is not covered by the Mercedes-Benz Limited Warranty.

 When opening and closing the retractable hardtop, make sure

- there is sufficient clearance for the retractable hardtop to move up and for the trunk lid to move back
- the luggage cover is installed, extended and closed
- the trunk is loaded only to the height of the luggage cover
- the luggage/cargo does not push up the closed luggage cover
- the trunk lid is closed
- the outside temperature is above +5°F (-15°C)

Otherwise the retractable hardtop and trunk as well as other parts of the vehicle could be damaged.

Opening and closing

With the retractable hardtop switch

 **Observe Safety notes, see page 173.**



Retractable hardtop switch

- ① Opening
- ② Closing

- ▶ Engage the parking brake.
- ▶ Close the luggage cover (▶ page 178).

- ▶ Close the trunk lid.
- ▶ Switch on the ignition.

Opening

- ▶ **i** Make sure the retractable hardtop is dry before you open it. Otherwise water may enter the trunk interior.
- ▶ Pull up on the retractable hardtop switch as indicated by arrow ① until the retractable hardtop is completely lowered into its trunk storage compartment.

Closing

- ▶ Press down on the retractable hardtop switch as indicated by arrow ② until the retractable hardtop is completely closed and locked.

With the SmartKey

⚠ Observe Safety notes, see page 173.





- ▶ Close the luggage cover (▶ page 178).
- ▶ Close the trunk lid.
- ▶ Aim the transmitter eye at an outside door handle.
The SmartKey must be in close proximity to the outside door handle.



Opening (Summer opening feature)

- ▶ **i** Make sure the retractable hardtop is dry before you open it. Otherwise water may enter the trunk interior.

Retractable hardtop

- ▶ Press and hold button  until the retractable hardtop is completely open. The seat ventilation for the driver's seat switches on and the rear side windows also open.
- ▶ Release button  to interrupt the opening procedure.
- ▶ Press and hold button  once more to open the door windows.

Closing (Convenience closing feature)

- ▶ Press and hold button  until the retractable hardtop is completely closed. All currently open windows also close.
- ▶ Release button  to interrupt the closing procedure.

Retractable hardtop

Locking

 **Observe Safety notes, see page 173.**

The retractable hardtop is not fully closed and locked or not fully opened and locked if

- the message  Retractable Roof In Operation appears in the multifunction display
- a warning sounds for 10 seconds when driving off or while driving

If the retractable hardtop is not properly locked, lock it as follows.

Unlocked status noticed when stopped

- ▶ Switch on the ignition.
- ▶ To lock the retractable hardtop in its fully closed position, press down on the retractable hardtop switch (▷ page 174) forward until the retractable hardtop is fully closed.

or

- ▶ To lock the retractable hardtop in its fully opened position, pull up on the retractable hardtop switch (▷ page 174) until the retractable hardtop is fully opened.

Unlocked status noticed while driving

 **Warning!**

Stop the vehicle in a safe location or as soon as it is safe to do so and lock the retractable hardtop before continuing to drive. You could otherwise endanger yourself and others.

- ▶ Stop the vehicle in a safe location or as soon as it is safe to do so.
 - ▶ Leave the ignition switched on.
 - ▶ To lock the retractable hardtop in its fully closed position, press down on the retractable hardtop switch (▷ page 174) forward until the retractable hardtop is fully closed.
- or
- ▶ To lock the retractable hardtop in its fully opened position, pull up on the retractable hardtop switch (▷ page 174) until the retractable hardtop is fully opened.

Wind screen

 **Warning!**

The wind screen can restrict the driver's vision to the rear of the vehicle. To prevent a possible accident when visibility is limited (e.g. in darkness), the upper part of the wind screen should be folded back.

The wind screen deflects drafts away from the driver and passenger when the retractable hardtop is lowered.

The wind screen is stored in the trunk.

Installing

- ▶ Leave the wind screen folded and place it on the roll bar.
- ▶ Make sure the fastening straps are unbuckled.

Retractable hardtop

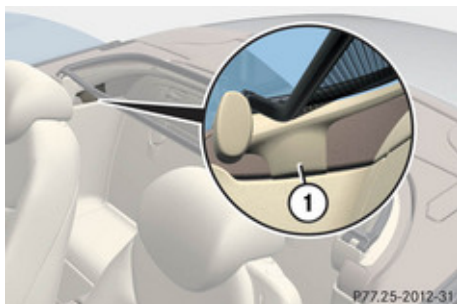

① Guide tabs

- ▶ Slide the wind screen into the roll bar until guide tabs ① on each side latch underneath the roll bar.
Make sure the fastening straps do not get caught.
- ▶ Adjust the roll bar to a height (▷ page 59) that allows you to reach easily underneath it.

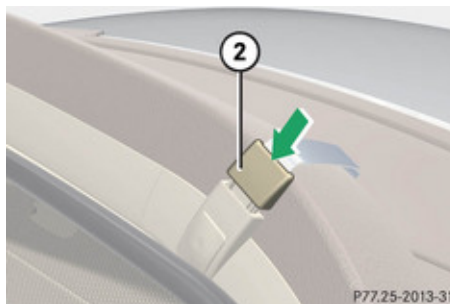

② Buckle

- ▶ Guide the fastening straps around the top of the roll bar and close buckles ②.
- ▶ Tighten the fastening straps if necessary.
- ▶ Lower the roll bar (▷ page 59).
- ▶ Fold the upper section of the wind screen up towards the head restraints until it stops.

Removing

- ▶ Fold the upper section of the wind screen back.
- ▶ Adjust the roll bar to a height (▷ page 59) that allows you to reach easily underneath it.

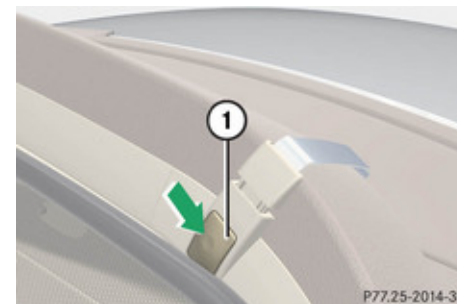

① Release button

- ▶ Undo the buckles on the upper section of the roll bar by pressing release button ①.
- ▶ Lower the roll bar (▷ page 59).
Make sure the fastening straps do not get caught.
- ▶ Pull the wind screen out towards the front of the vehicle.
Be careful not to damage interior trim with the guide tabs.
- ▶ Store the wind screen in a safe place.

Retractable hardtop

Luggage cover

The luggage cover covers luggage/cargo in the trunk.

! To prevent damage to the retractable hardtop or luggage/cargo when lowering the retractable hardtop:

- Load trunk only to the height of the luggage cover.
- Do not permit luggage/cargo to push up the closed luggage cover.
- Do not place anything on top of or in front of the luggage cover.
- Do not place anything on the shelf behind the roll bar.

Closing

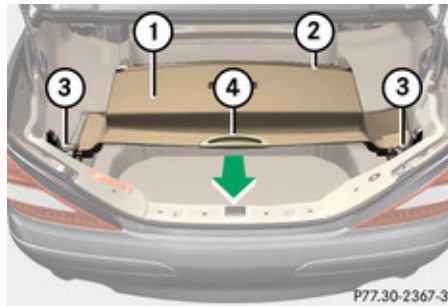

Closed luggage cover

- ① Luggage cover
- ② Zipper
- ③ Side holder
- ④ Handle

- ▶ Pull out luggage cover ① in direction of arrow using handle ④.
- ▶ Hook luggage cover ① into left and right side holders ③.

Opening

- ▶ Unhook luggage cover ① from side holders ③.
- ▶ While holding on to handle ④, guide luggage cover ① in the opposite direction of arrow.

Removing

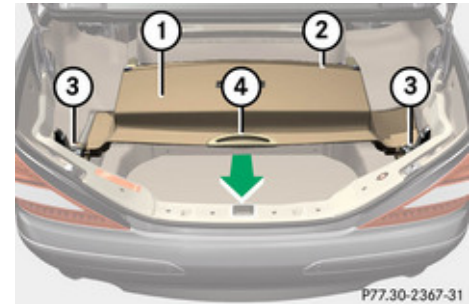

Closed luggage cover

- ① Luggage cover
- ② Zipper
- ③ Side holder
- ④ Handle

- ▶ Fold back the entire length of the zipper's cloth cover.

Retractable hardtop

- ▶ Open zipper ② completely while the luggage cover is closed.
- ▶ Open luggage cover ①.



- Closed luggage cover
- ⑤ Tensioning clasp
 - ⑥ Retainer spring

⚠ Warning!

Only open the tensioning clasps when the luggage cover is opened. You could otherwise be injured.

- ▶ Open tensioning clasps ⑤ by pulling them downward.
- ▶ Unhook retainer springs ⑥ from holders and flip retainer springs all the way up.



- ⑦ Luggage cover
- ⑧ Cloth end
- ⑨ Cloth holder

- ▶ Carefully tilt luggage cover ⑦ in direction of arrow towards rear of trunk.
- ▶ Roll up front end of cloth ⑧ in the trunk towards the front and fasten it in place in front of cloth holder ⑨.
- ▶ Remove luggage cover ⑦ from the trunk.

Installing

- !** Before installing the luggage cover, make sure that the cloth end is in front of the cloth holder. Otherwise, it could be damaged.

- ▶ Carefully place luggage cover in trunk.

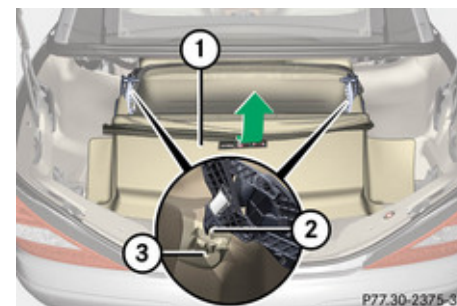

- ① Luggage cover
- ② Hook
- ③ Guide rail

- ▶ Insert luggage cover ① into guide rails ③ on both sides using hooks ②.
- ▶ Tilt luggage cover ① forward in direction of arrow.
- ▶ Fold retainer springs of tensioning clasps downward and clip them into holders on both sides (▶ page 179).
- ▶ Close tensioning clasps on both sides by pressing them upward.
- ▶ Pull handle of luggage cover towards the rear.
- ▶ Clip eyelets onto side trim panels.



Loading and storing

- ▶ Close the zipper completely.
- ▶ Fold back the zipper's cloth cover across the entire length of the luggage cover.

Sunshade for panorama roof

The sunshade protects you from excessive sunlight coming in through the panorama roof.

Warning!

Do not operate the sunshade while driving. Adjusting the sunshade while driving could cause the driver to lose control of the vehicle.

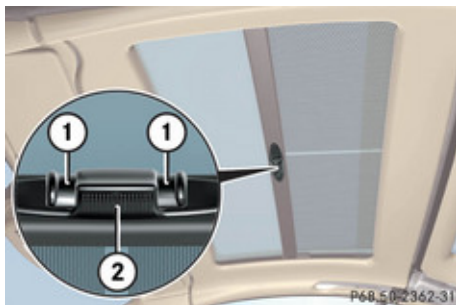

- ① Stop buttons
- ② Handle

- ▶ **Opening:** Squeeze stop buttons ① and guide the sunshade towards the rear.
- ▶ **Closing:** Using handle ②, slide the sunshade towards the front of the vehicle.

Loading and storing

Parcel nets

Warning!

The parcel net is intended for storing light-weight items only, such as road maps, mail, etc.

Heavy objects, objects with sharp edges or fragile objects may not be transported in the parcel net. In an accident, during hard braking, or sudden maneuvers, they could be thrown around inside the vehicle and cause injury to vehicle occupants.

The parcel net cannot protect transported goods in the event of an accident.

A parcel net is located in the passenger footwell.

Parcel nets in the trunk

There are three parcel nets available in the trunk to secure loads. A parcel net on each side of the right and left trunk side walls and a trunk floor net.

- ▶ Pull the trunk floor net from the trunk back wall towards the front over the luggage.
- ▶ Hang the hooks of the net on the eyes on the trunk floor.

Storage compartments

⚠ Warning!

To help avoid personal injury during a collision or sudden maneuver, exercise care when storing objects in the vehicle. Put luggage or cargo in the trunk if possible.

Do not pile luggage or cargo higher than the seat backs.

Do not place anything on shelf behind the roll bar.

Parcel nets cannot secure hard or heavy objects.

Keep compartment lids closed. This will help to prevent stored objects from being thrown about and injuring vehicle occupants during

- braking
- vehicle maneuvers
- an accident

Glove box

Depending on vehicle equipment, an AUX socket is located in the glove box. For information on AUX operation, see separate COMAND system operating instructions.

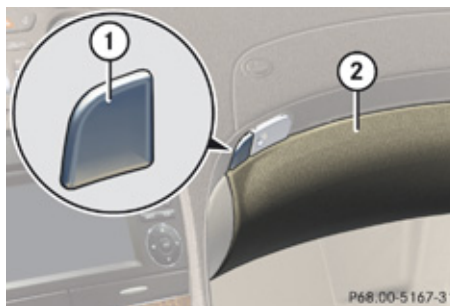

- ① Glove box lid release
- ② Glove box lid



- ▶ **Opening:** Press glove box lid release ①.
- ▶ **Closing:** Push glove box lid ② up until it engages.

Storage compartment under armrest

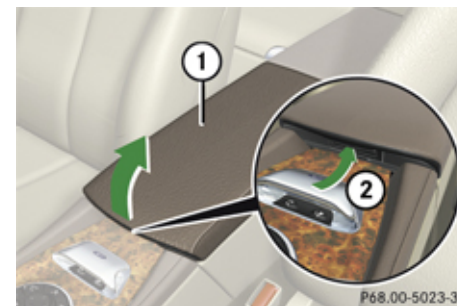
Depending on vehicle equipment, a media interface is located in the storage compartment. For information on media interface, see separate COMAND system operating instructions.



- ① Armrest
- ② Storage compartment release button

- ▶ **i** The Roadside Assistance button  (> page 190) and the Information button  (> page 191) are located in the storage compartment.

- ▶ **Opening:** Press release button ② and lift armrest ① in direction of arrow.
- ▶ **Closing:** Lower armrest ① until it engages.

Loading and storing

Rear storage compartments



Driver's side rear storage compartment

- ① Release button
- ② Storage compartment lid

► **Opening:** Press release button ①.

Locking/unlocking the storage compartments separately

The storage compartments are centrally locked when you lock the vehicle from the outside.

You can also lock the storage compartments separately, e.g. when the vehicle is in the shop for service.

The following storage compartments remain locked, even when the vehicle is unlocked with the SmartKey:

- Glove box
- Storage compartment
- Rear storage compartments

The separate locking status of these storage compartments can only be canceled with the mechanical key.

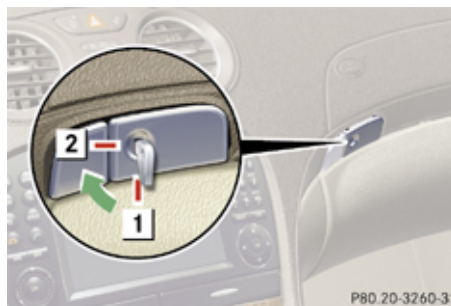

- ① Separately unlocking storage compartments
- ② Separately locking storage compartments

❗ If the glove box cannot be unlocked using the SmartKey, see “Unlocking the glove box” (► page 308).

Door storage compartments

⚠ Warning!

Keep the door storage compartments closed while vehicle is in motion. Failure to do so may cause the seat belt to catch at the rear and prevent proper positioning of the seat belt.

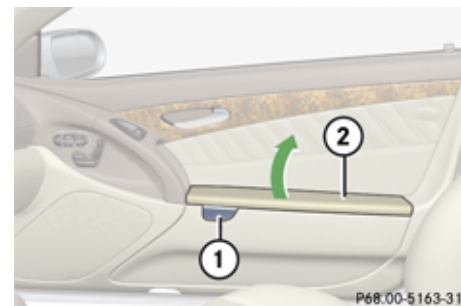

- ① Release button
- ② Storage compartment lid

► **Opening:** Press release button ①.

Seat storage compartments

Storage compartments are located in the seat base of each seat.

Loading and storing

The passenger seat storage compartment contains the first aid kit, see “First aid kit” (▷ page 252).

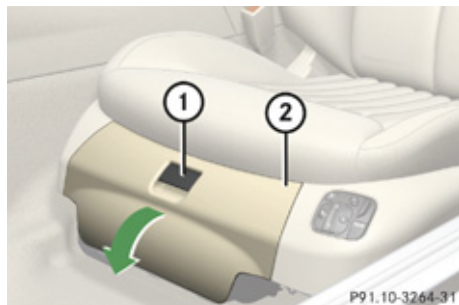

Driver's seat storage compartment

- ① Handle
- ② Storage compartment lid

- ▶ **Opening:** Pull handle ① up.
- ▶ Fold lid ② forward.

Luggage compartment in the rear

Warning!

Secure all pieces of luggage in the rear with the luggage straps. Unsecured pieces of luggage can otherwise cause injury during

a braking maneuver and can increase the risk of injury in an accident.

Never allow anyone to ride in the rear.

The luggage straps can only secure light luggage items. Carry heavy pieces of luggage in the trunk.

The rear compartment area is not designed or intended to accommodate occupants. Severe personal injury or death may be the result in an accident.

Warning!

The shelf below the rear window should not be used to carry objects. This will avoid such objects from being thrown about and injuring vehicle occupants during an accident or sudden maneuver.

The trunk is the preferred place to carry objects.

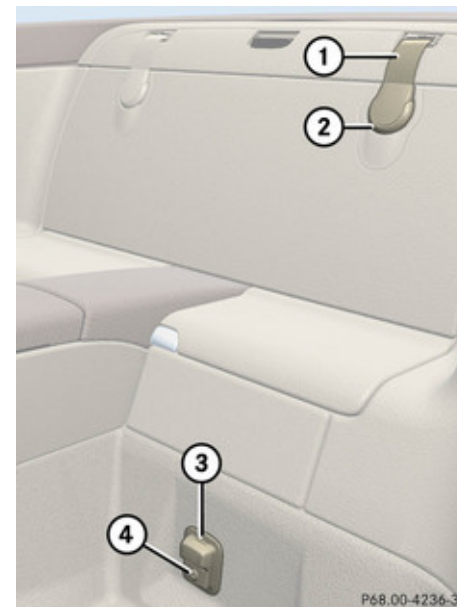

- ① Strap
- ② Holder
- ③ Latch
- ④ Release button

Loading and storing

- ▶ **Securing luggage:** Pull strap ① out of holder ②.
- ▶ Secure the luggage with the strap so that it cannot move.
- ▶ Insert strap ① into latch ③.
- ▶ **Releasing strap:** Press release button ④ and guide strap ① back to holder ②.

Load assist in the trunk

To facilitate trunk loading after opening the trunk lid, use the load assist feature to raise the retracted hardtop from its storage position in the trunk.

⚠ Warning!

To prevent injuries, make sure that there is no possibility of body parts getting caught in moving parts. If potential danger exists, press the switch again. This will immediately stop the movement of the hardtop.

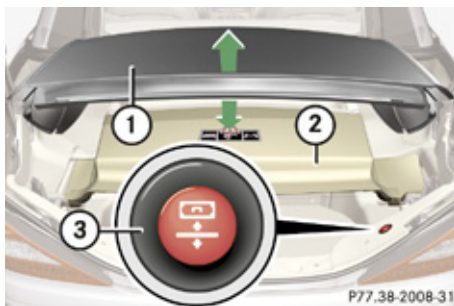

- ① Retracted hardtop
- ② Luggage cover
- ③ Load assist button

Hardtop ① can only be raised or lowered when luggage cover ② is closed and the trunk lid is completely opened.

- ▶ **Raising the hardtop:** Press button ③. Hardtop ① rises a short distance. Button ③ comes on brightly. You can now open luggage cover ②.
- ▶ **Lowering the hardtop:** Close luggage cover ②.
- ▶ Press button ③. Hardtop ① lowers. Button ③ is dimly lit.

! Only close the trunk if the hardtop is completely lowered. Otherwise you could damage the hardtop.

If you begin to close the trunk lid before the hardtop is completely lowered, the load assist button will flash and a warning will sound.

Useful features

Cup holders

⚠ Warning!

In order to help prevent spilling liquids on vehicle occupants and/or vehicle equipment, only use containers that fit into the cup holder. Use lids on open containers and do not fill containers to a height where the contents, especially hot liquids, could spill during braking, vehicle maneuvers, or in an accident. Liquids spilled on vehicle occupants may cause serious personal injury. Liquids spilled on vehicle equipment may cause damage not covered by the Mercedes-Benz Limited Warranty.

When not in use, keep the cup holder closed. An open cup holder may cause injury to you or others when contacted during braking, vehicle maneuvers, or in an accident.

Keep in mind that objects placed in the cup holder may come loose during braking, vehicle maneuvers, or in an accident and be thrown around in the vehicle interior. Objects thrown around in the vehicle interior may cause an accident and/or serious personal injury.



- ① Left cup holder
- ② Right cup holder

- ▶ **Opening:** Briefly press cup holder cover.
- ▶ **Closing:** Press cup holder cover until the cup holder engages.

Sun visors

⚠ Warning!

Do not use the vanity mirror while driving. Keep the vanity mirrors in the sun visors closed while vehicle is in motion. Reflected glare can endanger you and others.

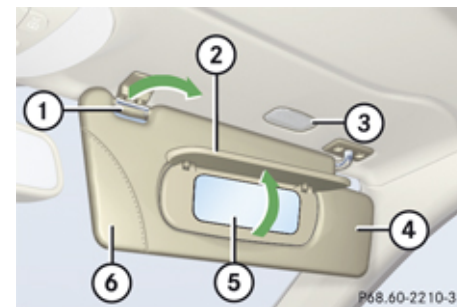

- ① Mounting
- ② Vanity mirror cover
- ③ Vanity mirror lamp
- ④ Sun visor
- ⑤ Vanity mirror
- ⑥ Holder, e.g. for gas cards

Useful features

Glare through the windshield

- ▶ Flip sun visor ④ down when you experience glare.

Glare through a door window

- ▶ Close vanity mirror cover ② (if opened).
- ▶ Disengage sun visor ④ from mounting ①.
- ▶ Pivot sun visor ④ to the side.

Vanity mirror

The mirror lamp only functions when the sun visor is engaged in mounting.

- ▶ To use vanity mirror ⑤, lift up vanity mirror cover ②.
- ▶ Vanity mirror lamp ③ comes on.

Ashtray

⚠ Warning!

Remove ashtray insert only with vehicle standing still.



- ① Cover plate
- ② Sliding knob

- ▶ **Opening:** Briefly touch cover plate ①.
- ▶ **Removing ashtray insert:** Secure vehicle from movement by engaging the parking brake.
- ▶ Shift the automatic transmission into neutral position **N**.
- ▶ Press sliding knob ② to the right. The ashtray insert will eject a short distance.

- ▶ **Reinstalling ashtray insert:** Press ashtray insert into the frame until it snaps into place.
- ▶ **Closing:** Push down cover plate ①.

Cigarette lighter

⚠ Observe Safety notes, see page 60.

⚠ Warning!

Never touch the heating element or sides of the lighter; they are extremely hot. Hold the knob only.

Make sure any children traveling with you do not injure themselves or start a fire with the hot cigarette lighter.

Useful features



① Cigarette lighter

► Open the cover plate (▷ page 186).

► Switch on the ignition.

► Push in cigarette lighter ①.

Cigarette lighter ① will pop out automatically when hot.

► Take out cigarette lighter ①.

► Reinsert cigarette lighter ① in its socket after use.

! The lighter socket can be used to accommodate 12V DC electrical accessories (up to a maximum of 85 W) designed for use with the standard “cigarette lighter” plug type. Keep in mind, however, that connecting accessories to the lighter socket (for example extensive connecting and discon-

necting, or using plugs that do not fit properly) can damage the lighter socket. With the socket damaged, the lighter may not function properly any longer.

Power outlet

The power outlet can be used to accommodate 12V DC electrical accessories (e.g. air pump, auxiliary lamps) up to a maximum of 15 A (180 W).

► Switch on the ignition.



Power outlet in trunk

① Power outlet

Tele Aid

! In order to activate the Tele Aid system, a subscriber agreement must be completed. To ensure your system is activated and operational, please press the  button to perform the acquaintance call. Failure to complete either of these steps may result in a system that is not activated.

If you have any questions regarding activation, please call the Response Center at 1-800-756-9018 (in the USA) or 1-888-923-8367 (in Canada).

Shortly after the completion of your Tele Aid acquaintance call, you will receive a user ID and password in the mail. You may use this password to access the Tele Aid section in “Owner's Online” at mbusa.com. The “My Tele Aid” section will give you access to account information, remote door unlock and more.

The Tele Aid system is available if

- it has been activated and is operational. Activation requires a subscription for mon-

Useful features

itoring services, connection and cellular air time.

- vehicle battery power is available
- the relevant cellular phone network and GPS signals are available and pass the information on to the Response Center.

i Location of the vehicle on a map is only possible if the vehicle is able to receive signals from the GPS satellite network and pass the information on to the Response Center.

The Tele Aid system

(Telematic Alarm Identification on Demand)
The Tele Aid system consists of three types of response:

- Automatic and manual emergency
- Roadside Assistance
- Information

The Tele Aid system is operational providing that the vehicle's battery is charged, properly connected, not damaged, and cellular and GPS coverage is available. The Tele Aid system utilizes the cellular network for communication and the GPS (Global Positioning System) satellites for vehicle location. If

either of these signals are unavailable, the Tele Aid system may not function and if this occurs, assistance must be summoned by other means.

To adjust the speaker volume during a Tele Aid call do the following:

▶ Press button **+** or **-** on the multifunction steering wheel.

or

▶ Use the volume knob on your COMAND system headunit.

System self-test

The system performs a self-test after you have switched on the ignition.

⚠ Warning!

If the indicator lamps in the SOS button, in the Roadside Assistance button **✓** and/or in the Information button **◀** do not come on during the system self-test, or if any of these indicators remain illuminated constantly in red and/or the message **Tele Aid Inoperative** is displayed in the multifunction display after the system self-test, a malfunction in the system has been detected.

If a malfunction is indicated as outlined above, the system may not operate as expected. In case of an emergency, help will have to be summoned by other means.

have to be summoned by other means.

Have the system checked at the nearest Mercedes-Benz Center or contact the Response Center at 1-800-756-9018 (in the USA) or 1-888-923-8367 (in Canada) as soon as possible.

Emergency calls

An emergency call is initiated automatically following an accident in which the Emergency Tensioning Devices (ETDs) or air bags deploy. An emergency call can also be initiated manually (▷ page 189).

Once the emergency call is in progress, the indicator lamp in the SOS button will begin to flash. The message **Connecting Call** appears in the multifunction display and the COMAND system is muted. When the connection is established, the message **Call Connected** appears in the multifunction display.

All information relevant to the emergency, such as the location of the vehicle (determined by the GPS satellite location system),

vehicle model, identification number and color are generated.

A voice connection between the Response Center and the occupants of the vehicle will be established automatically soon after the emergency call has been initiated. The Response Center will attempt to determine more precisely the nature of the emergency provided they can speak to an occupant of the vehicle.

- ① If no vehicle occupant responds, an ambulance will be sent to the vehicle immediately.

⚠ Warning!

If the indicator lamp in the SOS button is flashing continuously and there was no voice connection to the Response Center established, then the Tele Aid system could not initiate an emergency call (e.g. the relevant cellular phone network is not available).

The message **Call Failed** appears in the multifunction display for approximately 10 seconds.

Should this occur, assistance must be summoned by other means.

Initiating an emergency call manually

- ① The “911” emergency call system is a public service. Using it without due cause is a criminal offense.

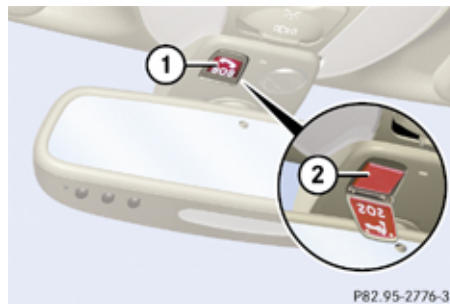

- ① Cover
 - ② SOS button
- ▶ Briefly press on cover ① to open.
 - ▶ Press SOS button ② briefly.
 - The indicator lamp in SOS button ② will flash until the emergency call is concluded.
 - ▶ Wait for a voice connection to the Response Center.
 - ▶ Close cover ① after the emergency call is concluded.

⚠ Warning!

If you feel at any way in jeopardy when in the vehicle (e.g. smoke or fire in the vehicle, vehicle in a dangerous road location), please do not wait for voice contact after you have pressed the emergency button. Carefully leave the vehicle and move to a safe location. The Response Center will automatically contact local emergency officials with the vehicle’s approximate location if they receive an automatic SOS signal and cannot make voice contact with the vehicle occupants.

Useful features

Roadside Assistance button

The Roadside Assistance button  is located in the storage compartment.



① Roadside Assistance button 

- ▶ Open the telephone compartment.
- ▶ Press and hold button  for longer than 2 seconds.

A call to a Mercedes-Benz Roadside Assistance dispatcher will be initiated. The button  will flash while the call is in progress. The message **Connecting Call** will appear in the multifunction display and the COMAND system is muted.

When the connection is established, the message **Call Connected** appears in the multifunction display. The Tele Aid system will transmit data generating the vehicle identi-

cation number, model, color and location (subject to availability of cellular and GPS signals).

i The COMAND system display indicates that a Tele Aid call is in progress. While the call is connected you can change to the navigation menu by pressing the NAV button on the COMAND system headunit. Spoken commands are not available.

A voice connection between the Roadside Assistance dispatcher and the occupants of the vehicle will be established.

- ▶ Describe the nature of the need for assistance.

The Mercedes-Benz Roadside Assistance dispatcher will either dispatch a qualified Mercedes-Benz technician or arrange to tow your vehicle to the nearest authorized Mercedes-Benz Center. For services such as labor and/or towing, charges may apply. Refer to the Roadside Assistance manual for more information.

The following is only available in the USA:
Sign and Drive services: Services such as a jump start, a few gallons of fuel or the replacement of a flat tire with the vehicle spare tire are obtainable at no charge.

i If the indicator lamp in the Roadside Assistance button  is flashing continuously and there was no voice connection to the Response Center established, then the Tele Aid system could not initiate a Roadside Assistance call (e.g. the relevant cellular phone network is not available). The message **Call Failed** appears in the multifunction display.

- ▶ **Terminating calls:** Press button  on the multifunction steering wheel.

or

- ▶ Press the respective button for ending a telephone call on the COMAND system headunit.

Information button

The Information button  is located in the storage compartment.



① Information button 

- ▶ Open the storage compartment.
- ▶ Press and hold button  for longer than 2 seconds.

A call to the Customer Assistance Center will be initiated. The button  will flash while the call is in progress. The message **Connecting Call** will appear in the multifunction display and the COMAND system is muted.

When the connection is established, the message **Call Connected** appears in the multifunction display. The Tele Aid system will transmit data generating the vehicle identi-

fication number, model, color and location (subject to availability of cellular and GPS signals).

- ❗ The COMAND system display indicates that a Tele Aid call is in progress. While the call is connected you can change to the navigation menu by pressing the NAV button on the COMAND system headunit. Spoken commands are not available.

A voice connection between the Customer Assistance Center representative and the occupants of the vehicle will be established. Information regarding the operation of your vehicle, the nearest authorized Mercedes-Benz Center or Mercedes-Benz USA products and services is available to you.

For more details concerning the Tele Aid system, please visit www.mbusa.com (USA only), log in to “Owner’s Online” and visit the “My Tele Aid” section to learn more.

- ❗ If the indicator lamp in the Information button  is flashing continuously and there was no voice connection to the Response Center established, then the Tele Aid system could not initiate an Information call (e.g. the relevant cellular phone network is not available). The message **Call**

Failed appears in the multifunction display.

- ▶ **Terminating calls:** Press button  on the multifunction steering wheel.
- or
- ▶ Press the respective button for ending a telephone call on the COMAND system headunit.

Call priority

If other service calls such as a Roadside Assistance call or Information call are active, an emergency call is still possible. In this case, the emergency call will take priority and override all other active calls.

The indicator lamp in the respective button flashes until the call is concluded. Emergency calls can only be terminated by a Response Center or Customer Assistance Center representative. All other calls can be terminated by pressing button  on the multifunction steering wheel or the respective button for ending a telephone call on the COMAND system headunit.

- ❗ When a Tele Aid call has been initiated, the COMAND system audio is muted. The mobile phone is no longer connected to the



Useful features

headunit. If you must use this phone, we recommend that you use it only with the vehicle at a standstill in a safe location.

Destination Download to the COMAND system

i The components and operating principles of the COMAND system can be found in the separate COMAND operating instructions.



Destination Download allows you access to a database of over 10,000,000 points of interest (POIs) that can be downloaded to your vehicle's navigation system. If you know the destination the address can be downloaded, or can be provided with points of interests near your location.

The Response Center can transmit destination data to the COMAND system during the connection with the Roadside Assistance or Customer Assistance Center.

The transmitted data can contain address details for a Mercedes-Benz Center or POIs.

Route guidance

A prompt appears for confirmation if route guidance to the address is to be started.

- ▶ Select Yes using button  or .
- ▶ Press button  to confirm.

The system starts the route calculation and subsequently the route guidance to the defined address.

- i** If you select No, you can save the address in your address book.
- i** The destination download feature is available if the relevant mobile phone network is available and data connection is possible.

Remote door unlock

In case you have locked your vehicle unintentionally (e.g. SmartKey inside vehicle), and the reserve SmartKey is not available:

- ▶ Contact the Mercedes-Benz Response Center at 1-800-756-9018 (in the USA) or 1-888-923-8367 (in Canada).
You will be asked to provide your password.
- ▶ Then return to your vehicle at the time arranged with the Response Center and

pull the trunk recessed handle for a minimum of 20 seconds until the SOS button is flashing.

The message **Connecting Call** appears in the multifunction display.

As an alternative, you may unlock the vehicle via Internet in the "My Tele Aid" section of "Owner's Online", using your ID and password (USA only).

The Response Center will then unlock your vehicle with the remote door unlocking feature.

- i** The remote door unlock feature is available if the relevant cellular phone network is available.

The SOS button will flash and the message **Call Connected** will appear in the multifunction display to indicate receipt of the door unlock command.

Once the vehicle is unlocked, a Response Center specialist will attempt to establish voice contact with the vehicle occupants.

If the trunk recessed handle was pulled for more than 20 seconds before door unlock authorization was received by the Response Center, you must wait 15 minutes before pulling the trunk recessed handle again.

Stolen Vehicle Recovery services

In the event your vehicle was stolen:

- ▶ Report the incident to the police.
The police will issue a numbered incident report.
- ▶ Pass this number on to the Mercedes-Benz Response Center along with your password.

The Response Center will then attempt to covertly contact the vehicle's Tele Aid system. Once the vehicle is located, the Response Center will contact the local law enforcement and you. The vehicle's location will only be provided to law enforcement.

- i** If the anti-theft alarm or the tow-away alarm stays on for more than 30 seconds, a call to the Response Center is initiated automatically by the Tele Aid system provided Tele Aid service was subscribed to and properly activated, and that necessary cellular service and GPS coverage are available. See "Anti-theft alarm system" (▶ page 71) and "Tow-away alarm" (▶ page 72).

Garage door opener

The integrated remote control can operate up to three separately controlled devices compatible with HomeLink® or some other systems.

See the following instructions for programming information.

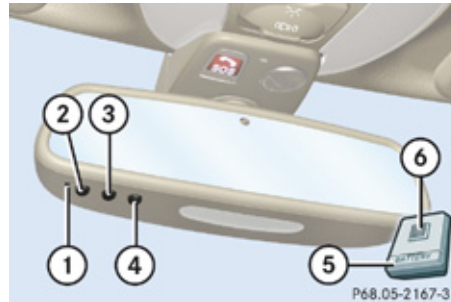

Interior rear view mirror with integrated remote control

- ① Indicator lamp
- ②③④ Signal transmitter button
- ⑤ Hand-held remote control (not part of vehicle equipment)
- ⑥ Hand-held remote control button

⚠ Warning!

Before programming the integrated remote control to a garage door opener or gate operator, make sure people and objects are out of the way of the device to prevent potential harm or damage. When programming a garage door opener, the door moves up or down. When programming a gate operator, the gate opens or closes.

Do not use the integrated remote control with any garage door opener that lacks safety stop and reverse features as required by U.S. federal safety standards (this includes any garage door opener model manufactured before April 1, 1982). A garage door that cannot detect an object - signaling the door to stop and reverse - does not meet current U.S. federal safety standards.

When programming a garage door opener, park vehicle outside the garage.

Do not run the engine while programming the integrated remote control. Inhalation of exhaust gas is hazardous to your health. All exhaust gas contains carbon monoxide (CO), and inhaling it can cause unconsciousness and possible death.

Useful features

Programming the integrated remote control

- ▶ **Step 1:** Switch on the ignition.
- ▶ **Step 2:** If you have previously programmed a signal transmitter button and wish to retain its programming, proceed to step 3.

or

- ▶ If you are programming the integrated remote control for the first time, press and hold the two outer signal transmitter buttons (2) and (4) and release them only when indicator lamp (1) begins to flash after approximately 20 seconds (do not hold the button for longer than 30 seconds).

This procedure erases any previous settings for all three channels and initializes the memory. If you later wish to program a second and/or third hand-held transmitter to the remaining two signal transmitter buttons, do not repeat this step and begin directly with step 3.

- ▶ **Step 3:** Hold the end of hand-held remote control (5) of the device you wish to train approximately 2 to 12 in (5 to 30 cm) away from the signal transmitter button (2), (3) or (4) to be programmed, while keeping indicator lamp (1) in view.

- ▶ **Step 4:** Using both hands, simultaneously press hand-held remote control button (6) and the desired signal transmitter button (2), (3) or (4). Do not release the buttons until step 5 is completed. Indicator lamp (1) will flash, first slowly and then rapidly.

1 Indicator lamp (1) flashes immediately the first time the signal transmitter button is programmed. If this button has already been programmed, the indicator lamp will only start flashing after 20 seconds.

- ▶ **Step 5:** After indicator lamp (1) changes from a slow to a rapidly flashing light, release the hand-held remote control button and the signal transmitter button.

- ▶ **Step 6:** Press and hold the just-trained signal transmitter button (2), (3) or (4) and observe indicator lamp (1).

If indicator lamp (1) stays on constantly, programming is complete and your device should activate when the respective signal transmitter button (2), (3) or (4) is pressed and released.

- 1** If indicator lamp (1) flashes rapidly for approximately 2 seconds and then turns to

a constant light, continue with programming steps 8 through 12 as your garage door opener may be equipped with the “rolling code” feature.

- ▶ **Step 7:** To program the remaining two signal transmitter buttons, repeat the steps above starting with step 3.

Rolling code programming

To train a garage door opener (or other rolling code devices) with the rolling code feature, follow these instructions after completing the “Programming” portion (steps 1 through 6) of this text. (A second person may make the following training procedures quicker and easier.)

- ▶ **Step 8:** Locate the “training” button on the garage door opener motor head unit.

i Exact location and color of the button may vary by garage door opener brand. Depending on manufacturer, the “training” button may also be referred to as “learn” or “smart” button. If there is difficulty locating the transmitting button, refer to the garage door opener Operator’s Manual.

- ▶ **Step 9:** Press the “training” button on the garage door opener motor head unit. The “training light” is activated.

Useful features

You have 30 seconds to initiate the following two steps.

- ▶ **Step 10:** Return to the vehicle and firmly press, hold for 2 seconds and release the programmed signal transmitter button (②, ③ or ④).
 - ▶ **Step 11:** Press, hold for 2 seconds and release same signal transmitter button a second time to complete the training process.
- i** Some garage door openers (or other rolling code equipped devices) may require you to press, hold for 2 seconds and release the same signal transmitter button a third time to complete the training process.
- ▶ **Step 12:** Confirm the garage door operation by pressing the programmed signal transmitter button (②, ③ or ④).
 - ▶ **Step 13:** To program the remaining two signal transmitter buttons, repeat the steps above starting with step 3.

Gate operator/Canadian programming

Canadian radio-frequency laws require transmitter signals to “time-out” (or quit) after several seconds of transmission which may

not be long enough for the integrated signal transmitter to pick up the signal during programming. Similar to this Canadian law, some U.S. gate operators are designed to “time-out” in the same manner.

If you live in Canada or if you are having difficulties programming a gate operator (regardless of where you live) by using the programming procedures, replace step 4 with the following:

- ▶ **Step 4:** Press and hold the signal transmitter button (②, ③ or ④). Do not release this button until it has been successfully trained.
- ▶ While still holding down the signal transmitter button (②, ③ or ④), “cycle” your hand-held remote control button ⑥ as follows: Press and hold button ⑥ for 2 seconds, then release it for 2 seconds, and again press and hold it for 2 seconds. Repeat this sequence on the hand-held remote control until the frequency signal has been learned.

Upon successful training, indicator lamp ① will flash slowly and then rapidly after several seconds.

- ▶ Proceed with programming step 5 and step 6 to complete.

- i** Upon completion of programming the integrated remote control, make sure you retain the hand-held remote control that came with the garage door opener, gate operator or other device. You may need it for use in other vehicles, for future programming of an integrated remote control, or simply for continued use as a hand-held remote control to operate the respective device in other situations.

Reprogramming a single signal transmitter button

To program a device using a signal transmitter button previously trained, follow these steps:

- ▶ Switch on the ignition.
- ▶ Press and hold the desired signal transmitter button (②, ③ or ④). Do not release the button. Indicator lamp ① will begin to flash after 20 seconds.
- ▶ Without releasing the signal transmitter button, proceed with programming starting with step 3.

Useful features

Operation of integrated remote control

- ▶ Switch on the ignition.
- ▶ Select and press the appropriate integrated signal transmitter button (②, ③ or ④) to activate the remote controlled device.

The integrated remote control transmitter continues to send the signal as long as the button is pressed – up to 20 seconds.

Erasing the integrated remote control memory

- ▶ Switch on the ignition.
- ▶ Simultaneously press and hold outer signal transmitter buttons ② and ④, for approximately 20 seconds, until indicator lamp ① flashes rapidly. Do not hold for longer than 30 seconds.

The codes of all three channels are erased.

- i** If you sell your vehicle, erase the codes of all three channels.

Programming tips

If you are having difficulty programming the integrated remote control, here are some helpful tips:

- Check the frequency of hand-held remote control ⑤ (typically located on the reverse side of the remote). The integrated remote control is compatible with radio-frequency devices operating between 280-390 MHz.
- Put a new battery in hand-held remote control ⑤. This will increase the likelihood of the hand-held remote control sending a faster and more accurate signal to the integrated remote control.
- While performing step 3, hold hand-held remote control ⑤ at different lengths and angles from the signal transmitter button (②, ③ or ④) you are programming. Attempt varying angles at the distance of 2 to 12 inches (5 to 30 cm) away or the same angle at varying distances.
- If another hand-held remote control is available for the same device, try the programming steps again using that other hand-held remote control. Make sure new

batteries are in the hand-held remote control before beginning the procedure.

- Straighten the antenna wire from the garage door opener assembly. This may help improve transmitting and/or receiving signals.
- i** Certain types of garage door openers are incompatible with the integrated remote control. If you should experience further difficulties with programming the integrated remote control, contact an authorized Mercedes-Benz Center, or call Mercedes-Benz Customer Assistance Center (in the USA) at 1-800-FOR-MERCEdes, or Customer Service (in Canada) at 1-800-387-0100.
- i** USA only:
This device complies with Part 15 of the FCC Rules. Operation is subject to the following two conditions:
 1. This device may not cause harmful interference, and
 2. this device must accept any interference received, including interference that may cause undesired operation.

Useful features

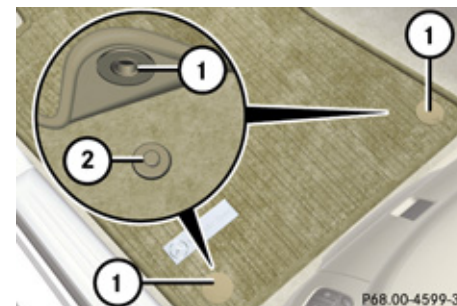

- ① Eyelet
- ② Retainer pin

- ▶ **Removing:** Pull floor mat off of retainer pins ②.
- ▶ **Installing:** Press floor mat eyelets ① onto retainer pins ②.

Any unauthorized modification to this device could void the user's authority to operate the equipment.

i Canada only:

This device complies with RSS-210 of Industry Canada. Operation is subject to the following two conditions:

1. This device may not cause interference, and
2. this device must accept any interference received, including interference that may cause undesired operation of the device.

Any unauthorized modification to this device could void the user's authority to operate the equipment.

Floormats

⚠ Warning!

Whenever you are using floormats, make sure there is enough clearance and that the floormats are securely fastened.

Floormats should always be securely fastened using the fastening equipment.

Before driving off, check that the floormats are securely in place and adjust them if necessary. A loose floormat could slip and hinder proper functioning of the pedals.

Do not place several floormats on top of each other as this may impair pedal movement.

- i** To install or remove the floormat more easily, move the driver's seat or passenger seat as far to the rear as possible.

Vehicle equipment	200
The first 1000 miles (1500 km)	200
At the gas station	201
Engine compartment	203
Tires and wheels	209
Winter driving	234
Driving instructions	236
Maintenance	241
Vehicle care	243



The first 1000 miles (1500 km)

Vehicle equipment

i This Operator's Manual describes all features, standard or optional, potentially available for your vehicle at the time of purchase. Please be aware that your vehicle might not be equipped with all features described in this manual.

The first 1000 miles (1500 km)

The more cautiously you treat your vehicle during the break-in period, the more satisfied you will be with its performance later on.

- Drive your vehicle during the first 1000 miles (1500 km) at varying but moderate vehicle and engine speeds.
- During this period, avoid heavy loads (full throttle driving) and excessive engine speeds (no more than $\frac{2}{3}$ of maximum rpm in each gear).
- Select **C** as the preferred shift program (\triangleright page 118) for the first 1000 miles (1500 km).
- Avoid accelerating by kickdown.
- Do not attempt to slow the vehicle down by shifting to a lower gear using the gear selector lever.
- Select gear ranges **3**, **2** or **1** (\triangleright page 118) only when driving at moderate speeds (for hill driving).

After 1000 miles (1500 km) you may gradually increase vehicle and engine speeds to the permissible maximum.

! Additional instructions for AMG vehicles:

- During the first 1000 miles (1500 km), do not exceed a speed of 85 mph (140 km/h).
- During this period, avoid engine speeds above 4500 rpm in each gear.
- Shift gears in a timely manner.

All of the above instructions, as may apply to your vehicle type, also apply when driving the first 1000 miles (1500 km) after the engine or the rear differential has been replaced.

i Always obey applicable speed limits.

At the gas station

At the gas station

Refueling

⚠ Warning!

Gasoline is highly flammable and poisonous. It burns violently and can cause serious personal injury.

Never allow sparks, flames or smoking materials near gasoline!

Turn off the engine before refueling.

Whenever you are around gasoline, avoid inhaling fumes and any skin or clothing contact. Extinguish all smoking materials.

Direct skin contact with fuels and the inhalation of fuel vapors are damaging your health.

⚠ Warning!

Overfilling of the fuel tank may create pressure in the system which could cause a gas discharge. This could cause the gas to spray back out when removing the fuel pump nozzle, which could cause personal injury.

! Never refuel vehicles with gasoline engine with diesel fuel. Even small amounts of diesel fuel will damage the fuel system and

engine. Damage resulting from the use of non-approved fuels or fuel additives or resulting from mixing gasoline with diesel fuel is not covered by the Mercedes-Benz Limited Warranty.

! If you have accidentally filled the tank with incorrect or non-approved fuel, do not switch on the ignition. Otherwise the incorrect or non-approved fuel will get into the fuel lines. The fuel system must be drained completely. Contact an authorized Mercedes-Benz Center to have the fuel system drained completely.

! To prevent damage to the catalytic converters, only use premium unleaded gasoline in this vehicle.

Any noticeable irregularities in engine operation should be repaired promptly.

Otherwise, excessive unburned fuel may reach the catalytic converter, causing it to overheat and potentially start a fire.

i Only use premium unleaded gasoline with a minimum Posted Octane Rating of 91 (average of 96 RON / 86 MON).

Information on gasoline quality can normally be found on the fuel pump. Please

contact gas station personnel in case labels on the pump cannot be found.

For more information on gasoline, see “Premium unleaded gasoline” (▷ page 354), see “Fuel requirements” (▷ page 354), or contact an authorized Mercedes-Benz Center, or visit www.mbusa.com (USA only).

The fuel filler flap is located on the right-hand side of the vehicle towards the rear.

Locking/unlocking the vehicle with the SmartKey automatically locks/unlocks the fuel filler flap.



i In case that the central locking system does not release the fuel filler flap, or the opening mechanism is clamping, contact Roadside Assistance or an authorized Mercedes-Benz Center.

At the gas station



- ① Fuel filler flap
- ② Fuel filler cap
- ③ Holder

▶ Turn off the engine.

i Leaving the engine running and the fuel filler cap open can cause the yellow fuel tank reserve warning lamp to flash and the malfunction indicator lamp  (USA only) or  (Canada only) to illuminate.

For more information, see also “Practical hints” (▷ page 302).

▶ Remove the SmartKey from the starter switch.

KEYLESS-GO: Open the driver’s door (this puts the starter switch in position **0**, same as with the SmartKey removed from the

starter switch). The driver’s door then can be closed again.

- ▶ **Opening:** Push fuel filler flap ① at the point indicated by the arrow.
- ▶ Turn fuel filler cap ② counterclockwise.
- ▶ Take off fuel filler cap ②.
- ▶ Place fuel filler cap ② in direction of arrow into holder ③ located on the inside of fuel filler flap.
- ▶ Fully insert filler nozzle unit and refuel.
- ▶ Only fill your tank until the filler nozzle unit cuts out – **do not top off or overfill.**
- ▶ **Closing:** Turn fuel filler cap ② clockwise until it audibly engages.
- ▶ Close fuel filler flap ①.

Check regularly and before a long trip

For information on quantities and requirements of operating agents, see “Fuels, coolants, lubricants, etc.” (▷ page 350).

Check the following:

- Engine oil level (▷ page 204)
- Tire inflation pressure (▷ page 217)
- Coolant level (▷ page 207)
- Vehicle lighting (▷ page 98), (▷ page 311)
- Washer system and headlamp cleaning system (▷ page 208)
- Brake fluid (▷ page 237), (▷ page 269) and (▷ page 293)

Engine compartment

Engine compartment

Hood

⚠ Warning!

Do not pull the release lever while the vehicle is in motion. Otherwise the hood could be forced open by passing air flow.

This could cause the hood to come loose and injure you and/or others.

Opening

⚠ Warning!

If you see flames or smoke coming from the engine compartment, or if the coolant temperature gauge indicates that the engine is overheated, do not open the hood. Move away from vehicle and do not open the hood until the engine has cooled. If necessary, call the fire department.

⚠ Warning!

You could be injured when the hood is open – even when the engine is turned off. Parts of the engine can become very hot. To prevent burns, let the engine cool off completely before touching any compo-

nents on the vehicle. Comply with all relevant safety precautions.

⚠ Warning!

To help prevent personal injury, stay clear of moving parts when the hood is open and the engine is running.

The radiator fan may continue to run for approximately 30 seconds or may even restart after the engine has been turned off. Stay clear of fan blades.

⚠ Warning!

The engine is equipped with a transistorized ignition system. Because of the high voltage it is dangerous to touch any components (ignition coils, spark plug sockets, diagnostic socket) of the ignition system

- with the engine running
- while starting the engine
- when the ignition is switched on and the engine is turned manually

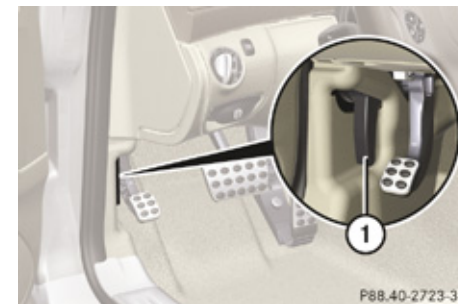

① Hood lock release lever

- Pull release lever ①.
The hood is unlocked.

! To avoid damage to the windshield wipers or hood, never open the hood if the wiper arms are folded forward away from the windshield.

Engine compartment



② Handle for opening the hood

- ▶ Push handle ② under the hood upwards.
- ▶ Pull up on the hood and then release it.

The hood will be automatically held open at shoulder height by gas-filled struts.

Closing

Warning!

When closing the hood, use extreme caution not to catch hands or fingers. Be careful that you do not close the hood on anyone.

Make sure the hood is securely engaged before driving off. Do not continue driving if the hood can no longer engage after an accident, for example. The hood could oth-

erwise come loose while the vehicle is in motion and injure you and/or others.

- ▶ Let the hood drop from a height of approximately 1 ft (30 cm).
- ▶ Check to make sure the hood is fully closed.

If you can raise the hood at a point above the headlamps, then it is not properly closed. Open it again and let it drop with somewhat greater force.

Engine oil

The amount of oil your engine needs will depend on a number of factors, including driving style. Increased oil consumption can occur when the vehicle is new or the vehicle is driven frequently at higher engine speeds.

Engine oil consumption checks should only be made after the vehicle break-in period.

- ❗ Do not use any special lubricant additives, as these may damage the drive assemblies. Using special additives not approved by Mercedes-Benz may cause damage not covered by the Mercedes-Benz Limited Warranty.

For further information contact an authorized Mercedes-Benz Center.

Notes on checking engine oil level

When checking the oil level

- the vehicle must be parked on level ground
- with the engine at operating temperature, the vehicle must have been stationary for at least 5 minutes with the engine turned off
- with the engine not at operating temperature, the vehicle must have been stationary for at least 30 minutes with the engine turned off

Checking engine oil level with the oil dipstick

On the SL 550 and SL 63 AMG, you can check the engine oil level with the oil dipstick.

- i In vehicles without an oil dipstick, the engine oil level is measured via the control system (> page 205).

Engine compartment

- ▶ Open the hood (▷ page 203).

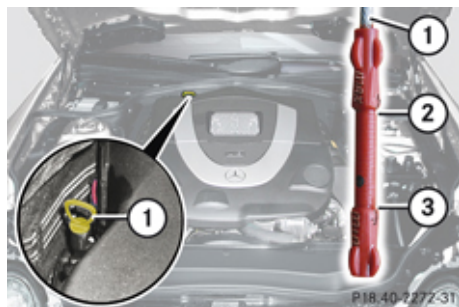

- ① Oil dipstick
- ② Upper (max) mark
- ③ Lower (min) mark

- ▶ Pull out oil dipstick ①.
- ▶ Wipe oil dipstick ① clean.
- ▶ Fully insert oil dipstick ① into the dipstick guide tube.
- ▶ Pull out oil dipstick ① again after approximately 3 seconds to obtain accurate reading.
The oil level is correct when it is between lower (min) mark ③ and upper (max) mark ② of oil dipstick ①.

- ① The filling quantity between the upper and lower marks on the oil dipstick is approximately 2.1 US qt. (2.0 l).

- ① SL 63 AMG only:
The filling quantity between the upper and lower marks on the oil dipstick is approximately 1.6 US qt. (1.5 l).

- ▶ If necessary, add engine oil.

For more information on engine oil, see “Fuels, coolants, lubricants etc.” (▷ page 350).

For information on messages in the multifunction display concerning engine oil, see the “Practical hints” section (▷ page 284).



Checking engine oil level with the control system

On the SL 600 and SL 65 AMG you can check the engine oil level with the control system.

- ① In vehicles without engine oil measuring system, the engine oil level is measured via the oil dipstick (▷ page 204).

- ▶ Switch on the ignition.

The standard display appears in the multifunction display (▷ page 129).

- ▶ Press button  or  on the multifunction steering wheel repeatedly until the following message appears in the multifunction displays.

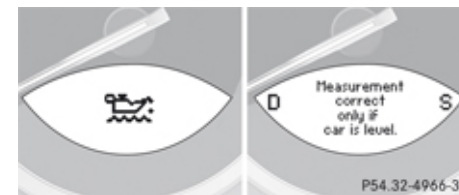

- ▶ After about 3 seconds, the following message appears in the left multifunction display: Engine Oil Measuring Now.



One of the following messages will subsequently appear in the right multifunction display:

- Engine Oil Level OK
- Add 1.0 qt to reach max. oil level.
(Canada: 1.0 liter)
- Add 1.5 qts

Engine compartment

to reach max.
oil level.
(Canada: 1.5 liters)

- Add 2.0 qts
to reach max.
oil level.
(Canada: 2.0 liters)

i If you want to interrupt the checking procedure, press button  or  on the multifunction steering wheel.

- ▶ If necessary, add engine oil.

For more information on engine oil, see “Fuels, coolants, lubricants etc.” (> page 350).

Other display messages

If the ignition is not switched on, the following message appears in the multifunction display:

Turn ignition on
to measure
engine oil level.

- ▶ Switch on the ignition.

If you see the message:

Observe
Waiting Time

- ▶ If the engine is at operating temperature, wait 5 minutes before repeating check procedure.
- ▶ If the engine is not at operating temperature yet, you must wait 30 minutes before checking oil.

If you see the message:

Engine Oil Level
Not With
Engine Running

- ▶ Turn off the engine.
- ▶ If the engine is at operating temperature, wait 5 minutes before checking oil.
- ▶ If the engine is not at operating temperature yet, you must wait 30 minutes before checking oil.

If there is excess engine oil with the engine at normal operating temperature, the following message appears in the multifunction display:

Engine Oil Level
Reduce Oil Level

- ▶ Have excess oil siphoned or drained off. Contact an authorized Mercedes-Benz Center.

! Excess oil must be siphoned or drained off. It could cause damage to the engine and emission control system not covered by the Mercedes-Benz Limited Warranty.

For information on messages in the multifunction display concerning engine oil, see the “Practical hints” section (> page 285).

Adding engine oil

! Only use approved engine oils and oil filters required for vehicles with Maintenance System. For a listing of approved engine oils and oil filters, contact an authorized Mercedes-Benz Center or visit www.mbusa.com (USA only).

Using engine oils and oil filters of specification other than those expressly required for the Maintenance System, or changing of oil and oil filter at change intervals longer than those called for by the Maintenance System will result in engine or emission control system damage not covered by the Mercedes-Benz Limited Warranty.

Engine compartment



Example illustration SL 550

① Filler cap



Example illustration SL 63 AMG

① Filler cap

- ▶ Unscrew filler cap ① from filler neck.
- ▶ Add engine oil as required. Be careful not to overfill with oil.

Be careful not to spill any oil when adding. Avoid environmental damage caused by oil entering the ground or water.

! Excess oil must be siphoned or drained off. It could cause damage to the engine and emission control system not covered by the Mercedes-Benz Limited Warranty.

- ▶ Screw filler cap ① back on filler neck.

For more information on engine oil, see the “Technical data” section (> page 350) and (> page 352).

Transmission fluid level

The transmission fluid level does not need to be checked. If you notice transmission fluid loss or gearshifting malfunctions, have an authorized Mercedes-Benz Center check the transmission.

Active Body Control (ABC) fluid level

Regular fluid level check is not required. If you notice fluid leaks or malfunction messages in the multifunction display, have an authorized Mercedes-Benz Center check the ABC-system.

Coolant level

The engine coolant is a mixture of water and anticorrosion/antifreeze.

When checking the coolant level, the vehicle must be parked on level ground, and the coolant temperature must be below 158°F (70°C).

⚠ Warning!

In order to avoid any potentially serious burns:

- Use extreme caution when opening the hood if there are any signs of steam or coolant leaking from the cooling system, or if the coolant temperature indicator indicates that the coolant is overheated.
- Do not remove pressure cap on coolant reservoir if coolant temperature is above 158°F (70°C). Allow engine to cool down before removing cap. The coolant reser-

▷▷

Engine compartment

voir contains hot fluid and is under pressure.

- Using a rag, slowly open the cap approximately $1/2$ turn to relieve excess pressure. If opened immediately, scalding hot fluid and steam will be blown out under pressure.
- Do not spill antifreeze on hot engine parts. Antifreeze contains ethylene glycol which may burn if it comes into contact with hot engine parts.



① Coolant expansion tank

- ▶ Using a rag, turn the cap slowly approximately $1/2$ counterclockwise to release any excess pressure.

- ▶ Continue turning the cap counterclockwise and remove it.

The coolant level is correct if the level

- for cold coolant: is up to the upper mark on the bracing rib of the coolant expansion tank (translucent)
- for warm coolant: is approximately 0.6 in (1.5 cm) higher

- ▶ Add coolant as required.
- ▶ Replace and tighten cap.

- ❗ SL 600 and SL 65 AMG: Only open the cap on the coolant expansion tank. Never open the cap between the two charge-air coolers. Otherwise, the engine could be damaged.

For more information on coolant, see the “Technical data” section (▷ page 355).

Washer system and headlamp cleaning system

⚠ Warning!

Washer solvent/antifreeze is highly flammable. Do not spill washer solvent/antifreeze on hot engine parts, because it may ignite and burn. You could be seriously burned.

- ❗ Always use washer solvent/antifreeze where temperatures may fall below freezing point. Failure to do so could result in damage to the washer system/fluid reservoir.

- ❗ Only use washer fluid which is suitable for plastic lenses. Improper washer fluid can damage the plastic lenses of the headlamps.

- ❗ Do not use distilled or de-ionized water in the washer fluid reservoir. Otherwise, the washer fluid level sensor could be damaged.

Tires and wheels

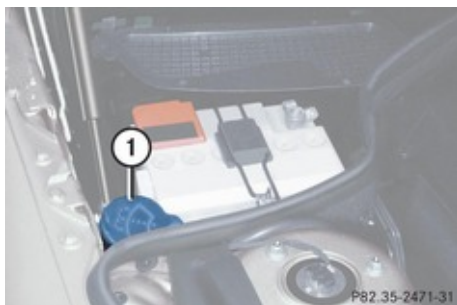

① Cap for washer fluid reservoir

Fluid for the washer system and the headlamp cleaning system is supplied from the washer fluid reservoir.

During all seasons, add MB Windshield Washer Concentrate “MB SummerFit” to water. Premix the washer fluid in a suitable container.

- ▶ **Opening washer fluid reservoir:** Pull tab of cap ① upwards.
- ▶ Refill the washer fluid reservoir with MB Windshield Washer Concentrate “MB SummerFit” and water (or commercially available premixed washer solvent/antifreeze,

depending on ambient temperatures)
(▷ page 357).

- ▶ **Closing washer fluid reservoir:** Press cap ① onto filler hole until it engages.

For more information, see “Washer system and headlamp cleaning system” (▷ page 352).

Tires and wheels

Safety notes

Contact an authorized Mercedes-Benz Center for information on tested and recommended rims and tires for summer and winter operation. They can also offer advice concerning tire service and purchase.

⚠ Warning!

Replace rims or tires with the same designation, manufacturer and type as shown on the original part. For further information contact an authorized Mercedes-Benz Center. If incorrectly sized rims and tires are mounted, the wheel brakes or suspension components can be damaged. Also, the correct operating clearance of the wheels and the tires may no longer be correct.

⚠ Warning!

Worn, old tires can cause accidents. If the tire tread is worn to minimum tread depth, or if the tires have sustained damage, replace them.

When replacing rims, only use genuine Mercedes-Benz wheel bolts specified for the particular rim type. Failure to do so can



Tires and wheels

result in the bolts loosening and possibly an accident.

Retreaded tires are not tested or recommended by Mercedes-Benz, since previous damage cannot always be recognized on retreads. The operating safety of the vehicle cannot be assured when such tires are used.

Warning!

If you feel a sudden significant vibration or ride disturbance, or you suspect that possible damage to your vehicle has occurred, you should turn on the hazard warning flashers, carefully slow down, and drive with caution to an area which is a safe distance from the road.

Inspect the tires and the vehicle underbody for possible damage. If the vehicle or tires appear unsafe, have the vehicle towed to the nearest authorized Mercedes-Benz Center or tire dealer for repairs.

Warning!

Do not drive with a flat tire. A flat tire affects the ability to steer or brake the vehicle. You could lose control of the vehicle. Continued driving with a flat tire or driving at high

speed with a flat tire will cause excessive heat build-up and possibly a fire.

Important guidelines

- Only use sets of tires and rims of the same type and make.
- Tires must be of the correct size for the rim.
- Break in new tires for approximately 60 miles (100 km) at moderate speeds.
- Regularly check the tires and rims for damage. Dented or bent rims can cause tire inflation pressure loss and damage to the tire beads.
- If vehicle is heavily loaded, check tire inflation pressure and correct as required.
- Do not allow your tires to wear down too far. Adhesion properties on wet roads are sharply reduced at tread depths of less than $\frac{1}{8}$ in (3 mm).
- When replacing individual tires, you should mount new tires on the front wheels first (on vehicles with same-sized wheels all around).

Tire care and maintenance

Warning!

Regularly check the tires for damage. Damaged tires can cause tire inflation pressure loss. As a result, you could lose control of your vehicle.

Worn, old tires can cause accidents. If the tire tread is worn to minimum tread depth, or if the tires have sustained damage, replace them.

Check the tire inflation pressure at least every other week. For more information on checking tire inflation pressure, see “Recommended tire inflation pressure” (▷ page 215).

Tire inspection

Every time you check the tire inflation pressure, you should also inspect your tires for the following:

- excessive treadwear (▷ page 211)
- cord or fabric showing through the tire’s rubber
- bumps, bulges, cuts, cracks or splits in the tread or side of the tire

Tires and wheels

Replace the tire if you find any of the above conditions.

Make sure you also inspect the spare tire periodically for condition and inflation. Spare tires will age and become worn over time even if never used, and thus should be inspected and replaced when necessary.

Life of tire

Warning!

Tires and spare tire should be replaced after 6 years, regardless of the remaining tread.

The service life of a tire is dependent upon varying factors including but not limited to:

- Driving style
- Tire inflation pressure
- Distance driven

Tread depth

Warning!

Although the applicable federal motor vehicle safety laws consider a tire to be worn when the treadwear indicators (TWI) become visible at approximately $1/16$ in

(1.6 mm), we recommend that you do not allow your tires to wear down to that level. As tread depth approaches $1/8$ in (3 mm), the adhesion properties on a wet road are sharply reduced.

Depending upon the weather and/or road surface (conditions), the tire traction varies widely.

Do not allow your tires to wear down too far. Adhesion properties on wet roads are sharply reduced at tread depths of less than $1/8$ in (3 mm).

Treadwear indicators (TWI) are required by law. These indicators are located in six places on the tread circumference and become visible at a tread depth of approximately $1/16$ in (1.6 mm), at which point the tire is considered worn and should be replaced.

The recommended minimum tire tread depth for summer tires is $1/8$ in (3 mm). The recommended minimum tire tread depth for winter tires is $1/6$ in (4 mm).

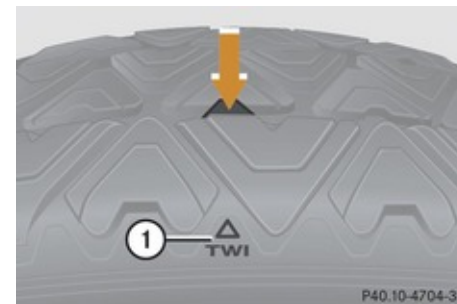

① TWI (Tread Wear Indicator)

The treadwear indicator appears as a solid band across the tread.

Storing tires

 Keep unmounted tires in a cool, dry place with as little exposure to light as possible. Protect tires from contact with oil, grease and fuels.

Cleaning tires

 Never use a round nozzle to power wash tires. The intense jet of water can result in damage to the tire. Always replace a damaged tire.

Tires and wheels

Direction of rotation

Unidirectional tires offer added advantages, such as better hydroplaning performance. To benefit, however, you must make sure the tires rotate in the direction specified.

An arrow on the sidewall indicates the intended direction of rotation (spinning) of the tire.

Spare wheels may be mounted against the direction of rotation (spinning) even with a unidirectional tire for temporary use only until the regular drive wheel has been repaired or replaced. Always observe and follow applicable temporary use restrictions and speed limitations indicated on the spare wheel.

Loading the vehicle

Two labels on your vehicle show how much weight it may properly carry.

- (1) The Tire and Loading Information placard can be found on the driver's door B-pillar. This placard tells you important information about the number of people that can be in the vehicle and the total weight that can be carried in the vehicle. It also contains information on the proper size and recommended tire inflation pres-

ures for the original equipment tires on your vehicle.

- (2) The certification label, also found on the driver's door B-pillar. It tells you about the gross weight capacity of your vehicle, called the Gross Vehicle Weight Rating (GVWR). The GVWR includes the weight of the vehicle, all occupants, fuel and cargo. The certification label also tells you about the front and rear axle weight capacity, called the Gross Axle Weight Rating (GAWR).

The GAWR is the total allowable weight that can be carried by a single axle (front or rear). Never exceed the GVWR or GAWR for either the front axle or rear axle.

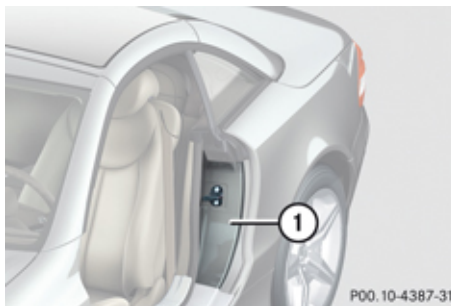

① Driver's door B-pillar

Following is a discussion on how to work with the information contained on the Tire and Loading Information placard with regards to loading your vehicle.

Tire and Loading Information

Warning!

Do not overload the tires by exceeding the specified load limit as indicated on the Tire and Loading Information placard on the driver's door B-pillar. Overloading the tires can overheat them, possibly causing a blowout. Overloading the tires can also result in handling or steering problems, or brake failure.

Tire and Loading Information placard

- i** Data shown on Tire and Loading Information placard example are for illustration purposes only. Load limit data are specific to each vehicle and may vary from data shown in the following illustration. Refer to Tire and Loading Information placard on vehicle for actual data specific to your vehicle.

Tires and wheels

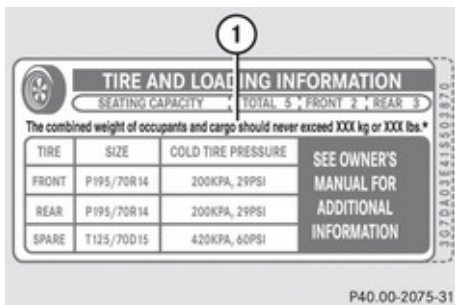

① Load limit information on the Tire and Loading Information placard

The Tire and Loading Information placard showing the load limit information is located on the driver’s door B-pillar (▷ page 212).

► Locate the statement “The combined weight of occupants and cargo should never exceed XXX kilograms or XXX lbs.” on the Tire and Loading Information placard.

The combined weight of all occupants, cargo/luggage and trailer tongue load (if applicable) should never exceed the weight referenced in that statement.

Seating capacity

The seating capacity gives you important information on the number of occupants that can be in the vehicle. The Tire and Loading Information placard showing the seating capacity is located on the driver’s door B-pillar (▷ page 212).

① Data shown on Tire and Loading Information placard example are for illustration purposes only. Seating capacity data are specific to each vehicle and may vary from data shown in the following illustration. Refer to Tire and Loading Information placard on vehicle for actual data specific to your vehicle.

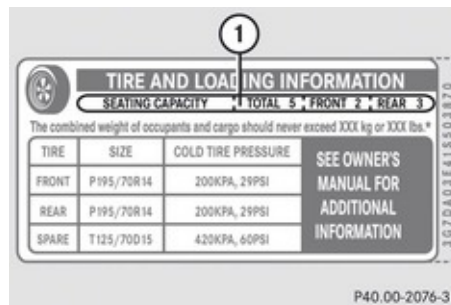

① Seating capacity information on the Tire and Loading Information placard

Steps for determining correct load limit

The following steps have been developed as required of all manufacturers under Title 49, Code of U.S. Federal Regulations, Part 575 pursuant to the “National Traffic and Motor Vehicle Safety Act of 1966”.

- **Step 1:** Locate the statement “The combined weight of occupants and cargo should never exceed XXX kg or XXX lbs.” on your vehicle’s Tire and Loading Information placard.
- **Step 2:** Determine the combined weight of the driver and passengers that will be riding in your vehicle.
- **Step 3:** Subtract the combined weight of the driver and passengers from XXX kilograms or XXX lbs.
- **Step 4:** The resulting figure equals the available amount of cargo and luggage load capacity. For example, if the “XXX” amount equals 1400 lbs and there will be five 150 lbs passengers in your vehicle, the amount of available cargo and luggage load capacity is 650 lbs (1400 - 750 (5 x 150) = 650 lbs).
- **Step 5:** Determine the combined weight of luggage and cargo being loaded on the



Tires and wheels

vehicle. That weight may not safely exceed the available cargo and luggage load capacity calculated in step 4.

- ▶ **Step 6 (if applicable):** If your vehicle will be towing a trailer, load from your trailer will be transferred to your vehicle. Consult

this manual to determine how this reduces the available cargo and luggage load capacity of your vehicle (▷ page 215).

The following table shows examples on how to calculate total and cargo load capacities with varying seating configurations and num-

ber and size of occupants. The following examples use a load limit of 1500 lbs. **This is for illustration purposes only.** Make sure you are using the actual load limit for your vehicle stated on the vehicle's Tire and Loading Information placard (▷ page 213).

Example	Combined weight limit of occupants and cargo from Tire and Loading Information placard	Number of occupants (driver and passengers)	Occupants weight	Combined weight of all occupants	Available cargo/luggage and trailer tongue weight (total load limit from Tire and Loading Information placard minus combined weight of all occupants)
1	1500 lbs	1	Occupant 1: 175 lbs	175 lbs	1500 lbs - 175 lbs = 1325 lbs
2	1500 lbs	2	Occupant 1: 175 lbs Occupant 2: 195 lbs	370 lbs	1500 lbs - 370 lbs = 1130 lbs

The higher the weight of all occupants, the less cargo and luggage load capacity is available.

For more information, see “Trailer tongue load” (▷ page 215).

Certification label

Even after careful determination of the combined weight of all occupants, cargo and the trailer tongue load (if applicable) (▷ page 215) as to not exceed the permissi-

ble load limit, you must make sure your vehicle never exceeds the Gross Vehicle Weight Rating (GVWR) and the Gross Axle Weight Rating (GAWR) for either the front or rear axle. You can obtain the GVWR and GAWR from the certification label. The certification label can be found on the driver's door B-pillar, see the “Technical data” section (▷ page 339).

Gross Vehicle Weight Rating (GVWR): The total weight of the vehicle, all occupants, all

cargo, and the trailer tongue load must never exceed the GVWR.

Gross Axle Weight Rating (GAWR): The total allowable weight that can be carried by a single axle (front or rear).

To assure that your vehicle does not exceed the maximum permissible weight limits (GVWR and GAWR for front and rear axle), have the loaded vehicle (including driver, passengers and all cargo and, if applicable, trailer

fully loaded) weighed on a suitable commercial scale.

Trailer tongue load

The tongue load of any trailer is an important weight to measure because it affects the load you can carry in your vehicle. If a trailer is towed, the tongue load must be added to the weight of all occupants riding and any cargo you are carrying in the vehicle. The tongue load typically is 10% of the trailer weight and everything loaded in it.

Your Mercedes-Benz has been designed primarily to carry passengers and their cargo. Mercedes-Benz does not recommend trailer towing with your vehicle.

Recommended tire inflation pressure

Warning!

Follow recommended tire inflation pressures.

Do not underinflate tires. Underinflated tires wear excessively and/or unevenly, adversely affect handling and fuel economy, and are more likely to fail from being overheated.

Do not overinflate tires. Overinflated tires can adversely affect handling and ride comfort, wear unevenly, increase stopping distance, and result in sudden deflation (blowout) because they are more likely to become punctured or damaged by road debris, potholes etc.

Do not overload the tires by exceeding the specified load limit as indicated on the Tire and Loading Information placard on the driver's door B-pillar. Overloading the tires can overheat them, possibly causing a blowout. Overloading the tires can also result in handling or steering problems, or brake failure.

Your vehicle is equipped with the Tire and Loading Information placard located on the driver's door B-pillar (▷ page 212).

Tires and wheels

The tire inflation pressure should be checked regularly and should only be adjusted on cold tires. The tires can be considered cold if the vehicle has been parked for at least 3 hours or driven less than 1 mile (1.6 km).

Follow recommended cold tire inflation pressures listed on Tire and Loading Information placard on the driver's door B-pillar.

Keeping the tires properly inflated provides the best handling, tread life and riding comfort.

In addition to the Tire and Loading Information placard on the driver's door B-pillar, also consult the tire inflation pressure label (if available) on the inside of the filler flap for any additional information pertaining to special driving situations. For more information, see "Important notes on tire inflation pressure" (▷ page 216).

 Data shown on Tire and Loading Information placard example are for illustration purposes only. Tire data are specific to each vehicle and may vary from data shown in the following illustration. Refer to Tire and Loading Information placard on vehicle for actual data specific to your vehicle.

Tires and wheels

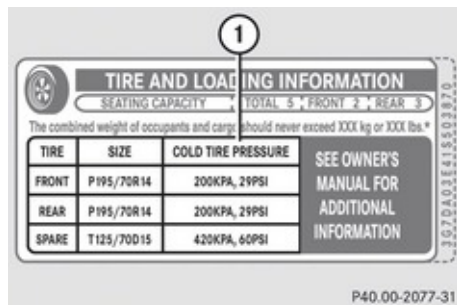

- ① Tire and Loading Information placard with recommended cold tire inflation pressures

The Tire and Loading Information placard lists the recommended cold tire inflation pressures for maximum loaded vehicle weight. The tire inflation pressures listed apply to the tires installed as original equipment.

Important notes on tire inflation pressure

Warning!

If the tire inflation pressure drops repeatedly, check the tires for punctures from foreign objects and/or whether air is leaking from the valves or from around the rim.

Tire temperature and tire inflation pressure are also increased while driving, depending on the driving speed and the tire load.

If you will be driving your vehicle at high speeds of 100 mph (160 km/h) or higher, where it is legal and conditions allow, consult the tire inflation pressure label on the inside of the fuel filler flap (if available) on how to adjust the cold tire inflation pressure. If you do not adjust the tire inflation pressure, excessive heat can build up and result in sudden tire failure.

If your vehicle is not equipped with the tire inflation pressure label on the inside of the fuel filler flap, contact an authorized Mercedes-Benz Center for proper tire inflation pressure.

- ① Driving comfort may be reduced when the tire inflation pressure is adjusted to the value for speeds above 100 mph (160 km/h) as specified on the tire inflation pressure label located on the inside of the fuel filler flap.

Make sure to readjust the tire inflation pressure for normal driving speeds. You should wait until the tires are cold before adjusting the tire inflation pressure.

Some vehicles may have supplemental tire inflation pressure information for vehicle

loads less than the maximum loaded vehicle condition. If such information is provided, it can be found on the tire inflation pressure label located on the inside of the fuel filler flap (▷ page 201).

Tire inflation pressure changes by approximately 1.5 psi (0.1 bar) per 18°F (10°C) of air temperature change. Keep this in mind when checking tire inflation pressure where the temperature is different from the outside temperature.

Potential problems associated with underinflated and overinflated tires

Underinflated tires

Warning!

Follow recommended tire inflation pressures.

Do not underinflate tires. Underinflated tires wear excessively and/or unevenly, adversely affect handling and fuel economy, and are more likely to fail from being overheated.

Underinflated tires can

- cause excessive and uneven tire wear
- adversely affect fuel economy

Tires and wheels

- lead to tire failure from being overheated
- adversely affect handling characteristics

Overinflated tires**⚠ Warning!**

Follow recommended tire inflation pressures.

Do not overinflate tires. Overinflated tires can adversely affect handling and ride comfort, wear unevenly, increase stopping distance, and result in sudden deflation (blowout) because they are more likely to become punctured or damaged by road debris, potholes etc.

Overinflated tires can

- adversely affect handling characteristics
- cause uneven tire wear
- be more prone to damage from road hazards
- adversely affect ride comfort
- increase stopping distance

Checking tire inflation pressure**Safety notes****⚠ Warning!**

Follow recommended tire inflation pressures.

Do not underinflate tires. Underinflated tires wear excessively and/or unevenly, adversely affect handling and fuel economy, and are more likely to fail from being overheated.

Do not overinflate tires. Overinflated tires can adversely affect handling and ride comfort, wear unevenly, increase stopping distance, and result in sudden deflation (blowout) because they are more likely to become punctured or damaged by road debris, potholes etc.

Do not overload the tires by exceeding the specified load limit as indicated on the Tire and Loading Information placard on the driver's door B-pillar. Overloading the tires can overheat them, possibly causing a blowout. Overloading the tires can also result in handling or steering problems, or brake failure.

Check the tire inflation pressure at least every other week.

Check and adjust the tire inflation pressure when the tires are cold. The tires can be considered cold if the vehicle has been parked for at least 3 hours or driven less than 1 mile (1.6 km).

If you check the tire inflation pressure when the tires are warm (the vehicle has been driven for several miles or sitting less than 3 hours), the reading will be approximately 4 psi (0.3 bar) higher than the cold reading. This is normal. Do not let air out to match the specified cold tire inflation pressure. Otherwise, the tire will be underinflated.

Checking tire inflation pressure manually

Follow the steps below to achieve correct tire inflation pressure:

- ▶ Remove the cap from the valve on one tire.
- ▶ Firmly press a tire gauge onto the valve.
- ▶ Read the tire inflation pressure on the tire gauge and check against the recommended tire inflation pressure on the Tire and Loading Information placard on the driver's door B-pillar (▷ page 212). If necessary, add air to achieve the recommended tire inflation pressure.



Tires and wheels

- ▶ If you have overfilled the tire, release tire inflation pressure by pushing the metal stem of the valve with e.g. a tip of a pen. Then recheck the tire inflation pressure with the tire gauge.
- ▶ Install the valve cap.
- ▶ Repeat this procedure for each tire.

Tire Pressure Monitoring System (TPMS), (USA only)

- i** The Tire Pressure Monitoring System (TPMS) is equipped with a combination low tire pressure/TPMS malfunction telltale in the instrument cluster. Depending on how the telltale illuminates, it indicates a low tire pressure condition or a malfunction in the TPMS system itself:
 - If the telltale illuminates continuously, one or more of your tires is significantly underinflated. There is no malfunction in the TPMS.
 - If the telltale flashes for 60 seconds and then stays illuminated, the TPMS system itself is not operating properly.

1 This device complies with Part 15 of the FCC Rules. Operation is subject to the following two conditions:

1. This device may not cause harmful interference, and
2. this device must accept any interference received, including interference that may cause undesired.

Any unauthorized modification to this device could void the user's authority to operate the equipment.

The TPMS only functions on wheels that are equipped with the proper electronic sensors. It monitors the tire inflation pressure, as selected by the driver, in all four tires. A warning is issued to alert you to a decrease in pressure in one or more of the tires.

⚠ Warning!

The TPMS does not indicate a warning for wrongly selected inflation pressures. Always adjust tire inflation pressure according to the Tire and Loading Information placard or, if available, on the supplemental tire inflation pressure information on the inside of the fuel filler flap.

The TPMS is not able to issue a warning due to a sudden dramatic loss of pressure (e.g.

tire blowout caused by a foreign object). In this case bring the vehicle to a halt by carefully applying the brakes and avoiding abrupt steering maneuvers.

⚠ Warning!

Each tire, including the spare (if provided), should be checked every other week when cold and inflated to the inflation pressure recommended by the vehicle manufacturer on the Tire and Loading Information placard on the driver's door B-pillar or, if available, the tire inflation pressure label on the inside of the fuel filler flap. If your vehicle has tires of a different size than the size indicated on the Tire and Loading Information placard or, if available, the tire inflation pressure label, you should determine the proper tire inflation pressure for those tires.

As an added safety feature, your vehicle has been equipped with a tire pressure monitoring system (TPMS) that illuminates a low tire pressure telltale when one or more of your tires are significantly underinflated. Accordingly, when the low tire pressure telltale illuminates, you should stop and check your tires as soon as possible, and inflate them to the proper pressure. Driving on a significantly underinflated tire causes

Tires and wheels

the tire to overheat and can lead to tire failure.

Underinflation also reduces fuel efficiency and tire tread life, and may affect the vehicle's handling and stopping ability. Please note that the TPMS is not a substitute for proper tire maintenance, and it is the driver's responsibility to maintain correct tire pressure, even if underinflation has not reached the level to trigger illumination of the TPMS low tire pressure telltale.

Your vehicle has also been equipped with a TPMS malfunction indicator to indicate when the system is not operating properly. The TPMS malfunction indicator is combined with the low tire pressure telltale. When the system detects a malfunction, the telltale will flash for approximately 1 minute and then remain continuously illuminated. This sequence will continue upon subsequent vehicle start-ups as long as the malfunction exists. When the malfunction indicator is illuminated, the system may not be able to detect or signal low tire pressure as intended.

TPMS malfunctions may occur for a variety of reasons, including the installation of incompatible replacement or alternate tires

or wheels on the vehicle that prevent the TPMS from functioning properly. Always check the TPMS malfunction telltale after replacing one or more tires or wheels on your vehicle to ensure that the replacement or alternate tires and wheels allow the TPMS to continue to function properly.

- ❶ If a condition causing the TPMS to malfunction develops, it may take up to 10 minutes for the system to signal a malfunction using the TPMS telltale flashing and illumination sequence.

The telltale extinguishes after a few minutes driving if the malfunction has been corrected.

- ❶ Operating radio transmission equipment (e.g. wireless headsets, two-way radios) in or near the vehicle could cause the TPMS to malfunction.

Tire inflation pressure warnings

If the system detects a significant loss of tire inflation pressure in one or more than one tire, a message appears in the multifunction display.

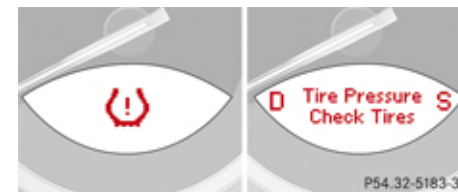

Example illustration

In addition, a warning signal sounds.

Restarting the TPMS

Warning!

It is the driver's responsibility to calibrate the TPMS on the recommended cold inflation pressure. Underinflated tires affect the ability to steer or brake the vehicle. You might lose control over the vehicle.

The TPMS must be restarted when you have adjusted the tire inflation pressure to a new level (e.g. because of different load or driving conditions). The TPMS is then recalibrated to the current tire inflation pressures.





- ▶ Using the Tire and Loading Information placard on the driver's door B-pillar (▷ page 212) or, if available, the supplemental tire inflation pressure information on the inside of the fuel filler flap



Tires and wheels

(▷ page 201), make sure the tire inflation pressure of all four tires is correct.

i Restart the TPMS after adjusting the tire inflation pressure to the inflation pressure recommended for the vehicle operating condition. Tire pressure should only be adjusted on cold tires. Observe the recommended tire inflation pressure on the Tire and Loading Information placard on the driver's door B-pillar. Some vehicles may have supplemental tire pressure information for driving at high speeds or for vehicle loads less than the maximum loaded vehicle condition. If such information is provided, it can be found on the inside of the fuel filler flap.

- ▶ Switch on the ignition.
- ▶ Press button  or  on the multifunction steering wheel repeatedly until the standard display appears in the multifunction display (▷ page 129).
- ▶ Press button  or  repeatedly until you see the current inflation pressures for each tire appear in the display or the following message appears in the display
Tire Pressure Monitor
Active
Menu: R-Button

▶ Press the reset button (▷ page 124).
The following message will appear in the multifunction display:
Restart tire
pressure monitor?

▶ **If you wish to confirm:** Press button .

The following message will appear in the multifunction display:
Tire Pressure Monitor
Restarted

After driving a few minutes the system verifies that the current tire inflation pressures are within the system's specified range. Afterwards the current tire inflation pressures are accepted as reference values and then monitored.

▶ **If you wish to cancel:** Press button .

Advanced Tire Pressure Monitoring System (Advanced TPMS), (Canada only)

i This device complies with RSS-210 of Industry Canada. Operation is subject to the following two conditions:

1. This device may not cause interference, and
2. this device must accept any interference received, including interference that may cause undesired operation of the device.

Any unauthorized modification to this device could void the user's authority to operate the equipment.

The TPMS only functions on wheels that are equipped with the proper electronic sensors. It monitors the tire inflation pressure, as selected by the driver, in all four tires. A warning is issued to alert you to a decrease in pressure in one or more of the tires.

Warning!

The TPMS does not indicate a warning for wrongly selected inflation pressures. Always adjust tire inflation pressure according to the Tire and Loading Information placard or, if available, on the supple-

Tires and wheels

mental tire inflation pressure information on the inside of the fuel filler flap.

The TPMS is not able to issue a warning due to a sudden dramatic loss of pressure (e.g. tire blowout caused by a foreign object). In this case bring the vehicle to a halt by carefully applying the brakes and avoiding abrupt steering maneuvers.

Warning!



Each tire, including the spare (if provided), should be checked every other week when cold and inflated to the inflation pressure recommended by the vehicle manufacturer on the Tire and Loading Information placard on the driver's door B-pillar or, if available, the tire inflation pressure label on the inside of the fuel filler flap. If your vehicle has tires of a different size than the size indicated on the Tire and Loading Information placard or, if available, the tire inflation pressure label, you should determine the proper tire inflation pressure for those tires.

As an added safety feature, your vehicle has been equipped with a tire pressure monitoring system (TPMS) that illuminates a low tire pressure telltale when one or more of your tires are significantly underinflated. Accordingly, when the low tire pressure



telltale illuminates, you should stop and check your tires as soon as possible. Driving on a significantly underinflated tire causes the tire to overheat and can lead to tire failure.

Underinflation also reduces fuel efficiency and tire tread life, and may affect the vehicle's handling and stopping ability. Please note that the TPMS is not a substitute for proper tire maintenance, and it is the driver's responsibility to maintain correct tire pressure, even if underinflation has not reached the level to trigger illumination of the TPMS low tire pressure telltale.

Tire pressure inquiries are made using the multifunction display. The present inflation pressures are displayed only after a few minutes' travel time.

-  Possible differences between the readings of a tire pressure gauge of an air hose, e.g. gas station equipment, and the vehicle's control system can occur. Usually the readings issued by the control system are more precise.
- ▶ Switch on the ignition.
- ▶ Press button  or  on the multifunction steering wheel repeatedly until the

standard display appears in the multifunction display (▶ page 129).

- ▶ Press button  or  until the current inflation pressures for each tire appear in the multifunction display.

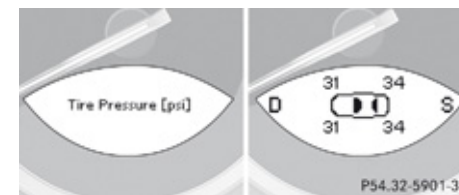

-  When the vehicle has been parked for longer than 20 minutes, the message appears in the multifunction display.

Warning!

It is the driver's responsibility to calibrate the TPMS on the recommended cold inflation pressure. Underinflated tires affect the ability to steer or brake the vehicle. You might lose control over the vehicle.

-  With a spare wheel mounted, the system may still indicate the tire inflation pressure of the removed road wheel for some minutes. If this happens, keep in mind that the indicated value where the spare wheel



Tires and wheels

is mounted does not reflect the actual spare tire inflation pressure.

- ❗ Operating radio transmission equipment (e.g. wireless headsets, two-way radios) in or near the vehicle could cause the TPMS to malfunction.

Tire inflation pressure warnings

If the system detects a significant loss of tire inflation pressure in one or more than one tire, a message appears in the multifunction display.

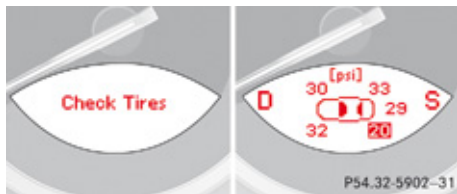

The respective tire is indicated by a red rectangle. In addition, a warning signal sounds.

Restarting Advanced TPMS

⚠ Warning!

It is the driver's responsibility to calibrate the TPMS on the recommended cold inflation pressure. Underinflated tires affect the

ability to steer or brake the vehicle. You might lose control over the vehicle.

The TPMS usually recognizes new reference values automatically, for example when you have

- adjusted the tire inflation pressure
- changed wheels or tires
- mounted new wheels or tires

If you want to set new reference values manually:

- ▶ Using the Tire and Loading Information placard on the driver's door B-pillar (▷ page 212) or, if available, the supplemental tire inflation pressure information on the inside of the fuel filler flap (▷ page 201), make sure the tire inflation pressure of all four tires is correct.

- ❗ Restart the TPMS after adjusting the tire inflation pressure to the inflation pressure recommended for the vehicle operating condition. Tire pressure should only be adjusted on cold tires. Observe the recommended tire inflation pressure on the Tire and Loading Information placard on the driver's door B-pillar. Some vehicles may have supplemental tire pressure informa-

tion for driving at high speeds or for vehicle loads less than the maximum loaded vehicle condition. If such information is provided, it can be found on the inside of the fuel filler flap.

- ▶ Switch on the ignition.
- ▶ Press button or on the multifunction steering wheel repeatedly until the standard display appears in the multifunction display (▷ page 129).
- ▶ Press button or repeatedly until you see the current inflation pressures for each tire appear in the display or the following message appears in the multifunction display
Tire pressure displayed after driving for a few minutes.
- ▶ Press the reset button (▷ page 124).
The following message will appear in the multifunction display:
Restart tire pressure monitor?

- **If you wish to confirm:** Press button



The following message will appear in the multifunction display:

Tire Pressure Monitor
Restarted

After driving a few minutes the system verifies that the current tire inflation pressures are within the system's specified range.

Afterwards the current tire inflation pressures are accepted as reference values and then monitored.

or

- **If you wish to cancel:** Press button



MOExtended system

The MOExtended system allows you to continue driving your vehicle even if there is a total loss of pressure in one or more tires.

You may only use the MOExtended system in conjunction with the TPMS (▷ page 218) or the Advanced TPMS (▷ page 220).

For information on driving in case of pressure loss in one or more tires (emergency mode), see the "Practical Hints" section (▷ page 325).

Tire labeling

Besides tire name (sales designation) and manufacturer name, a number of markings can be found on a tire.

Following are some explanations for the markings on your vehicle's tires:

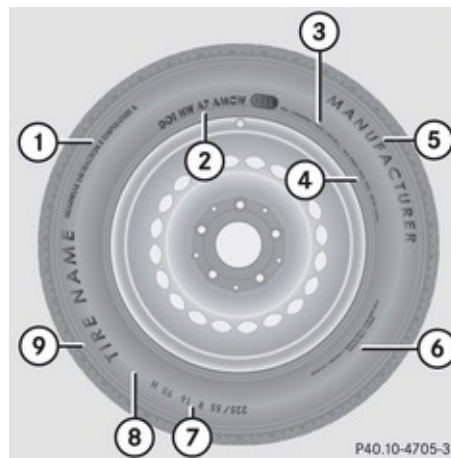

- ① Uniform Tire Quality Grading Standards (▷ page 229)
- ② DOT, Tire Identification Number (▷ page 227)
- ③ Maximum tire load (▷ page 228)
- ④ Maximum tire inflation pressure (▷ page 228)

- ⑤ Manufacturer
- ⑥ Tire ply material (▷ page 230)
- ⑦ Tire size designation, load and speed rating (▷ page 224)
- ⑧ Load identification (▷ page 226)
- ⑨ Tire name

i For illustration purposes only. Actual data on tires are specific to each vehicle and may vary from data shown in above illustration.

For more information, see "Rims and tires" (▷ page 343).

Tires and wheels

Tire size designation, load and speed rating

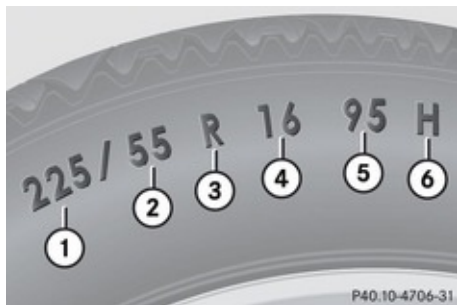

- ① Tire width
- ② Aspect ratio in %
- ③ Radial tire code
- ④ Rim diameter
- ⑤ Tire load rating
- ⑥ Tire speed rating

i For illustration purposes only. Actual data on tires are specific to each vehicle and may vary from data shown in above illustration.

General: Depending on the design standards used, the tire size molded into the sidewall may have no letter or a letter preceding the tire size designation.

No letter preceding the size designation (as illustrated above): Passenger car tire based on European design standards.

Letter “P” preceding the size designation: Passenger car tire based on U.S. design standards.

Letter “LT” preceding the size designation: Light Truck tire based on U.S. design standards.

Letter “T” preceding the size designation: Temporary spare tires which are high pressure compact spares designed for temporary emergency use only.

Tire width

Tire width ① indicates the nominal tire width in millimeters.

Aspect ratio

Aspect ratio ② is the dimensional relationship between tire section height and section width and is expressed in percentage. The aspect ratio is arrived at by dividing section height by section width.

Tire code

Tire code ③ indicates the tire construction type. The “R” stands for radial tire type. Letter

“D” means diagonal or bias ply construction; letter “B” means belted-bias ply construction.

At the tire manufacturer’s option, any tire with a speed capability above 149 mph (240 km/h) can include a “ZR” in the size designation (for example: 245/40 ZR 18). For additional information, see “Tire speed rating” (▷ page 225).

Rim diameter

Rim diameter ④ is the diameter of the bead seat, not the diameter of the rim edge. The rim diameter is indicated in inches (in).

Tire load rating

⚠ Warning!

The tire load rating must always be at least half of the GAWR of your vehicle. Otherwise, tire failure may be the result which may cause an accident and/or serious injury to you or others.

Always replace rims and tires with the same designation, manufacturer and type as shown on the original part.

⚠ Warning!

Do not overload the tires by exceeding the specified load limit as indicated on the Tire

Tires and wheels

and Loading Information placard on the driver’s door B-pillar. Overloading the tires can overheat them, possibly causing a blowout. Overloading the tires can also result in handling or steering problems, or brake failure.

Tire load rating ⑤ is a numerical code associated with the maximum load a tire can support.

For example, a load rating of 91 corresponds to a maximum load of 1356 lb (615 kg) the tire is designed to support. See also “Maximum tire load” (▷ page 228) where the maximum load associated with the load index is indicated in kilograms and lbs.

For additional information on tire load rating, see “Load identification” (▷ page 226).

Tire speed rating

⚠ Warning!

Even when permitted by law, never operate a vehicle at speeds greater than the maximum speed rating of the tires.

Exceeding the maximum speed for which tires are rated can lead to sudden tire failure, causing loss of vehicle control and possibly resulting in an accident and/or

serious personal injury and possible death, for you and for others.

Regardless of the tire speed rating, local speed limits should be obeyed. Use prudent driving speeds appropriate to prevailing conditions.

Tire speed rating ⑥ indicates the approved maximum speed for the tire.

Summer tires

Index	Speed rating
Q	up to 100 mph (160 km/h)
R	up to 106 mph (170 km/h)
S	up to 112 mph (180 km/h)
T	up to 118 mph (190 km/h)
H	up to 130 mph (210 km/h)
V	up to 149 mph (240 km/h)
W	up to 168 mph (270 km/h)
Y	up to 186 mph (300 km/h)
ZR...Y	up to 186 mph (300 km/h)

Index	Speed rating
ZR...(..Y)	above 186 mph (300 km/h)
ZR	above 149 mph (240 km/h)

- At the tire manufacturer’s option, any tire with a speed capability above 149 mph (240 km/h) can include a “ZR” in the size designation (for example: 245/40 ZR18). To determine the maximum speed capability of the tire, the service description for the tire must be referred to.

The service description is comprised of tire load rating ⑤ and tire speed rating ⑥.

If your tire includes “ZR” in the size designation and no service description is given, the tire manufacturer must be consulted for the maximum speed capability.

If a service description is given, the speed capability is limited by the speed symbol in the service description. Example: 245/40 ZR18 97Y. In this example, “97Y” is the service description. The letter “Y” designates the speed rating and the speed capability of the tire is limited to 186 mph (300 km/h).

- Any tire with a speed capability above 186 mph (300 km/h) must include a “ZR”

Tires and wheels

in the size designation AND the service description must be placed in parenthesis. Example: 275/40 ZR 18 (99Y). The “(Y)” speed rating in parenthesis designates the maximum speed capability of the tire as being above 186 mph (300 km/h). Consult the tire manufacturer for the actual maximum permissible speed of the tire.

All-season and winter tires

Index	Speed rating
Q M+S ⁹	up to 100 mph (160 km/h)
T M+S ⁹	up to 118 mph (190 km/h)
H M+S ⁹	up to 130 mph (210 km/h)
V M+S ⁹	up to 149 mph (240 km/h)

i Not all M+S rated tires provide special winter performance. Make sure the tires you use show M+S and the mountain/snowflake  marking on the tire sidewall. These tires meet specific snow traction performance requirements of the Rubber Manufacturers Association (RMA) and the Rubber Association of Canada

⁹ or M+S  for winter tires

(RAC) and have been designed specifically for use in snow conditions.

An electronic speed limiter prevents your vehicle from exceeding a speed of:

- 155 mph (250 km/h):
 - SL 550
 - SL 550 (Sport Package)
 - SL 600
 - SL 600 (Sport Package)
 - SL 63 AMG
 - SL 65 AMG
- 186 mph (300 km/h):
 - SL 63 AMG (Performance Package)
 - SL 65 AMG with increased top speed

The factory equipped tires on your vehicle may have a tire speed rating above the maximum speed permitted by the electronic speed limiter.

Make sure your tires have the required tire speed rating as specified for your vehicle in the “Technical data” section (▷ page 343), for example when purchasing new tires.

If you are uncertain about the correct reading of the information given on a tire’s sidewall,

any authorized Mercedes-Benz Center will be glad to assist you.

Load identification



① Load identification

i For illustration purposes only. Actual data on tires are specific to each vehicle and may vary from data shown in above illustration.

In addition to tire load rating, special load identification ① may be molded into the tire sidewall following the letter designating the tire speed rating ⑥ (▷ page 224).

Tires and wheels

- No specification given: absence of any text (like in above example) indicates a standard load (SL) tire.
- XL or Extra Load: designates an extra load (or reinforced) tire.
- Light Load: designates a light load tire.
- C, D, E: designates load range associated with the maximum load a tire can carry at a specified pressure.

DOT, Tire Identification Number (TIN)

U.S. tire regulations require each new tire manufacturer or tire retreader to mold a TIN into or onto a sidewall of each tire produced. The TIN is a unique identifier which facilitates efforts by tire manufactures to notify purchasers in recall situations or other safety matters concerning tires and gives purchasers the means to easily identify such tires. The TIN is comprised of “Manufacturer’s identification mark”, “Tire size”, “Tire type code” and “Date of manufacture”.



- ① DOT
 - ② Manufacturer’s identification mark
 - ③ Tire size
 - ④ Tire type code (at the option of the tire manufacturer)
 - ⑤ Date of manufacture
- i** For illustration purposes only. Actual data on tires are specific to each vehicle and may vary from data shown in above illustration.

DOT (Department of Transportation)

Tire branding symbol ① denotes that the tire meets requirements of the U.S. Department of Transportation.

Manufacturer’s identification mark

Manufacturer’s identification mark ② denotes the tire manufacturer. New tires have a mark with two symbols. Retreaded tires have a mark with four symbols. For more information on retreaded tires, see (▷ page 209).

Tire size

Code ③ indicates the tire size.

Tire type code

Tire type code ④ may, at the option of the manufacturer, be used as a descriptive code for identifying significant characteristics of the tire.

Date of manufacture

The date of manufacture ⑤ identifies the week and year of manufacture. The first two figures identify the week, starting with “01” to represent the first full week of the calendar year. The second two figures represent the year. For example, “3202” represents the 32nd week of 2002.

Tires and wheels

Maximum tire load

⚠ Warning!

Do not overload the tires by exceeding the specified load limit as indicated on the Tire and Loading Information placard on the driver's door B-pillar. Overloading the tires can overheat them, possibly causing a blowout. Overloading the tires can also result in handling or steering problems, or brake failure.



① Maximum tire load rating

i For illustration purposes only. Actual data on tires are specific to each vehicle and may vary from data shown in above illustration.

The maximum tire load is the maximum weight the tires are designed to support.

For more information on tire load rating, see (> page 224).

For information on calculating total and cargo load capacities, see (> page 213).

Maximum tire inflation pressure

⚠ Warning!

Never exceed the maximum tire inflation pressure. Follow recommended tire inflation pressures.

Do not underinflate tires. Underinflated tires wear excessively and/or unevenly, adversely affect handling and fuel economy, and are more likely to fail from being overheated.

Do not overinflate tires. Overinflated tires can adversely affect handling and ride comfort, wear unevenly, increase stopping distance, and result in sudden deflation (blowout) because they are more likely to become punctured or damaged by road debris, potholes etc.



① Maximum permissible tire inflation pressure

i For illustration purposes only. Actual data on tires are specific to each vehicle and may vary from data shown in above illustration.

This is the maximum permissible tire inflation pressure for the tire.

Always follow the recommended tire inflation pressure (> page 215) for proper tire inflation.

Uniform Tire Quality Grading Standards

The Uniform Tire Quality Grading is a U.S. Government requirement designed to give drivers consistent and reliable information regarding tire performance. Tire manufacturers are required to grade tires based on three performance factors: treadwear, traction, and temperature resistance. Although not a Government of Canada requirement, all tires made for sale in North America have these grades branded on the sidewall.

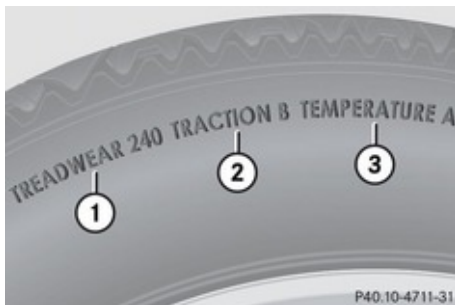

- ① Treadwear
- ② Traction
- ③ Temperature resistance

i For illustration purposes only. Actual data on tires are specific to each vehicle and

may vary from data shown in above illustration.

Quality grades can be found, where applicable, on the tire sidewall between tread shoulder and maximum section width. For example:

Treadwear	Traction	Temperature
200	AA	A

All passenger car tires must conform to federal safety requirements in addition to these grades.

Treadwear

The treadwear grade is a comparative rating based on the wear rate of the tire when tested under controlled conditions on a specified U.S. Government test course. For example, a tire graded 150 would wear one and one-half (1 1/2) times as well on the government course as a tire graded 100.

The relative performance of tires depends upon the actual conditions of their use, however, and may depart significantly from the norm due to variations in driving habits, service practices and differences in road characteristics and climate.

Traction

Warning!

The traction grade assigned to this tire is based on straight-ahead braking traction tests, and does not include acceleration, cornering, hydroplaning, or peak traction characteristics.

The traction grades, from highest to lowest, are AA, A, B, and C. Those grades represent the tire's ability to stop on wet pavement as measured under controlled conditions on specified government test surfaces of asphalt and concrete. A tire marked C may have poor traction performance.

Warning!

If ice has formed on the road, tire traction will be substantially reduced. Under such weather conditions, drive, steer and brake with extreme caution.

The safe speed on a wet, snow covered or icy road is always lower than on a dry road.

You should pay particular attention to the condition of the road whenever the outside temperature is close to the freezing point.

Mercedes-Benz recommends winter tires (▷ page 234) with a minimum tread depth of approximately 1/6 in (4 mm) on all four wheels



Tires and wheels

for the winter season to ensure normal balanced handling characteristics. On packed snow, they can reduce your stopping distance compared to summer tires. Stopping distance, however, is still considerably greater than when the road is not covered with snow or ice. Exercise appropriate caution.

! Avoid spinning of a drive wheel. This may cause serious damage to the drivetrain which is not covered by the Mercedes-Benz Limited Warranty.

Temperature

Warning!

The temperature grade for this tire is established for a tire that is properly inflated and not overloaded. Excessive speed, underinflation, or excessive loading, either separately or in combination, can cause excessive heat build-up and possible tire failure.

The temperature grades are A (the highest), B, and C, representing the tire's resistance to the generation of heat and its ability to dissipate heat when tested under controlled conditions on a specified indoor laboratory test wheel. Sustained high temperature can cause the material of the tire to degenerate and reduce tire life, and excessive temperature

can lead to sudden tire failure. The grade C corresponds to a level of performance which all passenger car tires must meet under the Federal Motor Vehicle Safety Standard No. 109. Grades B and A represent higher levels of performance on the laboratory test wheel than the minimum required by law.

Tire ply material

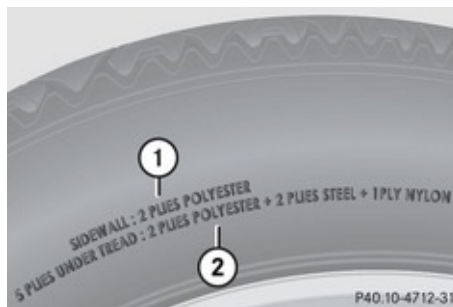

- ① Plies in sidewall
- ② Plies under tread

1 For illustration purposes only. Actual data on tires are specific to each vehicle and may vary from data shown in above illustration.

This marking tells you about the type of cord and number of plies in the sidewall and under the tread.

Tire and loading terminology

Accessory weight

The combined weight (in excess of those standard items which may be replaced) of automatic transmission, power steering, power brakes, power windows, power seats, radio, and heater, to the extent that these items are available as factory-installed equipment (whether installed or not).

Air pressure

The amount of air inside the tire pressing outward on each square inch of the tire. Air pressure is expressed in pounds per square inch (psi), or kilopascal (kPa) or bar.

Aspect ratio

Dimensional relationship between tire section height and section width expressed in percentage.

Tires and wheels

Bar

Another metric unit for air pressure. There are 14.5038 pounds per square inch (psi) to 1 bar; there are 100 kilopascals (kPa) to 1 bar.

Bead

The tire bead contains steel wires wrapped by steel cords that hold the tire onto the rim.

Cold tire inflation pressure

Tire inflation pressure when your vehicle has been sitting for at least 3 hours or driven no more than 1 mile (1.6 km).

Curb weight

The weight of a motor vehicle with standard equipment including the maximum capacity of fuel, oil, and coolant, and, if so equipped, air conditioning and additional optional equipment, but without passengers and cargo.

DOT (Department of Transportation)

A tire branding symbol which denotes the tire meets requirements of the U.S. Department of Transportation.

GAWR (Gross Axle Weight Rating)

The GAWR is the maximum permissible axle weight. The gross vehicle weight on each axle must never exceed the GAWR for the front and rear axle indicated on the certification label located on the driver's door B-pillar.

GVW (Gross Vehicle Weight)

The GVW comprises the weight of the vehicle including fuel, tools, spare wheel, installed accessories, passengers and cargo and, if applicable, trailer tongue load. The GVW must never exceed the GVWR indicated on the certification label located on the driver's door B-pillar.

GVWR (Gross Vehicle Weight Rating)

This is the maximum permissible vehicle weight of the fully loaded vehicle (weight of the vehicle including all options, passengers, fuel, and cargo and, if applicable, trailer tongue load). It is indicated on certification label located on the driver's door B-pillar.

Kilopascal (kPa)

The metric unit for air pressure. There are 6.9 kPa to 1 psi; another metric unit for air

pressure is bar. There are 100 kilopascals (kPa) to 1 bar.

Maximum load rating

The maximum load in kilograms and pounds that can be carried by the tire.

Maximum loaded vehicle weight

The sum of curb weight, accessory weight, total load limit, and production options weight.

Maximum permissible tire inflation pressure

This number is the greatest amount of air pressure that should ever be put in the tire.

Normal occupant weight

The number of occupants the vehicle is designed to seat, multiplied by 68 kilograms (150 lb).

Occupant distribution

The distribution of occupants in a vehicle at their designated seating positions.

Tires and wheels

Production options weight

The combined weight of those installed regular production options weighing over 5 lbs (2.3 kilograms) in excess of those standard items which they replace, not previously considered in curb weight or accessory weight, including heavy duty brakes, ride levelers, roof rack, heavy duty battery, and special trim.

PSI (Pounds per square inch)

A standard unit of measure for air pressure.

Recommended tire inflation pressure

The recommended tire inflation pressure for normal driving conditions is listed on the Tire and Loading Information placard located on the driver's door B-pillar and provides best handling, tread life and riding comfort. If so equipped, supplemental information pertaining to special driving situations can be found on the tire inflation pressure label on the inside of the fuel filler flap.

Rim

A metal support for a tire or a tire and tube assembly upon which the tire beads are seated.

Sidewall

The portion of a tire between the tread and the bead.

TIN (Tire Identification Number)

Unique identifier which facilitates efforts by tire manufacturers to notify purchasers in recall situations or other safety matters concerning tires and gives purchasers the means to easily identify such tires. The TIN is comprised of "Manufacturer's identification mark", "Tire size", "Tire type code" and "Date of manufacture".

Tire load rating

Numerical code associated with the maximum load a tire can support.

Tire ply composition and material used

This indicates the number of plies or the number of layers of rubber-coated fabric in the tire

tread and sidewall. Tire manufacturers also must indicate the ply materials in the tire and sidewall, which include steel, nylon, polyester, and others.

Tire speed rating

Part of tire designation; indicates the speed range for which a tire is approved.

Total load limit

Rated cargo and luggage load plus 68 kilograms (150 lb) times the vehicle's designated seating capacity.

Traction

Force exerted by the vehicle on the road via the tires. The amount of grip provided.

Tread

The portion of a tire that comes into contact with the road.

Treadwear indicators

Narrow bands, sometimes called "wear bars" that show across the tread of a tire when only $\frac{1}{16}$ in (1.6 mm) of tread remains.

Uniform Tire Quality Grading Standards

A tire information system that provides consumers with ratings for a tire's traction, temperature and treadwear. Ratings are determined by tire manufacturers using U.S. government testing procedures. The ratings are molded into the sidewall of the tire.

Vehicle maximum load on the tire

Load on an individual tire that is determined by distributing to each axle its share of the maximum loaded vehicle weight and dividing it by two.

Rotating tires

Warning!

Rotate front and rear wheels only if the tires are of the same dimension.

If your vehicle is equipped with mixed-size tires (different tire dimensions front vs. rear), tire rotation is not possible.

Warning!

Have the tightening torque checked after changing a wheel. Wheels could become

loose if not tightened with a torque of 96 lb-ft (130 Nm).

Only use genuine Mercedes-Benz wheel bolts specified for your vehicle's rims.

Tire rotation can be performed on vehicles with tires of the same dimension all around. If your vehicle is equipped with tires of the same dimension all around, tires can be rotated, observing a front-to-rear rotation pattern that will maintain the intended rotation (spinning) direction of the tire (> page 212).

In some cases, such as when your vehicle is equipped with mixed-size tires (different tire dimension front vs. rear), tire rotation is not possible.

If applicable to your vehicle's tire configuration, tires can be rotated according to the tire manufacturer's recommended intervals in the tire manufacturer's warranty pamphlet located in your vehicle literature portfolio. If none is available, tires should be rotated every 3 000 to 6 000 miles (5 000 to 10 000 km), or sooner if necessary, according to the degree of tire wear. The same rotation (spinning) direction must be maintained.

Rotate tires before the characteristic tire wear pattern becomes visible (shoulder wear

on front tires and tread center wear on rear tires).

Thoroughly clean the mounting face of wheels and brake disks, i.e. the inner side of the wheels/tires, during each rotation. Check for and ensure proper tire inflation pressure.

For information on wheel change, see "Flat tire" (> page 317).

Winter driving

Winter driving

General information

Have your vehicle winterized at an authorized Mercedes-Benz Center.

Winter tires

Warning!

Winter tires with a tread depth of less than $\frac{1}{8}$ in (4 mm) must be replaced. They are no longer suitable for winter operation.

Warning!

If you use your spare wheel when winter tires are fitted on the other wheels, be aware that the difference in tire characteristics may very well impair turning stability and that overall driving stability may be reduced. Adapt your driving style accordingly.

Have the spare wheel replaced by regular road wheel with a winter tire at the nearest authorized Mercedes-Benz Center.

Always use winter tires at temperatures below 45°F (7°C) and whenever wintry road conditions prevail. Not all M+S rated tires provide special winter performance. Make

sure the tires you use show the mountain/snowflake  marking on the tire sidewall. These tires meet specific snow traction performance requirements of the Rubber Manufacturers Association (RMA) and the Rubber Association of Canada (RAC) and have been designed specifically for use in snow conditions. Use of winter tires is the only way to achieve the maximum effectiveness of your vehicle's driving safety systems such as the ABS and the ESP® in winter operation. For safe handling, make sure all mounted winter tires are of the same make and have the same tread design.

Always observe the speed rating of the winter tires installed on your vehicle. If the maximum speed for which your tires are rated is below the speed rating of your vehicle, you must place a notice to this effect where it will be seen by the driver. Such notices are available at your tire dealer or any authorized Mercedes-Benz Center.

Snow chains

 When driving with snow chains, always select setting 1 of the vehicle level control. Other settings may result in damage to your vehicle.

 Some tire sizes do not leave adequate clearance for snow chains. To help avoid serious damage to your vehicle or tires, make sure the use of snow chains is permissible as specified in the “Technical data” section of this Operator's Manual.

Snow chains should only be driven on snow-covered roads at speeds not to exceed 30 mph (50 km/h). Remove chains as soon as possible when driving on roads without snow.

Observe the following guidelines when using snow chains:

- Use of snow chains is not permissible with all wheel/tire combinations (▷ page 343).
- Use snow chains in pairs and on rear wheels only. Follow the manufacturer's mounting instructions.

 If snow chains are mounted to the front wheels, they may scrape against the body

Winter driving

or axle components. The tires or the vehicle could be damaged as a result.

- Only use snow chains that are approved by Mercedes-Benz. Any authorized Mercedes-Benz Center will be glad to advise you on this subject.
 - Use of snow chains may be prohibited depending on location. Always check local and state laws before installing snow chains.
 - Do not use snow chains on the spare wheel.
- i** When driving with snow chains, you may wish to switch off the ESP® (▷ page 65) before setting the vehicle in motion. This will improve the vehicle's traction.

Winter driving instructions

⚠ Warning!

If the vehicle becomes stuck in snow, make sure snow is kept clear of the exhaust pipe and from around the vehicle with the engine running. Otherwise, deadly carbon monoxide (CO) gases may enter vehicle interior resulting in unconsciousness and death. To assure sufficient fresh air ventilation, open a window slightly on the side of the vehicle not facing the wind.

⚠ Warning!

The outside temperature indicator is not designed to serve as an ice-warning device and is therefore unsuitable for that purpose.

Indicated temperatures just above the freezing point do not guarantee that the road surface is free of ice. The road may still be icy, especially in wooded areas or on bridges.

⚠ Warning!

On slippery road surfaces, never downshift in order to obtain braking action. This could result in drive wheel slip and reduced vehi-

cle control. Your vehicle's ABS will not prevent this type of loss of control.

The most important rule for slippery or icy roads is to drive sensibly and to avoid abrupt acceleration, braking and steering maneuvers. Do not use the cruise control system under such conditions.

When the vehicle is in danger of skidding, shift the automatic transmission to neutral position **N**. Try to keep the vehicle under control by corrective steering action.

i For information on driving with snow chains, see "Snow chains" (▷ page 234).

Road salts and chemicals can adversely affect braking efficiency. Increased pedal force may become necessary to produce the normal brake effect.

Depressing the brake pedal periodically when traveling at length on salt-strewn roads can bring road-salt-impaired braking efficiency back to normal.

If the vehicle is parked after being driven on salt-treated roads, the braking efficiency should be tested as soon as possible after driving is resumed.

Driving instructions

Warning!

Make sure not to endanger any other road users when carrying out these braking maneuvers.

Driving instructions

Drive sensibly – save fuel

To save fuel you should:

- Keep tires at the recommended inflation pressures.
- Remove unnecessary loads.
- Allow engine to warm up under low load use.
- Avoid frequent acceleration and deceleration.
- Have all maintenance work performed at the intervals specified in the Maintenance Booklet and as required by the Maintenance system. Contact an authorized Mercedes-Benz Center.

Fuel consumption is also increased by driving in cold weather, in stop-and-go traffic, on short trips and in mountainous areas.

Drinking and driving

Warning!

Drinking and driving and/or taking drugs and driving are very dangerous combinations. Even a small amount of alcohol or drugs can affect your reflexes, perceptions and judgment.

The possibility of a serious or even fatal accident are greatly increased when you drink or take drugs and drive.

Do not drink or take drugs and drive or allow anyone to drive who has been drinking or taking drugs.

Pedals

Warning!

Make sure absolutely no objects are obstructing the pedals' range of movement. Keep the driver's footwell clear of all obstacles. If there are any floor mats or carpets in the footwell, make sure that the pedals still have sufficient clearance.

During sudden driving or braking maneuvers, the objects could get caught between the pedals. You could then no longer brake

Driving instructions

or accelerate. This could lead to accidents and injury.

Power assistance

⚠ Warning!

There is no power assistance for the steering and the service brake when the engine is not running.

Steering and braking requires significantly more effort and you could lose control of the vehicle and cause an accident as a result.

Do not turn off the engine while the vehicle is in motion.

⚠ Warning!

The brake system requires electrical energy for operation.

A malfunction in the vehicle's power supply or electrical system may impair brake system operation and switch it into its emergency operation mode. In such a case, the red brake warning lamp and warning messages in the instrument cluster come on while driving. To brake, the driver must then apply significantly greater brake pedal

pressure and depress the pedal much further to obtain the expected brake effect. If necessary, apply full pressure to the brake pedal. Brakes are only applied to the front wheels. Stopping distance is increased! If there is a malfunction in the electro-hydraulic brake system, we recommend that the vehicle be transported with all wheels off the ground using flatbed or appropriate wheel lift/dolly equipment.

Brakes

Downhill grades

! When driving down long and steep grades, relieve the load on the brakes by shifting into a lower gear to use the engine's braking power. This helps prevent overheating of the brakes and reduces wear.

When using the engine's braking power, a drive wheel may not spin for an extended period of time, e.g. on slippery road surfaces. This may cause serious damage to the drivetrain which is not covered by the Mercedes-Benz Limited Warranty.

Continuous or hard braking

⚠ Warning!

Resting your foot on the brake pedal will cause excessive and premature wear of the brake pads.

It can also result in the brakes overheating, thereby significantly reducing their effectiveness. It may not be possible to stop the vehicle in sufficient time to avoid an accident.

After hard braking, it is advisable to drive on for some time, rather than immediately park, so that the air stream will cool down the brakes faster.

Wet roads

⚠ Warning!

After driving in heavy rain for some time without applying the brakes or through water deep enough to wet brake components, the first braking action may be somewhat reduced and increased pedal pressure may be necessary to obtain expected brake effect. Maintain a safe distance from vehicles in front.

Driving instructions

The first time the brakes are applied after a long period of driving in heavy rain without braking, it is possible that there will be a delayed braking response and that you will need to depress the brake pedal more firmly.

You should therefore maintain a greater distance from the vehicle in front.

To help prevent brake disk corrosion after driving on wet or salt-covered roads, it is advisable to brake the vehicle with considerable force prior to parking. The heat generated serves to dry the brakes.

Salt-covered roads

Warning!

A layer of salt on the brake discs and the brake linings may cause a delay in the braking effect, resulting in a significantly increased braking distance, which could lead to an accident.

To avoid this danger, you should:

- occasionally brake carefully when you are driving on salt-covered roads, so that any layer of salt that may have built up on the brake discs and the brake linings

is removed without putting other road users at risk

- maintain a greater distance to the vehicle ahead and drive with particular care
- carefully apply the brakes at the end of a trip and immediately after commencing a new trip, so that salt residues are removed from the brake disc

Brake service

 The brake fluid level in the reservoir may be too low or the electro-hydraulic brake system may be malfunctioning if the brake warning lamp in the instrument cluster comes on and an acoustic warning sounds although the parking brake is released. Observe additional messages in the multi-function display that may appear.

Brake pad wear or a leak in the system may be the reason for low brake fluid in the reservoir.

Have the brake system inspected immediately. Contact an authorized Mercedes-Benz Center.

Only install brake pads and brake fluid recommended by Mercedes-Benz.

Warning!

If other than recommended brake pads are installed, or other than recommended brake fluid is used, the braking properties of the vehicle can be degraded to an extent that safe braking is substantially impaired. This could result in an accident.

 Because the ESP[®] operates automatically, the engine and ignition must be shut off (SmartKey in starter switch position **0** or **1** or KEYLESS-GO start/stop button in position **0** or **1**) when the parking brake is being tested on a brake test dynamometer or when the vehicle is being towed with the front axle raised.

Active braking action through the ESP[®] may otherwise seriously damage the brake system which is not covered by the Mercedes-Benz Limited Warranty.

If your brake system is normally only subjected to moderate loads, you should occasionally test the effectiveness of the brakes by applying above-normal braking pressure at higher speeds. This will also enhance the grip of the brake pads.

Driving instructions

⚠ Warning!

Make sure not to endanger any other road users when carrying out these braking maneuvers.

Refer to the description of the Brake Assist System (BAS) (> page 64).

High-performance brake system

The high-performance brake system is only available on SL 63 AMG and SL 65 AMG.

⚠ Warning!

New vehicle brake pads and discs, and replacement brake pads and discs may take several hundred miles of driving until they provide optimum braking efficiency. Until that time, you may need to use increased brake pedal pressure while braking. Please be aware of this and adjust your driving and braking accordingly during this break-in period.

Excessive high-demand braking will cause correspondingly high brake wear. Please be attentive to the brake warning lamp in the instrument cluster and brake condition messages in the multifunction display. Especially for high performance driving, it

is important to maintain and have the brake system checked regularly.

The high-performance brake system is designed to operate under the extremely high operating demands required to accommodate the performance capabilities of the vehicle.

The brakes may produce a squeaking-type noise depending on the

- vehicle speed
- brake force applied
- ambient conditions, e.g. temperature and humidity

As with any brake system, the wear of individual brake system components such as brake pads or disks strongly depends on your driving style and the conditions under which you operate the vehicle. Thus, a driving style calling for high demand braking will cause your vehicle's brakes to wear more quickly.

Driving off

Warm up the engine smoothly. Do not place full load on the engine until the operating temperature has been reached.

! When driving off on a slippery surface, do not allow a drive wheel to spin for an extended period with the ESP[®] switched off. Doing so may cause serious damage to the drivetrain which is not covered by the Mercedes-Benz Limited Warranty.

! Simultaneously depressing the accelerator pedal and applying the brakes reduces engine performance and causes premature brake and drivetrain wear which is not covered by the Mercedes-Benz Limited Warranty.

Driving instructions

Hydroplaning

Depending on the depth of the water layer on the road, hydroplaning may occur, even at low speeds and with new tires.

- ▶ Reduce vehicle speed, avoid track grooves in the road and apply brakes cautiously in the rain.

Standing water

! Do not drive through flooded areas. Before driving through water, determine its depth.

If you must drive through standing water, drive slowly to prevent water from entering the passenger compartment or the engine compartment. Water in these areas could cause damage to electrical components or wiring of the engine or transmission, or could result in water being ingested by the engine through the air intake causing severe internal engine damage. Any such damage is not covered by the Mercedes-Benz Limited Warranty.

Driving abroad

If you plan to drive the vehicle outside the US or Canada, you should request dealer network information for your destination from any authorized Mercedes-Benz Center.

Control and operation of radio transmitter

Safety notes

⚠ Warning!

Please do not forget that your primary responsibility is to drive the vehicle safely. Only operate the COMAND (Cockpit Management and Data system), radio or telephone¹⁰ if road, weather and traffic conditions permit. Otherwise, you may not be able to observe traffic conditions and could endanger yourself and others.

Bear in mind that at a speed of just 30 mph (approximately 50 km/h), your vehicle is covering a distance of 44 feet (approximately 14 m) every second.

Telephones and two-way radios

⚠ Warning!

Never operate radio transmitters equipped with a built-in or attached antenna, such as a portable telephone or a citizens band unit, from inside the vehicle while the engine is running. Doing so could lead to a malfunction of the vehicle's electronic system, possibly resulting in an accident and/or serious personal injury. Radio transmitters should only be used inside the vehicle if they are connected to an antenna that is installed on the outside of the vehicle.

⚠ Warning!

Please do not forget that your primary responsibility is to drive the vehicle. A driver's attention to the road must always be his/her primary focus when driving. For your safety and the safety of others, we recommend that you pull over to a safe location and stop before placing or taking a telephone call.

If you choose to use the telephone¹¹ while driving, please use the hands-free device and only use the telephone when road,

¹⁰ Observe all legal requirements.

¹¹ Observe all legal requirements

weather and traffic conditions permit. Some jurisdictions prohibit the driver from using a mobile telephone while driving a vehicle.

Only operate the COMAND¹¹ (Cockpit Management and Data System) if road, weather and traffic conditions permit.

Bear in mind that at a speed of just 30 mph (approximately 50 km/h), your vehicle is covering a distance of 44 feet (approximately 14 m) every second.

Refer to the radio transmitter operation instructions regarding use of an external antenna.

Emission control

Certain systems of the engine serve to keep the toxic components of the exhaust gases within permissible limits required by law.

These systems will function properly only when maintained strictly according to factory specifications. Any adjustments on the engine should, therefore, be carried out only by qualified Mercedes-Benz Center authorized technicians.

Engine adjustments should not be altered in any way. Moreover, the specified service procedures must be carried out regularly according to Mercedes-Benz servicing requirements. For details refer to the Maintenance Booklet.

Warning!

Inhalation of exhaust gas is hazardous to your health. All exhaust gas contains carbon monoxide (CO), and inhaling it can cause unconsciousness and possible death.

Do not run the engine in confined areas (such as a garage) which are not properly ventilated. If you think that exhaust gas fumes are entering the vehicle while driving, have the cause determined and corrected immediately. If you must drive under these conditions, drive only with at least one window fully open at all times.

Maintenance

Notes

The Maintenance System in your vehicle tracks distance driven and the time elapsed since the last maintenance service, calculates other maintenance service work required, and calls for the next maintenance service accordingly.

We strongly recommend that you have your vehicle serviced at an authorized Mercedes-Benz Center, in accordance with the Maintenance Booklet at the times called for by the maintenance service indicator.

-  Failure to have the vehicle maintained in accordance with the Maintenance Booklet and maintenance service indicator at the designated times/mileage (kilometers) will result in vehicle damage not covered by the Mercedes-Benz Limited Warranty.

¹¹ Observe all legal requirements

Maintenance

Maintenance service indicator message

The maintenance service indicator message will notify you when the next maintenance service is due.

Starting approximately 1 month before the next maintenance service is due, one of the following messages will appear in the right multifunction display while you are driving or when you switch on the ignition (example service A):

Service A In XXXXX Miles (km)

Service A In XXX Days

Service A Due Now



The type of maintenance service due is indicated in the left multifunction display:

 Basic service (A)

 Extended service (B)

Clearing the maintenance service indicator message

The maintenance service indicator message is automatically cleared after approximately 30 seconds when you switch on the ignition or when reaching the service threshold while driving.



① Reset button

▶ **To clear the maintenance service indicator message:** Press reset button ① on the instrument cluster.

The standard display appears in the multifunction display.

Maintenance service term exceeded

If you have exceeded the suggested maintenance service term, you will see the following message in the right multifunction display:

Service A Exceeded By XXXX Miles (km)

Service A Exceeded By XXX Days





In addition, a signal sounds when the message appears.



Any authorized Mercedes-Benz Center will reset the maintenance service indicator following a completed maintenance service.

Calling up the maintenance service indicator display

i The menu overview can be found on (▷ page 128).

You can call up the maintenance service indicator display at any time to check when the next maintenance service is due.

- ▶ Switch on the ignition.
- ▶ Press button  or  on the multifunction steering wheel repeatedly until the standard display (▷ page 129) appears in the multifunction display.
- ▶ Press button  or  on the multifunction steering wheel until the mainte-

nance service indicator display with the service symbol  or  appears in the left multifunction display and the maintenance service deadline appears in the right multifunction display.

- i** If the battery is disconnected, the days of disconnection will not be included in the count shown by the maintenance service indicator. To arrive at the true maintenance service deadline, you will need to subtract these days from the days shown in the maintenance service indicator message or maintenance service indicator display. Do not confuse the maintenance service indicator with the engine oil level indicator .

Resetting the maintenance service indicator

In the event that the maintenance service on your vehicle is not carried out at an authorized Mercedes-Benz Center, you can have the maintenance service indicator reset.

The automotive maintenance facility carrying out the maintenance service will find the information for resetting the maintenance service indicator in the maintenance-relevant literature for your vehicle.

Such literature is available from any authorized Mercedes-Benz Center or directly from Mercedes-Benz.

- i** If the maintenance service indicator was inadvertently reset, have an authorized Mercedes-Benz Center correct it. Only reset if the proper maintenance service has been performed. Resetting the system without performing the proper maintenance service as called for by the maintenance service indicator will result in engine damage and/or other vehicle damage not covered by the Mercedes-Benz Limited Warranty.

Vehicle care

Cleaning and care of the vehicle

Notes

Regular and proper care will help to maintain the value of your vehicle.

Warning!

Many cleaning products can be hazardous. Some are poisonous, others are flammable. Always follow the instructions on the particular container. Always open your vehicle's doors or windows when cleaning the inside.

Never use fluids or solvents that are not designed for cleaning your vehicle.

Always lock away cleaning products and keep them out of reach of children.

- !** When cleaning the vehicle, do not use scouring agents. Never apply strong force and only use a soft, wet cloth or sponge. Otherwise you may scratch or damage the surface to be cleaned.

While in operation, even while parked, your vehicle is subjected to varying external influences which, if gone unchecked, can attack



Vehicle care

the paintwork as well as the vehicle underbody and cause lasting damage.

Such damage is caused not only by extreme and varying climatic conditions, but also by:

- Air pollution
- Road salt
- Tar
- Gravel and stone chipping

To avoid paint damage, you should immediately remove:

- Grease and oil
- Fuel
- Coolant
- Brake fluid
- Bird droppings
- Insects
- Tree resins etc.

Frequent washing reduces and/or eliminates the aggressiveness and potency of the above adverse influences.

More frequent washings are necessary to deal with unfavorable conditions:

- near the ocean
- in industrial areas (smoke, exhaust emissions)
- during winter operation

You should check your vehicle from time to time for stone chipping or other damage. Any damage should be repaired as soon as possible to prevent corrosion.

In doing so, do not neglect the underbody of the vehicle. A prerequisite for a thorough check is a washing of the underbody followed by a thorough inspection. Damaged areas need to be re-undercoated.

Your vehicle has been treated at the factory with a wax-base rustproofing in the body cavities which will last for the lifetime of the vehicle. Post-production treatment is neither necessary nor recommended by Mercedes-Benz because of the possibility of incompatibility between materials used in the production process and others applied later.

We have selected vehicle-care products and compiled recommendations which are specially matched to our vehicles and which always reflect the latest technology. You can obtain Mercedes-Benz approved vehicle-care

products at an authorized Mercedes-Benz Center.

Scratches, corrosive deposits, corrosion or damage due to negligent or incorrect care cannot always be removed or repaired with the vehicle-care products recommended here. In such cases it is best to seek aid at an authorized Mercedes-Benz Center.

The following topics deal with the cleaning and care of your vehicle and give important "how-to" information as well as references to Mercedes-Benz approved vehicle-care products.

Power washer

! Follow the instructions provided by the power washer manufacturer on maintaining a distance between the vehicle and the nozzle of the power washer.

Never use a round nozzle to power-wash tires. The intense jet of water can result in damage to the tire.

Always replace a damaged tire.

Always keep the jet of water moving across the surface. Do not aim directly at electrical parts, electrical connectors, seals, or other rubber parts.

i Vehicles with KEYLESS-GO:

If a door handle is hit by a strong jet of water, and a SmartKey is within approximately 3 ft (1 m) of the vehicle, it could be inadvertently locked or unlocked.

Tar stains

Quickly remove tar stains before they dry and become more difficult to remove. A tar remover is recommended.

Paintwork, painted body components

! Affixing stickers, magnets, adhesive tape or similar materials to painted body components may damage the paintwork.

Mercedes-Benz approved Paint Care should be applied when water drops on the paint surface do not “bead up”. This should normally be done every 3 to 5 months, depending on the climate and washing detergent used.

Mercedes-Benz approved Paint Cleaner should be applied if the paint surface shows signs of embedded dirt (i.e. loss of gloss).

Do not apply any of these products or wax if your vehicle is parked in the sun or if the hood is still hot.

- ▶ Use the appropriate MB-Touch-Up Stick for quick and provisional repairs of minor paint damage (i.e. chips from stones, vehicle doors, etc.).

Engine cleaning

Prior to cleaning the engine compartment, make sure to protect electrical components and connectors from contact with water and cleaning agents.

Corrosion protection, such as MB Anticorrosion Wax should be applied to the engine compartment after every engine cleaning. Before applying, all control linkage bushings and joints should be lubricated. The poly-V-belt and all pulleys should be protected from any wax.

Vehicle washing

In the winter, thoroughly remove all traces of road salt as soon as possible.

When washing the vehicle underbody, do not forget to clean the inner sides of the wheels.

i Vehicles with KEYLESS-GO:

If a door handle is hit by a strong jet of water, and a SmartKey is within approxi-

mately 3 ft (1 m) of the vehicle, it could be inadvertently locked or unlocked.

Hand-wash

Do not use hot water or wash your vehicle in direct sunlight.

- ▶ Only use a soft, wet cloth or sponge to clean the vehicle.
 - Do not spray directly towards the ventilation intake.
- ▶ Only use a mild vehicle wash detergent, such as Mercedes-Benz approved Car Shampoo.
- ▶ Thoroughly spray the vehicle with a diffused jet of water.
- ▶ Do not spray directly towards the ventilation intake.
- ▶ Use plenty of water and rinse the sponge and chamois frequently.
- ▶ Rinse with clean water and thoroughly dry with a chamois.
 - Do not allow cleaning agents to dry on the finish.

Vehicle care

Automatic car wash

You can have your vehicle washed in an automatic car wash from the start. Brushless car washes are preferable.

- ▶ To protect the filter system, activate the air recirculation mode using button  on the climate control panel.

! Do not clean your vehicle in an automatic touchless car wash which uses caustic spray. Otherwise the caustic spray will damage the paint or ornamental moldings.

If the vehicle is very dirty, prewash it before running it through the automatic car wash.

! Make sure the combination switch is set to wiper setting **0**. Otherwise, the rain sensor could activate and cause the wipers to move unintentionally. This may lead to vehicle damage.

Due to the width of the vehicle, fold in exterior rear view mirrors prior to running the vehicle through an automatic car wash to prevent damage to the mirrors.

When leaving the automatic car wash, make sure the mirrors are folded out.

After running the vehicle through an automatic car wash, wipe any wax off of the windshield and the wiper blade inserts. This will

prevent smears and reduce wiping noise which can be caused by residual wax on the windshield.

Ornamental moldings

- ▶ For regular cleaning and care of ornamental moldings, use a damp cloth.

! Do not use chrome cleaner on ornamental moldings. Although ornamental moldings may have chrome appearance, they could be made of anodized aluminum that will be damaged when cleaned with chrome cleaner. Instead, use a damp cloth to clean those ornamental moldings.

For very dirty ornamental moldings of which you are sure are chrome-plated, use a chrome cleaner. If in doubt whether an ornamental molding is chrome-plated, contact an authorized Mercedes-Benz Center.

Headlamps, brake lamps, tail lamps, side markers, turn signal lenses

- ▶ Use a mild vehicle wash detergent, such as Mercedes-Benz approved Car Shampoo, with plenty of water.

! Only use window cleaning solutions that are suitable for plastic lamp lenses. Window cleaning solutions which are not suitable may damage the plastic lamp lenses of the headlamps. Therefore, do not use abrasives, solvents or cleaners that contain solvents.

Cleaning the DISTRONIC system sensor cover



① DISTRONIC system sensor cover

- ▶ Switch off the ignition.
- ▶ Only clean sensor cover ① by hand.
- ▶ Use a mild vehicle wash detergent, such as Mercedes-Benz approved Car Shampoo, with plenty of water and a non-scratching cloth to clean sensor cover ①.

- ▶ Restart the engine after cleaning sensor cover ①.

Cleaning the Parktronic system sensors

Parktronic system sensors are located in the front and rear bumper.

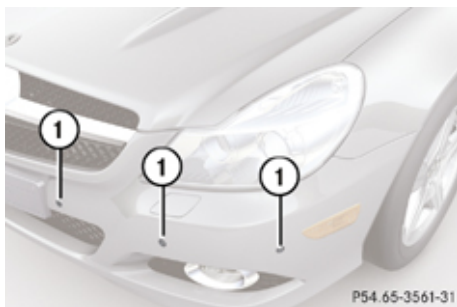

- ① Parktronic system sensors in front bumper

- ▶ Only clean sensor cover by hand.
- ▶ Use a mild vehicle wash detergent, such as Mercedes-Benz approved Car Shampoo, with plenty of water and a soft, non-scratching cloth to clean sensors ① on the bumpers.

- ❗ Applying strong pressure may damage the sensor covers.

Cleaning the windows and the wiper blades

- ❗ The windshield wipers must be in a vertical position before folding them away from the windshield. They could otherwise damage the hood.

Never open the hood when the wiper arms are folded forward.

- ▶ Make sure the hood is fully closed.
- ▶ Switch on the ignition.
- ▶ Turn combination switch to wiper setting II (▷ page 105).
- ▶ With wiper arms in vertical position, switch off the ignition.

⚠ Warning!

For safety reasons, switch off wipers and remove SmartKey from starter switch (vehicles with KEYLESS-GO: Make sure the vehicle's on-board electronics have status **0**) before cleaning the windshield and/or the wiper blades. Otherwise, the wiper motor could suddenly turn on and cause injury.

- ❗ Do not pull on the wiper blade inserts. They could tear.

- ▶ Fold the wiper arms forward until they snap into place.
- ▶ Clean the windshield and the wiper blade inserts with a clean cloth and mild detergent solution.
- ▶ Use a soft, clean cloth and a mild window cleaning solution on all outside and inside glass surfaces.
An automotive glass cleaner is recommended.

- ❗ Fold the windshield wiper arms back onto the windshield before turning the SmartKey in the starter switch or pressing the KEYLESS-GO start/stop button (vehicles with KEYLESS-GO).

Hold on to the wiper when folding the wiper arm back. If released, the force of the impact from the tensioning spring could crack the windshield.

- ❗ To clean the window interior, do not use a dry cloth, abrasives, solvents or cleaners containing solvents. Do not touch the inside of the front, rear or side windows with hard objects such as an ice scraper or ring. Doing so may damage the windows.

Vehicle care

Rear window cleaning

Clean the rear window with the hardtop fully raised and closed.

Warning!

Do not clean the rear window with the hardtop in a position other than the fully raised and closed position. Otherwise, the hardtop may move unexpectedly which may result in personal injury to you or others.

- ▶ Use a soft, clean cloth and a mild window cleaning solution on all outside and inside glass surfaces.

An automotive glass cleaner is recommended.

Light alloy wheels

If possible, clean wheels once a week.

- ▶ Use Mercedes-Benz approved Wheel Care, a soft bristle brush and a strong spray of water for cleaning the light alloy wheels.

 Only use acid-free cleaning materials. Acid may cause corrosion or damage the clear coat.

 The vehicle should not be parked for an extended period of time immediately after

it has been cleaned, especially not after the wheel rims have been cleaned with wheel rim cleaner. Wheel rim cleaners can lead to increased corrosion of the brake disks and brake pads. Non-approved wheel cleaners may also damage the wheel paint if the vehicle is not driven after cleaning.

Therefore, the vehicle's brake system should always be warmed-up before it is parked after cleaning. To do so, please drive your vehicle for several minutes to allow the brakes to dry. When applying Mercedes-Benz approved Tire Care and Mercedes-Benz approved Wheel Care products, take care not to spray them on the brake disks.

Plastic and rubber parts

- ▶ Use a gentle dishwashing detergent or mild detergent for delicate fabrics as a washing solution.
- ▶ Wipe with a cloth moistened in a lukewarm solution.

The surface may temporarily change color. If this is the case, wait for it to dry.

Warning!

Do not use cleaners or cockpit care sprays containing solvents to clean the cockpit or the steering wheel. Cleaners containing solvents will make the surface porous and vehicle occupants could suffer serious injuries from plastic parts coming loose in the event of air bag deployment.

 Do not use oil, wax or scouring agents.

Otherwise you may scratch or damage the surface.

Hard plastic trim items

- ▶ Use Mercedes-Benz approved Interior Care on a soft, lint-free cloth and apply with light pressure.

COMAND display

 You must switch off the COMAND display and allow it to cool prior to cleaning.

 Do not use any liquids or cleaning agents. These can damage or even destroy the audio display screen.

- ▶ Use a standard microfiber cloth and apply with light pressure.

Steering wheel and gear selector lever

- ▶ Wipe with a damp cloth and dry thoroughly or clean with Mercedes-Benz approved Leather Care.

Carpets

- ▶ Use Mercedes-Benz approved Carpet and Fabric Care for cleaning the carpets.

Headliner

- ▶ Use a soft bristle brush or a dry-shampoo cleaner in case of excessive dirt.

Seat belts

- ▶ Only use clear, lukewarm water and soap.

! The seat belts must not be treated with chemical cleaning agents. Do not dry the seat belts at temperatures above 176°F (80°C) or in direct sunlight.

Warning!

Do not bleach or dye seat belts as this may severely weaken them. In a crash they may not be able to provide adequate protection.

Upholstery

Using aftermarket seat covers or wearing clothing that have the tendency to give off coloring (e.g. when wet, etc.) may cause the upholstery to become permanently discolored. By lining the seats with a proper intermediate cover, contact-discoloration will be prevented.

Leather upholstery

Please note that leather upholstery is a natural product and is therefore subject to a natural aging process. Leather upholstery may also react to certain ambient influences such as high humidity or high temperature by showing wrinkles for example.

- ▶ Wipe leather upholstery with a damp cloth and dry thoroughly or clean with Mercedes-Benz approved Leather Care.
- !** To avoid damage to leather upholstery:
 - Wipe with light pressure only.
 - Do not clean with abrasive cleaning agents such as scouring milk or powder.
 - Do not soak the leather upholstery.

As leather is a natural product, it could otherwise harden or become porous.

- Exercise particular care when cleaning perforated leather as its underside should not become wet.

Wood trims

- ▶ Only use water and a damp cloth to clean wood trims in your vehicle.

! Do not use solvents like tar remover or wheel cleaner nor polishes or waxes as these may be abrasive.

Chrome-plated exhaust tip

Regular cleaning and care of chrome-plated exhaust tips will help to maintain their shine and the classy appearance.

- ▶ Use Mercedes-Benz approved Chrome Polishing Paste each time the vehicle has been washed, especially during the winter.
- !** Do not use alkaline cleaners such as wheel cleaners as they could cause corrosion.

Vehicle equipment	252
Where will I find ...?	252
Vehicle status messages in the multifunction display	255
What to do if	293
Unlocking/locking manually	307
Replacing SmartKey batteries	309
Replacing bulbs	311
Replacing wiper blades	316
Flat tire	317
Battery	326
Jump starting	328
Towing the vehicle	330
Fuses	334



Where will I find ...?

Vehicle equipment

i This Operator's Manual describes all features, standard or optional, potentially available for your vehicle at the time of purchase. Please be aware that your vehicle might not be equipped with all features described in this manual.

Where will I find ...?

First aid kit

i Check expiration dates and contents for completeness at least once a year and replace missing/expired items.

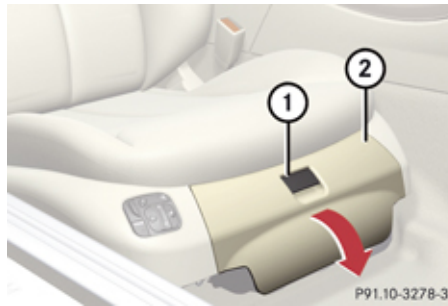

① Handle

② Lid

- ▶ Pull handle ① upward.
- ▶ Fold lid ② down.
- ▶ Remove the first aid kit.

Vehicle tool kit

The vehicle tool kit is located in the space underneath the trunk floor.

The vehicle tool kit includes:

- 2 open-end wrenches
- Alignment bolt
- Electric air pump
- Fuse chart
- Hex-socket wrench
- Interchangeable slot/Phillips screwdriver
- Jack
- Pair of universal pliers
- Protective wrap (if available)
- Towing eye bolt
- Valve extractor
- Wheel wrench

- ▶ **Removing:** Open the trunk (> page 82).
- ▶ Lift the trunk floor.

Where will I find ...?

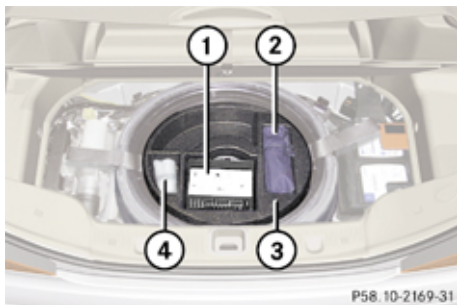

- ① Electric air pump
- ② Tool bag
- ③ Storage well casing
- ④ Protective wrap

i For transporting the damaged road wheel, use protective wrap ④ (if available).

- ▶ **To access jack and wheel wrench:**
Remove storage well casing ③.
- ▶ Remove the spare wheel (▷ page 253).

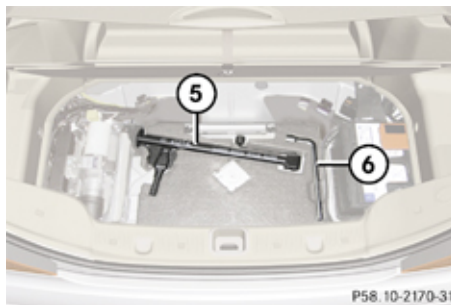

- ⑤ Jack
- ⑥ Wheel wrench

Jack

⚠ Warning!

Only use the jack supplied with your vehicle to lift the vehicle briefly for wheel changes. If you use the jack for any other purpose, you or others could be injured, as the jack is designed only for the purpose of changing a wheel.

When using the jack, observe the safety notes in the “Mounting the spare wheel” section and the notes on the jack.

Spare wheel

⚠ Observe Safety notes, see page 317.

The spare wheel is located in the space underneath the trunk floor.

- ▶ **Removing:** Open the trunk (▷ page 82).
- ▶ Lift the trunk floor.
- ▶ Remove the storage well casing (▷ page 253).

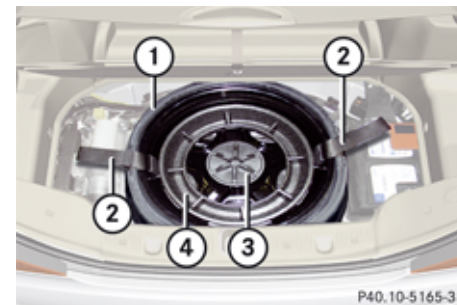

- ① Spare wheel
- ② Tensioning strap¹²
- ③ Retaining screw
- ④ Storage well casing base

¹² Vehicles with 19" spare wheel only.

Where will I find ...?

- ▶ Remove storage well casing base ④.
- ▶ Remove retaining screw ③ by turning it counterclockwise.
- ▶ Remove spare wheel ①.

For information on mounting the spare wheel, see “Flat tire” (▷ page 317).

Storing the spare wheel after use

If you wish to store the spare wheel after use, carry out the following steps. Otherwise, the spare wheel may not fit the spare wheel well.

- ❗ Make sure the spare wheel is dry before storing it.
- ▶ Unscrew the valve cap from the valve of the collapsible tire.
- ▶ Unscrew the valve insert from the valve using the valve extractor integrated in the valve cap.
- ▶ Allow the air to escape.
- ❗ It may take a few minutes for the collapsible tire to deflate completely.
- ▶ Screw the valve insert back into the valve.
- ▶ Screw the valve cap back on the valve.

- ❗ Vehicles with 19" spare wheel only:
Before placing the spare wheel in the spare wheel well fasten tensioning straps, see “Compressing the collapsible tire” (▷ page 254).
- ▶ Place the spare wheel in the spare wheel well.
- ▶ Secure the spare wheel by turning retaining screw ③ clockwise.

Compressing the collapsible tire

This description applies to vehicles with 19" spare wheel only.

The collapsible tire on a 19" spare wheel must be compressed with two tensioning straps before you can store it in the spare wheel well.

- ❗ The tensioning straps are shown in red for illustration purposes. The tensioning straps on the spare wheel of your vehicle are black.



- ▶ Extend the tensioning strap by pulling the slider.
- ▶ Place tensioning strap around the spare wheel rim and collapsible tire with the buckle facing the inside of the rim.
- ▶ Close the buckle.
- ▶ Pull the loose end of the tensioning strap. The tensioning strap must be pulled as tight as possible.

Vehicle status messages in the multifunction display

Vehicle status messages in the multifunction display

Notes





Warning and malfunction messages appear in the multifunction display located in the instrument cluster.





Certain warning and malfunction messages are accompanied by an audible signal.

Address these messages accordingly and follow the additional instructions given in this Operator's Manual.

Selecting the **Vehicle status message memory** menu in the control system (▷ page 134) displays both cleared and uncleared messages.

High-priority messages appear in the multifunction display in red color.

Certain messages of high priority cannot be cleared from the multifunction display using the reset button (▷ page 124) or button , ,  or  on the multifunction steering wheel.

Other messages of high priority and messages of less immediate priority can be cleared from the multifunction display using the reset button (▷ page 124) or button , ,  or  on the multifunction steering wheel. They are then stored in the **Vehicle status message memory** menu (▷ page 134). Remember that clearing a message will only make the message disappear. Clearing a message will not correct the condition that caused the message to appear.

Warning!

All categories of messages contain important information which should be taken note of and, where a malfunction is indicated, addressed as soon as possible at an authorized Mercedes-Benz Center.

Failure to repair condition noted may cause damage not covered by the Mercedes-Benz Limited Warranty, or result in property damage or personal injury.

Warning!

No messages will be displayed if either the instrument cluster or the multifunction display is inoperative.

As a result, you will not be able to see information about your driving conditions, such as speed or outside temperature, warning/indicator lamps, malfunction/warning messages or the failure of any systems. Driving characteristics may be impaired.

If you must continue to drive, please do so with added caution. Contact an authorized Mercedes-Benz Center as soon as possible.

On the pages that follow, you will find a compilation of the most important warning and malfunction messages that may appear in the multifunction display.

For your convenience the messages are divided into text messages (▷ page 256) and Symbol messages (▷ page 269).

Vehicle status messages in the multifunction display

Text messages



Safety systems

Display messages		Possible cause/consequence	Possible solution
ABS	ABS, ESP Inoperative See Oper. Manual.	The electro-hydraulic brake system is still functioning normally but due to a malfunction, the ABS, the BAS, the ESP® and the hill start assist system (SL 63 AMG only) are unavailable.	<ul style="list-style-type: none"> ▶ Continue driving with added caution. Wheels may lock during hard braking, reducing steering capability. ▶ Have the system checked at an authorized Mercedes-Benz Center as soon as possible. <p>Failure to follow these instructions increases the risk of an accident.</p>
ABS	ABS, ESP Unavailable See Oper. Manual	The self-diagnosis may not be completed yet.	The display will clear after driving a short distance at a vehicle speed of above 12 mph (20 km/h).
ABS	ABS, ESP Unavailable See Oper. Manual	The electro-hydraulic brake system is still functioning normally but due to a malfunction, the ABS, the BAS, the ESP® and the hill start assist system (SL 63 AMG only) are unavailable.	<ul style="list-style-type: none"> ▶ Continue driving with added caution. Wheels may lock during hard braking, reducing steering capability. ▶ Have the system checked at an authorized Mercedes-Benz Center as soon as possible. <p>Failure to follow these instructions increases the risk of an accident.</p>

Vehicle status messages in the multifunction display

Display messages		Possible cause/consequence	Possible solution
ESP	ESP Inoperative See Oper. Manual	The electro-hydraulic brake system is still functioning normally but due to a malfunction the ESP® and the hill start assist system (SL 63 AMG only) are unavailable. The ABS may not be operational.	<ul style="list-style-type: none"> ▶ Continue driving with added caution. ▶ Have the system checked at an authorized Mercedes-Benz Center as soon as possible. <p>Failure to follow these instructions increases the risk of an accident.</p>
ESP	ESP Unavailable See Oper. Manual	The electro-hydraulic brake system still functions normally but due to insufficient power supply the ESP® and the hill start assist system (SL 63 AMG only) are unavailable.	<ul style="list-style-type: none"> ▶ Synchronize the ESP®. With the vehicle stationary, turn the steering wheel completely to the left and then to the right. <p>! When synchronizing the ESP®, make sure you can turn the steering wheel in both directions as far as it will go without the wheels hitting any objects, e.g. a road curb.</p> <p>If the message in the multifunction display does not disappear:</p> <ul style="list-style-type: none"> ▶ Continue driving with added caution. ▶ Have the system checked at an authorized Mercedes-Benz Center as soon as possible. <p>Failure to follow these instructions increases the risk of an accident.</p>

Vehicle status messages in the multifunction display

Display messages		Possible cause/consequence	Possible solution
<p>Front Passeng. Airbag</p>	<p>Enabled See Oper. Manual</p>	<p>The passenger front air bag is activated while driving even though a child, small individual, or object below the system's weight threshold is on the passenger seat, or the passenger seat is empty. Objects on the seat or forces acting on the seat may make the system sense supplemental weight.</p>	<ul style="list-style-type: none"> ▶ Stop the vehicle in a safe location as soon as possible. ▶ Engage the parking brake. ▶ Switch off the ignition. ▶ Open the passenger door. ▶ Remove child and child restraint from passenger seat. ▶ Make sure no objects which apply forces to the seat are present. The system may recognize such forces as supplemental weight and sense that an occupant on the passenger seat is of a greater weight than actually present. ▶ Keep the seat unoccupied, close the passenger door and switch on the ignition. <p>Monitor the  PASS AIR BAG OFF indicator lamp (▷ page 52) and the multifunction display in the instrument cluster (▷ page 30) for the following: With the seat unoccupied and the ignition switched on,</p> <ul style="list-style-type: none"> • the  PASS AIR BAG OFF indicator lamp in the center console should illuminate and remain illuminated,

Vehicle status messages in the multifunction display



Display messages	Possible cause/consequence	Possible solution
		<p>indicating that the OCS (▷ page 50) has deactivated the passenger front air bag.</p> <ul style="list-style-type: none"> the message Front Passeng. Airbag Enabled See Oper. Manual or the message Front Passeng. Airbag Disabled See Oper. Manual should not appear in the multifunction display at any time the seat is unoccupied. Wait at least 60 seconds for the system to complete the necessary check cycles and to make sure neither message appears in the multifunction display. <p>If above conditions are met, you can occupy the passenger seat again. Depending on the passenger classification sensed by the OCS, the  PASS. AIR BAG OFF indicator lamp will remain illuminated or go out.</p> <p>If above conditions are not met, the system is not working properly. Have the system checked as soon as possible at an authorized Mercedes-Benz Center.</p>

 **Warning!**

If the  **PASS. AIR BAG OFF** indicator lamp remains out even after performing the above corrective steps, do not have any children 12 years old and under and other small individuals use the passenger seat until the system has been repaired.



Vehicle status messages in the multifunction display

Display messages	Possible cause/consequence	Possible solution
<p>Front Passeng. Airbag</p>	<p>Disabled See Oper. Manual</p>	<p>The passenger front air bag is deactivated while driving even though an adult or someone larger than a small individual is occupying the passenger seat. Forces acting on the seat may make the system sense a decrease in weight.</p> <ul style="list-style-type: none"> ▶ Stop the vehicle in a safe location as soon as possible. ▶ Engage the parking brake. ▶ Switch off the ignition. ▶ Have the passenger vacate the seat and exit the vehicle. ▶ Keep the seat unoccupied, close the passenger door and switch on the ignition. <p>Monitor the  indicator lamp (▷ page 52) and the multifunction display in the instrument cluster (▷ page 30) for the following: With the seat unoccupied and the ignition switched on,</p> <ul style="list-style-type: none"> • the  indicator lamp should illuminate and remain illuminated, indicating that the OCS (▷ page 50) has deactivated the front passenger front air bag.

Vehicle status messages in the multifunction display

Display messages	Possible cause/consequence	Possible solution
		<ul style="list-style-type: none"> the message Front Passeng. Airbag Enabled See Oper. Manual or the message Front Passeng. Airbag Disabled See Oper. Manual should not appear in the multifunction display at any time the seat is unoccupied. Wait at least 60 seconds for the system to complete the necessary check cycles and to make sure neither message appears in the multifunction display. <p>If above conditions are met, you can occupy the passenger seat again. Depending on the passenger classification sensed by the OCS, the  indicator lamp will remain illuminated or go out.</p> <p>If above conditions are not met, the system is not working properly. Have the system checked as soon as possible at an authorized Mercedes-Benz Center.</p>

 **Warning!**

If the  indicator lamp remains illuminated with an adult occupant on the passenger seat even after performing the above corrective steps, do not have any passenger use the passenger seat until the system has been repaired.

Vehicle status messages in the multifunction display

Driving systems

Display messages		Possible cause/consequence	Possible solution
ABC	Malfunction Stop Car	<p>You have started driving although the vehicle level is still too low.</p> <p>The vehicle is being raised. The ABC message goes out after a few seconds.</p>	<ul style="list-style-type: none"> ▶ Stop your vehicle in a safe location or as soon as it is safe to do so. ▶ Wait until the message disappears from the multifunction display. You may then drive off.
ABC	Malfunction Stop Car	<p>The vehicle is losing oil.</p> <p>The ABC message is continuously shown.</p>	<ul style="list-style-type: none"> ▶ Stop your vehicle in a safe location or as soon as it is safe to do so. ▶ Contact an authorized Mercedes-Benz Center.
ABC	Malfunction Stop Car	<p>The ABC is malfunctioning.</p>	<ul style="list-style-type: none"> ▶ Stop the vehicle in a safe location and press the vehicle level control button to select a higher vehicle level (> page 157). <p>If the vehicle does not raise, observe the following when you continue to drive:</p> <ul style="list-style-type: none"> ▶ Do not turn steering wheel too far to avoid damaging the front fenders. ▶ Listen for scraping noises. ▶ Do not drive faster than 50 mph (80 km/h). ▶ Contact an authorized Mercedes-Benz Center as soon as possible.

Vehicle status messages in the multifunction display

Display messages	Possible cause/consequence	Possible solution	
ABC	Malfunction	The capability of the ABC system is restricted. This can impair handling.	<ul style="list-style-type: none"> ▶ Do not drive faster than 50 mph (80 km/h). ▶ Contact an authorized Mercedes-Benz Center as soon as possible.
ABC	Vehicle Rising Please Wait	The vehicle's level is too low while at a standstill. The vehicle will be raised.	<ul style="list-style-type: none"> ▶ Do not drive off. ▶ Wait until the message disappears from the multifunction display. You may then drive off.
Cruise Control And SPEEDTRONIC	Inoperative	The cruise control is malfunctioning.	<ul style="list-style-type: none"> ▶ Have cruise control checked at an authorized Mercedes-Benz Center.
- - - MPH (USA only) - - - Km/h (Canada only)	Cruise Control	One of the activation conditions for cruise control has not been fulfilled. For example, you attempted to set a speed below 20 mph (30 km/h).	<ul style="list-style-type: none"> ▶ Drive faster than 20 mph (30 km/h), if the situation allows, and set the speed. ▶ Check the activation conditions for cruise control (▷ page 145).
DTR - - - MPH (USA only) DTR - - - Km/h (Canada only)		One of the activation conditions for Distronic has not been fulfilled. For example, you attempted to set a speed below 20 mph (30 km/h).	<ul style="list-style-type: none"> ▶ Drive faster than 20 mph (30 km/h) and set the speed. ▶ Check the activation conditions for Distronic (▷ page 150).
DISTRONIC	Inoperative	The Distronic or the display are malfunctioning.	<ul style="list-style-type: none"> ▶ Contact an authorized Mercedes-Benz Center as soon as possible.



Vehicle status messages in the multifunction display

Display messages	Possible cause/consequence	Possible solution
DTR	Override	You have accelerated. The Distronic has switched off.
DISTRONIC	Currently Unavailable. See Oper. Manual	<p>Distronic is deactivated because:</p> <ul style="list-style-type: none"> • The Distronic cover in the radiator grille is dirty. • The functionality is impaired by heavy precipitation or fog • The system is overheated. <p>▶ Stop accelerating.</p> <p>▶ If necessary, clean the Distronic cover in the area of the radiator grille (▷ page 246).</p> <p>▶ If necessary, wait until the system has cooled down.</p> <p>▶ Restart the vehicle.</p> <p>Distronic becomes operational again without the engine being restarted when:</p> <ul style="list-style-type: none"> • dirt on the radiator grille has fallen off while driving (e.g. slush or snow) • the system recognizes full sensor availability (due to lessening rain or the road surface drying) • the message in the multifunction display disappears <p>You can then operate Distronic as usual again.</p>

Vehicle status messages in the multifunction display

Display messages	Possible cause/consequence	Possible solution
DISTRONIC Currently Unavailable. See Oper. Manual	Distronic is deactivated because the functionality is impaired by external interferences, e.g. high-frequency sources such as toll stations, speed measuring systems etc.	<ul style="list-style-type: none"> ▶ Leave the area of the external interference. ▶ Activate DISTRONIC again (▷ page 150) when the message in the multifunction display disappears.
	Distronic is deactivated because the DISTRONIC sensor has not sensed any other vehicles or objects, e.g. road sign or such, for a long time.	<ul style="list-style-type: none"> ▶ Activate DISTRONIC again (▷ page 150) when the message in the multifunction display disappears.

Vehicle

Display messages	Possible cause/consequence	Possible solution
P Gear Selector Lever To P	You have attempted to start the engine with the KEYLESS-GO start/stop button while the automatic transmission was not in park position P .	<ul style="list-style-type: none"> ▶ Shift the automatic transmission into park position P.
	You have attempted to turn off the engine with the KEYLESS-GO start/stop button while the automatic transmission was not in park position P .	<ul style="list-style-type: none"> ▶ Shift the automatic transmission into park position P.

Vehicle status messages in the multifunction display

Tires

Display messages		Possible cause/consequence	Possible solution
Tire pressure	displayed after driving for a few minutes.	Vehicles with Advanced TPMS (Canada only): The tire inflation pressure is being checked.	▶ Drive the vehicle for a few minutes.
Tire Pressure Monitor	Inoperative	The TPMS (USA only) or Advanced TPMS (Canada only) is malfunctioning.	▶ Have the TPMS or Advanced TPMS checked at an authorized Mercedes-Benz Center.
Tire Pressure Monitor	Inoperative No Wheel Sensors	There are wheels without appropriate wheel sensors mounted (e.g. winter tires).	<ul style="list-style-type: none"> ▶ Have the TPMS (USA only) or Advanced TPMS (Canada only) checked at an authorized Mercedes-Benz Center. ▶ Have the appropriate wheel sensors installed at an authorized Mercedes-Benz Center.

Vehicle status messages in the multifunction display

Display messages		Possible cause/consequence	Possible solution
Tire Pressure Monitor Wheel Sensor Missing		Vehicles with Advanced TPMS (Canada only): One or more sensors are defect (e.g. battery is empty). The respective tire is indicated by - - instead of the tire inflation pressure in the multifunction display.	<ul style="list-style-type: none"> ▶ Have the Advanced TPMS checked at an authorized Mercedes-Benz Center. ▶ Have the wheel sensors installed at an authorized Mercedes-Benz Center.
		One or more wheels without appropriate wheel sensors mounted (e.g. spare tire). The respective tire is indicated by - - instead of the tire inflation pressure in the multifunction display.	<ul style="list-style-type: none"> ▶ Have the Advanced TPMS checked at an authorized Mercedes-Benz Center. ▶ Have the wheel sensors installed at an authorized Mercedes-Benz Center.
Tire Pressure Monitor	Currently Unavailable	The TPMS (USA only) or Advanced TPMS (Canada only) is unable to monitor the tire pressure due to a nearby radio interference source or insufficient power supply.	As soon as the causes of the malfunction have been removed, the TPMS or Advanced TPMS automatically becomes active again after a few minutes driving.



Vehicle status messages in the multifunction display

Display messages	Possible cause/consequence	Possible solution
Please correct the tire pressure.	Vehicles with Advanced TPMS (Canada only): The tire pressure is too low in one or more tires. or The tire pressures of the individual tires differ from each other significantly. The tire pressure values are shown in the multifunction display.	▶ Check and correct tire inflation pressure as required (▷ page 217).
Caution Tire defect	Vehicles with Advanced TPMS (Canada only): One or more tires are deflating. The respective tire is indicated in the multifunction display.	▶ Carefully bring the vehicle to a halt, avoiding abrupt steering and braking maneuvers. ▶ If necessary, change the wheel (▷ page 318).
Check Tires	Vehicles with Advanced TPMS (Canada only): The tire pressure in one or more tires is already below the minimum value. The respective tire is indicated in the multifunction display.	▶ Carefully bring the vehicle to a halt, avoiding abrupt steering and braking maneuvers. ▶ Check and adjust tire pressure as required. ▶ If necessary, change the wheel (▷ page 318).

Warning!

Do not drive with a flat tire. A flat tire affects the ability to steer or brake the vehicle. You may lose control of the vehicle. Continued driving with a flat tire will cause excessive heat build-up and possibly a fire.

Vehicle status messages in the multifunction display **Warning!**

Follow recommended tire inflation pressures.



Do not underinflate tires. Underinflated tires wear excessively and/or unevenly, adversely affect handling and fuel economy, and are more likely to fail from being overheated.

Do not overinflate tires. Overinflated tires can adversely affect handling and ride comfort, wear unevenly, increase stopping distance, and result in sudden deflation (blowout) because they are more likely to become punctured or damaged by road debris, potholes etc.

Vehicle status messages in the multifunction display

Symbol messages

Brake

Display messages	Possible cause/consequence	Possible solution
 <p>Reduced Brake Effect Depress brake pedal fully.</p>	<p>The electro-hydraulic brake system is in emergency operation mode. Considerably greater brake pedal force is required and the brake pedal travel is longer. The stopping distance is increased.</p> <p>The maximum speed is limited to 55 mph (90 km/h).</p>	<ul style="list-style-type: none"> ▶ Stop the vehicle in a safe location or as soon as it is safe to do so. ▶ Engage the parking brake. ▶ Do not drive any further. ▶ Prevent the vehicle from rolling away by blocking the wheels with wheel chocks or other sizeable objects. ▶ Contact an authorized Mercedes-Benz Center or call Roadside Assistance.
 <p>Reduced Brake Effect Service Required</p>	<p>The electro-hydraulic brake system is in emergency operation mode. Considerably greater brake pedal force is required and the brake pedal travel is longer. The stopping distance is increased.</p>	<ul style="list-style-type: none"> ▶ Stop the vehicle in a safe location or as soon as it is safe to do so. ▶ Engage the parking brake. ▶ Do not drive any further. ▶ Prevent the vehicle from rolling away by blocking the wheels with wheel chocks or other sizeable objects. ▶ Contact an authorized Mercedes-Benz Center or call Roadside Assistance.

Vehicle status messages in the multifunction display

⚠ Warning!

Driving while one of the previous messages is displayed can result in an accident. Have your brake system checked immediately.

If the electro-hydraulic brake system enters its emergency operation mode, the driver must apply significantly greater brake pedal pressure and depress the pedal much further than normal to obtain braking effect.

If necessary, apply full pressure to the brake pedal. Brakes are only applied to the front wheels. Stopping distance is increased!

If there is a malfunction in the electro-hydraulic brake system, we recommend that the vehicle be transported with all wheels off the ground using flatbed or appropriate wheel lift/dolly equipment.

A tow bar must be used if circumstances do not permit the use of the recommended towing methods and the vehicle requires towing with all four wheels on the ground.

Towing the vehicle with all four wheels on the ground is only permissible for distances up to 30 miles (50 km) and at a speed not to exceed 30 mph (50 km/h). For more information, see "Towing the vehicle".

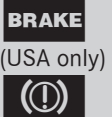
Display messages	Possible cause/consequence	Possible solution
 (USA only) (Canada only)	Reduced Brake Effect Start Engine	The battery has insufficient voltage and cannot supply sufficient power to the electro-hydraulic brake system.
		▶ Start the engine. The message disappears when sufficient voltage is available.

⚠ Warning!

Inhalation of exhaust gas is hazardous to your health. All exhaust gas contains car-

bon monoxide (CO), and inhaling it can cause unconsciousness and lead to death.

Do not run the engine in confined areas (such as a garage) which are not properly ventilated.

Display messages	Possible cause/consequence	Possible solution
	Brake Wear	The brake pads have reached their wear limit.
		▶ Have the brake pads replaced as soon as possible.

Vehicle status messages in the multifunction display

! Brake pad thickness must be visually inspected by a qualified technician at the intervals specified in the Maintenance Booklet.

Warning!



Have brake pad replacement and other work on the electro-hydraulic brake system carried out by qualified technicians only. Contact an authorized Mercedes-Benz Center for further information.

The electro-hydraulic brake system must be deactivated prior to working on the sys-

tem. High pressure is intermittently built up in the system as part of its automatic self-test.

In addition, the system is automatically activated when the vehicle is unlocked by remote control, when the driver or passenger door is opened, when the SmartKey in the starter switch is turned to position 1 or

the KEYLESS-GO start/stop button is pressed once, when the brake pedal is depressed or when the parking brake is released. Failure to deactivate the system prior to maintenance will cause brake pistons to extend and brake fluid to leak, which may result in injuries (contusions and acid burns). Extended brake pistons may also cause injury.



Display messages	Possible cause/consequence	Possible solution
 (USA only)  (Canada only)	Check Brake Fluid Level There is insufficient brake fluid in the reservoir.	Risk of accident! ► Stop the vehicle in a safe location or as soon as it is safe to do so. ► Do not drive any further. ► Contact an authorized Mercedes-Benz Center or call Roadside Assistance. Do not add brake fluid! This will not solve the problem.

Warning!

Driving with the message **Check Brake Fluid Level** displayed can result in an accident. Have your brake system checked immediately. Do not add brake fluid before checking the brake system. Overfilling the brake fluid reservoir can result in spilling brake fluid on hot engine parts and the brake fluid catching fire. You can be seriously burned.





Vehicle status messages in the multifunction display

! If you find that the brake fluid in the brake fluid reservoir has fallen to the minimum mark or below, have the brake system checked for brake pad thickness and leaks.

Display messages	Possible cause/consequence	Possible solution	
BRAKE (USA only)  (Canada only)	Brake Service Required	There are malfunctions, but the electro-hydraulic brake system is operating normally.	<ul style="list-style-type: none"> ▶ Contact an authorized Mercedes-Benz Center as soon as possible.
BRAKE (USA only)  (Canada only)	Brakes Overheated Drive on, but with even greater care.	The brake system is overheated due to an excessive load on the brakes.	Relieve the load on the brake system: <ul style="list-style-type: none"> ▶ Drive more smoothly and think ahead to avoid unnecessary braking. ▶ When driving down steep grades, shift into a lower gear to use the engine's braking power (▷ page 120). ▶ Cautiously continue driving so that the air stream will cool down the brakes.
BRAKE (USA only)  (Canada only)	Release Parking Brake	You are driving with the parking brake engaged.	<ul style="list-style-type: none"> ▶ Release the parking brake.

Vehicle status messages in the multifunction display

Safety systems

Display messages		Possible cause/consequence	Possible solution
	Raise Roll-over Bar	The roll bar is malfunctioning.	<p>For safety reasons, always have the roll bar raised when driving with the retractable hardtop open.</p> <ul style="list-style-type: none"> ▶ Attempt to raise the roll bar using the roll bar button (▷ page 59). ▶ Have the roll bar checked at an authorized Mercedes-Benz Center.
	Raise Roll-over Bar	The roll bar was raised automatically and you have attempted to open or close the retractable hardtop.	<ul style="list-style-type: none"> ▶ Raise the roll bar manually until you hear the roll bar lock into place (▷ page 59). ▶ Open or close the retractable hardtop.
	Tele Aid Inoperative	One or more main functions of the Tele Aid system are malfunctioning.	<ul style="list-style-type: none"> ▶ Have the Tele Aid system checked at an authorized Mercedes-Benz Center.
	Restraint System Malfunction Service Required	There is a malfunction in the supplemental restraint systems. The air bags or the emergency tensioning devices (ETDs) could deploy unexpectedly or fail to activate in an accident.	<ul style="list-style-type: none"> ▶ Drive with added caution to the nearest authorized Mercedes-Benz Center and have the system checked immediately.





Warning!

In the event a malfunction of the SRS is indicated as outlined above, the SRS may not be operational.



Vehicle status messages in the multifunction display

For your safety, we strongly recommend that you contact an authorized Mercedes-Benz Center immediately to have the system checked; otherwise the SRS may not be activated when needed in an accident, which could result in serious or fatal injury, or it might deploy unexpectedly and unnecessarily which could also result in injury.







Vehicle

Display messages	Possible cause/consequence	Possible solution
	The trunk is open.	▶ Close the trunk.
	You are driving with the hood open.	▶ Close the hood (▷ page 204).
	You are driving with the hood and the tailgate open.	▶ Close the hood and the tailgate.
	You are driving with at least one door open.	▶ Close the door(s).
 Check Doors	Vehicles with KEYLESS-GO: You are pressing the lock button on the door handle and at least one door is open.	▶ Close the door(s).





Vehicle status messages in the multifunction display

Display messages	Possible cause/consequence	Possible solution
 <p>Retract. Roof Oper. Please Wait See Oper. Manual</p>	The on-board voltage is too low.	<ul style="list-style-type: none"> ▶ Repeat the opening or closing procedure. ▶ Start the engine.
	The hardtop drive system was shut down for safety reasons after multiple, consecutive attempts to raise or lower the hardtop.	<p>After about 10 minutes you can open or close the retractable hardtop.</p> <ul style="list-style-type: none"> ▶ Switch on the ignition. ▶ Repeat the opening or closing procedure. ▶ If the retractable hardtop still does not open or close properly, have the hardtop system checked at an authorized Mercedes-Benz Center.
 <p>Retractable Roof Lowering</p>	The retractable hardtop is not completely opened or closed. The roof hydraulics will start to lose pressure.	<ul style="list-style-type: none"> ▶ Make sure the retractable hardtop is completely opened or closed (> page 173).
 <p>Retractable Roof Operation Only At Standstill</p>	You have attempted to open the retractable hardtop while driving.	<ul style="list-style-type: none"> ▶ Stop the vehicle in a safe location and try to open the hardtop again.

Vehicle status messages in the multifunction display

Display messages	Possible cause/consequence	Possible solution
 <p>Retractable Roof Not Opened/Closed Completely</p>	You are driving with the retractable hardtop not properly locked.	<ul style="list-style-type: none"> ▶ Stop the vehicle in a safe location. Observe the traffic situation around you. ▶ Pull or push on the retractable hardtop switch until the retractable hardtop is completely open or closed (▷ page 173). ▶ If the retractable hardtop still does not lock properly, have the hardtop system checked at an authorized Mercedes-Benz Center.
 <p>Trunk Partition Open</p>	You are trying to open or close the retractable hardtop even though the luggage cover in the trunk is not closed and/or properly engaged.	▶ Close the luggage cover and engage it into the side holders (▷ page 178).
 <p>Key Detected In Vehicle</p>	A SmartKey with KEYLESS-GO left in the vehicle was recognized while locking the vehicle from the outside.	▶ Take the SmartKey out of the vehicle.
 <p>Remove Key</p>	You have forgotten to remove the SmartKey.	▶ Remove the SmartKey from the starter switch.
 <p>Replace Key</p>	The SmartKey is malfunctioning.	▶ Contact an authorized Mercedes-Benz Center.
 <p>Change Key Batteries</p>	The batteries in the SmartKey with KEYLESS-GO are discharged.	▶ Replace the batteries (▷ page 309).





Vehicle status messages in the multifunction display

Display messages	Possible cause/consequence	Possible solution
 <p>Key Not Detected</p>	<p>The SmartKey with KEYLESS-GO is not detected while the engine is running because the SmartKey is not in the vehicle.</p>	<ul style="list-style-type: none"> ▶ Stop the vehicle as soon as it is safe to do so. ▶ Engage the parking brake. ▶ Search for the SmartKey. <p>The vehicle cannot be centrally locked nor can the engine be started again after the engine is stopped.</p>
 <p>Key Not Detected</p>	<p>The SmartKey with KEYLESS-GO is not detected while the engine is running because there is strong radio-frequency interference.</p>	<ul style="list-style-type: none"> ▶ Stop the vehicle as soon as it is safe to do so. ▶ Engage the parking brake. ▶ Operate the vehicle with the SmartKey with KEYLESS-GO in the starter switch.
 <p>Key Not Detected</p>	<p>The SmartKey with KEYLESS-GO is momentarily not detected.</p>	<ul style="list-style-type: none"> ▶ Change the position of the SmartKey in the vehicle. ▶ Operate the vehicle with the SmartKey in the starter switch if necessary.
 <p>Bluetooth Ready</p>	<p>The telephone has not yet been connected to the COMAND system via Bluetooth®.</p>	<ul style="list-style-type: none"> ▶ Connect the telephone to the COMAND system via Bluetooth®.
 <p>Top Up Washer Fluid</p>	<p>The washer fluid in the washer fluid reservoir has fallen below the minimum level.</p>	<ul style="list-style-type: none"> ▶ Add washer fluid (▷ page 208).

Vehicle status messages in the multifunction display

Display messages	Possible cause/consequence	Possible solution
 <p>Entry Position Do Not Drive</p>	The steering wheel has not yet moved into its stored driving position.	<ul style="list-style-type: none"> ▶ Wait until the steering wheel has moved to its driving position. The message disappears.

Engine

Display messages	Possible cause/consequence	Possible solution
 <p>check engine (USA only)</p>  <p>(Canada only)</p>	<p>Engine Service</p> <p>There may be a malfunction in:</p> <ul style="list-style-type: none"> • The fuel management system • The ignition system • The exhaust system • The fuel system 	<ul style="list-style-type: none"> ▶ Have the engine checked as soon as possible at an authorized Mercedes-Benz Center.
	<p>Service Required</p> <p>Certain electronic systems are unable to relay information to the control system. The coolant temperature display or the tachometer may have failed.</p>	<ul style="list-style-type: none"> ▶ Have the electronic systems checked at an authorized Mercedes-Benz Center.
	<p>Top Up Coolant See Oper. Manual</p> <p>The coolant level is too low.</p>	<ul style="list-style-type: none"> ▶ Add coolant (▷ page 207). ▶ If you have to add coolant frequently, have the cooling system checked at an authorized Mercedes-Benz Center.

Vehicle status messages in the multifunction display

Warning!

Do not spill antifreeze on hot engine parts. Antifreeze contains ethylene glycol which may burn if it comes into contact with hot engine parts. You could be seriously burned.

! Do not ignore the low engine coolant level warning. Extended driving with the message and symbol displayed may cause serious engine damage not covered by the Mercedes-Benz Limited Warranty.

Do not drive without sufficient amount of coolant in the cooling system. The engine will overheat causing major engine damage.

Display messages	Possible cause/consequence	Possible solution
 <p>Coolant Stop car, switch engine off.</p>	The coolant is too hot.	<ul style="list-style-type: none"> ▶ Stop the vehicle in a safe location or as soon as possible. ▶ Turn off the engine immediately. ▶ Only start the engine again after the message disappears. You could otherwise damage the engine. ▶ Engage the parking brake. ▶ Observe the coolant temperature gauge in the instrument cluster. ▶ If the temperature rises again: Contact an authorized Mercedes-Benz Center immediately. <p>During severe operation conditions and stop-and-go city traffic, the coolant temperature may rise close to 248°F (120°C).</p>

Vehicle status messages in the multifunction display

 **Warning!**

Driving when your engine is overheated can cause some fluids which may have leaked into the engine compartment to catch fire. You could be seriously burned.

Steam from an overheated engine can cause serious burns which can occur just by opening the engine hood. Stay away from the engine if you see or hear steam coming from it.



Stop the vehicle in a safe location away from other traffic. Turn off the engine, get out of the vehicle and do not stand near the vehicle until the engine has cooled down.

 The engine should not be operated with the coolant temperature above 248°F (120°C). Doing so may cause serious damage which is not covered by the Mercedes-Benz Limited Warranty.



Vehicle status messages in the multifunction display

Display messages	Possible cause/consequence	Possible solution
 <p data-bbox="300 202 507 286">Coolant Stop car, switch engine off.</p>	<p data-bbox="555 202 890 225">The poly-V-belt could be broken.</p>	<ul style="list-style-type: none"> <li data-bbox="999 202 1495 255">▶ Stop the vehicle in a safe location or as soon as possible. <li data-bbox="999 269 1353 292">▶ Turn off the engine immediately. <li data-bbox="999 306 1251 329">▶ Check the poly-V-belt. <li data-bbox="999 348 1495 490">▶ If it is broken: Do not continue to drive. Otherwise the engine will overheat due to an inoperative water pump which may result in damage to the engine. Contact an authorized Mercedes-Benz Center. <li data-bbox="999 505 1495 647">▶ If it is intact: Do not continue to drive the vehicle with this message displayed. Doing so could result in serious engine damage that is not covered by the Mercedes-Benz Limited Warranty. <li data-bbox="999 661 1495 714">▶ Observe the coolant temperature gauge in the instrument cluster. <li data-bbox="999 729 1495 781">▶ Drive to the nearest authorized Mercedes-Benz Center immediately.

Vehicle status messages in the multifunction display

Display messages	Possible cause/consequence	Possible solution
	<p>The cooling fan for the coolant is malfunctioning.</p>	<ul style="list-style-type: none"> ▶ Observe the coolant temperature gauge in the instrument cluster. If the coolant temperature is under 248°F (120°C), you may continue driving to an authorized Mercedes-Benz Center. ▶ Avoid placing heavy loads on the engine (e.g. by driving uphill) as well as stop-and-go traffic. ▶ Have the fan replaced as soon as possible.
	<p>The battery is no longer charging. Possible causes:</p> <ul style="list-style-type: none"> • alternator malfunctioning • broken poly-V-belt • a malfunction in the electronic system <p>Do not forget that the brake system requires electrical energy and may be operating with restricted capability. Considerably greater brake pedal force is required and the stopping distance is increased.</p>	<ul style="list-style-type: none"> ▶ Stop immediately in a safe location or as soon as it is safe to do so and check the poly-V-belt. ▶ If it is broken: Do not continue to drive. Otherwise the engine will overheat due to an inoperative water pump which may result in damage to the engine. Contact an authorized Mercedes-Benz Center. ▶ If it is intact: Drive to the nearest authorized Mercedes-Benz Center immediately. Adjust driving to be consistent with reduced braking responsiveness.

Vehicle status messages in the multifunction display

Display messages	Possible cause/consequence	Possible solution
 <p>Battery/Alternator Stop Car</p>	<p>The battery is defective. The electro-hydraulic brake system requires electrical energy and therefore has only limited operation. Considerably greater brake pedal force is required and the stopping distance is increased.</p>	<ul style="list-style-type: none"> ▶ Stop the vehicle in a safe location or as soon as it is safe to do so. ▶ Adjust driving to be consistent with reduced braking responsiveness. ▶ Contact an authorized Mercedes-Benz Center.
 <p>Engine Oil Level Check Level</p>	<p>Vehicles with oil dipstick only: The engine oil has dropped to a critical level.</p>	<ul style="list-style-type: none"> ▶ Check the engine oil level (▷ page 204) and add engine oil as required (▷ page 206). ▶ If you must add engine oil frequently, have the engine checked for possible leaks.
 <p>Add 1 qt engine oil at next refueling. (USA only) Add 1 liter engine oil at next refueling. (Canada only)</p>	<p>Vehicles with engine oil measuring system only: The engine oil level is too low.</p>	<ul style="list-style-type: none"> ▶ Add engine oil (▷ page 206) and check the engine oil level (▷ page 204).

If the message Add 1 qt (Canada: 1 liter) engine oil at next refueling or Engine Oil Level Check Level appears while the engine is running and at operating temperature, the engine oil level has dropped to approximately the minimum level.

The message will be stored in the vehicle status message memory after you have cleared it from the multifunction display.





Visually check for oil leaks. If there are no obvious oil leaks, drive to the nearest service station to refill your engine oil to the required level.

For information on approved engine oils contact an authorized Mercedes-Benz Center or visit www.mbusa.com (USA only).

! Engine oil level warnings should not be ignored. Extended driving with the symbol displayed could result in serious engine

Vehicle status messages in the multifunction display

damage that is not covered by the Mercedes-Benz Limited Warranty.





Display messages	Possible cause/consequence	Possible solution
 <p>Engine Oil Level Cannot measure eng. oil level.</p>	<p>Vehicles with engine oil measuring system only: The measuring system is malfunctioning.</p>	<p>▶ Have the measuring system checked at an authorized Mercedes-Benz Center.</p>
 <p>Engine Oil Level Reduce Oil Level</p>	<p>Vehicles with engine oil measuring system only: You have added too much engine oil. There is a risk of damaging the engine or the catalytic converter.</p>	<p>▶ Have oil siphoned or drained off. Observe all legal requirements with respect to its disposal.</p>
 <p>Engine Oil Level Stop car, switch engine off.</p>	<p>There is no oil in the engine. There is a danger of engine damage.</p>	<ul style="list-style-type: none"> ▶ Stop the vehicle in a safe location or as soon as it is safe to do so. ▶ Turn off the engine. ▶ Engage the parking brake. ▶ Add engine oil (▷ page 206) and check the engine oil level (▷ page 204).
	<p>The fuel level has dropped below the reserve mark.</p>	<p>▶ Refuel at the next gas station.</p>
 <p>Reserve Fuel</p>	<p>The fuel level has dropped below the reserve mark.</p>	<p>▶ Refuel at the next gas station.</p>







Vehicle status messages in the multifunction display

Display messages	Possible cause/consequence	Possible solution
 Fuel Cap Open	A loss of pressure has been detected in the fuel system. The fuel cap may not be closed properly or the fuel system may be leaky.	<ul style="list-style-type: none"> ▶ Check the fuel cap (▷ page 201). ▶ If it is not closed properly: Close the fuel cap. ▶ If it is closed properly: Have the fuel system checked at an authorized Mercedes-Benz Center.





Lamps

Display messages	Possible cause/consequence	Possible solution
 Active Headlamps Inoperative	The active Bi-Xenon headlamp system is malfunctioning.	▶ Contact an authorized Mercedes-Benz Center as soon as possible.
 Reverse Lamp Left or Reverse Lamp Right	The left or right backup lamp is malfunctioning.	▶ Replace the bulb as soon as possible (▷ page 311).
 Brake Lamp Left Auxiliary Bulb On or Brake Lamp Right Auxiliary Bulb On	The left or right brake lamp is malfunctioning. A substitute bulb is being used.	▶ Contact an authorized Mercedes-Benz Center as soon as possible.
 3rd Brake Lamp	The high-mounted brake lamp is malfunctioning. This message will only appear if all LEDs have stopped working.	▶ Contact an authorized Mercedes-Benz Center as soon as possible.





Vehicle status messages in the multifunction display

Display messages		Possible cause/consequence	Possible solution
	Front Foglamp Left or Front Foglamp Right	The left or right front fog lamp is malfunctioning.	► Contact an authorized Mercedes-Benz Center as soon as possible.
	Marker Lamp Front Left or Marker Lamp Front Right	The front left side or right side marker lamp is malfunctioning.	► Contact an authorized Mercedes-Benz Center as soon as possible.
	Marker Lamp Rear Left or Marker Lamp Rear Right	The rear left side or right side marker lamp is malfunctioning.	► Contact an authorized Mercedes-Benz Center as soon as possible.
	Parking Lamp Front Left Auxiliary Bulb On or Parking Lamp Front Right Auxiliary Bulb On	The left or right front parking lamp is malfunctioning. A substitute bulb is being used.	► Replace the bulb as soon as possible (▷ page 311).



Vehicle status messages in the multifunction display

Display messages	Possible cause/consequence	Possible solution
 <p>High Beam Left or High Beam Right</p>	The left or right high-beam lamp is malfunctioning.	▶ Replace the bulb as soon as possible (▷ page 311).
 <p>License Plate Lamp - Left or License Plate Lamp - Right</p>	The left or right license plate lamp is malfunctioning.	▶ Replace the bulb as soon as possible (▷ page 311).
 <p>AUTO Light Inoperative</p>	The light sensor is malfunctioning. The headlamps come on automatically.	<p>▶ Contact an authorized Mercedes-Benz Center as soon as possible.</p> <p>To switch off the headlamps (U.S. vehicles only):</p> <p>▶ In the control system, set daytime running lamp mode to manual (▷ page 138).</p> <p>▶ Switch off the headlamps using the exterior lamp switch (▷ page 99).</p>
 <p>Low Beam Left or Low Beam Right</p>	The left or right low-beam lamp is malfunctioning.	▶ Contact an authorized Mercedes-Benz Center as soon as possible.
 <p>Rear Foglamp Left</p>	The left rear fog lamp is malfunctioning.	▶ Contact an authorized Mercedes-Benz Center as soon as possible.

Vehicle status messages in the multifunction display



Display messages	Possible cause/consequence	Possible solution
 Lights Are still On	You have removed the SmartKey from the starter switch, opened the driver's door and left the headlamps on or removed the SmartKey with KEYLESS-GO from the vehicle and left the headlamps on.	<ul style="list-style-type: none"> ▶ Turn the exterior lamp switch to 0 or AUTO (▷ page 99). or <ul style="list-style-type: none"> ▶ With the rear fog lamp switched on: Push in the exterior lamp switch to its stop.
 Tail Lamp Left Auxiliary Bulb On or Tail Lamp Right Auxiliary Bulb On	The left or right tail lamp is malfunctioning. A substitute bulb is being used.	<ul style="list-style-type: none"> ▶ Contact an authorized Mercedes-Benz Center as soon as possible.
 Cornering Lamp Left or Cornering Lamp Right	The left or right corner-illuminating lamp is malfunctioning.	<ul style="list-style-type: none"> ▶ Replace the bulb as soon as possible (▷ page 311).
 Turn Signal Rear Left Auxiliary Bulb On or Turn Signal Rear Right Auxiliary Bulb On	The left or right rear turn signal lamp is malfunctioning. A substitute bulb is being used.	<ul style="list-style-type: none"> ▶ Replace the bulb as soon as possible (▷ page 311).

Vehicle status messages in the multifunction display

Display messages	Possible cause/consequence	Possible solution
 <p>Turn Signal Front Left Auxiliary Bulb On or Turn Signal Front Right Auxiliary Bulb On</p>	<p>The left or right front turn signal lamp is malfunctioning. A substitute bulb is being used.</p>	<p>► Replace the bulb as soon as possible (▷ page 313).</p>
 <p>Turn Signal Left Mirror or Turn Signal Right Mirror</p>	<p>The turn signal in the left or right exterior rear view mirror is malfunctioning. This message will only appear if all LEDs have stopped working.</p>	<p>► Contact an authorized Mercedes-Benz Center as soon as possible.</p>

Vehicle status messages in the multifunction display

Tires

Display messages	Possible cause/consequence	Possible solution
	Please correct the tire pressure. The tire pressure is too low in one or more tires. or The tire pressure of the individual tires differ from each other significantly.	▶ Check and correct tire inflation pressure as required (▷ page 217).
	Tire Pressure Caution Tire Defect	▶ Carefully bring the vehicle to a halt, avoiding abrupt steering and braking maneuvers. ▶ If necessary, change the wheel (▷ page 318).
	Tire Pressure Check Tires The tire pressure in one or more tires is already below the minimum value.	▶ Carefully bring the vehicle to a halt, avoiding abrupt steering and braking maneuvers. ▶ Check and adjust tire pressure as required. ▶ If necessary, change the wheel (▷ page 318).

⚠ Warning!

Do not drive with a flat tire. A flat tire affects the ability to steer or brake the vehicle. You may lose control of the vehicle. Continued driving with a flat tire will cause excessive heat build-up and possibly a fire.

⚠ Warning!

Follow recommended tire inflation pressures.

Do not underinflate tires. Underinflated tires wear excessively and/or unevenly, adversely affect handling and fuel economy, and are more likely to fail from being overheated.



Vehicle status messages in the multifunction display

Do not overinflate tires. Overinflated tires can adversely affect handling and ride comfort, wear unevenly, increase stopping distance, and result in sudden deflation (blowout) because they are more likely to become punctured or damaged by road debris, potholes etc.

What to do if ...**Lamps in instrument cluster****Notes**



If any of the following lamps in the instrument cluster fails to come on during the bulb self-



check when switching on the ignition, have the respective bulb checked and replaced if necessary.

When you switch on the ignition, all lamps (except high beam headlamp indicator lamp, and turn signal indicator lamps unless activated) in the instrument cluster come on. If a lamp in the instrument cluster fails to come on when the ignition is switched on, have it checked and replaced if necessary.

What to do if ...

Brake

Problem	Possible cause/consequence	Suggested solutions
 The yellow ABS indicator lamp comes on while the engine is running.	<p>The ABS has detected a malfunction and switched off. The BAS, the ESP[®] and the hill start assist system (SL 63 AMG only) are also switched off (see messages in multifunction display).</p> <p>The electro-hydraulic brake system is still functioning normally but without the systems specified above available.</p> <p>If the ABS control unit is malfunctioning, other systems such as the navigation system or the automatic transmission may also be malfunctioning.</p>	<ul style="list-style-type: none"> ▶ Continue driving with added caution. Wheels may lock during hard braking, reducing steering capability. ▶ Read and observe messages that may appear in the multifunction display (▷ page 255). ▶ Have the system checked at an authorized Mercedes-Benz Center as soon as possible. <p>Failure to follow these instructions increases the risk of an accident.</p>
 The yellow ABS indicator lamp comes on while the engine is running.	<p>The ABS has switched off due to insufficient power supply.</p> <p>The battery might not be charged sufficiently.</p>	<p>When the voltage is above the required value again, the ABS is operational again and the ABS indicator lamp should go out.</p> <ul style="list-style-type: none"> ▶ If the ABS indicator lamp does not go out: Have the alternator and the battery checked.

Problem	Possible cause/consequence	Suggested solutions
BRAKE (USA only)  (Canada only) The red brake warning lamp comes on while driving and you hear a warning sound.	You are driving with the parking brake engaged.	<ul style="list-style-type: none"> ▶ Release the parking brake.
BRAKE (USA only)  (Canada only) The red brake warning lamp comes on while the engine is running and you hear a warning sound.	There is a malfunction in the electro-hydraulic brake system. There is insufficient brake fluid in the reservoir.	<ul style="list-style-type: none"> ▶ Risk of accident! Do not drive any further. Stop the vehicle in a safe location as soon as it is safe to do so. ▶ Engage the parking brake. ▶ Read and observe messages that may appear in the multifunction display (▶ page 255). ▶ Contact an authorized Mercedes-Benz Center. Do not add brake fluid! This will not solve the problem.

 **Warning!**



Driving with the brake warning lamp illuminated can result in an accident. Have your brake system checked immediately if the brake warning lamp stays on. Do not add brake fluid before checking the brake system.

Overfilling the brake fluid reservoir can result in spilling brake fluid on hot engine parts and the brake fluid catching fire. You can be seriously burned.

! If you find that the brake fluid in the brake fluid reservoir has fallen to the minimum mark or below, have the brake system checked for brake pad thickness and leaks.

What to do if ...

Safety systems

Problem	Possible cause/consequence	Suggested solutions
 The red seat belt telltale comes on for a maximum of 6 seconds after starting the engine.	The seat belt telltale reminds you and your passenger to fasten your seat belts before driving off.	▶ Fasten your seat belts. Regardless of whether the seat belts are fastened or not, the seat belt telltale always comes on and remains lit for 6 seconds after starting the engine.
 You hear a warning chime for a maximum of 6 seconds after starting the engine.	You have forgotten to fasten your seat belt.	▶ Fasten your seat belt. The warning chime stops sounding.
 The red seat belt telltale comes on while the vehicle is standing still and the engine is running or during driving.	You and/or your passenger have forgotten to fasten your seat belts.	▶ Fasten your seat belts. The seat belt telltale goes out.
	There are items placed on the passenger seat and therefore the system senses the passenger seat as being occupied.	▶ Remove the items from the front passenger seat and put them in a safe place. The seat belt telltale goes out.

Problem	Possible cause/consequence	Suggested solutions
 During driving the red seat belt telltale flashes and you additionally hear an intermittent warning chime with increasing intensity.	The vehicle's speed once exceeded 15 mph (25 km/h) and you and/or your passenger have forgotten to fasten your seat belts.	<ul style="list-style-type: none"> ▶ Fasten your seat belts. The seat belt telltale goes out and the warning chime stops sounding.
	There are items placed on the passenger seat and therefore the system senses the passenger seat as being occupied.	<ul style="list-style-type: none"> ▶ Remove the items from the passenger seat and put them in a safe place. The seat belt telltale goes out and the warning chime stops sounding.

i After 60 seconds with an unfastened seat belt the warning chime stops sounding and the seat belt telltale illuminates continuously. The seat belt telltale will only go out if both, the driver and passenger's seat belt are fastened, or the vehicle is standing still and a door is opened.



Problem	Possible cause/consequence	Suggested solutions
 The red SRS indicator lamp comes on while driving.	There is a malfunction in the restraint systems. The air bags or Emergency Tensioning Devices (ETDs) could deploy unexpectedly or fail to activate in an accident.	<ul style="list-style-type: none"> ▶ Drive with added caution to the nearest authorized Mercedes-Benz Center.





 **Warning!**

In the event a malfunction of the SRS is indicated as outlined above, the SRS may not be operational.

What to do if ...

For your safety, we strongly recommend that you contact an authorized Mercedes-Benz Center immediately to have the system checked; otherwise the SRS may not be activated when needed in an accident, which could result in serious or fatal injury, or it might deploy unexpectedly and unnecessarily which could also result in injury.

Problem	Possible cause/consequence	Suggested solutions
<p> All models, except SL 63 AMG: The yellow ABS/ESP® warning lamp comes on while the engine is running.</p>	<p>The ESP® has been switched off. Risk of accident!</p> <p>When the ESP® is switched off it will not stabilize the vehicle if the system recognizes that the vehicle starts to skid or that a wheel is spinning.</p>	<ul style="list-style-type: none"> ▶ Switch the ESP® back on. Exceptions: (▷ page 66). ▶ If leaving the ESP® switched off, adapt your speed and driving to the prevailing road and weather conditions. ▶ If the ESP® cannot be switched back on: Have the system checked at an authorized Mercedes-Benz Center as soon as possible.
<p> SL 63 AMG only: The yellow ABS/ESP® warning lamp comes on while the engine is running.</p>	<p>ESP® SPORT is activated. Risk of accident!</p> <p>When ESP® SPORT is activated it will only stabilize the vehicle to a limited extent if the system recognizes that the vehicle starts to skid or that a wheel is spinning.</p>	<ul style="list-style-type: none"> ▶ Switch the ESP® SPORT off (▷ page 67). The message ESP-ON appears in the multifunction display.

Problem	Possible cause/consequence	Suggested solutions
 SL 63 AMG only:  The yellow ABS/ESP® warning lamp and the yellow ESP® OFF warning lamp come on while the engine is running.	<p>The ESP® has been switched off. Risk of accident!</p> <p>When the ESP® is switched off it will not stabilize the vehicle if the system recognizes that the vehicle starts to skid or that a wheel is spinning.</p>	<ul style="list-style-type: none"> ▶ Switch the ESP® back on. Exceptions: (▷ page 66). ▶ If leaving the ESP® switched off, adapt your speed and driving to the prevailing road and weather conditions. ▶ If the ESP® cannot be switched back on: Have the system checked at an authorized Mercedes-Benz Center as soon as possible.
 The yellow ABS/ESP® warning lamp comes on while the engine is running.	<p>The ESP® is not operational due to a malfunction. Risk of accident!</p>	<ul style="list-style-type: none"> ▶ Read and Observe additional messages that may appear in the multifunction display. ▶ Continue driving with added caution. ▶ Adapt your speed and driving to the prevailing road and weather conditions. ▶ Have the system checked at an authorized Mercedes-Benz Center as soon as possible.
 The yellow ABS/ESP® warning lamp flashes while driving.	<p>The ESP® or Electronic Traction System (ETS) has come into operation because of detected traction loss in at least one tire. The cruise control and the Distronic system are deactivated.</p>	<ul style="list-style-type: none"> ▶ When driving off, apply as little throttle as possible. ▶ While driving, ease up on the accelerator pedal. ▶ Adapt your speed and driving to the prevailing road and weather conditions. ▶ Do not deactivate the ESP®. Exceptions: (▷ page 66). <p>Failure to follow these instructions increases the risk of an accident.</p>

What to do if ...

Problem	Possible cause/consequence	Suggested solutions
 The yellow roll bar warning lamp comes on when the engine is running.	The roll bar system is malfunctioning.	For safety reasons, always have the roll bar raised when driving with the retractable hardtop open. <ul style="list-style-type: none"> ▶ Attempt to raise the roll bar manually (▷ page 59). ▶ Have the system checked at an authorized Mercedes-Benz Center as soon as possible.



Warning!

If the yellow roll bar warning lamp  in the instrument cluster does not go out after starting the engine, or if it comes on while driving, the roll bar system is not operating



properly and may not activate in an accident. At the same time, the message **Raise Roll-over Bar** appears in the multifunc-

tion display. In this case, raise the roll bar manually before continuing to drive. For safety reasons, drive only with the roll bar raised until the malfunction is repaired. Have your vehicle checked at an authorized Mercedes-Benz Center.

Driving systems





Problem	Possible cause/consequence	Suggested solutions
 The white Distronic indicator lamp comes on while driving.	You are too close to the vehicle in front of you to maintain selected speed.	<ul style="list-style-type: none"> ▶ Apply the brakes immediately to increase the following distance.
 The red distance warning lamp comes on while driving and you hear a warning sound.	You are gaining too rapidly on the vehicle ahead of you or the distance warning system has recognized a stationary obstacle on your probable line of travel.	<ul style="list-style-type: none"> ▶ Apply the brakes immediately. ▶ Carefully observe the traffic situation. You may need to brake or maneuver to avoid hitting an obstacle.



Vehicle

Problem	Possible cause/consequence	Suggested solutions
 The yellow fuel tank reserve warning lamp comes on when the engine is running.	The fuel level has gone below the reserve mark.	<ul style="list-style-type: none"> ▶ Refuel at the next gas station.
 The yellow fuel tank reserve warning lamp comes on when the engine is running.	The fuel cap is not closed properly.	<ul style="list-style-type: none"> ▶ Close the fuel cap.

What to do if ...

Engine

Problem	Possible cause/consequence	Suggested solutions
<p> (USA only)  (Canada only)</p> <p>The yellow engine malfunction indicator lamp comes on when the engine is running.</p>	<p>There may be a malfunction in:</p> <ul style="list-style-type: none"> • The fuel management system • The ignition system • The emission control system • Systems which affect emissions <p>Such malfunctions may result in excessive emissions values and may switch the engine to limp-home (emergency operation) mode.</p>	<ul style="list-style-type: none"> ▶ Have the vehicle checked as soon as possible at an authorized Mercedes-Benz Center. ❗ Some states may by law require you to visit a workshop as soon as the engine malfunction indicator lamp comes on. Check local requirements.
<p> (USA only)  (Canada only)</p> <p>The yellow engine malfunction indicator lamp comes on when the engine is running.</p>	<p>A loss of pressure has been detected in the fuel system. The fuel cap may not be closed properly or the fuel system may be leaky.</p>	<ul style="list-style-type: none"> ▶ Check the fuel cap (▷ page 201). ▶ If it is not closed properly: Close the fuel cap. ▶ If it is closed properly: Have the fuel system checked by an authorized Mercedes-Benz Center.

Problem	Possible cause/consequence	Suggested solutions
 The red coolant temperature warning lamp comes on when the engine is running.	<p>There is insufficient coolant in the reservoir.</p> <p>If this warning lamp comes on frequently, there is a leak in the cooling system.</p> <p>If the coolant level is correct, the electric radiator fan may be broken.</p>	<ul style="list-style-type: none"> ▶ Immediately add coolant to prevent engine from overheating (▷ page 207). ▶ Have the cooling system checked. ▶ If the coolant temperature is below 248°F (120°C), you can continue driving to the nearest authorized Mercedes-Benz Center. ▶ Avoid high engine loads (e.g. driving uphill) and stop-and-go driving.
 The red coolant temperature warning lamp comes on when the engine is running and you hear a warning sound.	<p>The coolant temperature has exceeded 248°F (120°C).</p>	<ul style="list-style-type: none"> ▶ Stop in a safe location as soon as possible and allow the engine and coolant to cool down.

 **Warning!**

Driving when your engine is overheated can cause some fluids which may have leaked into the engine compartment to catch fire. You could be seriously burned.

Steam from an overheated engine can cause serious burns which can occur just



by opening the engine hood. Stay away from the engine if you see or hear steam coming from it.

Stop the vehicle in a safe location away from other traffic. Turn off the engine, get out of the vehicle and do not stand near the vehicle until the engine has cooled down.

 The engine should not be operated with the coolant temperature above 248°F (120°C). Doing so may cause serious damage which is not covered by the Mercedes-Benz Limited Warranty.

What to do if ...

Tires

Problem	Possible cause/consequence	Suggested solutions
<p> USA only: Combination low tire pressure telltale/TPMS malfunction telltale for the TPMS illuminates continuously.</p> <p>Canada only: Low tire pressure telltale for the Advanced TPMS illuminates continuously.</p>	<p>The TPMS (USA only) or Advanced TPMS (Canada only) detects a loss of pressure in at least one tire.</p>	<ul style="list-style-type: none"> ▶ Carefully bring the vehicle to a halt, avoiding abrupt steering and braking maneuvers. Observe the traffic situation around you. ▶ Read and observe messages in the multifunction display (▷ page 255). <p>If the tire inflation pressure in the respective tire(s) has (have) been corrected, the combination low tire pressure/TPMS malfunction telltale goes out after a few minutes of driving.</p>
<p> USA only: Combination low tire pressure telltale/TPMS malfunction telltale for the TPMS flashes 60 seconds and then stays illuminated.</p>	<p>There is a malfunction in the TPMS.</p>	<ul style="list-style-type: none"> ▶ Read and observe messages in the multifunction display (▷ page 255). ▶ Have the TPMS checked by an authorized Mercedes-Benz Center. <p>After the malfunction has been remedied, the combination low tire pressure/TPMS malfunction telltale goes out after a few minutes of driving.</p>

Warning!

Each tire, including the spare (if provided), should be checked every other week when cold and inflated to the inflation pressure

recommended by the vehicle manufacturer on the Tire and Loading Information placard on the driver's door B-pillar or, if available, the tire inflation pressure label on the inside of the fuel filler flap. If your vehicle has tires

of a different size than the size indicated on the vehicle placard or the tire inflation pressure label, you should determine the proper tire inflation pressure for those tires.

What to do if ...

As an added safety feature, your vehicle has been equipped with a tire pressure monitoring system (TPMS) that illuminates a low tire pressure telltale when one or more of your tires are significantly underinflated. Accordingly, when the low tire pressure telltale illuminates, you should stop and check your tires as soon as possible, and inflate them to the proper pressure. Driving on a significantly underinflated tire causes the tire to overheat and can lead to tire failure.

Underinflation also reduces fuel efficiency and tire tread life, and may affect the vehicle's handling and stopping ability. Please

note that the TPMS is not a substitute for proper tire maintenance, and it is the driver's responsibility to maintain correct tire pressure, even if underinflation has not reached the level to trigger illumination of the TPMS low tire pressure telltale.

USA only:

Your vehicle has also been equipped with a TPMS malfunction indicator to indicate when the system is not operating properly. The TPMS malfunction indicator is combined with the low tire pressure telltale. When the system detects a malfunction, the telltale will flash for approximately 1 minute and then remain continuously illu-

minated. This sequence will continue upon subsequent vehicle start-ups as long as the malfunction exists. When the malfunction indicator is illuminated, the system may not be able to detect or signal low tire pressure as intended.

TPMS malfunctions may occur for a variety of reasons, including the installation of replacement or alternate tires or wheels on the vehicle that prevent the TPMS from functioning properly. Always check the TPMS malfunction telltale after replacing one or more tires or wheels on your vehicle to ensure that the replacement or alternate tires and wheels allow the TPMS to continue to function properly.

Lamp in center console

Problem	Possible cause/consequence	Suggested solutions
 <p>The indicator lamp illuminates and remains illuminated with the weight of a typical adult or someone larger than a small individual on the passenger seat.</p>	<p>The system is malfunctioning.</p>	<ul style="list-style-type: none"> ▶ Have the system checked as soon as possible at an authorized Mercedes-Benz Center. ▶ Read and observe messages in the multifunction display and follow corrective steps (> page 255).



What to do if ...

Warning!

If the  indicator lamp illuminates and remains illuminated with the weight of

a typical adult or someone larger than a small individual on the passenger seat, do

not have any passenger use the passenger seat until the system has been repaired.

Problem	Possible cause/consequence	Suggested solutions
 <p>The indicator lamp does not illuminate and/or does not remain illuminated with the weight of a typical 12-month-old child in a standard child restraint or less on the passenger seat.</p>	<p>The system is malfunctioning.</p>	<ul style="list-style-type: none"> ▶ Make sure there is nothing between seat cushion and child seat and check installation of the child seat. ▶ Make sure no objects applying supplemental weight onto the seat are present. ▶ If the indicator lamp remains out, have the system checked as soon as possible at an authorized Mercedes-Benz Center. Do not transport a child on the passenger seat until the system has been repaired. ▶ Read and observe messages in the multifunction display and follow corrective steps (▷ page 255).

Warning!

If the  indicator lamp does not illuminate or remains out with the weight of a typical 12-month-old child in a standard child restraint or less on the passenger seat, do not transport a child on the passenger seat until the system has been repaired.

Unlocking/locking manually

Unlocking the vehicle

If you cannot unlock the vehicle with the SmartKey or with KEYLESS-GO, unlock the driver's door and the trunk using the mechanical key.

- 1 Unlocking the vehicle with the mechanical key and opening the driver's door or the trunk will trigger the anti-theft alarm system.

To cancel the alarm, insert the SmartKey in the starter switch.

Removing the mechanical key

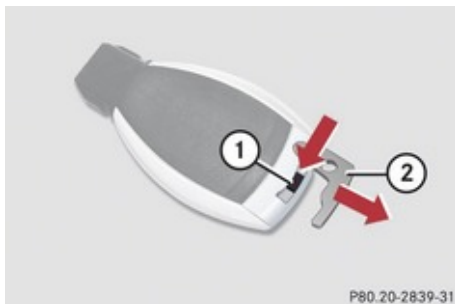

- 1 Mechanical key locking tab
- 2 Mechanical key

- ▶ Move locking tab 1 in direction of arrow.
- ▶ Slide mechanical key 2 out of the housing.

Unlocking the driver's door

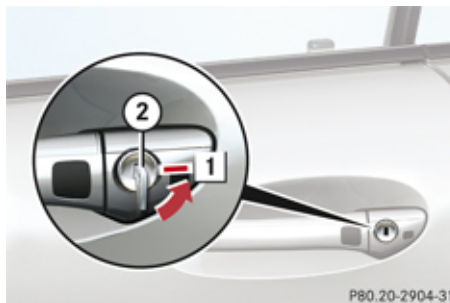

- 1 Unlocking
- 2 Mechanical key

- ▶ Insert mechanical key 2 into the driver's door lock until it stops.
- ▶ Turn mechanical key 2 counterclockwise to position 1 until the locking knob moves up.
The driver's door is unlocked.
- ▶ Pull the door handle to open the driver's door.

Unlocking/locking manually

Unlocking the trunk

A minimum height clearance of 6.2 ft (1.89 m) is required to open the trunk lid.

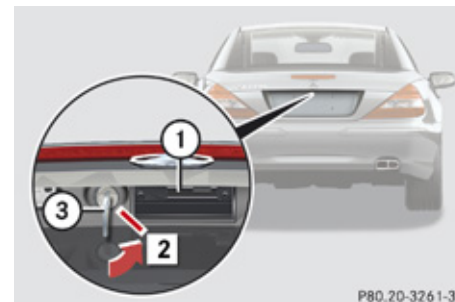

- 1 Handle
- 2 Unlocking
- 3 Mechanical key

- ▶ Insert mechanical key 3 into the trunk lid lock until it stops.
- ▶ Turn mechanical key 3 counterclockwise to position 2.
- ▶ Pull handle 1 and lift the trunk lid.
- ! Always make sure there is sufficient overhead clearance.
- ▶ Turn mechanical key 3 back and remove it from the trunk lid lock.

Unlocking/locking manually

Unlocking the glove box

Lockable storage areas in the passenger compartment include:

- the glove box
- the storage compartment under the armrest
- the rear storage compartments

If these cannot be unlocked by means of the SmartKey, use the mechanical key to unlock the glove box.

i To unlock the remaining storage compartments, the cause for the malfunction of the SmartKey must be determined and corrected, see (▷ page 76).

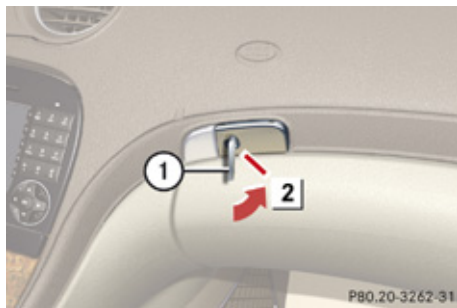

① Mechanical key

② Separately unlocking the glove box

- ▶ Slide mechanical key ① into the glove box lock and turn it counterclockwise to position ②.

You can now open the glove box.

i Unlocking the glove box with the mechanical key will trigger the anti-theft alarm system.

To cancel the alarm, insert the SmartKey in the starter switch.

Locking the vehicle

If you cannot lock the vehicle with the SmartKey or with KEYLESS-GO, lock it as follows:

- ▶ Close the passenger door and the trunk.
- ▶ Press the central locking switch (▷ page 81).
- ▶ Check to see whether the locking knob on the passenger door has moved down.
- ▶ If necessary, push it down manually.
- ▶ Exit the vehicle and close the driver's door.
- ▶ Remove the mechanical key from the SmartKey (▷ page 307).

- ▶ Check whether the trunk is locked.
- ▶ If it is not locked, lock it with the mechanical key (▷ page 86).

Except for the driver's door, the vehicle should now be locked.

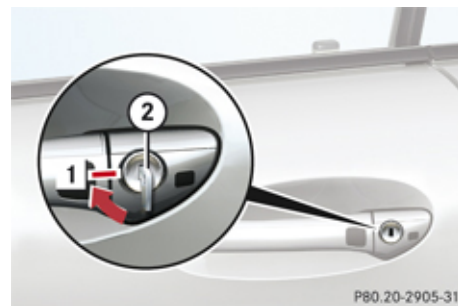

① Locking

② Mechanical key

- ▶ Insert mechanical key ② into the driver's door lock until it stops.
- ▶ Turn mechanical key ② clockwise to position ①.

The driver's door is locked.

i This procedure does not arm the anti-theft alarm system, nor does it lock the fuel filler flap and the storage compartments.

The storage compartments can be locked separately (▷ page 182).

Lowering the load assist manually

If the load assist feature does not fully lower the retractable hardtop into the trunk compartment and you are unable to close the trunk lid, follow the instructions below.

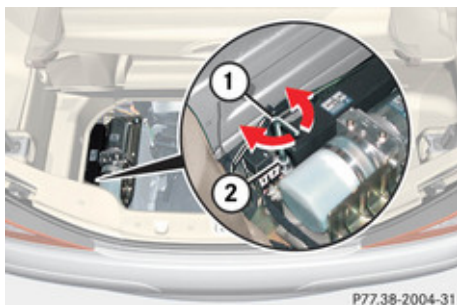

① Hex-socket wrench

② Locking screw

- ▶ Remove the trunk floor from the trunk.
- ▶ Have a second person lift and hold the retracted hardtop.
- ▶ Using hex-socket wrench ① provided in the vehicle tool kit, carefully turn locking

screw ② approximately one quarter of a turn.

- ▶ Hook luggage cover into holders (▷ page 178).
- ▶ Let go of the hardtop. It should gradually lower into the trunk.
- ▶ When hardtop is completely lowered, return locking screw ② to its original position.
- ❗ Do not overtighten the screw.
- ▶ Replace the trunk floor.
- ▶ Contact an authorized Mercedes-Benz Center as soon as possible.

Replacing SmartKey batteries

Replacing SmartKey batteries

If the batteries in the SmartKey are discharged, the vehicle can no longer be locked or unlocked. It is recommended to have the batteries replaced at an authorized Mercedes-Benz Center.

⚠ Warning!

Batteries contain poisonous and corrosive substances. Therefore, keep the batteries out of reach of children.

If a battery is swallowed, seek medical help immediately.

⚠ Warning

SmartKey batteries contain Perchlorate material, which may require special handling and regard for the environment. Check with your local government's disposal guidelines. California residents, see <http://www.dtsc.ca.gov/Hazardous-Waste/Perchlorate/index.cfm>.

Batteries contain materials that can harm the environment if disposed of improperly. Recycling of batteries is the preferred method of disposal. Many states require sellers of batteries to accept old batteries for recycling.

Replacing SmartKey batteries

When inserting the batteries, make sure they are clean and free of lint.

When replacing batteries, always replace both batteries.

i The required replacement batteries are available at any authorized Mercedes-Benz Center.

Replacement batteries: Lithium, type CR 2025 or equivalent.

▶ Remove the mechanical key from the SmartKey (▶ page 307).

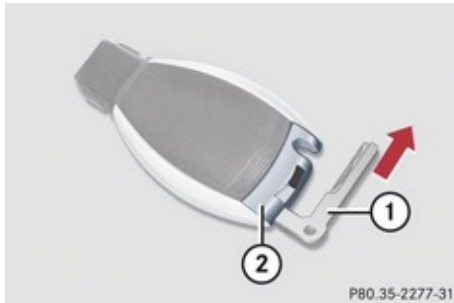

- ① Mechanical key
- ② Battery compartment

- ▶ Insert mechanical key ① into opening.
- ▶ Press mechanical key ① in direction of arrow.
Battery compartment ② is unlatched.
- ▶ Pull battery compartment ② out of the SmartKey housing.

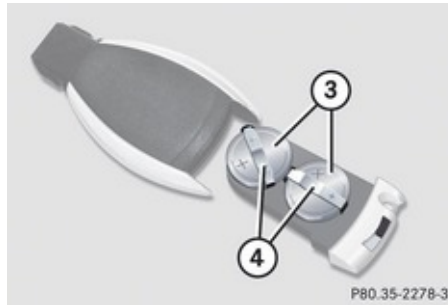

- ③ Batteries
- ④ Contact springs

- ▶ Pull out batteries ③.
- ▶ Insert new batteries ③ under contact springs ④ with the positive terminal (+) side facing up.
- ▶ Return battery compartment ② into SmartKey housing until it locks into place.

- ▶ Slide mechanical key ① back into the SmartKey.
- ▶ Check the operation of the SmartKey as well as the KEYLESS-GO function.

Replacing bulbs

Safety notes

Safe vehicle operation depends to a large degree on proper exterior lighting and signaling.

Correct headlamp adjustment is extremely important. Have headlamps checked and readjusted at regular intervals and when a bulb has been replaced. Contact an authorized Mercedes-Benz Center for headlamp adjustment.

Warning!

Bulbs and bulb sockets can be very hot. Allow the lamp to cool down before changing a bulb.

Keep bulbs out of reach of children.

Halogen lamps contain pressurized gas. A bulb can explode if you:

- touch or move it when hot
- drop the bulb
- scratch the bulb

Wear eye and hand protection.

Because of high voltage in Xenon lamps, it is dangerous to replace the bulb or repair

the lamp and its components. We recommend that you have such work done by a qualified technician.

- 1** If the headlamps or front fog lamps are fogged up on the inside as a result of high humidity, driving the vehicle a distance with the lights on should clear up the fogging.

Bulbs

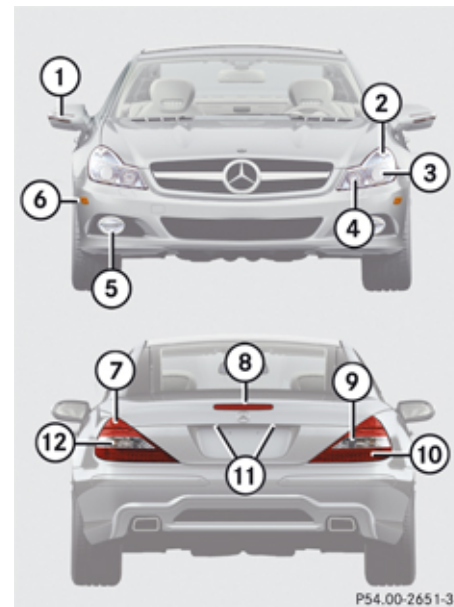

P54.00-2651-31

Replacing bulbs

Front lamps

	Lamp	Type
①	Additional turn signal lamp	LED
②	Turn signal lamp	PY 24 W
③	Low- and high-beam headlamp ¹³	D 1S-35 W
④	High-beam/high-beam flasher lamp	H7 (55 W)
	Parking and standing lamp	W 5 W (Blue Vision)
	Corner-illuminating lamp	H7 (55 W)
⑤	Front fog lamp	H 11 (55 W)
⑥	Side marker lamp	W 5 W

Rear lamps

	Lamp	Type
⑦	Rear fog lamp (driver's side only)	P 21 W
⑧	High-mounted brake lamp	LED
⑨	Backup lamp	P 21 W
⑩	Brake lamp, tail lamp, parking and standing lamp, side marker lamp	LED
⑪	License plate lamps	C 5 W
⑫	Turn signal lamp	PY 21 W

Notes on bulb replacement

- Only use 12 volt bulbs of the same type and with the specified watt rating.
- Switch the lights off before changing a bulb to prevent short circuits.
- Always use a clean lint-free cloth when handling bulbs.

- Your hands should be dry and free of oil and grease.
- If the newly installed bulb does not come on, contact an authorized Mercedes-Benz Center.

Have the LEDs and bulbs for the following lamps replaced at an authorized Mercedes-Benz Center:

- Additional turn signal lamps in the exterior rear view mirrors
- Front turn signal lamps
- High-mounted brake lamp
- Bi-Xenon lamps
- Front fog lamps
- Side marker lamps
- Parking and standing lamps in the tail lamp unit
- Brake lamps
- Rear fog lamp

! Do not replace the LEDs yourself. You could otherwise damage the LEDs or parts of the vehicle. Only have the LEDs replaced at an authorized Mercedes-Benz Center.

¹³ Low beam and high beam use the same D1S-35 W lamp. Do not replace the Bi-Xenon bulbs yourself. Contact an authorized Mercedes-Benz Center.

Replacing bulbs

Replacing bulbs for front lamps

Warning!

Do not remove the cover for the Bi-Xenon headlamp. Because of high voltage in Xenon lamps, it is dangerous to replace the bulb or repair the lamp and its components. We recommend that you have such work done by a qualified technician.

Before you start to replace a bulb for a front lamp, do the following first:

- ▶ Switch off the ignition.
- ▶ Turn the exterior lamp switch to position **0**.
- ▶ Open the hood (▷ page 203).

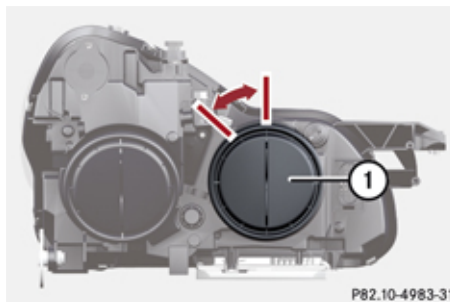

- ① Housing cover for high-beam headlamp, parking and standing lamp, corner-illuminating lamp

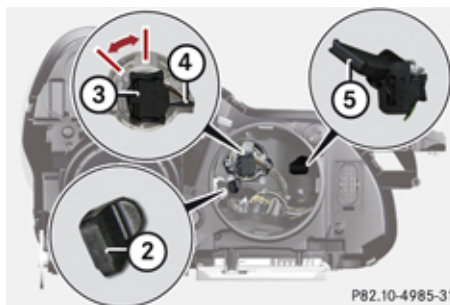

- ② Bulb socket for parking and standing lamp bulb
- ③ Bulb socket for high-beam bulb
- ④ Cable outlet for high-beam bulb

- ⑤ Bulb socket for corner-illuminating lamp bulb

High-beam and high-beam flasher bulb

- ▶ Turn housing cover ① counterclockwise and remove it.
- ▶ Pull out bulb socket ②.
- ▶ Turn bulb socket ③ with the bulb counterclockwise and remove it.
- ▶ Pull the bulb out of bulb socket ③.
- ▶ Press the new bulb gently into bulb socket ③.
- ▶ Insert bulb socket ③ into the guide in the headlamp.
- ▶ Turn bulb socket ③ clockwise until it engages.

Driver's side headlamp: Cable outlet ④ of bulb socket ③ must point towards the lower right.

Passenger side headlamp: Cable outlet ④ of bulb socket ③ must point towards the lower left.

- ▶ Place bulb socket ② back into the housing.
- ▶ Align housing cover ① and turn it clockwise until it engages.

Replacing bulbs

Parking and standing lamp bulb

- ▶ Turn housing cover ① counterclockwise and remove it.
- ▶ Pull out bulb socket ②.
- ▶ Pull the bulb out of bulb socket ②.
- ▶ Press the new bulb gently into bulb socket ②.
- ▶ Place bulb socket ② back into the housing.
- ▶ Align housing cover ① and turn it clockwise until it engages.

Corner-illuminating lamp bulbs

- ▶ Turn housing cover ① counterclockwise and remove it.
- ▶ Turn bulb socket ⑤ counterclockwise and remove it.
- ▶ Pull the bulb out of bulb socket ⑤.
- ▶ Press the new bulb gently into bulb socket ⑤.
- ▶ Insert bulb socket ⑤ into the guide in the headlamp.

- ▶ Turn bulb socket ⑤ clockwise until it engages.
The handle of the bulb socket must be vertical.
- ▶ Align housing cover ① and turn it clockwise until it engages.

Replacing bulbs for rear lamps

Before you start to replace a bulb for a rear lamp, do the following first:

- ▶ Switch off the ignition.
- ▶ Turn the exterior lamp switch to position **0**.
- ▶ Open the trunk.

Tail lamp unit

Opening the driver's side trim panel

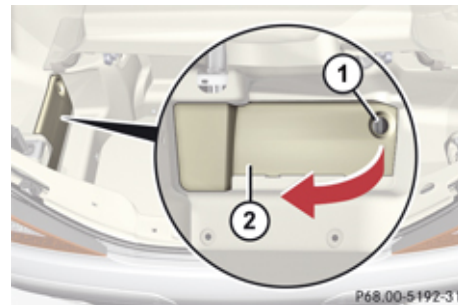

- ① Lock
- ② Cover

- ▶ Turn lock ① counterclockwise by 90°.
- ▶ Remove cover ②.

Replacing bulbs

Opening the passenger side trim panel



- ① Lock
- ② Cover

► Move lock ① in direction of the arrow and remove cover ②.

Replacing bulbs

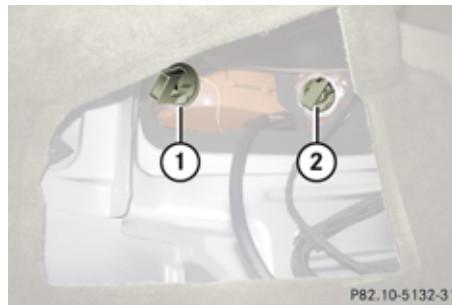

Example illustration bulb socket passenger side

- ① Turn signal lamp
- ② Backup lamp

- ❗ The lamps on the driver's side are mirrored.
- Depending on which bulb needs to be replaced, turn bulb socket ① or ② counterclockwise and remove it.
- Press gently onto the respective bulb and turn clockwise out of its bulb socket.
- Press the new bulb gently into its bulb socket and turn counterclockwise until it engages.

- Align the respective bulb socket and press it into the tail lamp unit until it audibly engages.
- Reinstall the trim.

License plate lamps

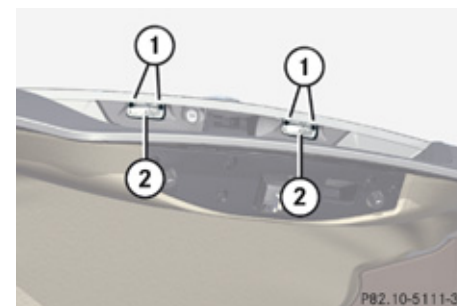

- ① Screws
- ② Lamp cover
- Loosen both screws ①.
- Remove lamp cover ②.
- Replace the bulb.
- Reinstall lamp cover ②.
- Retighten screws ①.

Replacing wiper blades

Replacing wiper blades

Safety notes

Warning!

For safety reasons, switch off wipers and remove SmartKey from starter switch (vehicles with KEYLESS-GO: Make sure the vehicle's on-board electronics have status **0**) before replacing a wiper blade. Otherwise, the wiper motor could suddenly turn on and cause injury.

Warning!

Wiper blades are components that are subject to wear and tear. Replace the wiper blades twice a year, preferably in the spring and fall. Otherwise the windows will not be properly wiped. As a result, you may not be able to observe surrounding traffic conditions and could cause an accident.

 To avoid damage to the hood the wiper arms should only be folded forward when in the vertical position.

 Never open the hood when a wiper arm is folded forward.

Hold on to the wiper when folding a wiper arm back. If released, the force of the

impact from the tensioning spring could crack the windshield.

Do not allow a wiper arm to contact the windshield glass without a wiper blade inserted.

For your convenience, we recommend that you have this work carried out at an authorized Mercedes-Benz Center.

Placing wiper arms in vertical position



Wiper arms in vertical position

- ▶ Make sure the hood is fully closed.

Vehicles with SmartKey

- ▶ Turn the SmartKey in the starter switch to position **1**.
- ▶ Turn combination switch to wiper setting **II**.
- ▶ With wiper arms in vertical position, turn the SmartKey in the starter switch to position **0**.
- ▶ Remove the SmartKey from the starter switch.

Vehicles with KEYLESS-GO

- ▶ Turn off the engine.
With the driver's door closed, the starter switch is now in position **1**.
- ▶ Turn combination switch to wiper setting **II**.
- ▶ With wiper arms in vertical position, open the driver's door.
The starter switch is set to position **0**, same as the SmartKey removed from the starter switch.
- ▶ Turn combination switch to wiper setting **0**.

Removing wiper blades

- ❗ Do not pull on the wiper blade inserts. They could tear.
- ▶ Fold the wiper arm forward until it snaps into place.

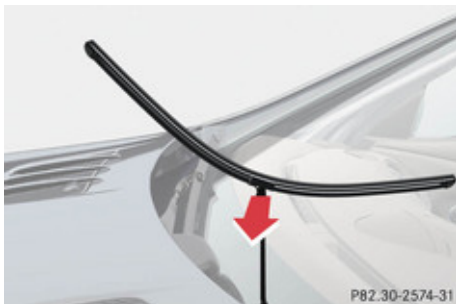

- ▶ Turn the wiper blade at a right angle to wiper arm.
- ▶ Slide the wiper blade sideways out of the retainer.

Installing wiper blades

- ▶ Slide the wiper blade onto wiper arm in opposite direction of arrow.
- ▶ Rotate the wiper blade into position parallel to the wiper arm.
- ▶ Fold the wiper arm backward to rest on the windshield.
Make sure you hold on to the wiper when folding the wiper arm back.
- ❗ Make sure the wiper blades are properly installed. Improperly installed wiper blades may cause windshield damage.

Flat tire

Safety notes

⚠ Warning!

The dimensions of the spare wheel are different from those of the road wheels. As a result, the vehicle handling characteristics change when driving with a spare wheel mounted. Adapt your driving style accordingly.

The spare wheel is for temporary use only. When driving with spare wheel mounted, ensure proper tire inflation pressure and do not exceed a vehicle speed of 50 mph (80 km/h).

Contact the nearest authorized Mercedes-Benz Center as soon as possible to have the spare wheel replaced with a regular road wheel.

Never operate the vehicle with more than one spare wheel mounted.

Do not switch off the ESP[®] when a spare wheel is mounted.

Flat tire

Preparing the vehicle

- ▶ Park the vehicle in a safe distance from moving traffic on a hard, flat surface when possible.
- ▶ Turn on the hazard warning flasher.
- ▶ Turn the steering wheel so that the front wheels are in a straight-ahead position.
- ▶ Engage the parking brake.
- ▶ Shift the automatic transmission into park position **P**.
- ▶ Turn off the engine.
- ▶ Remove the SmartKey from the starter switch.

or

- ▶ Vehicles with KEYLESS-GO: Open the driver's door (this puts the starter switch in position **O**, same as with the SmartKey removed from the starter switch). The driver's door can then be closed again. Open doors only when conditions are safe to do so.
- ▶ Have any passenger exit the vehicle at a safe distance from the roadway. Open doors only when conditions are safe to do so.

Mounting the spare wheel

Introduction

- ▶ Prepare the vehicle as described (▷ page 318).
- ▶ Take the following out of the vehicle:
 - spare wheel
 - jack
 - vehicle tool kit
 - wheel wrench
 - electric air pump

For information on where to find the respective items, see "Where will I find ...?" (▷ page 252) and (▷ page 253).

Removing tensioning straps from spare wheel

This description applies to vehicles with 19" spare wheel with collapsible tire only.

A 19" spare wheel with collapsible tire has two tensioning straps on it that must be removed before mounting the spare wheel.

- ① The tensioning straps are shown in red for illustration purposes. The tensioning straps on the spare wheel of your vehicle may be of a different color.

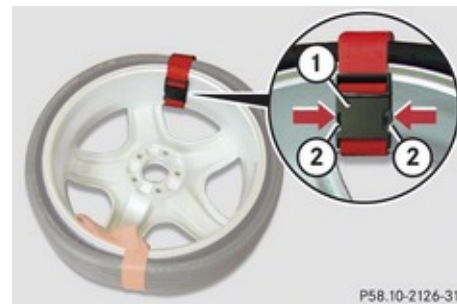

- ① Buckle
- ② Clip

- ▶ Press on both clips ② simultaneously to release buckle ①.
- ▶ Store the tensioning straps in a safe place. You will need them to store the spare wheel in the trunk after use.

Lifting the vehicle

Warning!

When jacking up the vehicle, only use the jack which has been specifically approved by Mercedes-Benz for your vehicle. The jack is designed exclusively for jacking up the vehicle at the jack tubes built into both sides of the vehicle. Make sure the

Flat tire

jack arm is fully inserted in the jack tube. The jack must always be vertical when in use, especially on inclines or declines.

The jack is intended only for lifting the vehicle briefly for wheel changes. It is not suited for performing maintenance work under the vehicle. To help avoid personal injury, use the jack only to lift the vehicle during a wheel change.

Never get beneath the vehicle while it is supported by the jack. Keep hands and feet away from the area under the lifted vehicle. Always lower the vehicle onto sufficient capacity jackstands before working under the vehicle.

Always firmly set the parking brake and block the wheels with wheel chocks or other sizeable objects before raising the vehicle with the jack. Do not disengage the parking brake while the vehicle is raised. Make sure that the ground on which the vehicle is standing and where you place the jack is solid, level and not slippery. If necessary, use a large underlay. On slippery surfaces, such as tiled floors, you should use a non-slip underlay, for example a rubber mat.

Do not use wooden blocks or similar objects to support the jack. Otherwise the jack may not be able to achieve its load-bearing capacity if it is not at its full height. Never start the engine when the vehicle is raised.

Also observe the notes on the jack.

- ▶ Prevent the vehicle from rolling away by blocking wheels with wheel chocks (not included) or other sizeable objects.

When changing wheel on a level surface:

- ▶ Place one wheel chock or other sizeable object in front of and another wheel chock or other sizeable object behind the wheel that is diagonally opposite to the wheel being changed.

Always try lifting the vehicle using the jack on a level surface. However, should circumstances require you to do so on a hill, place a wheel chock or other sizeable object and the other wheel chock or sizeable object as follows:

- ▶ Place wheel chocks or other sizeable objects on the downhill side blocking both wheels of the axle not being worked on.

⚠ Warning!

Only jack up the vehicle on level ground or on slight inclines/declines. Otherwise, the vehicle could fall off the jack and injure you or others.

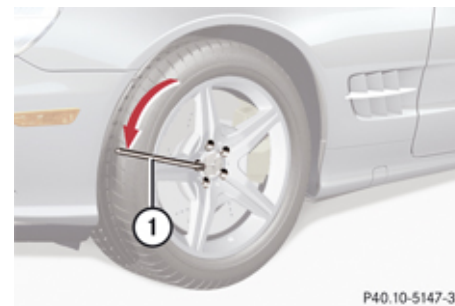

① Wheel wrench

- ▶ On wheel to be changed, loosen but do not yet remove the wheel bolts (approximately one full turn with wrench ①).

The jack support tubes are located directly behind the front wheel housings and in front of the rear wheel housings.

⚠ Warning!

When turning the wheel wrench to loosen the wheel bolts, make sure you position



Flat tire

your hands on the wrench in such a way that you avoid injury to yourself, such as scraping your hands against the wheel. Make sure turning the wheel wrench will not scratch or damage the wheel rim.

! Do not position the jack on the body of the vehicle, as this may cause damage to the vehicle.

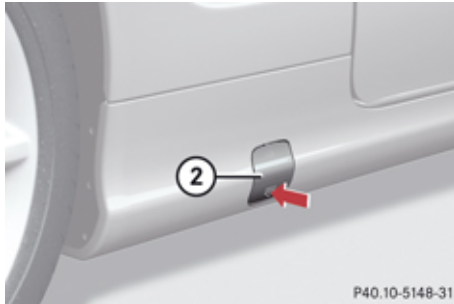

② Jack support tube cover (except SL 63 AMG, SL 65 AMG, and vehicles with Sport Package)

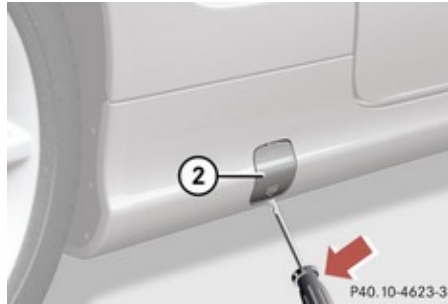

② Jack support tube cover (SL 63 AMG, SL 65 AMG, and vehicles with Sport Package only)

▶ Open cover ② by pressing at point indicated by arrow.

or

▶ Insert a flat blade screwdriver in the opening of cover ② and pry it out.

▶ Remove cover ②, taking care not to damage the locking tabs.

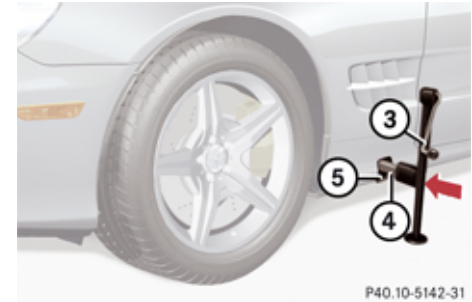

③ Crank

④ Jack arm

⑤ Jack support tube hole

▶ Insert jack arm ④ fully into tube hole ⑤ up to the stop.

⚠ Warning!

Insert the jack fully into the jack support tube hole up to the stop. Otherwise, the vehicle may fall from the jack and cause personal injury or damage to the vehicle.

▶ Keeping jack in this position, turn crank ③ clockwise until the jack base meets the ground. Make sure the jack is vertical.

Flat tire

- ▶ Place jack ③ on firm ground.
- ▶ Position jack ③ under take-up bracket ② so that it is always vertical as seen from the side, even if the vehicle is parked on an incline.
- ▶ Jack up the vehicle until the wheel is a maximum of 1.2 in (3 cm) from the ground.

Removing the wheel

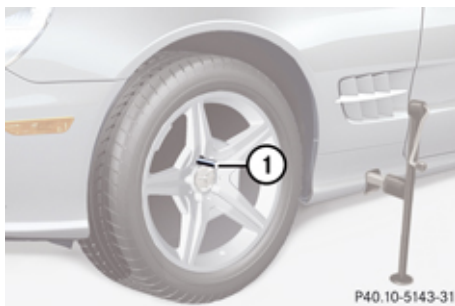

① Alignment bolt

- ▶ Unscrew uppermost wheel bolt and remove it.
- ▶ Replace this wheel bolt with alignment bolt ① supplied with the vehicle tool kit.
- ▶ Remove the remaining bolts.

- ❗ Do not place wheel bolts in sand or dirt. This could result in damage to the wheel bolts and wheel hub threads.
- ▶ Remove the wheel.

Attaching the spare wheel

⚠ Warning!

Inflate collapsible tire only after the wheel is properly attached.

Inflate the collapsible tire using the electric air pump before lowering the vehicle.

⚠ Warning!

Always replace wheel bolts that are damaged or rusted.

Never apply oil or grease to wheel bolts.

Damaged wheel hub threads should be repaired immediately. Do not continue to drive under these circumstances! Contact an authorized Mercedes-Benz Center or call Roadside Assistance.

Incorrect wheel bolts or improperly tightened wheel bolts can cause the wheel to come off. This could cause an accident. Be sure to use the correct wheel bolts.

⚠ Warning!

Only use genuine Mercedes-Benz wheel bolts. Other wheel bolts may come loose.

Do not tighten the wheel bolts when the vehicle is raised. Otherwise the vehicle could fall off the jack.

- ▶ Clean contact surfaces of wheel and wheel hub.

- ❗ To avoid paint damage, place wheel flat against hub and hold it there while installing first wheel bolt.



- ▶ Guide the spare wheel onto the alignment bolt and push it on.
- ▶ Insert the wheel bolts and tighten them slightly.



Flat tire

- ▶ Unscrew the alignment bolt.
- ▶ Install last wheel bolt and tighten it slightly.
- ▶ Inflate the collapsible tire (> page 322).

Inflating the collapsible tire

⚠ Warning!

Inflate collapsible tire only after the wheel is properly attached.

Inflate the collapsible tire using the electric air pump before lowering the vehicle.

⚠ Warning!

Observe safety instructions on air pump label.

❗ Do not lower the vehicle before inflating the collapsible tire. Otherwise the rim may be damaged.

Your vehicle may be equipped with either of two versions of the electric air pump:

- **Version 1:** The air hose with pressure gauge and the electrical plug are located behind a flap.
- **Version 2:** The pressure gauge is located in the pump housing. The air hose and elec-

trical plug are located at the bottom of the pump housing.

The following description applies to both versions. Differences in usage are expressly declared.

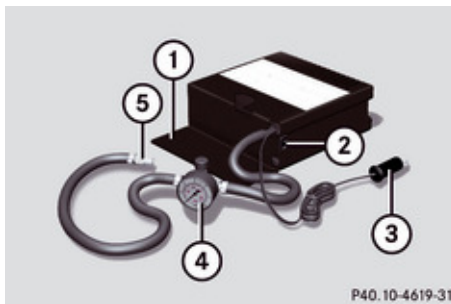

Version 1

- ① Flap
- ② Air pump switch
- ③ Electrical plug
- ④ Air hose with pressure gauge and vent screw
- ⑤ Union nut

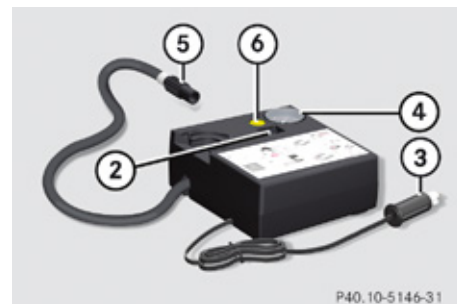

Version 2

- ② Air pump switch
- ③ Electrical plug
- ④ Pressure gauge
- ⑤ Union nut
- ⑥ Deflate button

- ▶ **Version 1 only:** Open flap ① on electric air pump.
- ▶ **Version 1 only:** Pull out electrical plug ③ and air hose with pressure gauge ④.
- ▶ **Version 2 only:** Pull electrical plug ③ and the air hose out of the pump housing bottom.
- ▶ **Version 1 only:** Close vent screw on air hose ④.

Flat tire

- ▶ Remove the valve cap from the collapsible tire valve.
- ▶ Screw union nut ⑤ onto the collapsible tire valve.
- ▶ Make sure air pump switch ② is set to **0**.
- ▶ Insert electrical plug ③ into the cigarette lighter socket (▷ page 186) or a power outlet (▷ page 187).

- ▶ Turn the SmartKey in the starter switch to position **1**.

or

- ▶ Vehicles with KEYLESS-GO: Press the KEYLESS-GO start/stop button on the gear selector lever once. Do not depress the brake pedal.

- ▶ Press **I** on electric air pump switch ②. The electric air pump switches on and inflates the collapsible tire.

- ▶ Inflate the collapsible tire to the recommended tire inflation pressure as specified for your vehicle (▷ page 346).

This should take approximately 5 minutes.

Warning!

The air hose and the union nut can become hot during inflation. Exercise proper cau-

tion to avoid burning yourself when using the equipment.

- ❗ Do not operate the electric air pump longer than 8 minutes without interruption. Otherwise it may overheat.

You may operate the air pump again after it has cooled off.

- ❗ Compare the recommended tire inflation pressure for your vehicle with the tire inflation pressure on the yellow label located on the spare wheel rim.

If the tire inflation pressure on the yellow label on the spare wheel rim differs from the values given in this Operator's Manual, inflate the tire to the recommended tire inflation pressure given on the yellow label on the spare wheel rim.

- ▶ Press **0** on electric air pump switch ②.
- ▶ Turn the SmartKey in the starter switch to position **0**.

or

- ▶ Vehicles with KEYLESS-GO: Press the KEYLESS-GO start/stop button on the gear selector lever twice. Do not depress the brake pedal.

- ▶ **Version 1 only:** If the tire inflation pressure is above the recommended tire inflation pressure as specified for your vehicle (▷ page 346), decrease tire pressure using the vent screw on air hose ④.

- ▶ **Version 2 only:** If the tire inflation pressure is above the recommended tire inflation pressure as specified for your vehicle (▷ page 346), decrease tire pressure using deflate button ⑥.

Warning!

Follow recommend inflation pressures.

Do not overinflate tires. Overinflating tires can result in sudden deflation (blowout) because they are more likely to become punctured or damaged by road debris, potholes, etc.

Do not underinflate tires. Underinflated tires wear unevenly, adversely affect handling and fuel economy, and are more likely to fail from being overheated.

- ▶ Detach the electric air pump.
- ▶ Reinstall collapsible tire valve cap.
- ▶ **Version 1 only:** Store electrical plug ③ and air hose ④ behind flap ① and place

▷▷

Flat tire

the electric air pump back in its designated storage space.

- ▶ **Version 2 only:** Store electrical plug ③ and the air hose back into the pump housing bottom.
- ▶ Place the electric air pump back in its designated storage space.
- ▶ Lower the vehicle.

Lowering the vehicle

⚠ Warning!

Inflate collapsible tire only after the wheel is properly attached.

Inflate the collapsible tire using the electric air pump before lowering the vehicle.

- ▶ Lower the vehicle by turning crank counterclockwise until the vehicle is resting fully on its own weight.
- ▶ Pull the jack out of the jack support tube.

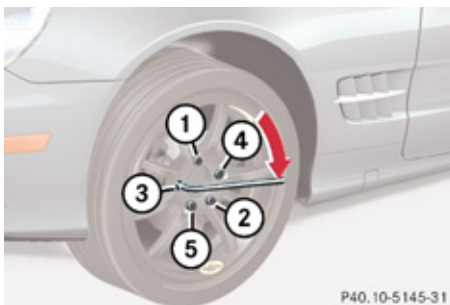

① - ⑤ Wheel bolts

- ▶ Tighten the five wheel bolts evenly, following the diagonal sequence illustrated (① to ⑤), until all bolts are tight. Observe a tightening torque of 96 lb-ft (130 Nm).

⚠ Warning!

Have the tightening torque checked after changing a wheel. The wheels could come loose if they are not tightened to a torque of 96 lb-ft (130 Nm).

⚠ Warning!

When turning the wheel wrench to tighten the wheel bolts, make sure you position your hands on the wrench in such a way that you avoid injury to yourself, such as scraping your hands against the wheel.

Make sure turning the wheel wrench will not scratch or damage the wheel rim.

- ▶ Before storing the jack in the trunk, crank back to storage position and fold in the jack arm.
- ▶ Store the jack and the other vehicle tools in the designated storage space.

For information on storing the spare wheel in the trunk after it has been replaced by a regular road wheel, see (▶ page 253).

i The flat tire may be transported in the trunk when the retractable hardtop is closed. If available use a protective wrap on the spare wheel.

i Vehicles with TPMS or Advanced TPMS: Do not restart the tire inflation pressure monitor until a full size wheel/tire with functioning sensor has been placed back into service on the vehicle.

Replacing jack support tube cover

- ▶ Slide tongue of cover under the upper edge of the tube opening.
- ▶ Applying even pressure, press cover until it snaps into place.

Be careful not to damage the locking tabs or clamp the plastic retaining strap.

MOExtended system

The MOExtended system allows you to continue driving your vehicle even if there is a total loss of pressure in one or more tires.

You may only use the MOExtended system in conjunction with the TPMS (▷ page 218) or the Advanced TPMS (▷ page 220).

The maximum distance in emergency mode depends on the vehicle's load. It is 30 miles (50 km) if the vehicle is partially loaded and 18 miles (30 km) if the vehicle is fully loaded. The point at which the maximum driving distance in emergency mode begins is when the warning message appears in the multifunction display indicating that there is a loss of tire inflation pressure.

- ▶ Do not exceed the maximum speed of 50 mph (80 km/h).

Warning!

In emergency mode, your vehicle's driving characteristics are diminished in such situations as:

- driving around curves
- while braking
- while accelerating rapidly

Therefore, your driving style must be adapted accordingly. Avoid abrupt steering and driving maneuvers, as well as driving over obstacles (road curbs, potholes, or off-road areas). This is especially important if the vehicle is heavily loaded.

The emergency driving distance that can be achieved greatly depends on the demands placed on the vehicle. Depending on speed, load, driving maneuvers, road conditions, outside temperature, etc., the distance can be significantly shorter or, if the vehicle is driven cautiously, somewhat longer.

Do not continue driving in emergency mode if

- you notice knocking sounds
- the vehicle starts to shake
- smoke develops and you smell rubber

- ESP® is intervening continuously
- you notice tears on the tire sidewalls

After driving in emergency mode, you must have the rims inspected by an authorized Mercedes-Benz Center to check if they are suitable for further use. The failed tire must be replaced in any case.

When replacing individual or all tires on the vehicle, make sure only tires marked with "MOExtended" are mounted in the size specified for your vehicle (▷ page 343).

Battery

Battery

Safety notes

These batteries should always be sufficiently charged in order to achieve their rated service life. Refer to Maintenance Booklet for battery maintenance intervals.

If you use your vehicle mostly for short-distance trips, you will need to have the battery charge checked more frequently.

When replacing a battery, always use a battery approved by Mercedes-Benz.

If you do not intend to operate your vehicle for an extended period of time, contact an authorized Mercedes-Benz Center about steps you need to observe.

Warning!

Observe all safety instructions and precautions when handling automotive batteries.



Risk of explosion.



Fire, open flames and smoking are prohibited when handling batteries. Avoid creating sparks.



Battery acid is caustic. Do not allow it to come into contact with skin, eyes or clothing.

Wear suitable protective clothing, especially gloves, apron and face-guard.



Wear eye protection.

Rinse any acid spills immediately with clear water. Contact a physician if necessary.



Keep children away.



Follow the instructions in this Operator's Manual.

Batteries contain materials that can harm the environment if disposed of improperly. Large 12-volt storage batteries contain lead. Recycling of batteries is the preferred method of disposal. Many states require sellers of batteries to accept old batteries for recycling.

Warning!

Failure to follow these instructions can result in severe injury or death.

Never lean over batteries while connecting, you might get injured.

Battery fluid contains sulfuric acid. Do not allow this fluid to come in contact with eyes, skin or clothing. In case it does, immediately flush affected area with water and seek medical help if necessary.

A battery will also produce hydrogen gas, which is flammable and explosive. Keep flames or sparks away from battery, avoid improper connection of jumper cables, smoking etc.

Warning!

Do not place metal objects on the battery as this could result in a short circuit.

Use leak-proof batteries only to avoid the risk of acid burns in the event of an accident.

! The battery is a Valve-Regulated Lead Acid (VRLA) battery, also referred to as “fleece” battery.

Such batteries do not require topping-up of the electrolyte level. VRLA batteries there-

fore do not have cell caps and the battery cover is non-removable. Do not attempt to open the battery as otherwise the battery will be damaged.

Even though VRLA batteries do not require topping-up of the electrolyte level and cannot be opened to check the electrolyte level, the battery condition must be checked periodically by performing a battery conductance test. Refer to Maintenance Booklet for battery condition testing intervals.

The factory-equipped VRLA battery is leak-proofed. Only use a battery as replacement that has the same security features and is of identical size, voltage, and capacity as the factory-equipped battery.

! As with any other battery, have the battery disconnect at a qualified workshop or an authorized Mercedes-Benz Center if you do not intend to operate your vehicle for an extended period of time to prevent battery discharge. You may also connect an accessory battery charge unit expressly approved by Mercedes-Benz for your vehicle model to maintain the battery charge. Contact an authorized Mercedes-Benz Center for further information.

The battery, the battery ventilation hose and the lateral plug must always be securely installed when the vehicle is in operation.

! Never loosen or detach battery terminal clamps while the engine is running or the SmartKey is in the starter switch or KEY-LESS-GO button is in position **1**. Otherwise the alternator and other electronic components could be severely damaged.

Have the battery checked regularly at an authorized Mercedes-Benz Center.

Refer to Maintenance Booklet for maintenance intervals or contact an authorized Mercedes-Benz Center for further information.

i Only replace a discharged battery with a battery recommended by Mercedes-Benz.

i After battery power was interrupted, do the following:

- Synchronize the ESP® (▷ page 257).
- Synchronize the power windows (▷ page 108).

Charging the battery

⚠ Warning!

Never charge a battery while still installed in the vehicle unless the accessory battery charge unit approved by Mercedes-Benz is being used. Gases may escape during charging and cause explosions that may result in paint damage, corrosion or personal injury.

An accessory battery charge unit specially adapted for Mercedes-Benz vehicles and tested and approved by Mercedes-Benz is available, permitting the charging of the battery in its installed position. Contact an authorized Mercedes-Benz Center for information and availability.

Charge battery in accordance with the separate instructions for the accessory battery charger.

Have batteries charged at an authorized Mercedes-Benz Center. If you charge the batteries yourself, follow the operating instructions for your charging device.

Only use a battery charge unit with a maximum charging voltage of 14.8 V.

Jump starting

- ▶ Charge battery in accordance with the instructions of the battery charger manufacturer.

Jump starting

Warning!

Failure to follow these directions will cause damage to the electronic components, and can lead to a battery explosion and severe injury or death.

Never lean over batteries while connecting or jump starting, you might get injured.

Battery fluid contains sulfuric acid. Do not allow this fluid to come in contact with eyes, skin or clothing. In case it does, immediately flush affected area with water, and seek medical help if necessary.

A battery will also produce hydrogen gas, which is flammable and very explosive. Keep flames or sparks away from battery, avoid improper connection of jumper cables, smoking, etc.

Attempting to jump start a frozen battery can result in it exploding, causing personal injury.

Read all instructions before proceeding.

-  Do not tow-start the vehicle.

-  Jump starting should only be performed on the starter battery installed in the engine compartment.

Avoid repeated and lengthy starting attempts.

Do not attempt to start the engine using a battery quick-charge unit.

If the engine does not run after several unsuccessful starting attempts, have it checked at the nearest authorized Mercedes-Benz Center.

Excessive unburned fuel generated by repeated failed starting attempts may damage the catalytic converter and may present a fire risk.

Make sure the jumper cables do not have loose or missing insulation.

Make sure the cable clamps do not touch any other metal part while the other end is still attached to a battery.

Jump starting

If the starter battery is discharged, the engine can be started with jumper cables and the battery of another vehicle. Observe the following:

- Jump starting should only be performed when the engine and catalytic converter are cold.
- Do not start the engine if the battery is frozen. Let the battery thaw out first.
- Only jump start from batteries with the same voltage rating (12 V). Jump starting with a more powerful battery could damage the vehicle's electrical system, which will not be covered by the Mercedes-Benz Limited Warranty.
- Only use jumper cables with sufficient cross-section and insulated terminal clamps.
- Always make sure the jumper cables are not on or near pulleys, fans or other parts that move when an engine is started or running.

Warning!

Keep flames or sparks away from battery. Do not smoke.

Observe all safety instructions and precautions when handling automotive batteries.

- ▶ Make sure the two vehicles do not touch.
- ▶ Switch off all electrical consumers.
- ▶ Engage the parking brake.
- ▶ Make sure the automatic transmission is in park position **P**.
- ▶ Open the hood.
- ▶ Remove cover from battery positive terminal.

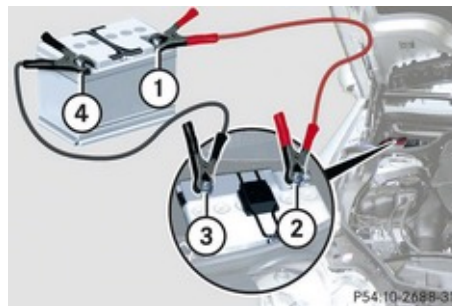

- ① Positive terminal of charged battery
- ② Positive terminal of discharged battery
- ③ Negative terminal of discharged battery
- ④ Negative terminal of charged battery

! Never invert the terminal connections!

- ▶ Connect positive terminals ① and ② of the batteries with a jumper cable. Clamp

the cable to positive terminal ① of the charged battery first.

- ▶ Start engine of the vehicle with the charged battery and run at idle speed.
- ▶ Connect negative terminals ③ and ④ of the batteries with a jumper cable. Clamp the cable to negative terminal ④ of the charged battery first.
- ▶ Start engine of the vehicle with the discharged battery and run at idle speed. You can now turn on the electrical consumers. Do not switch on the headlamps under any circumstances.
- ▶ Remove the jumper cables first from negative terminals ① and ② and then from positive terminals ③ and ④. You can now switch on the headlamps.
- ▶ Have the battery checked at the nearest authorized Mercedes-Benz Center.

Towing the vehicle

Towing the vehicle

Safety notes

Mercedes-Benz recommends that the vehicle be transported with all wheels off the ground using flatbed or appropriate wheel lift/dolly equipment. This method is preferable to other types of towing.

! To prevent damage during transport, do not tie down vehicle by its chassis or suspension parts.

Warning!

The electro-hydraulic brake system requires electrical power to operate.

A malfunction in the vehicle's power supply or electrical system may impair brake system operation and switch it into its emergency operation mode. In such a case, the red brake warning lamp comes on and warning messages appear in the multifunction display while driving. To brake, the driver must then apply significantly greater brake pedal pressure and depress the pedal much further to obtain the expected braking effect. If necessary, apply full pressure to the brake pedal. Brakes are only applied to the front wheels. Stopping distance is

increased! For more information, see "Electro-hydraulic brake system" in this in this Operator's Manual.

If there is a malfunction in the electro-hydraulic brake system, we recommend that the vehicle be transported with all wheels off the ground using flatbed or appropriate wheel lift/dolly equipment.

If circumstances do not permit the recommended towing methods, the vehicle may be towed with all wheels on the ground or front axle raised only so far as necessary to have the vehicle moved to a safe location where the recommended towing methods can be employed.

▶ Switch off the tow-away alarm before towing the vehicle with all wheels off the ground or front axle raised (▷ page 72).

! Before towing the vehicle observe the following instructions:

- Do not tow-start the vehicle. You could otherwise seriously damage the automatic transmission which is not covered by the Mercedes-Benz Limited Warranty.
- Do not tow with sling-type equipment. Towing with sling-type equipment over

bumpy roads will damage radiator and supports.

- Towing of the vehicle should only be done using the properly installed towing eye bolt. Never attach a tow cable, tow rope or tow rod to the vehicle chassis, frame or suspension parts.

i If the battery is disconnected or discharged

- the SmartKey will not turn in the starter switch
- the automatic transmission will remain in park position **P**
- For more information see "Battery" (▷ page 326) or "Jump starting" (▷ page 328).

Towing the vehicle

Installing towing eye bolt

Depending on whether you are towing a vehicle or you are being towed, the towing eye bolt can be screwed into threaded holes which are located behind covers on each bumper.

The towing eye bolt is supplied with the vehicle tool kit, located in the compartment underneath the trunk floor (▷ page 252).

▶ Take the vehicle tool kit out of the trunk.

Removing cover in front bumper

- ▶ Press mark on cover ① as indicated by the arrow.
- ▶ Lift cover ① off to reveal the threaded hole for the towing eye bolt.

USA only

① Cover

- ▶ Press mark on cover ① as indicated by the arrow.
- ▶ Lift cover ① off to reveal the threaded hole for the towing eye bolt.

Canada only

① Cover

- ▶ Press mark on cover ① as indicated by the arrow and pull on lower edge simultaneously.
- ▶ Lift cover ① off to reveal the threaded hole for the towing eye bolt.

Removing cover in rear bumper**⚠ Warning!**

In order to avoid possible serious burns or injury, use extreme caution when removing the rear cover, because the rear exhaust pipe is extremely hot.

Towing the vehicle

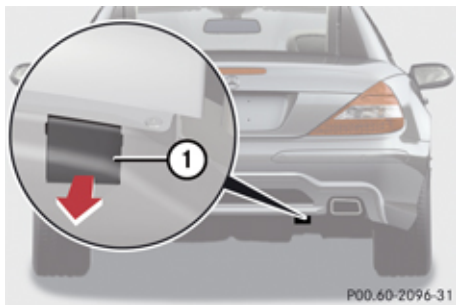

Example illustration USA, bumper in Canada differs slightly

① Cover

- ▶ Insert flat, blunt object as a lever into upper left or right recess of cover ①.
- ▶ Loosen cover ① using the lever.
- ▶ Fold cover ① down in direction of arrow to reveal the threaded hole for the towing eye bolt.

Fixing towing eye bolt



Example illustration front bumper

① Towing eye bolt

- ▶ Take the towing eye bolt ① and the wheel wrench from the vehicle tool kit.
- ▶ Screw towing eye bolt ① clockwise into threaded hole to its stop.
- ▶ Insert wheel wrench into towing eye and tighten towing eye bolt ① by turning it clockwise.

Removing towing eye bolt

- ▶ Loosen towing eye bolt ① counterclockwise with wheel wrench.
- ▶ Unscrew towing eye bolt ①.

- ▶ **Reinstalling front cover:** Fit locking tabs of cover ① (▷ page 331) under the lower edge of the opening in the bumper.
- ▶ Apply even pressure on the upper part of the cover until it snaps into place.
- ▶ **Reinstalling rear cover:** Fit cover ① (▷ page 331) and snap it into place.
- ▶ Store the towing eye bolt and wheel wrench back into the vehicle tool kit.

Towing with front axle raised

- When towing the vehicle with the front axle raised, the wheels on the ground have to move freely.
- ▶ Make sure the ignition is switched on.
 - ▶ With the vehicle at a standstill, depress the brake pedal and keep it pressed.
 - ▶ Shift the automatic transmission into neutral position **N**.
 - ▶ Release the brake pedal.
 - ▶ If engaged, release the parking brake.
 - ▶ Switch off the automatic central locking (▷ page 140).

Towing the vehicle

- ▶ Switch off the ignition and leave the SmartKey in the starter switch.
- ▶ Switch on the hazard warning flasher (> page 102).

! Make sure that the ignition is switched off. If the starter switch is in position **2**, active braking action through the ESP® may otherwise seriously damage the brake system.

! The vehicle may be towed only for distances up to 30 miles (50 km) and at a speed not to exceed 30 mph (50 km/h).

Towing with all wheels on the ground

⚠ Warning!

If circumstances require towing the vehicle with all wheels on the ground, always tow with a tow bar if:

- the engine will not run
- there is a malfunction in the electro-hydraulic brake system
- there is a malfunction in the power supply or in the vehicle's electrical system

This is necessary to adequately control the towed vehicle.

Prior to towing the vehicle with all wheels on the ground, make sure the SmartKey is in starter switch position **2**.

⚠ Warning!

With the engine not running, there is no power assistance for the brake and steering systems. In this case, it is important to keep in mind that a considerably higher degree of effort is necessary to brake and steer the vehicle. Adapt your driving accordingly.

- ▶ Make sure the ignition is switched on.
- ▶ With the vehicle at a standstill, depress the brake pedal and keep it pressed.
- ▶ Shift the automatic transmission into neutral position **N**.
- ▶ Release the brake pedal.
- ▶ If engaged, release the parking brake.
- ▶ Switch on the hazard warning flasher (> page 102).

! The vehicle may be towed only for distances up to 30 miles (50 km) and at a speed not to exceed 30 mph (50 km/h).

i To signal turns while being towed with the hazard warning flasher in use you can activate the combination switch for the left or right turn signal in the usual manner – only the selected turn signal will operate. Upon canceling the turn signal, the hazard warning flasher will operate again.

Fuses

Fuses

Introduction

The electrical fuses in your vehicle serve to switch off malfunctioning power circuits.

If a fuse is blown, the components and systems secured by that fuse will stop operating.

Warning!

Only use fuses approved by Mercedes-Benz with the specified amperage for the system in question and do not attempt to repair or bridge a blown fuse. Using other than approved fuses or using repaired or bridged fuses may cause an overload leading to a fire, and/or cause damage to electrical components and/or systems. Have the cause determined and remedied by an authorized Mercedes-Benz Center.

A blown fuse must be replaced by an appropriate spare fuse (recognizable by its color or the fuse rating given on the fuse) of the amperage recommended in the fuse chart. Any Mercedes-Benz Center will be glad to advise you on this subject.

 In case of a blown fuse contact Roadside Assistance or an authorized Mercedes-Benz Center.

If a newly inserted fuse blows again, have the cause determined and rectified by an authorized Mercedes-Benz Center.

A fuse chart is located in the trunk with the vehicle tool kit (▷ page 252). The fuse chart explains the fuse allocation and fuse amperages.

The electrical fuses are located in fuse boxes on the driver's side of the engine compartment, on the passenger side of the engine compartment, under passenger-side rear storage compartment or in the trunk.

Before replacing fuses

- ▶ Engage the parking brake.
- ▶ Make sure the automatic transmission is in park position **P**.
- ▶ Switch off all electrical consumers.
- ▶ Turn off the engine.
- ▶ Remove the SmartKey from the starter switch.
- ▶ Vehicles with KEYLESS-GO: Open the driver's door (this puts the starter switch in position **0**, same as with the SmartKey removed from the starter switch). The driver's door then can be closed again.

Fuse box in passenger compartment

The fuse box is located under the rear passenger-side storage compartment.

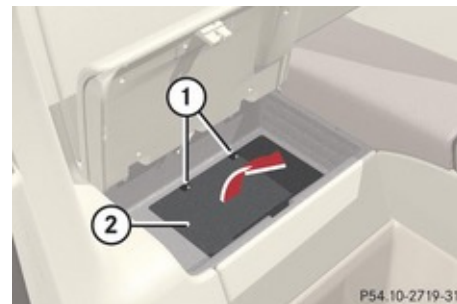

① Clips

② Storage compartment floor

- ▶ **Opening:** Open the passenger door.
- ▶ Open the rear passenger-side storage compartment (▷ page 182).
- ▶ Lift both clips ①.
- ▶ Remove storage compartment floor ② in direction of arrow.
- ▶ **Closing:** To reinstall storage compartment floor ② after checking or replacing fuses, follow the procedure in reverse order.

❗ The fuse box cover must be properly positioned as described to prevent moisture or dirt from entering the fuse box and possibly impairing fuse operation.

Fuse box in trunk

The fuse in the trunk is located on the right-hand side of the trunk.

► Lift up the trunk floor cover.



Fuse box in engine compartment

The fuse boxes are located on the driver's and passenger side in front of the bulkhead (wall separating the engine and passenger compartment).

► **Opening:** Open the hood.

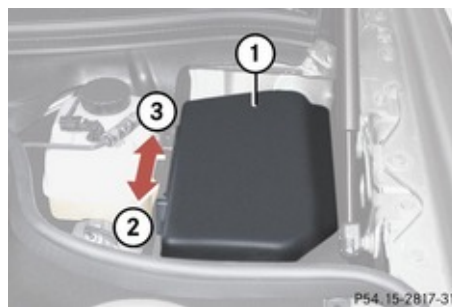

Fuse box on driver's side

- ① Fuse box cover
- ② Locking
- ③ Unlocking

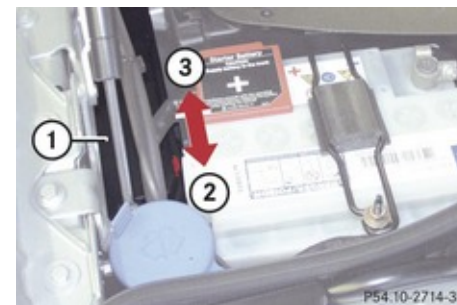

Fuse box on passenger side

- ① Fuse box cover
- ② Locking
- ③ Unlocking

- With a dry cloth, remove any moisture from the fuse box ①.
- Move slide to position ③ and lift fuse box cover ①.
- **Closing:** Make sure the sealing rubber is properly positioned.
- Hook fuse box cover ① onto tabs and close it.
- Move slide to position ②.

❗ The fuse box cover must be properly positioned with the slide at the  symbol to



Fuses

prevent moisture and/or dirt from entering the fuse box and possibly impairing fuse operation.

- ▶ Close the hood after checking or replacing fuses.

Emergency engine shut-down

If the engine cannot be turned off as described (▷ page 114), you may use the following emergency procedure.

- ▶ Take the fuse chart from the vehicle tool kit (▷ page 252).
- ▶ Find row “Engine emergency stop” in the fuse chart table to identify the fuses that have to be removed as well as their locations.
- ▶ Remove the respective fuses.

Vehicle equipment 338
Parts service 338
Warranty coverage 338
Identification labels 339
Engine 340
Rims and tires 343
Electrical system 348
Main dimensions 349
Weights 350
Fuels, coolants, lubricants etc. 350



Warranty coverage

Vehicle equipment

i This Operator's Manual describes all features, standard or optional, potentially available for your vehicle at the time of purchase. Please be aware that your vehicle might not be equipped with all features described in this manual.

Parts service

All authorized Mercedes-Benz Centers maintain a stock of Genuine Mercedes-Benz Parts required for maintenance and repair work. In addition, strategically located parts distribution centers provide quick and reliable parts service.

More than 300 000 different parts for Mercedes-Benz models are available.

Genuine Mercedes-Benz Parts are subjected to stringent quality inspections. Each part has been specifically developed, manufactured or selected for and adapted to Mercedes-Benz vehicles.

Therefore, Genuine Mercedes-Benz Parts should be installed.

! Do not use non-genuine Mercedes-Benz parts and accessories not authorized by Mercedes-Benz. Doing so could damage the vehicle, which is not covered by the Mercedes-Benz Limited Warranty. Also, it could compromise the vehicle's durability or safety.

Warranty coverage

Your vehicle is covered under the terms of the warranties printed in the Service and Warranty Information booklet.

Your authorized Mercedes-Benz Center will exchange or repair any defective parts originally installed in the vehicle in accordance with the terms of the following warranties:

- New Car Limited Warranty
- Emission System Warranty
- Emission Performance Warranty
- California, Connecticut, Maine, Massachusetts, New York, Pennsylvania, Rhode Island, and Vermont Emission Control Systems Warranty
- State Warranty Enforcement Laws (Lemon Laws)

Replacement parts and accessories are covered by the Mercedes-Benz Parts and Accessories warranties, copies of which are available at any authorized Mercedes-Benz Center.

Identification labels

Loss of Service and Warranty Information booklet

Should you lose your Service and Warranty Information booklet, have an authorized Mercedes-Benz Center arrange for a replacement. It will be mailed to you.

Identification labels

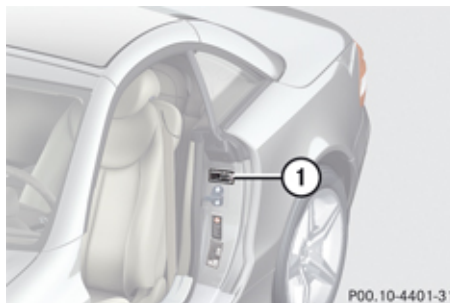

- ① Certification label (on driver's door B-pillar)

The VehicIde Identification Number (VIN) can be found in the following locations:

- on the certification label
- embossed underneath a trim below the passenger-side rear storage compartment lid (▷ page 340)
- on the lower edge of the windshield (▷ page 340)

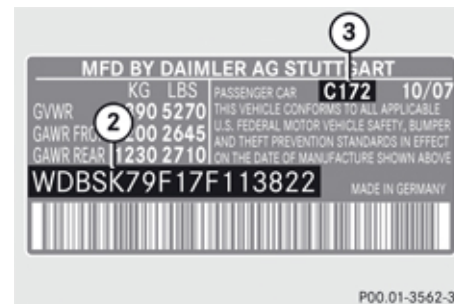

Example certification label (U.S. vehicles)

- ② VIN
- ③ Paintwork code

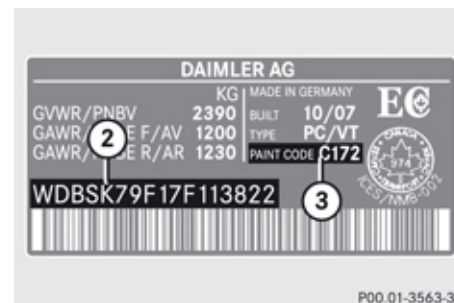

Example certification label (Canada vehicles)

- ② VIN
- ③ Paintwork code

Engine

i Data shown on certification label are for illustration purposes only. These data are specific to each vehicle and may vary from data shown in the illustration. Refer to certification label on vehicle for actual data specific to your vehicle.

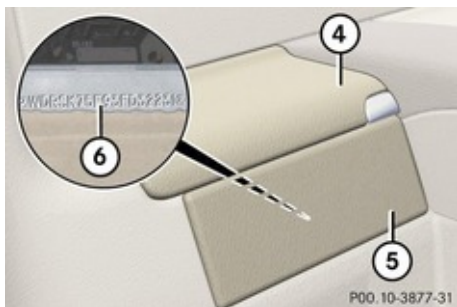

Passenger-side rear storage compartment

- ④ Compartment lid
- ⑤ Compartment trim
- ⑥ VIN

- ▶ Open compartment lid ④.
- ▶ Remove compartment trim ⑤.
VIN ⑥ is now visible.

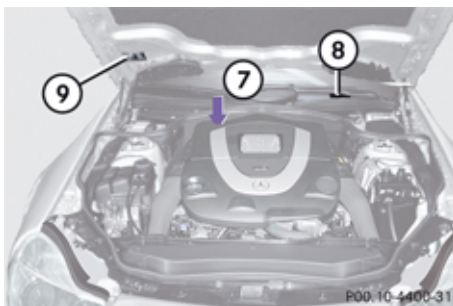

- ⑦ Engine number (engraved on engine)
- ⑧ VIN (on lower edge of windshield)
- ⑨ Emission control information label, includes both federal and California certification exhaust emission standards

i When ordering parts, please specify vehicle identification and engine number.

Engine

Model	SL 550 (230.471) ¹⁴	SL 600 (230.477) ¹⁴
Engine type	273	275
Mode of operation	4-stroke engine, gasoline injection	4-stroke engine, gasoline injection
No. of cylinders	8	12
Bore	3.86 in (98.00 mm)	3.23 in (82.00 mm)
Stroke	3.56 in (90.50 mm)	3.43 in (87.00 mm)
Total piston displacement	333.2 cu in (5 461 cm ³)	336.4 cu in (5 513 cm ³)
Compression ratio	10.7:1	9:1
Output acc. to SAE J 1349	382 hp / 6 000 rpm (285 kW / 6 000 rpm) ¹⁵	510 hp / 5 000 rpm (380 kW / 5 000 rpm) ¹⁵
Maximum torque acc. to SAE J 1349	391 lb-ft / 2 800 rpm - 4 800 rpm (530 Nm / 2 800 rpm - 4 800 rpm)	612 lb-ft / 1 900 rpm - 3 500 rpm (830 Nm / 1 900 rpm - 3 500 rpm)
Maximum engine speed	6 500 rpm	5 950 rpm
Firing order	1-5-4-2-6-3-7-8	1-12-5-8-3-10-6-7-2-11-4-9
Poly-V-belt	2 398 mm	2 335 mm

¹⁴ The quoted data apply only to the standard vehicle. Contact an authorized Mercedes-Benz Center for the corresponding data of all special bodies and special equipment.

¹⁵ Premium fuel required. Performance may vary with fuel octane rating.

Engine

Model	SL 63 AMG (230.470) ¹⁶	SL 65 AMG (230.479) ¹⁶
Engine type	156	275
Mode of operation	4-stroke engine, gasoline injection	4-stroke engine, gasoline injection
No. of cylinders	8	12
Bore	4.02 in (102.20 mm)	3.25 in (82.60 mm)
Stroke	3.72 in (94.60 mm)	3.66 in (93.00 mm)
Total piston displacement	378.8 cu in (6 208 cm ³)	364.9 cu in (5 980 cm ³)
Compression ratio	11.3:1	9:1
Output acc. to SAE J 1349	518 hp / 6 800 rpm (386 kW / 6 800 rpm) ¹⁷	603 hp / 4 800 rpm - 5 100 rpm (450 kW / 4 800 rpm - 5 100 rpm) ¹⁷
Maximum torque acc. to SAE J 1349	465 lb-ft / 5 200 rpm (630 Nm / 5 200 rpm)	738 lb-ft / 2 000 rpm - 4 000 rpm (1 000 Nm / 2 000 rpm - 4 000 rpm)
Maximum engine speed	7 000 rpm	5 950 rpm
Firing order	1-5-4-2-6-3-7-8	1-12-5-8-3-10-6-7-2-11-4-9
Poly-V-belt	2 360 mm	2 335 mm

¹⁶ The quoted data apply only to the standard vehicle. Contact an authorized Mercedes-Benz Center for the corresponding data of all special bodies and special equipment.

¹⁷ Premium fuel required. Performance may vary with fuel octane rating.

Rims and tires

Notes

! Only use tires which have been tested and approved by Mercedes-Benz. Tires approved by Mercedes-Benz are developed to provide best possible performance in conjunction with the driving safety systems on your vehicle such as the ABS or the ESP®. Tires specially developed for your vehicle and tested and approved by Mercedes-Benz can be identified by finding the following on the tire's sidewall:

- MO = Mercedes-Benz Original equipment tires
- MO1 = Mercedes-Benz Original equipment tires (applicable to selected tire sizes only)
- MOE = Mercedes-Benz Original Extended (tires with limited run-flat characteristics) original equipment tires

Using tires other than those approved by Mercedes-Benz may result in damage that is not covered by the Mercedes-Benz Limited Warranty.

For information on driving with MOExtended tires, see the "Practical hints" section (▷ page 325).

! Using tires other than those approved by Mercedes-Benz can have detrimental effects, such as

- poor handling characteristics
- increased noise
- increased fuel consumption

Moreover, tires and rims not approved by Mercedes-Benz may, under load, exhibit dimensional variations and different tire deformation characteristics that could cause them to come into contact with the vehicle body or axle parts. Damage to the tires or the vehicle may be the result.

i Further information on tires and rims is available at any authorized Mercedes-Benz Center. A placard with the recommended tire inflation pressures is located on the driver's door B-pillar. Some vehicles may have supplemental tire inflation pressure information for driving at high speeds or for vehicle loads less than the maximum loaded vehicle condition. If such information is provided, it can be found on the placard located on the inside of the fuel filler flap. The tire inflation pressure should be checked regularly and should only be adjusted on cold tires. Follow tire manu-

facturer's maintenance recommendation included with the vehicle.





For information on recommended tire inflation pressure and supplemental tire inflation pressure information for special driving situations, see (▷ page 215).

i The following pages also list the approved wheel rim and tire sizes for equipping your vehicles with winter tires. Winter tires are not available as standard or optional factory equipment, but can be purchased from an authorized Mercedes-Benz Center.

Depending on vehicle model and the standard or optional factory-equipped wheel rim/tire configuration on your vehicle (Appearance Package, Sport Package etc.), equipping your vehicle with winter tires approved for your vehicle model may also require the purchase of two or four wheel rims of the recommended size for use with these winter tires. For more information contact an authorized Mercedes-Benz Center.

Rims and tires

Same size tires

Model	SL 550 SL 550 (Sport Package) SL 600 SL 600 (Sport Package)	SL 63 AMG	SL 63 AMG SL 63 AMG (Performance Package) SL 65 AMG
Rims (light alloy)	8.5 J x 18 H2	8.5 J x 18 H2	8.5 J x 19 H2
Wheel offset	1.38 in (35 mm)	1.18 in (30 mm)	1.18 in (30 mm)
Winter tires ^{18,19}	255/40 R18 95V M+S  or 255/40 R18 95V M+S  MOExtended ²⁰	255/40 R18 95V XL (Extra Load) M+S 	255/35 R19 96V XL (Extra Load) M+S 

¹⁸ Radial-ply tires

¹⁹ Not available as factory equipment.

²⁰ Must be used in conjunction with Tire Pressure Monitoring System (U.S. vehicles) or Advanced Tire Pressure Monitoring System (Canada vehicles) only.

Mixed size tires

Front axle

Model	SL 550	SL 600	SL 550 (Sport Package) SL 600 (Sport Package) SL 63 AMG SL 63 AMG (Performance Package) SL 65 AMG
Rims (light alloy)	8.5 J x 18 H2	8.5 J x 18 H2	8.5 J x 19 H2
Wheel offset	1.38 in (35 mm)	1.38 in (35 mm)	1.18 in (30 mm)
Summer tires ²¹	255/40 R18 95W or 255/40 R18 95Y MOEx- tended ²²	255/40 R18 95Y or 255/40 R18 95Y MOEx- tended ²²	255/35 ZR19 96Y XL (Extra Load) MO1

²¹ Radial-ply tires

²² Must be used in conjunction with Tire Pressure Monitoring System (U.S. vehicles) or Advanced Tire Pressure Monitoring System (Canada vehicles) only.

Rims and tires

Rear axle

Model	SL 550	SL 600	SL 550 (Sport Package) SL 600 (Sport Package) SL 63 AMG SL 63 AMG (Performance Package) SL 65 AMG
Rims (light alloy)	9.5 J x 18 H2	9.5 J x 18 H2	9.5 J x 19 H2
Wheel offset	1.57 in (40 mm)	1.57 in (40 mm)	1.22 in (31 mm)
Summer tires ^{23,24}	285/35 R18 97W or 285/35 R18 97Y MOEx- tended ²⁵	285/35 R18 97Y or 285/35 R18 97Y MOEx- tended ²⁵	285/30 ZR19 98Y XL (Extra Load) MO1

²³ Radial-ply tires

²⁴ Must not be used with snow chains.

²⁵ Must be used in conjunction with Tire Pressure Monitoring System (U.S. vehicles) or Advanced Tire Pressure Monitoring System (Canada vehicles) only.

Spare wheel

! Compare the recommended tire inflation pressure for your vehicle with the tire inflation pressure on the yellow label located on the spare wheel rim.

If the tire inflation pressure on the yellow label on the spare wheel rim differs from the values given in this Operator’s Manual, inflate the tire to the recommended tire inflation pressure given on the yellow label on the spare wheel rim.

i Please note that the tire inflation pressure of the spare wheel differs from the tire inflation pressure of the road tires.

Model	SL 550 SL 550 (Sport Package)	SL 600 SL 600 (Sport Package) SL 63 AMG	SL 63 AMG (Performance Package) SL 65 AMG
Rim	6 B x 17 H2	6 B x 18 H2	6.5 B x 19 H2
Wheel offset	0.98 in (25 mm)	0.98 in (25 mm)	0.55 in (14 mm)
Collapsible tire ²⁶	185/60-17 93P	175/55-18 95P	175/50-19 97P
Recommended tire inflation pressure	41 psi (2.8 bar)	51 psi (3.5 bar)	51 psi (3.5 bar)

²⁶ Must not be used with snow chains.

Electrical system

Electrical system

Model		SL 550	SL 600	SL 63 AMG	SL 65 AMG
Alternator		14 V / 180 A	14 V / 180 A	14 V / 180 A	14 V / 180 A
Starter motor		12 V / 1.7 kW	12 V / 2.0 kW	12 V / 2.1 kW	12 V / 1.7 kW
Starter battery		12 V / 35 Ah	12 V / 35 Ah	12 V / 35 Ah	12 V / 35 Ah
Battery for electrical consumers		12 V / 70 Ah	12 V / 70 Ah	12 V / 70 Ah	12 V / 70 Ah
Spark plugs	Type	NGK PLKR 7A	NGK IFR 6Q-G	NGK ILZKAR 7A10	NGK IFR 6Q-G
	Electrode gap	0.031 in (0.8 mm)	0.028 in (0.7 mm)	0.039 in (1.0 mm)	0.028 in (0.7 mm)
	Tightening torque	15 lb-ft - 18 lb-ft (20 Nm - 25 Nm)	18 lb-ft - 22 lb-ft (25 Nm - 30 Nm)	15 lb-ft - 18 lb-ft (20 Nm - 25 Nm)	18 lb-ft - 22 lb-ft (25 Nm - 30 Nm)

Main dimensions

Model	SL 550	SL 63 AMG
	SL 600	SL 65 AMG
Overall vehicle length	179.8 in (4 566 mm)	181.0 in (4 598 mm)
Overall vehicle length when opening/closing hardtop	185.6 in (4 713 mm)	187.9 in (4 772 mm)
Overall vehicle width, exterior rear view mirrors folded out	81.5 in (2 069 mm)	81.5 in (2 069 mm)
Overall vehicle height	51.0 in (1 295 mm)	51.1 in (1 298 mm)
Overall vehicle height when opening/closing hardtop	65.9 in (1 674 mm)	66.1 in (1 680 mm)
Wheelbase	100.8 in (2 560 mm)	100.8 in (2 560 mm)
Track, front	61.4 in (1 559 mm)	61.8 in (1 569 mm)
Track, rear	60.5 in (1 537 mm)	61.2 in (1 555 mm)
Turning circle	36.2 ft (11.04 m)	36.3 ft (11.05 m)

Fuels, coolants, lubricants etc.

Weights

Trunk load

max. 220 lb (100 kg)

Fuels, coolants, lubricants etc.

Capacities

Vehicle components and their respective lubricants must match. Therefore only use products tested and approved by Mercedes-Benz.

For information on tested and approved products, contact an authorized Mercedes-Benz Center or visit www.mbusa.com (USA only).

Warning!

Comply with all valid regulations with respect to handling, storing, and disposing of service fluids. Otherwise you could endanger persons or the environment.

Keep service fluids out of the reach of children.

For health reasons, you should prevent service fluids from coming into direct contact with your skin or clothing.

If a service fluid is swallowed, contact a physician immediately.

	Model	Capacity	Fuels, coolants, lubricants, etc.
Engine with oil filter	SL 550	9.0 US qt (8.5 l)	Approved engine oils
	SL 600	8.5 US qt (8.0 l)	
	SL 63 AMG		
	SL 65 AMG		
Automatic transmission	SL 550	9.5 US qt (9.0 l)	MB Automatic Transmission Fluid
	SL 63 AMG	9.3 US qt (8.8 l)	
	SL 600	8.0 US qt (7.5 l)	
	SL 65 AMG		

Fuels, coolants, lubricants etc.

	Model	Capacity	Fuels, coolants, lubricants, etc.
Rear axle	SL 550 SL 600	1.3 US qt (1.2 l)	MB Hypoid Gear Oil (SAE 85W-90)
	SL 63 AMG		Fuchs Titan EG 5010 D
	SL 63 AMG ²⁷ SL 65 AMG		Castrol SAF-XJ (SAE 75W-140)
Hydraulic system for active body control (ABC)	All models	4.0 US qt (3.8 l)	MB ABC Fluid
Power steering	All models	1.1 US qt (1.0 l)	MB Power Steering Fluid (Chevron Texaco PSF 9109)
Brake system	All models	1.1 US qt (1.05 l)	MB Brake Fluid (DOT 4+)
Cooling system	SL 550	approx. 12.3 US qt (11.6 l)	MB 325.0 Anticorrosion/Antifreeze
	SL 600	approx. 13.6 US qt (12.9 l)	
	SL 63 AMG	approx. 11.9 US qt (11.3 l)	
	SL 65 AMG	approx. 14.8 US qt (14.0 l)	
Low temperature cooling system	SL 600	approx. 2.2 US qt (2.1 l)	MB 325.0 Anticorrosion/Antifreeze
	SL 65 AMG	approx. 3.4 US qt (3.2 l)	

²⁷ SL 63 AMG with Performance Package.

Fuels, coolants, lubricants etc.

	Model	Capacity	Fuels, coolants, lubricants, etc.
Fuel tank	All models	21.1 US gal (80.0 l)	Premium unleaded gasoline (Minimum Posted Octane 91 [Avg. of 96 RON/86 MON])
Fuel tank reserve	SL 550 SL 600	2.6 US gal (10.0 l)	
	SL 63 AMG SL 65 AMG	3.7 US gal (14.0 l)	
Air conditioning system	All models	—	R-134a refrigerant and special PAG lubricant oil (never R-12)
Hydraulic system for retractable hardtop	All models	0.42 US qt (0.4 l)	MB Hydraulic Oil
Washer system and headlamp cleaning system	All models	7.4 US qt (7.0 l)	MB Windshield Washer Concentrate ²⁸ Washer fluid mixing ratio (> page 357)

²⁸ Use MB Windshield Washer Concentrate “MB SummerFit” and water for temperatures above freezing point or MB Windshield Washer Concentrate “MB SummerFit” and commercially available premixed washer solvent/antifreeze for temperatures below freezing point.

Approved engine oils

Engine oils are specifically tested for their suitability in our engines and durability for our service intervals. Therefore, only use approved engine oils and oil filters required for vehicles with Maintenance System.

Conventional petroleum-based oils must not be used for vehicles with Maintenance System.

For a listing of approved engine oils and oil filters, contact an authorized Mercedes-Benz Center or visit www.mbusa.com (USA only).

! Using engine oils and oil filters of specification other than those expressly required for the Maintenance System, or changing of oil and oil filter at change intervals longer than those called for by the Maintenance System will result in engine or emission control system damage not covered by the Mercedes-Benz Limited Warranty.

Please follow Maintenance System recommendations for scheduled oil changes. Failure to do so will result in engine or emission control system damage not covered by the Mercedes-Benz Limited Warranty.

Mercedes-Benz recommends MOBIL OIL.

²⁹ Restriction: Only SAE XW-40 engine oils may be used.

Use the table below to determine the MB sheet number.

Model	Engine type	MB sheet number
SL 550	273	229.5
SL 600	275	229.5
SL 63 AMG	156	229.5 ²⁹
SL 65 AMG	275	229.5

i MB sheet numbers are printed on the outside of oil containers.

Viscosity grades for engine oils

Using the chart below, select oil viscosity according to the lowest air temperature expected before the next oil change.

Fuels, coolants, lubricants etc.

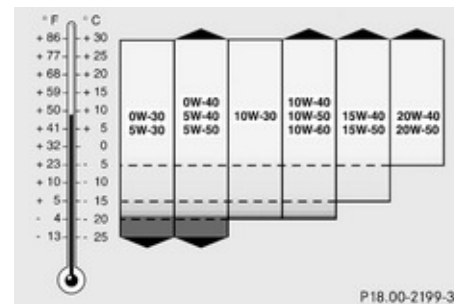

Engine oil additives

! Do not blend oil additives with engine oil. They may damage the engine. Damage or malfunctions resulting from blending oil additives are not covered by the Mercedes-Benz Limited Warranty.

Fuels, coolants, lubricants etc.

Air conditioning refrigerant

R-134a (HFC) refrigerant and special PAG lubricating oil are used in the air conditioning system.

! Never use R-12 (CFC) or mineral-based lubricating oil. Otherwise damage to the system will occur.

Brake fluid

⚠ Warning!

During vehicle operation, the boiling point of the brake fluid is continuously reduced through the absorption of moisture from the atmosphere.

Under extremely strenuous operating conditions, this moisture content can lead to the formation of bubbles in the system, thus reducing the system's efficiency.

Therefore, the brake fluid must be replaced regularly. Refer to your vehicle's Maintenance Booklet for replacement interval.

Only brake fluid approved by Mercedes-Benz is recommended. Any authorized Mercedes-Benz Center will provide you with additional information.

Premium unleaded gasoline

⚠ Warning!

Gasoline is highly flammable and poisonous. It burns violently and can cause serious personal injury.

Never allow sparks, flames or smoking materials near gasoline!

Turn off the engine before refueling.

Whenever you are around gasoline, avoid inhaling fumes and any skin or clothing contact. Extinguish all smoking materials.

Direct skin contact with fuels and the inhalation of fuel vapors are damaging your health.

! To maintain the engine's durability and performance, premium unleaded gasoline must be used.

If premium unleaded gasoline is not available and low octane gasoline is used, follow these precautions:

- Have the fuel tank only partially filled with unleaded regular gasoline and fill up with premium unleaded gasoline as soon as possible.
- Avoid full throttle driving and abrupt acceleration.

- Do not exceed an engine speed of 3 000 rpm if the vehicle is loaded with a light load such as two persons and no luggage.
- Do not exceed $\frac{2}{3}$ of maximum accelerator pedal position if the vehicle is fully loaded or operating in mountainous terrain.

Fuel requirements

Only use premium unleaded gasoline. The octane number (posted at the pump) must be 91 min. It is an average of both the Research Octane Number (RON) and the Motor Octane Number (MON): $(RON+MON)/2$. This is also known as the ANTI-KNOCK INDEX.

Reformulated gasolines (RFG) and/or unleaded gasoline containing oxygenates such as ethanol, TAME, ETBE, IPA, IBA, and TBA can be used provided the ratio of any one of these oxygenates to gasoline does not exceed 10%; MTBE must not exceed 15%.

The ratio of methanol to gasoline must not exceed 3% plus additional cosolvents.

Using mixtures of ethanol and methanol is not allowed. Gasohol, which contains 10% ethanol and 90% unleaded gasoline, can be used.

These blends must also meet all other fuel requirements, such as resistance to spark knock, boiling range, vapor pressure, etc.

Gasoline additives

A major concern among engine manufacturers is carbon build-up caused by gasoline. Mercedes-Benz recommends only the use of quality gasoline containing additives that prevent the build-up of carbon deposits.

After an extended period of using fuels without such additives carbon deposits can build up, especially on the intake valves and in the combustion area, leading to engine performance problems such as:

- Warm-up hesitation
- Unstable idle
- Knocking/pinging
- Misfire
- Power loss

In areas where carbon deposits may be encountered due to lack of availability of gasoline which contains these additives, Mercedes-Benz recommends the use of additives approved by us for use on Mercedes-Benz vehicles.

Contact an authorized Mercedes-Benz Center or visit www.mbusa.com (USA only) for a listing of approved product(s). Follow directions on product label.

Do not blend other fuel additives with fuel. This only results in unnecessary cost and may be harmful to the engine operation.

! Damage or malfunction resulting from poor fuel quality or from blending additional fuel additives other than those tested and approved by us for use on Mercedes-Benz vehicles are not covered by the Mercedes-Benz Limited Warranty or by any pre-owned or Extended Limited warranties.

Coolants

The engine coolant is a mixture of water and anticorrosion/antifreeze, which provides:

- Corrosion protection
- Freeze protection
- Boiling protection (by increasing the boiling point)

The cooling system was filled at the factory with a coolant providing freeze protection to approximately -35°F (-37°C) and corrosion protection.

Fuels, coolants, lubricants etc.

! Add premixed coolant solution only. Adding water and MB 325.0 Anticorrosion/Antifreeze separately from each other, could cause engine damage not covered by the Mercedes-Benz Limited Warranty.

If the antifreeze mixture is effective to -35°F (-37°C), the boiling point of the coolant in the pressurized cooling system is reached at approximately 266°F (130°C).

The coolant solution must be used year round to provide the necessary corrosion protection and increase boil-over protection. Refer to the Maintenance Booklet for replacement interval.

Coolant system design and coolant used determine the replacement interval. The replacement interval published in the Maintenance Booklet is only applicable if MB 325.0 Anticorrosion/Antifreeze solution or other Mercedes-Benz approved products of equal specification are used to renew the coolant concentration or bring it back up to the proper level.

For information on other Mercedes-Benz approved products of equal specification, contact an authorized Mercedes-Benz Center or visit www.mbusa.com (USA only).

To provide important corrosion protection, the solution must be at least 50% anticorro-



Fuels, coolants, lubricants etc.

sion/antifreeze (equivalent to freeze protection to approximately -35°F [-37°C]).

If you use a solution that is more than 55% anticorrosion/antifreeze (freeze protection to approximately -49°F [-45°C]), the engine temperature will increase due to the lower heat transfer capability of the solution. Therefore, do not use more than this amount of anticorrosion/antifreeze.

If the coolant level is low, water and MB 325.0 Anticorrosion/Antifreeze should be used to bring it up to the proper level (have cooling system checked for signs of leakage). Please make sure the mixture is in accordance with label instructions.

The water in the cooling system must meet minimum requirements, which are usually satisfied by normal drinking water.

If you are not sure about the water quality, contact an authorized Mercedes-Benz Center.

Anticorrosion/antifreeze

Your vehicle contains a number of aluminum parts. The use of aluminum components in motor vehicle engines necessitates that anticorrosion/antifreeze coolant used in such engines be specifically formulated to protect the aluminum parts. Failure to use such anti-

corrosion/antifreeze coolant will result in a significantly shortened service life.

Therefore, the following product is strongly recommended for use in your vehicle: MB 325.0 Anticorrosion/Antifreeze agent.

Before the start of the winter season (or once a year in hot southern regions), you should have the anticorrosion/antifreeze concentration checked.

The coolant is also regularly checked each time you bring your vehicle to an authorized Mercedes-Benz Center for service.

Fuels, coolants, lubricants etc.

	Model	Approximate freeze protection	
		-35°F (-37°C)	-49°F (-45°C)
Cooling system	SL 550	6.1 US qt (5.8 l)	6.8 US qt (6.4 l)
	SL 600	6.8 US qt (6.45 l)	7.5 US qt (7.1 l)
	SL 63 AMG	6.0 US qt (5.65 l)	6.6 US qt (6.2 l)
	SL 65 AMG	7.4 US qt (7.0 l)	8.1 US qt (7.7 l)
Low temperature cooling system	SL 600	1.1 US qt (1.05 l)	1.3 US qt (1.2 l)
	SL 65 AMG	1.7 US qt (1.6 l)	1.9 US qt (1.8 l)

Washer system and headlamp cleaning system

 **Warning!**

Washer solvent/antifreeze is highly flammable. Do not spill washer solvent/antifreeze on hot engine parts, because it may ignite and burn. You could be seriously burned.

Washer fluid mixing ratio

For temperatures above freezing point, use MB Windshield Washer Concentrate “MB SummerFit” and water:

- 1 part “MB SummerFit” to 100 parts water (1.34 fl oz [40 ml] “MB SummerFit” to 1 gal [4.0 l] water)

For temperatures below freezing point, use MB Windshield Washer Concentrate “MB SummerFit” and commercially available pre-mixed washer solvent/antifreeze:

- 1 part “MB SummerFit” to 100 parts solvent

(1.34 fl oz [40 ml] “MB SummerFit” to 1 gal [4.0 l] solvent)

Service and Literature

Your authorized Mercedes-Benz Center has trained technicians and Genuine Mercedes-Benz Parts to service your vehicle properly. For expert advice and quality service, contact an authorized Mercedes-Benz Center.

If you are interested in obtaining service literature for your vehicle, please contact an authorized Mercedes-Benz Center.

We consider this the best way for you to obtain accurate information for your vehicle.

For further information you can find us on the Mercedes-Benz web-site **www.mbusa.com** (USA only) or **www.mercedes-benz.ca** (Canada only).

Warning!

To help avoid personal injury, be extremely careful when performing any service work or repairs. Improper or incomplete service or the use of incorrect or inappropriate parts or materials may damage the vehicle or its equipment, which may in turn result in personal injury.

If you have any questions about carrying out any type of service, turn to the advice of an authorized Mercedes-Benz Center.

We reserve the right to make changes in design and equipment.

Therefore, information, illustrations and descriptions in this Operator's Manual might differ from your vehicle.

Reprinting, translation and copying, even of excerpts, is not permitted without our prior authorization in writing.

Press time February 07, 2008

GSP / TID

Printed in U. S. A.



2305842896

Order no. 6515 3083 13 Part no. 230 584 28 96 Edition A 2009 USA