



# CLS

Operator's Manual



2185843681

Order no. 6515 1504 13 Part no. 218 584 36 81 Edition A 2014

CLS Operator's Manual



Mercedes-Benz

## Symbols

Registered trademarks:

- Bluetooth® is a registered trademark of Bluetooth SIG Inc.
- DTS is a registered trademark of DTS, Inc.
- Dolby and MLP are registered trademarks of DOLBY Laboratories.
- BabySmart™, ESP® and PRE-SAFE® are registered trademarks of Daimler AG.
- HomeLink® is a registered trademark of Johnson Controls.
- iPod® and iTunes® are registered trademarks of Apple Inc.
- Logic7® is a registered trademark of Harman International Industries.
- Microsoft® and Windows media® are registered trademarks of Microsoft Corporation.
- SIRIUS is a registered trademark of Sirius XM Radio Inc.
- HD Radio is a registered trademark of iBiquity Digital Corporation.
- Gracenote® is a registered trademark of Gracenote, Inc.
- ZAGATSurvey® and related brands are registered trademarks of ZagatSurvey, LLC.

In this Operator's Manual you will find the following symbols:

### WARNING

Warning notes draw your attention to hazards that endanger your health or life, or the health or life of others.

### Environmental note

Environmental notes provide you with information on environmentally aware actions or disposal.

- ! Notes on material damage alert you to dangers that could lead to damage to your vehicle.

 Practical tips or further information that could be helpful to you.

- ▶ This symbol indicates an instruction that must be followed.
- ▶ Several of these symbols in succession indicate an instruction with several steps.
- (▷ page) This symbol tells you where you can find more information about a topic.
- ▷▷ This symbol indicates a warning or an instruction that is continued on the next page.

**Display** This font indicates a display in the multifunction display/COMAND display.

Parts of the software in the vehicle are protected by copyright © 2005 The FreeType Project  
<http://www.freetype.org>. All rights reserved.

## Publication details

### Internet

Further information about Mercedes-Benz vehicles and about Daimler AG can be found on the following websites:

<http://www.mbusa.com> (USA only)

<http://www.mercedes-benz.ca> (Canada only)

### Editorial office

You are welcome to forward any queries or suggestions you may have regarding this Operator's Manual to the technical documentation team at the following address:

Daimler AG, HPC: CAC, Customer Service,  
70546 Stuttgart, Germany

©Daimler AG: Not to be reprinted, translated or otherwise reproduced, in whole or in part, without written permission from Daimler AG.

## **Welcome to the world of Mercedes-Benz**

We urge you to read this Operator's Manual carefully and familiarize yourself with the vehicle before driving. For your own safety and a longer vehicle life, follow the instructions and warning notices in this manual. Ignoring them could result in damage to the vehicle or personal injury to you or others.

Vehicle damage caused by failure to follow instructions is not covered by the Mercedes-Benz Limited Warranty.

The equipment or product designation of your vehicle may vary depending on:

- model
- order
- country specification
- availability

Mercedes-Benz therefore reserves the right to introduce changes in the following areas:

- design
- equipment
- technical features

The equipment in your vehicle may therefore differ from that shown in the descriptions and illustrations.

The following are integral components of the vehicle:

- Operator's Manual
- Maintenance Booklet
- Equipment-dependent supplements

Keep printed copies of the documents in the vehicle at all times. If you sell the vehicle, always pass the documents on to the new owner.

The technical documentation team at Daimler AG wishes you safe and pleasant motoring.

Mercedes-Benz USA, LLC

Mercedes-Benz Canada, Inc.

A Daimler Company



<b>Index</b> .....	<b>4</b>	<b>At a glance</b> .....	<b>29</b>
<b>Introduction</b> .....	<b>21</b>	<b>Safety</b> .....	<b>39</b>
		<b>Opening and closing</b> .....	<b>75</b>
		<b>Seats, steering wheel and mirrors</b> ....	<b>97</b>
		<b>Lights and windshield wipers</b> .....	<b>115</b>
		<b>Climate control</b> .....	<b>129</b>
		<b>Driving and parking</b> .....	<b>145</b>
		<b>On-board computer and displays</b> ....	<b>217</b>
		<b>Stowage and features</b> .....	<b>277</b>
		<b>Maintenance and care</b> .....	<b>305</b>
		<b>Breakdown assistance</b> .....	<b>319</b>
		<b>Wheels and tires</b> .....	<b>333</b>
		<b>Technical data</b> .....	<b>371</b>

## 1, 2, 3 ...

**12 V socket**

see Sockets

**4ETS**see ETS/4ETS (Electronic  
Traction System)**4MATIC (permanent four-wheel****drive) ..... 193****4MATIC off-road system ..... 193****A****ABS (Anti-lock Braking System)**

Display message ..... 238

Function/notes ..... 66

Important safety notes ..... 66

Warning lamp ..... 267

**Activating/deactivating cooling  
with air dehumidification ..... 136****Active Blind Spot Assist**Activating/deactivating (on-  
board computer) ..... 228

Display message ..... 254

Function/information ..... 211

**Active Driving Assistance package . 211****Active Lane Keeping Assist**Activating/deactivating (on-  
board computer) ..... 229

Display message ..... 253

Function/information ..... 214

**Active light function ..... 121****Active multicontour seat**

Adjusting (on the seat) ..... 103

**Active Parking Assist**

Detecting parking spaces ..... 197

Display message ..... 254

Function/notes ..... 196

Important safety notes ..... 196

Parking ..... 198

**ADAPTIVE BRAKE ..... 72****Adaptive Damping System (ADS) ..... 190****Adaptive Highbeam Assist**

Display message ..... 248

Function/notes ..... 121

**Additives (engine oil) ..... 376****Air bags**

Display message ..... 244

Front air bag (driver, front  
passenger) ..... 44

Important safety notes ..... 42

Knee bag ..... 45

PASSENGER AIR BAG OFF

indicator lamp ..... 47

Pelvis air bag ..... 46

Safety guidelines ..... 41

Side impact air bag ..... 45

Window curtain air bag ..... 47

**Air-conditioning system**

see Climate control

**AIR FLOW ..... 137****AIRMATIC**

Display message ..... 252

Function/notes ..... 189

**Air vents**

Glove box ..... 142

Important safety notes ..... 142

Rear ..... 143

Setting ..... 142

Setting the center air vents ..... 142

Setting the side air vents ..... 142

**Ambient lighting**Setting the brightness (on-board  
computer) ..... 231Setting the color (on-board  
computer) ..... 231**AMG adaptive sport suspension****system ..... 190****Ashtray ..... 287****Assistance display (on-board****computer) ..... 227****Assistance menu (on-board****computer) ..... 227****ASSYST PLUS**

Displaying a service message ..... 310

Hiding a service message ..... 310

Notes ..... 309

Resetting the service interval

display ..... 310

Service message ..... 309

Special service requirements ..... 310

- ATA (Anti-Theft Alarm system)**  
 Activating/deactivating ..... 74  
 Function ..... 74  
 Switching off the alarm ..... 74
- ATTENTION ASSIST**  
 Activating/deactivating ..... 228  
 Display message ..... 251  
 Function/notes ..... 203
- Audio system**  
 see separate operating instructions
- Authorized Mercedes-Benz Center**  
 see Qualified specialist workshop
- AUTO lights**  
 Display message ..... 247  
 see Lights
- Automatic engine start (ECO start/stop function)** ..... 152
- Automatic engine switch-off (ECO start/stop function)** ..... 151
- Automatic headlamp mode** ..... 117
- Automatic transmission**  
 Automatic drive program ..... 160  
 Changing gear ..... 158  
 DIRECT SELECT lever ..... 155  
 Display message ..... 260  
 Drive program display ..... 156  
 Driving tips ..... 158  
 Emergency running mode ..... 164  
 Engaging drive position ..... 158  
 Engaging neutral ..... 157  
 Engaging park position (AMG vehicles) ..... 157  
 Engaging reverse gear ..... 157  
 Engaging the park position ..... 156  
 Kickdown ..... 159  
 Manual drive program ..... 161  
 Manual drive program (AMG vehicles) ..... 162  
 Manual drive program (vehicles with Sports package AMG) ..... 162  
 Overview ..... 155  
 Problem (malfunction) ..... 164  
 Program selector button ..... 159  
 Pulling away ..... 150  
 Selector lever ..... 155  
 Shift ranges ..... 162  
 Starting the engine ..... 149  
 Steering wheel paddle shifters ..... 160  
 Transmission position display ..... 155  
 Transmission position display (DIRECT SELECT lever) ..... 156  
 Transmission positions ..... 158
- Automatic transmission emergency mode** ..... 164
- B**
- Backup lamp**  
 Changing bulbs ..... 125
- Bag hook** ..... 283
- BAS (Brake Assist System)** ..... 67
- BAS PLUS (Brake Assist System PLUS)** ..... 67
- Battery (SmartKey)**  
 Checking ..... 79  
 Important safety notes ..... 79  
 Replacing ..... 79
- Battery (vehicle)**  
 Charging ..... 324  
 Display message ..... 250  
 Important safety notes ..... 322  
 Jump starting ..... 326
- Belt force limiter**  
 Activation ..... 59  
 Function ..... 59
- Blind Spot Assist**  
 Activating/deactivating ..... 228  
 Display message ..... 254  
 Notes/function ..... 207  
 see Active Blind Spot Assist
- Bottle holder** ..... 285
- Brake fluid**  
 Display message ..... 240  
 Notes ..... 376
- Brake lamps**  
 Display message ..... 246
- Brakes**  
 ABS ..... 66  
 BAS ..... 67  
 BAS PLUS ..... 67  
 Brake fluid (notes) ..... 376  
 Display message ..... 238  
 Driving tips ..... 172  
 High-performance brake system .... 173  
 Important safety notes ..... 172  
 Maintenance ..... 173

Parking brake .....	169
Warning lamp .....	266

**Breakdown**

- see Flat tire
- see Towing away

**Bulbs**

- see Changing bulbs

**C****California**

- Important notice for retail customers and lessees ..... 23

**Calling up a malfunction**

- see Display messages

**Care**

Carpets .....	318
Car wash .....	311
Display .....	315
Exhaust pipe .....	315
Exterior lights .....	314
Gear or selector lever .....	316
Interior .....	315
Matte finish .....	313
Night View Assist Plus .....	316
Notes .....	311
Paint .....	313
Plastic trim .....	316
Power washer .....	312
Rear view camera .....	315
Roof lining .....	318
Seat belt .....	317
Seat cover .....	317
Sensors .....	315
Steering wheel .....	316
Trim pieces .....	316
Washing by hand .....	312
Wheels .....	314
Windows .....	314
Wiper blades .....	314
Wooden trim .....	316

<b>Cargo tie down rings</b> .....	282
-----------------------------------	-----

<b>Car wash (care)</b> .....	311
------------------------------	-----

<b>CD player/CD changer (on-board computer)</b> .....	225
---	-----

**Center console**

Lower section .....	35
Lower section (AMG vehicles) .....	36
Upper section .....	34

**Central locking**

Automatic locking (on-board computer) .....	232
Locking/unlocking (SmartKey) .....	76

**Changing bulbs**

Important safety notes .....	124
Overview of bulb types .....	125
Reversing lamps .....	125

**Child-proof locks**

Important safety notes .....	64
Rear doors .....	65

**Children**

In the vehicle .....	60
Restraint systems .....	60
Special seat belt retractor .....	63

**Child seat**

LATCH-type (ISOFIX) child seat anchors .....	63
Top Tether .....	64

<b>Cigarette lighter</b> .....	288
--------------------------------	-----

**Cleaning**

Mirror turn signal .....	314
--------------------------	-----

**Climate control**

Automatic climate control (3-zone) .....	134
Controlling automatically .....	137
Cooling with air dehumidification ..	136
Defrosting the windows .....	140
Defrosting the windshield .....	139
Dual-zone automatic climate control .....	131
Important safety notes .....	130
Indicator lamp .....	137
Information about using dual-zone automatic climate control .....	132
Information on using 3-zone automatic climate control .....	135
Maximum cooling .....	139
Overview of systems .....	130
Problems with cooling with air dehumidification .....	137
Problem with the rear window defroster .....	141
Rear control panel .....	134



- Refrigerant ..... 378
  - Refrigerant filling capacity ..... 379
  - Setting the air distribution ..... 138
  - Setting the airflow ..... 139
  - Setting the air vents ..... 142
  - Setting the climate mode (AIR FLOW) ..... 137
  - Setting the temperature ..... 138
  - Setting the temperature with 3-zone automatic climate control ..... 138
  - Setting the temperature with dual-zone automatic climate control ..... 138
  - Switching air-recirculation mode on/off ..... 141
  - Switching on/off ..... 135
  - Switching residual heat on/off ..... 141
  - Switching the rear window defroster on/off ..... 140
  - Switching the ZONE function on/off ..... 139
  - Cockpit**
    - Overview ..... 30
    - see Instrument cluster
  - Collapsible spare wheel**
    - Inflating ..... 368
    - see Emergency spare wheel
  - COMAND**
    - see separate operating instructions
  - COMAND display**
    - Cleaning ..... 315
  - Combination switch** ..... 119
  - Compass**
    - Calibrating ..... 303
    - Calling up ..... 302
    - Setting ..... 302
  - Consumption statistics (on-board computer)** ..... 222
  - Convenience closing feature** ..... 90
  - Convenience opening feature** ..... 89
  - Coolant (engine)**
    - Checking the level ..... 308
    - Display message ..... 248
    - Filling capacity ..... 377
    - Important safety notes ..... 377
    - Temperature (on-board computer) . 234
    - Temperature gauge ..... 219
    - Warning lamp ..... 273
  - Cooling**
    - see Climate control
  - Copyright** ..... 27
  - Cornering light function**
    - Display message ..... 245
    - Function/notes ..... 121
  - Crash-responsive emergency lighting** ..... 124
  - Cruise control**
    - Activation conditions ..... 176
    - Cruise control lever ..... 176
    - Deactivating ..... 177
    - Display message ..... 257
    - Driving system ..... 175
    - Function/notes ..... 175
    - Important safety notes ..... 175
    - Setting a speed ..... 177
    - Storing and maintaining current speed ..... 176
  - Cup holder**
    - Center console ..... 284
    - Center console in the rear compartment ..... 285
    - Important safety notes ..... 284
    - Rear compartment ..... 285
  - Customer Assistance Center (CAC)** ... 26
  - Customer Relations Department** ..... 26
- D**
- Data**
    - see Technical data
  - Daytime running lamps**
    - Display message ..... 247
    - Function/notes ..... 117
    - Switching on/off (on-board computer) ..... 230
  - Declarations of conformity** ..... 25
  - Delayed switch-off**
    - Exterior lighting (on-board computer) ..... 231
    - Interior lighting ..... 232
  - Diagnostics connection** ..... 25
  - Digital speedometer** ..... 223
  - DIRECT SELECT lever**
    - see Automatic transmission

- Display messages**
  - ASSYST PLUS ..... 309
  - Calling up (on-board computer) ..... 237
  - Driving systems ..... 251
  - Engine ..... 248
  - General notes ..... 237
  - Hiding (on-board computer) ..... 237
  - KEYLESS-GO ..... 262
  - Lights ..... 245
  - Safety systems ..... 238
  - SmartKey ..... 262
  - Tires ..... 258
  - Vehicle ..... 260
- Distance recorder** ..... 222
  - see Trip odometer
- Distance warning (warning lamp)** .... 275
- DISTRONIC PLUS**
  - Activating ..... 180
  - Activation conditions ..... 180
  - Deactivating ..... 184
  - Display message ..... 255
  - Displays in the multifunction display ..... 184
  - Function/notes ..... 177
  - Important safety notes ..... 177
  - Setting the specified minimum distance ..... 183
  - Warning lamp ..... 275
- Doors**
  - Automatic locking (on-board computer) ..... 232
  - Automatic locking (switch) ..... 83
  - Central locking/unlocking (SmartKey) ..... 76
  - Control panel ..... 38
  - Display message ..... 261
  - Emergency locking ..... 84
  - Emergency unlocking ..... 84
  - Important safety notes ..... 82
  - Opening (from inside) ..... 82
- Drinking and driving** ..... 170
- Drinks holder**
  - see Bottle holder
- Drive program**
  - Automatic ..... 160
  - Display ..... 155
  - Display (DIRECT SELECT lever) ..... 156
  - Manual (AMG vehicles) ..... 162
  - Manual (vehicles with Sports package AMG) ..... 162
  - SETUP (on-board computer) ..... 234
- Drive program selector** ..... 159
- Driver's door**
  - see Doors
- Driving abroad**
  - Mercedes-Benz Service ..... 311
  - Symmetrical low beam ..... 116
- Driving on flooded roads** ..... 174
- Driving safety systems**
  - ABS (Anti-lock Braking System) ..... 66
  - ADAPTIVE BRAKE ..... 72
  - BAS (Brake Assist System) ..... 67
  - BAS PLUS (Brake Assist System PLUS) ..... 67
  - Electronic brake force distribution ... 71
  - ESP® (Electronic Stability Program) ..... 68
  - ETS/4ETS (Electronic Traction System) ..... 69
  - Important safety information ..... 66
  - Overview ..... 66
  - PRE-SAFE® Brake ..... 72
- Driving systems**
  - Active Blind Spot Assist ..... 211
  - Active Driving Assistance package ..... 211
  - Active Lane Keeping Assist ..... 214
  - Active Parking Assist ..... 196
  - AIRMATIC ..... 189
  - AMG adaptive sport suspension system ..... 190
  - ATTENTION ASSIST ..... 203
  - Blind Spot Assist ..... 207
  - Cruise control ..... 175
  - Display message ..... 251
  - DISTRONIC PLUS ..... 177
  - HOLD function ..... 186
  - Lane Keeping Assist ..... 209
  - Lane Tracking package ..... 207
  - Night View Assist Plus ..... 204
  - PARKTRONIC ..... 193
  - RACE START (AMG vehicles) ..... 188
  - Rear view camera ..... 199

**Driving tips**

AMG ceramic brakes .....	173
Automatic transmission .....	158
Brakes .....	172
Break-in period .....	146
Downhill gradient .....	172
Drinking and driving .....	170
Driving abroad .....	116
Driving in winter .....	174
Driving on flooded roads .....	174
Driving on wet roads .....	174
Exhaust check .....	170
Fuel .....	170
General .....	169
Hydroplaning .....	174
Icy road surfaces .....	174
Limited braking efficiency on salted roads .....	172
Snow chains .....	337
Symmetrical low beam .....	116
Wet road surface .....	172

**DVD audio**

Operating (on-board computer) .....	225
-------------------------------------	-----

**DVD video**

Operating (on-board computer) .....	226
-------------------------------------	-----

**E****EASY-ENTRY feature**

Activating/deactivating .....	233
Function/notes .....	108

**EASY-EXIT feature**

Crash-responsive .....	109
Function/notes .....	108
Switching on/off .....	233

**EBD (electronic brake force distribution)**

Display message .....	240
Function/notes .....	71

**ECO display**

Function/notes .....	170
On-board computer .....	223

**ECO start/stop function**

Automatic engine switch-off .....	151
Deactivating/activating .....	152
General information .....	151
Important safety notes .....	151
Introduction .....	150

**Emergency release**

Driver's door .....	84
Fuel filler flap .....	166
Trunk .....	88
Vehicle .....	84

**Emergency spare wheel**

Important safety notes .....	367
Points to remember .....	367
Removing .....	368
Storage location .....	368
Stowing .....	368
Technical data .....	370

**Emergency Tensioning Devices**

Function .....	59
Safety guidelines .....	41

**Emissions control**

Service and warranty information ....	23
---------------------------------------	----

**Engine**

Check Engine warning lamp .....	273
Display message .....	248
ECO start/stop function .....	150
Engine number .....	373
Irregular running .....	154
Jump-starting .....	326
Starting problems .....	154
Starting the engine with the SmartKey .....	149
Starting with KEYLESS-GO .....	149
Switching off .....	168
Tow-starting (vehicle) .....	331

**Engine electronics**

Problem (malfunction) .....	154
-----------------------------	-----

**Engine oil**

Adding .....	308
Additives .....	376
Checking the oil level .....	307
Checking the oil level using the dipstick .....	307
Display message .....	250
Filling capacity .....	376
Notes about oil grades .....	375
Notes on oil level/consumption ....	307
Temperature (on-board computer) .	234
Viscosity .....	376

**ESP® (Electronic Stability Program)**

- AMG menu (on-board computer) ... 234
- Deactivating/activating (AMG vehicles) ..... 70
- Deactivating/activating (except AMG vehicles) ..... 227
- Deactivating/activating (notes; except AMG vehicles) ..... 69
- Display message ..... 238
- ETS/4ETS ..... 69
- Function/notes ..... 68
- Important safety information ..... 68
- Warning lamp ..... 269

**ETS/4ETS (Electronic Traction System)**

- ..... 69

**Exhaust check**

- ..... 170

**Exhaust pipe (cleaning instructions)**

- ..... 315

**Exterior lighting**

- Setting options ..... 116
- see Lights

**Exterior mirrors**

- Adjusting ..... 109
- Dipping (automatic) ..... 111
- Folding in/out (automatically) ..... 110
- Folding in/out (electrically) ..... 110
- Folding in when locking (on-board computer) ..... 233
- Out of position (troubleshooting) ... 110
- Setting ..... 110
- Storing settings (memory function) ..... 112
- Storing the parking position ..... 111

**Eyeglasses compartment**

- ..... 279

**F****Filler cap**

- see Fuel filler flap

**First-aid kit**

- ..... 320

**Flat tire**

- MOExtended tires ..... 321
- Preparing the vehicle ..... 321

**Floormat**

- ..... 303

**Fuel**

- Additives ..... 375
- Consumption statistics ..... 222

- Displaying the current consumption ..... 223
- Displaying the range ..... 223
- Driving tips ..... 170
- Fuel gauge ..... 31, 219
- Grade (gasoline) ..... 374
- Important safety notes ..... 374
- Premium-grade unleaded gasoline . 374
- Problem (malfunction) ..... 167
- Refueling ..... 164
- Tank content/reserve fuel ..... 374

**Fuel filler flap**

- Emergency release ..... 166
- Opening/closing ..... 165

**Fuel level**

- Calling up the range (on-board computer) ..... 223

**Fuel tank**

- Capacity ..... 374
- Problem (malfunction) ..... 167

**Fuse allocation chart (vehicle tool kit)**

- ..... 320

**Fuses**

- Allocation chart ..... 331
- Before changing ..... 331
- Fuse box in the engine compartment ..... 332
- Fuse box in the trunk ..... 332
- Important safety notes ..... 331

**G****Garage door opener**

- Clearing the memory ..... 301
- Important safety notes ..... 299
- Opening/closing the garage door .. 301
- Programming (button in the rear-view mirror) ..... 299

**Gear indicator (on-board computer)**

- ..... 234

**Genuine**

- ..... 22

**Glove box**

- ..... 279

**H****Hazard warning lamps**

- ..... 120

**Head bags**

- Display message ..... 242

**Headlamps**

- Adding fluid to cleaning system ..... 309
- Cleaning system (function) ..... 120
- Cleaning system (notes) ..... 378
- Fogging up ..... 122
- see Automatic headlamp mode

**Head restraints**

- Adjusting ..... 100
- Adjusting (electrically) ..... 101
- Adjusting (rear) ..... 101
- Installing/removing (rear) ..... 102
- Luxury ..... 101

**Heating**

- see Climate control

**High-beam headlamps**

- Display message ..... 246
- Switching Adaptive Highbeam
- Assist on/off ..... 122
- Switching on/off ..... 119

**Hill start assist** ..... 150**HOLD function**

- Display message ..... 252
- Function/notes ..... 186

**Hood**

- Closing ..... 307
- Display message ..... 261
- Important safety notes ..... 306
- Opening ..... 306

**Hydroplaning** ..... 174**I****Ignition lock**

- see Key positions

**Immobilizer** ..... 73**Indicator lamps**

- see Warning and indicator lamps

**Instrument cluster**

- Overview ..... 31, 219
- Settings ..... 229
- Warning and indicator
- lamps ..... 32, 264

**Instrument cluster lighting** ..... 230**Interior lighting** ..... 123

- Automatic control ..... 123
- Delayed switch-off (on-board
- computer) ..... 232
- Emergency lighting ..... 124

Manual control ..... 124

Overview ..... 123

Reading lamp ..... 123

Setting the brightness of the ambient lighting (on-board computer) ..... 231

Setting the brightness of the display/switch (on-board computer) ..... 230

Setting the color of the ambient lighting (on-board computer) ..... 231

**J****Jack**

- Storage location ..... 320
- Using ..... 359

**Jump starting (engine)** ..... 326**K****KEYLESS-GO**

- Convenience closing feature ..... 90
- Display message ..... 262
- Locking ..... 77
- Start/Stop button ..... 147
- Starting the engine ..... 149
- Unlocking ..... 77

**Key positions**

- KEYLESS-GO ..... 147
- SmartKey ..... 147

**Kickdown**

- Driving tips ..... 159
- Manual drive program ..... 163

**Knee bag** ..... 45**L****Lamps**

- see Warning and indicator lamps

**Lane Keeping Assist**

- Activating/deactivating ..... 229
- Display message ..... 253
- Function/information ..... 209

**Lane Tracking package** ..... 207**Lap time (RACETIMER)** ..... 235**LATCH-type (ISOFIX) child seat****anchors** ..... 63

- Light function, active**  
 Display message ..... 247
- Lights**  
 Activating/deactivating the interior lighting delayed switch-off . 232  
 Active light function ..... 121  
 Automatic headlamp mode ..... 117  
 Cornering light function ..... 121  
 Driving abroad ..... 116  
 Hazard warning lamps ..... 120  
 High beam flasher ..... 120  
 High-beam headlamps ..... 119  
 Light switch ..... 116  
 Low-beam headlamps ..... 118  
 Parking lamps ..... 118  
 Setting the brightness of the ambient lighting (on-board computer) ..... 231  
 Setting the brightness of the display/switch (on-board computer) ..... 230  
 Setting the color of the ambient lighting (on-board computer) ..... 231  
 Standing lamps ..... 119  
 Switching the daytime running lamps on/off (on-board computer) ..... 230  
 Switching the exterior lighting delayed switch-off on/off (on-board computer) ..... 231  
 Switching the surround lighting on/off (on-board computer) ..... 231  
 Turn signals ..... 119  
 see Changing bulbs  
 see Interior lighting
- Light sensor (display message)** ..... 247
- Loading guidelines** ..... 278
- Locking**  
 see Central locking
- Locking (doors)**  
 Automatic ..... 83  
 Emergency locking ..... 84  
 From inside (central locking button) ..... 83
- Locking centrally**  
 see Central locking
- Locking verification signal (on-board computer)** ..... 232
- Low-beam headlamps**  
 Display message ..... 245  
 Setting for driving abroad (symmetrical) ..... 116  
 Switching on/off ..... 118
- Lumbar support**  
 Adjusting the 4-way lumbar support ..... 103
- Luxury head restraints** ..... 101
- M**
- M+S tires** ..... 336
- Malfunction message**  
 see Display messages
- Massage function (PULSE)** ..... 103
- Matte finish (cleaning instructions)** ..... 313
- mbrace**  
 Call priority ..... 294  
 Display message ..... 241  
 Downloading destinations (COMAND) ..... 294  
 Downloading routes ..... 298  
 Emergency call ..... 291  
 Geo fencing ..... 298  
 Important safety notes ..... 290  
 Locating a stolen vehicle ..... 297  
 MB info call button ..... 293  
 Remote vehicle locking ..... 296  
 Roadside Assistance button ..... 293  
 Search & Send ..... 295  
 Self-test ..... 291  
 Speed alert ..... 298  
 System ..... 291  
 Triggering the vehicle alarm ..... 299  
 Vehicle remote malfunction diagnosis ..... 297  
 Vehicle remote unlocking ..... 296
- Mechanical key**  
 Function/notes ..... 78  
 Locking vehicle ..... 84  
 Unlocking the driver's door ..... 84
- Memory card (audio)** ..... 225
- Memory function** ..... 112
- Message memory (on-board computer)** ..... 237

**Messages**

see Display messages

**Mirrors**

see Exterior mirrors

see Vanity mirror (in the sun visor)

**Mobile phone**

Menu (on-board computer) ..... 226

**Modifying the programming**

(SmartKey) ..... 77

MOExtended tires ..... 321

**Mounting wheels**

Lowering the vehicle ..... 361

Mounting a new wheel ..... 360

Raising the vehicle ..... 359

Removing a wheel ..... 360

Securing the vehicle against  
rolling away ..... 358

**MP3**

Operation ..... 225

see separate operating instructions

**Multicontour seat**

Adjusting (on the seat) ..... 102

**Multifunction display**

Function/notes ..... 221

Permanent display ..... 230

**Multifunction steering wheel**

Operating the on-board computer . 220

Overview ..... 33

**N****Navigation**

Menu (on-board computer) ..... 224

**NECK-PRO head restraints**

Operation ..... 53

Resetting after being triggered ..... 54

**NECK-PRO luxury head restraints**

Operation ..... 53

Resetting after being triggered ..... 54

**Night View Assist Plus**

Activating/deactivating ..... 205

Cleaning ..... 316

Function/notes ..... 204

Problem (malfunction) ..... 207

**Notes on breaking-in a new**

vehicle ..... 146

**O****Occupant Classification System (OCS)**

Faults ..... 52

Operation ..... 47

System self-test ..... 50

**Occupant safety**

Children in the vehicle ..... 60

Important safety notes ..... 40

**OCS**

Faults ..... 52

Operation ..... 47

System self-test ..... 50

**Odometer** ..... 222

see Trip odometer

**Oil**

see Engine oil

**On-board computer**

AMG menu ..... 234

Assistance menu ..... 227

Audio menu ..... 225

Convenience submenu ..... 233

Displaying a service message ..... 310

Display messages ..... 237

DISTRONIC PLUS ..... 184

Factory settings submenu ..... 234

Important safety notes ..... 218

Instrument cluster submenu ..... 229

Lighting submenu ..... 230

Menu overview ..... 222

Message memory ..... 237

Navigation menu ..... 224

Operation ..... 220

RACETIMER ..... 235

Service menu ..... 229

Settings menu ..... 229

Standard display ..... 222

Telephone menu ..... 226

Trip menu ..... 222

Vehicle submenu ..... 232

Video DVD operation ..... 226

**Operating safety**

Declaration of conformity ..... 25

Important safety notes ..... 24

**Operating system**

see On-board computer

- Operator's Manual**  
 Vehicle equipment ..... 22
- Outside temperature display** ..... 220
- Overhead control panel** ..... 37
- Override feature**  
 Rear side windows ..... 65
- P**
- Paint code number** ..... 372
- Paintwork (cleaning instructions)** ... 313
- Panic alarm** ..... 40
- Parking** ..... 167  
 Important safety notes ..... 167  
 Parking brake ..... 169  
 Position of exterior mirror, front-passenger side ..... 111  
 Rear view camera ..... 199  
 see PARKTRONIC
- Parking aid**  
 Active Parking Assist ..... 196  
 see Exterior mirrors  
 see PARKTRONIC
- Parking brake**  
 Display message ..... 240  
 Notes/function ..... 169  
 Warning lamp ..... 272
- Parking lamps**  
 Switching on/off ..... 118
- PARKTRONIC**  
 Deactivating/activating ..... 195  
 Driving system ..... 193  
 Function/notes ..... 193  
 Important safety notes ..... 193  
 Problem (malfunction) ..... 196  
 Range of the sensors ..... 194  
 Warning display ..... 195
- PASS AIR BAG OFF**  
 see PASSENGER AIR BAG OFF
- PASSENGER AIR BAG OFF**  
 Indicator lamp ..... 47  
 Problems (malfunction) ..... 244
- Plastic trim (cleaning instructions)** . 316
- Power washers** ..... 312
- Power windows**  
 see Side windows
- PRE-SAFE® (anticipatory occupant protection)**  
 Display message ..... 241  
 Operation ..... 54
- PRE-SAFE® Brake**  
 Activating/deactivating ..... 228  
 Display message ..... 241  
 Function/notes ..... 72  
 Warning lamp ..... 275
- Product information** ..... 21
- Program selector button** ..... 159
- Protection of the environment**  
 General notes ..... 21
- Pulling away (automatic transmission)** ..... 150
- Q**
- Qualified specialist workshop** ..... 26
- R**
- RACE START (AMG vehicles)** ..... 188
- RACETIMER (on-board computer)** .... 235
- Radar sensor system**  
 Activating/deactivating ..... 232  
 Display message ..... 252
- Radio**  
 Selecting a station ..... 225  
 see separate operating instructions
- Radio-based vehicle components**  
 Declaration of conformity ..... 25
- Reading lamp** ..... 123
- Rear compartment**  
 Setting the air vents ..... 143
- Rear fog lamp**  
 Display message ..... 246
- Rear seat (folding the backrest forwards/back)** ..... 281
- Rear seats**  
 Display message ..... 261
- Rear view camera**  
 Cleaning instructions ..... 315  
 Function/notes ..... 199  
 Switching on/off ..... 200
- Rear-view mirror**  
 Dipping (automatic) ..... 111
- Rear window blind** ..... 287



- Rear window defroster**
    - Problem (malfunction) ..... 141
    - Switching on/off ..... 140
  - Refrigerant (air-conditioning system)**
    - Important safety notes ..... 378
  - Refueling**
    - Fuel gauge ..... 31, 219
    - Important safety notes ..... 164
    - Refueling process ..... 165
    - see Fuel
  - Remote control**
    - Garage door opener ..... 299
    - Programming (garage door opener) ..... 299
  - Reporting safety defects** ..... 26
  - Reserve (fuel tank)**
    - see Fuel
  - Reserve fuel**
    - Display message ..... 251
    - Warning lamp ..... 273
    - see Fuel
  - Residual heat (climate control)** ..... 141
  - Reverse gear (selector lever)** ..... 155
  - Reversing feature**
    - Side windows ..... 88
    - Sliding sunroof ..... 93
  - Reversing lamps (display message)** ..... 246
  - Roadside Assistance (breakdown)** .... 23
  - Roller sunblind**
    - Rear window ..... 287
  - Roof carrier** ..... 283
  - Roof lining and carpets (cleaning guidelines)** ..... 318
  - Roof load (maximum)** ..... 379
- S
- Safety**
    - Children in the vehicle ..... 60
    - Child restraint systems ..... 60
    - Occupant Classification System (OCS) ..... 47
  - Seat belts**
    - Adjusting the driver's and front-passenger seat belt ..... 57
    - Adjusting the height ..... 58
    - Belt force limiters ..... 59
    - Cleaning ..... 317
    - Correct usage ..... 56
    - Emergency Tensioning Devices ..... 59
    - Fastening ..... 56
    - Important safety guidelines ..... 55
    - Releasing ..... 58
    - Safety guidelines ..... 41
    - Switching belt adjustment on/off (on-board computer) ..... 233
    - Warning lamp ..... 265
    - Warning lamp (function) ..... 58
  - Seats**
    - Adjusting (electrically) ..... 100
    - Adjusting the 4-way lumbar support ..... 103
    - Adjusting the active multicontour seat ..... 103
    - Adjusting the head restraint ..... 100
    - Adjusting the multicontour seat .... 102
    - Cleaning the cover ..... 317
    - Correct driver's seat position ..... 98
    - Important safety notes ..... 99
    - Massage function ..... 103
    - Overview ..... 99
    - Seat backrest display message .... 261
    - Seat heating problem ..... 105
    - Seat ventilation problem ..... 106
    - Storing settings (memory function) ..... 112
    - Switching seat heating on/off ..... 104
    - Switching seat ventilation on/off .. 105
  - Selector lever**
    - Cleaning ..... 316
  - Sensors (cleaning instructions)** ..... 315
  - Service menu (on-board computer)** . 229
  - Service products**
    - Brake fluid ..... 376
    - Coolant (engine) ..... 377
    - Engine oil ..... 375
    - Fuel ..... 374
    - Important safety notes ..... 373
    - Refrigerant (air-conditioning system) ..... 378
    - Washer fluid ..... 378
  - Settings**
    - Factory (on-board computer) ..... 234
    - On-board computer ..... 229

- Setting the air distribution** ..... 138
- Setting the airflow** ..... 139
- SETUP (on-board computer)** ..... 234
- Side impact air bag** ..... 45
- Side marker lamp (display message)** ..... 247
- Side windows**
- Cleaning ..... 314
  - Convenience closing feature ..... 90
  - Convenience opening feature ..... 89
  - Important safety information ..... 88
  - Opening/closing ..... 89
  - Problem (malfunction) ..... 92
  - Resetting ..... 91
- Sliding sunroof**
- Important safety notes ..... 92
  - Opening/closing ..... 93
  - Problem (malfunction) ..... 95
  - Resetting ..... 94
- SmartKey**
- Changing the battery ..... 79
  - Changing the programming ..... 77
  - Checking the battery ..... 79
  - Convenience closing feature ..... 90
  - Convenience opening feature ..... 89
  - Display message ..... 262
  - Door central locking/unlocking ..... 76
  - Important safety notes ..... 76
  - Loss ..... 81
  - Mechanical key ..... 78
  - Positions (ignition lock) ..... 147
  - Problem (malfunction) ..... 81
  - Starting the engine ..... 149
- Snow chains** ..... 337
- Sockets**
- Center console ..... 289
  - General notes ..... 289
  - Rear compartment ..... 290
  - Trunk ..... 290
  - Under the armrest ..... 289
- Spare wheel**
- Stowing ..... 368
- Specialist workshop** ..... 26
- Special seat belt retractor** ..... 63
- Speed, controlling**
- see Cruise control
- Speedometer**
- Digital ..... 223
  - In the Instrument cluster ..... 31, 219
  - Segments ..... 220
  - Selecting the unit of measurement ..... 229
  - see Instrument cluster
- SPORT handling mode**
- Activating/deactivating (AMG vehicles) ..... 70
  - Warning lamp ..... 270
- SRS (Supplemental Restraint System)**
- Display message ..... 242
  - Introduction ..... 41
  - Warning lamp ..... 272
  - Warning lamp (function) ..... 41
- Standing lamps**
- Display message ..... 246
  - Switching on/off ..... 119
- Start/stop function**
- see ECO start/stop function
- Starting (engine)** ..... 149
- Steering (display message)** ..... 262
- Steering wheel**
- Adjusting (electrically) ..... 106
  - Button overview ..... 33
  - Buttons (on-board computer) ..... 220
  - Cleaning ..... 316
  - Important safety notes ..... 106
  - Paddle shifters ..... 160
  - Steering wheel heating ..... 107
  - Storing settings (memory function) ..... 112
- Steering wheel heating**
- Problem (malfunction) ..... 108
  - Switching on/off ..... 107
- Steering wheel paddle shifters** ..... 160
- Stopwatch (RACETIMER)** ..... 235
- Stowage areas** ..... 278
- Stowage compartments**
- Armrest (under) ..... 280
  - Center console ..... 279
  - Cup holders ..... 284
  - Eyeglasses compartment ..... 279
  - Glove box ..... 279
  - Important safety information ..... 278
  - Rear ..... 281

- Stowage net ..... 281
  - Under driver's seat/front-passenger seat ..... 280
  - Stowage net** ..... 281
  - Stowage space**
    - Center console (rear) ..... 280
  - Stowage well beneath the trunk floor** ..... 283
  - Summer tires** ..... 336
  - Sun visor** ..... 286
  - Surround lighting (on-board computer)** ..... 231
  - Suspension tuning**
    - AIRMATIC ..... 190
    - AMG adaptive sport suspension system ..... 191
    - SETUP (on-board computer) ..... 234
  - Switching air-recirculation mode on/off** ..... 141
  - Switching off the alarm (ATA)** ..... 74
- T**
- Tachometer** ..... 219
  - Tail lamps**
    - Display message ..... 246
  - Tank content**
    - Fuel gauge ..... 31, 219
  - Technical data**
    - Capacities ..... 373
    - Emergency spare wheel ..... 370
    - Information ..... 372
    - Tires/wheels ..... 362
    - Vehicle data ..... 379
  - TELEAID**
    - Call priority ..... 294
    - Downloading destinations (COMAND) ..... 294
    - Downloading routes ..... 298
    - Emergency call ..... 291
    - Geo fencing ..... 298
    - Important safety notes ..... 290
    - Locating a stolen vehicle ..... 297
    - MB info call button ..... 293
    - Remote vehicle locking ..... 296
    - Roadside Assistance button ..... 293
    - Search & Send ..... 295
    - Self-test ..... 291
  - Speed alert ..... 298
  - System ..... 291
  - Triggering the vehicle alarm ..... 299
  - Vehicle remote malfunction diagnosis ..... 297
  - Vehicle remote unlocking ..... 296
  - Telephone**
    - Accepting a call ..... 226
    - Display message ..... 262
    - Menu (on-board computer) ..... 226
    - Number from the phone book ..... 226
    - Redialing ..... 227
    - Rejecting/ending a call ..... 226
  - Temperature**
    - Coolant ..... 219
    - Coolant (on-board computer) ..... 234
    - Engine oil (on-board computer) ..... 234
    - Outside temperature ..... 220
    - Setting (climate control) ..... 138
  - Theft deterrent systems**
    - ATA (Anti-Theft Alarm system) ..... 74
    - Immobilizer ..... 73
  - Through-loading feature** ..... 281
  - Timing (RACETIMER)** ..... 235
  - Tire pressure**
    - Calling up (on-board computer) ..... 342
    - Checking manually ..... 341
    - Display message ..... 258
    - Maximum ..... 340
    - Notes ..... 339
    - Recommended ..... 338
  - Tire pressure loss warning system**
    - General notes ..... 341
    - Important safety notes ..... 341
    - Restarting ..... 342
  - Tire pressure monitoring system**
    - Checking the tire pressure electronically ..... 344
    - Function/notes ..... 342
    - Restarting ..... 345
    - Warning lamp ..... 276
    - Warning message ..... 344
  - Tires**
    - Aspect ratio (definition) ..... 356
    - Average weight of the vehicle occupants (definition) ..... 355
    - Bar (definition) ..... 354
    - Changing a wheel ..... 357

- Characteristics ..... 354
- Checking ..... 335
- Definition of terms ..... 354
- Direction of rotation ..... 357
- Display message ..... 258
- Distribution of the vehicle occupants (definition) ..... 357
- DOT, Tire Identification Number (TIN) ..... 354
- DOT (Department of Transportation) (definition) ..... 355
- GAWR (Gross Axle Weight Rating) (definition) ..... 355
- GVW (Gross Vehicle Weight) (definition) ..... 355
- GVWR (Gross Vehicle Weight Rating) (definition) ..... 355
- Important safety notes ..... 334
- Increased vehicle weight due to optional equipment (definition) ..... 355
- Kilopascal (kPa) (definition) ..... 355
- Labeling (overview) ..... 351
- Load bearing index (definition) ..... 356
- Load index ..... 353
- Load index (definition) ..... 355
- Maximum loaded vehicle weight (definition) ..... 355
- Maximum load on a tire (definition) ..... 356
- Maximum permissible tire pressure (definition) ..... 356
- Maximum tire load ..... 353
- Maximum tire load (definition) ..... 356
- MOExtended tires ..... 336
- Optional equipment weight (definition) ..... 356
- PSI (pounds per square inch) (definition) ..... 356
- Replacing ..... 357
- Service life ..... 336
- Sidewall (definition) ..... 356
- Speed rating (definition) ..... 355
- Storing ..... 357
- Structure and characteristics (definition) ..... 354
- Temperature ..... 350
- TIN (Tire Identification Number) (definition) ..... 356
- Tire bead (definition) ..... 356
- Tire pressure (definition) ..... 356
- Tire pressures (recommended) ..... 355
- Tire size (data) ..... 362
- Tire size designation, load-bearing capacity, speed rating ..... 351
- Tire tread ..... 335
- Tire tread (definition) ..... 356
- Total load limit (definition) ..... 357
- Traction ..... 350
- Traction (definition) ..... 356
- Tread wear ..... 350
- Uniform Tire Quality Grading Standards ..... 349
- Uniform Tire Quality Grading Standards (definition) ..... 355
- Unladen weight (definition) ..... 356
- Wear indicator (definition) ..... 356
- Wheel rim (definition) ..... 355
- see Flat tire
- Top Tether** ..... 64
- Towing**
  - Important safety guidelines ..... 328
  - Installing the towing eye ..... 329
  - Removing the towing eye ..... 330
  - With the rear axle raised ..... 330
- Towing away**
  - With both axles on the ground ..... 330
- Tow-starting**
  - Emergency engine starting ..... 331
  - Important safety notes ..... 328
- Transmission**
  - see Automatic transmission
- Transmission position display** ..... 156
- Transmission position display (DIRECT SELECT lever)** ..... 156
- Transporting the vehicle** ..... 330
- Trim pieces (cleaning instructions)** . 316
- Trip computer (on-board computer)** ..... 222
- Trip odometer**
  - Calling up ..... 222
  - Resetting (on-board computer) ..... 223
- Trunk**
  - Emergency release ..... 87
  - Important safety notes ..... 84
  - Opening/closing (automatically from inside) ..... 86

- Opening/closing (automatically from outside) ..... 86
  - Opening/closing (manually from outside) ..... 85
  - Trunk lid**
    - Display message ..... 261
    - Opening/closing ..... 84
    - Opening dimensions ..... 379
  - Trunk load (maximum)** ..... 379
  - Turn signals**
    - Display message ..... 245
    - Switching on/off ..... 119
  - Type identification plate**  
see Vehicle identification plate
- U**
- Unlocking**
    - Emergency unlocking ..... 84
    - From inside the vehicle (central unlocking button) ..... 83
- V**
- Vanity mirror (in the sun visor)** ..... 286
  - Vehicle**
    - Data acquisition ..... 27
    - Display message ..... 260
    - Equipment ..... 22
    - Individual settings ..... 229
    - Limited Warranty ..... 26
    - Loading ..... 345
    - Locking (in an emergency) ..... 84
    - Locking (SmartKey) ..... 76
    - Lowering ..... 361
    - Maintenance ..... 23
    - Parking for a long period ..... 169
    - Pulling away ..... 150
    - Raising ..... 359
    - Reporting problems ..... 26
    - Securing from rolling away ..... 358
    - Towing away ..... 328
    - Transporting ..... 330
    - Unlocking (in an emergency) ..... 84
    - Unlocking (SmartKey) ..... 76
    - Vehicle data ..... 379
  - Vehicle data** ..... 379
  - Vehicle dimensions** ..... 379
  - Vehicle emergency locking** ..... 84
  - Vehicle identification number**  
see VIN
  - Vehicle identification plate** ..... 372
  - Vehicle level**
    - AIRMATIC ..... 189
  - Vehicle level (display message)** ..... 252
  - Vehicle tool kit** ..... 320
  - Video**
    - Operating the DVD ..... 226
  - VIN** ..... 372
- W**
- Warning and indicator lamps**
    - ABS ..... 267
    - Brakes ..... 266
    - Check Engine ..... 273
    - Coolant ..... 273
    - Distance warning ..... 275
    - DISTRONIC PLUS ..... 275
    - ESP® ..... 269
    - ESP® OFF ..... 270
    - Fuel tank ..... 273
    - Overview ..... 32, 264
    - PASSENGER AIR BAG OFF ..... 47
    - Reserve fuel ..... 273
    - Seat belt ..... 265
    - SPORT handling mode ..... 270
    - SRS ..... 272
    - Tire pressure monitor ..... 276
  - Warranty** ..... 372
  - Washer fluid**
    - Display message ..... 262
  - Wheel bolt tightening torque** ..... 361
  - Wheel chock** ..... 358
  - Wheels**
    - Changing a wheel ..... 357
    - Checking ..... 335
    - Cleaning ..... 314
    - Cleaning (warning) ..... 357
    - Emergency spare wheel ..... 367
    - Important safety notes ..... 334
    - Interchanging/changing ..... 357
    - Mounting a new wheel ..... 360
    - Mounting a wheel ..... 358
    - Removing a wheel ..... 360
    - Storing ..... 357

Tightening torque .....	361
Wheel size/tire size .....	362
<b>Window curtain air bag</b>	
Operation .....	47
<b>Windows</b>	
see Side windows	
<b>Windshield</b>	
Defrosting .....	139
<b>Windshield washer fluid</b>	
see Windshield washer system	
<b>Windshield washer system</b>	
Adding washer fluid .....	309
Notes .....	378
<b>Windshield wipers</b>	
Problem (malfunction) .....	128
Replacing the wiper blades .....	126
Switching on/off .....	125
<b>Winter driving</b>	
Important safety notes .....	336
Slippery road surfaces .....	174
Snow chains .....	337
<b>Winter tires</b>	
M+S tires .....	336
<b>Wiper blades</b>	
Cleaning .....	314
Important safety notes .....	126
Replacing .....	126
<b>Wooden trim (cleaning instructions)</b> .....	316

## Z

<b>ZONE function</b>	
Switching on/off .....	139

## Protection of the environment

### General notes

#### Environmental note

Daimler's declared policy is one of comprehensive environmental protection.

The objectives are for the natural resources that form the basis of our existence on this planet to be used sparingly and in a manner that takes the requirements of both nature and humanity into account.

You too can help to protect the environment by operating your vehicle in an environmentally responsible manner.

Fuel consumption and the rate of engine, transmission, brake and tire wear are affected by these factors:

- operating conditions of your vehicle
- your personal driving style

You can influence both factors. You should bear the following in mind:

Operating conditions:

- avoid short trips as these increase fuel consumption.
- always make sure that the tire pressures are correct.
- do not carry any unnecessary weight.
- remove roof racks once you no longer need them.
- a regularly serviced vehicle will contribute to environmental protection. You should therefore adhere to the service intervals.
- always have service work carried out at a qualified specialist workshop.

Personal driving style:

- do not depress the accelerator pedal when starting the engine.
- do not warm up the engine when the vehicle is stationary.
- drive carefully and maintain a safe distance from the vehicle in front.
- avoid frequent, sudden acceleration and braking.

- change gear in good time and use each gear only up to  $\frac{2}{3}$  of its maximum engine speed.
- switch off the engine in stationary traffic.
- keep an eye on the vehicle's fuel consumption.

### Environmental concerns and recommendations

Wherever the operating instructions require you to dispose of materials, first try to regenerate or re-use them. Observe the relevant environmental rules and regulations when disposing of materials. In this way you will help to protect the environment.

### Product information

Mercedes-Benz recommends that you use genuine Mercedes-Benz parts, conversion parts and accessories that have been approved for your vehicle.

Mercedes-Benz tests genuine parts as well as conversion parts and accessories that have been specifically approved for your vehicle for their reliability, safety and suitability. Despite ongoing market research, Mercedes-Benz is unable to assess other parts. Therefore, Mercedes-Benz accepts no responsibility for the use of such parts in Mercedes-Benz vehicles. This is also the case, even if they have been independently or officially approved. The use of non-approved parts could affect your vehicle's operating safety.

Genuine Mercedes-Benz parts, approved conversion parts and accessories are available from any authorized Mercedes-Benz Center. Here, you will receive advice about permissible technical modifications, and the parts will be professionally installed.

## Genuine Mercedes-Benz parts

### Environmental note

Daimler AG also supplies reconditioned major assemblies and parts which are of the same quality as new parts. They are covered by the same Limited Warranty entitlements as new parts.

**!** Air bags and Emergency Tensioning Devices, as well as control units and sensors for these restraint systems, may be installed in the following areas of your vehicle:

- doors
- door pillars
- door sills
- seats
- cockpit
- instrument cluster
- center console

Do not install accessories such as audio systems in these areas. Do not carry out repairs or welding. You could impair the operating efficiency of the restraint systems.

Have aftermarket accessories installed at a qualified specialist workshop.

You could jeopardize the operating safety of your vehicle if you use parts, tires and wheels as well as accessories relevant to safety which have not been approved by Mercedes. This could lead to malfunctions in safety-relevant systems, e.g. the brake system. Use only genuine Mercedes-Benz parts or parts of equal quality. Only use tires, wheels and accessories that have been specifically approved for your vehicle.

Genuine Mercedes-Benz parts are subject to strict quality control. Every part has been specifically developed, manufactured or selected for and adapted to Mercedes-Benz vehicles. Only genuine Mercedes-Benz parts should therefore be used.

More than 300,000 different genuine Mercedes-Benz parts are available for Mercedes-Benz models.

All authorized Mercedes-Benz Centers maintain a supply of genuine Mercedes-Benz parts for necessary service and repair work. In addition, strategically located parts delivery centers provide quick and reliable parts service.

Always specify the vehicle identification number (VIN) (▷ page 372) and the engine number (▷ page 373) when ordering genuine Mercedes-Benz parts.

## Operator's Manual

### Vehicle equipment

This Operator's Manual describes all models and all standard and optional equipment of your vehicle available at the time of going to print. Country-specific differences are possible. Bear in mind that your vehicle may not feature all functions described here. This also applies to safety-relevant systems and functions. The equipment in your vehicle may therefore differ from that shown in the descriptions and illustrations.

The original purchase agreement lists all systems installed in your vehicle.

Should you have any questions concerning equipment and operation, please consult an authorized Mercedes-Benz Center.

The Operator's Manual and Maintenance Booklet are important documents and should be kept in the vehicle.



## Service and vehicle operation

### Service and literature

Your vehicle is covered under the terms of the warranties printed in the Service and Warranty Information booklet. Your authorized Mercedes-Benz Center will exchange or repair any defective parts originally installed in the vehicle in accordance with the terms of the following warranties:

- New Vehicle Limited Warranty
- Emission Systems Warranty
- Emission Performance Warranty
- California, Connecticut, Maine, Massachusetts, New York, Pennsylvania, Rhode Island and Vermont Emission Control Systems Warranty
- State warranty enforcement laws (lemon laws)

### Information for customers in California

Under California law you may be entitled to a replacement of your vehicle or a refund of the purchase price or lease price, if after a reasonable number of repair attempts Mercedes-Benz USA, LLC and/or its authorized repair or service facilities fail to fix one or more substantial defects or malfunctions in the vehicle that are covered by its express warranty. During the period of 18 months from original delivery of the vehicle or the accumulation of 18,000 miles (approximately 29,000 km) on the odometer of the vehicle, whichever occurs first, a reasonable number of repair attempts is presumed for a retail buyer or lessee if one or more of the following occurs:

- (1) the same substantial defect or malfunction results in a condition that is likely to cause death or serious bodily injury if the vehicle is driven, that defect or malfunction has been subject to repair two or more times, and you have directly

notified Mercedes-Benz USA, LLC in writing of the need for its repair,

- (2) the same substantial defect or malfunction of a less serious nature than category (1) has been subject to repair four or more times and you have directly notified us in writing of the need for its repair, or
- (3) the vehicle is out of service by reason of repair of the same or different substantial defects or malfunctions for a cumulative total of more than 30 calendar days.

Please send your written notice to:

Mercedes-Benz USA, LLC  
Customer Assistance Center  
One Mercedes Drive  
Montvale, NJ 07645-0350

### Maintenance

The Service and Warranty Booklet describes all the necessary maintenance work which should be done at regular intervals.

Always have the Service and Warranty Booklet with you when you bring the vehicle to an authorized Mercedes-Benz Center. The service advisor will record every service for you in the Service and Warranty Booklet.

### Roadside Assistance

The Mercedes-Benz Roadside Assistance Program offers technical help in the event of a breakdown. Calls to the toll-free Roadside Assistance Hotline are answered by our agents 24 hours a day, 365 days a year.

**1-800-FOR-MERCEdes(1-800-367-6372)  
(USA)**

**1-800-387-0100 (Canada)**

For additional information, refer to the Mercedes-Benz Roadside Assistance Program brochure (USA) or the "Roadside Assistance" section in the Service and Warranty booklet (Canada). You will find both in your vehicle literature portfolio.

### Change of address or change of ownership

In the event of a change of address, please send us the "Notification of Address Change" in the Service and Guarantee booklet or simply call the Mercedes-Benz Customer Assistance Center (USA) at the hotline number

1-800-FOR-MERCEdes(1-800-367-6372) or Customer Service Center (Canada) at 1-800-387-0100. This will assist us in contacting you in a timely manner should the need arise.

If you sell your Mercedes, please leave the entire literature in the vehicle so that it is available to the next owner.

If you have purchased a used car, please send us the "Notification of Used Car Purchase" in the Service and Guarantee booklet or simply call the Mercedes-Benz Customer Assistance Center (USA) at the hotline number 1-800-FOR-MERCEdes(1-800-367-6372) or Customer Service (Canada) at 1-800-387-0100.

### Vehicle operation outside the USA and Canada

If you plan to operate your vehicle in foreign countries, please be aware that:

- service facilities or replacement parts may not be readily available.
- unleaded fuel for vehicles with a catalytic converter may not be available. Leaded fuel may cause damage to the catalytic converter.
- the fuel may have a considerably lower octane rating. Unsuitable fuel can cause engine damage.

Some Mercedes-Benz models are available for delivery in Europe through our European Delivery Program. For details, consult an authorized Mercedes-Benz Center or write to one of the following addresses.

#### In the USA

Mercedes-Benz USA, LLC  
European Delivery Department  
One Mercedes Drive  
Montvale, NJ 07645-0350

#### In Canada

Mercedes-Benz Canada, Inc.  
European Delivery Department  
98 Vanderhoof Avenue  
Toronto, Ontario M4G 4C9

### Operating safety

#### Important safety notes

##### WARNING

If you do not have the prescribed service/maintenance work or any required repairs carried out, this can result in malfunctions or system failures. There is a risk of an accident. Always have the prescribed service/maintenance work as well as any required repairs carried out at a qualified specialist workshop.

##### WARNING

If you switch off the ignition while driving, safety-relevant functions are only available with limitations, or not at all. This could affect, for example, the power steering and the brake boosting effect. You will require considerably more effort to steer and brake. There is a risk of an accident.

Do not switch off the ignition while driving.

##### WARNING

Modifications to electronic components, their software as well as wiring can impair their function and/or the function of other networked components. In particular, systems relevant to safety could also be affected. As a result, these may no longer function as intended and/or jeopardize the operating safety of the vehicle. There is an increased risk of an accident and injury.

Never tamper with the wiring as well as electronic components or their software. You should have all work to electrical and electronic equipment carried out at a qualified specialist workshop.

**!** There is a risk of damage to the vehicle if:

- the vehicle becomes stuck, e.g. on a high curb or an unpaved road
- you drive too fast over an obstacle, e.g. a curb or a hole in the road
- a heavy object strikes the undercarriage or parts of the chassis.

In situations like this, the body, the undercarriage, chassis parts, wheels or tires could be damaged without the damage being visible. Components damaged in this way can unexpectedly fail or, in the case of an accident, no longer withstand the strain they are designed to.

If the underbody paneling is damaged, combustible materials such as leaves, grass or twigs can gather between the underbody and the underbody paneling. If these materials come in contact with hot parts of the exhaust system for an extended period, they can catch fire.

Have the vehicle checked and repaired immediately at a qualified specialist workshop. If on continuing your journey you notice that driving safety is impaired, pull over and stop the vehicle immediately, paying attention to road and traffic conditions. In such cases, visit a qualified specialist workshop.

## Declarations of conformity

### Vehicle components which receive and/or transmit radio waves

**USA:** "The wireless devices of this vehicle comply with Part 15 of the FCC Rules. Operation is subject to the two following two conditions: 1) These devices may not cause harmful interference, and 2) These devices

must accept any interference received, including interference that may cause undesired operation. Changes or modifications not expressly approved by the party responsible for compliance could void the user's authority to operate the equipment."

**Canada:** "The wireless devices of this vehicle comply with Industry Canada license-exempt RSS standard(s). Operation is subject to the following two conditions: (1) These devices may not cause interference, and (2) These devices must accept any interference, including interference that may cause undesired operation of the device."

## Diagnostics connection

The diagnostics connection is only intended for the connection of diagnostic equipment at a qualified specialist workshop.

### WARNING

If you connect equipment to the diagnostics connection in the vehicle, it may affect the operation of the vehicle systems. As a result, the operating safety of the vehicle could be affected. There is a risk of an accident.

Do not connect any equipment to a diagnostics connection in the vehicle.

### WARNING

Objects in the driver's footwell can restrict the pedal travel or obstruct a depressed pedal. The operating and road safety of the vehicle is jeopardized. There is a risk of an accident.

Make sure that all objects in the vehicle are stowed correctly, and that they cannot enter the driver's footwell. Install the floor mats securely and as specified in order to ensure sufficient clearance for the pedals. Do not use loose floor mats.

**!** If the engine is switched off and equipment on the diagnostics connection is used, the starter battery may discharge.

Connecting equipment to the diagnostics connection can lead to emissions monitoring information being reset, for example. This may lead to the vehicle failing to meet the requirements of the next emissions test during the main inspection.

### Qualified specialist workshop

An authorized Mercedes-Benz Center is a qualified specialist workshop. It has the necessary specialist knowledge, tools and qualifications to correctly carry out the work required on your vehicle. This is especially the case for work relevant to safety.

Observe the notes in the Maintenance Booklet.

Always have the following work carried out at an authorized Mercedes-Benz Center:

- work relevant to safety
- service and maintenance work
- repair work
- alterations, installation work and modifications
- work on electronic components

### Problems with your vehicle

If you should experience a problem with your vehicle, particularly one that you believe may affect its safe operation, we urge you to contact an authorized Mercedes-Benz Center immediately to have the problem diagnosed and rectified. If the problem is not resolved to your satisfaction, please discuss the problem again with a Mercedes-Benz Center or contact us at one of the following addresses.

#### In the USA

Customer Assistance Center  
Mercedes-Benz USA, LLC  
One Mercedes Drive  
Montvale, NJ 07645-0350

#### In Canada

Customer Relations Department

Mercedes-Benz Canada, Inc.  
98 Vanderhoof Avenue  
Toronto, Ontario M4G 4C9

### Reporting safety defects

USA only:

The following text is published as required of manufacturers under Title 49, Code of U.S. Federal Regulations, Part 575 pursuant to the "National Traffic and Motor Vehicle Safety Act of 1966".

If you believe that your vehicle has a defect which could cause a crash or could cause injury or death, you should immediately inform the National Highway Traffic Safety Administration (NHTSA) in addition to notifying Mercedes-Benz USA, LLC.

If NHTSA receives similar complaints, it may open an investigation, and if it finds that a safety defect exists in a group of vehicles, it may order a recall and remedy campaign. However, NHTSA cannot become involved in individual problems between you, your dealer, or Mercedes-Benz USA, LLC.

To contact NHTSA, you may call the Vehicle Safety Hotline toll-free at 1-888-327-4236 (TTY: 1-800-424-9153); go to <http://www.safercar.gov>; or write to: Administrator, NHTSA, 400 Seventh Street, SW., Washington, DC 20590.

You can also obtain other information about motor vehicle safety from

<http://www.safercar.gov>

### Limited Warranty

**I** Follow the instructions in this manual about the proper operation of your vehicle as well as about possible vehicle damage. Damage to your vehicle that arises from culpable contraventions against these instructions is not covered either by the Mercedes-Benz Limited Warranty or by the New or Used-Vehicle Warranty.

## Data stored in the vehicle

### Information about electronic data acquisition in the vehicle

(Including notice pursuant to California Code § 9951)

Your vehicle records electronic data. If your vehicle is equipped with mbrace (Canada: TELE AID), data is transmitted in the event of an accident.

This information helps, for example, to test vehicle systems after an accident and to continually improve vehicle safety.

Daimler AG can access this data and submit it:

- for safety research or vehicle diagnosis purposes
- with the consent of the vehicle owner
- on the instruction of prosecuting authorities
- for use in arbitration of disputes that involve Daimler AG, its affiliates or its sales and service organizations
- as otherwise required or permitted by law.

Please check your mbrace (Canada: TELE AID) purchase agreement to find out more about data that can be recorded and transmitted by this system.

## Information on copyright

### General information

Information on license for free and open-source software used in your vehicle and its electronic components is available on the following website:

<http://www.mercedes-benz.com/opensource>



Dashboard .....	30
Instrument cluster .....	31
Multifunction steering wheel .....	33
Center console .....	34
Overhead control panel .....	37
Door control panel .....	38

## Dashboard

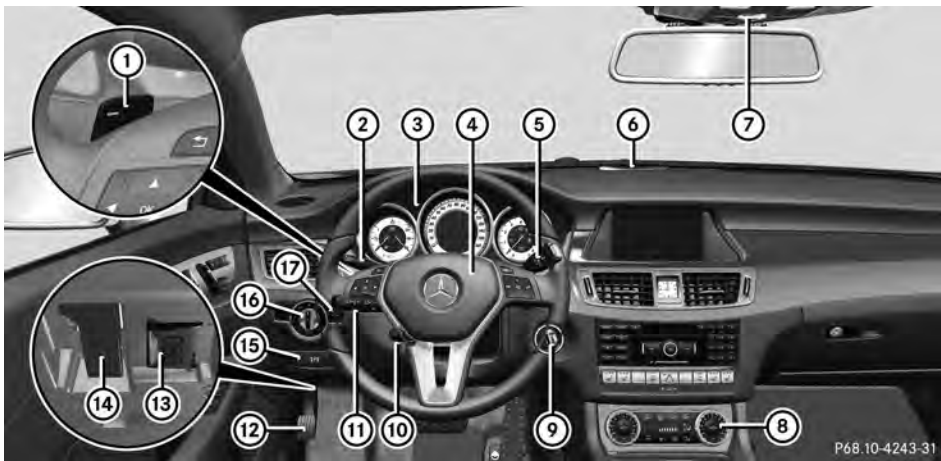

	Function	Page
①	Steering wheel paddle shifters	160
②	Cruise control lever	176
③	Instrument cluster	31
④	Horn	
⑤	DIRECT SELECT lever	155
⑥	PARKTRONIC warning display	193
⑦	Overhead control panel	37
⑧	Climate control systems	130
⑨	Ignition lock Start/Stop button	147 147

	Function	Page
⑩	Adjusts the steering wheel Steering wheel heating	106 107
⑪	Combination switch	119
⑫	Parking brake	169
⑬	Diagnostics connection	25
⑭	Opens the hood	306
⑮	Releases the parking brake	169
⑯	Light switch	116
⑰	Night View Assist Plus	204



## Instrument cluster

## Displays

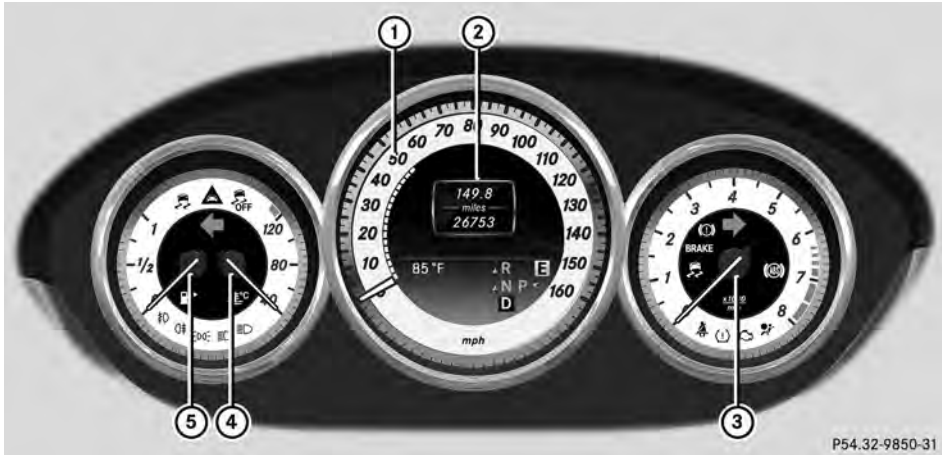

P54.32-9850-31

	Function	Page
①	Speedometer with segments	220
②	Multifunction display	221
③	Tachometer	219

	Function	Page
④	Coolant temperature	219
⑤	Fuel gauge	

- i** Adjust the instrument cluster lighting using the on-board computer (▷ page 230).

## Warning and indicator lamps

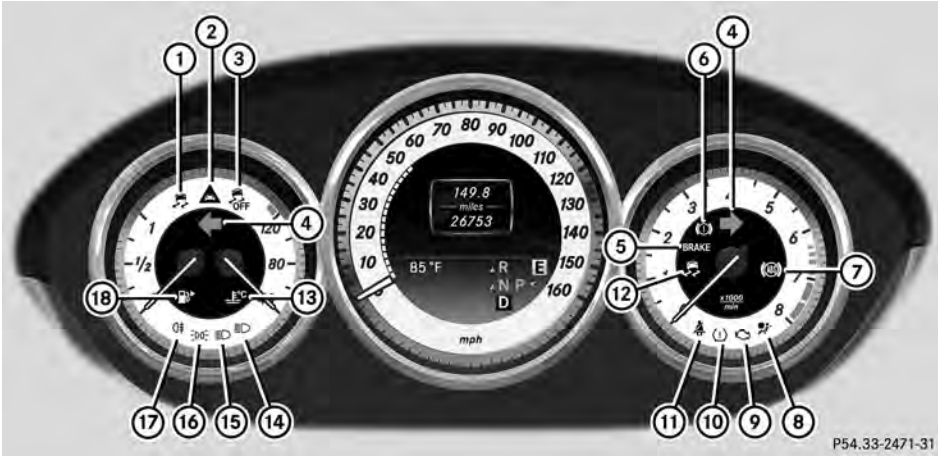





P54.33-2471-31





	Function	Page
①	ESP® SPORT handling mode in AMG vehicles	269 270
②	Distance warning	275
③	ESP® OFF	269
④	Turn signals	119
⑤	Brakes (USA only)	266
⑥	Brakes (Canada only)	266
⑦	ABS	267
⑧	SRS	272
⑨	Check Engine	273
⑩	Tire pressure monitor	276

	Function	Page
⑪	Seat belt	265
⑫	ESP® in AMG vehicles	270
⑬	Coolant	273
⑭	High-beam headlamps	119
⑮	Low-beam headlamps	118
⑯	Parking lamps	118
⑰	This lamp has no function	
⑱	Reserve fuel	273

Multifunction steering wheel



	Function	Page
①	Multifunction display	221
②	COMAND display; see the separate operating instructions	
③	 Switches on the Voice Control System; see the separate operating instructions	
④	 Rejects or ends a call Exits phone book/redial memory  Makes or accepts a call Switches to the redial memory  Adjusts the volume  Mute	226





	Function	Page
⑤	 Selects a menu  Selects a submenu or scrolls through lists  Confirms your selection Hides display messages	220 220 220 237
⑥	 Back Switches off the Voice Control System; see the separate operating instructions	220

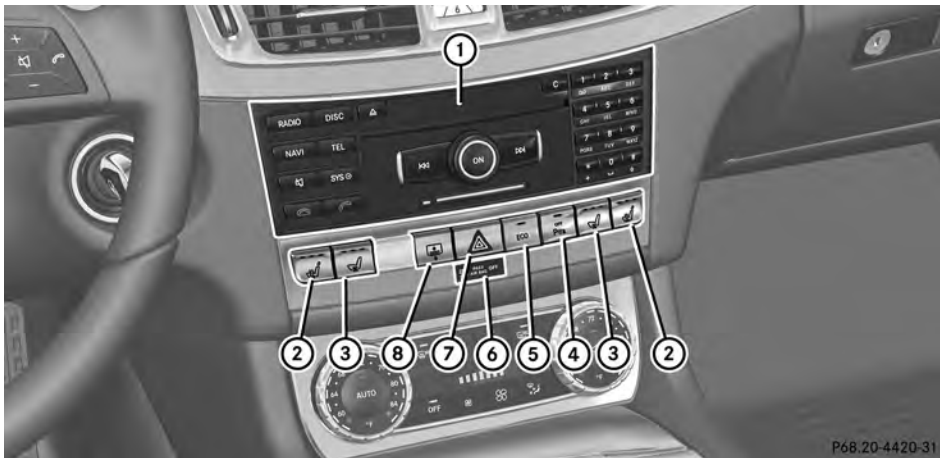



## Center console

## Center console, upper section





P68.20-4420-31

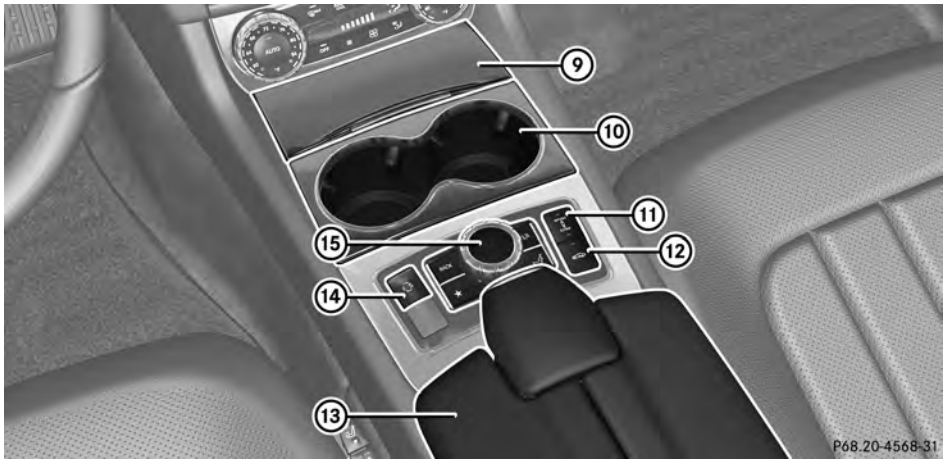

	Function	Page
①	COMAND; see the separate operating instructions	
②	 Seat heating	104
③	 Seat ventilation	105
④	 PARKTRONIC	193
⑤	 ECO start/stop function (AMG vehicles)	150

	Function	Page
⑥	  Indicator lamp	47
⑦	 Hazard warning lamps	120
⑧	 Roller sunblind in the rear window	287

## Center console, lower section



	Function	Page
⑨	Stowage compartment	278
	Ashtray	287
	Cigarette lighter	288
	Socket	289
	Cup holder	284
⑩	Cup holder	284
⑪	 Sets the suspension tuning	190

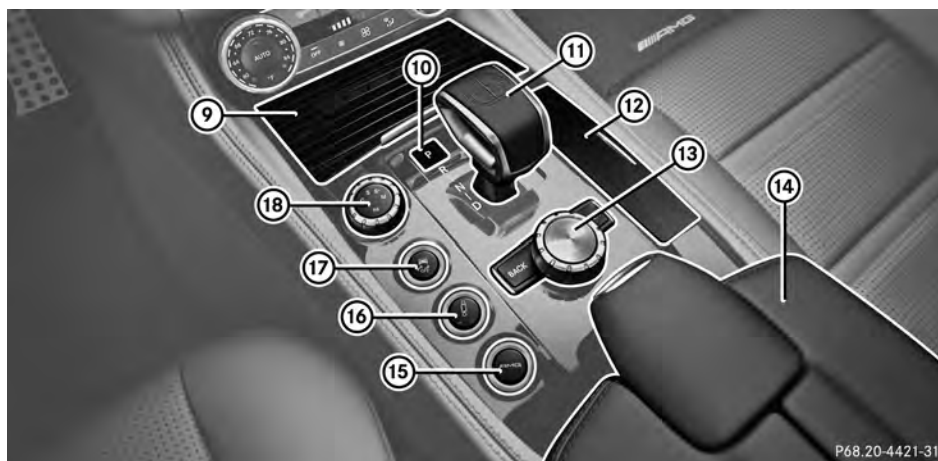

	Function	Page
⑫	 Sets the vehicle level	189
⑬	Stowage compartment	278
⑭	 Selects the drive program	159
⑮	COMAND controller; see the separate operating instructions	

## Center console, lower section (AMG vehicles)



P68.20-4421-31

	Function	Page
⑨	Cup holder	284
⑩	Engages parking position <b>P</b>	168
⑪	Selector lever	155
⑫	Ashtray	287
	Cigarette lighter	288
	Socket	289
⑬	COMAND controller; see the separate operating instructions	

	Function	Page
⑭	Stowage compartment	278
⑮	 Calls up/saves the suspension tuning	191
⑯	 Sets the suspension tuning	191
⑰	 ESP®	70
⑱	Drive program selector	159

## Overhead control panel

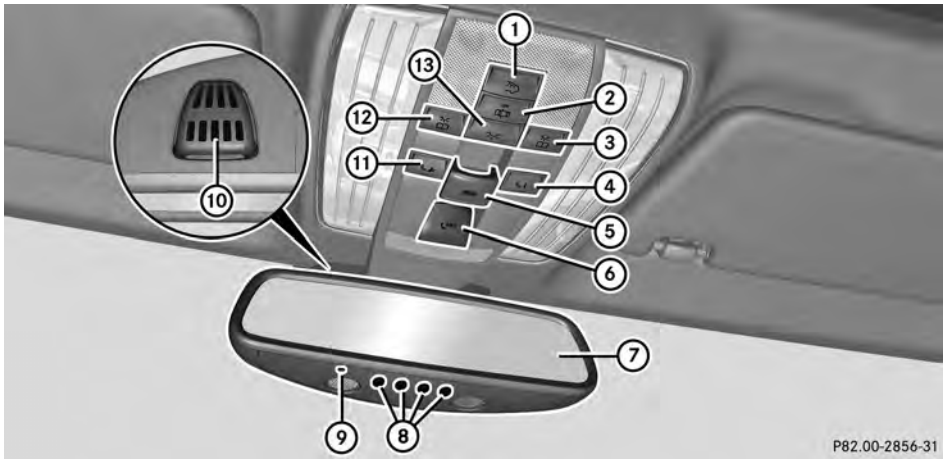

P82.00-2856-31

	Function	Page		Function	Page
①	Switches the rear interior lighting on/off	124	⑨	Integrated electronic compass	302
②	Switches the automatic interior lighting control on/off	124	⑩	Microphone for mbrace (emergency call system), telephone and Voice Control System; see the separate operating instructions	
③	Switches the right-hand reading lamp on/off	123	⑪	Roadside Assistance call button (mbrace system)	293
④	MB Info call button (mbrace system)	293	⑫	Switches the left-hand reading lamp on/off	123
⑤	Opens/closes the sliding sunroof	93	⑬	Switches the front interior lighting on/off	124
⑥	SOS button (mbrace system)	291			
⑦	Rear-view mirror	111			
⑧	Buttons for the garage door opener	299			

## Door control panel

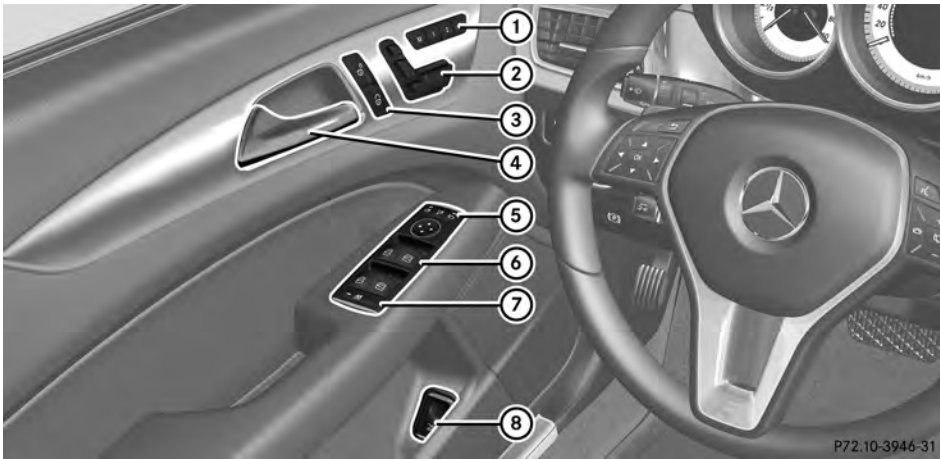

P72.10-3946-31

	Function	Page
①	<b>1</b> <b>2</b> <b>3</b> Stores settings for the seat, exterior mirrors and steering wheel	112
②	Adjusts the seats electrically	100
③	Unlocks/locks the vehicle	83
④	Opens the door	82
⑤	 Adjusts and folds the exterior mirrors in/out electrically	109

	Function	Page
⑥	Opens/closes the side windows	89
⑦	Activates/deactivates the override feature for the side windows in the rear compartment	65
⑧	Opens/closes the trunk lid	86



Useful information .....	40
Panic alarm .....	40
Occupant safety .....	40
Children in the vehicle .....	60
Driving safety systems .....	66
Theft deterrent locking system .....	73

### Useful information

- 1 This Operator's Manual describes all models and all standard and optional equipment of your vehicle available at the time of publication of the Operator's Manual. Country-specific differences are possible. Please note that your vehicle may not be equipped with all features described. This also applies to safety-related systems and functions.
- 1 Read the information on qualified specialist workshops: (▷ page 26).

### Panic alarm



- ▶ **To activate:** press **PANIC** button 1 for at least one second.  
An alarm sounds and the exterior lighting flashes.
  - ▶ **To deactivate:** press **PANIC** button 1 again.
- or
- ▶ Insert the SmartKey into the ignition lock.
- or
- ▶ Press the KEYLESS-GO Start/Stop button.  
The KEYLESS-GO key must be in the vehicle.

### Occupant safety

#### Important safety notes

#### ⚠ WARNING

Modifications to the restraint systems could result in them not functioning properly any more. The restraint systems could then no longer protect vehicle occupants as they are designed to do and could fail in the event of an accident or activate unexpectedly, for example. There is an increased risk of injury. Never modify parts of the restraint systems. Do not attempt to modify the wiring as well as electronic components or their software. If it is necessary to modify an air bag system to accommodate a person with disabilities, contact an authorized Mercedes-Benz center. USA only: for further information contact our Customer Assistance Center at 1-800-FOR-MERCEdes (1800-367-6372).

In this section, you will learn the most important facts about the restraint system components of the vehicle.

The restraint system consists of:

- Seat belts
- Child restraint systems
- LATCH-type (ISOFIX) child seat securing system

Additional protection is provided by:

- SRS (Supplemental Restraint System)
- NECK-PRO head restraints/NECK-PRO luxury head restraints
- PRE-SAFE®
- Air bag system components with:
  - PASSENGER AIR BAG OFF indicator lamp
  - Front-passenger seat with Occupant Classification System (OCS)

The different air bag systems work independently of each other. The protective functions of the system work in conjunction with each other. Not all air bags are deployed in an accident.

- i** For information on infants and children traveling with you in the vehicle as well as restraint systems for infants and children, see "Children in the vehicle" (▷ page 60).

## SRS (Supplemental Restraint System)

### Introduction

RS consists of:

- The  RS warning lamp
- Air bags
- The air bag control unit with crash sensors
- Emergency Tensioning Device for the front seat belts and the outer seat belts in the rear
- Seat belt force limiters for the front seat belts and the outer seat belts in the rear

RS reduces the risk of occupants coming into contact with the vehicle's interior in the event of an accident. It can also reduce the effect of the forces to which occupants are subjected during an accident.

### SRS warning lamp

#### WARNING

If SRS is malfunctioning, child restraint system components may be triggered unintentionally or might not be triggered at all in the event of an accident with a high rate of vehicle deceleration. There is an increased risk of injury, possibly even fatal.



Have SRS checked and repaired immediately at a qualified specialist workshop.

SRS functions are checked regularly when you switch on the ignition and when the engine is running. Therefore, malfunctions can be detected in good time.

The  SRS warning lamp in the instrument cluster lights up when the ignition is switched on. It goes out no later than a few seconds after the engine is started.

The SRS components are in operational readiness when the  SRS indicator lamp goes out while the engine is running.

There is a malfunction if:

- the  SRS warning lamp does not light up when the ignition is switched on
- the engine is running and the  SRS indicator lamp does not go out after a few seconds
- the engine is running and the  SRS warning lamp lights up again.

### Safety guidelines for seat belts, Emergency Tensioning Devices (ETDs) and air bags

#### WARNING

- Damaged seat belts or seat belts that have been subjected to stress in an accident must be replaced. Their anchoring points must also be checked. Only use seat belts installed or supplied by an authorized Mercedes-Benz Center.
- Air bags and pyrotechnic Emergency Tensioning Devices (ETDs) contain perchlorate material, which may require special handling and regard for the environment. Check your national disposal guidelines. California residents, see [www.dtsc.ca.gov/HazardousWaste/Perchlorate/index.cfm](http://www.dtsc.ca.gov/HazardousWaste/Perchlorate/index.cfm).
- Air bags and ETDs are designed to function on a one-time-only basis. An air bag or ETD that has deployed must be replaced. PRE-SAFE® has electrically operated reversible belt tensioners in addition to the pyrotechnic ETDs.
- Do not pass seat belts over sharp edges. They could tear.
- Do not make any modification that could change the effectiveness of the seat belts.
- Do not bleach or dye seat belts as this may severely weaken them. In a crash they may not be able to provide adequate protection.

- No modifications of any kind may be made to any components or wiring of the SRS.
- Do not change or remove any component or part of the SRS.
- Do not install additional trim material, seat covers, badges, etc. to the:
  - padded steering wheel boss
  - knee bag covers
  - front-passenger air bag cover
  - outer side of front seat bolsters
  - side trim next to the rear seat backrest
  - roof lining trim
- Do not install additional electrical/ electronic equipment on or near SRS components and wiring.
- Keep area between air bags and occupants free of objects (e.g. packages, purses, umbrellas, etc.).
- Do not hang items such as coat hangers from the coat hooks or handles over the door. These items may be thrown around in the vehicle and cause head and other injuries when the window curtain air bag is deployed.
- Air bag system components will be hot after an air bag has inflated. Do not touch them.
- Never place your feet on the instrument panel, dashboard, or on the seat. Always keep both feet on the floor in front of the seat.
- Improper repair work on the SRS creates a risk of rendering the SRS inoperative or causing unintended air bag deployment. Work on the SRS must therefore only be performed by qualified technicians. Contact an authorized Mercedes-Benz Center.
- For your protection and the protection of others, when scrapping the air bag unit or ETD, our safety instructions must be followed. These instructions are available

from any authorized Mercedes-Benz Center.

- Given the considerable deployment speed, required inflation volume, and the material of the air bags, there is the possibility of abrasions or other, potentially more serious injuries resulting from air bag deployment.

If you sell your vehicle, Mercedes-Benz strongly recommends that you inform the subsequent owner that the vehicle is equipped with SRS. Also, refer them to the applicable section in the Operator's Manual.

### Air bags

#### Important safety notes

##### WARNING

If you modify the air bag covers or affix objects such as stickers to them, the air bags may not function correctly. There is an increased risk of injury.

Never modify the air bag covers or affix objects to them.

##### WARNING

Using unsuitable seat covers could restrict or even prevent deployment of the air bags integrated into the seats. Consequently, the air bags cannot protect vehicle occupants as they are designed to do. In addition, the function of the air bag deactivation system could be restricted. This poses an increased risk of injury or even fatal injury.

You should only use seat covers that have been approved for the respective seat by Mercedes-Benz.

##### WARNING

The air bag parts are hot after the airbag has been deployed. There is a risk of injury.

Do not touch the air bag parts. Have the deployed air bags replaced at a qualified specialist workshop as soon as possible.

 **WARNING**

Air bags are designed to reduce the incidence of injuries and fatalities in certain situations:

- frontal impacts (driver's and front-passenger front air bags and knee bags)
- side impacts (side impact air bags, window curtain air bags and pelvis air bags)
- rollover (window curtain air bags)

However, no system available today can completely eliminate injuries and fatalities.

When the air bags are deployed, a small amount of powder is released. The powder generally does not constitute a health hazard and does not indicate that there is a fire in the vehicle. In order to prevent potential breathing difficulties, you should leave the vehicle as soon as it is safe to do so. If you have any breathing difficulty but cannot get out of the vehicle after the air bag inflates, then get fresh air by opening a window or door.

 **WARNING**

In order to reduce the potential danger of injuries caused during the deployment of the front air bags, the driver and front passenger must always be correctly seated and wear their seat belts.

For maximum protection in the event of a collision, you must always be in the normal seat position with your back against the backrest. Fasten your seat belt and make sure that it is correctly positioned on your body.

As the air bag inflates with considerable speed and force, a proper seating position and correct positioning of the hands on the steering wheel will help to keep you at a safe distance from the air bag. Occupants who are not wearing their seat belt, are not seated properly or are too close to the air bag can be seriously injured or killed by an air bag, as it inflates with great force instantaneously:

- sit with the seat belt fastened correctly and in a position that is as upright as possible with your back against the backrest.
- move the driver's seat as far back as possible, still permitting proper operation of vehicle controls. The distance from the center of the driver's chest to the center of the air bag cover on the steering wheel must be at least 10 inches (25 cm). You should be able to accomplish this by adjusting the seat and steering wheel. If you have any difficulties, please contact an authorized Mercedes-Benz Center.
- do not lean your head or chest close to the steering wheel or dashboard.
- only hold the steering wheel on the outside. Placing hands and arms inside the rim can increase the risk and potential severity of hand/arm injury if the driver front air bag inflates.
- adjust the front-passenger seat as far back as possible from the dashboard when the seat is occupied.
- occupants, especially children, should never place their bodies or lean their heads in the area of the door where the side impact air bag inflates. This could result in serious or fatal injuries should the side impact air bag be deployed. Always sit as upright as possible, wear the seat belt properly and use an appropriately sized infant restraint, toddler restraint or booster seat recommended for the size and weight of the child.

Failure to follow these instructions can result in severe injuries to you or other occupants.

If you sell your vehicle, it is important that you make the buyer aware of this safety information. Be sure to give the buyer this Operator's Manual.

If the air bags are deployed, you will hear a bang, and a small amount of powder may also be released. Only in rare cases will the bang affect your hearing. The powder that is released generally does not constitute a health hazard and does not indicate that there is a fire in the vehicle. The dust might cause some temporary breathing difficulty for people with asthma or other breathing trouble. To avoid this, you may wish to get out of the vehicle as soon as it is safe to do so. You can also open the window to allow fresh air to enter the vehicle interior. The  SRS warning lamp lights up.

The air bag installation locations are identified by the AIR BAG symbol.

The air bags are deployed if the air bag control unit detects the need for deployment. Only in the event of such a situation will the air bags provide their supplemental protection.

If the driver and front passenger do not wear their seat belts, it is not possible for the air bags to provide their supplemental protection.

In the event of other types of impacts and impacts below air bag deployment thresholds, the air bags will not deploy. The driver and passenger will then be protected to the extent possible by a properly fastened seat belt. A properly fastened seat belt is also needed to provide the best possible protection in a rollover.

Air bags provide additional protection; they are not, however, a substitute for seat belts. All vehicle occupants must fasten their seat belts regardless of whether your vehicle is equipped with air bags or not.

It is important for your safety and that of your passenger to have deployed air bags replaced and to have any malfunctioning air bags repaired. This will help to make sure the air bags continue to perform their protective

function for the vehicle occupants in the event of a crash.

- i** After an air bag has been deployed, have the vehicle towed to the nearest qualified specialist workshop, even if your vehicle is ready to drive.

## Front air bags



Driver's air bag ① deploys in front of the steering wheel; front-passenger front air bag ② deploys in front of and above the glove box.

The front air bags increase protection for the driver's and front passenger's head and chest.

They are deployed:

- at the start of an accident with a high rate of vehicle acceleration or deceleration in a longitudinal direction
- in the event of certain frontal impacts
- if the system determines that air bag deployment can offer additional protection to that provided by the seat belt
- depending on whether the seat belt is being used
- independently of other air bags in the vehicle

If the vehicle rolls over, the front air bags are generally not deployed.

Your vehicle has adaptive, two-stage front air bags. The air bag control unit evaluates vehicle deceleration or acceleration in the event of a collision. In the first deployment stage, the front air bag is filled with part of the

total available propellant gas, thereby reducing the risk of injury. If the air bag control unit recognizes within a few milliseconds that the vehicle is being braked or accelerated faster than originally predicted, the front air bag is filled with the maximum amount of propellant gas available.

The deployment of the front-passenger front air bag is also influenced by the weight category of the front passenger, which is determined by the Occupant Classification System (OCS) (▷ page 47).

The lighter the passenger-side occupant, the higher the vehicle deceleration rate required (predicted at the start of the impact) for second-stage inflation of the front-passenger front air bag. In the second stage, the front air bags are inflated with the maximum amount of propellant gas available.

The front air bags are not deployed in situations where a low impact severity is predicted. You will then be protected by the fastened seat belt.

The front-passenger front air bag will only deploy if:

- the system, based on the OCS weight sensor readings, detects that the front-passenger seat is occupied
- the PASSENGER AIR BAG OFF indicator lamp on the center console is not lit (▷ page 47)
- the air bag control unit predicts a high impact severity

### Knee bags



Driver's knee bag ① deploys underneath the steering column and front-passenger knee bag ② underneath the glove box. They deploy together with the front air bags. They are designed to operate together with the front air bags in frontal impacts if certain thresholds are exceeded. The knee bags operate at best in conjunction with correctly positioned and fastened seat belts.

Knee bags provide increased protection for the driver and front passenger against the risk of:

- knee injuries
- thigh injuries
- lower leg injuries

### Side impact air bags

#### WARNING

Using unsuitable seat covers could restrict or even prevent deployment of the air bags integrated into the seats. Consequently, the air bags cannot protect vehicle occupants as they are designed to do. In addition, the function of the air bag deactivation system could be restricted. This poses an increased risk of injury or even fatal injury.

You should only use seat covers that have been approved for the respective seat by Mercedes-Benz.

#### WARNING

Sensors to control the air bags are located in the doors. Modifications or work not performed correctly to the doors or door paneling, as well as damaged doors, can lead to the function of the sensors being impaired. The air bags might therefore not function properly any more. Consequently, the air bags cannot protect vehicle occupants as they are designed to do. There is an increased risk of injury.

Never modify the doors or parts of the doors. Always have work on the doors or door paneling carried out at a qualified specialist workshop.

You should only use seat cover that have been approved for your vehicle by Mercedes-Benz. The seat covers must have a special tear seam for side impact air bags. Otherwise, the side impact air bags cannot deploy correctly and therefore cannot provide the intended protection in the event of an accident.



Front side impact air bags ① and rear side impact air bags ② deploy next to the outer seat cushions.

When deployed, the side impact air bags offer additional protection for the thorax of the vehicle occupants on the side of the vehicle on which the impact occurs. However, they do not protect the:

- head
- neck
- arms

The side impact air bags are deployed:

- on the side on which an impact occurs
- at the start of an accident with a high rate of lateral vehicle deceleration or acceleration, e.g. in a side impact
- independently of the use of the seat belt
- independently of the front air bags
- independently of the ETDs

If the vehicle rolls over, the side impact air bags are generally not deployed. Side impact air bags are deployed if the system detects high vehicle deceleration or acceleration in a lateral direction and determines that side impact air bag deployment can offer additional protection to that provided by the seat belt.

Side impact air bags will not deploy in side impacts which do not exceed the system's preset deployment thresholds for lateral acceleration/deceleration. You will then be protected by the fastened seat belt.

The side impact air bag on the front-passenger side is not deployed in the following situations:

- OCS has detected that the front-passenger seat is unoccupied.
- the front-passenger seat belt is not fastened.

The side impact air bag on the front-passenger side will deploy if the front-passenger seat belt is fastened, regardless of whether the front-passenger seat is occupied or not.

## Pelvis air bags

### WARNING

Only use seat covers which have been tested and approved by Mercedes-Benz for your vehicle model. Using seat covers or other seat coverings can cause a malfunction of the side impact air bags and/or the pelvis air bags. Contact an authorized Mercedes-Benz Center for availability.



Pelvis air bags ① enhance the level of protection of the vehicle occupants on the side of the vehicle on which the impact occurs.



The pelvis air bags deploy next to and below the outer seat cushions. They are deployed:

- on the side on which an impact occurs
- at the start of an accident with a high rate of lateral vehicle deceleration or acceleration, e.g. in a side impact
- independently of the use of the seat belt
- independently of the front air bags
- independently of the ETDs

If the vehicle rolls over, the pelvis air bags are generally not deployed. Exception: if the system detects high vehicle deceleration or acceleration in a lateral direction and determines that deployment can offer additional protection to that provided by the seat belt.

Pelvis air bags ① will not deploy in side impacts which do not exceed the system's preset deployment thresholds for lateral acceleration/deceleration. You will then be protected by the fastened seat belt.

The pelvis air bag on the front-passenger side is not deployed in the following situations:

- OCS has detected that the front-passenger seat is unoccupied.
- the front-passenger seat belt is not fastened.

The pelvis air bag on the front-passenger side will deploy if the front-passenger seat belt is fastened, regardless of whether the front-passenger seat is occupied or not.

### Window curtain air bags

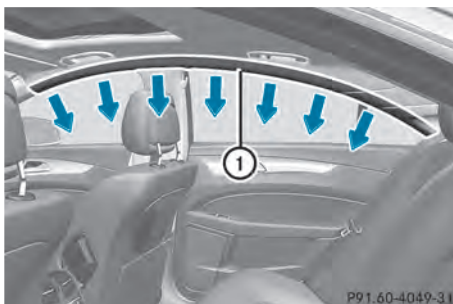

Window curtain air bags ① enhance the level of protection for the head, but not chest or arms, of the vehicle occupants on the side of the vehicle on which the impact occurs.

The window curtain air bags are integrated into the side of the roof frame and deploy in the area from the A-pillar to the C-pillar.

Window curtain air bags are deployed:



- at the start of an accident with a high rate of lateral vehicle deceleration or acceleration, e.g. in a side impact
- on the side on which an impact occurs
- on the driver's side and passenger side, in the event of a vehicle rollover and if the system determines that air bag deployment can offer the vehicle occupants additional protection to that provided by the seat belt
- independently of the use of the seat belt
- regardless of whether the front-passenger seat is occupied
- independently of the front air bags

Window curtain air bags ① will not deploy in the event of impacts which do not exceed the system's preset deployment thresholds for vehicle acceleration/deceleration. You will then be protected by the fastened seat belt.

### Occupant Classification System (OCS)

#### Method of operation

#### WARNING



If the  indicator lamp illuminates when an adult or someone larger than a small individual is in the front-passenger seat, have the front passenger reposition himself or herself in the seat until the  indicator lamp goes out.

In the event of a collision, the air bag control unit will not allow front-passenger front air bag deployment when the OCS has classified the front-passenger seat occupant as weighing as much as or less than a typical 12-month-old child in a standard child restraint

or if the front-passenger seat is classified as being empty.

When the OCS senses that the front-passenger seat occupant is classified as being up to or less than the weight of a typical 12-month-old child in a standard child restraint, the  indicator lamp will illuminate when the engine is started and remain illuminated, indicating that the front-passenger front air bag is deactivated.

When the OCS senses that the front-passenger seat is classified as being empty, the  indicator lamp will illuminate when the engine is started and remain illuminated, indicating that the front-passenger front air bag is deactivated.

When the OCS senses that the front-passenger seat occupant is classified as being heavier than the weight of a typical 12-month-old child seated in a standard child restraint or as being a small individual (such as a young teenager or a small adult), the  indicator lamp will illuminate for approximately 6 seconds when the engine is started and then, depending on occupant weight sensor readings from the front-passenger seat, remain illuminated or go out. With the  indicator lamp illuminated, the front-passenger front air bag is deactivated. With the  indicator lamp out, the front-passenger front air bag is activated.

When the OCS senses that the front-passenger seat occupant is classified as an adult or someone larger than a small individual, the  indicator lamp will illuminate for approximately 6 seconds when the engine is started and then go out, indicating that the front-passenger front air bag is activated.

If the  indicator lamp is illuminated, the front-passenger front air bag and the front-passenger knee bag are deactivated and will not be deployed.

If the  indicator lamp is not illuminated, the front-passenger front air bag and the front-passenger knee bag are activated and will be deployed:

- in the event of certain frontal impacts
- if impact exceeds a preset deployment threshold
- independently of the side impact air bag or pelvis air bag

If the front-passenger front air bag is deployed, the rate of inflation will be influenced by:

- the rate of relevant vehicle deceleration as assessed by the air bag control unit
- the front passenger's weight category as identified by OCS

### WARNING





According to accident statistics, children are safer when properly restrained on the rear seats than on the front-passenger seat. Thus, we strongly recommend that children be placed in the rear seats whenever possible. Regardless of seating position, children 12 years old and under must be seated and properly secured in an appropriate infant restraint, toddler restraint, or booster seat recommended for the size and weight of the child.

The infant or child restraint must be properly secured with the vehicle's seat belt, the seat belt and Top Tether strap, or lower LATCH-type (ISOFIX) child seat retaining loops and Top Tether strap, fully in accordance with the infant or child seat manufacturer's instructions.

Occupants, especially children, should always sit as upright as possible, wear the seat belt properly and use an appropriately sized infant restraint, toddler restraint, or booster seat recommended for the size and weight of the child.



Children can be killed or seriously injured by an inflating air bag.

Note the following important information if it is necessary to carry a child on the front-passenger seat:

- Your vehicle is equipped with air bag technology designed to deactivate the front-passenger front air bag and the front-passenger knee bag in your vehicle when the system senses the weight of a typical 12-month-old child or less along with the weight of a standard appropriate child restraint on the front-passenger seat.
- A child in a rear-facing child restraint on the front-passenger seat will be seriously injured or even killed if the front-passenger front air bag inflates in a collision which could occur under some circumstances, even with the air bag technology installed in your vehicle. The only means to eliminate this risk completely is never to place a child in a rear-facing child restraint in the front-passenger seat. We therefore strongly recommend that you always place a child in a rear-facing child restraint on the rear seat.
- If you install a rear-facing child restraint on the front-passenger seat, make sure the  indicator lamp is illuminated, indicating that the front-passenger front air bag and front-passenger knee bag are deactivated. Should the  indicator lamp not illuminate or go out while the restraint is installed, please check installation. Periodically check the  indicator lamp while driving to make sure that the  indicator lamp is illuminated. If the  indicator lamp goes out or remains out, do not transport a child on the front-passenger seat until the system has been repaired. A child in a rear-facing child restraint on the front-passenger seat could be seriously injured or even killed if the front-passenger front air bag is deployed.

- If you place a child in a forward-facing child restraint on the front-passenger seat:
  - move the seat as far back as possible
  - use the proper child restraint recommended for the age, size and weight of the child
  - secure child restraint with the vehicle's seat belt according to the child seat manufacturer's instructions
- For children larger than the typical 12-month-old child, the front-passenger front air bag and the front-passenger knee bag may or may not be activated.

### WARNING

If the red  SRS warning lamp in the instrument cluster and the  indicator lamp light up simultaneously, the OCS is malfunctioning. The front passenger front air bag and the front passenger knee bag will be deactivated in this case. Have the system checked by qualified technicians as soon as possible. Contact an authorized Mercedes-Benz Center.

Only have the seat repaired or replaced at an authorized Mercedes-Benz Center.

In order to ensure proper operation of the air bag system and OCS:

- Sit with the seat belt properly fastened in a position that is as upright as possible with your back against the seat backrest.
- When seated, a passenger should not position him/herself in such a way as to cause the passenger's weight to be lifted from the seat cushion as this may result in the OCS being unable to correctly approximate the passenger's weight category.
- Read and observe all warnings in this chapter.



If the SmartKey is removed from the ignition lock or is in position **0**, PASSENGER AIR BAG OFF indicator lamp ① does not light up.

The Occupant Classification System (OCS) categorizes the occupant on the front-passenger seat using a weight sensor. The front-passenger front air bag is deactivated automatically for certain weight categories. The PASSENGER AIR BAG OFF indicator lamp shows you the current status.

Occupant Classification System (OCS) categorizes the occupant on the front-passenger seat using a weight sensor.

The front-passenger front air bag and the front-passenger knee bag are deactivated automatically for certain weight categories. The PASSENGER AIR BAG OFF indicator lamp shows you the current status.

If the PASSENGER AIR BAG OFF indicator lamp lights up, the front-passenger front air bag and the front-passenger knee bag are disabled.

The system does not deactivate:

- the side impact air bag
- the pelvis air bag
- the window curtain air bag
- the Emergency Tensioning Devices

To be classified correctly, the front passenger must sit:

- with the seat belt fastened correctly
- in a position that is as upright as possible with their back against the seat backrest
- with their feet on the floor

The OCS weight sensor reading is affected if the occupant's weight is transferred, e.g. by leaning on the armrest.

If the front-passenger seat, the seat cover or the seat cushion are damaged, have the necessary repair work carried out at a qualified specialist workshop.

For safety reasons, Mercedes-Benz recommends that you only use seat accessories that have been approved by Mercedes-Benz.

Both the driver and the front passenger should always observe the PASSENGER AIR BAG OFF indicator lamp as an indication of whether or not the front passenger is positioned correctly. Observe also the air bag display messages that can be displayed in the instrument cluster (▷ page 244).

If the driver's air bag deploys, this does not mean that the front-passenger front air bag will also deploy.

The OCS may have detected that the seat:

- is empty or occupied by the weight of a typical child up to twelve months old, seated in a child restraint system
- is occupied by a small individual, such as a young teenager or a small adult
- is occupied by a child in a child restraint system whose weight is greater than that of a typical twelve month old child.

These are examples of when the OCS deactivates the front-passenger front air bag and front-passenger knee bag. Deactivation takes place although the collision fulfills the criteria for deploying the driver's air bag.

For further information, see "Air bag display messages" (▷ page 244).

### System self-test

#### WARNING

If the  indicator lamp does not illuminate, the system is not functioning. You must contact an authorized Mercedes-Benz

Center before seating any child on the front passenger seat.

 **WARNING**

Objects between the seat surface and the child restraint system could affect the function of the OCS. This could result in the front-passenger front air bag not functioning as intended during an accident. This poses an increased risk of injury or even fatal injury.

Do not place any objects between the seat surface and the child restraint system. Make sure that the bottom and back of the child restraint system make full contact with the front-passenger seat cushion and backrest. Always comply with the child restraint system manufacturer's installation instructions.

The PASSENGER AIR BAG OFF indicator lamp lights up:

- if you turn the SmartKey in the ignition lock to position **1** or **2**
- if you press the KEYLESS-GO Start/Stop button once or twice on vehicles with KEYLESS-GO
- if an adult is seated properly on the front-passenger seat and the OCS classifies the occupant as an adult

The PASSENGER AIR BAG OFF indicator lamp goes out again after approximately six seconds.

If the seat is not occupied and the OCS system detects that the front-passenger seat is empty, the PASSENGER AIR BAG OFF indicator lamp will continue to light up. The PASSENGER AIR BAG OFF indicator lamp will not go out.

For more information about the OCS, see "Problems with the Occupant Classification System" (▷ page 52).

## Problems with the Occupant Classification System

### WARNING

If the  indicator lamp illuminates and remains illuminated when the weight of a typical adult or someone larger than a small individual has been detected on the passenger seat, do not allow any occupant to use the passenger seat until the system has been repaired.

### WARNING

If the  indicator lamp does not illuminate or remains out with the weight of a typical 12-month-old child in a standard child restraint or less, or is unoccupied, on the front-passenger seat, do not transport a child on the front-passenger seat until the system has been repaired.

Problem	Possible causes/consequences and ► Solutions
<p>The PASSENGER AIR BAG OFF indicator lights up and remains on.</p> <p>The person on the front-passenger seat:</p> <ul style="list-style-type: none"> <li>• has the weight of a typical adult</li> <li>• has been determined by the system not to be a child</li> </ul>	<p>The COS is malfunctioning.</p> <ul style="list-style-type: none"> <li>► Make sure that the front passenger is sitting in a correct, upright position.</li> <li>► Have the COS checked as soon as possible at a qualified specialist workshop.</li> <li>► Observe the additional display messages in the multifunction display (► page 244).</li> </ul>

Problem	Possible causes/consequences and ► Solutions
<p>The PASSENGER AIR BAG OFF indicator lamp does not light up and/or does not stay on.</p> <p>The front-passenger seat is:</p> <ul style="list-style-type: none"> <li>• unoccupied</li> <li>• occupied with the weight of a child up to twelve months old in a child restraint system</li> </ul>	<p>The COS is malfunctioning.</p> <ul style="list-style-type: none"> <li>► Make sure there is nothing between the seat cushion and the child seat.</li> <li>► Make sure that the backrest and base of the child restraint system rest on the front-passenger seat. If necessary, adjust the position of the front-passenger seat.</li> <li>► When installing the child restraint system, make sure that the seat belt is tight. Do not pull the seat belt tight with the front-passenger seat adjustment. This could result in the seat belt being pulled too tightly.</li> <li>► Check the installation of the child restraint system.</li> <li>► Make sure that no objects are applying additional weight onto the seat.</li> <li>► If the PASSENGER AIR BAG OFF indicator lamp remains off, have the COS checked immediately at a qualified specialist workshop. Do not transport a child on the front-passenger seat until the COS has been repaired.</li> <li>► Observe the additional display messages in the multifunction display (▷ page 244).</li> </ul>

### NECK-PRO head restraints/NECK-PRO luxury head restraints

#### Important safety notes

#### WARNING

The function of the head restraint may be impaired if you:

- attach objects such as coat hangers to the head restraints, for example
- use head restraint covers

If you do so, the head restraints cannot fulfill their intended protective function in the event of an accident. In addition, objects attached to the head restraints could endanger other vehicle occupants. There is an increased risk of injury.

Do not attach any objects to the head restraints and do not use head restraint covers.

NECK-PRO head restraints/NECK-PRO luxury head restraints increase protection of the

driver's and front-passenger's head and neck. In the event of a rear collision of a certain severity, the NECK-PRO head restraints/NECK-PRO luxury head restraints on the driver's and the front-passenger seats are moved forwards and upwards. This provides better head support.

If the NECK-PRO head restraints/NECK-PRO luxury head restraints have been triggered in an accident, reset the NECK-PRO head restraints/NECK-PRO luxury head restraints on the driver's and front-passenger seats (▷ page 54). Otherwise, the additional protection will not be available in the event of another rear-end collision. NECK-PRO head restraints/NECK-PRO luxury head restraints that have been triggered are moved forwards and can no longer be adjusted.

Mercedes-Benz recommends that you have the NECK-PRO head restraints/NECK-PRO luxury head restraints checked at a qualified specialist workshop after a rear-end collision.

## Resetting triggered NECK-PRO head restraints/NECK-PRO luxury head restraints

Safety

### NECK-PRO head restraints

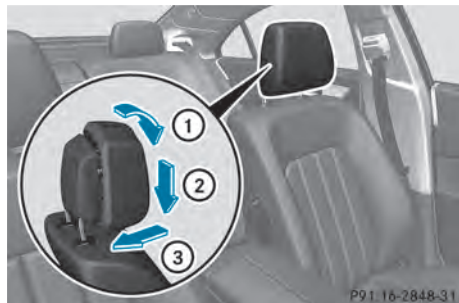

#### NECK-PRO head restraints

- ▶ Tilt the top of the NECK-PRO head restraint cushion forwards in the direction of arrow ①.
- ▶ Push the NECK-PRO head restraint cushion down in the direction of arrow ② as far as it will go.
- ▶ With your hand flat, firmly push the NECK-PRO head restraint cushion backwards in the direction of arrow ③ until it engages.
- ▶ Repeat this procedure for the second NECK-PRO head restraint.

### NECK-PRO luxury head restraints

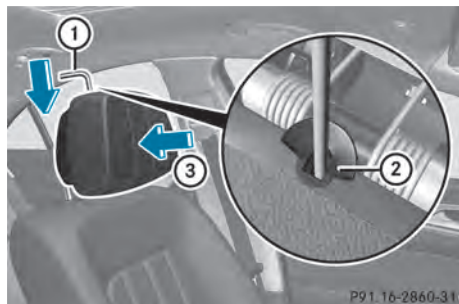

#### NECK-PRO luxury head restraints

- ▶ Remove resetting tool ① from the vehicle document wallet.
- ▶ Slide resetting tool ① into guide ② between the NECK-PRO luxury head

restraint and the rear cover of the head restraint.

- ▶ Push resetting tool ① downwards until you hear the head restraint deployment mechanism engage.
- ▶ Pull out resetting tool ①.
- ▶ With your hand flat, firmly push the NECK-PRO luxury head restraint cushion backwards in the direction of arrow ③ until it engages.
- ▶ Repeat this procedure for the second NECK-PRO luxury head restraint.
- ▶ Put resetting tool ① back into the vehicle document wallet.

**i** If you have difficulty resetting the NECK-PRO luxury head restraints, have this work carried out at a qualified specialist workshop.

### PRE-SAFE® (anticipatory occupant protection system)

**!** Make sure that there are no objects in the footwell or behind the seats when resetting the seats. There is a risk that the seats and/or the objects could be damaged.

PRE-SAFE® takes preemptive measures to protect occupants in certain hazardous situations. Despite your vehicle being equipped with the PRE-SAFE® system, the possibility of personal injuries occurring as a result of an accident cannot be eliminated. Always adapt your driving style to suit the prevailing road and weather conditions and maintain a safe distance from the vehicle in front. Drive carefully.

PRE-SAFE® intervenes:

- if BAS intervenes, e.g. in emergency braking situations.
- if BAS PLUS intervenes powerfully – on vehicles with DISTRONIC PLUS.



- if, on vehicles with DISTRONIC PLUS, the radar sensor system detects an imminent danger of collision in certain situations.
- in critical driving situations, e.g. when physical limits are exceeded and the vehicle understeers or oversteers severely.

PRE-SAFE® takes the following measures depending on the hazardous situation detected:

- the front seat belts are pre-tensioned.
- the front-passenger seat is adjusted if it is in an unfavorable position.
- vehicles with a multicontour seat or active multicontour seat: the air pressure in the side bolsters of the seat cushion and backrest is increased.
- if the vehicle skids, the sliding sunroof and the side windows are closed so that only a small gap remains.

If the hazardous situation passes without resulting in an accident, PRE-SAFE® slackens the belt pre-tensioning. The air pressure in the side bolsters on the multicontour seat/ active multicontour seat is reduced again. All settings made by PRE-SAFE® can then be reversed.

If the seat belts are not released:

- ▶ When the vehicle is stationary, move the backrest or seat back slightly.  
The seat belt pre-tensioning is reduced and the locking mechanism is released.

Information about seat belt adjustment, a convenience function integrated into PRE-SAFE®, can be found in the "Seat belt adjustment" section (▷ page 57).

## Seat belts

### Important safety notes

#### WARNING

The seat belt does not offer the intended level of protection if the backrest is not in the upright position. When braking or in the event

of an accident, you could slide underneath the seat belt and sustain abdomen or neck injuries, for example. This poses an increased risk of injury or even fatal injury.

Adjust the seat properly before beginning your journey. Always make sure that the seat is in the upright position.

#### WARNING

Seat belts cannot protect as intended, if:

- they are damaged, extremely dirty, bleached or dyed
- the seat belt buckle is damaged or extremely dirty
- the Emergency Tensioning Devices or the belt anchorage has been modified.

Damage caused to seat belts in an accident may not be visible, e.g. by splinters of glass. Modified or damaged seat belts can tear or fail, for example in the event of an accident. Modified Emergency Tensioning Devices may be deployed unintentionally or fail to be deployed when required. There is an increased risk of injury, possibly even fatal.

Never modify seat belts, Emergency Tensioning Devices, seat belt anchorages and inertia reels. Ensure that seat belts are not damaged or worn and are clean.

Only use seat belts that have been approved for your vehicle by Mercedes-Benz.

The use of seat belts and infant and child restraint systems is required by law in:

- all 50 states
- the U.S. territories
- the District of Columbia
- all Canadian provinces

Even where this is not required by law, all vehicle occupants should correctly fasten their seat belts before starting the journey.

- ❗ See "Children in the vehicle" (▷ page 60) for further information on infants and children traveling in the vehicle as well as on child restraint systems.

## Correct use of the seat belts

### WARNING

#### USE SEAT BELTS PROPERLY

- Seat belts can only work when used properly. Never wear seat belts in any other way than as described in this section, as that could result in serious injuries in the event of an accident.
- Each occupant should wear their seat belt at all times, because seat belts help reduce the likelihood of and potential severity of injuries in accidents, including rollovers. The integrated restraint system includes SRS (driver front air bag, driver's side knee bag, front-passenger front air bag, side impact air bags, pelvis air bags, window curtain air bags for the side windows), Emergency Tensioning Devices, seat belt force limiters, and front seat knee bolsters. The system is designed to enhance the protection offered to properly belted occupants in certain frontal (front air bags, driver's side knee bag and ETDs) and side (side impact air bags, window curtain air bags, and ETDs) impacts which exceed preset deployment thresholds and in certain rollovers (window curtain air bags and ETDs).
- Never wear the shoulder belt under your arm, across your neck or off your shoulder. In a frontal crash, your body would move too far forward. That would increase the chance of head and neck injuries. The seat belt would also apply too much force to the ribs or abdomen, which could severely injure internal organs such as your liver or spleen.

Adjust the seat belt so that the shoulder section is located as close as possible to the middle of the shoulder. It should not touch the neck. Never pass the shoulder portion of the seat belt under your arm. For this purpose, you can adjust the height of the seat belt outlet.

- Position the lap belt as low as possible on your hips and not across the abdomen. If the lap belt is positioned across your abdomen, it could cause serious injuries in a crash.
- Never wear seat belts over rigid or breakable objects in or on your clothing, such as eyeglasses, pens, keys etc., as these might cause injuries.
- Make sure the seat belt is always fitted snugly. Take special care of this when wearing loose clothing.
- Never use a seat belt for more than one person at a time. Do not fasten a seat belt around a person and another person or other objects at the same time.
- Seat belts should not be worn twisted. In a crash, you would not have the full width of the seat belt to distribute impact forces. The twisted seat belt against your body could cause injuries.
- Pregnant women should also always use a lap-shoulder belt. The lap belt portion should be positioned as low as possible on the hips to avoid any possible pressure on the abdomen.
- Place the seat backrest in a position that is as upright as possible.
- Check your seat belt during travel to make sure it is properly positioned.
- Never place your feet on the instrument panel, dashboard, or on the seat. Always keep both feet on the floor in front of the seat.
- When using a seat belt to secure infant restraints, toddler restraints, or children in booster seats, always follow the child seat manufacturer's instructions.

## Fastening seat belts

### WARNING

According to accident statistics, children are safer when properly restrained on the rear seats than on the front-passenger seat. Thus, we strongly recommend that children be

placed in the rear seat whenever possible. Regardless of seating position, children 12 years old and under must be seated and properly secured in an appropriately sized child restraint system or booster seat recommended for the size and weight of the child. For additional information, see the "Children in the vehicle" section.

A child's risk of serious or fatal injuries is significantly increased if the child restraints are not properly secured in the vehicle and/or the child is not properly secured in the child restraint.



- ▶ Adjust the seat and move the backrest to an almost vertical position (▷ page 98).
- ▶ Pull the seat belt smoothly through belt sash guide (1).
- ▶ Without twisting it, guide the shoulder section of the seat belt across the middle of your shoulder and the lap section across your pelvis.
- ▶ Engage belt tongue (2) in buckle (3).  
Seat-belt adjustment: if necessary, the driver's and front-passenger seat belts automatically adjust to the upper body (▷ page 57).

- ▶ If necessary, adjust the seat belt to the appropriate height (▷ page 58).
- ▶ If necessary, pull upwards on the shoulder section of the seat belt to tighten the belt across your body.

All seat belts except the driver's seat belt are equipped with a special seat belt retractor to securely fasten child restraint systems in the vehicle. Further information can be found under "Special seat belt retractor" (▷ page 63).

For more information about releasing the seat belt with release button (4), see "Releasing seat belts" (▷ page 58).

### Seat belt adjustment

The seat-belt adjustment function adjusts the driver's and front-passenger seat belt to the upper body of the occupants.

The belt strap is tightened slightly when:

- you engage the belt tongue in the belt buckle and you then turn the SmartKey to position 2 in the ignition lock.
- the SmartKey is in position 2 in the ignition lock and you then engage the belt tongue in the buckle.

The seat-belt adjustment will apply a retraction force if any slack is detected between the occupant and the seat belt. Do not hold on to the seat belt tightly while it is adjusting. You can switch the seat-belt adjustment on and off in the on-board computer (▷ page 233).

The seat-belt adjustment is an integral part of the PRE-SAFE® convenience function. More information about PRE-SAFE® can be found under "PRE-SAFE® (preventative occupant protection)" (▷ page 54).

## Belt height adjustment

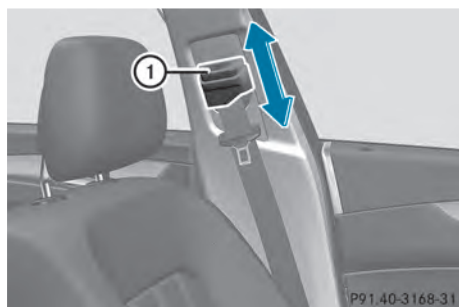

You can adjust the seat belt height on the front seats. Adjust the belt to a height that allows the upper part of the seat belt to be routed across the center of your shoulder.

- ▶ **To raise:** slide the belt sash guide upwards. The belt sash guide engages in various positions.
- ▶ **To lower:** press and hold belt sash guide release ①.
- ▶ Slide the belt sash guide downwards.
- ▶ Release belt sash guide release ① and make sure that the belt sash guide has engaged.

## Releasing seat belts

- ❗ Make sure that the seat belt is fully rolled up. Otherwise, the seat belt or belt tongue will be trapped in the door or in the seat mechanism. This could damage the door, the door trim panel and the seat belt. Damaged seat belts can no longer fulfill their protective function and must be replaced. Visit a qualified specialist workshop.

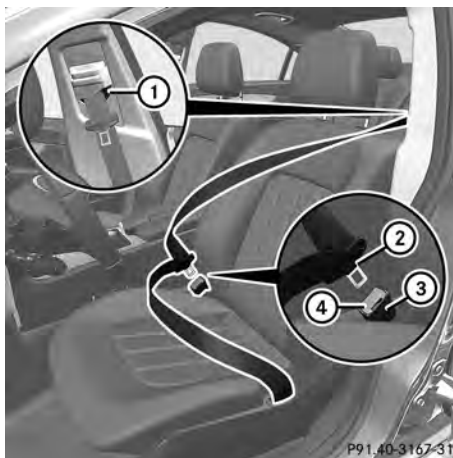



- ▶ Press release button ④ on belt buckle ③.
- ▶ Guide belt tongue ② to belt sash guide ①.

## Belt warning for the driver and front passenger

Regardless of whether the driver's and front-passenger seat belts have already been fastened, the  seat belt warning lamp lights up for six seconds each time the engine is started. It then goes out if the driver and the front passenger have already fastened their seat belts.

If the driver's seat belt is not fastened when the engine is started, an additional warning tone will sound. This warning tone stops after a maximum of six seconds or once the driver's seat belt is fastened.

If after six seconds, the driver or front passenger have not fastened their seat belts and the doors are closed:

- the  seat belt warning lamp remains lit as long as the driver's or front-passenger's seat belt is not fastened and
- if a vehicle speed of 15 mph (25 km/h) is exceeded, the  seat belt warning lamp begins to flash. A warning tone also sounds with increasing intensity for a maximum of

60 seconds or until the driver or front passenger have fastened their seat belts.

If the driver/front passenger unfasten their seat belt while the vehicle is in motion, the  seat belt warning lamp lights up and a warning tone sounds again.

The warning tone ceases even if the driver or front-passenger seat belt has still not been fastened after 60 seconds. The  seat belt warning lamp stops flashing but remains illuminated.

After the vehicle comes to a standstill, the warning tone is reactivated and the seat belt warning lamp  flashes again if the vehicle speed again exceeds 15 mph (25 km/h).

The  seat belt warning lamp only goes out if:

- both the driver and the front passenger have fastened their seat belts.  
or
- the vehicle is stationary and a door is open.

**i** For more information on the  seat belt warning lamp, see "Warning and indicator lamps in the instrument cluster, seat belts" (> page 265).

## Emergency Tensioning Devices, seat belt force limiters

### WARNING

Pyrotechnic Emergency Tensioning Devices that have been deployed are no longer operational and are unable to perform their intended protective function. This poses an increased risk of injury or even fatal injury. Therefore, have pyrotechnic Emergency Tensioning Devices which have been triggered immediately replaced at a qualified specialist workshop.

**!** If the front-passenger seat is not occupied, do not engage the seat belt tongue in the buckle on the front-passenger seat. Otherwise, the Emergency

Tensioning Device could be triggered in the event of an accident.

**i** Vehicles with PRE-SAFE®: Emergency Tensioning Devices that are triggered by an electric motor can be deployed as often as desired and do not need to be replaced.

The front seat belts and the outer seat belts in the rear are equipped with Emergency Tensioning Devices and seat belt force limiters.

The ETDs tighten the seat belts in an accident, pulling them close against the body.

The ETDs do not correct incorrect seat positions or incorrectly fastened seat belts.

The ETDs do not pull vehicle occupants back towards the backrest.

The ETDs can only be activated when:

- the ignition is switched on
- the restraint systems are operational; see "SRS warning lamp " (> page 41)
- the belt tongue is engaged in the buckle on each of the front seat belts.

The ETDs on the outside seats in the rear compartment are triggered independently of the lock status of the seat belts.

The ETDs are triggered depending on the type and severity of an accident:

- if, in the event of a head-on or rear-end collision, the vehicle decelerates or accelerates rapidly in a longitudinal direction during the initial stages of the impact
- if, in the event of a side impact, on the side opposite the impact the vehicle decelerates or accelerates rapidly in a lateral direction
- if, in certain situations where the vehicle rolls over, the system determines that it can provide additional protection

If the ETDs are deployed, you will hear a bang, and a small amount of powder may also be released. Only in rare cases will the bang affect your hearing. The powder that is released generally does not constitute a

health hazard and does not indicate that there is a fire in the vehicle. The dust might cause some temporary breathing difficulty for people with asthma or other breathing trouble. To avoid this, you may wish to get out of the vehicle as soon as it is safe to do so. You can also open the window to allow fresh air to enter the vehicle interior. The  SRS warning lamp lights up.

If the seat belt is also equipped with a seat belt force limiter and this is triggered, the force exerted by the seat belt on the vehicle occupant is reduced.

The seat belt force limiters for the front seats are synchronized with the front air bags, which take on a part of the deceleration force. This results in the force exerted on the occupant being distributed over a greater area.

## Children in the vehicle

### Child restraint systems

#### Important safety notes

##### WARNING







According to accident statistics, children are safer when properly restrained in the rear seating positions than in the front seating position. Thus, we strongly recommend that children be placed in the rear seats whenever possible. Regardless of seating position, children 12 years old and under must be seated and properly secured in an appropriate infant restraint, toddler restraint, or booster seat recommended for the size and weight of the child.

The infant or child restraint must be properly secured with the vehicle's seat belt, the seat belt and top tether strap, or lower anchors and top tether strap, fully in accordance with the child seat manufacturer's instructions.

Occupants, especially children, should always sit as upright as possible, wear the seat belt properly and use an appropriately sized infant restraint, toddler restraint, or booster seat

recommended for the size and weight of the child.

Children can be killed or seriously injured by an inflating air bag. Note the following important information when circumstances require you to place a child in the front passenger seat:

- Your vehicle is equipped with air bag technology designed to deactivate the front passenger front air bag in your vehicle when the system senses the weight of a typical 12-month-old child or less along with the weight of a standard appropriate child restraint on the front passenger seat.
- For children larger than the typical 12-month-old child, the front passenger front air bag may or may not be activated. Always make sure the  PASS AIR BAG OFF indicator lamp is illuminated, indicating that the front passenger front air bag is deactivated.
- A child in a rear-facing child restraint on the front passenger seat will be seriously injured or even killed if the front passenger front air bag inflates in a collision which could occur under some circumstances, even with the air bag technology installed in your vehicle. The only means to completely eliminate this risk is to never place a child in a rear-facing child restraint in the front seat. We therefore strongly recommend that you always place a child in a rear-facing child restraint in a backseat.
- If you must install a rear-facing child restraint on the front passenger seat because circumstances require you to do so, make sure the  PASS AIR BAG OFF indicator lamp is illuminated, indicating that the front passenger front air bag is deactivated. Should the  PASS AIR BAG OFF indicator lamp not illuminate or go out while the restraint is installed, please check installation. Periodically check the  PASS AIR BAG OFF indicator lamp while driving to make sure the  PASS AIR BAG OFF indicator lamp is illuminated. If the  PASS AIR BAG OFF indicator lamp goes out or remains out, do not transport a child on the

front passenger seat until the system has been repaired.

A child in a rear-facing child restraint on the front passenger seat will be seriously injured or even killed if the front passenger front air bag inflates.

- If you have to place a child in a forward-facing child restraint on the front passenger seat, move the seat as far back as possible, use the proper child restraint recommended for the age, size and weight of the child, and secure child restraint with the vehicle's seat belt according to the child seat manufacturer's instructions.

### WARNING

If the child restraint system is installed incorrectly on a suitable seat, it cannot protect as intended. The child cannot then be restrained in the event of an accident, heavy braking or sudden changes of direction. There is an increased risk of injury, possibly even fatal.

Make sure that you observe the child restraint system manufacturer's installation instructions and the notes on use. Please ensure, that the base of the child restraint system is always resting completely on the seat cushion. Never place objects, e.g. cushions, under or behind the child restraint system. Only use child restraint systems with the original cover designed for them. Only replace damaged covers with genuine covers.

### WARNING

If the child restraint system is installed incorrectly or is not secured, it can come loose in the event of an accident, heavy braking or a sudden change in direction. The child restraint system could be thrown about, striking vehicle occupants. There is an increased risk of injury, possibly even fatal.

Always install child restraint systems properly, even if they are not being used. Make sure that you observe the child restraint

system manufacturer's installation instructions.

### WARNING

Child restraint systems or their securing systems which have been damaged or subjected to a load in an accident can no longer protect as intended. The child cannot then be restrained in the event of an accident, heavy braking or sudden changes of direction. There is an increased risk of injury, possibly even fatal.

Replace child restraint systems which have been damaged or subjected to a load in an accident as soon as possible. Have the securing systems on the child restraint system checked at a qualified specialist workshop, before you install a child restraint system again.

### WARNING

Infants and small children should never share a seat belt with another occupant. In the event of an accident, they could be crushed between the occupant and seat belt.

A child's risk of serious or fatal injuries is significantly increased if the child restraints are not properly secured in the vehicle and/or the child is not properly secured in the child restraint.

Children that are too large for a child restraint must travel in seats using normal seat belts. Position the shoulder belt across the chest and shoulder, not the face or neck. A booster seat may be necessary to achieve proper seat belt positioning for children over 41 lbs (18 kg) until they reach a height where a lap/shoulder belt fits properly without a booster seat.

When the child restraint is not in use, remove it from the vehicle or secure it with the seat belt to prevent the child restraint from becoming a projectile in the event of an accident.

**⚠ WARNING**

If children are left unsupervised in the vehicle, they could:

- open the doors, thus endangering other people or road users.
- get out and disrupt traffic.
- operate the vehicle's equipment.

Additionally, children could set the vehicle in motion if, for example, they:

- release the parking brake.
- shifting the automatic transmission out of park position **P**
- Start the engine.

There is a risk of an accident and injury.

When leaving the vehicle, always take the SmartKey with you and lock the vehicle. Never leave children or animals unattended in the vehicle. Always keep the SmartKey out of reach of children.

**⚠ WARNING**

If persons, particularly children are subjected to prolonged exposure to extreme heat or cold, there is a risk of injury, possibly even fatal. Never leave children unattended in the vehicle.

**⚠ WARNING**

If the child restraint system is subjected to direct sunlight, parts may get very hot. Children may burn themselves on these parts, particularly on the metal parts of the child restraint system. There is a risk of injury.

If you leave the vehicle, taking the child with you, always ensure that the child restraint system is not exposed to direct sunlight. Protect it with a blanket, for example. If the child restraint system has been exposed to direct sunlight, let it cool down before securing the child in it. Never leave children unattended in the vehicle.

If an infant or child is traveling in the vehicle:

- Secure the child with a child or infant seat restraint system appropriate to the age and weight of the child.
- Make sure that the infant or child is properly secured at all times while the vehicle is in motion.

Mercedes-Benz recommends that you always properly secure all infants and children with a child or infant seat restraint system for the trip.

The use of seat belts and infant and child restraint systems is required by law in:

- all 50 states
- the U.S. territories
- the District of Columbia
- all Canadian provinces

Infants and children must always be seated in an appropriate infant or child restraint system recommended for the size and weight of the child. The infant or child restraint system must be properly secured in accordance with the manufacturer's instructions.

All infant or child restraint systems must meet the following standards:

- U.S. Federal Motor Vehicle Safety Standards 213 and 225
- Canadian Motor Vehicle Safety Standards 213 and 210.2

Confirmation that the child restraint system corresponds to the standards can be found on an instruction label on the child restraint system. This confirmation can also be found in the installation instructions that are included with the child restraint system.

Always read and follow the manufacturer's instructions when using an infant or child restraint system or booster seat.

Observe the warning labels in the vehicle interior or on the infant or child restraint.



## Special seat belt retractor

### WARNING

If the seat belt is released while driving, the child restraint system will no longer be secured properly. The special seat belt retractor is disabled and the inertia reel draws in a portion of the seat belt. The seat belt cannot be immediately refastened. There is an increased risk of injury, possibly even fatal. Stop the vehicle immediately, paying attention to road and traffic conditions. Reactivate the special seat belt retractor and secure the child restraint system properly.

All seat belts except the driver's seat belt are equipped with a special seat belt retractor. When activated, the special seat belt retractor ensures that the seat belt will not slacken once the child restraint system has been secured.

Installing a child restraint system:

- ▶ Always comply with the manufacturer's installation instructions.
- ▶ Pull the seat belt smoothly from the seat belt retractor.
- ▶ Engage the seat belt tongue in the belt buckle.

Activating the special seat belt retractor:

- ▶ Pull the seat belt out fully and let the seat belt retractor retract it again. While the seat belt is retracting, you should hear a ratcheting sound. The special seat belt retractor is activated.
- ▶ Push down on the child restraint system to take up any slack.

Removing a child restraint system/  
deactivating the special seat belt retractor:

- ▶ Always comply with the manufacturer's installation instructions.
- ▶ Press the seat belt release button and guide the belt tongue to the belt outlet. The special seat belt retractor is deactivated.

## LATCH-type (ISOFIX) child seat anchors in the rear

### WARNING

LATCH-type (ISOFIX) child restraint systems do not offer sufficient protective effect for children whose weight is greater than 48 lbs (22 kg). The child could, for example, not be restrained correctly in the event of an accident. This poses an increased risk of injury or even fatal injury.

If the child weighs more than 48 lbs (22 kg), also secure the LATCH-type (ISOFIX) child restraint system with the vehicle seat belt. Also secure the child restraint system with the Top Tether belt, if available.

When installing a child restraint system, be sure to observe the manufacturer's installation instructions and the instructions for correct use of the child restraint system.

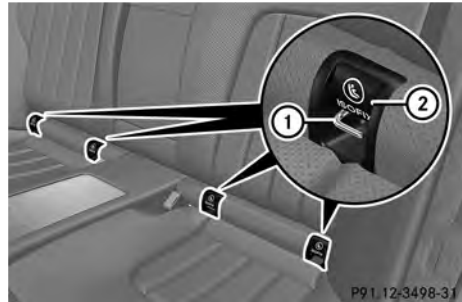

Securing ring

When installing the LATCH-type (ISOFIX) child restraint system, fold protective caps ② of securing rings ① inwards.

- ▶ Install the LATCH-type (ISOFIX) child seat securing system. Comply with the manufacturer's instructions when installing.

The LATCH-type (ISOFIX) system is a standardized securing system for specially designed child restraint systems on the rear seats. Securing rings for two LATCH-type (ISOFIX) child restraint systems are installed on the left and right of the rear seats.

Secure child restraint systems without a LATCH-type (ISOFIX) child seat securing system using the seat belts in the vehicle. When installing child restraint systems, you must observe the manufacturer's installation instructions.

## Top Tether

### Top Tether anchorages

#### WARNING

Always lock the rear seat backrests in their upright position when the rear seats are occupied by passengers. Lock the rear seat backrests in their upright position before installing the Top Tether straps or when the cargo compartment is not in use. Make sure that rear seat backrests are secured properly by pushing and pulling on the seat backrests. If the seat backrest is not locked properly, the seat backrest could fold forward. The child restraint system is no longer supported properly or held in position and can no longer fulfill its function. This could cause serious or even fatal injuries.

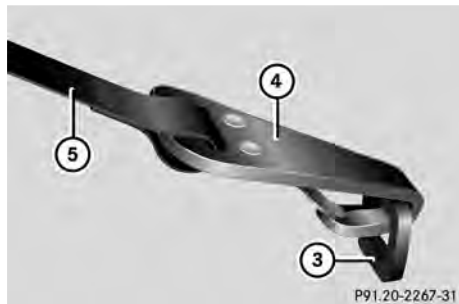
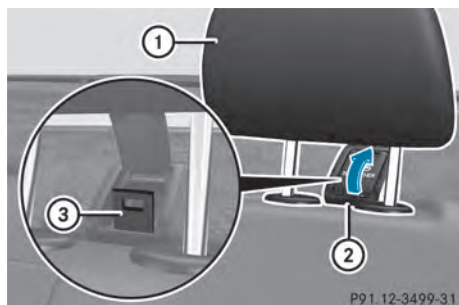

Top Tether provides an additional connection between a child restraint system, secured with a LATCH-type (ISOFIX) child seat mount, and the rear seat. This helps reduce the risk of injury even further.

The Top Tether anchorage points are located in the rear compartment behind the head restraints.

- ▶ Move head restraint ① upwards.
- ▶ Fold up cover ② of Top Tether anchorage ③.
- ▶ Route Top Tether belt ⑤ under head restraint ① between the two head restraint bars.
- ▶ Hook Top Tether hook ④ into Top Tether anchorage ③.
- ▶ Make sure that Top Tether belt ⑤ is not twisted.
- ▶ Fold down cover ② of Top Tether anchorage ③.
- ▶ Slide down head restraint ① until it engages (> page 101).  
Make sure that you do not interfere with the correct routing of Top Tether belt ⑤.
- ▶ Install the LATCH-type (ISOFIX) child restraint system with Top Tether. Comply with the manufacturer's installation instructions when doing so. Make sure that Top Tether belt ⑤ is tight.

### Child-proof locks

### Important safety notes

#### WARNING

If children are left unsupervised in the vehicle, they could:

- open the doors, thus endangering other people or road users.
- get out and disrupt traffic.
- operate the vehicle's equipment.

Additionally, children could set the vehicle in motion if, for example, they:

- release the parking brake.
- shifting the automatic transmission out of park position **P**
- Start the engine.

There is a risk of an accident and injury.

When leaving the vehicle, always take the SmartKey with you and lock the vehicle. Never leave children or animals unattended in the vehicle. Always keep the SmartKey out of reach of children.

### WARNING

If persons, particularly children are subjected to prolonged exposure to extreme heat or cold, there is a risk of injury, possibly even fatal. Never leave children unattended in the vehicle.

### WARNING

If children are traveling in the vehicle, they could:

- open doors, thus endangering other people or road users
- exit the vehicle and be caught by oncoming traffic
- operate vehicle equipment and become trapped

There is a risk of an accident and injury.

Always activate the child-proof locks and override feature if children are traveling in the vehicle. When leaving the vehicle, always take the key with you and lock the vehicle. Never leave children unattended in the vehicle.

You can activate the following child-proof locks:

- rear doors (▷ page 65)
- rear side windows (▷ page 65)

## Child-proof locks for the rear doors

### WARNING

Children could open a rear door from inside the vehicle. This could result in serious injuries or an accident. Therefore, when children ride in the rear always secure the rear doors with the child-proof locks.

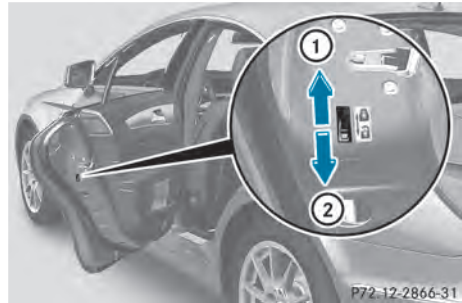

You secure each door individually with the child-proof locks on the rear doors. A door secured with a child-proof lock cannot be opened from inside the vehicle. When the vehicle is unlocked, the door can be opened from the outside.

- ▶ **To activate:** press the child-proof lock lever up in the direction of arrow ①.
- ▶ Make sure that the child-proof locks are working properly.
- ▶ **To deactivate:** press the child-proof lock lever down in the direction of arrow ②.

## Override feature for the rear side windows

### WARNING

When children ride on the vehicle's rear seats, activate the override switch. Otherwise, the children could be injured, e.g. by trapping themselves in the rear side window.

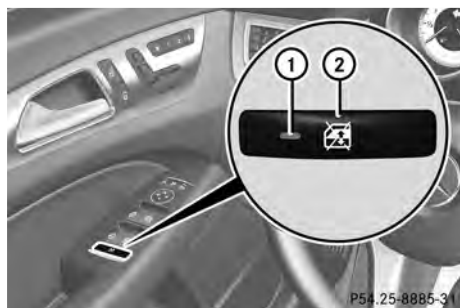

- **To activate/deactivate:** press button ②. If indicator lamp ① is lit, operation of the rear side windows is disabled. Operation is only possible using the switches in the driver's door. If indicator lamp ① is off, operation is possible using the switches in the rear compartment.

## Driving safety systems

### Overview of driving safety systems

In this section, you will find information about the following driving safety systems:

- ABS (**A**nti-**l**ock **B**raking **S**ystem) (▷ page 66)
- BAS (**B**rake **A**ssist **S**ystem) (▷ page 67)
- BAS PLUS (**B**rake **A**ssist **S**ystem Plus) (▷ page 67)
- ESP® (**E**lectronic **S**tability **P**rogram) (▷ page 68)
- EBD (**E**lectronic **B**rake force **D**istribution) (▷ page 71)
- ADAPTIVE BRAKE (▷ page 72)
- PRE-SAFE® Brake (▷ page 72)

### Important safety notes

If you fail to adapt your driving style or become distracted, the driving safety systems can neither reduce the risk of accident nor override the laws of physics. Driving safety systems are merely aids designed to assist driving. You are

responsible for the distance to the vehicle in front, for vehicle speed and for braking in good time. Always adapt your driving style to suit the prevailing road, weather and traffic conditions and maintain a safe distance from the vehicle in front. Drive carefully.

- ❗ The driving safety systems described only work as effectively as possible when there is adequate contact between the tires and the road surface. Please pay special attention to the notes on tires, recommended minimum tire tread depths, etc. (▷ page 334).

In wintry driving conditions, always use winter tires (M+S tires) and if necessary, snow chains. Only in this way will the driving safety systems described in this section work as effectively as possible.

## ABS (Anti-lock Braking System)

### Important safety notes

- ❗ Observe the "Important safety notes" section (▷ page 66).

#### **WARNING**

If ABS is faulty, the wheels could lock when braking. The steerability and braking characteristics may be severely impaired. Additionally, further driving safety systems are deactivated. There is an increased danger of skidding and accidents.

Drive on carefully. Have ABS checked immediately at a qualified specialist workshop.

When ABS is malfunctioning, other systems, including driving safety systems, will also become inoperative. Observe the information on the ABS warning lamp (▷ page 267) and display messages which may be shown in the instrument cluster (▷ page 238).

ABS regulates brake pressure in such a way that the wheels do not lock when you brake. This allows you to continue steering the vehicle when braking.

ABS works from a speed of about 5 mph (8 km/h) upwards, regardless of road-surface conditions. ABS works on slippery surfaces, even if you only brake gently.

The yellow  ABS warning lamp in the instrument cluster lights up when the ignition is switched on. It goes out when the engine is running.

## Braking

- ▶ **If ABS intervenes:** continue to depress the brake pedal vigorously until the braking situation is over.
- ▶ **To make a full brake application:** depress the brake pedal with full force.

If ABS intervenes when braking, you will feel a pulsing in the brake pedal.

The pulsating brake pedal can be an indication of hazardous road conditions, and functions as a reminder to take extra care while driving.

## BAS (Brake Assist System)

- ❗ Observe the "Important safety notes" section (▷ page 66).

### WARNING

If BAS is malfunctioning, the braking distance in an emergency braking situation is increased. There is a risk of an accident.

In an emergency braking situation, depress the brake pedal with full force. ABS prevents the wheels from locking.

BAS operates in emergency braking situations. If you depress the brake pedal quickly, BAS automatically boosts the braking force, thus shortening the stopping distance.

The brakes will function as usual once you release the brake pedal. BAS is deactivated.

## BAS PLUS (Brake Assist System PLUS)

### General information

- ❗ Observe the "Important safety notes" section (▷ page 66).

BAS PLUS is only available in vehicles equipped with DISTRONIC PLUS.

For BAS PLUS to assist you when driving, the radar sensor system must be:

- activated (▷ page 232)
- operational

With the help of the radar sensor system, BAS PLUS can detect obstacles that are in the path of your vehicle for an extended period of time.

If the radar sensor system is malfunctioning, BAS PLUS will not be available. The brake system is still available with complete brake boosting effect and BAS.

BAS PLUS provides braking assistance in hazardous situations at speeds greater than 4 mph (7 km/h).

At speeds of up to approximately 40 mph (70 km/h), BAS PLUS can also react to stationary objects. Examples of stationary objects are stopped or parked vehicles.

### Important safety notes

#### WARNING

BAS PLUS cannot always clearly identify objects and complex traffic situations. BAS PLUS cannot intervene in these cases. There is a risk of an accident.

Always pay careful attention to the traffic situation and be ready to brake.

#### WARNING

BAS PLUS does not react:

- to people or animals
- to oncoming vehicles
- to crossing traffic
- when cornering

As a result, BAS PLUS may not intervene in all critical situations. There is a risk of an accident.

Always pay careful attention to the traffic situation and be ready to brake.

In particular, the detection of obstacles can be impaired if there is:

- dirt on the sensors or anything else covering the sensors
- snow or heavy rain
- interference by other radar sources
- there are strong radar reflections, for example in parking garages
- a narrow vehicle traveling in front, e.g. a motorbike
- a vehicle traveling in front on a different line relative to the center of your vehicle

Following damage to the front end of the vehicle, have the configuration and operation of the radar sensors checked at a qualified specialist workshop. This also applies to collisions at low speeds where there is no visible damage to the front of the vehicle.

### Braking assistance

To prevent a collision with the vehicle in front, BAS PLUS calculates the brake force necessary if:

- you approach an obstacle, and
- BAS PLUS has detected a risk of collision

**When driving at a speed under 20 mph (30 km/h):** if you depress the brake pedal, BAS PLUS is activated. The increase in brake pressure will be carried out at the last possible moment.

**When driving at a speed greater than 20 mph (30 km/h):** if you depress the brake pedal sharply, BAS PLUS automatically raises the brake pressure to a value adapted to the traffic situation.

If BAS PLUS demands particularly high braking force, preventative passenger

protection measures (PRE-SAFE®) are activated simultaneously.

- ▶ Keep the brake pedal depressed until the emergency braking situation is over. ABS prevents the wheels from locking.

BAS PLUS is deactivated and the brakes function as usual if:

- you release the brake pedal
- there is no longer a risk of collision
- no obstacle is detected in front of your vehicle

### ESP® (Electronic Stability Program)

#### Important safety notes

- ❗ Observe the "Important safety notes" section (▷ page 66).

#### WARNING

If ESP® is malfunctioning, ESP® is unable to stabilize the vehicle. Additionally, further driving safety systems are deactivated. This increases the risk of skidding and an accident.



Drive on carefully. Have ESP® checked at a qualified specialist workshop.

- ❗ Vehicles with 4MATIC: switch off the ignition when the parking brake is being tested on a brake dynamometer.

Application of the brakes by ESP® may otherwise destroy the brake system.

Vehicles without 4MATIC: observe the notes on ESP® (▷ page 330) when towing the vehicle with a raised rear axle.

ESP® is deactivated if the  warning lamp in the instrument cluster lights up continuously when the engine is running.

If the  warning lamp and the  warning lamp are lit continuously, ESP® is not available due to a malfunction.

Observe the information on warning lamps (▷ page 269) and display messages which may be shown in the instrument cluster (▷ page 238).

If ESP® detects that the vehicle is deviating from the direction desired by the driver, one or more wheels are braked to stabilize the vehicle. The engine output is also modified to keep the vehicle on the desired course within physical limits. ESP® assists the driver when pulling away on wet or slippery roads. ESP® can also stabilize the vehicle during braking. If ESP® intervenes, the  ESP® warning lamp flashes in the instrument cluster.

If ESP® intervenes:

- ▶ Do not deactivate ESP® under any circumstances.
  - ▶ Only depress the accelerator pedal as far as necessary when pulling away.
  - ▶ Adapt your driving style to suit the prevailing road and weather conditions.
- i** Only use wheels with the recommended tire sizes. Only then will ESP® function properly.

### **ETS/4ETS (Electronic Traction System)**

ETS/4ETS traction control is part of ESP®. Traction control brakes the drive wheels individually if they spin. This enables you to pull away and accelerate on slippery surfaces, for example if the road surface is slippery on one side. In addition, more drive torque is transferred to the wheel or wheels with traction.

Traction control remains active, even if you deactivate ESP®.

### **Deactivating/activating ESP® (except AMG vehicles)**

#### **WARNING**

If you deactivate ESP®, ESP® no longer stabilizes the vehicle. There is an increased risk of skidding and an accident.

Only deactivate ESP® in the situations described in the following.

**!** Avoid spinning the driven wheels for an extended period with ESP® deactivated. You could otherwise damage the drivetrain.

▶ **To deactivate:** (> page 227).

The  ESP® OFF warning lamp in the instrument cluster lights up.

▶ **To activate:** (> page 227).

The  ESP® OFF warning lamp in the instrument cluster goes out.

ESP® is activated automatically when the engine is started.

The ECO start/stop function switches the engine off automatically when the vehicle stops moving. The engine starts automatically when the driver wants to pull away again. ESP® remains in its previously selected status. Example: if ESP® was deactivated before the engine was switched off, ESP® remains deactivated when the engine is switched on again.

If ESP® is deactivated and one or more wheels start to spin, the  ESP® warning lamp in the instrument cluster flashes. In such situations, ESP® will not stabilize the vehicle.

It may be best to deactivate ESP® in the following situations:

- when using snow chains
- in deep snow
- on sand or gravel

If you deactivate ESP®:

- ESP® no longer improves driving stability.
- traction control is still activated.
- ESP® still provides support when you brake.
- engine torque is not limited and the drive wheels are able to spin. The spinning wheels produce a cutting effect for better traction.

## Deactivating/activating ESP® (AMG vehicles)

### Activating/deactivating SPORT handling mode

Safety

#### WARNING

When SPORT handling mode is activated, there is a greater risk of skidding and accidents.

Only activate SPORT handling mode in the situations described in the following.



► **To activate:** briefly press button ①. The **SPORT** SPORT handling mode warning lamp in the instrument cluster lights up. The **SPORT handling mode** message appears in the multifunction display. SPORT handling mode is designed for driving on designated roads when the vehicle's own oversteering and understeering characteristics are desired. Driving in SPORT handling mode requires an extremely qualified and experienced driver who is able to cope with these critical driving conditions.

► **To deactivate:** briefly press button ①. The **SPORT** SPORT handling mode warning lamp in the instrument cluster goes out.

ESP® is activated automatically when the engine is started.

It may be best to activate SPORT handling mode in the following situations:

- when using snow chains
- in deep snow
- on sand or gravel

If SPORT handling mode is activated and one or more wheels start to spin, the  ESP® warning lamp in the instrument cluster flashes. ESP® only stabilizes the vehicle to a limited degree.

When SPORT handling mode is activated:

- ESP® only improves driving stability to a limited degree.
- traction control is still activated.
- ESP® still provides support when you brake.
- engine torque is only restricted to a limited degree, and the drive wheels are able to spin. The spinning wheels produce a cutting effect for better traction.

Vehicles with ECO start/stop function: the ECO start/stop function switches the engine off automatically when the vehicle comes to a stop. The engine starts automatically when the driver wants to pull away again. ESP® remains in its previously selected status. For example, if ESP® was deactivated before the engine was switched off, ESP® remains deactivated when the engine is switched on again.

### Deactivating/activating ESP®

#### WARNING

If you deactivate ESP®, ESP® no longer stabilizes the vehicle. There is an increased risk of skidding and an accident.

Only deactivate ESP® in the situations described in the following.

**!** Avoid spinning the driven wheels for an extended period with ESP® deactivated. You could otherwise damage the drivetrain.







► **To deactivate:** press button ① until the  ESP<sup>®</sup> OFF warning lamp lights up in the instrument cluster.

The  OFF message appears in the multifunction display.

Deactivate ESP<sup>®</sup> when driving on designated roads when the vehicle's own oversteering and understeering characteristics are desired. Driving without ESP<sup>®</sup> requires an extremely qualified and experienced driver who is able to cope with these critical driving conditions.

► **To activate:** briefly press button ①.

The  ESP<sup>®</sup> OFF warning lamp in the instrument cluster goes out. The  ON message appears in the multifunction display.

ESP<sup>®</sup> is activated automatically when the engine is started.

If ESP<sup>®</sup> is deactivated and one or more wheels start to spin, the  ESP<sup>®</sup> warning lamp in the instrument cluster does not flash. In such situations, ESP<sup>®</sup> will not stabilize the vehicle. It may be best to deactivate ESP<sup>®</sup> in the following situations:

- when using snow chains
- in deep snow
- on sand or gravel

If you deactivate ESP<sup>®</sup>:

- ESP<sup>®</sup> no longer improves driving stability.
- traction control is still activated.

- PRE-SAFE<sup>®</sup> is no longer available, nor is it activated if you brake firmly and ESP<sup>®</sup> intervenes.
- PRE-SAFE<sup>®</sup> Brake is no longer available, it is also not activated if you brake firmly and ESP<sup>®</sup> intervenes.
- ESP<sup>®</sup> still provides support when you brake.
- engine torque is no longer limited and the drive wheels are able to spin. The spinning wheels produce a cutting effect for better traction.

Vehicles with ECO start/stop function: the ECO start/stop function switches the engine off automatically when the vehicle comes to a stop. The engine starts automatically when the driver wants to pull away again. ESP<sup>®</sup> remains in its previously selected status. For example, if ESP<sup>®</sup> was deactivated before the engine was switched off, ESP<sup>®</sup> remains deactivated when the engine is switched on again.

### EBD (electronic brake force distribution)

**i** Observe the "Important safety notes" section (► page 66).

### WARNING

If EBD has malfunctioned, the rear wheels can still lock, e.g. under full braking. This increases the risk of skidding and an accident. You should therefore adapt your driving style to the different handling characteristics. Have the brake system checked at a qualified specialist workshop.

Observe information regarding indicator and warning lamps (► page 267) as well as display messages (► page 240).

EBD monitors and controls the brake pressure on the rear wheels to improve driving stability while braking.

## ADAPTIVE BRAKE

ADAPTIVE BRAKE enhances braking safety and offers increased braking comfort. In addition to the braking function, ADAPTIVE BRAKE also has the HOLD function (▷ page 186) and hill start assist (▷ page 150).

## PRE-SAFE® Brake

### General information

**i** Observe the "Important safety notes" section (▷ page 66).

PRE-SAFE® Brake is only available in vehicles with DISTRONIC PLUS.

If PRE-SAFE® Brake is to aid you, the radar sensor system must be:

- activated (▷ page 232)
- operational

With the help of the radar sensor system, PRE-SAFE® Brake can detect obstacles that are in front of your vehicle for an extended period of time.

PRE-SAFE® Brake can help you to minimize the risk of a collision with a vehicle ahead or reduce the effects of such a collision. If PRE-SAFE® Brake has detected a risk of collision, you will be warned visually and acoustically as well as by automatic braking. PRE-SAFE® Brake cannot prevent a collision without your intervention.

At speeds of up to approximately 40 mph (70 km/h) PRE-SAFE® Brake can also detect stationary objects. Examples of stationary objects are stopped or parked vehicles.

### Important safety notes

#### WARNING

PRE-SAFE® Brake will initially brake your vehicle by a partial application of the brakes if a danger of collision is detected. There may be a collision unless you also brake.

Automatic emergency braking cannot prevent a collision. There is a risk of an accident.

Always apply the brakes yourself and try to take evasive action.

#### WARNING

PRE-SAFE® Brake cannot always clearly identify objects and complex traffic conditions.

In these cases, PRE-SAFE® Brake may:

- give an unnecessary warning and then brake the vehicle
- not give a warning or intervene

There is a risk of an accident.

Always pay particular attention to the traffic situation and be ready to brake, especially if PRE-SAFE® Brake warns you. Terminate the intervention in a non-critical driving situation.

In particular, the detection of obstacles can be impaired if there is:

- dirt on the sensors or anything else covering the sensors
- snow or heavy rain
- interference by other radar sources
- there are strong radar reflections, for example in parking garages
- a narrow vehicle traveling in front, e.g. a motorbike
- a vehicle traveling in front on a different line relative to the center of your vehicle

#### WARNING

PRE-SAFE® Brake does not react:

- to people or animals
- to oncoming vehicles
- to crossing traffic
- when cornering

As a result, PRE-SAFE® Brake may neither give warnings nor intervene in all critical situations. There is a risk of an accident.

Always pay careful attention to the traffic situation and be ready to brake.

In order to maintain the appropriate distance to the vehicle in front and thus prevent a collision, you must apply the brakes yourself. Due to the nature of the system, particularly complicated driving conditions may cause unnecessary warnings or the unnecessary intervention of PRE-SAFE® Brake.

Following damage to the front end of the vehicle, have the configuration and operation of the radar sensors checked at a qualified specialist workshop. This also applies to collisions at low speeds where there is no visible damage to the front of the vehicle.

### Function

► **To activate/deactivate:** activate or deactivate PRE-SAFE® Brake in the on-board computer (▷ page 228).

If the PRE-SAFE® Brake is not activated, the  symbol appears in the multifunction display.

If you approach a vehicle in front very quickly, this function warns you from a speed of approximately 4 mph (7 km/h). An intermittent warning tone sounds and the  distance warning signal lamp in the instrument cluster lights up.

- Brake immediately to defuse the situation.
- or
- Take evasive action provided it is safe to do so.

From a speed of approximately 4 mph (7 km/h), if the driver and front passenger have fastened their seat belts, PRE-SAFE® Brake can brake the vehicle automatically at speeds up to approximately 124 mph (200 km/h).

You can prevent the intervention of the PRE-SAFE® Brake at any time by:

- depressing the accelerator pedal further.
- activating kickdown.
- releasing the brake pedal.

The braking action of PRE-SAFE® Brake is ended automatically if:

- you maneuver to avoid the obstacle.
- there is no longer any danger of a rear-end collision.
- there is no longer an obstacle detected in front of your vehicle.

If you approach an obstacle and PRE-SAFE® Brake detects a risk of a collision, the system will alert you both visually and acoustically. If you do not brake or take evasive action, the system will warn you by automatically braking the vehicle gently. If there is an increased risk of collision, preventative passenger protection measures (PRE-SAFE®) are activated (▷ page 54). If a risk of collision remains at speeds of over 20 mph (30 km/h) and you do not brake, take evasive action or significantly accelerate, automatic braking may be performed up to and including emergency braking. Automatic emergency braking is not performed until immediately prior to an accident that can no longer be avoided.

### Theft deterrent locking system

#### Immobilizer

The immobilizer prevents your vehicle from being started without the correct SmartKey.

- **To activate with the SmartKey:** remove the SmartKey from the ignition lock.
- **To activate with KEYLESS-GO:** switch the ignition off and open the driver's door.
- **To deactivate:** switch on the ignition.

When leaving the vehicle, always take the SmartKey with you and lock the vehicle. Anyone can start the engine if a valid SmartKey has been left inside the vehicle.

**i** The immobilizer is always deactivated when you start the engine.

In the event that the engine cannot be started when the starter battery is fully charged, the immobilizer may be faulty.

Contact an authorized Mercedes-Benz Center or call 1-800-FOR-MERCEdes (in the USA) or 1-800-387-0100 (in Canada).

### ATA (anti-theft alarm system)



- ▶ **To arm:** lock the vehicle with the SmartKey or KEYLESS-GO.



Indicator lamp ① flashes. The alarm system is armed after approximately 15 seconds.

- ▶ **To disarm:** unlock the vehicle with the SmartKey or KEYLESS-GO.

A visual and audible alarm is triggered if the alarm system is armed and you open:

- a door
- the vehicle with the mechanical key
- the trunk lid
- the hood

- ▶ **To turn the alarm off with the**

**SmartKey:** press the  or  button on the SmartKey.

The alarm is switched off.

or

- ▶ Insert the SmartKey into the ignition lock. The alarm is switched off.

- ▶ **To stop the alarm using KEYLESS-GO:** grasp the outside door handle. The SmartKey must be outside the vehicle. The alarm is switched off.

or

- ▶ Press the Start/Stop button on the dashboard. The SmartKey must be inside the vehicle. The alarm is switched off.

The alarm is not switched off, even if you close the open door that triggered it, for example.

- ❗ If the alarm stays on for more than 30 seconds, the mbrace emergency call system automatically sends a message to the Customer Assistance Center by text message or data connection. The emergency call system sends the message provided that:

- you have subscribed to the mbrace service
- the mbrace service has been activated properly
- the necessary mobile phone network is available

Useful information .....	76
SmartKey .....	76
Doors .....	82
Trunk .....	84
Side windows .....	88
Sliding sunroof .....	92

### Useful information

- i** This Operator's Manual describes all models and all standard and optional equipment of your vehicle available at the time of publication of the Operator's Manual. Country-specific differences are possible. Please note that your vehicle may not be equipped with all features described. This also applies to safety-related systems and functions.
- i** Read the information on qualified specialist workshops: (▷ page 26).

### SmartKey

#### Important safety notes

#### **⚠ WARNING**

If children are left unsupervised in the vehicle, they could:

- open the doors, thus endangering other people or road users.
- get out and disrupt traffic.
- operate the vehicle's equipment.

Additionally, children could set the vehicle in motion if, for example, they:

- release the parking brake.
- shifting the automatic transmission out of park position **P**
- Start the engine.

There is a risk of an accident and injury.

When leaving the vehicle, always take the SmartKey with you and lock the vehicle. Never leave children or animals unattended in the vehicle. Always keep the SmartKey out of reach of children.

#### **⚠ WARNING**

If persons, particularly children are subjected to prolonged exposure to extreme heat or cold, there is a risk of injury, possibly even fatal. Never leave children unattended in the vehicle.

#### **⚠ WARNING**

If you attach heavy or large objects to the SmartKey, the SmartKey could be unintentionally turned in the ignition lock. This could cause the engine to be switched off. There is a risk of an accident.

Do not attach any heavy or large objects to the SmartKey. Remove any bulky key rings before inserting the SmartKey into the ignition lock.

- !** Keep the SmartKey away from strong magnetic fields. Otherwise, the remote control function could be affected. Strong magnetic fields can occur in the vicinity of powerful electrical installations.

- Do not keep the SmartKey:
  - with electronic devices, e.g. a mobile phone or another SmartKey
  - with metallic objects, e.g. coins or metal foil
  - inside metallic objects, e.g. a metal case
 This can affect the functionality of the SmartKey.

### SmartKey functions

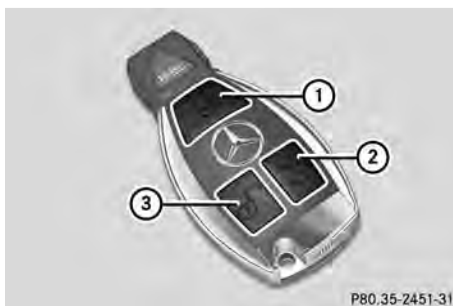

P80.35-2451-31

- ① To lock the vehicle
- ② To unlock the trunk lid
- ③ To unlock the vehicle

- **To unlock centrally:** press the button.

If you do not open the vehicle within approximately 40 seconds of unlocking:

- the vehicle is locked again.
- the theft deterrent locking system is armed again.

► **To lock centrally:** press the  button.

The SmartKey centrally locks/unlocks:

- the doors
- the trunk lid
- the fuel filler flap

The turn signals flash once when unlocking and three times when locking.

You can also set an audible signal to confirm that the vehicle has been locked. The audible signal can be activated and deactivated using the on-board computer (► page 232).

When it is dark, the surround lighting also comes on if it is activated in the on-board computer (► page 231).

## KEYLESS-GO

### General notes

Bear in mind that the engine can be started by any of the vehicle occupants if there is a KEYLESS-GO key in the vehicle.

### Locking/unlocking centrally

You can start, lock or unlock the vehicle using KEYLESS-GO. To do this, you only need carry the SmartKey with you. You can combine the functions of KEYLESS-GO with those of a conventional SmartKey. Unlock the vehicle by using KEYLESS-GO, for instance, and lock it using the  button on the SmartKey.

When locking or unlocking with KEYLESS-GO, the distance between the SmartKey and the corresponding door handle must not be greater than 3 ft (1 m).

KEYLESS-GO checks whether a valid SmartKey is in the vehicle by periodically establishing a radio connection between the vehicle and the SmartKey. This happens:

- when the external door handles are touched
- when starting the engine
- while the vehicle is in motion

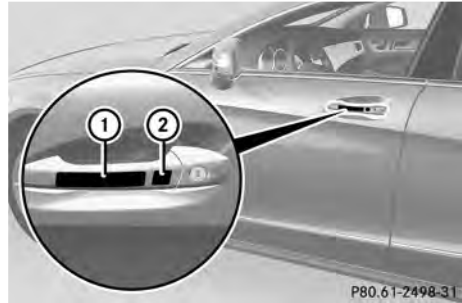

► **To unlock the vehicle:** touch the inner surface of the door handle.

► **To lock the vehicle:** touch sensor surface ①.



► **Convenience closing feature:** touch recessed sensor surface ② for an extended period.

► **To unlock the trunk lid:** pull the handle on the trunk lid.



Further information on the convenience closing feature (► page 90).

### Changing the settings of the locking system

You can change the settings of the locking system. This means that only the driver's door and the fuel filler flap are unlocked when the vehicle is unlocked. This is useful if you frequently travel on your own.



► **To change the setting:** press and hold down the  and  buttons on the SmartKey simultaneously for

approximately six seconds until the battery check lamp flashes twice (▷ page 79).



1 If the setting of the locking system is changed within the signal range of the vehicle, pressing the  or  button:

- locks or
- unlocks the vehicle

The SmartKey now functions as follows:

- ▶ **To unlock the driver's door:** press the  button once.
- ▶ **To unlock centrally:** press the  button twice.
- ▶ **To lock centrally:** press the  button.

The KEYLESS-GO function is changed as follows:

- ▶ **To unlock the driver's door:** touch the inner surface of the door handle on the driver's door.
- ▶ **To unlock centrally:** touch the inner surface of the door handle on the front-passenger door or the rear door.
- ▶ **To lock centrally:** touch the outer sensor surface on one of the door handles.
- ▶ **To restore the factory settings:** press and hold down the  and  buttons simultaneously for approximately six seconds until the battery check lamp flashes twice (▷ page 79).



## Mechanical key

### General notes

If the vehicle can no longer be locked or unlocked with the SmartKey, use the mechanical key.

If you use the mechanical key to unlock and open the driver's door or the trunk lid, the anti-theft alarm system will be triggered (▷ page 74).

There are several ways to turn off the alarm:

▶ **To turn the alarm off with the SmartKey:** press the  or  button on the SmartKey.

or

▶ Insert the SmartKey into the ignition lock.

or

▶ **To deactivate the alarm with KEYLESS-GO:** press the Start/Stop button in the ignition lock. The SmartKey must be in the vehicle.

or

▶ Lock or unlock the vehicle using KEYLESS-GO. The SmartKey must be outside the vehicle.

If you unlock the vehicle using the mechanical key, the fuel filler flap will not be unlocked automatically.

▶ **To unlock the fuel filler flap:** insert the SmartKey into the ignition lock.

## Removing the mechanical key



① Release catch

② Mechanical key

▶ Push release catch ① in the direction of the arrow and at the same time remove mechanical key ② from the SmartKey.



## SmartKey battery

### Important safety notes

#### WARNING





Batteries contain toxic and corrosive substances. If batteries are swallowed, it can result in severe health problems. There is a risk of fatal injury.

Keep batteries out of the reach of children. If a battery is swallowed, seek medical attention immediately.

Mercedes-Benz recommends that you have the batteries replaced at a qualified specialist workshop.

### Checking the battery



- ▶ Press the  or  button.
  - The battery is working properly if battery check lamp ① lights up briefly.
  - The battery is discharged if battery check lamp ① does not light up briefly.
- ▶ Change the battery (▷ page 79).
- i** If the SmartKey battery is checked within the signal reception range of the vehicle, pressing the  or  button:
  - locks or
  - unlocks the vehicle
- i** You can get a battery at any qualified specialist workshop.

### Replacing the battery

You require a CR 2025 3 V cell battery.

- ▶ Take the mechanical key out of the SmartKey (▷ page 78).









- ① Battery compartment cover
- ② Mechanical key
- ▶ Press mechanical key ② into the opening in the SmartKey in the direction of the arrow until battery compartment cover ① opens. Do not hold battery compartment cover ① closed while doing so.
- ▶ Remove battery compartment cover ①.



- ③ Battery
- ▶ Repeatedly tap the SmartKey against your palm until battery ③ falls out.
- ▶ Insert the new battery with the positive terminal facing upwards. Use a lint-free cloth to do so.
- ▶ Make sure that the surface of the battery is free of lint, grease and other contaminants.

- ▶ Insert the front tabs of battery compartment cover ① into the housing first and then press to close it.
- ▶ Insert mechanical key ② into the SmartKey (▷ page 78).
- ▶ Check the function of all SmartKey buttons on the vehicle.

## Problems with the SmartKey

Problem	Possible causes/consequences and ► Solutions
<p>You cannot lock or unlock the vehicle using the SmartKey.</p>	<p>The SmartKey battery is discharged or nearly discharged.</p> <ul style="list-style-type: none"> <li>► Try again to lock/unlock the vehicle using the remote control function of the SmartKey. Point the tip of the SmartKey at the driver's door handle from close range and press the  or  button.</li> </ul> <p>If this does not work:</p> <ul style="list-style-type: none"> <li>► Check the SmartKey battery (▷ page 79) and replace it if necessary (▷ page 79).</li> <li>► Lock (▷ page 84) or unlock (▷ page 84) the vehicle using the mechanical key.</li> </ul> <p>The SmartKey is faulty.</p> <ul style="list-style-type: none"> <li>► Lock (▷ page 84) or unlock (▷ page 84) the vehicle using the mechanical key.</li> <li>► Have the SmartKey checked at a qualified specialist workshop.</li> </ul>
<p>You can no longer lock or unlock the vehicle using KEYLESS-GO.</p>	<p>There is interference from a powerful source of radio waves.</p> <ul style="list-style-type: none"> <li>► Lock/unlock the vehicle using the remote control function of the SmartKey. Point the tip of the SmartKey at the driver's door handle from close range and press the  or  button.</li> </ul> <p>There is a malfunction with KEYLESS-GO.</p> <ul style="list-style-type: none"> <li>► Lock/unlock the vehicle using the remote control function of the SmartKey. Point the tip of the SmartKey at the driver's door handle from close range and press the  or  button.</li> <li>► Have KEYLESS-GO checked at a qualified specialist workshop.</li> </ul> <p>If this does not work:</p> <ul style="list-style-type: none"> <li>► Check the SmartKey battery (▷ page 79) and replace it if necessary (▷ page 79).</li> <li>► Lock (▷ page 84) or unlock (▷ page 84) the vehicle using the mechanical key.</li> </ul>
<p>You have lost a SmartKey.</p>	<ul style="list-style-type: none"> <li>► Have the SmartKey deactivated at a qualified specialist workshop.</li> <li>► Report the loss immediately to the vehicle insurers.</li> <li>► If necessary, have the locks changed as well.</li> </ul>
<p>You have lost the mechanical key.</p>	<ul style="list-style-type: none"> <li>► Report the loss immediately to the vehicle insurers.</li> <li>► If necessary, have the locks changed as well.</li> </ul>

Problem	Possible causes/consequences and ► Solutions
The engine cannot be started using the SmartKey.	<p>The on-board voltage is too low.</p> <ul style="list-style-type: none"> <li>► Switch off non-essential consumers, e.g. seat heating or interior lighting, and try to start the engine again.</li> </ul> <p>If this does not work:</p> <ul style="list-style-type: none"> <li>► Check the starter battery and charge it if necessary (▷ page 324).</li> </ul> <p>or</p> <ul style="list-style-type: none"> <li>► Jump-start the vehicle (▷ page 326).</li> </ul> <p>or</p> <ul style="list-style-type: none"> <li>► Consult a qualified specialist workshop.</li> </ul>
The engine cannot be started using KEYLESS-GO. The SmartKey is in the vehicle.	<p>A door is open. Therefore, the SmartKey cannot be detected as easily.</p> <ul style="list-style-type: none"> <li>► Close the door and try to start the vehicle again.</li> </ul> <p>There is interference from a powerful source of radio waves.</p> <ul style="list-style-type: none"> <li>► Start your vehicle with the SmartKey in the ignition lock.</li> </ul>

## Doors

### Important safety notes

#### WARNING

If children are left unsupervised in the vehicle, they could:

- open the doors, thus endangering other people or road users.
- get out and disrupt traffic.
- operate the vehicle's equipment.

Additionally, children could set the vehicle in motion if, for example, they:

- release the parking brake.
- shifting the automatic transmission out of park position **P**
- Start the engine.

There is a risk of an accident and injury.

When leaving the vehicle, always take the SmartKey with you and lock the vehicle. Never leave children or animals unattended in the vehicle. Always keep the SmartKey out of reach of children.

#### WARNING

If persons, particularly children are subjected to prolonged exposure to extreme heat or cold, there is a risk of injury, possibly even fatal. Never leave children unattended in the vehicle.

### Unlocking and opening doors from the inside

You can open a door from inside the vehicle even if it has been locked. If the vehicle has been locked with the SmartKey or with KEYLESS-GO, opening a door from the inside will trigger the anti-theft alarm system. Switch off the alarm (▷ page 74).

You can only open the rear doors from inside the vehicle if they are not secured by the child-proof locks (▷ page 65).



- ▶ **To unlock a front door:** pull door handle (2).  
Locking knob (1) pops up.  
The door is unlocked and can be opened.
- ▶ **To open a front door:** pull door handle (2).
- ▶ **To unlock a rear door:** pull up locking knob (1).  
The door is unlocked and can be opened.
- ▶ **To open a rear door:** pull door handle (2).

### Centrally locking and unlocking the vehicle from the inside

You can centrally lock or unlock the vehicle from the inside.

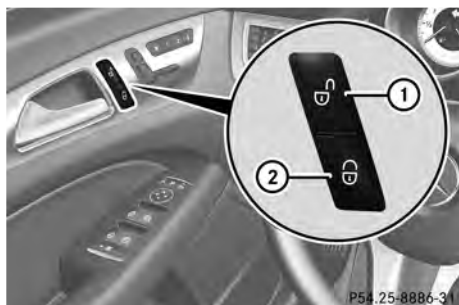

- ▶ **To unlock:** press button (1).
- ▶ **To lock:** press button (2).  
If all the doors are closed, the vehicle locks.

Meanwhile, the fuel filler flap will not be locked or unlocked.

You cannot unlock the vehicle centrally from the inside if the vehicle has been locked with the SmartKey or KEYLESS-GO.

You can open a door from inside the vehicle even if it has been locked.

You can only open the rear doors from inside the vehicle if they are not secured by the child-proof locks (▷ page 65).

If the vehicle has been locked using the locking button for the central locking, or has been locked automatically, and a door is opened from the inside:

- the vehicle will be fully unlocked if it had previously been fully unlocked
- only the door which has been opened from the inside is unlocked if only the driver's door had been previously unlocked

### Automatic locking feature

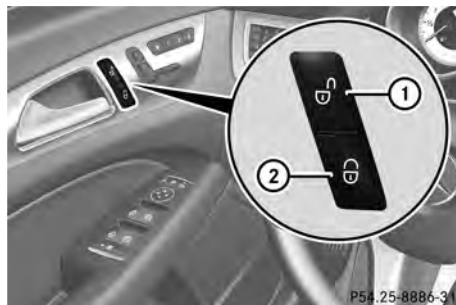

- ▶ **To deactivate:** press and hold button (1) for about five seconds until a tone sounds.
- ▶ **To activate:** press and hold button (2) for about five seconds until a tone sounds.

**i** If you press one of the two buttons and do not hear a tone, the relevant setting has already been selected.

The vehicle is locked automatically when the ignition is switched on and the wheels are turning.

You could therefore lock yourself out if:

- ▶ the vehicle is being pushed.
- ▶ the vehicle is being towed.
- ▶ the vehicle is on a roller dynamometer.

You can also switch the automatic locking function on and off using the on-board computer (▷ page 232).

### Unlocking the driver's door (mechanical key)

If the vehicle can no longer be unlocked with the SmartKey, use the mechanical key.

- ▶ Take the mechanical key out of the SmartKey (▷ page 78).
- ▶ Insert the mechanical key into the lock of the driver's door as far as it will go.

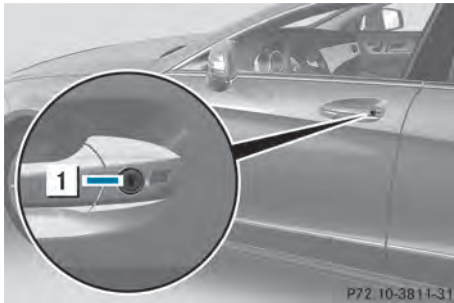

**1** To unlock

- ▶ Turn the mechanical key counter-clockwise to position **1**.  
The door is unlocked.
- ▶ Turn the mechanical key back and remove it.
- ▶ Insert the mechanical key into the SmartKey.

If you use the mechanical key to unlock and open the driver's door, the anti-theft alarm system will be triggered (▷ page 74).

### Locking the vehicle (mechanical key)

If the vehicle can no longer be locked with the SmartKey, use the mechanical key.

- ▶ Open the driver's door.
- ▶ Close the front-passenger door, the rear doors and the trunk lid.
- ▶ Press the locking button (▷ page 83).
- ▶ Check whether the locking knobs on the front-passenger door and the rear doors are still visible. Press down the locking knobs manually, if necessary (▷ page 82).
- ▶ Close the driver's door.
- ▶ Take the mechanical key out of the SmartKey (▷ page 78).
- ▶ Insert the mechanical key into the lock of the driver's door as far as it will go.

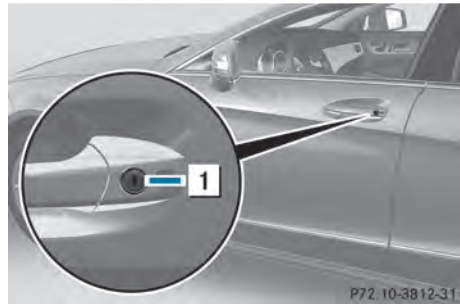

**1** To lock

- ▶ Turn the mechanical key clockwise as far as it will go to position **1**.
- ▶ Turn the mechanical key back and remove it.
- ▶ Make sure that the doors and the trunk lid are locked.
- ▶ Insert the mechanical key into the SmartKey.

## Trunk

### Important safety notes

#### WARNING

Combustion engines emit poisonous exhaust gases such as carbon monoxide. Exhaust gases can enter the vehicle interior if the trunk lid is open when the engine is running,

especially if the vehicle is in motion. There is a risk of poisoning.

Always switch off the engine before opening the trunk lid. Never drive with the trunk lid open.

### **WARNING**

If persons, particularly children are subjected to prolonged exposure to extreme heat or cold, there is a risk of injury, possibly even fatal. Never leave children unattended in the vehicle.

- ❗ The trunk lid swings upwards when opened. Therefore, make sure that there is sufficient clearance above the trunk lid.

- ① Opening dimensions of the trunk lid (▷ page 379).

You should preferably place luggage or loads in the cargo compartment. Observe the loading guidelines (▷ page 278).

Do not leave the SmartKey in the trunk. You could otherwise lock yourself out.

**Vehicles without trunk lid remote closing feature:** the trunk lid can be:

- opened and closed manually from outside
- opened automatically from outside
- opened automatically from inside
- locked separately
- unlocked with the mechanical key
- opened with the emergency release button

**Vehicles with trunk lid remote closing feature:** the trunk lid can be:

- opened and closed manually from outside
- opened and closed automatically from outside
- opened and closed automatically from inside
- locked separately
- unlocked with the mechanical key
- opened with the emergency release button

## Opening/closing from outside

### Opening

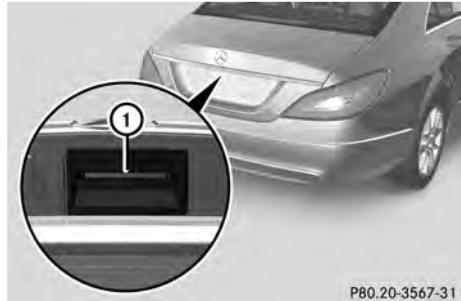

P80.20-3567-31

- ▶ Press the  button on the SmartKey.
- ▶ Pull handle ①.

### Closing

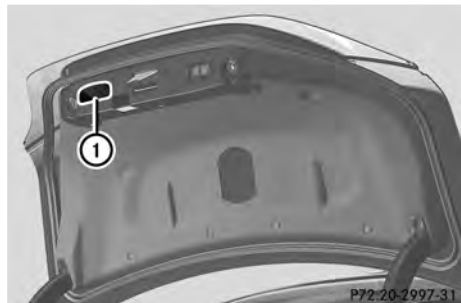

P72.20-2997-31

- ▶ Pull the trunk lid down using recess ①.
- ▶ If necessary, lock the vehicle with the  button on the SmartKey (▷ page 76) or with KEYLESS-GO (▷ page 77).

- ① If a KEYLESS-GO key is detected in the trunk, the trunk lid cannot be locked and will open again.

## Opening/closing automatically from outside

### Important safety notes

#### WARNING

Combustion engines emit poisonous exhaust gases such as carbon monoxide. Exhaust gases can enter the vehicle interior if the trunk lid is open when the engine is running, especially if the vehicle is in motion. There is a risk of poisoning.

Always switch off the engine before opening the trunk lid. Never drive with the trunk lid open.

- ❗ The trunk lid swings upwards when opened. Therefore, make sure that there is sufficient clearance above the trunk lid.

- i Opening dimensions of the trunk lid (▷ page 379).

### Opening

You can open the trunk lid automatically using the SmartKey or the handle in the trunk lid.

- ▶ Press and hold the  button on the SmartKey until the trunk lid opens.

or

- ▶ If the trunk is unlocked, pull the trunk lid handle and release it again immediately (▷ page 85).

### Closing

#### WARNING

Parts of the body could become trapped during automatic closing of the trunk lid. Moreover, people, e.g. children, may be standing in the closing area or may enter the closing area during the closing process. There is a risk of injury.

Make sure that nobody is in the vicinity of the closing area during the closing process.

Use one of the following options to stop the closing process:

- Press the  button on the key.
- press the remote operating switch on the driver's door.
- Press the closing or locking button on the trunk lid.
- Pull the trunk lid handle.

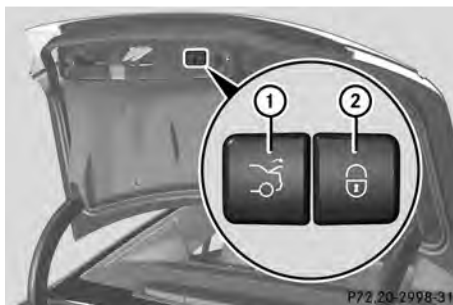

Example: closing and locking button (vehicle with the trunk lid remote closing feature and KEYLESS-GO)

- ① Closing button
- ② Locking button

- ▶ **To close:** press closing button ① in the trunk lid.

**Vehicles with the trunk lid remote closing feature and KEYLESS-GO:** you can simultaneously close and lock the trunk lid.

- ▶ Press locking button ② in the trunk lid.

- i If you leave a KEYLESS-GO key in the trunk, the trunk lid will not lock.

## Opening/closing automatically from inside

### Important safety notes

#### WARNING

Parts of the body could become trapped during automatic closing of the trunk lid. Moreover, people, e.g. children, may be standing in the closing area or may enter the



closing area during the closing process. There is a risk of injury.

Make sure that nobody is in the vicinity of the closing area during the closing process.

Use one of the following options to stop the closing process:

- Press the  button on the key.
- press the remote operating switch on the driver's door.
- Press the closing or locking button on the trunk lid.
- Pull the trunk lid handle.

#### **WARNING**

The trunk lid can be automatically opened or closed even if the SmartKey is not in the vehicle. If children are left unsupervised in the vehicle, they could activate the functions. There is a risk of injury.

When leaving the vehicle, always take the SmartKey with you and lock the vehicle. Never leave children unsupervised in the vehicle.

#### **WARNING**

Combustion engines emit poisonous exhaust gases such as carbon monoxide. Exhaust gases can enter the vehicle interior if the trunk lid is open when the engine is running, especially if the vehicle is in motion. There is a risk of poisoning.

Always switch off the engine before opening the trunk lid. Never drive with the trunk lid open.

- i** Opening dimensions of the trunk lid (▷ page 379).

## Opening and closing



- ▶ **To open:** pull remote operating switch for trunk lid ① until the trunk lid opens.
- ▶ **To close:** press remote operating switch for trunk lid ① until the trunk lid is closed.

You can open the trunk lid from the driver's seat when the vehicle is stationary and unlocked.

### Unlocking the trunk (mechanical key)

- !** The trunk lid swings upwards when opened. Therefore, make sure that there is sufficient clearance above the trunk lid.

If the trunk cannot be unlocked with the SmartKey or KEYLESS-GO, use the mechanical key.

If you use the mechanical key to unlock and open the trunk lid, the anti-theft alarm system will be triggered (▷ page 74).

- ▶ Take the mechanical key out of the SmartKey (▷ page 78).
- ▶ Insert the mechanical key into the trunk lid lock as far as it will go.

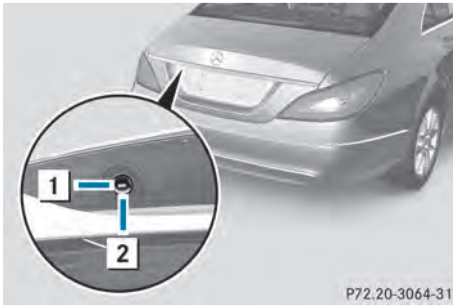

P72.20-3064-31

- 1 Neutral position.
- 2 To unlock
- ▶ Turn the mechanical key counter-clockwise from position 1 as far as it will go to position 2. The trunk is unlocked.
- ▶ Turn the mechanical key back to position 1 and remove it.
- ▶ Insert the mechanical key into the SmartKey.

### Trunk emergency release

You can open the trunk lid from inside the vehicle with the emergency release button.

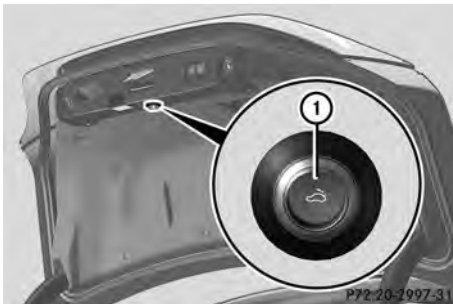

P72.20-1997-31

- ▶ Press emergency release button 1 briefly. The trunk lid unlocks and opens.

The trunk lid can be unlocked and opened with the trunk lid emergency release when the vehicle is stationary or while driving.

The trunk lid emergency release does not open the trunk lid if the battery is disconnected or discharged.

Trunk lid emergency release light:

- emergency release button 1 flashes for 30 minutes after the trunk lid is opened
- emergency release button 1 flashes for 60 minutes after the trunk lid is closed

## Side windows

### Important safety notes

#### ⚠ WARNING

While opening the side windows, body parts could become trapped between the side window and the door frame as the side window moves. There is a risk of injury.

Make sure that nobody touches the side window during the opening procedure. If somebody becomes trapped, release the switch or pull the switch to close the side window again.

#### ⚠ WARNING

While opening the side windows, body parts in the closing area could become trapped. There is a risk of injury.

Make sure that no body parts are in close proximity during the closing procedure. If somebody becomes trapped, release the switch or press the switch to open the side window again.

#### ⚠ WARNING

If children operate the side windows they could become trapped, particularly if they are left unsupervised. There is a risk of injury.

Activate the override feature for the rear side windows. When leaving the vehicle, always take the SmartKey with you and lock the vehicle. Never leave children unsupervised in the vehicle.

### Side window reversing feature

The side windows are equipped with an automatic reversing feature. If a solid object

blocks or restricts a side window during the closing process, the side window opens again automatically. However, the automatic reversing feature is only an aid and does not relieve you of the responsibility of paying attention when closing a side window.

### WARNING

The reversing feature does not react:

- to soft, light and thin objects, e.g. small fingers
- over the last 4 mm of the closing movement
- during resetting
- when closing the side window again manually immediately after automatic reversing

This means that the reversing feature cannot prevent someone being trapped in these situations. There is a risk of injury.

Make sure that no body parts are in close proximity during the closing procedure. If someone becomes trapped, press the switch to open the side window again.

## Opening and closing the side windows

The switches for all side windows are located on the driver's door. There is also a switch on each door for the corresponding side window.

The switches on the driver's door take precedence.

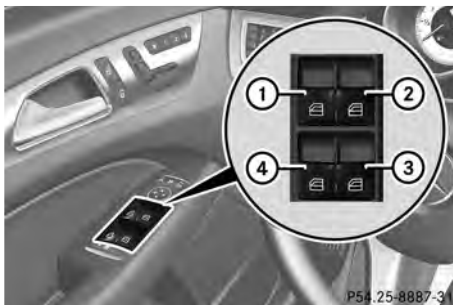

- ① Front left
- ② Front right

- ③ Rear right
- ④ Rear left

▶ Turn the SmartKey to position **1** or **2** in the ignition lock.

▶ **To open:** press the corresponding switch.

▶ **To close:** pull the corresponding switch.

**i** If you press the switch beyond the point of resistance, an automatic opening/closing process is started in the corresponding direction. You can stop automatic operation by operating the switch again.

**i** You can continue to operate the side windows after you switch off the engine or remove the SmartKey. This function is available for up to five minutes or until the driver's or front-passenger door is opened.

**i** When the override feature for the side windows is activated (▷ page 65), the side windows cannot be operated from the rear.

## Convenience opening



### General notes

You can ventilate the vehicle before you start driving. To do this, the SmartKey is used to carry out the following functions simultaneously:

- unlock the vehicle
- open the side windows
- open the sliding sunroof
- switch on the seat ventilation for the driver's seat

**i** The convenience opening feature can only be operated using the SmartKey. The SmartKey must be close to the driver's door handle.

### Convenience opening

- ▶ Point the tip of the SmartKey at the driver's door handle.
- ▶ Press and hold the  button until the side windows and the sliding sunroof are in the desired position.
- ▶ **To interrupt convenience opening:** release the  button.

### Convenience closing feature

#### Important safety notes

Information on the side window reversing feature (> page 88).

#### WARNING

The reversing feature does not react:

- to soft, light and thin objects, e.g. small fingers
- over the last 4 mm of the closing movement
- during resetting
- when closing the sliding sunroof again manually immediately after automatic reversing

This means that the reversing feature cannot prevent someone being trapped in these situations. There is a risk of injury.

Make sure that no body parts are in close proximity during the closing procedure.

If somebody becomes trapped:

- release the switch immediately, or
- during automatic operation, push the switch briefly in any direction

The closing process is stopped.



#### WARNING

When the convenience closing feature is operating, parts of the body could become trapped in the closing area of the side window and the sliding sunroof. There is a risk of injury.

Observe the complete closing procedure when the convenience closing feature is

operating. Make sure that no body parts are in close proximity during the closing procedure.

Proceed as follows if someone is trapped:  
With the SmartKey:

- release the  button.
- press and hold the  button until the side windows and the sliding sunroof or the panorama roof with power tilt/sliding panel open again.

Using KEYLESS-GO:

- release the sensor surface on the door handle.
- pull the door handle immediately and hold it.

The side windows and the sliding sunroof or the panorama roof with power tilt/sliding panel open.

### General notes

When you lock the vehicle, you can simultaneously:

- close the side windows
- close the sliding sunroof

### Using the SmartKey

The SmartKey must be close to the driver's door handle.

- ▶ Point the tip of the SmartKey at the driver's door handle.
- ▶ Press and hold the  button until the side windows and the sliding sunroof are fully closed.
- ▶ Make sure that all the side windows and the sliding sunroof are closed.

- ▶ **To interrupt convenience closing:** release the  button.

### Using KEYLESS-GO

The KEYLESS-GO key must be outside the vehicle. All the doors must be closed.

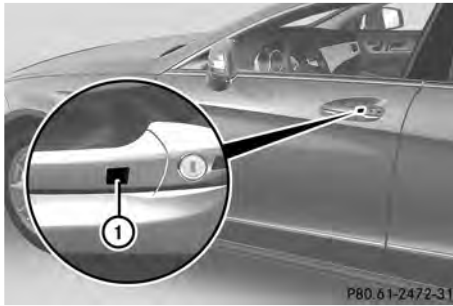

- ▶ Touch recessed sensor surface ① on the door handle until the side windows and the sliding sunroof are fully closed.
- ❗ Make sure you only touch recessed sensor surface ①.
- ▶ Make sure that all the side windows and the sliding sunroof are closed.
- ▶ **To interrupt convenience closing:** release recessed sensor surface ① on the door handle.

### Resetting the side windows

If a side window can no longer be closed fully, you must reset it.

- ▶ Close all the doors.
- ▶ Turn the SmartKey to position **1** or **2** in the ignition lock.
- ▶ Pull the corresponding switch on the door control panel until the side window is completely closed (▷ page 89).
- ▶ Hold the switch for an additional second.

If the side window opens again slightly:

- ▶ Immediately pull the corresponding switch on the door control panel until the side window is completely closed (▷ page 89).
- ▶ Hold the switch for an additional second.
- ▶ If the corresponding side window remains closed after the button has been released, the side window has been reset correctly. If this is not the case, repeat the steps above again.

### Problems with the side windows

#### WARNING

If you close a side window again immediately after it has been blocked or reset, the side window closes with increased or maximum force. The reversing feature is then not active. Parts of the body could be trapped in the closing area in the process. This poses an increased risk of injury or even fatal injury.

Make sure that no parts of the body are in the closing area. To stop the closing process, release the switch or push the switch again to reopen the side window.

Problem	Possible causes/consequences and ► Solutions
A side window cannot be closed because it is blocked by objects, e.g. leaves in the window guide.	<ul style="list-style-type: none"> <li>► Remove the objects.</li> <li>► Close the side window.</li> </ul>
A side window cannot be closed and you cannot see the cause.	<p>If a side window is obstructed during closing and reopens again slightly:</p> <ul style="list-style-type: none"> <li>► Immediately after the window blocks, pull the corresponding switch again until the side window has closed. The side window is closed with increased force.</li> </ul> <p>If a side window is obstructed again during closing and reopens again slightly:</p> <ul style="list-style-type: none"> <li>► Immediately after the window blocks, pull the corresponding switch again until the side window has closed. The side window is closed without the anti-entrapment feature.</li> </ul>

### Sliding sunroof

#### Important safety notes

#### WARNING

While opening and closing the sliding sunroof, body parts in close proximity could become trapped. There is a risk of injury.

Make sure that no body parts are in close proximity during the opening and closing procedures.

If somebody becomes trapped:

- release the switch immediately, or
- during automatic operation, push the switch briefly in any direction

The opening or closing procedure will be stopped.

#### WARNING

If children operate the sliding sunroof they could become trapped, particularly if they are left unsupervised. There is a risk of injury.

When leaving the vehicle, always take the SmartKey with you and lock the vehicle. Never leave children unsupervised in the vehicle.

- ❗ Only open the sliding sunroof if it is free of snow and ice. Otherwise, malfunctions may occur.

Do not allow anything to protrude from the sliding sunroof. Otherwise, the seals could be damaged.

**!** The weather can change abruptly. It could start to rain or snow. Make sure that the sliding sunroof is closed when you leave the vehicle. The vehicle electronics can be damaged if water enters the vehicle interior.

**i** Resonance noises can occur in addition to the usual airflow noises when the sliding sunroof is open. They are caused by minor pressure fluctuations in the vehicle interior. Change the position of the sliding sunroof or open a side window slightly to reduce or eliminate these noises.

### Sliding sunroof reversing feature

The sliding sunroof is equipped with an automatic reversing feature. If a solid object blocks or restricts the sliding sunroof during the closing process, the sliding sunroof opens again automatically. However, the automatic reversing feature is only an aid and does not relieve you of the responsibility of paying attention when closing the sliding sunroof.

#### **!** WARNING

The reversing feature does not react:

- to soft, light and thin objects, e.g. small fingers
- over the last 4 mm of the closing movement
- during resetting
- when closing the sliding sunroof again manually immediately after automatic reversing

This means that the reversing feature cannot prevent someone being trapped in these situations. There is a risk of injury.

Make sure that no body parts are in close proximity during the closing procedure.

If somebody becomes trapped:

- release the switch immediately, or
- during automatic operation, push the switch briefly in any direction

The closing process is stopped.

### Operating the sliding sunroof

#### Opening and closing

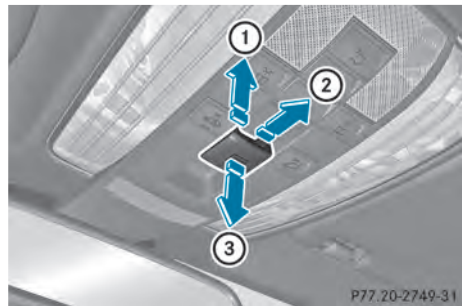

Overhead control panel

- ① To raise
- ② To open
- ③ To close/lower

▶ Turn the SmartKey to position **1** or **2** in the ignition lock.

▶ Press or pull the  switch in the corresponding direction.

**i** If you press the  switch beyond the point of resistance, an automatic opening/closing process is started in the corresponding direction. You can stop automatic operation by operating the switch again.

**i** The automatic opening and raising feature is available only when the sliding sunroof is closed.

The sun protection cover automatically opens along with the sliding sunroof. You can open or close the sun protection cover manually when the sliding sunroof is raised or closed.

**i** You can continue to operate the sliding sunroof after switching off the engine or

removing the SmartKey from the ignition lock. This function remains active for five minutes or until you open a front door.

## Resetting

---

- ❗ If the sliding sunroof still cannot be opened or closed fully after resetting, contact a qualified specialist workshop.

Reset the sliding sunroof if it does not move smoothly.

- ▶ Turn the SmartKey to position **2** in the ignition lock.
- ▶ Raise the sliding sunroof fully at the rear (▷ page 93).
- ▶ Keep the  switch pressed for another second.
- ▶ Make sure that the sliding sunroof can be fully opened and closed again (▷ page 93).
- ▶ If this is not the case, repeat the steps above again.



## Problems with the sliding sunroof

### WARNING

If you close the sliding sunroof again immediately after it has been blocked or reset, the sliding sunroof closes with increased or maximum force. The reversing feature is then not active. Parts of the body could be trapped in the closing area in the process. This poses an increased risk of injury or even fatal injury.



Make sure that no parts of the body are in the closing area.

If somebody becomes trapped:

- release the switch immediately, or
- during automatic operation, push the switch briefly in any direction

The closing process is stopped.

-  If the sliding sunroof still cannot be opened or closed as a result of a malfunction, contact a qualified specialist workshop.

Problem	Possible causes/consequences and ► Solutions
<p>The sliding sunroof cannot be closed and you cannot see the cause.</p>	<p>If the sliding sunroof is obstructed during closing and reopens again slightly:</p> <ul style="list-style-type: none"> <li>► Immediately after the sliding sunroof blocks, pull the  switch in the overhead control panel down to the point of resistance and hold it until the sliding sunroof is closed. The sliding sunroof is closed with increased force.</li> </ul> <p>If the sliding sunroof is obstructed again during closing and then reopens slightly:</p> <ul style="list-style-type: none"> <li>► Immediately after the sliding sunroof blocks, pull the  switch in the overhead control panel down to the point of resistance and hold it until the sliding sunroof is closed. The sliding sunroof is closed without the anti-entrapment feature.</li> </ul>



Useful information .....	98
Correct driver's seat position .....	98
Seats .....	99
Steering wheel .....	106
Mirrors .....	109
Memory function .....	112

### Useful information

- 1 This Operator's Manual describes all models and all standard and optional equipment of your vehicle available at the time of publication of the Operator's Manual. Country-specific differences are possible. Please note that your vehicle may not be equipped with all features described. This also applies to safety-related systems and functions.
- i Read the information on qualified specialist workshops: (▷ page 26).

### Correct driver's seat position

#### WARNING

You could lose control of your vehicle if you do the following while driving:

- adjust the driver's seat, head restraint, steering wheel or mirrors
- fasten the seat belt

There is a risk of an accident.

Adjust the driver's seat, head restraint, steering wheel and mirror and fasten your seat belt before starting the engine.



P91.40-3308-3.1

- ▶ Observe the safety guidelines on seat adjustment (▷ page 99).
- ▶ Make sure that seat ③ is adjusted properly.

Electrical seat adjustment (▷ page 100)

When adjusting the seat, make sure that:

- you are as far away from the driver's air bag as possible.
- you are sitting in a normal upright position.
- you can fasten the seat belt properly.
- you have moved the backrest to an almost vertical position.
- you have set the seat cushion angle so that your thighs are gently supported.
- you can depress the pedals properly.

- ▶ Check whether the head restraint is adjusted properly.

When doing so, make sure that you have adjusted the head restraint so that the back of your head is supported at eye level by the center of the head restraint.

- ▶ Observe the safety guidelines on steering wheel adjustment (▷ page 106).
- ▶ Make sure that steering wheel ① is adjusted properly.

Adjusting the steering wheel electrically (▷ page 106)

When adjusting the steering wheel, make sure that:

- you can hold the steering wheel with your arms slightly bent.
- you can move your legs freely.
- you can see all the displays in the instrument cluster clearly.
- ▶ Observe the safety guidelines for seat belts (▷ page 55).
- ▶ Check whether you have fastened seat belt ② properly (▷ page 56).

The seat belt should:

- fit snugly across your body
  - be routed across the middle of your shoulder
  - be routed in your pelvic area across the hip joints
- Before starting off, adjust the rear-view mirror and the exterior mirrors in such a way that you have a good view of road and traffic conditions (▷ page 109).
- **Vehicles with a memory function:** save the seat, steering wheel and exterior mirror settings with the memory function (▷ page 112).

## Seats

### Important safety notes

#### WARNING

Children could become trapped if they adjust the seats, particularly when unattended. There is a risk of injury.

When leaving the vehicle, always take the SmartKey with you and lock the vehicle. Never leave children unsupervised in the vehicle.

#### WARNING

You could lose control of your vehicle if you do the following while driving:

- adjust the driver's seat, head restraint, steering wheel or mirrors
- fasten the seat belt

There is a risk of an accident.

Adjust the driver's seat, head restraint, steering wheel and mirror and fasten your seat belt before starting the engine.

#### WARNING

If you adjust the seat height carelessly, you or other vehicle occupants could be trapped and thereby injured. Children in particular could accidentally press the electrical seat

adjustment buttons and become trapped. There is a risk of injury.

While moving the seats, make sure that your hands or other body parts do not get under the lever assembly of the seat adjustment system.

#### WARNING

When you adjust a seat, you or other vehicle occupants could become trapped, e.g. on the seat guide rail. There is a risk of injury.

Make sure when adjusting a seat that no one has any body parts in the sweep of the seat.

#### WARNING

If head restraints are not installed and adjusted correctly, they cannot provide protection as intended. There is an increased risk of injury in the head and neck area, e.g. in the event of an accident or when braking.

Always drive with the head restraints installed. Before driving off, make sure for every vehicle occupant that the center of the head restraint supports the back of the head at about eye level.

#### WARNING

The seat belt does not offer the intended level of protection if the backrest is not in the upright position. When braking or in the event of an accident, you could slide underneath the seat belt and sustain abdomen or neck injuries, for example. This poses an increased risk of injury or even fatal injury.

Adjust the seat properly before beginning your journey. Always make sure that the seat is in the upright position.

#### WARNING

According to accident statistics, children are safer when properly restrained on the rear seats than on the front-passenger seat. Thus, we strongly recommend that children be placed in the rear seat whenever possible. Regardless of seating position, children 12 years old and under must be seated and

properly secured in an appropriately sized child restraint system or booster seat recommended for the size and weight of the child. For additional information, see the "Children in the vehicle" section.

A child's risk of serious or fatal injuries is significantly increased if the child restraints are not properly secured in the vehicle and/or the child is not properly secured in the child restraint.

**!** To avoid damage to the seats and the seat heating, observe the following information:

- keep liquids from spilling on the seats. If liquid is spilled on the seats, dry them as soon as possible.
- if the seat covers are damp or wet, do not switch on the seat heating. The seat heating should also not be used to dry the seats.
- clean the seat covers as recommended; see "Interior care".
- do not transport heavy loads on the seats. Do not place sharp objects on the seat cushions, e.g. knives, nails or tools. The seats should only be occupied by passengers, if possible.
- when the seat heating is in operation, do not cover the seats with insulating materials, e.g. blankets, coats, bags, seat covers, child seats or booster seats.

**!** Make sure that there are no objects in the footwell or behind the seats when resetting the seats. There is a risk that the seats and/or the objects could be damaged.

**i** The head restraints in the front seats are installed with the NECK-PRO system (▷ page 53). For this reason, it is not possible to remove the head restraints from the front seats.

For more information, contact a qualified specialist workshop.

**i** Further related subjects:

## Adjusting the seats

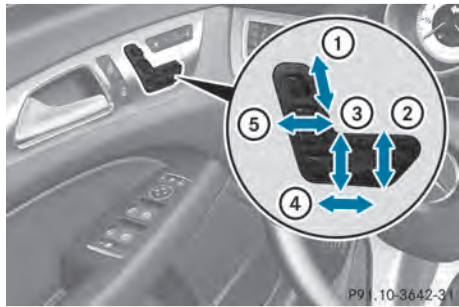

① Head restraint height

② Seat cushion angle

③ Seat height

④ Seat fore-and-aft adjustment

⑤ Backrest angle

**i** If PRE-SAFE® is triggered, the front-passenger seat will be moved to a better position if it was previously in an unfavorable position.

**i** You can store the seat settings using the memory function (▷ page 112).

**i** Vehicles with the through-loading feature: if you fold down a rear seat backrest, the respective front seat is moved forwards slightly in order to avoid contact.

## Adjusting the head restraints

### Important safety notes

#### **!** WARNING

You could lose control of your vehicle if you do the following while driving:

- adjust the driver's seat, head restraint, steering wheel or mirrors
- fasten the seat belt

There is a risk of an accident.

Adjust the driver's seat, head restraint, steering wheel and mirror and fasten your seat belt before starting the engine.

**⚠ WARNING**

If head restraints are not installed and adjusted correctly, they cannot provide protection as intended. There is an increased risk of injury in the head and neck area, e.g. in the event of an accident or when braking. Always drive with the head restraints installed. Before driving off, make sure for every vehicle occupant that the center of the head restraint supports the back of the head at about eye level.

**General notes**

Observe the important safety guidelines for seats (▷ page 99).

Do not rotate the head restraints of the front and rear seats. Otherwise, you cannot adjust the height and angle of the head restraints to the correct position.

**Adjusting the height of the head restraints electrically**



- ▶ **To adjust the head restraint height:** slide switch for head restraint adjustment ① up or down in the direction of the arrow.

**Adjusting the luxury head restraints**

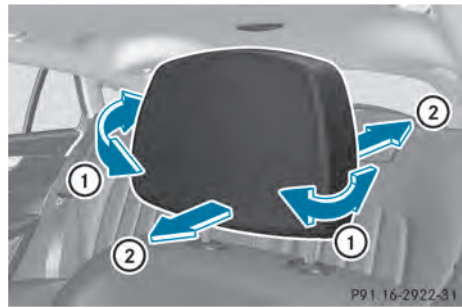

- ▶ **To adjust the side bolsters of the head restraint:** push or pull right or left-hand side bolster ① into the desired position.
- ▶ **To adjust the angle of the head restraint:** push or pull the head restraint in the direction of arrow ②.
- ❗ Adjust the head restraint so that the back of your head is as close to the head restraint as possible.

**Rear seat head restraints**

**Important safety notes**

**⚠ WARNING**

For your protection, drive only with properly positioned head restraints. Adjust the head restraints so that they are as close as possible to your head. This will reduce the potential for injury to the head and neck in the event of an accident or similar situation.

Whenever the rear seats are occupied, only drive the vehicle with the head restraints installed and engaged. Head restraints are intended to help reduce injuries during an accident.

### Adjusting the rear seat head restraint angle

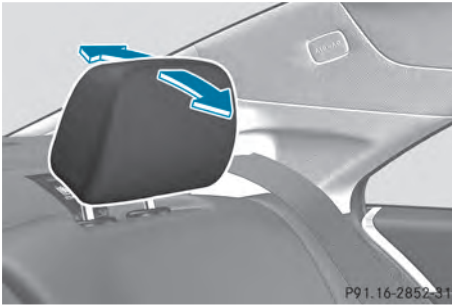

- ▶ Pull or push the top of the head restraint until it is in the desired position.

### Removing and installing the rear seat head restraints

#### WARNING

If head restraints are not installed and adjusted correctly, they cannot provide protection as intended. There is an increased risk of injury in the head and neck area, e.g. in the event of an accident or when braking.

Always drive with the head restraints installed. Before driving off, make sure for every vehicle occupant that the center of the head restraint supports the back of the head at about eye level.

- ! Make sure that the rear window roller sunblind has been retracted before the rear head restraints are removed. You could otherwise damage the roller sunblind.

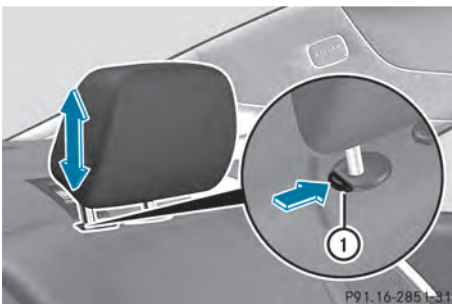

- ▶ **To remove:** pull the head restraint up to the stop.
- ▶ Press release catch ① and pull the head restraint out of the guides.
- ▶ **To re-install:** insert the head restraint so that the notches on the bar are on the left when viewed in the direction of travel.
- ▶ Push the head restraint down until you hear it engage in position.

### Adjusting the multicontour seat

The multicontour seat function is only available for vehicles in Canada.

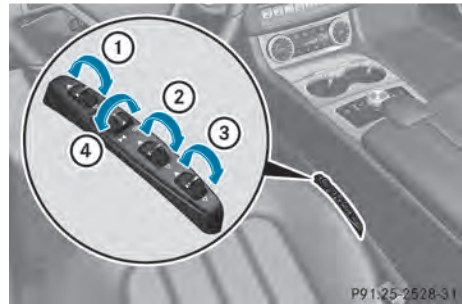

- ① To adjust the thigh cushion
- ② To adjust the backrest contour in the lumbar region
- ③ To adjust the backrest contour in the upper back region
- ④ To adjust the side bolsters of the seat backrest

You can adjust the contour of the front seats individually so as to provide optimum support for your back and sides.

- ▶ Turn the SmartKey to position **2** in the ignition lock (▷ page 147).



## Adjusting the active multicontour seat

### Overview

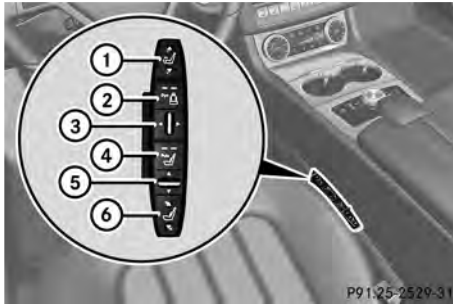

- ① To adjust the seat cushion length
- ② To switch the dynamic function on or off
- ③ To adjust the side bolsters of the seat backrest
- ④ To switch the massage function on or off
- ⑤ To adjust the contour of the backrest to increase/decrease support
- ⑥ To adjust the height/depth of the backrest contour

The active multicontour seat on the driver's side automatically adapts the sides of the backrest to your current driving style. You can adjust the contour of the seat individually so as to provide optimum support for your back and sides.

### Dynamic function

The dynamic function adjusts the air cushions in the side bolsters of the seat backrests to ensure ideal lateral support at all times. You can choose between two levels.

- ▶ **To switch on:** press button ② once or twice until the desired level is set. One or two indicator lamps in button ② light up.
- ▶ **To switch off:** press button ② repeatedly until all indicator lamps in button ② go out.

You can select the following levels:

Level 1 (one indicator lamp)	Standard setting: slightly increased lateral support and slow build-up of air pressure in the side bolsters of the seat backrest.
Level 2 (two indicator lamps)	Sport setting: increased lateral support and fast build-up of pressure in the side bolsters of the seat backrest.

### Massage function (PULSE)

The massage function helps you to prevent muscle tension on long journeys. You can choose between two levels.

- ▶ **To switch on:** press button ④ once or twice until the desired level is set. One or two indicator lamps in button ④ light up. The air cushions in the lumbar region vibrate for approximately 20 minutes.

### Adjusting the 4-way lumbar support

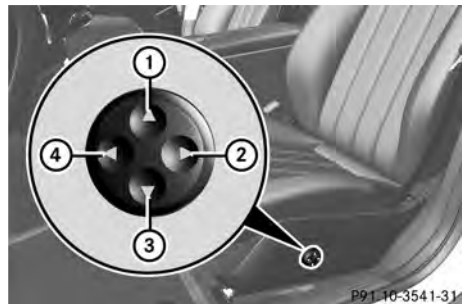

- ① To raise the backrest contour
- ② To soften the backrest contour
- ③ To lower the backrest contour
- ④ To harden the backrest contour

You can adjust the contour of the front seat backrests individually to provide optimum support for your back.

### Switching the seat heating on/off

#### Activating/deactivating

##### WARNING

Repeatedly switching on the seat heating can cause the seat cushion and backrest pads to become very hot. The health of persons with limited temperature sensitivity or a limited ability to react to excessively high temperatures may be affected or they may even suffer burn-like injuries. There is a risk of injury.

Therefore, do not switch the seat heating on repeatedly.



Driver's and front-passenger seat

The three red indicator lamps in the button indicate the heating level you have selected.

The system automatically switches down from level **3** to level **2** after approximately eight minutes.

The system automatically switches down from level **2** to level **1** after approximately ten minutes.

The system automatically switches off approximately 20 minutes after it is set to level **1**.

► Turn the SmartKey to position **1** or **2** in the ignition lock (► page 147).

► **To switch on:** press button ① repeatedly until the desired heating level is set.

► **To switch off:** press button ① repeatedly until all the indicator lamps go out.

**i** If the battery voltage is too low, the seat heating may switch off.

## Problems with the seat heating

Problem	Possible causes/consequences and ► Solutions
The seat heating has switched off prematurely or cannot be switched on.	<p>The on-board voltage is too low because too many electrical consumers are switched on.</p> <ul style="list-style-type: none"> <li>► Switch off electrical consumers that you do not need, such as the rear window defroster or interior lighting.</li> </ul> <p>Once the battery is sufficiently charged, the seat heating will switch back on automatically.</p>

## Switching the seat ventilation on/off

### Activating/deactivating



The three blue indicator lamps in the buttons indicate the ventilation level you have selected.

- Turn the SmartKey to position **2** in the ignition lock (► page 147).
- **To switch on:** press button ① repeatedly until the desired ventilation level is set.
- **To switch off:** press button ① repeatedly until all the indicator lamps go out.

- i** If the battery voltage is too low, the seat ventilation may switch off.
- i** You can open the side windows and the sliding sunroof using the "Convenience opening" feature (► page 89). The seat ventilation of the driver's seat automatically switches to the highest level.

### Problems with the seat ventilation

Problem	Possible causes/consequences and ► Solutions
The seat ventilation has switched off prematurely or cannot be switched on.	<p>The on-board voltage is too low because too many electrical consumers are switched on.</p> <p>► Switch off electrical consumers that you do not need, such as the rear window defroster or interior lighting. Once the battery is sufficiently charged, the seat ventilation will switch back on automatically.</p>

### Steering wheel

#### Important safety notes

#### WARNING

You could lose control of your vehicle if you do the following while driving:

- adjust the driver's seat, head restraint, steering wheel or mirrors
- fasten the seat belt

There is a risk of an accident.

Adjust the driver's seat, head restraint, steering wheel and mirror and fasten your seat belt before starting the engine.

#### WARNING

Children could injure themselves if they adjust the steering wheel. There is a risk of injury.

When leaving the vehicle, always take the SmartKey with you and lock the vehicle. Never leave children unsupervised in the vehicle.

### Adjusting the steering wheel electrically

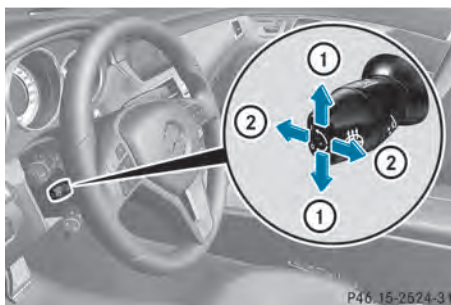

- ① To adjust the steering wheel height
- ② To adjust the steering wheel position (fore-and-aft adjustment)

#### Further related subjects:

- EASY-ENTRY/EXIT feature (► page 108)
- Storing settings (► page 112)

## Steering wheel heating

### Activating/deactivating

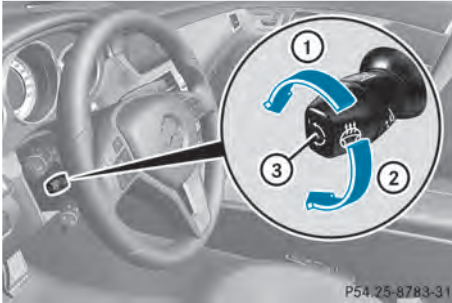

- ▶ Turn the SmartKey to position **2** in the ignition lock (▶ page 147).
- ▶ **To switch on/off:** turn the lever in the direction of arrow **1** or **2**.  
Indicator lamp **3** lights up or goes out.

Vehicles without KEYLESS-GO: when you remove the SmartKey from the ignition lock, the steering wheel heating is deactivated.

Vehicles with KEYLESS-GO: when you switch off the ignition and open the driver's door, the steering wheel heating is deactivated.

- i** The steering wheel heating may switch off temporarily if:
  - the temperature in the vehicle interior is above 86 °F (30 °C).
  - the temperature of the steering wheel is above 95 °F (35 °C).
 Indicator lamp **3** remains on.

## Problems with the steering wheel heating

Problem	Possible causes/consequences and ► Solutions
If the steering wheel heating indicator lamp is flashing, the steering wheel heating has switched off automatically.	<p>The on-board voltage is too low because too many electrical consumers are switched on.</p> <p>► Switch off electrical consumers that you do not need, such as the rear window defroster or interior lighting. Once the battery is sufficiently charged, the steering wheel heating will switch back on automatically.</p>

### EASY-ENTRY/EXIT feature

#### Important safety notes

##### WARNING

When the EASY-ENTRY/EXIT feature adjusts the steering wheel, you and other vehicle occupants – particularly children – could become trapped. There is a risk of injury.

While the EASY-ENTRY/EXIT feature is making adjustments, make sure that no one has any body parts in the sweep of the steering wheel.

If somebody becomes trapped:

- press one of the memory function position buttons, or
- move the switch for steering wheel adjustment in the opposite direction to that in which the steering wheel is moving.

The adjustment process is stopped.

##### WARNING

If children activate the EASY-ENTRY/EXIT feature, they can become trapped, particularly when unattended. There is a risk of injury.

When leaving the vehicle, always take the SmartKey with you and lock the vehicle. Never leave children unsupervised in the vehicle.

##### WARNING

If you drive off while the EASY-ENTRY/EXIT feature is making adjustments, you could lose

control of the vehicle. There is a risk of an accident.

Always wait until the adjustment process is complete before driving off.

The EASY-ENTRY/EXIT feature makes getting in and out of your vehicle easier.

You can activate and deactivate the EASY-ENTRY/EXIT feature in the on-board computer (► page 233).

#### Position of the steering wheel when the EASY-ENTRY/EXIT feature is active

The steering wheel swings upwards when you:

- remove the SmartKey from the ignition lock
- **with KEYLESS-GO:** open the driver's door; KEYLESS-GO must be in position **1** in the ignition lock
- **with the SmartKey:** open the driver's door; the SmartKey must be in position **0** or **1** in the ignition lock (► page 147)

 The steering wheel only moves upwards if it has not already reached the upper end stop.

## Position of the steering wheel for driving

The steering wheel is moved to the last selected position when:

- the driver's door is closed
- **with KEYLESS-GO:** you press the Start/Stop button once on vehicles with KEYLESS-GO  
or
- **with the SmartKey:** you insert the SmartKey into the ignition lock.

When you close the driver's door with the ignition switched on, the steering wheel is also automatically moved to the previously set position.

The last position of the steering wheel is stored when you switch off the ignition or when you store the setting with the memory function (▷ page 112).

## Crash-responsive EASY-EXIT feature

If the crash-responsive EASY-EXIT feature is triggered in an accident, the steering column will move upwards when the driver's door is opened. This occurs irrespective of the position of the SmartKey in the ignition lock. This makes it easier to exit the vehicle and rescue the occupants.

The crash-responsive EASY-EXIT feature is only operational if the EASY-EXIT/ENTRY feature is activated in the on-board computer. (▷ page 233)

## Mirrors

### Exterior mirrors

#### Adjusting the exterior mirrors

#### WARNING

You could lose control of your vehicle if you do the following while driving:

- adjust the driver's seat, head restraint, steering wheel or mirrors
- fasten the seat belt

There is a risk of an accident.

Adjust the driver's seat, head restraint, steering wheel and mirror and fasten your seat belt before starting the engine.

#### WARNING

The exterior mirror on the front-passenger side reduces the size of the image. Visible objects are actually closer than they appear. This means that you could misjudge the distance from road users traveling behind, e.g. when changing lane. There is a risk of an accident.

For this reason, always make sure of the actual distance from the road users traveling behind by glancing over your shoulder.



- ▶ Turn the SmartKey to position 1 or 2 in the ignition (▷ page 147).
- ▶ Press button ① for the left-hand exterior mirror or button ② for the right-hand exterior mirror. The indicator lamp in the corresponding button lights up in red.

The indicator lamp goes out again after some time. You can adjust the selected mirror using adjustment button ③ as long as the indicator lamp is lit.

- ▶ Press adjustment button ③ up, down, or to the left or right until you have adjusted the exterior mirror to the correct position. You should have a good overview of traffic conditions.

The convex exterior mirrors provide a larger field of vision.

After the engine has been started, the exterior mirrors are automatically heated if the rear window defroster is switched on and the outside temperature is low. Heating takes a maximum of 10 minutes.

- ① The exterior mirrors can also be heated manually by switching on the rear window defroster.

### Folding the exterior mirrors in or out electrically

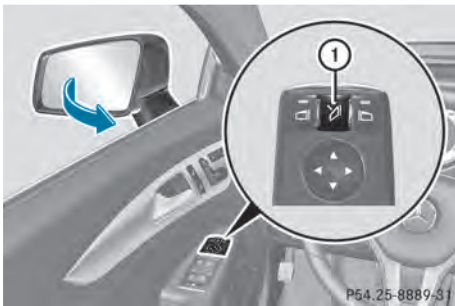

- ▶ Turn the SmartKey to position **1** or **2** in the ignition (▷ page 147).
- ▶ Briefly press button ①. Both exterior mirrors fold in or out.
- ① Make sure that the exterior mirrors are always folded out fully while driving. They could otherwise vibrate.
- ① If you are driving faster than 30 mp/h (47 km/h), you can no longer fold in the exterior mirrors.

### Setting the exterior mirrors

If the battery has been disconnected or completely discharged, the exterior mirrors must be reset. The exterior mirrors will otherwise not fold in when you select the "Fold in mirrors when locking" function in the on-board computer (▷ page 233)

- ▶ Turn the SmartKey to position **1** in the ignition lock (▷ page 147).
- ▶ Briefly press button ①.

### Folding the exterior mirrors in or out automatically

If the "Fold in mirrors when locking" function is activated in the on-board computer (▷ page 233):

- the exterior mirrors fold in automatically as soon as you lock the vehicle from the outside.
- the exterior mirrors fold out again automatically as soon as you unlock the vehicle and then open the driver's or front-passenger door.

- ① If the exterior mirrors have been folded in manually, they do not fold out.

### Exterior mirror pushed out of position

If an exterior mirror has been pushed out of position, proceed as follows:

- ▶ **Vehicles without electrically folding exterior mirrors:** move the exterior mirror into the correct position manually.
- ▶ **Vehicles with electrically folding exterior mirrors:** press and hold mirror-folding button ① until you hear a click and then the mirrors engage in position (▷ page 110). The mirror housing is engaged again and you can adjust the exterior mirrors as usual (▷ page 109).



### Automatic anti-glare mirrors

The rear-view mirror and the exterior mirror on the driver's side automatically go into anti-glare mode if the following conditions are met simultaneously:

- the ignition is switched on and
- incident light from headlamps strikes the sensor in the rear-view mirror.

The mirrors do not go into anti-glare mode if reverse gear is engaged or if the interior lighting is switched on.

### Parking position for the exterior mirror on the front-passenger side

#### Setting and storing the parking position

##### Using reverse gear



- ① Button for the driver's side exterior mirror
- ② Button for the front-passenger side exterior mirror
- ③ Adjustment button
- ④ Memory button **M**

You can position the front-passenger side exterior mirror in such a way that you can see the rear wheel on that side as soon as you engage reverse gear. You can store this position.

- ▶ Park the vehicle and turn the SmartKey to position **2** in the ignition lock (▷ page 147).
- ▶ Press button ② for the exterior mirror on the front-passenger side.

- ▶ Engage reverse gear.

The exterior mirror on the front-passenger side moves to the preset parking position.

- ▶ Use adjustment button ③ to adjust the exterior mirror to a position that allows you to see the rear wheel and the curb. The parking position is stored.

- ❗ If you shift the transmission to another position, the exterior mirror on the front-passenger side returns to the driving position.

##### Using the memory button

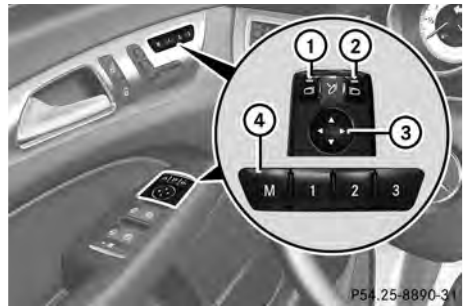

- ① Button for the driver's side exterior mirror
- ② Button for the front-passenger side exterior mirror
- ③ Adjustment button
- ④ Memory button **M**

You can position the front-passenger side exterior mirror in such a way that you can see the rear wheel on that side as soon as you engage reverse gear. This setting can be stored using memory button **M** ④.

- ▶ Turn the SmartKey to position **2** in the ignition lock (▷ page 147).
- ▶ With the exterior mirror on the front-passenger side activated, use adjustment button ③ to adjust the exterior mirror. In the exterior mirror, the rear wheel and the curb should be visible.

- ▶ Press memory button **M** ④ and one of the arrows on adjustment button ③ within three seconds.  
The parking position is stored if the exterior mirror does not move.
- ▶ If the exterior mirror moves out of position, repeat the steps.

### Calling up a stored parking position setting

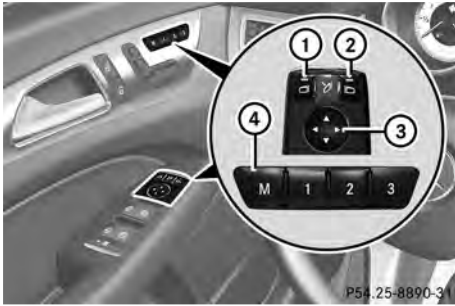

- ① Button for the driver's side exterior mirror
- ② Button for the front-passenger side exterior mirror
- ③ Adjustment button
- ④ Memory button **M**

- ▶ Turn the SmartKey to position **2** in the ignition lock (> page 147).
- ▶ Adjust the exterior mirror on the front-passenger side using button ②.
- ▶ Engage reverse gear.  
The exterior mirror on the front-passenger side moves to the stored parking position.

The exterior mirror on the front-passenger side moves back to its original position:

- as soon as you exceed a speed of 9 mph (15 km/h)
- if you press button ① for the exterior mirror on the driver's side

## Memory function

### Storing settings

#### ⚠ WARNING

If you use the memory function on the driver's side while driving, you could lose control of the vehicle as a result of the adjustments being made. There is a risk of an accident. Only use the memory function on the driver's side when the vehicle is stationary.

#### ⚠ WARNING

Children could become trapped if they activate the memory function, particularly when unattended. There is a risk of injury. When leaving the vehicle, always take the SmartKey with you and lock the vehicle. Never leave children unsupervised in the vehicle.

With the memory function, you can store up to three different settings, e.g. for three different people.

The following settings are stored as a single memory preset:

- position of the seat, backrest and head restraint
- active multicontour seat: seat contour, dynamic function level
- driver's side: position of the exterior mirrors on the driver's and front-passenger sides



- ▶ Adjust the seat (▷ page 100).
- ▶ On the driver's side, adjust the steering wheel (▷ page 106) and the exterior mirrors (▷ page 109).
- ▶ Press memory button **M** and one of the storage position buttons **1**, **2** or **3** within three seconds.  
The settings are stored in the selected preset position. A tone sounds when the settings have been completed.

### Calling up a stored setting

- ▶ Press and hold the relevant storage position button **1**, **2** or **3** until the seat, steering wheel and exterior mirrors are in the stored position.
- i** The setting procedure is interrupted as soon as you release the storage position button.



Useful information .....	116
Exterior lighting .....	116
Interior lighting .....	123
Replacing bulbs .....	124
Windshield wipers .....	125

## Useful information

**i** This Operator's Manual describes all models and all standard and optional equipment of your vehicle available at the time of publication of the Operator's Manual. Country-specific differences are possible. Please note that your vehicle may not be equipped with all features described. This also applies to safety-related systems and functions.

**i** Read the information on qualified specialist workshops: (▷ page 26).

## Exterior lighting

### General notes

For reasons of safety, Mercedes-Benz recommends that you drive with the lights switched on even during the daytime. Therefore, your vehicle is equipped with special daytime running lamps. In some countries, operation of the headlamps varies due to legal requirements and self-imposed obligations.

If you wish to drive during the daytime without lights, switch off the daytime running lamps function in the on-board computer (▷ page 230).

### Driving abroad

#### Symmetrical low-beam headlamps

Switch the headlamps to symmetrical low beam in countries in which traffic drives on the opposite side of the road from the country where the vehicle is registered. This prevents glare to oncoming traffic. When using symmetrical lights, the edge of the road is not lit as widely and as far ahead as normal.

Have the headlamps converted at a qualified specialist workshop as close to the border as possible before driving in these countries.

#### Asymmetrical low beam

Have the headlamps converted back to asymmetrical low-beam headlamps at a qualified specialist workshop as soon as possible after crossing the border again.

## Setting the exterior lighting

### Setting options

Exterior lighting can be set using:

- the light switch
- the combination switch (▷ page 119)
- the on-board computer (▷ page 230)

### Light switch

#### Operation

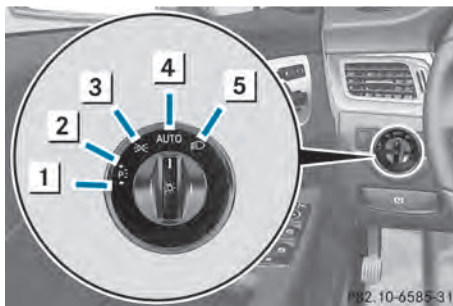

- 1** Left-hand standing lamps
- 2** Right-hand standing lamps
- 3** Parking lamps, license plate and instrument cluster lighting
- 4** **AUTO** Automatic headlamp mode, controlled by the light sensor
- 5** Low-beam/high-beam headlamps

If you hear a warning tone when you leave the vehicle, the lights may still be switched on.

► Turn the light switch to **AUTO**.

The exterior lighting (except the parking/standing lamps) switches off automatically if you:

- remove the SmartKey from the ignition lock
- open the driver's door with the SmartKey in position **0**.

**Automatic headlamp mode**

**WARNING**

When the light switch is set to **AUTO**, the low-beam headlamps may not be switched on automatically if there is fog, snow or other causes of poor visibility due to the weather conditions such as spray. There is a risk of an accident.

In such situations, turn the light switch to



The automatic headlamp feature is only an aid. The driver is responsible for the vehicle's lighting at all times.

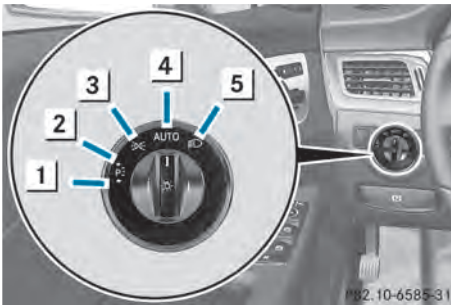

- 1 **↔P** Left-hand standing lamps
- 2 **P↔** Right-hand standing lamps
- 3 **▷▷** Parking lamps, license plate and instrument cluster lighting
- 4 **AUTO** Automatic headlamp mode, controlled by the light sensor
- 5 **☞** Low-beam/high-beam headlamps

**AUTO** is the favored light switch setting. The light setting is automatically selected according to the brightness of the ambient light (exception: poor visibility due to weather conditions such as fog, snow or spray):

- SmartKey in position **1** in the ignition lock: the parking lamps are switched on or off automatically depending on the brightness of the ambient light.
- With the engine running: if you have activated the daytime running lamps function via the on-board computer, the daytime running lamps or the low-beam headlamps and parking lamps are switched on or off automatically depending on the brightness of the ambient light.

► **To switch on automatic headlamp mode:** turn the light switch to **AUTO**.

**Only for Canada:**

The daytime running lamps improve the visibility of your vehicle during the day. The daytime running lamps function is required by law in Canada. It cannot therefore be deactivated.

When the engine is running and the vehicle is stationary: if you move the selector lever from a drive position to **P**, the daytime running lamps/low-beam headlamps go out after three minutes.

When the engine is running, the vehicle is stationary and in high ambient light: if you turn the light switch to **▷▷**, the daytime running lamps and parking lamps switch on.

If the engine is running and you turn the light switch to **☞**, the manual settings take precedence over the daytime running lamps.

**USA only:**

The daytime running lamps improve the visibility of your vehicle during the day. To do this, the daytime running lamps function must be switched on using the on-board computer (▷ page 230).

If the engine is running and you turn the light switch to **▷▷** or **☞**, the manual settings

take precedence over the daytime running lamps.

### Low-beam headlamps

#### WARNING

When the light switch is set to **AUTO**, the low-beam headlamps may not be switched on automatically if there is fog, snow or other causes of poor visibility due to the weather conditions such as spray. There is a risk of an accident.

In such situations, turn the light switch to

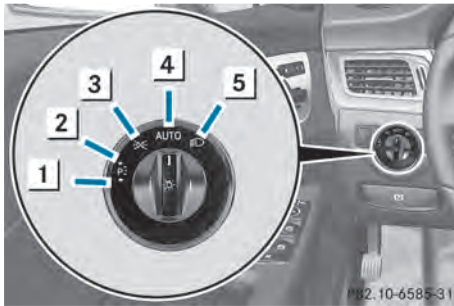

- 1 Left-hand standing lamps
- 2 Right-hand standing lamps
- 3 Parking lamps, license plate and instrument cluster lighting
- 4 **AUTO** Automatic headlamp mode, controlled by the light sensor
- 5 Low-beam/high-beam headlamps

Even if the light sensor does not detect that it is dark, the parking lamps and low-beam headlamps switch on when the ignition is switched on and the light switch is set to the position. This is a particularly useful function in the event of rain and fog.

#### ► To switch on the low-beam headlamps:

- turn the SmartKey in the ignition lock to position **2** or start the engine.
  - Turn the light switch to .
- The green indicator lamp in the instrument cluster lights up.

### Parking lamps

**!** If the battery has been excessively discharged, the parking lamps or standing lamps are automatically switched off to enable the next engine start. Always park your vehicle safely and sufficiently lit according to legal standards. Avoid the continuous use of the parking lamps for several hours. If possible, switch on the right or the left standing lamp.

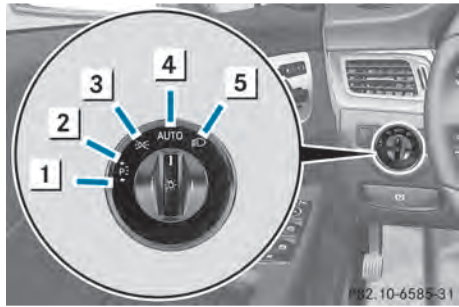

- 1 Left-hand standing lamps
- 2 Right-hand standing lamps
- 3 Parking lamps, license plate and instrument cluster lighting
- 4 **AUTO** Automatic headlamp mode, controlled by the light sensor
- 5 Low-beam/high-beam headlamps

► **To switch on:** turn the light switch to .

The green indicator lamp in the instrument cluster lights up.



### Standing lamps

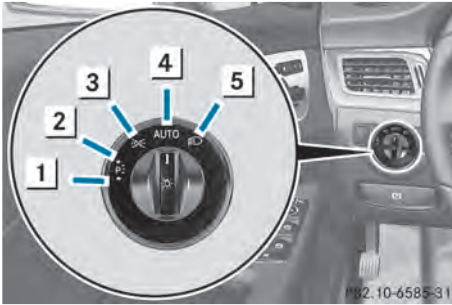

- 1 Left-hand standing lamps
- 2 Right-hand standing lamps
- 3 Parking lamps, license plate and instrument cluster lighting
- 4 **AUTO** Automatic headlamp mode, controlled by the light sensor
- 5 Low-beam/high-beam headlamps

Switching on the standing lamps ensures the corresponding side of the vehicle is illuminated.

- ▶ **To switch on the standing lamps:** the SmartKey is not in the ignition lock or it is in position **0**.
- ▶ Turn the light switch to (left-hand side of the vehicle) or (right-hand side of the vehicle).

### Combination switch

#### Turn signal

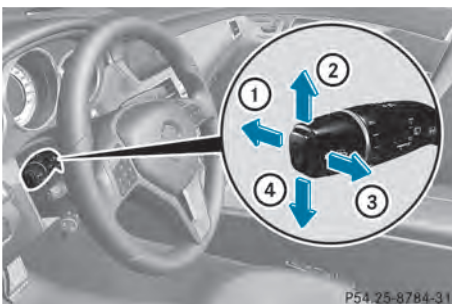

- ① High-beam headlamps
- ② Turn signal, right

- ③ High-beam flasher
- ④ Turn signal, left

- ▶ **To indicate briefly:** press the combination switch briefly to the pressure point in the direction of arrow ② or ④. The corresponding turn signal flashes three times.
- ▶ **To indicate:** press the combination switch beyond the pressure point in the direction of arrow ② or ④.

#### High-beam headlamps

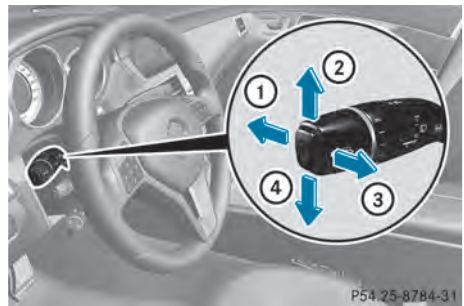

- ① High-beam headlamps
- ② Turn signal, right
- ③ High-beam flasher
- ④ Turn signal, left

- ▶ **To switch on the high-beam headlamps:** turn the SmartKey in the ignition lock to position **2** or start the engine.
  - ▶ Turn the light switch to or **AUTO**.
  - ▶ Press the combination switch beyond the pressure point in the direction of arrow ①.
- In the **AUTO** position, the high-beam headlamps are only switched on when it is dark and the engine is running.

The blue  indicator lamp in the instrument cluster lights up when the high-beam headlamps are switched on.

- **To switch off the high-beam headlamps:** move the combination switch back to its normal position.

The blue  indicator lamp in the instrument cluster goes out.

- ❗ Vehicles with Adaptive Highbeam Assist: when Adaptive Highbeam Assist is active, it controls activation of the high-beam headlamps (► page 121).

### High-beam flasher

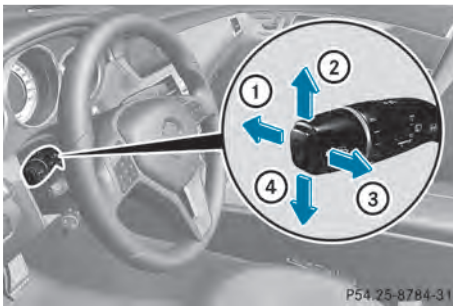

- ① High-beam headlamps
- ② Turn signal, right
- ③ High-beam flasher
- ④ Turn signal, left

- **To switch on:** turn the SmartKey in the ignition lock to position **1** or **2**, or start the engine.
- Pull the combination switch in the direction of arrow **③**.

### Hazard warning lamps



- **To switch on the hazard warning lamps:** press button **①**.

All turn signals flash. If you now switch on a turn signal using the combination switch, only the turn signal lamp on the corresponding side of the vehicle will flash.

- **To switch off the hazard warning lamps:** press button **①**.

The hazard warning lamps automatically switch on if:

- an air bag is deployed
- the vehicle decelerates rapidly from a speed of more than 45 mph (70 km/h) and comes to a standstill

The hazard warning lamps switch off automatically if the vehicle reaches a speed of over 6 mph (10 km/h) again after a full brake application.

- ❗ The hazard warning lamps still operate if the ignition is switched off.

### Headlamp cleaning system

The headlamps are cleaned automatically if the "Wipe with washer fluid" function is operated five times (► page 125) while the lights are on and the engine is running. When you switch off the ignition, the automatic headlamp cleaning system is reset and counting is resumed from 0.

**Cornering light function**



The cornering light function improves the illumination of the road over a wide angle in the direction you are turning, enabling better visibility in tight bends, for example. It can only be activated when the low-beam headlamps are switched on.

**Active:**

- if you are driving at speeds below 25 mph (40 km/h) and switch on the turn signal or turn the steering wheel
- if you are driving at speeds between 25 mph (40 km/h) and 45 mph (70 km/h) and turn the steering wheel

**Not active:** if you are driving at speeds above 25 mph (40 km/h) or switch off the turn signal or turn the steering wheel to the straight-ahead position.

The cornering lamp may remain lit for a short time, but is automatically switched off after no more than three minutes.

**Active light function**



P82\_10-6162-31

The active light function is a system that moves the headlamps according to the steering movements of the front wheels. In this way, relevant areas remain illuminated while driving. This allows you to identify pedestrians, cyclists and animals.

**Active:** when the lights are switched on.

**Adaptive Highbeam Assist**

**Important safety notes**

**⚠ WARNING**

Adaptive Highbeam Assist does not recognize road users:

- who have no lights, e.g. pedestrians
- who have poor lighting, e.g. cyclists
- whose lighting is blocked, e.g. by a barrier

In very rare cases, Adaptive Highbeam Assist may fail to recognize other road users that have lights, or may recognize them too late. In this or similar situations, the automatic high-beam headlamps will not be deactivated or activated regardless. There is a risk of an accident.

Always carefully observe the traffic conditions and switch off the high-beam headlamps in good time.



P82\_10-6943-31

You can use this function to set the headlamps to change between low beam and high beam automatically. The system recognizes vehicles with their lights on, either approaching from the opposite direction or traveling in front of your vehicle, and consequently switches the headlamps from high beam to low beam.

The system automatically adapts the low-beam headlamp range depending on the distance to the other vehicle. Once the system no longer detects any other vehicles, it reactivates the high-beam headlamps.

The system's optical sensor is located behind the windshield near the overhead control panel.

### Switching Adaptive Highbeam Assist on/off

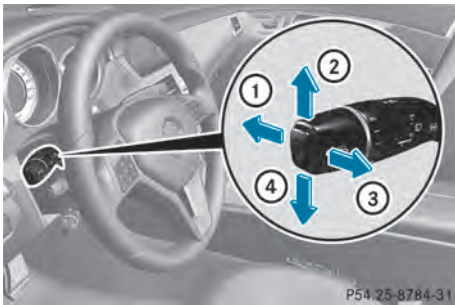

- ① High-beam headlamps
- ② Turn signal, right
- ③ High-beam flasher
- ④ Turn signal, left

► **To switch on:** turn the light switch to

**AUTO**.

► Press the combination switch beyond the pressure point in the direction of arrow ①.

The  indicator lamp in the multifunction display lights up if it is dark and the light sensor activates the low-beam headlamps.



If you are driving at speeds above approximately 28 mph (45 km/h):

The headlamp range is set automatically depending on the distance between the vehicle and other road users.

If you are driving at speeds above approximately 35 mph (55 km/h) and no other road users have been detected:

The high-beam headlamps are switched on automatically. The  indicator lamp in the instrument cluster also lights up.

If you are driving at speeds below approximately 30 mph (45 km/h) or other road users have been detected or the roads are adequately lit:

The high-beam headlamps are switched off automatically. The  indicator lamp in the instrument cluster goes out. The  indicator lamp in the multifunction display remains lit.

- **To switch off:** move the combination switch back to its normal position or move the light switch to another position. The  indicator lamp in the instrument cluster goes out.

### Headlamps fogged up on the inside

The headlamps may fog up on the inside if there is high atmospheric humidity.

- Switch on the light and drive off. The level of moisture diminishes, depending on the length of the journey and the weather conditions (humidity and temperature).

If the level of moisture does not diminish:

- Have the headlamps checked at a qualified specialist workshop.

Interior lighting

Overview of interior lighting

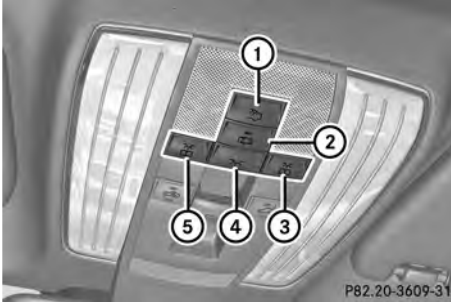

Front overhead control panel

- ① To switch the rear interior lighting on/off
- ② To switch the automatic interior lighting control on/off
- ③ To switch the right-hand front reading lamp on/off
- ④ To switch the front interior lighting on/off
- ⑤ To switch the left-hand front reading lamp on/off

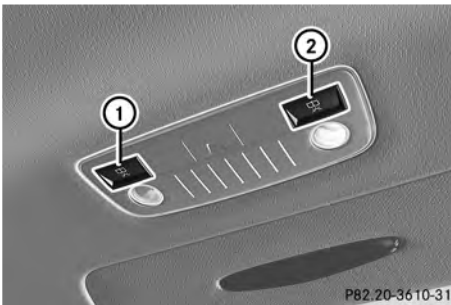

Rear-compartment overhead control panel

- ① To switch the right-hand reading lamp on/off
- ② To switch the left-hand reading lamp on/off

Interior lighting control

General notes

In order to prevent the vehicle's battery from discharging, the interior lighting functions are automatically deactivated after some time unless the SmartKey is in position 2 in the ignition lock.

The color and brightness of the ambient lighting may be set using the on-board computer (▷ page 231).

Automatic interior lighting control

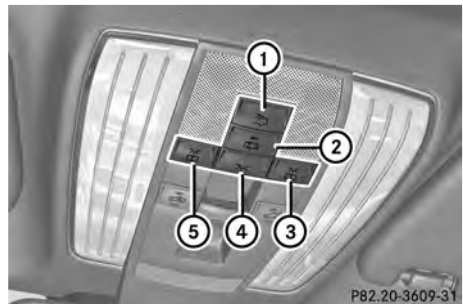

Front overhead control panel

- ① To switch the rear interior lighting on/off
- ② To switch the automatic interior lighting control on/off
- ③ To switch the right-hand reading lamp on/off
- ④ To switch the front interior lighting on/off
- ⑤ To switch the left-hand reading lamp on/off

► **To activate/deactivate:** press the

button. When the automatic interior lighting control is activated, the button is flush with the overhead control panel.

The interior lighting automatically switches on if you:





- unlock the vehicle
- open a door
- remove the SmartKey from the ignition lock

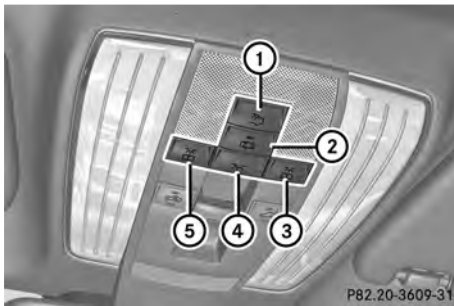

The interior light is activated for a short while when the SmartKey is removed from the ignition lock. You can activate this delayed switch-off using the on-board computer (> page 232).

### Manual interior lighting control



Front overhead control panel

- ①  To switch the rear interior lighting on/off.
- ②  To switch the automatic interior lighting control on/off
- ③  To switch the right-hand reading lamp on/off
- ④  To switch the front interior lighting on/off
- ⑤  To switch the left-hand reading lamp on/off

- ▶ **To switch the front interior lighting on/off:** press the  button.
- ▶ **To switch the rear interior lighting on/off:** press the  button.
- ▶ **To switch the reading lamps on/off:** press the  button.

### Crash-responsive emergency lighting

The interior lighting is activated automatically if the vehicle is involved in an accident.

- ▶ **To switch off the crash-responsive emergency lighting:** press the hazard warning lamp button.

or

- ▶ Lock and then unlock the vehicle using the SmartKey.

### Replacing bulbs

#### Important safety notes

#### Xenon bulbs

##### DANGER

Xenon bulbs carry a high voltage. You can get an electric shock if you remove the cover of the Xenon bulb and touch the electrical contacts. There is a risk of fatal injury.

Never touch the parts or the electrical contacts of the Xenon bulb. Always have work on the Xenon bulbs carried out at a qualified specialist workshop.

Bulbs and lamps are an important aspect of vehicle safety. You must therefore make sure that these function correctly at all times. Have the headlamp setting checked regularly.

#### LED lamps

You can neither replace Xenon bulbs nor LED bulbs. Have LED bulbs changed at a qualified specialist workshop.

Bulbs and lamps are an important aspect of vehicle safety. You must therefore make sure that these function correctly at all times. Have the headlamp setting checked regularly.

#### Other bulbs

##### WARNING

Bulbs, lamps and connectors can get very hot when operating. If you change a bulb, you

could burn yourself on these components. There is a risk of injury. Allow these components to cool down before changing a bulb.

There are bulbs other than Xenon and LED bulbs that you cannot replace. Replace only the bulbs listed (> page 125). Have the bulbs that you cannot replace yourself changed at a qualified specialist workshop.

If you require assistance changing bulbs, consult a qualified specialist workshop.

Do not touch the glass tube of new bulbs with your bare hands. Even minor contamination can burn into the glass surface and reduce the service life of the bulbs. Always use a lint-free cloth or only touch the base of the bulb when installing.

Only use bulbs of the correct type.

If the new bulb still does not light up, consult a qualified specialist workshop.

Bulbs and lamps are an important aspect of vehicle safety. You must therefore make sure that these function correctly at all times. Have the headlamp setting checked regularly.

**Overview: changing bulbs/bulb types**

You can change the following bulbs. The bulb type can be found in the legend.

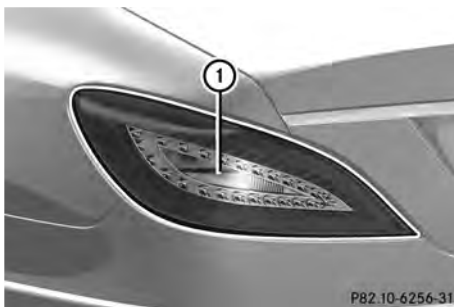

Tail lamp

- ① Backup lamp: W 16 W

**Changing the rear bulbs**

**Backup light**

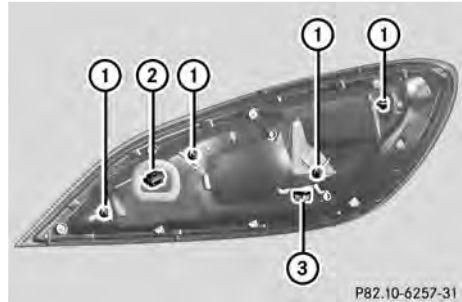

Lamp unit

- ▶ Switch off the lights.
- ▶ Open the trunk.
- ▶ Reach up into the side paneling and pull downwards until the lamp cluster is easily accessible.
- ▶ Press the detent of connector ② and pull out connector ②.
- ▶ Use a suitable tool to loosen and remove four nuts ①.
- ▶ Remove the entire lamp cluster.
- ▶ Turn bulb holder ③ counter-clockwise and pull it out.
- ▶ Pull out bulb.
- ▶ Insert the new bulb into bulb holder ③.
- ▶ Insert bulb holder ③ into the lamp and turn it clockwise.
- ▶ Re-insert the lamp cluster.
- ▶ Tighten four nuts ①.
- ▶ Push in connector ② until it engages.
- ▶ Insert the side paneling.

**Windshield wipers**

**Switching the windshield wipers on/off**

- ❗ Do not operate the windshield wipers when the windshield is dry, as this could damage the wiper blades. Moreover, dust

that has collected on the windshield can scratch the glass if wiping takes place when the windshield is dry.

If it is necessary to switch on the windshield wipers in dry weather conditions, always use washer fluid when operating the windshield wipers.

**!** If the windshield wipers leave smears on the windshield after the vehicle has been washed in an automatic car wash, wax or other residues may be the reason for this. Clean the windshield using washer fluid after washing the vehicle in an automatic car wash.

**!** Intermittent wiping with rain sensor: due to optical influences and the windshield becoming dirty in dry weather conditions, the windshield wipers may be activated inadvertently. This could then damage the windshield wiper blades or scratch the windshield.

For this reason, you should always switch off the windshield wipers in dry weather.

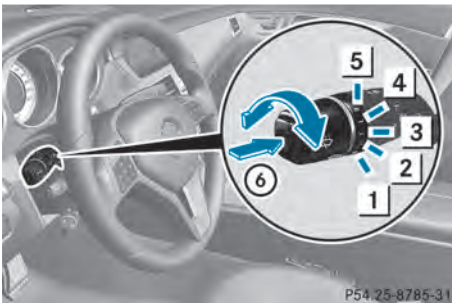

Combination switch

- 1 **0** Windshield wiper off
- 2 **...** Intermittent wipe, low (rain sensor set to low sensitivity)
- 3 **....** Intermittent wipe, high (rain sensor set to high sensitivity)
- 4 **—** Continuous wipe, slow
- 5 **==** Continuous wipe, fast
- 6 **☹** Single wipe / **☹** To wipe the windshield using washer fluid

- ▶ Switch on the ignition.
- ▶ Turn the combination switch to the corresponding position.

In the **...** or **....** position, the appropriate wiping frequency is set automatically according to the intensity of the rain. In the **....** position, the rain sensor is more sensitive than in the **...** position, causing the windshield wipers to wipe more frequently.

If the wiper blades are worn, the windshield will no longer be wiped properly. This could prevent you from observing the traffic conditions. Replace the wiper blades twice a year, ideally in spring and fall.

## Replacing the wiper blades

### Important safety notes

#### **!** WARNING

If the windshield wipers begin to move while you are changing the wiper blades, you could be trapped by the wiper arm. There is a risk of injury.

Always switch off the windshield wipers and ignition before changing the wiper blades.

- !** To avoid damaging the wiper blades, make sure that you touch only the wiper arm of the wiper.
  - !** Never open the hood if a windshield wiper arm has been folded away from the windshield.
    - Never fold a windshield wiper arm without a wiper blade back onto the windshield.
    - Hold the windshield wiper arm firmly when you change the wiper blade. If you release the windshield wiper arm without a wiper blade and it falls onto the windshield, the windshield may be damaged by the force of the impact.
- Mercedes-Benz recommends that you have the wiper blades changed at a qualified specialist workshop.



Depending on the equipment level of your vehicle, there are two variants of wiper blade; these are installed and removed in different ways. Based on the diagrams, check which system is installed in your vehicle.

### **Changing the wiper blades (version 1)**

#### **Removing the wiper blades**

- ▶ Remove the SmartKey from the ignition lock or turn it to position **0** (KEYLESS-GO).
- ▶ Fold the wiper arm away from the windshield until it engages.
- ▶ Set the wiper blade at right angles to the wiper arm.

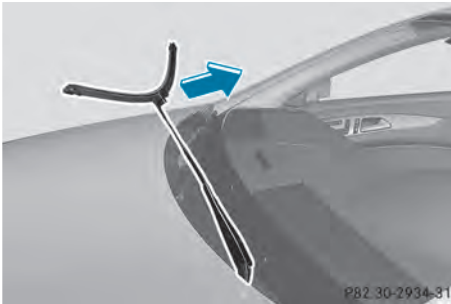

- ▶ Remove the wiper blade from the retaining pin on the wiper arm in the direction of the arrow.

#### **Installing the wiper blades**

- ▶ Push the new wiper blade onto the retaining pin on the wiper arm in the opposite direction to the arrow.  
Make sure that the wiper blade slides fully onto the retaining pin on the wiper arm.
- ▶ Turn the wiper blade parallel to the wiper arm.
- ▶ Fold the wiper arm back onto the windshield.

### **Changing the wiper blades (version 2)**

#### **Removing the wiper blades**

- ▶ Remove the SmartKey from the ignition lock or turn it to position **0** (KEYLESS-GO).
- ▶ Fold the wiper arm away from the windshield until it engages.

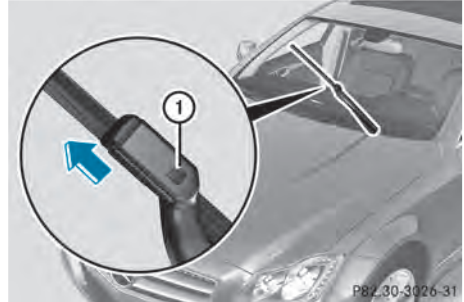

- ▶ Firmly press release knob ① and pull the wiper blade upwards from the wiper arm in the direction of the arrow.

#### **Installing the wiper blades**

- ▶ Position the new wiper blade in the retainer on the wiper arm and slide it into place in the opposite direction from the arrow. The wiper blade audibly engages.
- ▶ Make sure that wiper blade is seated correctly.
- ▶ Fold the wiper arm back onto the windshield.

**Problems with the windshield wipers**

<b>Problem</b>	<b>Possible causes/consequences and ► Solutions</b>
The windshield wipers are jammed.	<p>Leaves or snow, for example, may be obstructing the windshield wiper movement. The wiper motor has been deactivated.</p> <ul style="list-style-type: none"><li>► For safety reasons, you should remove the SmartKey from the ignition lock.</li></ul> <p>or</p> <ul style="list-style-type: none"><li>► Switch off the engine using the Start/Stop button and open the driver's door.</li><li>► Remove the cause of the obstruction.</li><li>► Switch the windshield wipers back on.</li></ul>
The windshield wipers fail completely.	<p>The windshield wiper drive is malfunctioning.</p> <ul style="list-style-type: none"><li>► Select another wiper speed on the combination switch.</li><li>► Have the windshield wipers checked at a qualified specialist workshop.</li></ul>

Useful information .....	130
Overview of climate control systems .....	130
Operating the climate control systems .....	135
Setting the air vents .....	142

### Useful information

- i** This Operator's Manual describes all models and all standard and optional equipment of your vehicle available at the time of publication of the Operator's Manual. Country-specific differences are possible. Please note that your vehicle may not be equipped with all features described. This also applies to safety-related systems and functions.
- i** Read the information on qualified specialist workshops: (▷ page 26).

- i** The integrated filter filters out most particles of dust and soot and completely filters out pollen. It also reduces gaseous pollutants and odors. A clogged filter reduces the amount of air supplied to the vehicle interior. For this reason, you should always observe the interval for replacing the filter, which is specified in the Maintenance Booklet. As it depends on environmental conditions, e.g. heavy air pollution, the interval may be shorter than stated in the Maintenance Booklet.

### Overview of climate control systems

#### Important safety notes

Observe the settings recommended on the following pages. The windows could otherwise fog up.

To prevent the windows from fogging up:

- switch off climate control only briefly
- switch on air-recirculation mode only briefly
- switch on the cooling with air dehumidification function
- switch on the defrost windshield function briefly, if required

Climate control regulates the temperature and the humidity in the vehicle interior and filters undesirable substances out of the air.

Climate control can only be operated when the engine is running. Optimum operation is only achieved with the side windows and roof closed.

The residual heat function can only be activated or deactivated with the ignition switched off (▷ page 14 1).

- i** Ventilate the vehicle for a brief period during warm weather, e.g. using the convenience opening feature (▷ page 89). This will speed up the cooling process and the desired vehicle interior temperature will be reached more quickly.

## Control panel for dual-zone automatic climate control

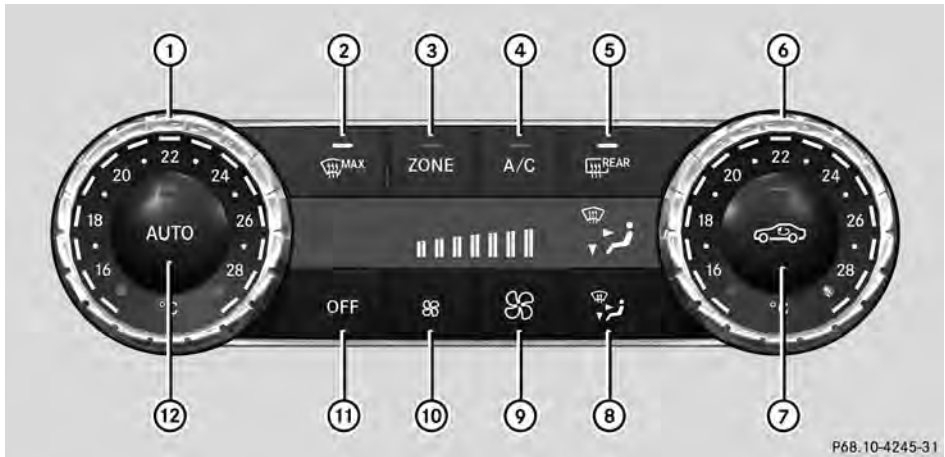

Canada only

- ① Sets the temperature, left (▷ page 138)
- ② Defrosts the windshield (▷ page 139)
- ③ Switches the ZONE function on/off (▷ page 139)
- ④ Switches cooling with air dehumidification on/off (▷ page 136)
- ⑤ Switches the rear window defroster on/off (▷ page 140)
- ⑥ Sets the temperature, right (▷ page 138)
- ⑦ Activates/deactivates air-recirculation mode (▷ page 141)
- ⑧ Sets the air distribution (▷ page 138)
- ⑨ Increases the airflow (▷ page 139)
- ⑩ Reduces the airflow (▷ page 139)
- ⑪ Switches climate control on/off (▷ page 135)
- ⑫ Sets climate control to automatic (▷ page 137)

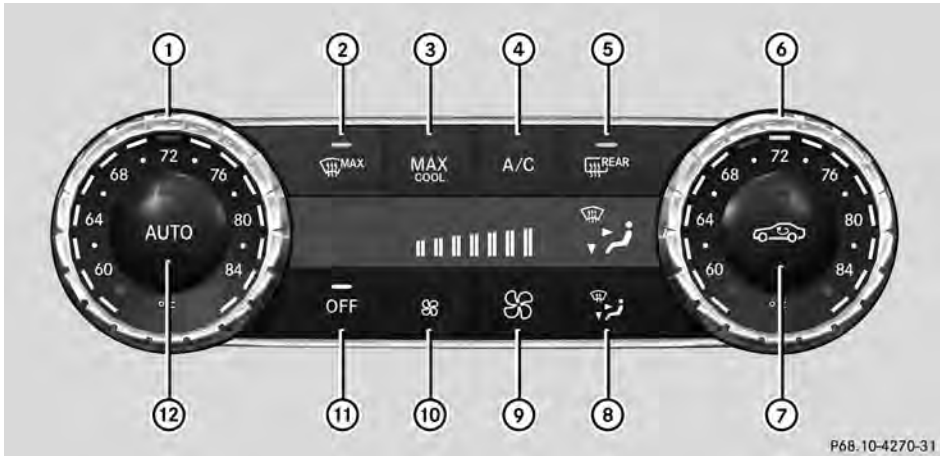

USA only

- ① Sets the temperature, left (▷ page 138)
- ② Defrosts the windshield (▷ page 139)
- ③ Switches maximum cooling on/off (▷ page 139)
- ④ Switches cooling with air dehumidification on/off (▷ page 136)
- ⑤ Switches the rear window defroster on/off (▷ page 140)
- ⑥ Sets the temperature, right (▷ page 138)
- ⑦ Activates/deactivates air-recirculation mode (▷ page 141)
- ⑧ Sets the air distribution (▷ page 138)
- ⑨ Increases the airflow (▷ page 139)
- ⑩ Reduces the airflow (▷ page 139)
- ⑪ Switches climate control on/off (▷ page 135)
- ⑫ Sets climate control to automatic (▷ page 137)

### Information about using dual-zone automatic climate control

#### Automatic climate control

The following contains notes and recommendations on optimum use of dual-zone automatic climate control.

- Activate climate control using the **AUTO** and **A/C** buttons. The indicator lamps above the **AUTO** and **A/C** buttons light up.
- Set the temperature to 72 °F (22 °C).
- Only use the "Windshield defrosting" function briefly until the windshield is clear again.
- Only use air-recirculation mode briefly, e.g. if there are unpleasant outside odors or when in a tunnel. The windows could otherwise fog up, since no fresh air is drawn into the vehicle in air-recirculation mode.
- Use the ZONE function to adopt the temperature settings on the driver's side for the front-passenger side as well. The

indicator lamp above the  button goes out.

- **Vehicles with COMAND Multimedia-System:** if you change the settings of the climate control system, the climate status display appears for approximately three seconds at the bottom of the screen in the COMAND display. See also the separate COMAND operating instructions. You will see the current settings of the various climate control functions.

### **ECO start/stop function**

---

During automatic engine switch-off, the ECO start/stop function only operates at a reduced capacity. If you require the full climate control output, you can switch off the ECO start/stop function by pressing the ECO button (▷ page 152).

## Control panel for 3-zone automatic climate control

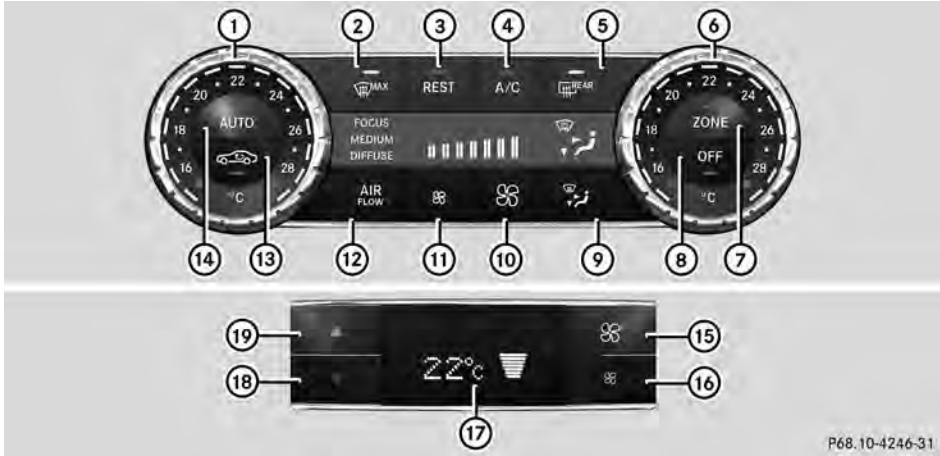

P68.10-4246-31

Canada only

**Front control panel**

- ① Sets the temperature, left (▷ page 138)
- ② Defrosts the windshield (▷ page 139)
- ③ Switches the residual heat function on/off (▷ page 141)
- ④ Switches cooling with air dehumidification on/off (▷ page 136)
- ⑤ Switches the rear window defroster on/off (▷ page 140)
- ⑥ Sets the temperature, right (▷ page 138)
- ⑦ Switches the ZONE function on/off (▷ page 139)
- ⑧ Switches climate control on/off (▷ page 135)
- ⑨ Sets the air distribution (▷ page 138)
- ⑩ Increases the airflow (▷ page 139)
- ⑪ Reduces the airflow (▷ page 139)
- ⑫ Adjusts the climate mode settings (▷ page 137)
- ⑬ Activates/deactivates air-recirculation mode (▷ page 141)
- ⑭ Sets climate control to automatic (▷ page 137)

**Rear control panel**

- ⑮ Increases the airflow (▷ page 139)
- ⑯ Reduces the airflow (▷ page 139)
- ⑰ Display
- ⑱ Reduces the temperature (▷ page 138)
- ⑲ Increases the temperature (▷ page 138)



## Information about using 3-zone automatic climate control

### Automatic climate control

The 3-zone automatic climate control is only available on vehicles for Canada.

The following contains instructions and recommendations to enable you to get the most out of your automatic climate control.

- Activate climate control using the **AUTO** and **A/C** buttons. The indicator lamps above the **AUTO** and **A/C** buttons light up.
- In automatic mode, you can also use the **AIR FLOW** button to set a climate mode (FOCUS/MEDIUM/DIFFUSE). The MEDIUM level is recommended.
- Set the temperature to  $f 72^{\circ}\text{F}$  ( $22^{\circ}\text{C}$ ).
- Only use the "Windshield defrosting" function briefly until the windshield is clear again.
- Only use air-recirculation mode briefly, e.g. if there are unpleasant outside odors or when in a tunnel. The windows could otherwise fog up, since no fresh air is drawn into the vehicle in air-recirculation mode.
- Use the ZONE function to adopt the temperature settings on the driver's side for the front-passenger side and the rear compartment as well. The indicator lamp above the **ZONE** button goes out.
- Use the residual heat function if you want to heat or ventilate the vehicle interior when the ignition is switched off. The residual heat function can only be activated or deactivated with the ignition switched off.
- **Vehicles with COMAND Multimedia-System:** if you change the settings of the climate control system, the climate status display appears for approximately three seconds at the bottom of the screen in the COMAND display. See also the separate COMAND operating instructions. You will see the current settings of the various climate control functions.

### ECO start/stop function

During automatic engine switch-off, the ECO start/stop function only operates at a reduced capacity. If you require the full climate control output, you can switch off the ECO start/stop function by pressing the ECO button (▷ page 152).

## Operating the climate control systems

### Switching climate control on/off

#### Points to observe before use

When the climate control is switched off, the air supply and air circulation are also switched off. The windows could fog up. Therefore, switch off climate control only briefly

- **i** Activate climate control primarily using the **AUTO** button (▷ page 137).

#### Activating/deactivating

- ▶ Turn the SmartKey to position **2** in the ignition lock (▷ page 147).
  - ▶ **To switch on:** press the **AUTO** button on the control panel for the climate control. The indicator lamp in the **AUTO** button lights up. Airflow and air distribution are set to automatic mode.
- or
- ▶ Press the **OFF** button. The indicator lamp in the **OFF** button goes out. The previously selected settings are restored.
  - ▶ **To switch off:** press the **OFF** button. The indicator lamp in the **OFF** button lights up.

## Activating/deactivating cooling with air dehumidification

### Points to observe before use

---





If you deactivate the "Cooling with air-dehumidification" function, the air inside the vehicle will not be cooled. The air inside the vehicle will also not be dehumidified. The windows can fog up more quickly. Therefore, deactivate the cooling with air-dehumidification function only briefly.

The cooling with air dehumidification function is only available when the engine is running. The air inside the vehicle is cooled and dehumidified according to the temperature selected.

Condensation may drip from the underside of the vehicle when it is in cooling mode. This is normal and not a sign that there is a malfunction.

### Activating/deactivating

---

- ▶ **To activate:** press the  button.  
The indicator lamp in the  button lights up.
- ❗ When the "Cooling with air dehumidification" function is activated, one of the indicator lamps on the auxiliary heating button will light up on vehicles with auxiliary heating.
- ▶ **To deactivate:** press the  button.  
The indicator lamp in the  button goes out. The "Cooling with air dehumidification" function has a delayed switch-off feature.

## Problems with the "Cooling with air dehumidification" function

Problem	Possible causes/consequences and ► Solutions
The indicator lamp in the  button flashes three times or remains off. The "Cooling with air dehumidification" function cannot be switched on.	Cooling with air dehumidification has been deactivated due to a malfunction. ► Visit a qualified specialist workshop.



### Setting climate control to automatic

#### Points to observe before use

In automatic mode, the set temperature is maintained automatically at a constant level. The system automatically regulates the temperature of the dispensed air, the airflow and the air distribution.



The automatic mode functions optimally when the "Cooling with air dehumidification" function is activated. If necessary, cooling with air dehumidification can be deactivated. If you deactivate the "Cooling with air-dehumidification" function, the air inside the vehicle will not be cooled. The air inside the vehicle will also not be dehumidified. The windows can fog up more quickly. Therefore, deactivate the cooling with air-dehumidification function only briefly.

#### Activating/switching

- Turn the SmartKey to position **2** in the ignition lock (▷ page 147).
- Set the desired temperature.
- **To activate:** press the  button. The indicator lamp in the  button lights up. Automatic air distribution and airflow are activated.
- i** 3-zone automatic climate control: when automatic mode is activated, you can select a climate mode (▷ page 137).

► **To switch to manual mode:** press the  button.

or



► Press the  or  button. The indicator lamp in the  button goes out.

### Adjusting the climate mode settings

The "Set climate mode" function is only available with 3-zone automatic climate control.

You can select the following climate mode settings in automatic mode:

- FOCUS high airflow that is set slightly cooler
- MEDIUM medium airflow, standard setting
- DIFFUSE low airflow that is set slightly warmer and with less draft

- Turn the SmartKey to position **2** in the ignition lock (▷ page 147).
- Press the  button.
- Press the  button repeatedly until the desired climate mode appears in the display.

## Setting the temperature

### Dual-zone automatic climate control

Different temperatures can be set for the driver's and front-passenger sides.

- ▶ Turn the SmartKey to position **2** in the ignition lock (▷ page 147).
- ▶ **To increase/reduce:** turn temperature control ① or ⑥ clockwise or counter-clockwise (▷ page 131).

Only change the temperature setting in small increments. Start at 72 °F (22 °C).

### 3-zone automatic climate control

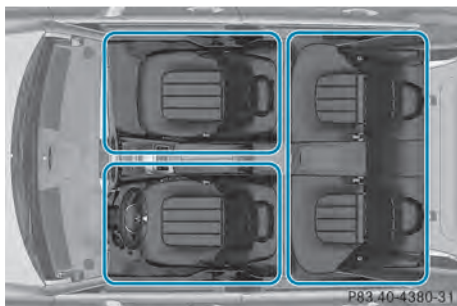

Automatic climate control zones

You can select different temperature settings for the driver's and front-passenger sides as well as for the rear compartment.

- ▶ Turn the SmartKey to position **2** in the ignition lock (▷ page 147).
- ▶ **To increase/reduce the temperature in the front compartment:** turn temperature control ① or ⑥ clockwise or counter-clockwise (▷ page 134).

Only change the temperature setting in small increments. Start at 72 °F (22 °C).

- ▶ **To increase/reduce the temperature in the rear compartment using the front control panel:** press the **ZONE** button. The indicator lamp in the **ZONE** button goes out.
- ▶ Turn temperature control ① clockwise or counter-clockwise (▷ page 134).

Only change the temperature setting in small increments. Start at 72 °F (22 °C). The temperature setting for the driver's side is adopted for the rear compartment and the front-passenger side.

- ▶ **To increase/reduce the temperature in the rear compartment using the rear control panel:** press the or button on the rear control panel.

Only change the temperature setting in small increments. Start at 72 °F (22 °C).

## Setting the air distribution

### Air distribution settings



- Directs air through the center and side air vents
- Directs air through the footwell air vents
- Directs air through the center, side and footwell vents
- Directs air through the defroster vents
- Directs the airflow through the defroster, center and side air vents (Canada only)
- Directs air through the defroster and footwell vents
- Directs the airflow through the defroster, center and side air vents, as well as the footwell air vents (Canada only)

**i** Regardless of the air distribution setting, airflow is always directed through the side air vents. The side air vents can only be closed when the controls on the side air vents are turned downwards.

### Setting the air distribution

- ▶ Turn the SmartKey to position **2** in the ignition lock (▷ page 147).
- ▶ Press the button repeatedly until the desired symbol appears in the display.



### Setting the airflow

- ▶ Turn the SmartKey to position **2** in the ignition lock (▷ page 147).
- ▶ **To increase:** press the  button.
- ▶ **To reduce:** press the  button.

**i** You can use 3-zone automatic climate control to set the airflow in the rear compartment separately.



If the battery is not sufficiently charged, blower output may be reduced. As soon as the battery is sufficiently charged, full blower output will be available.

### Switching the ZONE function on/off

- ▶ **To activate:** press the  button. The indicator lamp above the  button lights up.

Dual-zone automatic climate control: the temperature setting for the driver's side is not adopted for the front-passenger side.

3-zone automatic climate control: the temperature setting for the driver's side is not adopted for the front-passenger side and the rear compartment.

- ▶ **To deactivate:** press the  button. The indicator lamp above the  button goes out.



Dual-zone automatic climate control: the temperature setting for the driver's side is adopted for the front-passenger side.

3-zone automatic climate control: the temperature setting for the driver's side is adopted for the front-passenger side and the rear compartment.

### Defrosting the windshield

You can use this function to defrost the windshield or to defrost the inside of the windshield and the side windows.



Switch off the "Windshield defrosting" function as soon as the windshield is clear again.

- ▶ Turn the SmartKey to position **2** in the ignition lock (▷ page 147).
- ▶ **To activate:** press the  button. The indicator lamp in the  button lights up.



The climate control system switches to the following functions:

- high airflow
- high temperature
- air distribution to the windshield and front side windows
- air-recirculation mode off

If the battery is not sufficiently charged, blower output may be reduced. Once the battery is sufficiently charged again, full blower output will be available again.

- ▶ **To deactivate:** press the  button. The indicator lamp in the  button goes out. The previously selected settings are restored. Air-recirculation mode remains deactivated.

or

- ▶ Press the  button. The indicator lamp in the  button goes out. Airflow and air distribution are set to automatic mode.

or

- ▶ Dual-zone automatic climate control: turn temperature controls **①** or **⑥** clockwise or counter-clockwise (▷ page 131).
- ▶ 3-zone automatic climate control: turn temperature controls **①** or **⑥** clockwise or counter-clockwise (▷ page 134).



or

- ▶ Press the  or  button.

### MAX COOL maximum cooling

The MAX COOL function is only available in vehicles for the USA.

MAX COOL is only operational when the engine is running.



- ▶ **To activate:** press the  button.  
The indicator lamp in the button lights up.
- ▶ **To activate:** press off-road button  again.  
The indicator lamp goes out. The previously selected settings are restored.

When you activate MAX COOL, climate control switches to the following functions:



- maximum cooling
- maximum airflow
- air-recirculation mode on

### Defrosting the windows

#### Windows fogged up on the inside

- ▶ Activate the  cooling with air dehumidification function.
  - ▶ Activate automatic mode .
  - ▶ Adjust the side air vents so that the warmed air is directed to the side windows.
  - ▶ If the windows continue to fog up, activate the "windshield defrosting" function (▷ page 139).
-  You should only select this setting until the windshield is clear again.

#### Windows fogged up on the outside

- ▶ Press the  button repeatedly until the  or  symbol appears in the display.
- ▶ Adjust the side air vents so that no air is directed to the side windows.



### Rear window defroster

#### Activating/deactivating

The rear window defroster has a high current draw. You should therefore switch it off as soon as the rear window is clear. Otherwise,

the rear window defroster switches off automatically after several minutes.

If the battery voltage is too low, the rear window defroster may switch off.

- ▶ Turn the SmartKey to position **2** in the ignition lock (▷ page 147).
- ▶ Press the  button.  
The indicator lamp in the  button lights up or goes out.

**Problems with the rear window defroster**

Problem	Possible causes/consequences and ► Solutions
The rear window defroster has deactivated prematurely or cannot be activated.	The battery has not been sufficiently charged. ► Switch off any consumers that are not required, e.g. reading lamps, interior lighting or the seat heating. When the battery is sufficiently charged, the rear window defroster can be activated again.

**Activating/deactivating air-recirculation mode**



**Points to observe before use**

You can deactivate the flow of fresh air if unpleasant odors are entering the vehicle from outside. The air already inside the vehicle will then be recirculated.



If you switch on air-recirculation mode, the windows can fog up more quickly, in particular at low temperatures. Only use air-recirculation mode briefly to prevent the windows from fogging up.

The operation of air-recirculation mode is the same for all control panels.

**Activating/deactivating**

- Turn the SmartKey to position **2** in the ignition lock (► page 147).
- **To activate:** press the  button. The indicator lamp in the  button lights up.
- i** Dual-zone automatic climate control: air-recirculation mode is automatically activated at high outside temperatures.  
 3-zone automatic climate control: air-recirculation mode is automatically activated at high levels of pollution or at high outside temperatures.  
 When air-recirculation mode is activated automatically, the indicator lamp above the

 button does not light up. Outside air is added after about 30 minutes.

- **To deactivate:** press the  button. The indicator lamp in the  button goes out.

- i** Air-recirculation mode deactivates automatically:
  - after approximately five minutes at outside temperatures below approximately 41 °F (5 °C)
  - after approximately five minutes if cooling with air dehumidification is deactivated
  - after approximately 30 minutes at outside temperatures above approximately 41 °F(5 °C) if the "Cooling with air dehumidification" function is activated

**Activating/deactivating the residual heat function**

The residual heat function is only available in vehicles for Canada with 3-zone automatic climate control.

It is possible to make use of the residual heat of the engine to continue heating the vehicle for approximately 30 minutes after the engine has been switched off. The heating time depends on the temperature that has been set.

- ▶ Turn the SmartKey to position **0** in the ignition lock or remove it (▷ page 147).
- ▶ **To activate:** press the **REST** button. The indicator lamp in the **REST** button lights up.

**1** If the residual heat function is activated, the windows may fog up on the inside.

**i** The blower will run at a low speed regardless of the airflow setting.

**i** If you activate the residual heat function at high temperatures, only the ventilation will be activated. The blower runs at medium speed.

- ▶ **To deactivate:** press the **REST** button. The indicator lamp in the **REST** button goes out.

Residual heat is deactivated automatically:

- after approximately 30 minutes
- when the ignition is switched on
- if the battery voltage drops

## Setting the air vents

### Important safety notes

#### WARNING

Very hot or very cold air can flow from the air vents. This could result in burns or frostbite in the immediate vicinity of the air vents. There is a risk of injury.

Make sure that all vehicle occupants always maintain a sufficient distance to the air outlets. If necessary, redirect the airflow to another area of the vehicle interior.

In order to ensure the direct flow of fresh air through the air vents into the vehicle interior, please observe the following notes:

- keep the air inlet between the windshield and the hood free of blockages, such as ice, snow or leaves.
- never cover the air vents or air intake grilles in the vehicle interior.

## Setting the center air vents



- ① Center air vent, left
- ② Center air vent, right
- ③ Center vent thumbwheel, right
- ④ Center vent thumbwheel, left

- ▶ **To open/close:** turn thumbwheels ③ and ④ up or down.

## Setting the side air vents



- ① Defroster vent
- ② Side air vent
- ③ Control for side air vent

- ▶ **To open/close:** turn thumbwheel ③ up or down.

## Setting the glove box air vent

- !** Close the air vent when heating the vehicle.

At high outside temperatures, open the air vent and activate the "cooling with air



dehumidification" function. Otherwise, temperature-sensitive items stored in the glove box could be damaged.

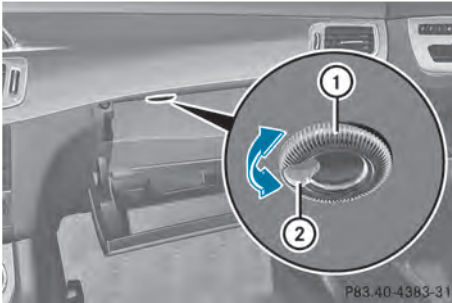

- ① Air vent thumbwheel
- ② Air vent

When automatic climate control is activated, the glove box can be ventilated, for instance to cool its contents. The level of airflow depends on the airflow and air distribution settings.

- **To open/close:** turn thumbwheel ① clockwise or counter-clockwise.

- ③ Rear control panel, only for Canada with 3-zone automatic climate control
- ④ Rear-compartment air vent, left

- **To open/close:** turn thumbwheel ① up or down.

### Setting the rear-compartment air vents

#### Setting the center vents in the rear compartment

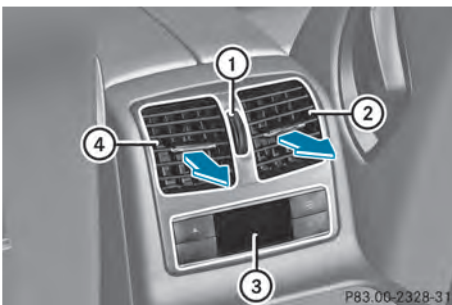

- ① Rear-compartment air vent thumbwheel
- ② Rear-compartment air vent, right



Useful information .....	146
Notes on breaking-in a new vehicle	146
Driving .....	146
Automatic transmission .....	155
Refueling .....	164
Parking .....	167
Driving tips .....	169
Driving systems .....	175

### Useful information

- i** This Operator's Manual describes all models and all standard and optional equipment of your vehicle available at the time of publication of the Operator's Manual. Country-specific differences are possible. Please note that your vehicle may not be equipped with all features described. This also applies to safety-related systems and functions.
- i** Read the information on qualified specialist workshops: (▷ page 26).

### Notes on breaking-in a new vehicle

#### Important safety notes

New and replaced brake pads and discs only reach their optimum braking effect after several hundred kilometers of driving. Compensate for this by applying greater force to the brake pedal.

#### The first 1000miles (1500 km)

The more you look after the engine when it is new, the more satisfied you will be with its performance in the future.

- You should therefore drive at varying vehicle and engine speeds for the first 1000 miles (1500 km).
- Avoid heavy loads, e.g. driving at full throttle, during this period.
- Change gear in good time, before the tachometer needle is  $\frac{2}{3}$  of the way to the red area of the tachometer.
- Do not manually shift to a lower gear to brake the vehicle.
- If possible, do not depress the accelerator pedal past the point of resistance (kickdown).
- Only select shift ranges **3**, **2** or **1** when driving slowly, e.g. in mountainous terrain.

After 1000 miles (1500 km), you can increase the engine speed gradually and accelerate the vehicle to full speed.

Additional breaking-in notes for AMG vehicles:

- Do not drive faster than 85 mph (140 km/h) for the first 1000 miles (1500 km).
- Only allow the engine to reach a maximum engine speed of 4500 rpm briefly.
- Change gear in good time.
- i** You should also observe these notes on breaking in if the engine or parts of the drive train on your vehicle have been replaced.
- i** Always observe the respective speed limits.

#### AMG vehicles with self-locking rear axle differential

Your vehicle is equipped with a self-locking differential on the rear axle. To protect the differential on the rear axle, carry out an oil change after a breaking-in phase of 2000 miles (3000 km). This oil change prolongs the service life of the differential. Have the oil change carried out at a qualified specialist workshop.

### Driving

#### Important safety notes

#### WARNING

Objects in the driver's footwell can restrict the pedal travel or obstruct a depressed pedal. The operating and road safety of the vehicle is jeopardized. There is a risk of an accident.

Make sure that all objects in the vehicle are stowed correctly, and that they cannot enter the driver's footwell. Install the floor mats securely and as specified in order to ensure sufficient clearance for the pedals. Do not use loose floor mats.

**⚠ WARNING**

Unsuitable footwear can hinder correct usage of the pedals, e.g.:

- shoes with thick soles
- shoes with high heels
- slippers

There is a risk of an accident.

Wear suitable footwear to ensure correct usage of the pedals.

**⚠ WARNING**

If you switch off the ignition while driving, safety-relevant functions are only available with limitations, or not at all. This could affect, for example, the power steering and the brake boosting effect. You will require considerably more effort to steer and brake. There is a risk of an accident.

Do not switch off the ignition while driving.

**⚠ WARNING**

If the parking brake has not been fully released when driving, the parking brake can:

- overheat and cause a fire
- lose its hold function.

There is a risk of fire and an accident. Release the parking brake fully before driving off.

**!** Warm up the engine quickly. Do not use the engine's full performance until it has reached operating temperature.

Only shift the automatic transmission to the desired drive position when the vehicle is stationary.

Where possible, avoid spinning the drive wheels when pulling away on slippery roads. You could otherwise damage the drive train.

**!** **AMG vehicles:** at low engine oil temperatures below 68 °F (+20 °C), the maximum engine speed is restricted in order to protect the engine. To protect the engine and maintain smooth engine

operation, avoid driving at full throttle when the engine is cold.

**Key positions**

**SmartKey**

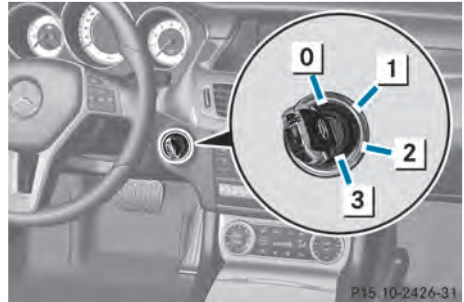

- 0** To remove the SmartKey (shift the transmission to position **P**)
  - 1** Power supply for some consumers, such as the windshield wipers
  - 2** Ignition (power supply for all consumers) and drive position
  - 3** To start the engine
- i** The SmartKey can be turned in the ignition lock even if it is not the correct SmartKey for the vehicle. The ignition is not switched on. The engine cannot be started.

**KEYLESS-GO**

**General notes**

- Do not store the KEYLESS-GO key together with:
  - electronic devices, e.g. a mobile phone or another SmartKey
  - metallic objects, e.g. coins or metal film
- Do not keep the KEYLESS-GO key in metal objects, e.g. metal cases.

This can affect the functionality of KEYLESS-GO.

Vehicles with KEYLESS-GO are equipped with keys featuring the integrated KEYLESS-GO function and a detachable Start/Stop button.

The Start/Stop button must be inserted in the ignition lock and the SmartKey must be in the vehicle.

Pressing the Start/Stop button several times in succession corresponds to the different key positions in the ignition lock. This is only the case if you are not depressing the brake pedal.

If you depress the brake pedal and press the Start/Stop button, the engine starts immediately.

The Start/Stop button can be removed from the ignition lock. Then, you can insert the SmartKey into the ignition lock.

**i** You do not have to remove the Start/Stop button from the ignition lock when you leave the vehicle. You should, however, always take the SmartKey with you when leaving the vehicle. As long as the SmartKey is in the vehicle:

- the vehicle can be started using the Start/Stop button and
- electrically powered equipment can be operated.

### Key positions with KEYLESS-GO



As soon as the ignition is switched on, all the indicator lamps in the instrument cluster light up. If an indicator lamp does not go out after starting the engine or lights up while driving, see (▷ page 266).

► Insert Start/Stop button ① into ignition lock ②.

**i** When you insert Start/Stop button ① into ignition lock ②, the system needs approximately two seconds recognition time. You can then use Start/Stop button ①.

### Activating power supply

► Position 0: if Start/Stop button ① has not yet been pressed, this corresponds to the SmartKey being removed from the ignition.

► Position 1: press Start/Stop button ①. The power supply is switched on. You can now activate the windshield wipers, for example.

**i** If you then open the driver's door when in this position, the power supply is deactivated.

### Switching on the ignition

► Position 2 (ignition): press Start/Stop button ① twice.

The ignition is switched on.

**i** The ignition is switched off when:

- the driver's door is opened and
- you press Start/Stop button ① once when in this position.

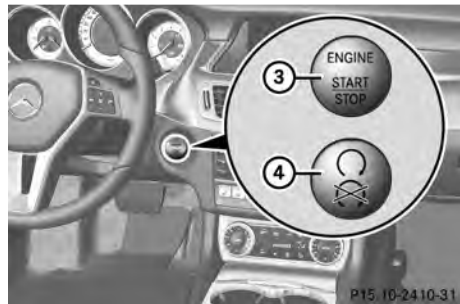

Start/Stop button

③ USA only

④ Canada only

## Starting the engine

### Important safety notes

#### WARNING

If children are left unsupervised in the vehicle, they could:

- open the doors, thus endangering other people or road users.
- get out and disrupt traffic.
- operate the vehicle's equipment.

Additionally, children could set the vehicle in motion if, for example, they:

- release the parking brake.
- shift the automatic transmission out of parking position P.
- starting the engine.

There is a risk of an accident and injury.

When leaving the vehicle, always take the SmartKey with you and lock the vehicle. Never leave children or animals unattended in the vehicle. Always keep the SmartKey out of reach of children.

#### WARNING

Combustion engines emit poisonous exhaust gases such as carbon monoxide. Inhaling these exhaust gases leads to poisoning. There is a risk of fatal injury. Therefore never leave the engine running in enclosed spaces without sufficient ventilation.

#### WARNING

Flammable materials introduced through environmental influence or by animals can ignite if in contact with the exhaust system or parts of the engine that heat up. There is a risk of fire.

Carry out regular checks to make sure that there are no flammable foreign materials in the engine compartment or in the exhaust system.

-  Do not depress the accelerator pedal when starting the engine.

## General notes

-  The catalytic converter is preheated for up to 30 seconds after a cold start. The sound of the engine may change during this time.

## Automatic transmission

- ▶ Shift the transmission to position **P**. The transmission position display in the multifunction display shows **P**.

-  You can also start the engine when the transmission is in position **N**.

## Starting procedure with the SmartKey

-  To start the engine using the SmartKey instead of KEYLESS-GO, pull the Start/Stop button out of the ignition lock.
- ▶ Turn the SmartKey to position **3** in the ignition lock (▷ page 147) and release it as soon as the engine is running.

## Using KEYLESS-GO to start the engine

-  The Start/Stop button can be used to start the vehicle manually without inserting the SmartKey into the ignition lock. The Start/Stop button must be inserted in the ignition lock and the SmartKey must be in the vehicle. This mode for starting the engine operates independently of the ECO start/stop automatic engine start function.
- ▶ Depress the brake pedal and keep it depressed.
- ▶ Press the Start/Stop button once (▷ page 147). The engine starts.

## Pulling away

### Automatic transmission

#### WARNING

If the engine speed is above the idling speed and you engage transmission position **D** or **R**, the vehicle could pull away suddenly. There is a risk of an accident.

When engaging transmission position **D** or **R**, always firmly depress the brake pedal and do not simultaneously accelerate.

**i** If a warning tone sounds and the **Release Park. Brake** message appears in the multifunction display, the parking brake is still applied. Release the parking brake.

- ▶ Depress the brake pedal and keep it depressed.
- ▶ Shift the transmission to position **D** or **R**.
- ▶ Release the parking brake (▷ page 169).
- ▶ Release the brake pedal.
- ▶ Carefully depress the accelerator pedal.

**i** It is only possible to shift the transmission from position **P** to the desired position if you depress the brake pedal. Only then is the parking lock released. If you do not depress the brake pedal, you can move the DIRECT SELECT lever but the parking lock remains engaged.

**i** The vehicle locks centrally once you have pulled away. The locking knobs in the doors drop down.

You can open the doors from the inside at any time.

You can also deactivate the automatic locking feature (▷ page 232).

**i** Upshifts take place at higher engine speeds after a cold start. This helps the catalytic converter to reach its operating temperature more quickly.

## Hill start assist

#### WARNING

After a short time, hill start assist will no longer brake your vehicle and it could roll away. There is a risk of an accident and injury.

Therefore, quickly move your foot from the brake pedal to the accelerator pedal. Never leave the vehicle when it is held by hill start assist.

Hill start assist helps you when pulling away forwards or in reverse on an uphill gradient. It holds the vehicle for a short time after you have removed your foot from the brake pedal. This gives you enough time to move your foot from the brake pedal to the accelerator pedal and to depress it before the vehicle begins to roll.

- ▶ Take your foot off the brake pedal. The vehicle is then held for about a second.
- ▶ Pull away.

Hill start assist will not function if:

- you are pulling away on a level road or on a downhill gradient.
- the transmission is in position **N**.
- the parking brake is applied.
- ESP® is malfunctioning.

## ECO start/stop function

### Introduction

The ECO start/stop function switches the engine off automatically if the vehicle is stopped under certain conditions.

The engine starts automatically when the driver wants to pull away again. The ECO start/stop function thereby helps you to reduce the fuel consumption and emissions of your vehicle.



## Important safety notes

### WARNING

If the engine is switched off automatically and you exit the vehicle, the engine is restarted automatically. The vehicle may begin moving. There is a risk of accident and injury.

If you wish to exit the vehicle, always turn off the ignition and secure the vehicle against rolling away.

## General notes

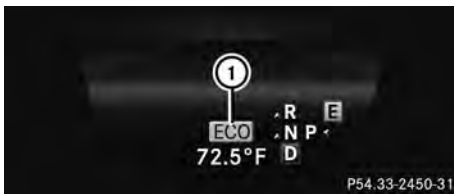

### ① ECO start/stop display

If the **ECO** symbol is shown in green in the multifunction display, the ECO start/stop function switches the engine off automatically if the vehicle stops moving. Every time you switch on the engine using the SmartKey or the Start/Stop button, the ECO start/stop function is activated.

If the ECO start/stop function has been manually deactivated (▷ page 152) or a malfunction has caused the system to be deactivated, the **ECO** symbol is not displayed.

**AMG vehicles:** the **Stop/Start active** or **Stop/Start inactive** message in the AMG menu in the multifunction display goes out.

**AMG vehicles:** the ECO start/stop function is only available in drive program **C**.

For further information on automatic engine switch-off (▷ page 151) and automatic engine start (▷ page 152).

## Automatic engine switch-off

### General notes

If the vehicle is braked to a standstill in **D** or **N**, the ECO start/stop function switches off the engine automatically.

The ECO start/stop function is operational and the **ECO** symbol is displayed in green in the multifunction display, if:

- the indicator lamp in the ECO button is lit green.
- the outside temperature is within the comfort range.
- the engine is at normal operating temperature.
- the set temperature for the vehicle interior has been reached.
- the battery is sufficiently charged.
- the system detects that the windshield is not fogged up when the air-conditioning system is switched on.
- the hood is closed.
- the driver's door is closed and the driver's seat belt is fastened.

If conditions for automatic engine switch-off have not been fulfilled, the **ECO** symbol will be shown in yellow.

**AMG vehicles:** the AMG menu in the multifunction display also shows the **Stop/Start inactive** message.

- ① If you shift the transmission from **R** to **D**, the ECO start/stop function is available again once the **ECO** symbol reappears in green in the multifunction display.
- ① All of the vehicle's systems remain active when the engine has been stopped automatically.

- ① **All vehicles (apart from AMG vehicles):** automatic engine switch-off can take place a maximum of four times consecutively (initial stop then repeated three times). The **ECO** symbol is shown in yellow in the multifunction display after the engine has been started automatically for

the fourth time. When the **ECO** symbol is shown in green in the multifunction display, automatic engine switch-off is again possible.

- i** **AMG vehicles:** times which the engine can be automatically switched off.
- i** The HOLD function can also be activated if the engine has been switched off automatically. It is then not necessary to continue applying the brakes during the automatic stop phase. When you depress the accelerator pedal, the engine starts automatically and the braking effect of the HOLD function is deactivated.

### Automatic engine start

The engine starts automatically if:

- you switch off the ECO start/stop function by pressing the ECO button.
  - you release the brakes when in transmission position **D** or **N** and when the HOLD function is not active.
  - you depress the accelerator pedal.
  - you engage reverse gear **R**.
  - you move the transmission out of position **P**.
  - you switch to drive program **S**, **S+** or **M** (AMG vehicles).
  - you unfasten your seat belt or open the driver's door.
  - the vehicle starts to roll.
  - the brake system requires this.
  - the temperature in the vehicle interior deviates from the set range.
  - the system detects moisture on the windshield when the air-conditioning system is switched on.
  - the charge level of the battery is too low.
- i** Shifting the transmission to position **P** does not start the engine.
  - i** If you shift the transmission from **R** to **D**, the ECO start/stop function is available

again once the **ECO** symbol reappears in green in the multifunction display.

### Deactivating/activating the ECO start/stop function



ECO button

- ▶ **To switch off (except AMG vehicles):** press button ①. Indicator lamp ② and the **ECO** symbol in the multifunction display go out.
  - ▶ **To switch on (except AMG vehicles):** press button ①. Indicator lamp ② lights up. If all conditions for automatic engine switch-off (▷ page 151) are fulfilled, the **ECO** symbol is shown in green in the multifunction display. If not all conditions for automatic engine switch-off (▷ page 151) are fulfilled, the **ECO** symbol is shown in yellow in the multifunction display. If this is the case, the ECO start/stop function is not available.
  - ▶ **To switch off (AMG vehicles):** press button ① in drive program **C**.
- or
- ▶ Switch to drive program **S**, **S+** or **M** (▷ page 159). Indicator lamp ② and the **ECO** symbol in the multifunction display go out. The **Stop/Start active** or **Stop/Start inactive** message in the AMG menu in the multifunction display goes out.

- **To switch on (AMG vehicles):** press button ①.
- Indicator lamp ② lights up. If drive program **S**, **S+** or **M** is active, the automatic transmission switches to drive program **C**.
- If all conditions for automatic engine switch-off (▷ page 151) are fulfilled, the **ECO** symbol is shown in green in the multifunction display. In addition, the **Stop/Start active** message is shown in the AMG menu in the multifunction display.
- If conditions for automatic engine switch-off (▷ page 151) have not been fulfilled, the **ECO** symbol will be shown in yellow. If this is the case, the ECO start/stop function is not available. In addition, the **Stop/Start inactive** message is shown in the AMG menu in the multifunction display.
- ❗ If indicator lamp ② is off, the ECO start/stop function has been deactivated manually or as the result of a malfunction. The engine will then not be switched off automatically when the vehicle stops.

Problems with the engine	
Problem	Possible causes/consequences and ► Solutions
The engine does not start. The starter motor can be heard.	<ul style="list-style-type: none"> <li>• There is a malfunction in the engine electronics.</li> <li>• There is a malfunction in the fuel supply.</li> </ul> <p>► Before attempting to start the engine again, turn the SmartKey in the ignition back to position <b>0</b> or press the Start/Stop button repeatedly until all indicator lamps in the instrument cluster go out.</p> <p>► Try to start the engine again (▷ page 149). Avoid excessively long and frequent attempts to start the engine as these will drain the battery.</p> <p>If the engine does not start after several attempts:</p> <p>► Consult a qualified specialist workshop.</p>
The engine does not start. You cannot hear the starter motor.	<p>The on-board voltage is too low because the battery is too weak or discharged.</p> <p>► Jump-start the vehicle (▷ page 326).</p> <p>If the engine does not start despite attempts to jump-start it:</p> <p>► Consult a qualified specialist workshop.</p> <p>The starter motor was exposed to a thermal load that was too high.</p> <p>► Allow the starter motor to cool down for approximately two minutes.</p> <p>► Try to start the engine again.</p> <p>If the engine still does not start:</p> <p>► Consult a qualified specialist workshop.</p>
The engine is not running smoothly and is misfiring.	<p>There is a malfunction in the engine electronics or in a mechanical component of the engine management system.</p> <p>► Only depress the accelerator pedal slightly.</p> <p>► Have the cause rectified immediately at a qualified specialist workshop.</p> <p>Otherwise, non-combusted fuel may get into the catalytic converter and damage it.</p>
The coolant temperature gauge shows a value above 248 °F (120 °C).	<p>The coolant level is too low. The coolant is too hot and the engine is no longer being cooled sufficiently.</p> <p>► Stop as soon as possible and allow the engine and the coolant to cool down.</p> <p>► Check the coolant level (▷ page 308). Observe the warning notes as you do so and add coolant if necessary.</p>

## Automatic transmission

### Important safety notes

#### WARNING

If the engine speed is above the idling speed and you engage transmission position **D** or **R**, the vehicle could pull away suddenly. There is a risk of an accident.

When engaging transmission position **D** or **R**, always firmly depress the brake pedal and do not simultaneously accelerate.

#### WARNING

The automatic transmission switches to neutral position **N** when you switch off the engine. The vehicle may roll away. There is a risk of an accident.

After switching off the engine, always switch to parking position **P**. Prevent the parked vehicle from rolling away by applying the parking brake.

### Selector lever

#### Overview of transmission positions

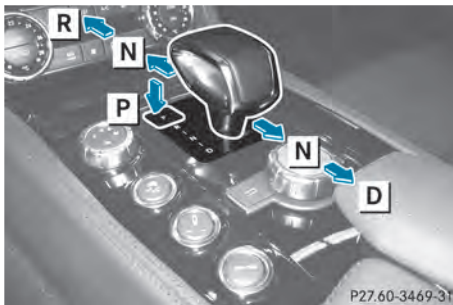

Selector lever in AMG vehicles with P button

- P** Park position with parking lock
- R** Reverse gear
- N** Neutral
- D** Drive

### Transmission position and drive program display

**!** If the transmission position display in the multifunction display is not working, you should pull away carefully to check whether the desired transmission position is engaged. Ideally, you should select transmission position **D** and drive program **C**. Do not restrict the shift range.



- ① Transmission position display
- ② Drive program display

The current position of the selector lever is shown by the indicators next to the selector lever.

The indicators light up when the SmartKey is inserted into the ignition lock. The indicators go out when the SmartKey is removed from the ignition lock.

### DIRECT SELECT lever

#### Overview of transmission positions

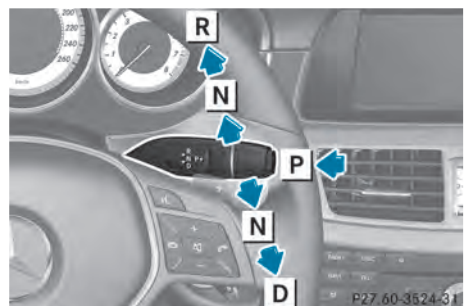

- P** Park position with parking lock
- R** Reverse gear
- N** Neutral
- D** Drive

The DIRECT SELECT lever is on the right of the steering column.

- ① The DIRECT SELECT lever always returns to its original position. The current transmission position **P**, **R**, **N** or **D** appears in the transmission position display (▷ page 155) in the multifunction display.

### Transmission position and drive program display

- ⚠ If the transmission position display in the multifunction display is not working, you should pull away carefully to check whether the desired transmission position is engaged. Ideally, you should select transmission position **D** and drive program **E** or **S**. Do not restrict the shift range.



- ① Transmission position display
- ② Drive program display

The current transmission position and drive program appear in the multifunction display.

- ① The arrows in the transmission position display show how and into which transmission positions you can change using the DIRECT SELECT lever.

### Engaging park position P

- ⚠ If the engine speed is too high or the vehicle is moving, do not shift the automatic transmission directly from **D** to **R**, from **R** to **D** or directly to **P**. The automatic transmission could otherwise be damaged.

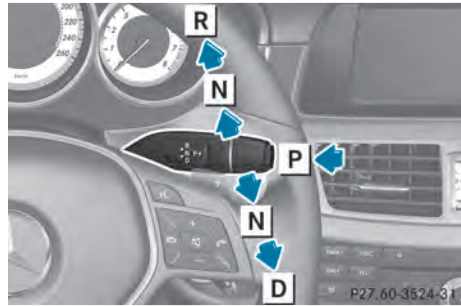

- P** Park position with parking lock
- R** Reverse gear
- N** Neutral
- D** Drive

- ▶ Push the DIRECT SELECT lever in the direction of arrow **P**.

- ① The automatic transmission shifts into park position **P** automatically:
  - if you open the driver's door while the vehicle is stationary in transmission position **D** or **R**
  - if you open the door while traveling at very low speeds in transmission position **D** or **R**

**HOLD function or DISTRONIC PLUS:** if the vehicle is braked using the HOLD function or DISTRONIC PLUS, the automatic transmission shifts automatically to transmission position **P**. In addition, at least one of the following conditions must be fulfilled:

- the engine is switched off.
- the driver's door is open and the seat belt is not in the buckle.

## Engaging park position P in AMG vehicles



- ▶ When the vehicle is stationary, press **P** button ①.

## Engaging reverse gear R

**!** Only shift the automatic transmission to **R** when the vehicle is stationary.

- ▶ When the vehicle is stationary, depress the brake pedal.
- ▶ Push the DIRECT SELECT lever up past the first point of resistance.

## Shifting to neutral N

### **!** WARNING

If children are left unsupervised in the vehicle, they could:

- open the doors, thus endangering other people or road users.
- get out and disrupt traffic.
- operate the vehicle's equipment.

Additionally, children could set the vehicle in motion if, for example, they:

- release the parking brake.
- shift the automatic transmission out of parking position **P**.
- starting the engine.

There is a risk of an accident and injury.

When leaving the vehicle, always take the SmartKey with you and lock the vehicle. Never leave children or animals unattended in the

vehicle. Always keep the SmartKey out of reach of children.

- ▶ When the vehicle is stationary, depress the brake pedal.
- ▶ Push the DIRECT SELECT lever up or down to the first point of resistance.

If the engine has been switched off, the automatic transmission automatically shifts to **N**.

If the automatic transmission is to remain in neutral **N**, e.g. for washing the vehicle in car washes with a towing device, please observe the following instructions:

### Using the SmartKey:

- Make sure that the ignition is switched on.
- When the vehicle is stationary, depress the brake pedal and keep it depressed.
- Shift to neutral **N**.
- Release the brake pedal.
- If the parking brake is engaged, release it.
- Switch off the ignition and leave the SmartKey in the ignition lock.

### Using KEYLESS-GO:

- Make sure that the ignition is switched on.
- When the vehicle is stationary, depress the brake pedal and keep it depressed.
- Engage park position **P**.
- Release the brake pedal.
- Remove the Start/Stop button from the ignition lock.
- Insert the SmartKey into the ignition lock.
- Switch on the ignition.
- Depress the brake pedal and keep it depressed.
- Shift to neutral **N**.
- Release the brake pedal.
- If the parking brake is engaged, release it.
- Switch off the ignition and leave the SmartKey in the ignition lock.

### Engaging drive position D

- ▶ When the vehicle is stationary, depress the brake pedal.
- ▶ Push the DIRECT SELECT lever down past the first point of resistance.

### Transmission positions

**P**

#### Park position

Do not shift the transmission into position **P** (▷ page 167) unless the vehicle is stationary. The parking lock should not be used as a brake when parking. In addition to engaging the parking lock, you must always apply the parking brake to secure the vehicle.

If the vehicle electronics are malfunctioning, the transmission may be locked in position **P**.

Have the vehicle electronics checked immediately at a qualified specialist workshop.

**R**

#### Reverse gear

Only shift the transmission to **R** when the vehicle is stationary.

**N**

#### Neutral

Do not shift the transmission to **N** while driving. The transmission could otherwise be damaged.

No power is transmitted from the engine to the drive wheels.

Releasing the brakes will allow you to move the vehicle freely, e.g. to push it or tow it.

If ESP® is deactivated or faulty: only shift the transmission to position **N** if the vehicle is in danger of skidding, e.g. on icy roads.

**!** Rolling in neutral **N** can damage the drive train.

**D**

#### Drive

The automatic transmission changes gear automatically. All forward gears are available.

### Changing gear

The automatic transmission shifts to the individual gears automatically when it is in transmission position **D**. This automatic gearshifting behavior is determined by:

- a shift range restriction, if selected
- the selected drive program (▷ page 159)
- the position of the accelerator pedal
- the road speed

### Driving tips

#### AMG vehicles

When shifting down, the double-clutch function is active regardless of the currently selected drive program. The double-clutch function reduces load change reactions and is conducive to a sporty driving style. The sound generated by the double-clutch function depends on the drive program selected.



## Kickdown

Use kickdown for maximum acceleration.

- ▶ Depress the accelerator pedal beyond the pressure point.  
The automatic transmission shifts to a lower gear depending on the engine speed.
- ▶ Ease off the accelerator pedal once the desired speed is reached.  
The automatic transmission shifts back up.

## Rocking the vehicle free

Rocking the vehicle free by shifting back and forth between transmission positions **D** and **R** can help to free a vehicle that has become stuck in mud or snow. The vehicle's engine management restricts repeated shifting between gears **D** and **R** up to a maximum speed of up to 5 mph (9 km/h). To shift back and forth between transmission positions **D** and **R**, move the selector lever up and down beyond the pressure point.

## Program selector button

### General notes



All vehicles (except AMG vehicles and vehicles with the Sports package AMG)

- ▶ Press program selector button ① repeatedly until the letter for the desired gearshift program appears in the multifunction display.



Vehicles with the Sports package AMG

- ▶ Press program selector button ① repeatedly until the letter for the desired drive program appears in the multifunction display.

The program selector button allows you to choose between different driving characteristics.

<b>E</b> Economy	Comfortable, economical driving
<b>S</b> Sport	Sporty driving style
<b>M</b> Manual	Manual gear shifting

- ❗ For further information on the automatic drive program, see (▶ page 160).
- ❗ The automatic transmission shifts to automatic drive program **E** each time the engine is started.

## AMG vehicles



Drive program selector with manual drive program

- ▶ Turn drive program selector ① until the desired drive program appears in the multifunction display in the speedometer. The drive program indicator on drive program selector ① lights up in red.

<b>C</b> Controlled Efficiency	Comfortable, economical driving
<b>S</b> Sport	Sporty driving style
<b>S+</b> SportPlus	Extremely sporty driving style
<b>M</b> Manual	Manual gear shifting
<b>RS RACE START</b>	Optimal vehicle acceleration from a standstill

- ① For further information on the automatic drive program, see (▷ page 160).

Only change from automatic drive program **C**, **S** or **S+** to manual drive program **M** when the vehicle is stationary.

- ① The automatic transmission shifts to automatic drive program **C** each time the engine is started.
- ① **RS** cannot be selected during normal driving. For further information on RACE START, see (▷ page 188).

### Steering wheel paddle shifters

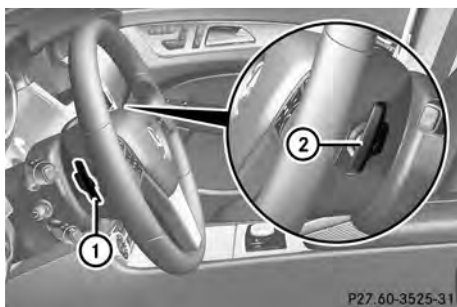

P27.60-3525-31

- ① Left-hand steering wheel paddle shifter
- ② Right-hand steering wheel paddle shifter

In the automatic drive program, you can restrict or derestrict the shift range by using the steering wheel paddle shifters (▷ page 162).

- ① You can only change gear with the steering wheel paddle shifters when the transmission is in position **D**.

### Automatic drive program

#### Automatic drive programs **E** and **S**

Drive program **E** (drive program **C** on MAG vehicles) is characterized by the following:

- comfort-oriented engine and automatic transmission settings
- optimal fuel consumption resulting from the automatic transmission shifting up sooner
- the vehicle pulling away more gently in forward and reverse gears, unless the accelerator pedal is depressed fully
- increased sensitivity. This improves driving stability on slippery road surfaces, for example
- the automatic transmission shifting up sooner. This results in the vehicle being driven at lower engine speeds and the wheels being less likely to spin

Drive program **S** (or, in the case of AMG vehicles, drive programs **S** and **S+**) is characterized by the following:

- sporty engine and automatic transmission settings
- the vehicle pulling away in first gear
- the automatic transmission shifting up later
- the fuel consumption possibly being higher as a result of the later automatic transmission shift points

## Manual drive program M

### General notes

You can activate manual drive program **M** in the **E** and **S** automatic drive programs.

In manual drive program **M**, you can briefly change gear yourself by using the steering wheel paddle shifters. The transmission must be in position **D**.

### Activating

- ▶ Shift the transmission to position **D**.
- ▶ Pull the left or right steering wheel paddle shifter (▷ page 160).  
Manual drive program **M** is temporarily activated. The selected gear and **M** appear in the multifunction display.

### Shifting gears

If you pull on the left or right steering wheel paddle shifter, the automatic transmission switches to manual drive program **M** for a limited amount of time. Depending on which paddle shifter is pulled, the automatic transmission immediately shifts into the next gear down or up, if permitted.

- ▶ **To shift up:** pull the right-hand steering wheel paddle shifter (▷ page 160).  
The automatic transmission shifts up to the next gear.
- i** If the maximum engine speed on the currently engaged gear is reached and you continue to accelerate, the automatic transmission automatically shifts up in order to prevent engine damage.
- ▶ **To shift down:** pull on the left-hand steering wheel paddle shifter (▷ page 160).  
The automatic transmission shifts down to the next gear.
- i** If the engine exceeds the maximum engine speed when shifting down, the automatic transmission protects against engine damage by not shifting down.
- i** Automatic down shifting occurs when coasting.

### Shift recommendation



The gearshift recommendations assist you in adopting an economical driving style. The recommended gear is shown in the multifunction display.

- ▶ Shift to recommended gear ② according to gearshift recommendation ① when shown in the multifunction display of the instrument cluster.

### Disarming

If you have activated manual drive program **M**, it will remain active for a certain amount of time. Under certain conditions the minimum amount of time is extended, e.g. in the case of lateral acceleration, during an overrun phase or when driving on steep terrain.

If manual drive program **M** has been deactivated, the automatic transmission shifts into the automatic drive program that was last selected, i.e. **E** or **S**.

You can also deactivate manual drive program **M** yourself:

- ▶ Pull on the right-hand steering wheel paddle shifter and hold it in place (▷ page 160).
- or
- ▶ Use the DIRECT SELECT lever to switch the transmission position.
- or
- ▶ Use the program selector button to change the drive program (▷ page 159).  
Manual drive program **M** is deactivated. The automatic transmission switches into the automatic drive program that was last selected, i.e. **E** or **S**.

## Shift ranges

### Introduction

- i** You can restrict or derestrict the shift range by using the steering wheel paddle shifters.

When the automatic transmission is in position **D**, it is possible to restrict or expand the shift range (▷ page 162).

The shift range selected is shown in the multifunction display. The automatic transmission shifts only as far as the selected gear.

### Shift range:

<b>3</b>	You can use the engine's braking effect
<b>2</b>	You can use the braking effect of the engine on downhill gradients and for driving: <ul style="list-style-type: none"> <li>• on steep mountain roads</li> <li>• in mountainous terrain</li> <li>• in arduous conditions</li> </ul>
<b>1</b>	To use the braking effect of the engine on extremely steep downhill gradients and on long downhill stretches

### Restricting the shift range

- ▶ Pull the left-hand steering wheel paddle shifter.  
The automatic transmission shifts down one gear and restricts the shift range to the relevant gear.
- i** If the engine exceeds the maximum engine speed when shifting down, the automatic transmission protects against engine damage by not shifting down.
- i** If the maximum engine speed for the shift range is reached and you continue to accelerate, the automatic transmission shifts up, even if the shift range is

restricted. This prevents the engine from overrevving.

### Extending the shift range

- ▶ Pull the right-hand steering wheel paddle shifter.  
The shift range is derestricted.

### Clearing the shift range restriction

- ▶ Pull and hold the right-hand steering wheel paddle shifter until **D** is shown again in the multifunction display.  
The automatic transmission shifts from the current shift range directly to **D**.

### Selecting the ideal shift range

- ▶ Pull the left-hand steering wheel paddle shifter and hold it in position.  
The automatic transmission shifts to the gear which allows optimum acceleration and deceleration. To do this, the automatic transmission shifts down one or more gears.

## Manual drive program (AMG vehicles and vehicles with AMG Sports package)

### Switching on the manual drive program

- ▶ Turn the drive program selector (▷ page 159) until **M** appears in the multifunction display.  
The indicator **M** on the drive program selector lights up in red.

The manual drive program is only available for AMG vehicles.

Manual drive program **M** is different from drive programs **S** and **S+** with regard to spontaneity, responsiveness and smoothness of gear changes.

Manual drive program **M** can be selected using the drive program selector. In manual drive program **M**, you can change gear using

the steering wheel paddle shifters if the transmission is in position **D**. The gear currently selected and engaged is shown in the multifunction display.

## Upshifting

- ❗ In manual drive program **M**, the automatic transmission does not shift up automatically even when the engine limiting speed for the current gear is reached. When the engine limiting speed is reached, the fuel supply is cut to prevent the engine from overrevving. Always make sure that the engine speed does not reach the red area of the tachometer. There is otherwise a risk of engine damage.
- ▶ Pull the right-hand steering wheel paddle shifter.  
The automatic transmission shifts up to the next gear.



- ① Upshift indicator
- ② Gear indicator

Before the engine speed reaches the red area, an upshift indicator will be shown in the multifunction display.

## Downshifting

- ▶ Pull the left-hand steering wheel paddle shifter.  
The automatic transmission shifts down to the next gear.
- ❗ If you brake the vehicle or stop without shifting down, the automatic transmission will shift down to a gear that will allow the vehicle to accelerate or pull away again.
- ❗ For maximum acceleration, pull the left-hand steering wheel paddle shifter until the

transmission selects the optimum gear for the current speed.

## Kickdown

- ❗ Kickdown is not possible in manual drive program **M**.

## Switching off the manual drive program

- ▶ Press the program selector button (▷ page 159) repeatedly until **E** or **S** appears in the multifunction display.
- ▶ **AMG vehicles:** turn the drive program selector (▷ page 159) until **C**, **S** or **S+** appears in the multifunction display.

## Problems with the transmission

Problem	Possible causes/consequences and ► Solutions
The transmission has problems shifting gear.	The transmission is losing oil. ► Have the transmission checked at a qualified specialist workshop immediately.
The acceleration ability is deteriorating. The transmission no longer changes gear.	The transmission is in emergency mode. It is only possible to shift into <b>second</b> gear and reverse gear. ► Stop the vehicle. ► Shift the transmission to position <b>P</b> . ► Switch off the engine. ► Wait at least ten seconds before restarting the engine. ► Shift the transmission to position <b>D</b> or <b>R</b> . If <b>D</b> is selected, the transmission shifts into <b>second</b> gear; if <b>R</b> is selected, the transmission shifts into reverse gear. ► Have the transmission checked at a qualified specialist workshop immediately.

## Refueling

## Important safety notes

 **WARNING**

Fuel is highly flammable. If you handle fuel incorrectly, there is a risk of fire and explosion.

You must avoid fire, open flames, creating sparks and smoking. Switch off the engine and, if applicable, the auxiliary heating before refueling.

 **WARNING**

Fuel is poisonous and hazardous to health. There is a risk of injury.

You must make sure that fuel does not come into contact with your skin, eyes or clothing and that it is not swallowed. Do not inhale fuel vapors. Keep fuel away from children.

If you or others come into contact with fuel, observe the following:

- Wash away fuel from skin immediately using soap and water.
- If fuel comes into contact with your eyes, immediately rinse them thoroughly with clean water. Seek medical assistance without delay.
- If fuel is swallowed, seek medical assistance without delay. Do not induce vomiting.
- Immediately change out of clothing which has come into contact with fuel.

 **WARNING**

Electrostatic buildup can create sparks and ignite fuel vapors. There is a risk of fire and explosion.

Always touch the vehicle body before opening the fuel filler flap or touching the fuel pump nozzle. Any existing electrostatic buildup is thereby discharged.

**!** Do not use diesel to refuel vehicles with a gasoline engine. Do not switch on the ignition if you accidentally refuel with the wrong fuel. Otherwise, the fuel will enter the fuel system. Even small amounts of the wrong fuel could result in damage to the fuel system and the engine. The repair costs are high. Notify a qualified specialist workshop and have the fuel tank and fuel lines drained completely.

**!** Overfilling the fuel tank could damage the fuel system.

**!** Take care not to spill any fuel on painted surfaces. You could otherwise damage the paintwork.

**!** Use a filter when refueling from a fuel can. Otherwise, the fuel lines and/or injection system could be blocked by particles from the fuel can.

Do not get into the vehicle again during the refueling process. Otherwise, electrostatic charge could build up again.

If you overfill the fuel tank, fuel could spray out when the fuel pump nozzle is removed.

For further information on fuel and fuel quality (▷ page 374).

- ③ Tire pressure table
- ④ Fuel type to be used

The fuel filler flap is unlocked or locked automatically when you open or close the vehicle with the SmartKey or with KEYLESS-GO.

The position of the fuel filler cap is displayed  in the instrument cluster. The arrow next to the filling pump indicates the side of the vehicle.

### Opening the fuel filler flap

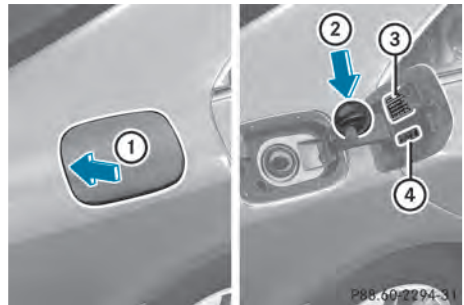

- ① To open the fuel filler flap
- ② To insert the fuel filler cap
- ③ Tire pressure table
- ④ Fuel type to be used

- ▶ Switch the engine off.
- ▶ Remove the SmartKey from the ignition lock.
- ▶ KEYLESS-GO: open the driver's door. This corresponds to key position **0**: "key removed".  
The driver's door can be closed again.
- ▶ Press the fuel filler flap in the direction of arrow ①.  
The fuel filler flap opens slightly.
- ▶ Open the fuel filler flap fully.
- ▶ Turn the fuel filler flap counter-clockwise and remove it.

## Refueling

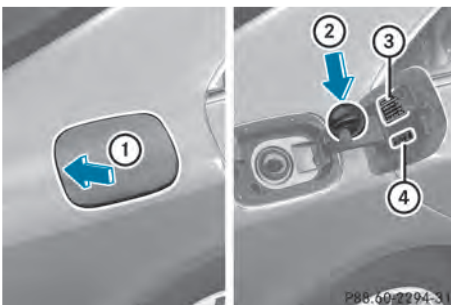

### Opening/closing the fuel filler flap



- ① To open the fuel filler flap
- ② To insert the fuel filler cap

- ▶ insert the fuel filler cap into the holder on the inside of fuel filler flap ②.
  - ▶ Completely insert the filler neck of the fuel pump nozzle into the tank, hook in place and refuel.
  - ▶ Only fill the tank until the pump nozzle switches off.
  - ① Do not add any more fuel after the pump stops filling for the first time. Otherwise, fuel may leak out.
- ▶ Open the right-hand side trim panel.
  - ▶ Remove the first-aid kit (▷ page 320).
  - ▶ Detach the emergency release from retainer ①.
  - ▶ Pull the emergency release in the direction of arrow ②.  
The fuel filler flap is unlocked.
  - ▶ Open the fuel filler flap.

### Closing the fuel filler flap

- ▶ Replace the cap on the filler neck and turn clockwise until it engages audibly.
- ▶ Close the fuel filler flap.
- ① Close the fuel filler flap before locking the vehicle. Otherwise, the locking pin of the central locking prevents the fuel filler flap from closing.
- ① If you are driving with the fuel filler cap open, the  reserve fuel warning lamp flashes. A message appears in the multifunction display (▷ page 251).  
In addition, the  Check Engine warning lamp may light up (▷ page 273).  
For further information on warning and indicator lamps in the instrument cluster, see (▷ page 273).

### Fuel filler flap emergency release

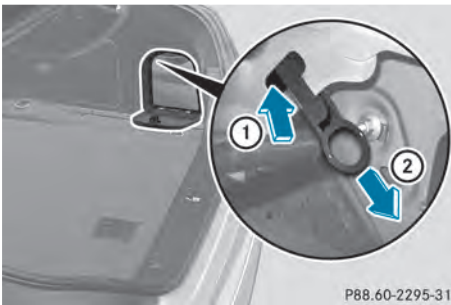

P88.60-2295-31

- ▶ open the trunk lid.
- ▶ Slide down the parcel net.



**Problems with fuel and the fuel tank**

Problem	Possible causes/consequences and ► Solutions
Fuel is leaking from the vehicle.	The fuel line or the fuel tank is faulty.  <b>WARNING</b> Risk of explosion or fire. ► Turn the SmartKey to position <b>0</b> in the ignition lock and remove it immediately (▷ page 147). ► Do not restart the engine under any circumstances. ► Consult a qualified specialist workshop.
The fuel filler flap cannot be opened.	The fuel filler flap is not unlocked. or The SmartKey battery is discharged. ► Unlock the vehicle using the mechanical key (▷ page 78). ► Open the trunk lid or the tailgate. ► open the trunk lid. ► Manually unlock the fuel filler flap using the emergency release (▷ page 166).  The fuel filler flap is unlocked, but the opening mechanism is jammed. ► Consult a qualified specialist workshop.

**Parking**

**Important safety notes**

 **WARNING**

If flammable materials such as leaves, grass or twigs are exposed to prolonged contact to parts of the exhaust system that heat up, they could ignite. There is a risk of fire.

Park the vehicle so that no flammable materials come into contact with parts of the vehicle which are hot. Take particular care not to park on dry grassland or harvested grain fields.

 **WARNING**

If you switch off the ignition while driving, safety-relevant functions are only available with limitations, or not at all. This could affect,

for example, the power steering and the brake boosting effect. You will require considerably more effort to steer and brake. There is a risk of an accident.

Do not switch off the ignition while driving.

 **WARNING**

If you leave children unsupervised in the vehicle, they could set it in motion by, for example:

- releasing the parking brake
- shifting the automatic transmission out of the parking position **P**
- starting the engine.

They could also operate the vehicle's equipment. There is a risk of an accident and injury.

When leaving the vehicle, always take the SmartKey with you and lock the vehicle. Never leave children unsupervised in the vehicle.

- ! Always secure the vehicle correctly against rolling away. Otherwise, the vehicle or its drivetrain could be damaged.

To ensure that the vehicle is secured against rolling away unintentionally:

- the parking brake must be applied.
- the transmission must be in position **P** and the SmartKey must be removed from the ignition lock.
- on uphill or downhill gradients, the front wheels must be turned towards the curb.

### Switching off the engine

#### Important safety notes

##### WARNING

The automatic transmission switches to neutral position **N** when you switch off the engine. The vehicle may roll away. There is a risk of an accident.

After switching off the engine, always switch to parking position **P**. Prevent the parked vehicle from rolling away by applying the parking brake.

#### Vehicles with automatic transmission

- ▶ Apply the parking brake firmly.
- ▶ **All vehicles (except AMG vehicles):** shift the transmission to position **P**.



Selector lever in AMG vehicles with P button

- ▶ **AMG vehicles:** press **P** button ①.

#### Using the SmartKey

- ▶ Turn the SmartKey to position **0** in the ignition lock and remove it. The immobilizer is activated.

- i If you turn off the engine with the SmartKey and then remove it from the ignition lock or open a front door, the automatic transmission shifts to **P** automatically.

#### Using KEYLESS-GO

- ▶ Press the Start/Stop button (▷ page 147). The engine stops and all the indicator lamps in the instrument cluster go out.

- i When the driver's door is closed, this corresponds to key position **1**. When the driver's door is open, this corresponds to key position **0**: "key removed".

- i If you turn off the engine with the Start/Stop button, the automatic transmission shifts to **N**. If you then open one of the front doors, the automatic transmission shifts to **P**.

- i The engine can be turned off while the vehicle is in motion by pressing and holding the Start/Stop button for about three seconds. This function operates independently of the ECO start/stop automatic engine switch-off function.

### Parking brake

#### WARNING

If you must brake the vehicle with the parking brake, the braking distance is considerably longer and the wheels could lock. There is an increased danger of skidding and accidents. Only use the parking brake to brake the vehicle when the service brake is faulty. Do not apply the parking brake too firmly. If the wheels lock, release the parking brake until the wheels begin turning again.

#### WARNING

If you leave children unsupervised in the vehicle, they could set it in motion by, for example:



- releasing the parking brake
- shifting the automatic transmission out of the parking position **P**
- starting the engine.

They could also operate the vehicle's equipment. There is a risk of an accident and injury.

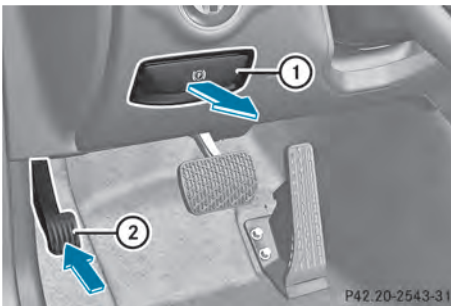
When leaving the vehicle, always take the SmartKey with you and lock the vehicle. Never leave children unsupervised in the vehicle.



If you brake the vehicle with the parking brake, the brake lamps will not light up.

- ▶ **To apply:** depress parking brake ② firmly. When the engine is running, the **BRAKE** (USA only) or  (Canada only) indicator lamp lights up in the instrument cluster.
- ▶ **To release:** depress the brake pedal and keep it depressed.
- ▶ Pull release handle ①. When the ignition is switched on or the engine is running, the **BRAKE** (USA only) or  (Canada only) indicator lamp goes out in the instrument cluster.

### Parking the vehicle for a long period

If you leave the vehicle parked for longer than four weeks, the battery may be damaged by exhaustive discharging.

If you leave the vehicle parked for longer than six weeks, the vehicle may suffer damage as a result of lack of use.

- ▶ Visit a qualified specialist workshop and seek advice.
-  You can obtain information about trickle chargers from a qualified specialist workshop.

### Driving tips

#### General notes

#### Important safety notes

#### WARNING

If you switch off the ignition while driving, safety-relevant functions are only available with limitations, or not at all. This could affect, for example, the power steering and the brake boosting effect. You will require considerably more effort to steer and brake. There is a risk of an accident.

Do not switch off the ignition while driving.

#### WARNING

If you operate mobile communication equipment while driving, you will be

distracted from traffic conditions. You could also lose control of the vehicle. There is a risk of an accident.

Only operate this equipment when the vehicle is stationary.

Observe the legal requirements for the country in which you are driving. Some jurisdictions prohibit the driver from using a mobile phone while driving a vehicle.

If you make a call while driving, always use hands-free mode. Only operate the telephone when the traffic situation permits. If you are unsure, pull over to a safe location and stop before operating the telephone.

Bear in mind that at a speed of only 30 mph (approximately 50 km/h) the vehicle covers a distance of 44 ft (approximately 14 m) per second.

### Drive sensibly – save fuel

Observe the following tips to save fuel:

- ▶ The tires should always be inflated to the recommended tire pressure.
- ▶ Remove unnecessary loads.
- ▶ Remove roof racks when they are not needed.
- ▶ Warm up the engine at low engine speeds.
- ▶ Avoid frequent acceleration or braking.
- ▶ Have all maintenance work carried out as indicated by the service intervals in the Maintenance Booklet or by the service interval display.

Fuel consumption also increases when driving in cold weather, in stop-start traffic and in hilly terrain.

### Drinking and driving

#### WARNING

Drinking and driving and/or taking drugs and driving are very dangerous combinations. Even a small amount of alcohol or drugs can affect your reflexes, perceptions and judgment.

The possibility of a serious or even fatal accident are greatly increased when you drink or take drugs and drive.

Do not drink or take drugs and drive or allow anyone to drive who has been drinking or taking drugs.

### Emission control

#### WARNING

Combustion engines emit poisonous exhaust gases such as carbon monoxide. Inhaling these exhaust gases leads to poisoning. There is a risk of fatal injury. Therefore never leave the engine running in enclosed spaces without sufficient ventilation.

Certain engine systems are designed to keep the level of poisonous components in exhaust fumes within legal limits.

These systems only work at peak efficiency if they are serviced exactly in accordance with the manufacturer's specifications. For this reason, only have work on the engine carried out by qualified and authorized Mercedes-Benz technicians.

The engine settings must not be changed under any circumstances. Furthermore, all specific service work must be carried out at regular intervals and in accordance with the Mercedes-Benz service requirements. Details can be found in the Maintenance Booklet.

### ECO display

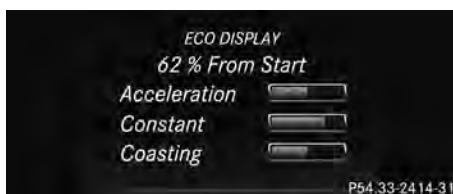

Example: ECO display

The ECO display gives you information on how economical your driving style is. The ECO display assists you in achieving the optimum

driving style in terms of consumption, taking the actual and selected conditions into consideration. Your driving style can significantly influence the vehicle's consumption.

The ECO display consists of three bars:

- **Acceleration**
- **Constant**
- **Coasting**

The percent value is the average value of the three bars. The three bars and the mean value begin at the value of 50%. A higher percentage indicates a more economical driving style.

The ECO display does not indicate the actual fuel consumption and a fixed percentage count in the ECO display does not indicate a fixed consumption figure.

Apart from driving style, consumption is dependent on many factors such as, e.g.:

- load
- check
- cold start
- choice of route
- electrical consumers switched on

These factors are not taken into consideration by the ECO display.

The evaluation of your driving style is carried out using the following three categories:

- **Acceleration** (evaluation of all acceleration processes):
  - The bar fills up: moderate acceleration, especially at higher speeds
  - The bar empties: sporty acceleration
- **Constant** (assessment of driving behavior at all times):
  - The bar fills up: constant speed and avoidance of unnecessary acceleration and deceleration
  - The bar empties: fluctuations in speed
- **Coasting** (assessment of all deceleration processes):
  - The bar fills up: anticipatory driving, keeping your distance and early release of the accelerator. The vehicle can coast without use of the brakes.
  - The bar empties: frequent braking

**i** An economical driving style specially requires driving at moderate engine speeds.

To achieve a higher value in the categories **Acceleration** and **Constant**:

- observe the gearshift recommendations.
- drive in drive program **E**.

**i** On long journeys at a constant speed, e.g. on the highway, only the bar for **Constant** will change.

**i** The ECO display summarizes the driving characteristics from the start of the journey to its completion. For this reason, the bars change dynamically at the beginning of the journey. On longer journeys, there are fewer changes. For more dynamic changes, carry out a manual reset.

Further information on the ECO display (> page 223).

## Braking

### Important safety notes

#### WARNING

If you shift down on a slippery road surface in an attempt to increase the engine's braking effect, the drive wheels could lose their grip. There is an increased danger of skidding and accidents.

Do not shift down for additional engine braking on a slippery road surface.

### Downhill gradients

**I** On long and steep gradients, you must reduce the load on the brakes by shifting early to a lower gear. This allows you to take advantage of the engine braking effect and helps avoid overheating and excessive wear of the brakes.

When you take advantage of the engine braking effect, a drive wheel may not turn for some time, e.g. on a slippery road surface. This could cause damage to the drive train. This type of damage is not covered by the Mercedes-Benz warranty.

Do not depress the brake pedal continuously while the vehicle is in motion, e.g. causing the brakes to rub by constantly applying light pressure to the pedal. This results in excessive and premature wear to the brake pads.

On long and steep downhill gradients, you must select shift range **1**, **2** or **3** in good time. This is especially important if the vehicle is laden.

### Heavy and light loads

#### WARNING

If you rest your foot on the brake pedal while driving, the braking system can overheat. This increases the stopping distance and can even cause the braking system to fail. There is a risk of an accident.

Never use the brake pedal as a footrest. Never depress the brake pedal and the accelerator pedal at the same time.

**I** Depressing the brake pedal constantly results in excessive and premature wear to the brake pads.

If the brakes have been subjected to a heavy load, do not stop the vehicle immediately, but drive on for a short while. This allows the airflow to cool the brakes more quickly.

### Wet roads

If you have driven for a long time in heavy rain without braking, there may be a delayed reaction from the brakes when braking for the first time. This may also occur after the vehicle has been washed or driven through deep water.

You have to depress the brake pedal more firmly. Maintain a greater distance from the vehicle in front.

After driving on a wet road or having the vehicle washed, brake firmly while paying attention to the traffic conditions. This will warm up the brake discs, thereby drying them more quickly and protecting them against corrosion.

### Limited braking performance on salt-treated roads

If you drive on salted roads, a layer of salt residue may form on the brake discs and brake pads. This can result in a significantly longer braking distance.

- Brake occasionally to remove any possible salt residue. Make sure that you do not endanger other road users when doing so.
- Carefully depress the brake pedal and the beginning and end of a journey.
- Maintain a greater distance to the vehicle ahead.

## Servicing the brakes

**!** If the red brake warning lamp lights up in the instrument cluster and you hear a warning tone while the engine is running, the brake fluid level may be too low. Observe additional warning messages in the multifunction display.

The brake fluid level may be too low due to brake pad wear or leaking brake lines.

Have the brake system checked immediately. This work should be carried out at a qualified specialist workshop.

**!** **Vehicles with 4MATIC:** function or performance tests may only be carried out on a 2-axle dynamometer. If you are planning to have the vehicle tested on such a dynamometer, contact an authorized Mercedes-Benz Center to obtain further information first. Otherwise, you could damage the drive train or the brake system.

**!** **Vehicles with 4MATIC:** as the ESP® system operates automatically, the engine and the ignition must be switched off (SmartKey in position **0** or **1** in the ignition lock or Start/Stop button in position **0** or **1**) while the parking brake is being tested on a brake dynamometer.

Braking maneuvers triggered automatically by ESP® may seriously damage the brake system.

**!** **Vehicles with 4MATIC:** as the ESP® system operates automatically, the engine and the ignition system must be switched off (SmartKey in position **0** or **1** in the ignition lock or Start/Stop button in position **0** or **1**) when:

- testing the parking brake on a brake dynamometer.
- you intend to have the vehicle towed with one of the axles raised.

Braking maneuvers triggered automatically by ESP® may seriously damage the brake system.

All checks and maintenance work on the brake system must be carried out at a qualified specialist workshop. Consult a qualified specialist workshop to arrange this.

Have brake pads installed and brake fluid replaced at a qualified specialist workshop. If the brake system has only been subject to moderate loads, you should test the functionality of your brakes at regular intervals. To do so, press firmly on the brake pedal when driving at a high speed. This improves the grip of the brake pads.

You can find a description of Brake Assist (BAS) on (▷ page 67) or of BAS PLUS on (▷ page 67).

The braking characteristics of the vehicle can be seriously impaired if:

- brake pads other than those recommended are installed
  - the recommended brake fluid is not used
- Safe braking can no longer be guaranteed.

## AMG high-performance and ceramic brakes

The high-performance brake system is installed only on the CLS 63 AMG.

The AMG brake systems are designed for heavy loads. This may lead to noise when braking. This will depend on:

- Speed
- Braking force
- Environmental conditions, such as temperature and humidity

The wear of individual components of the brake system, such as the brake pads/linings or brake discs, depends on the individual driving style and operating conditions.

For this reason, it is impossible to state a mileage that will be valid under all circumstances. An aggressive driving style will lead to high wear. You can obtain further information about this from your authorized Mercedes-Benz Center.

New and replaced brake pads and discs only reach their optimum braking effect after several hundred kilometers of driving. Compensate for this by applying greater force to the brake pedal. Keep this in mind, and adapt your driving and braking accordingly during this break-in period.

Excessive heavy braking results in correspondingly high brake wear. Observe the  brake wear warning lamp in the instrument cluster and note any brake status messages in the multifunction display. Especially for high performance driving, it is important to maintain and have the brake system checked regularly.

### Driving on wet roads

#### Hydroplaning

If water has accumulated to a certain depth on the road surface, there is a danger of hydroplaning occurring, even if:

- you drive at low speeds.
- the tires have adequate tread depth.

For this reason, in the event of heavy rain or in conditions in which hydroplaning may occur, you must drive in the following manner:

- lower your speed.
- avoid ruts.
- brake carefully.

#### Driving on flooded roads

**!** Do not drive through flooded areas. Check the depth of any water before driving through it. Drive slowly through standing water. Otherwise, water may enter the vehicle interior or the engine compartment. This can damage the electronic components in the engine or the automatic transmission. Water can also be drawn in by the engine's air suction nozzles and this can cause engine damage.

### Winter driving

#### Important safety notes

##### WARNING

If you shift down on a slippery road surface in an attempt to increase the engine's braking effect, the drive wheels could lose their grip. There is an increased danger of skidding and accidents.

Do not shift down for additional engine braking on a slippery road surface.

##### DANGER

If the exhaust pipe is blocked or adequate ventilation is not possible, poisonous gases such as carbon monoxide (CO) may enter the vehicle. This is the case, e.g. if the vehicle becomes trapped in snow. There is a risk of fatal injury.

If you leave the engine or the auxiliary heating running, make sure the exhaust pipe and area around the vehicle are clear of snow. To ensure an adequate supply of fresh air, open a window on the side of the vehicle that is not facing into the wind.

Have your vehicle winterproofed at a qualified specialist workshop at the onset of winter.

Observe the notes in the "Winter operation" section (▷ page 336).

#### Driving with summer tires

Observe the notes in the "Winter operation" section (▷ page 336).

#### Slippery road surfaces

##### WARNING

If you shift down on a slippery road surface in an attempt to increase the engine's braking effect, the drive wheels could lose their grip. There is an increased danger of skidding and accidents.

Do not shift down for additional engine braking on a slippery road surface.



If the vehicle threatens to skid or cannot be stopped when moving at low speed:

► Shift the transmission to position **N**.

Drive particularly carefully on slippery road surfaces. Avoid sudden acceleration, steering and braking maneuvers. Do not use the cruise control or DISTRONIC PLUS.

**i** For more information on driving with snow chains, see (► page 337).

The outside temperature indicator is not designed to serve as an ice-warning device and is therefore unsuitable for that purpose. Changes in the outside temperature are displayed after a short delay.

Indicated temperatures just above the freezing point do not guarantee that the road surface is free of ice. The road may still be icy, especially in wooded areas or on bridges. The vehicle could skid if you fail to adapt your driving style. Always adapt your driving style and drive at a speed to suit the prevailing weather conditions.

You should pay special attention to road conditions when temperatures are around freezing point.

## Driving systems

### Cruise control

#### Important safety notes

Cruise control maintains a constant road speed for you. It brakes automatically in order to avoid exceeding the set speed. On long and steep downhill gradients, especially if the vehicle is laden, you must select shift range **1**, **2** or **3** in good time. By doing so, you will make use of the braking effect of the engine. This relieves the load on the brake system and prevents the brakes from overheating and wearing too quickly.

Use cruise control only if road and traffic conditions make it appropriate to maintain a steady speed for a prolonged period. You can

store any road speed above 20 mph (30 km/h).

If you fail to adapt your driving style, cruise control can neither reduce the risk of an accident nor override the laws of physics. Cruise control cannot take into account the road, traffic and weather conditions. Cruise control is only an aid. You are responsible for the distance to the vehicle in front, for vehicle speed, for braking in good time and for staying in your lane.

Do not use cruise control:

- in road and traffic conditions which do not allow you to maintain a constant speed e.g. in heavy traffic or on winding roads
- on slippery road surfaces. Braking or accelerating could cause the drive wheels to lose traction and the vehicle could then skid
- when there is poor visibility, e.g. due to fog, heavy rain or snow

If there is a change of drivers, advise the new driver of the speed stored.

#### General notes

Cruise control maintains a constant road speed for you. It brakes automatically in order to avoid exceeding the set speed. On long and steep downhill gradients, especially if the vehicle is laden, you must select shift range **1**, **2** or **3** in good time. By doing so, you will make use of the braking effect of the engine, which relieves the load on the brake system and prevents the brakes from overheating and wearing too quickly.

Use cruise control only if road and traffic conditions make it appropriate to maintain a steady speed for a prolonged period. You can store any road speed above 20 mph (30 km/h).

### Cruise control lever

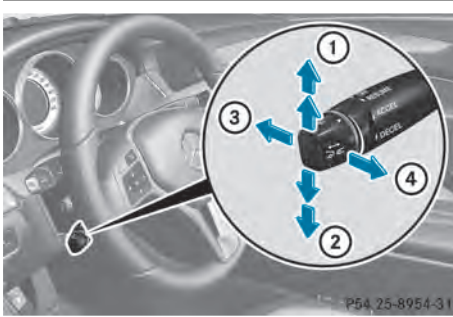

- ① To activate or increase speed
- ② To activate or reduce speed
- ③ To deactivate cruise control
- ④ To activate at the current speed/last stored speed

When you activate cruise control, the stored speed is shown in the multifunction display for five seconds. In the multifunction display, the segments between the stored speed and the maximum speed light up.

### Activation conditions

To activate cruise control, all of the following activation conditions must be fulfilled:

- the parking brake must be released.
- you are driving faster than 20 mph (30 km/h).
- ESP® must be active, but not intervening.
- the transmission must be in position **D**.

### Storing and maintaining the current speed

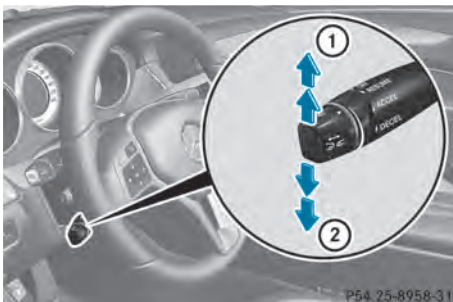

You can accept the current speed if you are driving faster than 20 mph (30 km/h).

- ▶ Accelerate the vehicle to the desired speed.
- ▶ Briefly press the cruise control lever up ① or down ②.
- ▶ Remove your foot from the accelerator pedal. Cruise control is activated. The vehicle automatically maintains the stored speed.

**i** Cruise control may be unable to maintain the stored speed on uphill gradients. The stored speed is resumed when the gradient evens out. Cruise control maintains the stored speed on downhill gradients by automatically applying the brakes.

### Storing the current speed or calling up the last stored speed

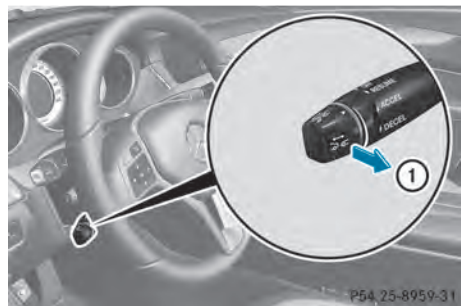

- ▶ Briefly pull the cruise control lever towards you ①.
- ▶ Remove your foot from the accelerator pedal. The first time cruise control is activated, it stores the current speed or regulates the speed of the vehicle to the previously stored speed.

## Setting a speed

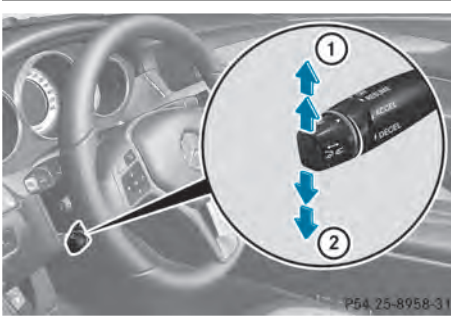

- ▶ Press the cruise control lever up ① for a higher speed or down ② for a lower speed.
- ▶ **To adjust the set speed in 1 mph increments (1 km/h increments):** briefly press the cruise control lever up ① or down ② to the pressure point. Every time the cruise control lever is pressed up ① or down ② the last speed stored is increased or reduced.
- ▶ **To adjust the set speed in 5 mph increments (10 km/h increments):** briefly press the cruise control lever up ① or down ② to the pressure point. Every time the cruise control lever is pressed up ① or down ② the last speed stored is increased or reduced.

**i** Cruise control is not deactivated if you depress the accelerator pedal. For example, if you accelerate briefly to overtake, cruise control adjusts the vehicle's speed to the last speed stored after you have finished overtaking.

## Deactivating cruise control

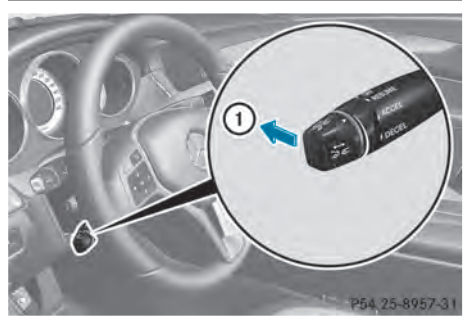

There are several ways to deactivate cruise control:

- ▶ Briefly press the cruise control lever forwards ①.
- or
- ▶ Brake.

Cruise control is automatically deactivated if:

- you depress the parking brake.
- you are driving at less than 20 mph (30 km/h).
- ESP® intervenes or you deactivate ESP®
- you shift the transmission to position **N** while driving.

If cruise control is deactivated, you will hear a warning tone. You will see the **Cruise Control Off** message in the multifunction display for approximately five seconds.

- i** When you switch off the engine, the last speed stored is cleared.

## DISTRONIC PLUS

### Important safety notes

#### WARNING

DISTRONIC PLUS does not react to:

- people or animals
- stationary obstacles on the road, e.g. stopped or parked vehicles
- oncoming and crossing traffic

As a result, DISTRONIC PLUS may neither give warnings nor intervene in such situations. There is a risk of an accident.

Always pay careful attention to the traffic situation and be ready to brake.

#### WARNING

DISTRONIC PLUS cannot always clearly identify other road users and complex traffic situations.

In such cases, DISTRONIC PLUS may:

- give an unnecessary warning and then brake the vehicle
- neither give a warning nor intervene
- accelerate unexpectedly

There is a risk of an accident.

Continue to drive carefully and be ready to brake, in particular when warned to do so by DISTRONIC PLUS.

#### WARNING

DISTRONIC PLUS brakes your vehicle with up to 40% of the maximum braking force. If this braking force is insufficient, DISTRONIC PLUS warns you visually and audibly. There is a risk of an accident.

In such cases, apply the brakes yourself and try to take evasive action.

**!** If DISTRONIC PLUS or the HOLD function is activated, the vehicle brakes automatically in certain situations. To prevent damage to the vehicle, deactivate DISTRONIC PLUS and the HOLD function in the following or other similar situations:

- when towing the vehicle
- in the car wash

If you fail to adapt your driving style, DISTRONIC PLUS can neither reduce the risk of accident nor override the laws of physics. DISTRONIC PLUS cannot take into account the road, traffic and weather conditions. DISTRONIC PLUS is only an aid. You are responsible for the distance to the vehicle in

front, for vehicle speed, for braking in good time and for staying in your lane.

Do not use DISTRONIC PLUS:

- in road and traffic conditions which do not allow you to maintain a constant speed e.g. in heavy traffic or on winding roads
- on slippery road surfaces. Braking or accelerating could cause the drive wheels to lose traction and the vehicle could then skid
- when there is poor visibility, e.g. due to fog, heavy rain or snow

DISTRONIC PLUS may not detect narrow vehicles driving in front, e.g. motorcycles, or vehicles driving on a different line.

In particular, the detection of obstacles can be impaired if:

- dirt on the sensors or anything else covering the sensors
- snow or heavy rain
- interference by other radar sources
- strong radar reflections, for example, in parking garages

If DISTRONIC PLUS no longer detects a vehicle in front, DISTRONIC PLUS may unexpectedly accelerate the vehicle to the stored speed.

This speed may:

- be too high if you are driving in a filter lane or an exit lane
- be so high in the right lane that you pass vehicles driving on the left (left-hand drive countries)
- be so high in the left lane that you pass vehicles driving on the right (right-hand drive countries)

If there is a change of drivers, advise the new driver of the speed stored.

### General notes

DISTRONIC PLUS regulates the speed and automatically helps you maintain the distance to the vehicle detected in front. Vehicles are detected with the aid of the radar

sensor system. DISTRONIC PLUS brakes automatically so that the set speed is not exceeded.

Change into a lower gear in good time on long and steep downhill gradients. This is especially important if the vehicle is laden. By doing so, you will make use of the braking effect of the engine. This relieves the load on the brake system and prevents the brakes from overheating and wearing too quickly.

If DISTRONIC PLUS detects that there is a risk of a collision, you will be warned visually and acoustically. DISTRONIC PLUS cannot prevent a collision without your intervention. An intermittent warning tone will then sound and the distance warning lamp will light up in the instrument cluster. Brake immediately in order to increase the distance to the vehicle in front or take evasive action provided it is safe to do so.

For DISTRONIC PLUS to assist you, the radar sensor system must be operational.

If there is no vehicle in front, DISTRONIC PLUS operates in the same way as cruise control in the speed range between 20 mph (Canada: 30 km/h) and 120 mph (Canada: 200 km/h). If a vehicle is driving in front of you, it operates in the speed range between 0 mph (0 km/h) and 120 mph (Canada: 200 km/h).

Do not use DISTRONIC PLUS while driving on roads with steep gradients.

As DISTRONIC PLUS transmits radar waves, it can resemble the radar detectors of the responsible authorities. You can refer to the relevant chapter in the Operator's Manual if questions are asked about this.

**i** USA only: This device has been approved by the FCC as a "Vehicular Radar System". The radar sensor is intended for use in an automotive radar system only. Removal, tampering, or altering of the device will void any warranties, and is not permitted by the FCC. Do not tamper with, alter, or use in any non-approved way.

Any unauthorized modification to this device could void the user's authority to operate the equipment.

**i** Canada only: This device complies with RSS-210 of Industry Canada. Operation is subject to the following two conditions:

1. This device may not cause harmful interference, and
2. this device must accept any interference received, including interference that may cause undesired operation of the device.

Removal, tampering, or altering of the device will void any warranties, and is not permitted. Do not tamper with, alter, or use in any non-approved way.

Any unauthorized modification to this device could void the user's authority to operate the equipment.

### Cruise control lever

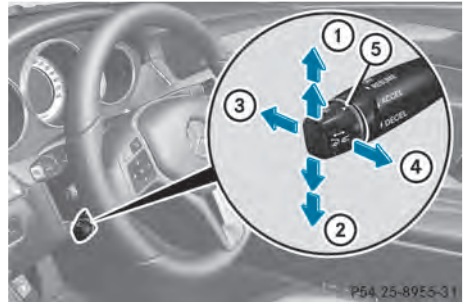

- ① To store the current speed or a higher speed
- ② To store the current speed or a lower speed
- ③ To deactivate DISTRONIC PLUS
- ④ To store the current speed or call up the last stored speed
- ⑤ To set the specified minimum distance

## Activating DISTRONIC PLUS

### Activation conditions

In order to activate DISTRONIC PLUS, the following conditions must be fulfilled:

- the engine must be started. It may take up to two minutes after pulling away before DISTRONIC PLUS is operational.
- the parking brake must be released.
- ESP® must be active, but not intervening.
- Active Parking Assist must not be activated.
- the transmission must be in position **D**.
- the hood must be closed.
- the driver's door must be closed when you shift from **P** to **D** or your seat belt must be fastened.
- the front-passenger door and rear doors must be closed.
- the vehicle must not skid.

### Activating

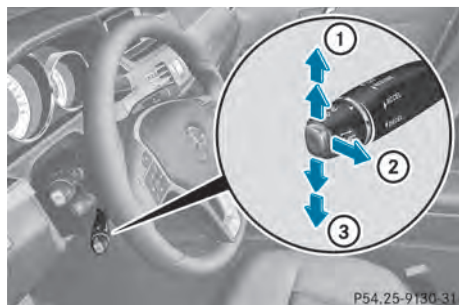

- ▶ Briefly pull the cruise control lever towards you ② or press it up ① or down ③. DISTRONIC PLUS is selected.
- ▶ Press the cruise control lever repeatedly up ① or down ③ until the desired speed is set.
- ▶ Remove your foot from the accelerator pedal. Your vehicle adapts its speed to that of the vehicle in front, but only up to the desired stored speed.

When driving at speeds below 20 mph (30 km/h), you can only activate DISTRONIC PLUS if the vehicle in front has been detected and is shown in the multifunction display. If the vehicle in front is no longer detected and displayed, DISTRONIC PLUS switches off and a tone sounds.

- ❗ If you do not fully release the accelerator pedal, the **DISTRONIC PLUS Override** message appears in the multifunction display. The set distance to a slower-moving vehicle in front will then not be maintained. You will be driving at the speed you determine by the position of the accelerator pedal.

### Activating when driving towards a stationary vehicle

- ▶ Briefly pull the cruise control lever towards you ④ or press it up ① or down ②. DISTRONIC PLUS is selected.
- ▶ Press the cruise control lever repeatedly up ① or down ② until the desired speed is set.

If the vehicle in front of you is stationary, you can only activate DISTRONIC PLUS once your vehicle is stationary as well.

- ❗ DISTRONIC PLUS can only be activated at under 20 mph (30 km/h) if a vehicle in front has been detected. Therefore, the DISTRONIC PLUS distance display in the instrument cluster should be activated (▷ page 227).
- ❗ You can use the cruise control lever to set the stored speed and the control on the cruise control lever to set the specified minimum distance (▷ page 183).

### Activating at the current speed/last stored speed

#### ⚠ WARNING

If you call up the stored speed and it differs from the current speed, the vehicle accelerates or decelerates. If you do not know the stored speed, the vehicle could accelerate

or brake unexpectedly. There is a risk of an accident.

Pay attention to the road and traffic conditions before calling up the stored speed. If you do not know the stored speed, store the desired speed again.

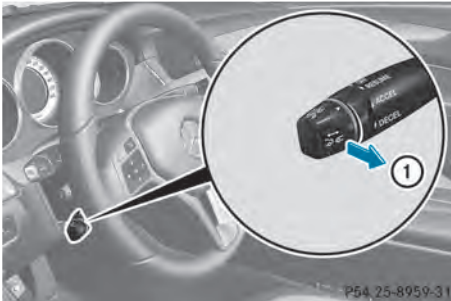

- ▶ Briefly pull the cruise control lever towards you ①.
- ▶ Remove your foot from the accelerator pedal. DISTRONIC PLUS is activated. The first time it is activated, the current speed is stored. Otherwise, it sets the vehicle cruise speed to the previously stored value.

## Driving with DISTRONIC PLUS

### Pulling away and driving

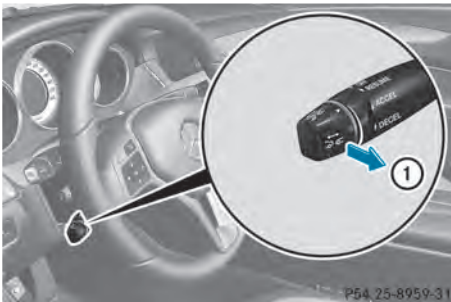

### ▶ If you want to pull away with

**DISTRONIC PLUS:** remove your foot from the brake pedal.

- ▶ Briefly pull the cruise control lever towards you ①

or

- ▶ Accelerate briefly.

Your vehicle pulls away and adapts its speed to that of the vehicle in front.

- ❗ The vehicle can also pull away when it is facing an unidentified obstacle or is driving on a different line from another vehicle. The vehicle then brakes automatically. There is a risk of an accident. Be ready to brake at all times.

If there is no vehicle in front, DISTRONIC PLUS operates in the same way as cruise control.

If DISTRONIC PLUS detects that the vehicle in front has slowed down, it brakes your vehicle. In this way, the distance you have selected is maintained.

If DISTRONIC PLUS detects a faster-moving vehicle in front, it increases the driving speed. However, the vehicle is only accelerated up to the speed you have stored.

### Changing lanes

If you change to the passing lane, DISTRONIC PLUS supports you when:

- you are driving faster than 40 mph (60 km/h)
- DISTRONIC PLUS is maintaining the distance to a vehicle in front
- you switch on the appropriate turn signal
- DISTRONIC PLUS does not detect a danger of collision

If these conditions are fulfilled, your vehicle is accelerated. Acceleration will be interrupted if changing lanes takes too long or if the distance between your vehicle and the vehicle in front becomes too small.

- ❗ When changing lanes, DISTRONIC PLUS monitors the left lane on left-hand drive

vehicles and the right lane on right-hand drive vehicles.

### Vehicles with COMAND

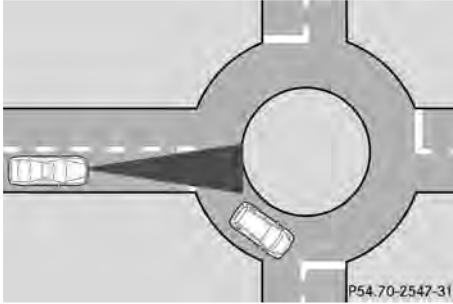

Example: traffic circle

- ❗ The following function is not operational in all countries.

DISTRONIC PLUS uses additional information from your navigation system so that it can react appropriately to certain traffic situations. This is the case if, while following a vehicle, DISTRONIC PLUS is active and you:

- approach or drive through a traffic circle
- approach a T-intersection
- turn off at a highway exit

Even if the vehicle in front leaves the detection range, DISTRONIC PLUS temporarily maintains the current driving speed and does not accelerate. This is based on the current map data in the navigation system.

Afterwards, the vehicle accelerates back to the speed you set.

### Stopping

#### WARNING

Never get out of the vehicle when DISTRONIC PLUS is activated.

DISTRONIC PLUS must also never be operated, activated or deactivated by a passenger or from outside the vehicle.

DISTRONIC PLUS does not replace the parking brake and must not be used for parking.

The DISTRONIC PLUS braking effect is canceled and the vehicle can start moving if:

- DISTRONIC PLUS is deactivated using the cruise control lever.
- you accelerate.
- there is a malfunction in the system or an interruption in the power supply, e.g. battery failure.
- the electrical system in the engine compartment, the battery or the fuses are tampered with.
- the battery is disconnected.

If you wish to leave the vehicle or park it, deactivate DISTRONIC PLUS and secure the vehicle against rolling away.

If DISTRONIC PLUS detects that the vehicle in front is stopping, it brakes your vehicle until it is stationary.

Once your vehicle is stationary, it remains stationary and you do not need to depress the brake.

- ❗ Depending on the specified minimum distance, your vehicle will come to a standstill at a sufficient distance behind the vehicle in front. The specified minimum distance is set using the control on the cruise control lever.

When DISTRONIC PLUS is activated, the transmission is shifted automatically to position **P** if:

- the driver's door is open and the driver's seat belt is unfastened.
- the engine is switched off, unless it is automatically switched off by the ECO start/stop function.
- the hood is opened.
- a system malfunction occurs.
- the power supply is not sufficient.



### Setting a speed

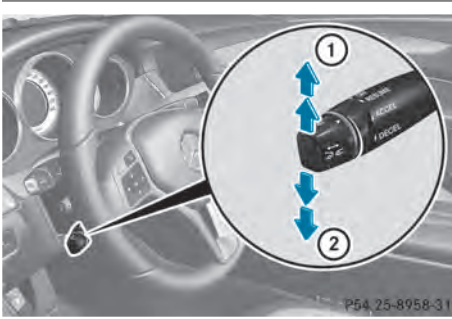

▶ Press the cruise control lever up ① for a higher speed or down ② for a lower speed.

▶ **To adjust the set speed in 1 mph increments (1 km/h increments):** briefly press the cruise control lever up ① or down ② to the pressure point. Every time the cruise control lever is pressed up ① or down ②, the last speed stored is increased or reduced.

▶ **To adjust the set speed in 5 mph increments (10 km/h increments):** briefly press the cruise control lever up ① or down ② to the pressure point. Every time the cruise control lever is pressed up ① or down ②, the last speed stored is increased or reduced.

**i** If you accelerate to overtake, DISTRONIC PLUS adjusts the vehicle's speed to the last speed stored after you have finished overtaking.

### Setting the specified minimum distance

You can set the specified minimum distance for DISTRONIC PLUS by varying the time span between one and two seconds. With this function, you can set the minimum distance that DISTRONIC PLUS keeps to the vehicle in front, dependent on vehicle speed. You can see this distance in the multifunction display (> page 184).

**i** Make sure that you maintain a sufficient distance to the vehicle in front and comply

with the minimum distance as required by law. Adjust the distance to the vehicle in front if necessary.

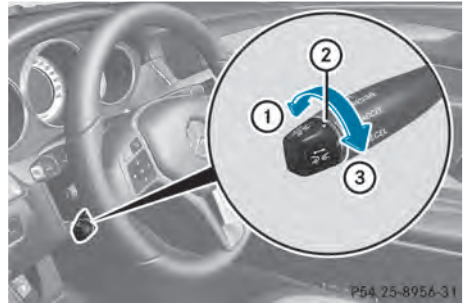

You can set the specified minimum distance for DISTRONIC PLUS by varying the time span between one and two seconds. With this function, you can set the minimum distance that DISTRONIC PLUS keeps to the vehicle in front, dependent on vehicle speed. You can see this distance in the multifunction display (> page 184).

▶ **To increase:** turn control ② in direction ③. DISTRONIC PLUS then maintains a greater distance between your vehicle and the vehicle in front.

▶ **To decrease:** turn control ② in direction ①. DISTRONIC PLUS then maintains a shorter distance between your vehicle and the vehicle in front.

### DISTRONIC PLUS displays in the speedometer



When DISTRONIC PLUS is activated, one or two segments ② in the set speed range light up.

If DISTRONIC PLUS detects a vehicle in front, segments ② between speed of the vehicle in front ① and stored speed ③ light up.

- ① For design reasons, the speed displayed in the speedometer may differ slightly from the speed set for DISTRONIC PLUS.

### DISTRONIC PLUS displays in the multifunction display

#### General notes

In the assistance graphics display menu (▷ page 227) of the on-board computer, you can select the assistance graphics display.

### Display when DISTRONIC PLUS is deactivated



- ① Vehicle in front, if detected
  - ② Distance indicator, current distance to the vehicle in front
  - ③ Specified minimum distance to the vehicle in front; adjustable
  - ④ Own vehicle
- ▶ Select the **Distance Display** function using the on-board computer (▷ page 227).

### Display when DISTRONIC PLUS is activated



- ① Vehicle in front, if detected
- ② Specified minimum distance to the vehicle in front; adjustable
- ③ Own vehicle
- ④ DISTRONIC PLUS active (text only appears when the cruise control lever is actuated)

You will see the stored speed for about five seconds when you activate DISTRONIC PLUS.

- ▶ Select the **Distance Display** function using the on-board computer (▷ page 227).

- ① You will see the stored speed for about five seconds when you activate DISTRONIC PLUS.

### Deactivating DISTRONIC PLUS

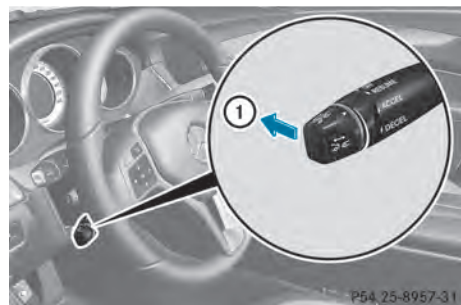

There are several ways to deactivate DISTRONIC PLUS:

- ▶ Briefly press the cruise control lever forwards ①.

or

- ▶ Brake, unless the vehicle is stationary.

When you deactivate DISTRONIC PLUS, you will see the **DISTRONIC PLUS Off** message in the multifunction display for approximately five seconds.

- i** The last speed stored remains stored until you switch off the engine.
- i** DISTRONIC PLUS is not deactivated if you depress the accelerator pedal.

DISTRONIC PLUS is automatically deactivated if:

- you engage the parking brake
- you are driving slower than 15 mph (25 km/h) and there is no vehicle in front, or if the vehicle in front is no longer detected
- ESP® intervenes or you deactivate ESP®
- the transmission is in the **P**, **R** or **N** position
- you pull the cruise control lever towards you in order to pull away and the front-passenger door or one of the rear doors is open
- the vehicle has skidded
- you activate Active Parking Assist

If DISTRONIC PLUS is deactivated, you will hear a warning tone. You will see the **DISTRONIC PLUS Off** message in the multifunction display for approximately five seconds.

### Tips for driving with DISTRONIC PLUS

#### General notes

Pay particular attention in the following traffic situations:

- Cornering, going into and coming out of a bend
- Vehicles traveling on a different line

- Other vehicles changing lanes
- Narrow vehicles
- Obstructions and stationary vehicles
- Crossing vehicles

In such situations, brake if necessary. DISTRONIC PLUS is then deactivated.

#### Cornering, going into and coming out of a bend

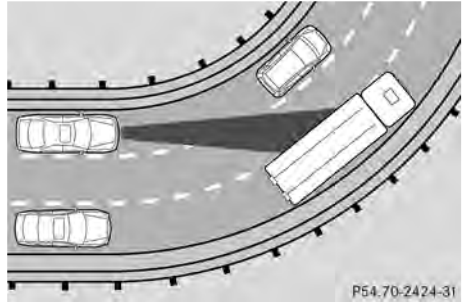

The ability of DISTRONIC PLUS to detect vehicles when cornering is limited. Your vehicle may brake unexpectedly or late.

#### Vehicles traveling on a different line

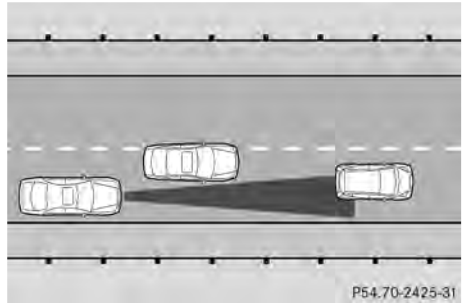

DISTRONIC PLUS may not detect vehicles traveling on a different line. The distance to the vehicle in front will be too short.

### Other vehicles changing lanes

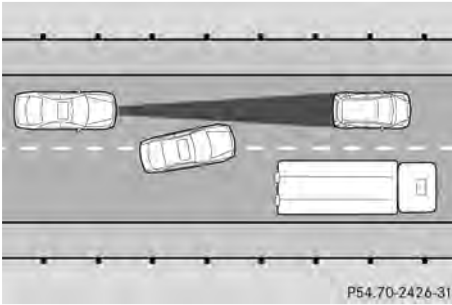

DISTRONIC PLUS has not detected the vehicle cutting in yet. The distance to this vehicle will be too short.

### Narrow vehicles

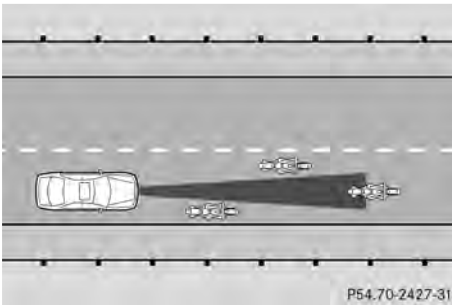

DISTRONIC PLUS has not yet detected the vehicle in front on the edge of the road, because of its narrow width. The distance to the vehicle in front will be too short.

### Obstructions and stationary vehicles

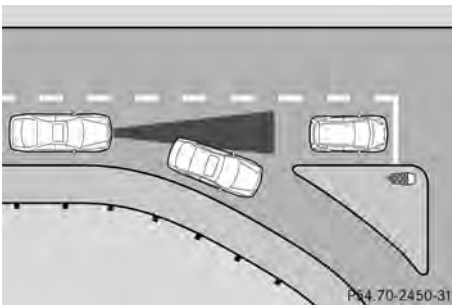

DISTRONIC PLUS does not brake for obstacles or stationary vehicles. If, for

example, the detected vehicle turns a corner and reveals an obstacle or stationary vehicle, DISTRONIC PLUS will not brake for these.

### Crossing vehicles

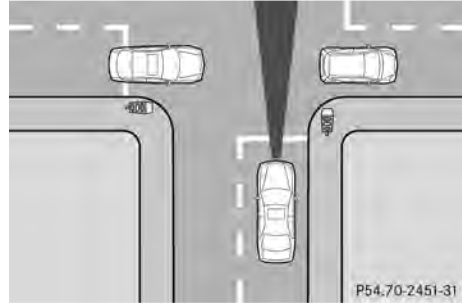

DISTRONIC PLUS may mistakenly detect vehicles that are crossing your lane. Activating DISTRONIC PLUS at traffic lights with crossing traffic, for example, could cause your vehicle to pull away unintentionally.

### HOLD function

#### General notes

The HOLD function can assist the driver in the following situations:

- when pulling away, especially on steep slopes
- when maneuvering on steep slopes
- when waiting in traffic

The vehicle is kept stationary without the driver having to depress the brake pedal.

The braking effect is canceled and the HOLD function deactivated when you depress the accelerator pedal to pull away.

## Important safety notes

### WARNING

When leaving the vehicle, it can still roll away despite being braked by the HOLD function if:

- there is a malfunction in the system or in the voltage supply.
- the HOLD function has been deactivated by pressing the accelerator pedal or the brake pedal, e.g. by a vehicle occupant.
- the electrical system in the engine compartment, the battery or the fuses have been tampered with.
- the battery is disconnected

There is a risk of an accident.

If you wish to exit the vehicle, always turn off the HOLD function and secure the vehicle against rolling away.

**!** If DISTRONIC PLUS or the HOLD function is activated, the vehicle brakes automatically in certain situations. To prevent damage to the vehicle, deactivate DISTRONIC PLUS and the HOLD function in the following or other similar situations:

- when towing the vehicle
- in the car wash

## Activation conditions

You can activate the HOLD function if:

- the vehicle is stationary
- the engine is running or if it has been automatically switched off by the ECO start/stop function
- the driver's door is closed or your seat belt is fastened
- the parking brake is released
- the hood is closed
- the transmission is in position **D**, **R** or **N**
- DISTRONIC PLUS is deactivated

## Activating the HOLD function



- ▶ Make sure that the activation conditions are met.
- ▶ Depress the brake pedal.
- ▶ Quickly depress the brake pedal further until **HOLD** ① appears in the multifunction display.

The HOLD function is activated. You can release the brake pedal.

- i** If depressing the brake pedal the first time does not activate the HOLD function, wait briefly and then try again.

## Deactivating the HOLD function

The HOLD function is deactivated automatically if:

- you accelerate and the transmission is in position **D** or **R**.
- you shift the transmission to position **P**.
- you depress the brake pedal again with a certain amount of pressure until **HOLD** disappears from the multifunction display.
- you activate DISTRONIC PLUS.

When the HOLD function is activated, the transmission is shifted automatically to position **P** if:

- the driver's door is open and the driver's seat belt is unfastened.
- the engine is switched off, unless it is automatically switched off by the ECO start/stop function.
- the hood is opened.
- a system malfunction occurs.
- the power supply is not sufficient.

## RACE START

### Important safety notes

- 1 Observe the safety notes for the SPORT handling mode (▷ page 70).

RACE START is intended solely for activation on dedicated race circuits.

RACE START enables optimal acceleration from a standing start. The precondition for this is a suitable high-grip road surface.

- 1 RACE START is only available in AMG vehicles.

### Conditions for activation

You can activate RACE START if:

- the doors are closed.
- the engine is running and it has reached an operating temperature of approximately 176 °F (80 °C). This is the case when the engine oil temperature in the multifunction display stops flashing.
- SPORT handling mode is activated. (▷ page 70)
- the steering wheel is in the straight-ahead position
- the vehicle is stationary and the brake pedal is depressed (left foot).
- the transmission is in position **D**.

### Activating RACE START

- ▶ Depress the brake pedal with your left foot and keep it depressed.
- ▶ Turn the drive program selector clockwise (▷ page 159) until the **RS** lamp lights up. The **RACE START Confirm: Paddle UP Cancel: Paddle DOWN** message appears in the multifunction display.
- 1 If the activation conditions are no longer fulfilled, RACE START is canceled. The **START Canceled** message appears in the multifunction display.

- ▶ To cancel: pull the left steering wheel paddle shifter (▷ page 160).

or

- ▶ To confirm: pull the right steering wheel paddle shifter (▷ page 160).

The **RACE START Available Depress gas pedal** message appears in the multifunction display.

- 1 If you do not depress the accelerator pedal fully within two seconds, RACE START is canceled. The **RACE START Not Possible See Operator's Manual** message appears in the multifunction display.

- ▶ Fully depress the accelerator pedal. The engine speed rises to approximately 3,500 rpm.

The **RACE START Release brake to start** message appears in the multifunction display.

- 1 If you do not release the brake pedal within five seconds, RACE START is canceled. The **RACE START Canceled** message appears in the multifunction display.

- ▶ Take your foot off the brake, but keep the accelerator pedal depressed. The vehicle pulls away at maximum acceleration.

The **RACE START Active** message appears in the multifunction display.

RACE START is deactivated when the vehicle reaches a speed of approximately 30 mph (Canada: 50 km/h). Drive program **S+** is activated. SPORT handling mode remains activated.

RACE START is deactivated immediately if you release the accelerator pedal during RACE START or if any of the activation conditions are no longer fulfilled. The **RACE START Not Possible See Operator's Manual** message appears in the multifunction display.

- 1 If RACE START is used repeatedly within a short period of time, it is only available

again after the vehicle has been driven a certain distance.

**AIRMATIC**

**Vehicle level**

**Important safety notes**

**⚠ WARNING**

When the vehicle is being lowered, people could become trapped if their limbs are between the vehicle body and the wheels or underneath the vehicle. There is a risk of injury.

Make sure no one is underneath the vehicle or in the immediate vicinity of the wheel arches when the vehicle is being lowered.

**⚠ WARNING**

Vehicles with level control:

The vehicle is slightly lowered if:

- you have selected comfort suspension tuning and
- you lock the vehicle within approximately 60 seconds of switching off the engine

You and people in the vicinity of the wheel arch or the underbody may thus become trapped. There is a risk of injury.

Make sure that nobody is in the vicinity of the wheel arch or the underbody when you lock the vehicle.

**!** The vehicle is lowered by about 15 mm if:

- you have selected "Comfort tuning"
- you switch off the engine and then
- you lock the vehicle within approximately 60 seconds

When parking, position your vehicle so that it does not make contact with the curb as the vehicle is lowered. Your vehicle could otherwise be damaged.

If you lock the vehicle within 60 seconds of switching the engine off, it lowers slightly to the selected Comfort suspension mode.

Your vehicle regulates its height automatically. All-round level control ensures the best possible suspension and constant ground clearance, even with a laden vehicle. When you drive fast, the vehicle is lowered automatically to improve driving safety and to reduce fuel consumption.

The following vehicle levels are possible:

- normal
- raised: the vehicle is raised by about 0.80 in (20 mm) when compared with the normal level
- lowered: the vehicle is raised by about 0.40 in (10 mm) when compared with the normal level

**i** These changes in level are so slight that you are hardly aware of them.

The "Normal" and "Raised" vehicle levels can be set manually.

The "Lowered" vehicle level is set automatically:

- at speeds above 70 mph (113 km/h)
- if you have selected "Sports tuning" (▷ page 190)

**Setting the vehicle level**

Select the "Normal" setting for normal road surfaces and "Raised" for driving with snow chains or on particularly poor road surfaces. Your selection remains stored even if you remove the SmartKey from the ignition lock.

**Setting raised level**



- ▶ Start the engine.

P54\_25-8502-31

If indicator lamp ② is not lit:

- ▶ Press the ① button.  
Indicator lamp ② lights up. The vehicle height is adjusted to raised level.  
The **Vehicle Rising** message appears in the display.

The "Raised level" setting is canceled if you:

- drive at a speed over approximately 75 mph (120 km/h)
- drive for approximately three minutes at a speed over 50 mph (80 km/h)

The "Raised level" remains active when you are not driving within these speed ranges.

### Setting the normal level

- ▶ Start the engine.

If indicator lamp ② is lit:

- ▶ Press the ① button.  
Indicator lamp ② goes out. The vehicle is adjusted to normal level.

## Suspension tuning

### General notes

The electronically controlled damping system works continuously. This improves driving safety and ride comfort.

The damping is tuned individually to each wheel and depends on:

- your driving style, e.g. sporty
- the road surface condition, e.g. bumps
- your individual selection, i.e. sports or comfort

Your selection remains stored even if you remove the SmartKey from the ignition lock.

### Sports tuning

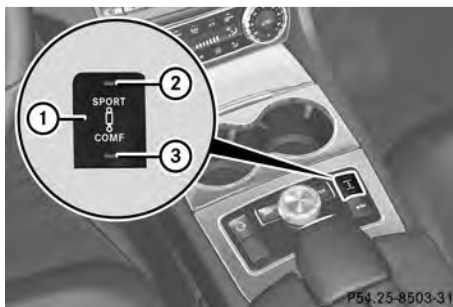

The firmer suspension tuning in Sport mode ensures even better contact with the road. Select this mode when employing a sporty driving style, e.g. on winding country roads.

- ▶ Press button ①.  
Indicator lamp ② lights up. Sports suspension tuning is selected.  
The **AIRMATIC SPORT** message appears in the multifunction display.

### Comfort tuning

In comfort mode, the driving characteristics of your vehicle are more comfortable. Therefore, select this mode if you favor a more comfortable driving style. Select comfort mode also when driving fast on straight roads, e.g. on straight stretches of freeway.

- ▶ Press button ①.  
Indicator lamp ③ lights up. Comfort tuning is selected.  
The **AIRMATIC COMFORT** message appears in the multifunction display.

## AMG adaptive sport suspension system

### Important safety notes

#### WARNING

When the vehicle is being lowered, people could become trapped if their limbs are between the vehicle body and the wheels or



underneath the vehicle. There is a risk of injury.

Make sure no one is underneath the vehicle or in the immediate vicinity of the wheel arches when the vehicle is being lowered.

**⚠ WARNING**

Vehicles with level control:

The vehicle is slightly lowered if:

- you have selected comfort suspension tuning and
- you lock the vehicle within approximately 60 seconds of switching off the engine

You and people in the vicinity of the wheel arch or the underbody may thus become trapped. There is a risk of injury.

Make sure that nobody is in the vicinity of the wheel arch or the underbody when you lock the vehicle.

- !** The vehicle is lowered by about 0.8 in (20 mm) if:
- you have selected "Comfortable tuning"
  - you switch off the engine and then
  - you lock the vehicle within approximately 60 seconds

When parking, position your vehicle so that it does not make contact with the curb as the vehicle is lowered. Your vehicle could otherwise be damaged.

**Suspension tuning**

**General notes**

The electronically controlled damping system works continuously. This improves driving safety and ride comfort.

The damping is tuned individually to each wheel and depends on:

- your driving style, e.g. sporty
- the road surface condition, e.g. bumps
- your individual selection of Sport, Sport + or Comfort

**Sport mode**

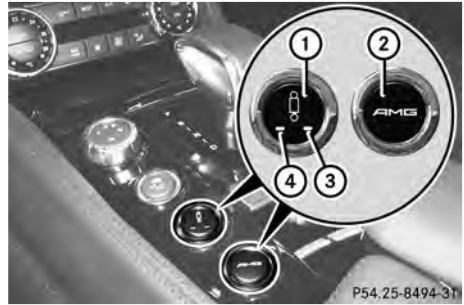

- ① Mode selection button
- ② Button to store, recall and display the selected mode
- ③ Sport + mode indicator lamp
- ④ Sport mode indicator lamp

The firmer suspension tuning in Sport mode ensures better contact with the road. Select this mode when employing a sporty driving style, e.g. on winding country roads.

- ▶ Press button ① once. Indicator lamp ④ lights up. You have selected Sport mode. The **AMG Ride Control SPORT** message appears in the multifunction display.

**Sport + mode**

The very firm setting of the suspension tuning in Sport + mode ensures the best possible contact with the road. Select this mode primarily when driving on race circuits.

If indicator lamps ③ and ④ are off:

- ▶ Press button ① twice. Indicator lamps ③ and ④ light up. You have selected Sport + mode. The **AMG Ride Control SPORT +** message appears in the multifunction display.

If indicator lamp ④ lights up:

- ▶ Press button ① once. Second indicator lamp ③ lights up. You have selected Sport + mode.

The **AMG Ride Control SPORT +** message appears in the multifunction display.

### Comfort mode

When comfort mode is selected, the driving characteristics of your vehicle are more comfortable. Select this mode if you prefer a comfort-oriented driving style. Select comfort mode also when driving fast on straight roads, e.g. on straight stretches of highway.

- ▶ Press button ① repeatedly until indicator lamps ③ and ④ go out.

You have selected Comfort mode.

The **AMG Ride Control COMFORT** message appears in the multifunction display.

### Storing and calling up settings

Once the suspension tuning and drive program have been selected, you can store and call up your settings using AMG button ②.

- ▶ **To store:** press AMG button ② until you hear a tone.
- ▶ **To call up:** press AMG button ②.  
The stored suspension tuning and drive program are selected.
- ▶ **To display:** briefly press AMG button ②.  
Your selection appears in the multifunction display.

### Vehicle level

#### Important safety notes

#### WARNING

When the vehicle is being lowered, people could become trapped if their limbs are between the vehicle body and the wheels or underneath the vehicle. There is a risk of injury.

Make sure no one is underneath the vehicle or in the immediate vicinity of the wheel arches when the vehicle is being lowered.

The vehicle lowers when you press the button for selecting the suspension tuning or the AMG button. The vehicle also lowers if it is stationary.

- ❗ If Sport or Sport + suspension tuning has been selected, the vehicle's ground clearance decreases. Make sure that no objects become trapped or that the vehicle does not become damaged, for example, on the curb.

- i The vehicle level may change visibly at the rear axle if you park the vehicle and the outside temperature changes. If the temperature drops, the vehicle level lowers; with an increase in temperature, the vehicle level rises.

### Changing the rear axle ride height

This function is only available for the CLS 63 AMG 4MATIC.

The vehicle level at the rear axle depends on the selected suspension tuning and the vehicle speed.

The vehicle level at the rear axle changes during the journey depending on the selected suspension tuning:

- Comfort: +0.4 in (+10 mm)
- Sport + and Sport: -0.6 in (-15 mm)

When switching from Comfort to Sport or Sport +, the rear axle lowers by approximately 1.0 in (25 mm). When switching from Sport or Sport + to Comfort, the rear axle raises by approximately 1.0 in (25 mm). This level change also takes place when the vehicle is stationary.

If you drive faster than 105 mph (170 km/h), the rear axle ride height is set to a medium level. This increases driving safety and reduces air resistance. If you then drive at speeds below 93 mph (150 km/h), the rear axle ride height is readjusted to the selected suspension tuning.

### Load compensation

The vehicle can compensate differences in the vehicle level by raising or lowering the rear axle. This is the case, for example, if people get out or if luggage is being loaded. Load compensation takes place if:

- a door or the trunk lid/tailgate is opened
- the parked vehicle is unlocked

For larger level changes, the engine must be running.

### 4MATIC (permanent four-wheel drive)

If you fail to adapt your driving style, 4MATIC can neither reduce the risk of accident nor override the laws of physics. 4MATIC cannot take account of road, weather and traffic conditions. 4MATIC is only an aid. You are responsible for the distance to the vehicle in front, for vehicle speed, for braking in good time and for staying in your lane.

If a drive wheel spins due to insufficient grip:

- Only depress the accelerator pedal as far as necessary when pulling away.
- Accelerate less when driving.

**!** Never tow the vehicle with one axle raised. This may damage the transfer case. Damage of this sort is not covered by the Mercedes-Benz Limited Warranty. All wheels must remain either on the ground or be fully raised. Observe the instructions for towing the vehicle with all wheels in full contact with the ground.

**i** In wintry driving conditions, the maximum effect of 4MATIC can only be achieved if you use winter tires (M+S tires), with snow chains if necessary.

4MATIC ensures that all four wheels are permanently driven. Together with ESP<sup>®</sup>, it improves the traction of your vehicle whenever a drive wheel spins due to insufficient grip.

### PARKTRONIC

#### Important safety notes

PARKTRONIC is an electronic parking aid with ultrasonic sensors. It indicates visually and audibly the distance between your vehicle and an object.

PARKTRONIC is only an aid. It is not a replacement for your attention to your immediate surroundings. You are always responsible for safe maneuvering, parking and exiting a parking space. When maneuvering, parking or pulling out of a parking space, make sure that there are no persons, animals or objects in the area in which you are maneuvering.

**!** When parking, pay particular attention to objects above or below the sensors, such as flower pots or trailer drawbars. PARKTRONIC does not detect such objects when they are in the immediate vicinity of the vehicle. You could damage the vehicle or the objects.

The sensors may not detect snow and other objects that absorb ultrasonic waves.

Ultrasonic sources such as an automatic car wash, the compressed-air brakes on a truck or a pneumatic drill could cause PARKTRONIC to malfunction.

PARKTRONIC may not function correctly on uneven terrain.

PARKTRONIC is activated automatically when you:

- switch on the ignition
- shift the transmission to position **D**, **R** or **N**
- release the parking brake

PARKTRONIC is deactivated at speeds above 11 mph (18 km/h). It is reactivated at lower speeds.

PARKTRONIC monitors the area around your vehicle using six sensors in the front bumper and four sensors in the rear bumper.

## Range of the sensors

### General notes

PARKTRONIC does not take objects into consideration that are:

- below the detection range, e.g. people, animals or objects
- above the detection range, e.g. overhanging loads, truck overhangs or loading ramps.

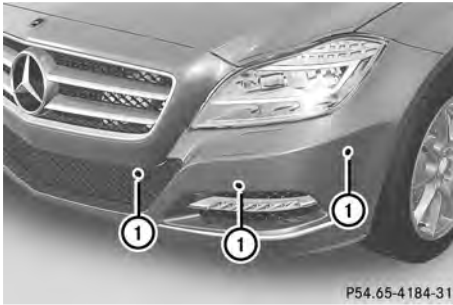

P54.65-4184-31

- ① Sensors in the front bumper, left-hand side (example)

The sensors must be free from dirt, ice or slush. They can otherwise not function correctly. Clean the sensors regularly, taking care not to scratch or damage them (> page 315).

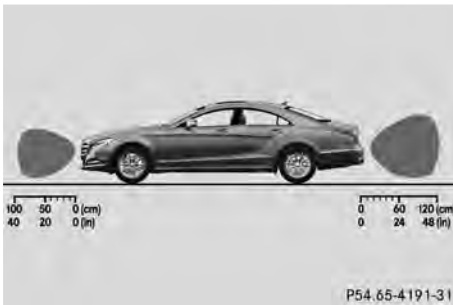

P54.65-4191-31

Example: side view

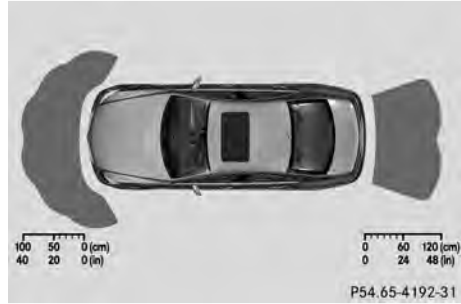

P54.65-4192-31

Example: top view

### Front sensors

Center	Approx. 40 in (approx. 100 cm)
Corners	Approx. 24 in (approx. 60 cm)

### Rear sensors

Center	Approx. 48 in (approx. 120 cm)
Corners	Approx. 32 in (approx. 80 cm)

### Minimum distance

Center	Approx. 8 in (approx. 20 cm)
Corners	Approx. 6 in (approx. 15 cm)

If there is an obstacle within this range, the relevant warning displays light up and a warning tone sounds. If the distance falls below the minimum, the distance may no longer be shown.

### Warning displays

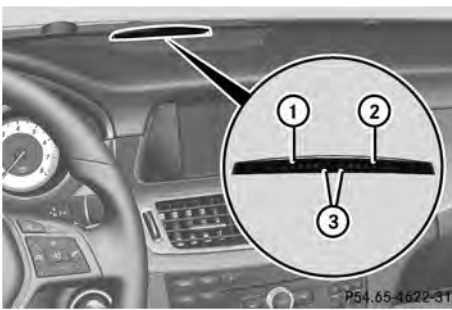

Warning display for the front area

- ① Segments on the left-hand side of the vehicle
- ② Segments on the right-hand side of the vehicle
- ③ Segments showing operational readiness

The warning displays show the distance between the sensors and the obstacle. The warning display for the front area is located on the dashboard above the center air vents. The warning display for the rear area is located on the headliner in the rear compartment.

The warning display for each side of the vehicle is divided into five yellow and two red segments. PARKTRONIC is operational if yellow segments showing operational readiness ③ light up.

The selected transmission position and the direction in which the vehicle is rolling determine which warning display is active when the engine is running.

Transmission position	Warning display
<b>D</b>	Front area activated
<b>R, N</b> or the vehicle is rolling backwards	Rear and front areas activated
<b>P</b>	No areas activated

One or more segments light up as the vehicle approaches an obstacle, depending on the vehicle's distance from the obstacle.

From the:

- sixth segment onwards, you will hear an intermittent warning tone for approximately two seconds.
- seventh segment onwards, you will hear a warning tone for approximately two seconds. This indicates that you have now reached the minimum distance.

### Deactivating/activating PARKTRONIC



- ① Indicator lamp
- ② To deactivate/activate PARKTRONIC

If indicator lamp ① lights up, PARKTRONIC is deactivated. Active Parking Assist is then also deactivated.

- i** PARKTRONIC is automatically activated when you turn the SmartKey to position 2 in the ignition lock.

## Problems with PARKTRONIC

Problem	Possible causes/consequences and ► Solutions
Only the red segments in the PARKTRONIC warning displays are lit. You also hear a warning tone for approximately two seconds. PARKTRONIC is then deactivated and the indicator lamp on the PARKTRONIC button lights up.	<p>PARKTRONIC has malfunctioned and has switched off.</p> <p>► If problems persist, have PARKTRONIC checked at a qualified specialist workshop.</p>
Only the red segments in the PARKTRONIC warning displays are lit. PARKTRONIC is then deactivated.	<p>The PARKTRONIC sensors are dirty or there is interference.</p> <p>► Clean the PARKTRONIC sensors (► page 315).</p> <p>► Switch the ignition back on.</p> <p>The problem may be caused by an external source of radio or ultrasound waves.</p> <p>► See if PARKTRONIC functions in a different location.</p>

## Active Parking Assist

### General notes

Active Parking Assist is an electronic parking aid with ultrasound. It measures the road on both sides of the vehicle. A parking symbol indicates a suitable parking space. Active steering intervention can assist you during parking. You may also use PARKTRONIC (► page 193).

### Important safety notes

Active Parking Assist is merely an aid. It is not a replacement for your attention to your immediate surroundings. You are always responsible for safe maneuvering, parking and exiting a parking space. Make sure that no persons, animals or objects are in the maneuvering range.

When PARKTRONIC is switched off, Active Parking Assist is also unavailable.

### WARNING

The vehicle swings out when parking and in doing so could cross into the opposite lane. This could result in a collision with another road user. There is a risk of an accident. Pay attention to other road users when parking. Stop the vehicle if necessary or cancel the Active Parking Assist parking procedure.

**!** If unavoidable, you should drive over obstacles such as curbs slowly and not at a sharp angle. Otherwise, you may damage the wheels or tires.

Active Parking Assist may possibly indicate parking spaces which are not suitable for parking, for example:

- where parking or stopping is prohibited
- in front of driveways or entrances and exits
- on unsuitable surfaces

**Parking tips:**

- On narrow roads, drive as close to the parking space as possible.
- Parking spaces that are littered or overgrown might be identified or measured incorrectly.
- Parking spaces that are partially occupied by trailer drawbars might not be identified as such or be measured incorrectly.
- Snowfall or heavy rain may lead to a parking space being measured inaccurately.
- Pay attention to the PARKTRONIC (▷ page 195) warning messages during the parking procedure.
- You can intervene in the steering procedure to correct it at any time. Active Parking Assist will then be canceled.
- When transporting a load which protrudes from your vehicle, you should not use Active Parking Assist.
- Never use Active Parking Assist when snow chains are installed.
- Make sure that the tire pressures are always correct. This has a direct influence on the parking characteristics of the vehicle.

**Use Active Parking Assist for parking spaces:**

- that are parallel to the direction of travel
- that are on straight roads, not bends
- that are on the same level as the road, e.g. not on the pavement

**Detecting parking spaces**

Objects located above the height range of Active Parking Assist will not be detected when the parking space is measured. These are not taken into account when the parking procedure is calculated, e.g. overhanging loads, tail sections or loading ramps of goods vehicles.

**! WARNING**

If there are objects above the detection range, Active Parking Assist may turn prematurely.

You may cause a collision as a result. There is a risk of an accident.

If there are objects above the detection range, stop and deactivate Active Parking Assist.

For further information on the detection range (▷ page 194).

Active Parking Assist does not support you with parking spaces parallel to the direction of travel if:

- the parking space is on a curb
- the parking space appears blocked to the system, for example, by foliage or grass paving blocks
- the area that the vehicle needs to maneuver is too small
- the parking space is bordered by an obstacle, such as a tree, a post or a trailer



Example: detected parking space

- ① Detected parking space on the left
- ② Parking symbol
- ③ Detected parking space on the right

Active Parking Assist is switched on automatically when driving forwards. The system is operational at speeds of up to approximately 22 mph (35 km/h). While in operation, the system independently locates and measures parking spaces on both sides of the vehicle.

Active Parking Assist will only detect parking spaces:

- that are parallel to the direction of travel
- that are at least 59 in (1.5 m) wide
- that are at least 51 in (1.3 m) longer than your vehicle

When driving at speeds below 19 mph (30 km/h), you will see parking symbol as a

status indicator in the instrument cluster. When a parking space has been detected, an arrow towards the right or the left also appears. By default, Active Parking Assist only displays parking spaces on the front-passenger side. Parking spaces on the driver's side are displayed as soon as the turn signal on the driver's side is activated. When parking on the driver's side, this must remain switched on until you acknowledge the use of Active Parking Assist by pressing the  button on the multifunction steering wheel.



- i** Take note that Active Parking Assist cannot measure the size of parking spaces that are at right angles to the direction of travel. You must decide for yourself whether the vehicle will fit in the parking space.

A parking space is displayed while you are driving past it, and until you are approximately 50 ft (15 m) away from it.

## Parking

### WARNING

Active Parking Assist merely aids you by intervening actively in the steering. If you do not brake there is a risk of an accident. Always apply the brakes yourself when maneuvering and parking.

- ▶ Stop the vehicle when the parking space symbol shows the desired parking space in the instrument cluster.
  - ▶ Shift the transmission to position **R**. The **Start Park Assist? Yes: OK No: ** message appears in the multifunction display.
  - ▶ **To cancel the procedure:** press the  button on the multifunction steering wheel or pull away.
- or
- ▶ **To park using Active Parking Assist:** press the  button on the multifunction steering wheel. The **Park Assist Active Accelerate and Brake Observe Surroundings** message appears in the multifunction display.
  - ▶ Let go of the multifunction steering wheel.
  - ▶ Back up the vehicle, being ready to brake at all times. When backing up, drive at a speed below approximately 6 mph (10 km/h). Otherwise Active Parking Assist will be canceled.
  - i** In tight parking spaces, you will achieve the best parking results by backing up as far as possible. When doing so, also observe the PARKTRONIC messages.
  - ▶ Stop as soon as PARKTRONIC sounds the continuous warning tone, if not before. Maneuvering may be required in tight parking spaces.
- The **Park Assist Active Select D Observe Surroundings** message appears in the multifunction display.
- ▶ Shift the transmission to position **D** while the vehicle is stationary. Active Parking Assist immediately steers in the other direction. The **Park Assist Active Accelerate and Brake Observe Surroundings** message appears in the multifunction display.
  - i** You will achieve the best results by waiting for the steering procedure to complete before pulling away.
  - ▶ Drive forwards and be ready to brake at all times.
  - ▶ Stop as soon as PARKTRONIC sounds the continuous warning tone, if not before.



The **Park Assist Active Select R Observe Surroundings** message appears in the multifunction display.

Further transmission shifts may be necessary.

As soon as the parking procedure is complete, the **Park Assist Finished** message appears in the multifunction display. PARKTRONIC continues to be available.

- ▶ Maneuver if necessary.
- ▶ Always observe the warning messages displayed by PARKTRONIC (▷ page 195).

Parking tips:

- The way your vehicle is positioned in the parking space after parking is dependent on various factors. These include the position and shape of the vehicles parked in front and behind it and the conditions of the location. It may be the case that Active Parking Assist guides you too far into a parking space, or not far enough into it. In some cases, it may also lead you across or onto the curb. If necessary, you should cancel the parking procedure with Active Parking Assist.
- You can also engage forward gear prematurely. The vehicle redirects and does not drive as far into the parking space. Should a gear be changed too early, the parking procedure will be canceled. A sensible parking position can no longer be achieved from this position.

### Canceling Active Parking Assist

You can cancel Active Parking Assist at any time.

- ▶ Stop the movement of the multifunction steering wheel or steer yourself. Active Parking Assist will be canceled at once. The **Park Assist Canceled**

message appears in the multifunction display.

or

- ▶ Press the PARKTRONIC button on the center console (▷ page 195). PARKTRONIC is switched off and Active Parking Assist is immediately canceled. The **Park Assist Canceled** message appears in the multifunction display.

Active Parking Assist is canceled automatically if:

- the transmission is shifted too early.
- parking using Active Parking Assist is no longer possible.
- you are driving faster than 6 mph (10 km/h).
- a wheel spins, ESP® intervenes or fails. The  warning lamp lights up in the instrument cluster.

A warning tone sounds. The parking symbol disappears and the multifunction display shows the **Park Assist Canceled** message.

If Active Parking Assist is canceled, you must steer again yourself.

### Rear view camera

#### Important safety notes

The rear view camera is only an aid. It is not a replacement for your attention to your immediate surroundings. You are always responsible for safe maneuvering and parking. When maneuvering or parking, make sure that there are no persons, animals or objects in the area in which you are maneuvering.

Under the following circumstances, the rear view camera will not function, or will function in a limited manner:

- if the trunk lid/tailgate is open
- in heavy rain, snow or fog
- at night or in very dark places

- if the camera is exposed to very bright light
- if the area is lit by fluorescent light or LED lighting (the display may flicker)
- if there is a sudden change in temperature, e.g. when driving into a heated garage in winter
- if the camera lens is dirty or obstructed
- if the rear of your vehicle is damaged. In this event, have the camera position and setting checked at a qualified specialist workshop.

### General notes



Example: Coupe

Rear view camera ① is located in the handle strip of the trunk lid.

Rear view camera ① is an optical parking and maneuvering aid. It shows the area behind your vehicle with guide lines in the COMAND display.

The area behind the vehicle is displayed as a mirror image, as in the rear view mirror.

- ① The text of messages shown in the COMAND display depends on the language setting. The following are examples of rear view camera messages in the COMAND display.

### Activating/deactivating the rear view camera

- ▶ **To activate:** make sure that the SmartKey is in position **2** in the ignition lock.
- ▶ Make sure that the "Activation by R gear" setting is active in COMAND, see the separate COMAND operating instructions.
- ▶ Engage reverse gear.  
The area behind the vehicle is shown in the COMAND display with guide lines.

**To deactivate:** the rear view camera is deactivated if you:

- shift the transmission to position **P**
- drive 33 ft (10 m) forwards
- shift the transmission from **R** to another position after 15 seconds
- drive forwards at a speed of over 5 mph (10 km/h)

### Displays in the COMAND display

The rear view camera may show a distorted view of obstacles, show them incorrectly or not at all. The rear view camera does not show objects in the following positions:

- very close to the rear bumper
- under the rear bumper
- in the area immediately above the tailgate handle

❗ Objects not at ground level may appear to be further away than they actually are, e.g.:

- the bumper of a parked vehicle
- the drawbar of a trailer
- the ball coupling of a trailer tow hitch
- the rear section of an HGV
- a slanted post

Use the guidelines only for orientation. Approach objects no further than the bottom-most guideline.

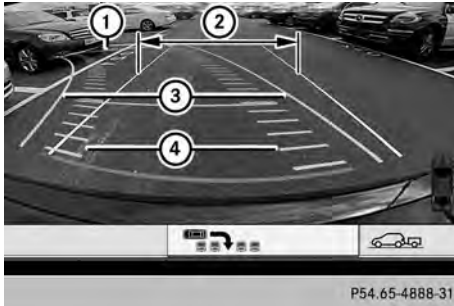

- ① Yellow guide line at a distance of approximately 13 ft (4.0 m) from the rear of the vehicle
- ② White guide line without turning the steering wheel, vehicle width including the exterior mirrors (static)
- ③ **CLS Coupe:** yellow guide line for the vehicle width including the exterior mirrors, for current steering wheel angle (dynamic)
- ④ Yellow lane marking tires at current steering wheel angle (dynamic)



Additional messages for vehicles with PARKTRONIC

- ① Front warning display
- ② Additional PARKTRONIC measurement operational readiness indicator
- ③ Rear warning display

**Vehicles with PARKTRONIC:** if PARKTRONIC is operational (▷ page 193), an additional operational readiness indicator will appear in COMAND display ②. If the PARKTRONIC warning displays are active or light up, warning displays ① and ③ are also active or light up correspondingly in the COMAND display.

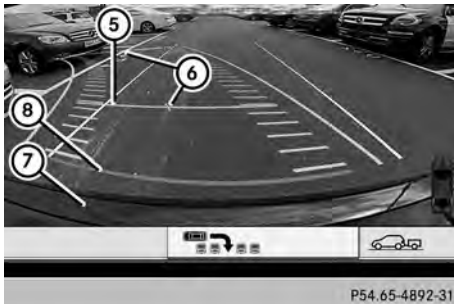

- ⑤ Yellow guide line at a distance of approximately 3 ft (1.0 m) from the rear of the vehicle
- ⑥ Vehicle center axle (marker assistance)
- ⑦ Bumper
- ⑧ Red guide line at a distance of approximately 12 in (0.30 m) from the rear of the vehicle

The guide lines are shown when the transmission is in position **R**.

The distance specifications only apply to objects that are at ground level.

## "Reverse parking" function

Backing up straight into a parking space without turning the steering wheel



- ① White guide line without turning the steering wheel, vehicle width including the exterior mirrors (static)
  - ② **CLS Coupe:** yellow guide line for the vehicle width including the exterior mirrors, for current steering wheel angle (dynamic)
  - ③ Yellow guide line at a distance of approximately 3 ft (1.0 m) from the rear of the vehicle
  - ④ Red guide line at a distance of approximately 12 in (0.30 m) from the rear of the vehicle
- ▶ Make sure that the rear view camera is switched on (▷ page 200). The lane and the guide lines are shown.
  - ▶ With the help of white guide lines ①, check whether the vehicle will fit into the parking space.
  - ▶ Using white guide lines ① as a guide, carefully reverse until you reach the end position. Red guide line ④ is then at the end of the parking space. The vehicle is almost parallel in the parking space.

## Reverse perpendicular parking with the steering wheel at an angle

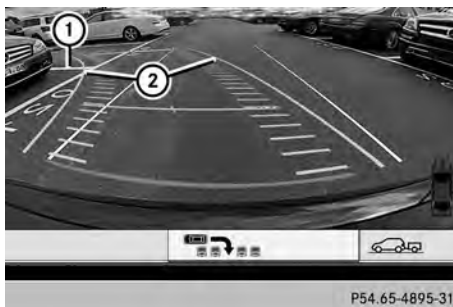

- ① Parking space marking
  - ② **CLS Coupe:** yellow guide line for the vehicle width including the exterior mirrors, for current steering wheel angle (dynamic)
- ▶ Make sure that the rear view camera is switched on (▷ page 200). The lane and the guide lines are shown.
  - ▶ Drive past the parking space and bring the vehicle to a standstill.
  - ▶ While the vehicle is at a standstill, turn the steering wheel in the direction of the parking space until yellow guide line ② reaches parking space marking ①.
  - ▶ Keep the steering wheel in that position and back up carefully.



Backing up with the steering wheel turned

- ① **CLS Coupe:** yellow guide line for the vehicle width including the exterior mirrors, for current steering wheel angle (dynamic)

- ▶ Stop the vehicle when it is almost exactly in front of the parking space.  
The white lane should be as close to parallel with the parking space marking as possible.



Driving to the final position

- ① White guide line at current steering wheel angle
  - ② Parking space marking
- ▶ Turn the steering wheel to the center position while the vehicle is stationary.

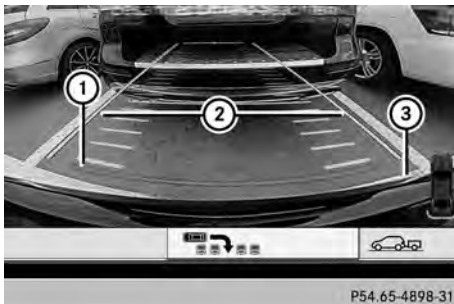

- ① Red guide line at a distance of approximately 12 in (0.30 m) from the rear of the vehicle
  - ② White lane with steering wheel straight
  - ③ End of parking space
- ▶ Back up carefully until you have reached the final position.  
Red guide line ① is then at end of parking space ③. The vehicle is almost parallel in the parking space.

## ATTENTION ASSIST

### Important safety notes

ATTENTION ASSIST is only an aid to the driver. It might not always recognize fatigue or increasing inattentiveness in time or fail to recognize them at all. The system is not a substitute for a well-rested and attentive driver.

### General notes

ATTENTION ASSIST helps you during long, monotonous journeys, such as on highways. It is active in the range between 50 mph (80 km/h) and 112 mph (180 km/h).

If ATTENTION ASSIST detects typical indicators of fatigue or increasing lapses in concentration on the part of the driver, it suggests you take a break.

ATTENTION ASSIST assesses your level of fatigue or lapses in concentration by taking the following criteria into account:

- your personal driving style, e.g. steering characteristics
- journey details, e.g. time of day and length of journey

The functionality of ATTENTION ASSIST is restricted and warnings may be delayed or not occur at all:

- if the road condition is poor, e.g. if the surface is uneven or if there are potholes
- if there is a strong side wind
- if you have adopted a sporty driving style with high cornering speeds or high rates of acceleration
- if you are predominantly driving slower than 50 mph (80 km/h) or faster than 112 mph (180 km/h)
- if you are currently using COMAND or making a telephone call with it
- if the time has been set incorrectly
- in active driving situations, such as when you change lanes or change your speed

### Warning and display messages in the multifunction display

- ▶ Activate ATTENTION ASSIST using the on-board computer (▷ page 228).

If ATTENTION ASSIST is active, you will be warned no sooner than 20 minutes after your journey has begun. You then hear an intermittent warning tone twice and the **Attention Assist: Drowsiness detected** message appears in the multifunction display.

- ▶ If necessary, take a break.
- ▶ Press the  button to confirm the message.

On long journeys, take regular breaks in good time to allow yourself to rest properly. If you do not take a break, you will be warned again after 15 minutes at the earliest. The precondition for this is that ATTENTION ASSIST still detects typical indicators of fatigue or increasing lapses in concentration.

When ATTENTION ASSIST is deactivated, the  symbol and OFF appear in the multifunction display in the assistance graphics display when the engine is running. ATTENTION ASSIST is reset when you continue your journey and starts assessing your tiredness again if:

- you switch off the engine.
- you take off your seat belt and open the driver's door, e.g. for a change of drivers or to take a break.

### Night View Assist Plus

#### Important safety notes

Night View Assist Plus is only an aid and is not a substitute for attentive driving. Do not rely on the Night View Assist Plus display. You are responsible for the distance to the vehicle in front, for vehicle speed and for braking in good time. Drive carefully and always adapt

your driving style to suit the prevailing road and traffic conditions.

The system may be impaired or may not function if:

- there is poor visibility, e.g. due to snow, rain, fog or spray
- the windshield is dirty, fogged up or covered, for instance by a sticker, in the vicinity of the camera
- on bends, on uphill gradients or downhill gradients

Pedestrian recognition may be impaired or inoperative if:

- pedestrians are partially or entirely obscured by objects, e.g. parked vehicles
- the silhouette of the pedestrian in the Night View Assist Plus display is incomplete or interrupted, e.g. by powerful light reflections
- pedestrians do not contrast adequately from the background
- pedestrians are not in an upright position, e.g. sitting, squatting or lying

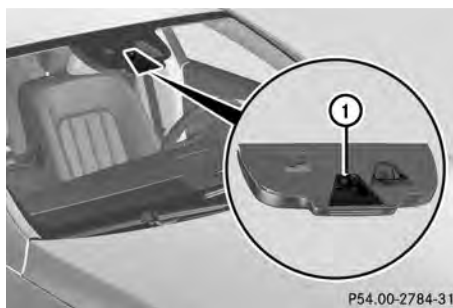

P54.00-2784-31

In addition to the illumination provided by the normal headlamps, Night View Assist Plus uses infrared light to illuminate the road. Night View Assist Plus camera ① picks up the infrared light and displays a monochrome image in COMAND. The image displayed in COMAND corresponds to a road lit up by high-beam headlamps. This enables you to see the road's course and any obstacles in good time. If pedestrian recognition is activated, pedestrians recognized by the system are

highlighted in the Night View Assist Plus display.

Light from the headlamps of oncoming vehicles does not affect the Night View Assist Plus display in the multifunction display. This is also the case if you cannot switch on the high-beam headlamps due to oncoming traffic.

- 1 Infrared light is not visible to the human eye and therefore does not glare. Night View Assist Plus can therefore remain switched on even if there is oncoming traffic.

### Activating Night View Assist Plus

#### Activation conditions

You can only activate Night View Assist Plus if:

- the SmartKey is in position **2** in the ignition lock.
- it is dark.
- the light switch is in the **AUTO** or  position.
- reverse gear has not been engaged.

#### Activating Night View Assist Plus



- ▶ Make sure that COMAND is switched on.
- ▶ Press button ①.  
The Night View Assist Plus display appears in the COMAND display.

You can read about how to adjust the brightness of the COMAND display in the COMAND operating instructions.

- 1 The infrared headlamps only switch on when the vehicle is being driven at speeds of approximately 6 mph (10 km/h). This means that you do not have the full visual range while the vehicle is stationary and cannot check whether Night View Assist Plus is working.

### Pedestrian recognition



- ① Night View Assist Plus display
- ② Pedestrian recognized
- ③ Framing
- ④ Symbol for active pedestrian recognition

- 1 Animals are not recognized by pedestrian recognition.

Night View Assist Plus is able to recognize pedestrians by typical characteristics, e.g. a silhouette in the shape of a person.

Pedestrian recognition is then switched on automatically:

- if Night View Assist Plus is activated
- if you are driving faster than approximately 6 mph (10 km/h)
- the surroundings are dark, e.g. when driving outside built-up areas without street lighting

If pedestrian recognition is active, symbol ④ appears. If pedestrians are detected, they are highlighted with framing ③. If the pedestrian recognition system has brought a pedestrian to your attention, look through the windshield to evaluate the situation. The actual distance to objects and

pedestrians cannot be gaged accurately by looking at a screen.

It may be the case that objects are highlighted as well as pedestrians.

### Fogged up or dirty windshield

#### **WARNING**

Always remember that you must concentrate primarily on driving the vehicle. A driver's attention to the road must always be his/her primary focus when driving. For your safety and the safety of others: stop the vehicle before attempting to clean fogged up windows or the windshield area in front of the Night View Assist Plus camera.

Please remember that when your vehicle is traveling at a speed of only 30 mph (approximately 50 km/h) it covers a distance of 44 ft (approximately 14 m) per second.

If the windshield in front of the camera is fogged up or dirty on the inside or outside, the Night View Assist Plus display is affected.

- ▶ **To defrost:** check the automatic air conditioning settings (▷ page 140) and fold down the camera cover (▷ page 316).
- ▶ **To defrost the inside of the windshield:** fold down the camera cover (▷ page 316) and clean the windshield (▷ page 314).



## Problems with Night View Assist Plus

Problem	Possible causes/consequences and ► Solutions
The picture quality of Night View Assist Plus has deteriorated.	The windshield wipers are smearing the windshield. ► Replace the wiper blades (▷ page 126).
	The windshield is smeared after the vehicle has been cleaned in a car wash. ► Clean the windshield (▷ page 314).
	There is windshield chip damage in the camera's field of vision. ► Replace the windshield.
	The windshield is fogged up on the inside. ► Defrost the windshield (▷ page 140).
	The windshield is iced up. ► De-ice the windshield (▷ page 139).
	There is dirt on the inside of the windshield. ► Clean the inside of the windshield (▷ page 314).

### Lane Tracking package

#### General notes

The Lane Tracking package consists of Blind Spot Assist (▷ page 207) and Lane Keeping Assist (▷ page 209).

#### Blind Spot Assist

##### General notes

Blind Spot Assist uses a radar sensor system to monitor the areas on both sides of your vehicle. It supports you from a speed of approximately 20 mph (30 km/h). A warning display in the exterior mirrors draws your attention to vehicles detected in the monitored area. If you then switch on the corresponding turn signal to change lanes, you will also receive a visual and audible collision warning. Blind Spot Assist uses sensors in the rear bumper for monitoring purposes.

For Blind Spot Assist to assist you, the radar sensor system must be operational.

#### Important safety notes

##### WARNING

Blind Spot Assist does not react to:

- vehicles overtaken too closely on the side, placing them in the blind spot area
- vehicles which approach with a large speed differential and overtake your vehicle

As a result, Blind Spot Assist may not give warnings in such situations. There is a risk of an accident.

Always observe the traffic conditions carefully, and maintain a safe lateral distance.

Blind Spot Assist is only an aid. It may fail to detect some vehicles and is no substitute for attentive driving. Always ensure that there is sufficient distance to the side for other road users and obstacles.

 USA only:

This device has been approved by the FCC as a "Vehicular Radar System". The radar sensor is intended for use in an automotive radar system only. Removing, tampering with, or altering the device will void any warranties, and is not permitted by the FCC. Do not tamper with, alter, or use in any non-approved way.

Any unauthorized modification to this device could void the user's authority to operate the equipment.

### Monitoring range of the sensors

In particular, the detection of obstacles can be impaired if:

- dirt on the sensors or anything else covering the sensors
- poor visibility, e.g. due to fog, heavy rain, snow or spray
- narrow vehicles, e.g. motorcycles or bicycles
- the road has very wide lanes
- the road has narrow lanes
- you are not driving in the middle of the lane
- there are barriers or similar lane borders

Vehicles in the monitoring range are then not indicated.

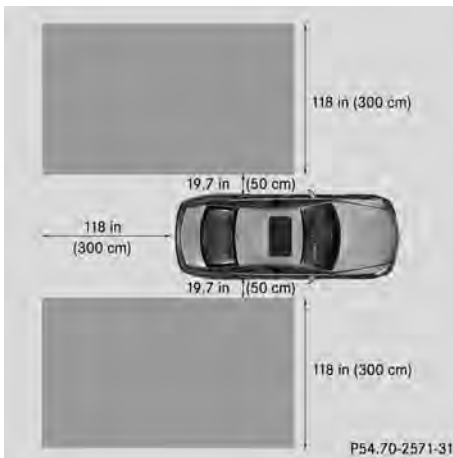

Blind Spot Assist monitors the area up to 10 ft (3 m) behind your vehicle and directly next to your vehicle, as shown in the diagram.

If the lanes are narrow, vehicles driving in the lane beyond the lane next to your vehicle may be indicated, especially if the vehicles are not driving in the middle of their lane. This may be the case if there are vehicles driving at the inner edge of their lanes.

Due to the nature of the system:

- warnings may be issued in error when driving close to crash barriers or similar solid lane borders.
- the warning is canceled when driving for an extended period next to long vehicles, such as trucks.

The two radar sensors for Blind Spot Assist are integrated into the sides of the rear bumper. Make sure that the bumper is free of dirt, ice or slush in the vicinity of the sensors. The sensors must not be covered, for example by cycle racks or overhanging loads. Following a severe impact or in the event of damage to the bumpers, have the function of the sensors checked at a qualified specialist workshop. Blind Spot Assist may otherwise not work properly.

### Indicator and warning display

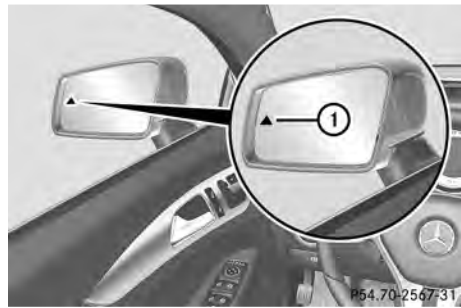

#### ① Yellow indicator lamp/red warning lamp

Active Blind Spot Assist is not active at speeds below approximately 20 mph (30 km/h). Vehicles in the monitoring range are then not indicated.

When Blind Spot Assist is activated, indicator lamp ① in the exterior mirrors lights up yellow at speeds of up to 20 mph (30 km/h). At speeds above 20 mph (30 km/h) the

indicator lamp goes out and Blind Spot Assist is operational.

If a vehicle is detected within the monitoring range of Blind Spot Assist at speeds above 20 mph (30 km/h), warning lamp ① on the corresponding side lights up red. This warning is always emitted when a vehicle enters the blind spot monitoring range from behind or from the side. When you overtake a vehicle, the warning only occurs if the difference in speed is less than 7 mph (12km/h).

The yellow indicator lamp goes out if reverse gear is engaged. In this event, Blind Spot Assist is no longer active.

The brightness of the indicator/warning lamps is adjusted automatically according to the ambient light.

### Collision warning

If a vehicle is detected in the monitoring range of Blind Spot Assist and you switch on the corresponding turn signal, a double warning tone sounds. Red warning lamp ① flashes. If the turn signal remains on, vehicles detected are indicated by the flashing of red warning lamp ①. There are no further warning tones.

### Switching on Blind Spot Assist

- ▶ Make sure that Blind Spot Assist (▷ page 228) is activated in the on-board computer.
- ▶ Turn the SmartKey to position **2** in the ignition lock.  
Warning lamps ① in the exterior mirrors light up red for approximately 1.5 seconds and then turn yellow.

### Lane Keeping Assist

#### Important safety notes

##### WARNING

Lane Keeping Assist may not always clearly recognize lane markings.

In this case, Lane Keeping Assist may:

- give an unnecessary warning
- not give a warning

There is a risk of an accident.

Always pay particular attention to the traffic situation and stay in lane, in particular if warned by Lane Keeping Assist.

##### WARNING

The Lane Keeping Assist warning does not return the vehicle to the original lane. There is a risk of an accident.

You should always steer, brake or accelerate yourself, in particular if warned by Lane Keeping Assist.

If you fail to adapt your driving style, Lane Keeping Assist can neither reduce the risk of an accident nor override the laws of physics. Lane Keeping Assist cannot take into account the road, traffic and weather conditions. Lane Keeping Assist is merely an aid. You are responsible for the distance to the vehicle in front, for vehicle speed, for braking in good time and for staying in your lane.

The Lane Keeping Assist does not keep the vehicle in the lane.

The system may be impaired or may not function if:

- there is poor visibility, e.g. due to insufficient illumination of the road, or due to snow, rain, fog or spray
- there is glare, e.g. from oncoming traffic, the sun or reflections (e.g. when the road surface is wet)
- the windshield is dirty, fogged up, damaged or covered, for instance by a sticker, in the vicinity of the camera
- there are no, several or unclear lane markings for a lane, e.g. in areas with road construction work
- the lane markings are worn away, dark or covered up, e.g. by dirt or snow

- the distance to the vehicle in front is too small and the lane markings thus cannot be detected
- the lane markings change quickly, e.g. lanes branch off, cross one another or merge
- the road is narrow and winding
- there are strong shadows cast on the lane

### General notes

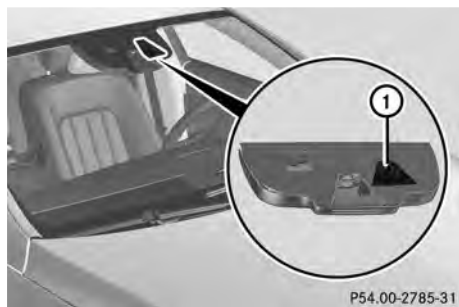

Lane Keeping Assist monitors the area in front of your vehicle with camera ①, which is mounted at the top of the windshield. Lane Keeping Assist detects lane markings on the road and warns you before you leave your lane unintentionally.

If you have chosen the function **Display Unit Speed-/Odometer:** (▷ page 229) and selected the display unit **km** in the on-board computer, Active Lane Keeping Assist supports you from a speed of 60 km/h. If the **miles** display unit is selected, the assistance range begins at 40 mph.

A warning may be given if a front wheel passes over a lane marking. It will warn you by means of intermittent vibration in the steering wheel for up to 1.5 seconds.

### Switching on Lane Keeping Assist

- ▶ Switch on Active Lane Keeping Assist using the on-board computer; to do so, select **Standard** or **Adaptive** (▷ page 229). If you drive at speeds above 40 mph (60 km/h) and lane markings are detected, the lines in the assistance graphics display

(▷ page 227) are shown in green. Lane Keeping Assist is ready for use.

### Standard

If **Standard** is selected, no warning vibration occurs if:

- you switch on the turn signals. In this event, the warnings are suppressed for a certain period of time.
- a driving safety system intervenes, such as ABS, BAS or ESP®.

### Adaptive

If **Adaptive** is selected, no warning vibration occurs if:

- you switch on the turn signals. In this event, the warnings are suppressed for a certain period of time.
- a driving safety system intervenes, e.g. ABS, BAS or ESP®.
- you accelerate hard, e.g. kickdown.
- you brake hard.
- you steer actively, e.g. swerve to avoid an obstacle or change lanes quickly.
- you cut the corner on a sharp bend.

In order that you are warned only when necessary and in good time if you cross the lane marking, the system recognizes certain conditions and warns you accordingly.

The warning vibration occurs earlier if:

- you approach the outer lane marking on a bend.
- the road has very wide lanes, e.g. a highway.
- the system recognizes solid lane markings.

The warning vibration occurs later if:

- the road has narrow lanes.
- you cut the corner on a bend.

## Active Driving Assistance package

### General notes

The Active Driving Assistance package consists of DISTRONIC PLUS (▷ page 177), Active Blind Spot Assist (▷ page 211) and Active Lane Keeping Assist (▷ page 214).

### Active Blind Spot Assist

#### General notes

Active Blind Spot Assist uses a radar sensor system, pointed toward the rear of the vehicle, to monitor the area to the sides of the vehicle which the driver is unable to see. A warning display in the exterior mirrors draws your attention to vehicles detected in the monitored area. If you then switch on the corresponding turn signal to change lane, you will also receive an optical and audible warning. If a risk of lateral collision is detected, corrective braking may help you avoid a collision. Before a course-correcting brake application, Active Blind Spot Assist evaluates the space in the direction of travel and at the sides of the vehicle. For this, Active Blind Spot Assist uses radar sensors which are pointed in the direction of travel.

Active Blind Spot Assist supports you from a speed of approximately 20 mph (30 km/h). For Active Blind Spot Assist to assist you when driving, the radar sensor system must be:

- activated (▷ page 232)
- operational

#### Important safety notes

Active Blind Spot Assist is only an aid and is not a substitute for attentive driving.

#### WARNING

Active Blind Spot Assist does not react to:

- vehicles overtaken too closely on the side, placing them in the blind spot area
- vehicles which approach with a large speed differential and overtake your vehicle

As a result, Active Blind Spot Assist may neither give warnings nor intervene in such situations. There is a risk of an accident.

Always observe the traffic conditions carefully, and maintain a safe lateral distance.

#### USA only:

This device has been approved by the FCC as a "Vehicular Radar System". The radar sensor is intended for use in an automotive radar system only. Removing, tampering with, or altering the device will void any warranties, and is not permitted by the FCC. Do not tamper with, alter, or use in any non-approved way.

Any unauthorized modification to this device could void the user's authority to operate the equipment.

#### Canada only: This device complies with RSS-210 of Industry Canada. Operation is subject to the following two conditions:

1. This device may not cause harmful interference, and
  2. this device must accept any interference received, including interference that may cause undesired operation of the device.
- Removal, tampering, or altering of the device will void any warranties, and is not permitted. Do not tamper with, alter, or use in any non-approved way.

Any unauthorized modification to this device could void the user's authority to operate the equipment.

#### Radar sensors

The Active Blind Spot Assist radar sensors are integrated into the front and rear bumpers and behind a cover in the radiator grill. Make sure that the bumpers and the cover in the radiator grill are free of dirt, ice or slush. The rear sensors must not be covered, for example by cycle racks or overhanging cargo. Following a severe impact or in the event of damage to the bumpers, have the function of the radar sensors checked at a qualified

specialist workshop. Active Blind Spot Assist may otherwise no longer work properly.

### Monitoring area

#### WARNING

Active Blind Spot Assist does not detect all traffic situations and road users. There is a risk of an accident.

Always make sure that there is sufficient distance on the side for other traffic or obstacles.

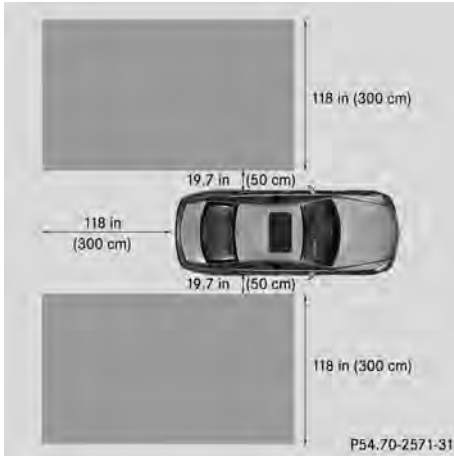

Active Blind Spot Assist monitors the area up to 10 ft (3.0 m) behind your vehicle and directly next to your vehicle, as shown in the diagram.

The detection of obstacles can be impaired in the case of:

- dirt on the sensors or anything else covering the sensors
- poor visibility, e.g. due to rain, snow or spray

Vehicles in the monitoring range are then not indicated or indicated with a delay.

Active Blind Spot Assist may not detect narrow vehicles, such as motorcycles or bicycles, or may only detect them too late.

If the lanes are narrow, vehicles driving in the lane beyond the lane next to your vehicle may be indicated, especially if the vehicles are not

driving in the middle of their lane. This may be the case if there are vehicles at the edge of their lane.

Due to the nature of the system:

- warnings may be issued in error when driving close to crash barriers or similar solid lane borders.
- the warning is canceled when driving for an extended period next to long vehicles, such as trucks.

### Indicator and warning display

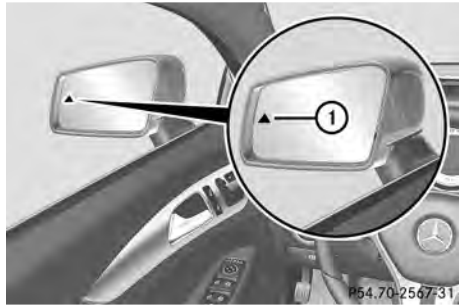

#### ① Yellow indicator lamp/red warning lamp

Active Blind Spot Assist is not active at speeds below approximately 20 mph (30 km/h). Vehicles in the monitoring range are then not indicated.

When active Blind Spot Assist is activated, indicator lamp ① in the exterior mirrors lights up yellow at speeds of up to 20 mph (30 km/h). At speeds above 20 mph (30 km/h), the indicator lamp goes out and active Blind Spot Assist is operational.

If a vehicle is detected within the monitoring range of Blind Spot Assist at speeds above 20 mph (30 km/h), warning lamp ① on the corresponding side lights up red. This warning is always given when a vehicle enters the blind spot monitoring range from behind or from the side. When you overtake a vehicle, the warning only occurs if the difference in speed is less than 7 mph (12 km/h).

The yellow indicator lamp goes out if reverse gear is engaged. In this event, Active Blind Spot Assist is no longer active.

The brightness of the indicator/warning lamps is adjusted automatically according to the ambient light.

### Visual and acoustic collision warning

If you switch on the turn signals to change lanes and a vehicle is detected in the side monitoring range, you receive a visual and acoustic collision warning. You then hear a double warning tone and red warning lamp ① flashes. If the turn signal remains on, detected vehicles are indicated by the flashing of red warning lamp ①. There are no further warning tones.

### Course-correcting brake application

#### WARNING

A course-correcting brake application cannot always prevent a collision. There is a risk of an accident.

Always steer, brake or accelerate yourself, especially if Active Blind Spot Assist warns you or makes a course-correcting brake application. Always maintain a safe distance at the sides.

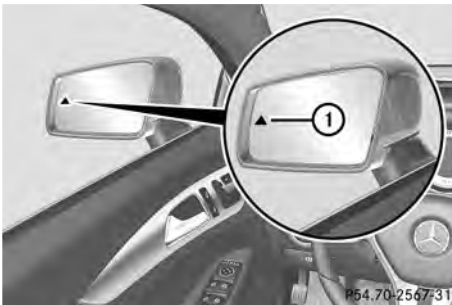

If Active Blind Spot Assist detects a risk of a lateral collision in the monitoring range, a

course-correcting brake application is carried out. This is meant to assist you in avoiding a collision.

If a course-correcting brake application occurs, red warning lamp ① flashes in the exterior mirror and a dual warning tone sounds. In addition, the display shown in the lower image appears in the multifunction display.

In very rare cases, the system may make an inappropriate brake application. An inappropriate course-correcting brake application may be interrupted at any time if you steer slightly in the opposite direction or accelerate, for example.

The course-correcting brake application is available in the speed range between 20 mph (30 km/h) and 120 mph (200 km/h). Either no braking application, or a course-correcting brake application adapted to the driving situation occurs if:

- there are vehicles or obstacles, e.g. crash barriers, located on both sides of your vehicle.
- a vehicle approaches you too closely at the side.
- you have adopted a sporty driving style with high cornering speeds.
- you clearly brake or accelerate.
- a driving safety system intervenes, e.g. ESP® or PRE-SAFE® Brake.
- ESP® is switched off.
- a loss of tire pressure or a defective tire is detected.

### Switching on Active Blind Spot Assist

- ▶ Make sure that the radar sensor system (▷ page 232) and Active Blind Spot Assist (▷ page 228) are activated in the on-board computer.
- ▶ Turn the SmartKey to position **2** in the ignition lock.  
Warning lamps ① in the exterior mirrors light up red for approximately 1.5 seconds and then turn yellow.

## Active Lane Keeping Assist

### General notes

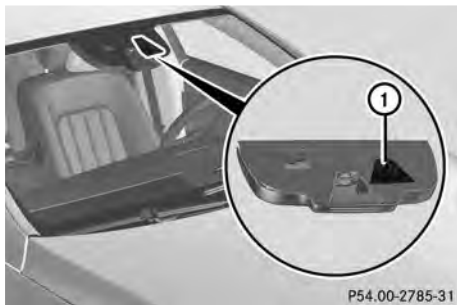

Active Lane Keeping Assist monitors the area in front of your vehicle by means of camera ① at the top of the windshield. Active Lane Keeping Assist detects lane markings on the road and warns you before you leave your lane unintentionally. If you do not react to the warning, a lane-correcting application of the brakes can bring the vehicle back into the original lane.

If you have chosen the function **Display Unit Speed-/Odometer:** (> page 229) and selected the display unit **km** in the on-board computer, Active Lane Keeping Assist supports you from a speed of 60 km/h. If **mi**les is selected as the display unit, the assistance range begins at 40 mph.

For Active Lane Keeping Assist to assist you when driving, the radar sensor system must be operational.

### Important safety notes

If you fail to adapt your driving style, Active Lane Keeping Assist can neither reduce the risk of accident nor override the laws of physics. Active Lane Keeping Assist cannot take into account road, weather or traffic conditions. It cannot detect possible road and traffic conditions. Active Lane Keeping Assist is only an aid. You are responsible for the distance to the vehicle in front, for vehicle speed, for braking in good time and for staying in your lane.

Active Lane Keeping Assist cannot continuously keep your vehicle in its lane.

### **WARNING**

Active Lane Keeping Assist cannot always clearly detect lane markings.

In such cases, Active Lane Keeping Assist can:

- give an unnecessary warning and then make a course-correcting brake application to the vehicle
- not give a warning or intervene

There is a risk of an accident.

Always pay particular attention to the traffic situation and keep within the lane, especially if Active Lane Keeping Assist alerts you.

Terminate the intervention in a non-critical driving situation.

The system may be impaired or may not function if:

- there is poor visibility, e.g. due to insufficient illumination of the road, or due to snow, rain, fog or spray
- there is glare, e.g. from oncoming traffic, the sun or reflections (e.g. when the road surface is wet)
- the windshield is dirty, fogged up, damaged or covered, for instance by a sticker, in the vicinity of the camera
- the radar sensors in the front or rear bumper or in the radiator grill are dirty, e.g. due to snow
- there are no, several or unclear lane markings for a lane, e.g. in areas with road construction work
- the lane markings are worn away, dark or covered up, e.g. by dirt or snow
- the distance to the vehicle in front is too small and the lane markings thus cannot be detected
- the lane markings change quickly, e.g. lanes branch off, cross one another or merge



- the road is narrow and winding
  - there are strong shadows cast on the lane
- If no vehicle is detected in the adjacent lane and there are broken lane markings detected, no lane-correcting brake application is made.

### Warning vibration in the steering wheel

A warning may be given if a front wheel passes over a lane marking. It will warn you by means of intermittent vibration in the steering wheel for up to 1.5 seconds.

### Lane-correcting brake application

#### WARNING

A lane-correcting brake application cannot always bring the vehicle back into the original lane. There is a risk of an accident.

Always steer, brake or accelerate yourself, especially if Active Lane Keeping Assist warns you or makes a lane-correcting brake application.

#### WARNING

Active Lane Keeping Assist does not detect traffic conditions or road users. In very rare cases, the system may make an inappropriate brake application, e.g. after intentionally driving over a solid lane marking. There is a risk of an accident.

An inappropriate brake application may be interrupted at any time if you steer slightly in the opposite direction. Always make sure that there is sufficient distance on the side for other traffic or obstacles.



If you leave your lane, under certain circumstances the vehicle will brake briefly on one side. This is meant to assist you in bringing the vehicle back to the original lane. If a lane-correcting brake application occurs, display ① appears in the multifunction display.

This function is available in the range between 40 mph and 120 mph (60 km/h and 200 km/h).

A lane-correcting brake application can only be made after driving over a solid, recognizable lane marking. Before this, a warning must be given by means of intermittent vibration in the steering wheel. In addition, a lane with lane markings on both sides must be recognized. The brake application also slightly reduces vehicle speed.

-  A further lane-correcting brake application can only occur after your vehicle has returned to the original lane.

No lane-correcting brake application occurs if:

- you clearly and actively steer, brake or accelerate.
- you cut the corner on a sharp bend.
- you have switched on the turn signals.
- a driving safety system intervenes, e.g. ESP<sup>®</sup>, PRE-SAFE<sup>®</sup> Brake or Active Blind Spot Assist.
- you have adopted a sporty driving style with high cornering speeds or high rates of acceleration.
- ESP<sup>®</sup> is switched off.
- the transmission is not in position **D**.
- a loss of tire pressure or a defective tire has been detected and displayed.

Active Lane Keeping Assist may be unable to detect other road or traffic conditions. An inappropriate brake application may be interrupted at any time if you:

- steer slightly in the opposite direction
- use a turn signal
- clearly brake or accelerate

A lane-correcting brake application is interrupted automatically if:

- a driving safety system intervenes, e.g. ESP®, PRE-SAFE® Brake or Active Blind Spot Assist.
- lane markings can no longer be recognized.

### Switching on Active Lane Keeping Assist

► Switch on Active Lane Keeping Assist using the on-board computer; to do so, select **Standard** or **Adaptive** (► page 229).

If you drive at speeds above 40 mph (60 km/h) and lane markings are detected, the lines in the assistance graphics display (► page 227) are shown in green. Lane Keeping Assist is ready for use.

If **Standard** is selected, no warning vibration occurs if:

- you have switched on the turn signals. In this event, the warnings are suppressed for a certain period of time.
- a driving safety system intervenes, such as ABS, BAS or ESP®.

If **Adaptive** is selected, no warning vibration occurs if:

- you have switched on the turn signals. In this event, the warnings are suppressed for a certain period of time.
- a driving safety system intervenes, e.g. ABS, BAS or ESP®.
- you accelerate hard, e.g. kickdown.
- you brake hard.
- you steer actively, e.g. swerve to avoid an obstacle or change lanes quickly.
- you cut the corner on a sharp bend.

In order that you are warned only when necessary and in good time if you cross the lane marking, the system recognizes certain conditions and warns you accordingly.

The warning vibration occurs earlier if:

- you approach the outer lane marking on a bend.
- the road has very wide lanes, e.g. a highway.
- the system recognizes solid lane markings.

The warning vibration occurs later if:

- the road has narrow lanes.
- you cut the corner on a bend.

Useful information .....	218
Important safety notes .....	218
Displays and operation .....	219
Menus and submenus .....	222
Display messages .....	237
Indicator and warning lamps in the instrument cluster .....	264

### Useful information

- 1 This Operator's Manual describes all models and all standard and optional equipment of your vehicle available at the time of publication of the Operator's Manual. Country-specific differences are possible. Please note that your vehicle may not be equipped with all features described. This also applies to safety-related systems and functions.
- i Read the information on qualified specialist workshops: (▷ page 26).

### Important safety notes

#### WARNING

If you operate information systems and communication equipment integrated in the vehicle while driving, you will be distracted from traffic conditions. You could also lose control of the vehicle. There is a risk of an accident.

Only operate the equipment when the traffic situation permits. If you are not sure that this is possible, park the vehicle paying attention to traffic conditions and operate the equipment when the vehicle is stationary.

#### WARNING

If the instrument cluster has failed or malfunctioned, you may not recognize function restrictions in systems relevant to safety. The operating safety of your vehicle may be impaired. There is a risk of an accident.

Drive on carefully. Have the vehicle checked at a qualified specialist workshop immediately.

multifunction display. You should therefore make sure your vehicle is operating safely at all times. Otherwise, a vehicle that is not operating safely may cause an accident.

For an overview, see the instrument panel illustration (▷ page 31).

You must observe the legal requirements for the country in which you are currently driving when operating the on-board computer.

The on-board computer only shows messages or warnings from certain systems in the

## Displays and operation

### Instrument cluster

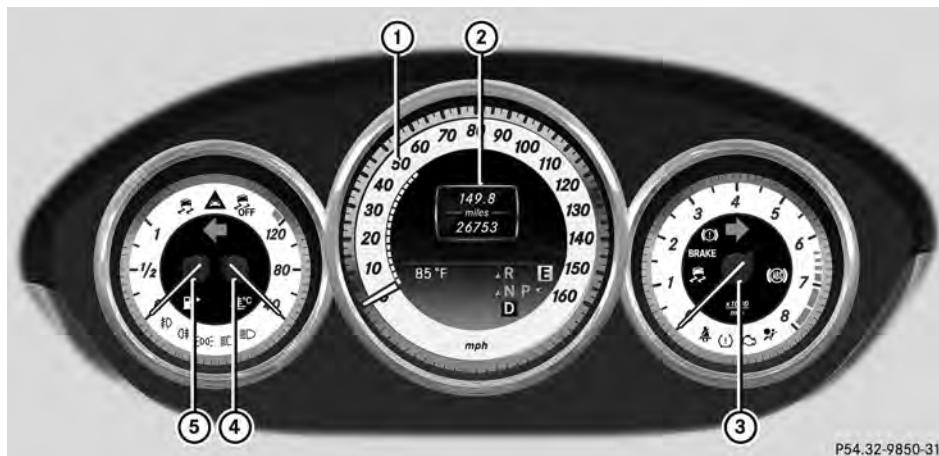

P54.32-9850-31

- ① Speedometer with segments (▷ page 220)
- ② Multifunction display (▷ page 221)
- ③ Tachometer (▷ page 219)
- ④ Coolant temperature (▷ page 219)
- ⑤ Fuel gauge

### Coolant temperature display

#### WARNING

Opening the hood when the engine is overheated or when there is a fire in the engine compartment could expose you to hot gases or other service products. There is a risk of injury.

Let an overheated engine cool down before opening the hood. If there is a fire in the engine compartment, keep the hood closed and contact the fire department.

- I** A display message is shown if the coolant temperature is too high.  
If the coolant temperature is over 248 °F (120 °C), do not continue driving. The engine will otherwise be damaged.

The coolant temperature gauge is in the instrument cluster on the left-hand side (▷ page 31).

Under normal operating conditions and with the specified coolant level, the coolant temperature may rise to 248 °F (120 °C).

### Tachometer

- I** Do not drive in the overrevving range, as this could damage the engine.

The red band in the tachometer indicates the engine's overrevving range.

The fuel supply is interrupted to protect the engine when the red band is reached.

### Outside temperature display

You should pay special attention to road conditions when temperatures are around freezing point.

The outside temperature display is in the multifunction display (▷ page 221).

Changes in the outside temperature are displayed after a short delay.

### Speedometer with segments

The segments in the speedometer indicate which speed range is available.

- Cruise control activated (▷ page 175):  
The segments light up from the stored speed to the maximum speed.
- DISTRONIC PLUS activated (▷ page 177):  
One or two segments in the set speed range light up.
- DISTRONIC PLUS detects a vehicle in front:  
The segments between the speed of the vehicle in front and the stored speed light up.

### Operating the on-board computer

#### Overview









- ① Multifunction display
- ② Right control panel
- ③ Switches on the Voice Control System; see the separate operating instructions
- ④ Back button
- ⑤ Left control panel



► **To activate the on-board computer:** turn the SmartKey to position **1** in the ignition lock.



You can control the multifunction display and the settings in the on-board computer using the buttons on the multifunction steering wheel.

**Left control panel**



	<ul style="list-style-type: none"> <li>• Calls up the menu and menu bar</li> </ul>
	
	<p><b>Press briefly:</b></p> <ul style="list-style-type: none"> <li>• Scrolls in lists</li> <li>• Selects a submenu or function</li> <li>• In the <b>Audio</b> menu: selects a stored station, an audio track or a video scene</li> <li>• In the <b>Tel</b> (telephone) menu: switches to the phone book and selects a name or telephone number</li> </ul>
	
	<p><b>Press and hold:</b></p> <ul style="list-style-type: none"> <li>• In the <b>Audio</b> menu: selects the previous/next station or selects an audio track or a video scene using rapid scrolling</li> <li>• In the <b>Tel</b> (telephone) menu: starts rapid scrolling if the phone book is open</li> </ul>
	
	<ul style="list-style-type: none"> <li>• Confirms a selection/display message</li> <li>• In the <b>Tel</b> (telephone) menu: switches to the telephone book and starts dialing the selected number</li> <li>• In the <b>Audio</b> menu: stops the station search function at the desired station</li> </ul>

**Right control panel**

	<ul style="list-style-type: none"> <li>• Rejects or ends a call</li> <li>• Exits phone book/redial memory</li> </ul>
	<ul style="list-style-type: none"> <li>• Makes or accepts a call</li> <li>• Switches to the redial memory</li> </ul>

	• Adjusts the volume
	
	• Mute



**Back button**

	<p><b>Press briefly:</b></p> <ul style="list-style-type: none"> <li>• Back</li> <li>• Switches off the Voice Control System; see the separate operating instructions</li> <li>• Hides display messages/calls up the last <b>Trip</b> menu function used</li> <li>• Exits the telephone book/redial memory</li> </ul>
	<p><b>Press and hold:</b></p> <ul style="list-style-type: none"> <li>• Calls up the standard display in the <b>Trip</b> menu</li> </ul>

**Multifunction display**



- ① Text field
- ② Menu bar
- ③ Drive program (▷ page 156)
- ④ Transmission position (▷ page 155)
- ⑤ Permanent display: outside temperature or speed (▷ page 230)

► **To show menu bar**②: press the  or  button on the steering wheel.

Menu bar ② disappears after a few seconds.

Text field ① shows the selected menu or submenu as well as display messages.

The following messages may appear in the multifunction display:

- ↑ Shift recommendation (▷ page 161)
- ←P→ Active Parking Assist (▷ page 196)
- ☰ Adaptive Highbeam Assist (▷ page 122)
- ECO ECO start/stop function (▷ page 150)
- HOLD HOLD function (▷ page 186)

## Menus and submenus

### Menu overview

Press the ◀ or ▶ button on the steering wheel to call up the menu bar and select a menu.

Operating the on-board computer (▷ page 220).

Depending on the equipment installed in the vehicle, you can call up the following menus:

- **Trip** menu (▷ page 222)
- **Navi** menu (navigation instructions) (▷ page 224)
- **Audio** menu (▷ page 225)
- **Te1** menu (telephone) (▷ page 226)
- **DriveAssist** menu (assistance) (▷ page 227)
- **Serv.** menu (▷ page 229)
- **Settings** menu (settings) (▷ page 229)
- **AMG** menu in AMG vehicles (▷ page 234)

## Trip menu

### Standard display



- ▶ Press and hold the ◀ button on the steering wheel until the **Trip** menu with trip odometer ① and odometer ② is shown.

### Trip computer "From Start" or "From Reset"

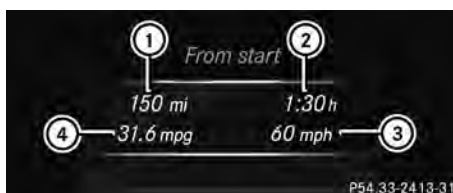

Example: trip computer "From Start"

- ① Distance
- ② Time
- ③ Average speed
- ④ Average fuel consumption

- ▶ Press the ◀ or ▶ button on the steering wheel to select the **Trip** menu.
- ▶ Press ▲ or ▼ to select **From Start** or **From Reset**.

The values in the **From Start** submenu are calculated from the start of a journey whilst the values in the **From Reset** submenu are calculated from the last time the submenu was reset (▷ page 223).

The **From Start** trip computer is automatically reset when:

- the ignition has been switched off for more than four hours.
- 999 hours have been exceeded.
- 9,999 miles have been exceeded.



The **From Reset** trip computer is automatically reset if the value exceeds 9,999 hours or 99,999 miles.

### ECO display

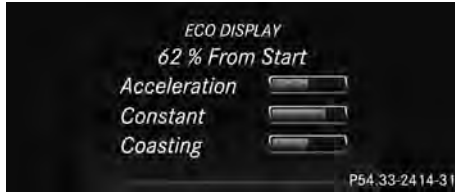

Example: ECO display

- ▶ Press the or button on the steering wheel to select the **Trip** menu.
- ▶ Select **ECO DISPLAY** with or .

If the ignition remains switched off for longer than four hours, the ECO display will be automatically reset.

Further information on the ECO display ([▷ page 170](#)).

### Displaying the range and current fuel consumption



- ▶ Press the or button on the steering wheel to select the **Trip** menu.
- ▶ Press the or button to select the current fuel consumption (not for AMG vehicles) and the approximate range.

The approximate range that can be covered depends on the fuel level and your current driving style. If there is only a small amount of fuel left in the fuel tank, the display shows a vehicle being refueled instead of the range.

### Digital speedometer



- ① Shift recommendation ([▷ page 161](#))
- ② Digital speedometer

- ▶ Press the or button on the steering wheel to select the **Trip** menu.
- ▶ Press the or button to select the digital speedometer.

**i** If the gearshift recommendation is shown at the top of the multifunction display, it is no longer shown at the bottom of the multifunction display.

### Resetting values

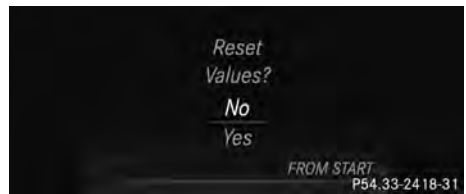

Example: resetting the trip computer "From Start"

- ▶ Press the or button on the steering wheel to select the **Trip** menu.
- ▶ Press the or button to select the function that you wish to reset.
- ▶ Press the button.
- ▶ Press the button to select **Yes** and press the button to confirm.

You can reset the values of the following functions:

- Trip odometer
- "From Start" trip computer
- "From Reset" trip computer
- ECO display

- ① When you reset the values in the "ECO display", the values in the trip computer "From start" are likewise reset. When you reset the values in the trip computer "From start", the values in the "ECO display" are likewise reset.

### Navigation system menu

#### Displaying navigation instructions

In the **Navi** menu, the multifunction display shows navigation instructions. For more information on navigation, see the separate operating instructions.

- ▶ Switch on COMAND (see the separate operating instructions).
- ▶ Press the ◀ or ▶ button on the steering wheel to select the **Navi** menu.

#### Route guidance not active



- ① Direction of travel
- ② Current road

#### Route guidance active

##### No change of direction announced



- ① Distance to the destination
- ② Distance to the next change of direction
- ③ Current road
- ④ "Follow the road's course" symbol

##### Change of direction announced without a lane recommendation

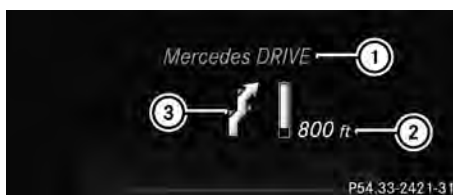

- ① Road into which the change of direction leads
- ② Distance to change of direction and visual distance display
- ③ Change-of-direction symbol

When a change of direction is announced, you will see symbol ③ for the change of direction and distance graphic ②. The distance indicator shortens towards the top of the display as you approach the point of the announced change of direction.

##### Change of direction announced with a lane recommendation



- ① Road into which the change of direction leads
- ② Distance to change of direction and visual distance display
- ③ New lane during a change of direction
- ④ Uninterrupted lane
- ⑤ Lane recommendation
- ⑥ Change-of-direction symbol

On multilane roads, the system can display lane recommendation ③ for the next change of direction. During the change of direction, additional lanes may be displayed.

Lane recommendations are only displayed if the relevant data is available on the digital map.

### Other status indicators of the navigation system

-  : you have reached the destination or an intermediate destination.
- **New Route...** or **Calculating Route:** calculating a new route
- **Off Map** or **Off Road:** the vehicle position is outside the area of the digital map (off-map position).
- **No Route:** no route could be calculated to the selected destination.







### Audio menu

#### Selecting a radio station





- ① Waveband
- ② Station frequency with memory position

**i** Station ② is displayed with the station frequency or station name. The memory position is only displayed along with station ② if this has been stored.

- ▶ Switch on the audio system or COMAND and select Radio; see the separate operating instructions.
- ▶ Press the  or  button on the steering wheel to select the **Audio** menu.
- ▶ **To select a stored station:** briefly press the  or  button.
- ▶ **To select a station from the station list:** press and briefly hold the  or  button.

If no station list is received:

- ▶ **To select a station using the station search:** press and briefly hold the  or  button.

**i** For information on switching waveband and storing stations; see the separate operating instructions.

**i** SIRIUS XM satellite radio functions like a normal radio.

For more information on satellite radio operation, see the separate operating instructions.







### Operating an audio player or audio media





Example: CD/DVD changer display

- ① Current title

Audio data from various audio devices or media can be played, depending on the equipment installed in the vehicle.

- ▶ Switch on COMAND and activate audio CD/DVD mode or MP3 mode; see the separate operating instructions.
- ▶ Press the  or  button on the steering wheel to select the **Audio** menu.
- ▶ **To select the next/previous track:** briefly press the  or  button.
- ▶ **To select a track from the track list (rapid scrolling):** press and hold the  or  button until desired track ① has been reached.

If you press and hold  or , the rapid scrolling speed is increased. Not all audio drives or data carriers support this function.

If track information is stored on the audio device or medium, the multifunction display will show the number and title of the track. The current track does not appear in audio AUX mode (**Auxiliary audio mode:** external audio source connected).

## Video DVD operation



Example: CD/DVD changer display

① Current scene

- ▶ Switch on COMAND and select video DVD; see the separate operating instructions.
- ▶ Press the ◀ or ▶ button on the steering wheel to select the **Audio** menu.
- ▶ **To select the next/previous scene:** briefly press the ▲ or ▼ button.
- ▶ **To select a scene from the scene list (rapid scrolling):** press and hold the ▲ or ▼ button until desired scene ① has been reached.

## Telephone menu

### Introduction

#### **WARNING**

If you operate information systems and communication equipment integrated in the vehicle while driving, you will be distracted from traffic conditions. You could also lose control of the vehicle. There is a risk of an accident.

Only operate the equipment when the traffic situation permits. If you are not sure that this is possible, park the vehicle paying attention to traffic conditions and operate the equipment when the vehicle is stationary.

When telephoning, you must observe the legal requirements for the country in which you are currently driving.

- ▶ Switch on the mobile phone (see the separate operating instructions).
- ▶ Switch on COMAND (see the separate operating instructions).

- ▶ Establish a Bluetooth® connection to COMAND; see the separate operating instructions.
- ▶ Press the ◀ or ▶ button on the steering wheel to select the **Te1** menu.

You will see one of the following display messages in the multifunction display:

- **Phone READY** or the name of the network provider: the mobile phone has found a network and is ready to receive.
- **Phone No Service:** there is no network available or the mobile phone is searching for a network.

## Accepting a call

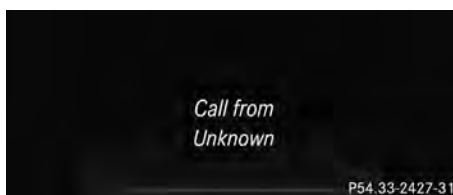

Example: incoming call

- ▶ Press the  button on the steering wheel to accept an incoming call.

If someone calls you when you are in the **Te1** menu, a display message appears in the multifunction display.

You can accept a call even if you are not in the **Te1** menu.

## Rejecting or ending a call

- ▶ Press the  button on the steering wheel.



You can end or reject a call even if you are not in the **Te1** menu.



## Dialing a number from the phone book

- ▶ Press the ◀ or ▶ button on the steering wheel to select the **Te1** menu.
- ▶ Press the ▲, ▼ or **OK** button to switch to the phone book.







- ▶ Press the  or  button to select the desired name.

or



- ▶ **To begin rapid scrolling:** press and hold the  or  button for longer than one second. Rapid scrolling stops when you release the button or reach the end of the list.

- ▶ **If only one telephone number is stored for a name:** press the  or  button to start dialing.

or







- ▶ **If there is more than one number for a particular name:** press the  or  button to display the numbers.
- ▶ Press the  or  button to select the number you want to dial.
- ▶ Press the  or  button to start dialing.

or



- ▶ **To exit the telephone book:** press the  or  button.

### Redialing

The on-board computer saves the last names or numbers dialed in the redial memory.

- ▶ Press the  or  button on the steering wheel to select the **Te1** menu.
- ▶ Press the  button to switch to the redial memory.
- ▶ Press the  or  button to select the desired name or number.
- ▶ Press the  or  button to start dialing.

or

- ▶ **To exit the redial memory:** press the  or  button.

### Assistance menu





#### Introduction



In the **DriveAssist** menu, you have the following options:

- Displaying the assistance graphic (▷ page 227)
- Activating/deactivating ESP® (▷ page 227)
- Activating/deactivating PRE-SAFE® Brake (▷ page 228)
- Activating/deactivating ATTENTION ASSIST (▷ page 228)
- Activating/deactivating Blind Spot Assist or Active Blind Spot Assist (▷ page 228)
- Activating/deactivating Lane Keeping Assist or Active Lane Keeping Assist (▷ page 229)

#### Displaying the assistance graphic

- ▶ Press the  or  button on the steering wheel to select the **DriveAssist** menu.
- ▶ Press the  or  button to select **Assist. Graphic**.
- ▶ Press the  button. The DISTRONIC PLUS assistance graphic appears in the multifunction display (▷ page 184).

#### Deactivating/activating ESP®

- ▶ **i** Observe the "Important safety notes" section in the description of ESP (▷ page 68).

**⚠ WARNING**

If you deactivate ESP®, ESP® no longer stabilizes the vehicle. There is an increased risk of skidding and an accident.







Only deactivate ESP® in the situations described in the following.

It may be best to deactivate ESP® in the following situations:



- when using snow chains
- in deep snow
- on sand or gravel

Activating/deactivating ESP® on AMG vehicles (▷ page 70).

For further information about ESP®, see (▷ page 68).

- ▶ Start the engine.
- ▶ Press the  or  button on the steering wheel to select the **DriveAssist** menu.
- ▶ Press the  or  button to select **ESP**.
- ▶ Press the  button.  
The current selection is displayed.
- ▶ **To activate/deactivate:** press the  button again.

ESP® is deactivated if the  warning lamp in the instrument cluster lights up continuously when the engine is running.







If the  warning lamp and the  warning lamp are lit continuously, ESP® is not available due to a malfunction.

Observe the information on warning lamps (▷ page 269).

Observe the information on display messages (▷ page 238).

**Activating/deactivating PRE-SAFE® Brake**







PRE-SAFE® Brake is only available in vehicles with DISTRONIC PLUS.

- ▶ Press  or  on the steering wheel to select the **DriveAssist** menu.
- ▶ Press the  or  button to select **PRE-SAFE Brake**.
- ▶ Press the  button.  
The current selection is displayed.
- ▶ **To activate/deactivate:** press the  button again.

When PRE-SAFE® Brake is deactivated, the assistance graphic shows the  symbol in the multifunction display.

For more information on PRE-SAFE® Brake, see (▷ page 72).





**Activating/deactivating ATTENTION ASSIST**

- ▶ Press  or  on the steering wheel to select the **DriveAssist** menu.
- ▶ Press  or  to select **Attention Assist**.
- ▶ Press the  button.  
The current selection is displayed.
- ▶ **To activate/deactivate:** press the  button again.

When ATTENTION ASSIST is deactivated, the  symbol and OFF appear in the multifunction display in the assistance display when the engine is running.

For further information about ATTENTION ASSIST, see (▷ page 203).

**Activating/deactivating Blind Spot Assist**

- ▶ Press  or  on the steering wheel to select the **DriveAssist** menu.
- ▶ Press the  or  button to select **Blind Spot Asst.**

- ▶ Press the **OK** button.  
The current selection is displayed.
- ▶ **To activate/deactivate:** press the **OK** button again.

If the **Blind Spot Assist Sensors Deactivated** or **Act. Blind Spot Asst. Sensors Deactivated** message appears, the radar sensor system is deactivated.

- ▶ Switch on the radar sensor system (▷ page 232).

For further information about Blind Spot Assist, see (▷ page 207).

For further information about Active Blind Spot Assist, see (▷ page 211).

### Activating/deactivating Lane Keeping Assist

- ▶ Press **◀** or **▶** on the steering wheel to select the **DriveAssist** menu.
- ▶ Press the **▲** or **▼** button to select **Lane Keep. Asst.**
- ▶ Press the **OK** button.  
The current selection is displayed.
- ▶ Press **OK** to confirm.
- ▶ Press the **▼** or **▲** button to set **Off**, **Standard** or **Adaptive**.
- ▶ Press the **OK** button to save the setting.

For further information about Lane Keeping Assist, see (▷ page 209).

For further information about Active Lane Keeping Assist, see (▷ page 214).

### Maintenance menu



In the **Serv.** menu, you have the following options:

- Calling up display messages in message memory (▷ page 237)
- Restarting the tire pressure loss warning system (▷ page 342)
- Checking the tire pressure electronically (▷ page 342)
- Calling up the service due date (▷ page 310)

### Settings menu

#### Introduction



In the **Sett.** menu, you have the following options:









- Changing the instrument cluster settings (▷ page 229)
- Changing the light settings (▷ page 230)
- Changing the vehicle settings (▷ page 232)
- Changing the convenience settings (▷ page 233)
- Restoring the factory settings (▷ page 234)

#### Instrument cluster

##### Selecting the unit of measurement for distance

The **Display Unit Speed-/Odometer:** function allows you to choose whether certain displays appear in kilometers or miles in the multifunction display.

You can determine whether the multifunction display shows some messages in miles or kilometers.









- ▶ Press the  or  button on the steering wheel to select the **Sett.** menu.
- ▶ Press the  or  button to select the **Inst. Cluster** submenu.
- ▶ Press  to confirm.
- ▶ Press the  or  button to select the **Display Unit Speed-/Odometer:** function.  
You will see the selected setting: **km** or **miles**.
- ▶ Press the  button to save the setting.

The selected unit of measurement for distance applies to:

- the digital speedometer in the **Trip** menu
- odometer and the trip odometer
- trip computer
- current consumption and the range
- the navigation instructions in the **Navi** menu
- cruise control
- DISTRONIC PLUS
- ASSYST PLUS service interval display

### Selecting the permanent display function

You can determine whether the multifunction display permanently shows your speed or the outside temperature.















- ▶ Press the  or  button on the steering wheel to select the **Sett.** menu.
- ▶ Press the  or  button to select the **Inst. Cluster** submenu.
- ▶ Press  to confirm.
- ▶ Press the  or  button to select the **Permanent Display:** function.  
You will see the selected setting **Outside Temperature** or **Speedometer [km/h]** (USA)/**Speedometer [mph]** (Canada).
- ▶ Press the  button to save the setting.

- i** The speed is shown in km/h (USA)/mph (Canada).

## Lights

### Setting the brightness of the instrument cluster lighting and switches





The lighting in the instrument cluster, in the displays and the controls in the vehicle interior can be adjusted using the **Brightness Display/Switches:** function.

- ▶ Press the  or  button on the steering wheel to select the **Sett.** menu.
- ▶ Press the  or  button to select the **Lights** submenu.
- ▶ Press  to confirm.
- ▶ Press the  or  button to select the **Brightness Display/Switches:** function.  
You will see the selected setting.
- ▶ Press  to confirm.
- ▶ Press the  or  button to adjust the brightness to any level from **Level 1** to **Level 5** (bright).
- ▶ Press the  or  button to save the setting.  
If the light switch is set to ,  or , the brightness is dependent upon the brightness of the ambient light.





- i** The light sensor in the instrument cluster automatically controls the brightness of the multifunction display.

In daylight, the displays in the instrument cluster are not illuminated.

### Switching the daytime running lamps on/off













- i** This function is not available in Canada.
- ▶ Press the  or  button on the steering wheel to select the **Sett.** menu.
- ▶ Press the  or  button to select the **Lights** submenu.
- ▶ Press  to confirm.















- ▶ Press  or  to select the **Day Lights**: function.
- If the **Day Lights**: have been switched on, the cone of light and the  symbol in the multifunction display are shown in red.
- ▶ Press the  button to save the setting.

Further information on daytime running lamps (▷ page 117).









### Setting the brightness of the ambient lighting

- ▶ Press the  or  button on the steering wheel to select the **Sett.** menu.
  - ▶ Press the  or  button to select the **Lights** submenu.
  - ▶ Press  to confirm.
  - ▶ Press the  or  button to select the **Amb. Light +/-** function.
- You will see the selected setting.
- ▶ Press  to confirm.
  - ▶ Press the  or  button to adjust the brightness to any level from **Off** to **Level 5** (bright).
  - ▶ Press the  or  button to save the setting.

### Setting the ambient lighting color

- ▶ Press the  or  button on the steering wheel to select the **Sett.** menu.
- ▶ Press the  or  button to select the **Lights** submenu.
- ▶ Press  to confirm.
- ▶ Press the  or  button to select the **Ambient Light Color** function.
- ▶ Press  to confirm.
- ▶ Press the  or  button to set the color to **SOLAR**, **NEUTRAL** or **POLAR**.
- ▶ Press the  or  button to save the setting.

### Activating/deactivating surround lighting and exterior lighting delayed switch-off

- ▶ Press the  or  button on the steering wheel to select the **Sett.** menu.
  - ▶ Press the  or  button to select the **Lights** submenu.
  - ▶ Press  to confirm.
  - ▶ Press  or  to select the **Surround Lighting** function.
- When the **Surround Lighting** function is activated, the light cone and the area around the vehicle are displayed in red in the multifunction display.
- ▶ Press the  button to save the setting.

Deactivating delayed switch-off of the exterior lighting temporarily:

- ▶ Before leaving the vehicle, turn the SmartKey to position **0** in the ignition lock.
  - ▶ Turn the SmartKey to position **2** in the ignition lock.
- The exterior lighting delayed switch-off is deactivated.

Delayed switch-off of the exterior lighting is reactivated the next time you start the engine.

If you have activated the **Surround Lighting** function and the light switch is set to **AUTO**, the following functions are activated when it is dark:

- **Surround lighting:** the exterior lighting remains lit for 40 seconds after unlocking with the SmartKey. If you start the engine, the surround lighting is switched off and the automatic headlamp mode is activated (▷ page 117).
- **Exterior lighting delayed switch-off:** the exterior lighting remains lit for 60seconds after the engine is switched off. If you close all the doors and the trunk lid, the exterior lighting goes off after 5 seconds.









**i** Depending on your vehicle's equipment, when the surround lighting and delayed

switch-off exterior lighting are on, the following light up:

- Parking lamps
- Low-beam headlamps
- Daytime running lamps
- Side marker lamps
- Surround lighting in the exterior mirrors









### Activating/deactivating the interior lighting delayed switch-off

If you activate the **Interior Lighting Delay** function, the interior lighting remains on for 20seconds after you remove the SmartKey from the ignition lock.

- ▶ Press the  or  button on the steering wheel to select the **Sett.** menu.
  - ▶ Press the  or  button to select the **Lights** submenu.
  - ▶ Press  to confirm.
  - ▶ Press  or  to select the **Light. Delay** function.
- When the **Interior Lighting Delay** function is activated, the vehicle interior is displayed in red in the multifunction display.
- ▶ Press the  button to save the setting.

## Vehicle

### Activating/deactivating the automatic door locking mechanism









- ▶ Press the  or  button on the steering wheel to select the **Sett.** menu.
  - ▶ Press  or  to select the **Vehicle** submenu.
  - ▶ Press  to confirm.
  - ▶ Press  or  to select the **Auto. Door Locks** function.
- When the **Automatic Door Lock** function is activated, the vehicle doors are displayed in red in the multifunction display.
- ▶ Press the  button to save the setting.

If you activate the **Automatic Door Lock** function, the vehicle is centrally locked above a speed of around 9 mph (15 km/h).









For further information on the automatic locking feature, see (▷ page 83).

### Activating/deactivating the acoustic locking verification signal

If you switch on the **Acoustic Lock** function, an acoustic signal sounds when you lock the vehicle.

- ▶ Press the  or  button on the steering wheel to select the **Sett.** menu.
  - ▶ Press  or  to select the **Vehicle** submenu.
  - ▶ Press  to confirm.
  - ▶ Press the  or  button to select the **Acoustic Lock** function.
- If the **Acoustic Lock** function is activated, the  symbol in the multifunction display lights up red.
- ▶ Press the  button to save the setting.

### Activating/deactivating the radar sensor system

- ▶ Press the  or  button on the steering wheel to select the **Sett.** menu.
  - ▶ Press  or  to select the **Vehicle** submenu.
  - ▶ Press  to confirm.
  - ▶ Press the  or  button to select **Radar Sensor (See Oper. Manual):.**
- You will see the selected setting: **Enabled** or **Disabled**.
- ▶ Press the  button to save the setting.

The following systems are switched off when the radar sensor system is deactivated:

- DISTRONIC PLUS (▷ page 177)
- BAS PLUS (▷ page 67)
- PRE-SAFE® Brake (▷ page 72)
- Blind Spot Assist (▷ page 207)
- Active Blind Spot Assist (▷ page 211)

**Convenience**

**Activating/deactivating the EASY-ENTRY/EXIT feature**

**⚠ WARNING**

When the EASY-ENTRY/EXIT feature adjusts the steering wheel, you and other vehicle occupants – particularly children – could become trapped. There is a risk of injury.

While the EASY-ENTRY/EXIT feature is making adjustments, make sure that no one has any body parts in the sweep of the steering wheel.

If somebody becomes trapped:

- press one of the memory function position buttons, or
- move the switch for steering wheel adjustment in the opposite direction to that in which the steering wheel is moving.

The adjustment process is stopped.

- ▶ Press the ◀ or ▶ button on the steering wheel to select the **Settings** menu.
- ▶ Press the ▼ or ▲ button to select the **Convenience** submenu.
- ▶ Press **OK** to confirm.
- ▶ Press the ▼ or ▲ button to select the **Easy Entry/Exit:** function.  
If the **Easy Entry/Exit** function is activated, the vehicle steering wheel is displayed in red in the multifunction display.
- ▶ Press the **OK** button to save the setting.

Further information on the EASY-ENTRY/EXIT feature (> page 108).

**Switching the belt adjustment on/off**

- ▶ Press the ◀ or ▶ button on the steering wheel to select the **Sett.** menu.
- ▶ Press the ▼ or ▲ button to select the **Convenience** submenu.
- ▶ Press **OK** to confirm.

- ▶ Press the ▼ or ▲ button to select the **Belt Adjustment** function.  
When the **Belt Adjustment** function is activated, the vehicle seat belt is displayed in red in the multifunction display.
- ▶ Press the **OK** button to save the setting.

For further information on belt adjustment, see (> page 57).

**Switching the fold-in mirrors with the locking feature on/off**

This function is only available on vehicles with the memory function (> page 112).

When you activate the **Auto. Mirror Folding** function, the exterior mirrors are folded in when the vehicle is locked. If you unlock the vehicle and then open a door, the exterior mirrors fold out again.

- ▶ Press the ◀ or ▶ button on the steering wheel to select the **Sett.** menu.
- ▶ Press the ▼ or ▲ button to select the **Convenience** submenu.
- ▶ Press **OK** to confirm.
- ▶ Press ▼ or ▲ to select the **Auto. Mirror Folding** function.  
If the **Auto. Mirror Folding** function is activated, the vehicle's exterior mirror is displayed in red in the multifunction display.
- ▶ Press the **OK** button to save the setting.



① To fold the exterior mirrors in or out

If you have switched on the **Auto. Mirror Folding** function and you fold in the exterior mirrors by pressing button ①, the exterior

mirrors will not fold out automatically (▷ page 110).

You can then only fold out the exterior mirrors using button ①.

### Restoring the factory settings

- ▶ Press the ◀ or ▶ button on the steering wheel to select the **Sett.** menu.
- ▶ Press the ▼ or ▲ button to select the **Factory Setting** submenu.
- ▶ Press **OK** to confirm.  
The **Reset All Settings?** message appears.
- ▶ Press the ▼ or ▲ button to select **No** or **Yes**.
- ▶ Press **OK** to confirm the selection.

If you have selected **Yes**, the multifunction display shows a confirmation message.

For safety reasons, the **Daytime Running Lights** function in the **Lights** submenu is only reset if the vehicle is stationary.

### AMG menu in AMG vehicles

#### AMG displays



- ① Digital speedometer
  - ② Gear indicator
  - ③ Upshift indicator
  - ④ Engine oil temperature
  - ⑤ Coolant temperature
  - ⑥ ECO start/stop function status indicator (▷ page 151)
- ▶ Press the ◀ or ▶ button on the steering wheel to select the **AMG** menu.

Upshift indicator **UP**③ indicates that the engine has reached the overrevving range when in the manual gearshift program. Upshift indicator **UP**③ fades out other messages until you have shifted up.

When the engine oil temperature is below 176 °F (80 °C) the oil temperature is shown in blue. Avoid driving at full engine output during this time.

### SETUP



- ① Drive program (**C/SS+/M**)
- ② ESP® mode (**ON/OFF**) or SPORT handling mode (**SPORT**)
- ③ Suspension tuning (**COMFORT/SPORT/SPORT+**)

SETUP shows the drive program, the ESP® (Electronic Stability Program) mode and the suspension tuning.

- ▶ Press the ◀ or ▶ button on the steering wheel to select the **AMG** menu.
  - ▶ Press the ▲ button repeatedly until **SETUP** is displayed.
- or
- ▶ Briefly press the AMG button on the center console (▷ page 191).

## RACETIMER

### Displaying and starting RACETIMER



- ① Lap
- ② RACETIMER

The RACETIMER is only intended for use on a closed race circuit. Do not use the function on public roads.

You can start the RACETIMER when the engine is running or if the SmartKey is in position 2 in the ignition lock.

- ▶ Press or on the steering wheel to select the **AMG** menu.
- ▶ Press the button repeatedly until the RACETIMER is shown.
- ▶ **To start:** press the button to start the RACETIMER.

### Displaying the intermediate time



- ▶ Press the or button to select **Interm. Time**.
  - ▶ Press to confirm.
- The intermediate time is displayed for five seconds.

### Starting a new lap



- ① RACETIMER
  - ② Fastest lap time (best lap)
  - ③ Lap
- ▶ Press to confirm **New Lap**.

**i** It is possible to store a maximum of sixteen laps. The 16th lap can only be completed with **Finish Lap**.

### Stopping the RACETIMER



- ▶ Press the button on the steering wheel.
- ▶ Press to confirm **Yes**.

The RACETIMER interrupts timing when you stop the vehicle and turn the SmartKey to position 1 in the ignition lock. If you turn the SmartKey to position 2 or 3 and then press to confirm **Start**, timing is continued.

### Resetting the current lap

- ▶ Stop the RACETIMER.
- ▶ Press the or button to select **Reset Lap**.
- ▶ Press to reset the lap time to "0".

### Deleting all laps



If you switch off the engine, the RACETIMER is reset to "0" after 30 seconds. All laps are deleted.

You cannot delete individual stored laps. If you have stopped 16 laps, the current lap does not have to be reset.

- ▶ Reset the current lap.
- ▶ Press **OK** to confirm **Reset**.  
**Reset Race Timer?** appears in the multifunction display.
- ▶ Press the **▼** button to select **Yes** and press the **OK** button to confirm.  
All laps are deleted.

### Overall statistics

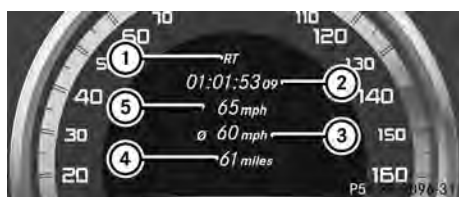

- ① RACETIMER overall evaluation
- ② Total time driven
- ③ Average speed
- ④ Distance covered
- ⑤ Maximum speed

This function is shown if you have stored at least one lap and stopped the RACETIMER.

- ▶ Press the **◀** or **▶** button on the steering wheel to select the **AMG** menu.
- ▶ Press the **▲** button repeatedly until the overall evaluation is shown.

### Lap statistics

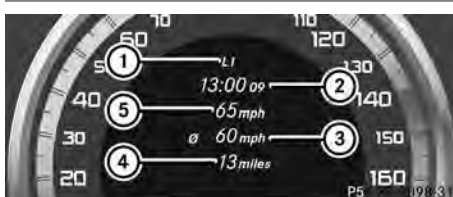

- ① Lap
- ② Lap time
- ③ Average lap speed
- ④ Lap length
- ⑤ Top speed during lap

This function is only available if you have stored at least two laps and have stopped the RACETIMER.

- ▶ Press the **◀** or **▶** button on the steering wheel to select the **AMG** menu.
- ▶ Press the **▲** button repeatedly until the lap evaluation is shown.  
Each lap is shown in a separate submenu. The fastest lap is indicated by flashing symbol ①.
- ▶ Press the **▲** or **▼** button to select a different lap evaluation.

## Display messages

### Introduction

#### General notes

Display messages appear in the multifunction display.

Display messages with graphic displays may be shown in simplified form in the Operator's Manual and may differ from the messages shown in the multifunction display.



Please respond in accordance with the display messages and follow the additional notes in this Operator's Manual.

Certain display messages are accompanied by an audible warning tone or a continuous tone. When the ignition is switched off, all display messages are deleted, apart from some high-priority display messages. Once the causes of the high-priority display messages have been rectified, the corresponding display messages are also deleted.

When you stop and park the vehicle, please observe the notes on:

- HOLD function (▷ page 186)
- Parking (▷ page 167)

#### Hiding display messages







- ▶ Press the  or  button on the steering wheel to hide the display message. The display message is cleared.

The multifunction display shows high-priority display messages in red. Some high-priority display messages cannot be hidden.

The multifunction display shows these messages continuously until the causes for the messages have been remedied.

#### Message memory

The on-board computer saves certain display messages in the **message memory**. You can call up the display messages:

- ▶ Press the  or  button on the steering wheel to select the **Serv.** menu. If there are display messages, the multifunction display shows **2 Messages**, for example.
- ▶ Press the  or  button to select the entry, e.g. **2 Messages**.
- ▶ Press  to confirm.
- ▶ Press the  or  button to scroll through the display messages.

## Safety systems

## Display messages



## Possible causes/consequences and ► Solutions



Currently  
Unavailable See  
Operator's Manual

ABS (Anti-lock Braking System), ESP<sup>®</sup> (Electronic Stability Program), BAS (Brake Assist), PRE-SAFE<sup>®</sup>, the HOLD function and hill start assist are temporarily unavailable.

BAS PLUS and PRE-SAFE<sup>®</sup> Brake may also have failed.

In addition, the ,  and  warning lamps light up in the instrument cluster.

ATTENTION ASSIST is deactivated.

Possible causes are:

- self-diagnosis is not yet complete.
- the on-board voltage may be insufficient.

 **WARNING**

The brake system continues to function normally, but without the functions listed above. The wheels could therefore lock if you brake hard, for example.

The steerability and braking characteristics may be severely affected. The braking distance in an emergency braking situation can increase.

If ESP<sup>®</sup> is not operational, ESP<sup>®</sup> is unable to stabilize the vehicle.

There is an increased risk of skidding and an accident.

- Carefully drive a suitable distance, making slight steering movements, at a speed above 12 mph (20 km/h).  
If the display message disappears, the functions mentioned above are available again.





If the display message continues to be displayed:

- Drive on carefully.
- Visit a qualified specialist workshop.



Inoperative See  
Operator's Manual

ABS, ESP<sup>®</sup>, BAS, PRE-SAFE<sup>®</sup>, the HOLD function and hill start assist are unavailable due to a malfunction.



The  (USA only)/ (Canada only), ,  and  warning lamps in the instrument cluster also light up.











ATTENTION ASSIST is deactivated.



 **WARNING**









The brake system continues to function normally, but without the functions listed above. The wheels could therefore lock if you brake hard, for example.





Display messages	Possible causes/consequences and ► Solutions
	<p>The steerability and braking characteristics may be severely affected. The braking distance in an emergency braking situation can increase.</p> <p>If ESP® is not operational, ESP® is unable to stabilize the vehicle. There is an increased risk of skidding and an accident.</p> <ul style="list-style-type: none"> <li>► Drive on carefully.</li> <li>► Visit a qualified specialist workshop immediately.</li> </ul>
<div style="border: 1px solid black; padding: 2px; width: 40px; height: 40px; margin: 0 auto; text-align: center;">  </div> <p>Inoperative See Operator's Manual</p>	<p>ESP®, BAS, PRE-SAFE®, the HOLD function and hill start assist are unavailable due to a malfunction.</p> <p>In addition, the  and  warning lamps light up in the instrument cluster.</p> <p>The self-diagnosis function might not be complete, for example. ATTENTION ASSIST is deactivated.</p> <p><b>⚠ WARNING</b></p> <p>The brake system continues to function normally, but without the functions listed above.</p> <p>The braking distance in an emergency braking situation can thus increase.</p> <p>If ESP® is not operational, ESP® is unable to stabilize the vehicle. There is an increased risk of skidding and an accident.</p> <ul style="list-style-type: none"> <li>► Carefully drive a suitable distance, making slight steering movements, at a speed above 12 mph (20 km/h). If the display message disappears, the functions mentioned above are available again.</li> </ul> <p>If the display message continues to be displayed:</p> <ul style="list-style-type: none"> <li>► Drive on carefully.</li> <li>► Visit a qualified specialist workshop.</li> </ul>

Display messages	Possible causes/consequences and ► Solutions
<div data-bbox="112 196 283 285">  </div> <p data-bbox="107 293 324 350">Inoperative See Operator's Manual</p>	<p data-bbox="365 196 1039 285">EBD (electronic brake force distribution), ABS, ESP<sup>®</sup>, BAS, PRE-SAFE<sup>®</sup>, the HOLD function and hill start assist are unavailable due to a malfunction.</p> <p data-bbox="365 293 930 321">BAS PLUS and PRE-SAFE<sup>®</sup> Brake may also have failed.</p> <p data-bbox="365 329 1020 386">In addition, the ,  and  warning lamps light up in the instrument cluster and a warning tone sounds.</p> <p data-bbox="377 402 532 430"><b>⚠ WARNING</b></p> <p data-bbox="365 446 1039 529">The brake system continues to function normally, but without the functions listed above. The front and rear wheels could therefore lock if you brake hard, for example.</p> <p data-bbox="365 537 1039 620">The steerability and braking characteristics may be severely affected. The braking distance in an emergency braking situation can increase.</p> <p data-bbox="365 628 1039 695">If ESP<sup>®</sup> is not operational, ESP<sup>®</sup> is unable to stabilize the vehicle. There is an increased risk of skidding and an accident.</p> <ul data-bbox="365 703 898 764" style="list-style-type: none"> <li>► Drive on carefully.</li> <li>► Visit a qualified specialist workshop immediately.</li> </ul>
<div data-bbox="112 797 251 841">  (USA only)         </div> <div data-bbox="165 846 333 889">  (Canada only)         </div> <p data-bbox="107 922 301 979">Release Parking Brake</p>	<p data-bbox="365 797 1039 854">You are driving with the parking brake applied. A warning tone also sounds.</p> <ul data-bbox="365 862 667 889" style="list-style-type: none"> <li>► Release the parking brake.</li> </ul>
<div data-bbox="112 1003 251 1047">  (USA only)         </div> <div data-bbox="165 1052 333 1096">  (Canada only)         </div> <p data-bbox="107 1128 324 1185">Check Brake Fluid Level</p>	<p data-bbox="365 1003 1039 1118">There is not enough brake fluid in the brake fluid reservoir. In addition, the  (USA only)/ (Canada only) warning lamp lights up in the instrument cluster and a warning tone sounds.</p> <p data-bbox="377 1136 532 1164"><b>⚠ WARNING</b></p> <p data-bbox="365 1180 738 1237">The braking effect may be impaired. There is a risk of an accident.</p> <ul data-bbox="365 1245 1039 1438" style="list-style-type: none"> <li>► Pull over and stop the vehicle safely as soon as possible, paying attention to road and traffic conditions. Do not continue driving under any circumstances.</li> <li>► Secure the vehicle against rolling away (► page 167).</li> <li>► Consult a qualified specialist workshop.</li> <li>► Do not add brake fluid. This does not correct the malfunction.</li> </ul>

Display messages	Possible causes/consequences and ► Solutions
 Check Brake Pad Wear	The brake pads/linings have reached their wear limit. ► Visit a qualified specialist workshop.
 mbrace Inoperative	One or more main features of the mbrace system are malfunctioning. ► Have the mbrace system checked immediately at a qualified specialist workshop.
PRE-SAFE Inoperative See Operator's Manual	Important functions of PRE-SAFE® have failed. All other occupant safety systems, e.g. air bags, remain available. ► Visit a qualified specialist workshop immediately.
PRE-SAFE Functions Currently Limited See Operator's Manual	PRE-SAFE® Brake is temporarily inoperative. Possible causes are: <ul style="list-style-type: none"> <li>• function is impaired due to heavy rain or snow.</li> <li>• the sensors in the radiator grill and the bumper are dirty.</li> <li>• the radar sensor system is temporarily inoperative, e.g. due to electromagnetic radiation emitted by nearby TV or radio stations or other sources of electromagnetic radiation.</li> <li>• AMG vehicles: ESP® is deactivated.</li> <li>• the system is outside the operating temperature range.</li> <li>• the on-board voltage is too low.</li> </ul> When the causes stated above no longer apply, the display message disappears. PRE-SAFE® Brake is operational again. If the display message does not disappear: <ul style="list-style-type: none"> <li>► Pull over and stop the vehicle safely as soon as possible, paying attention to road and traffic conditions.</li> <li>► Secure the vehicle against rolling away (▷ page 167).</li> <li>► Clean the sensors in the radiator grill and the bumper (▷ page 315).</li> <li>► Restart the engine.</li> <li>► AMG vehicles: reactivate ESP® (▷ page 70).</li> </ul>
PRE-SAFE Functions Limited See Operator's Manual	PRE-SAFE® Brake is inoperative due to a malfunction. BAS PLUS or the distance warning signal may also have failed. ► Visit a qualified specialist workshop.

Display messages	Possible causes/consequences and ► Solutions
 <p>SRS Malfunction Service Required</p>	<p>There is a malfunction in the SRS (Supplemental Restraint System). The  warning lamp also lights up in the instrument cluster.</p> <p><b>⚠ WARNING</b></p> <p>The air bags or Emergency Tensioning Devices may either be triggered unintentionally or, in the event of an accident, may not be triggered.</p> <p>There is an increased risk of injury.</p> <p>► Visit a qualified specialist workshop.</p> <p>For further information about SRS, see (► page 41).</p>
 <p>Front Left Malfunction Service Required or Front Right Malfunction Service Required</p>	<p>SRS has malfunctioned at the front on the left or right. The  warning lamp also lights up in the instrument cluster.</p> <p><b>⚠ WARNING</b></p> <p>The air bags or Emergency Tensioning Devices may either be triggered unintentionally or, in the event of an accident, may not be triggered.</p> <p>There is an increased risk of injury.</p> <p>► Visit a qualified specialist workshop.</p>
 <p>Rear Left Malfunction Service Required or Rear Right Malfunction Service Required</p>	<p><b>⚠ WARNING</b></p> <p>The air bags or Emergency Tensioning Devices may either be triggered unintentionally or, in the event of an accident, may not be triggered.</p> <p>There is an increased risk of injury.</p> <p>SRS has malfunctioned at the rear on the left or right. The  warning lamp also lights up in the instrument cluster.</p> <p>► Visit a qualified specialist workshop.</p>
 <p>Left Side Curtain Airbag Malfunction Service Required or Right Side Curtain Airbag Malfunction Service Required</p>	<p>There is a malfunction in the left-hand or right-hand window curtain air bag.</p> <p>The  warning lamp also lights up in the instrument cluster.</p> <p><b>⚠ WARNING</b></p> <p>The left or right window curtain air bag may either be triggered unintentionally or, in the event of an accident, may not be triggered.</p> <p>There is an increased risk of injury.</p> <p>► Visit a qualified specialist workshop.</p>

Display messages	Possible causes/consequences and ► Solutions
<p data-bbox="136 196 332 315">Front Passenger Airbag Disabled See Operator's Manual</p>	<p data-bbox="397 196 1036 253">The front-passenger air bag and front-passenger knee bag are deactivated during the journey, although:</p> <ul data-bbox="404 261 1010 386" style="list-style-type: none"> <li data-bbox="404 261 506 318">• an adult or</li> <li data-bbox="404 329 1010 386">• a person larger than a certain size is occupying the front-passenger seat</li> </ul> <p data-bbox="397 394 1006 451">If additional forces are applied to the seat, the system may interpret the occupant's weight as lower than it actually is.</p> <p data-bbox="409 467 562 496"> <b>WARNING</b></p> <p data-bbox="397 508 1053 565">The front-passenger front air bag and front passenger knee bag may not be triggered in the event of an accident.</p> <p data-bbox="397 573 759 597">There is an increased risk of injury.</p> <ul data-bbox="397 605 1067 922" style="list-style-type: none"> <li data-bbox="397 605 1067 662">► Pull over and stop the vehicle safely as soon as possible, paying attention to road and traffic conditions.</li> <li data-bbox="397 670 969 695">► Secure the vehicle against rolling away (▷ page 167).</li> <li data-bbox="397 703 653 727">► Switch the ignition off.</li> <li data-bbox="397 735 845 760">► Have the occupant get out of the vehicle.</li> <li data-bbox="397 768 1067 824">► Keep the seat unoccupied, close the front-passenger door and switch on the ignition.</li> <li data-bbox="397 833 1041 922">► Observe the PASSENGER AIR BAG OFF indicator lamp in the center console and the multifunction display and check the following:</li> </ul> <p data-bbox="397 938 836 963">Seat unoccupied and ignition switched on:</p> <ul data-bbox="404 979 1067 1182" style="list-style-type: none"> <li data-bbox="404 979 1067 1060">• the PASSENGER AIR BAG OFF indicator lamp must light up and remain lit. If the indicator lamp is on, OCS has disabled the front-passenger air bag and front-passenger knee bag (▷ page 47).</li> <li data-bbox="404 1068 1041 1182">• the <a href="#">Front Passenger Airbag Enabled See Operator's Manual</a> or <a href="#">Front Passenger Airbag Disabled See Operator's Manual</a> display messages must not be shown in the multifunction display.</li> </ul> <ul data-bbox="397 1198 1030 1312" style="list-style-type: none"> <li data-bbox="397 1198 1030 1247">► Wait for a period of at least 60 seconds until the necessary system checks have been completed.</li> <li data-bbox="397 1255 1020 1312">► Make sure that the display messages do not appear in the multifunction display.</li> </ul> <p data-bbox="397 1328 1067 1442">If these conditions are fulfilled, the front-passenger seat can be occupied again. Whether the PASSENGER AIR BAG OFF indicator lamp remains lit or goes out depends on how OCS classifies the occupant.</p> <p data-bbox="397 1450 1020 1498">If the conditions are not fulfilled, the system is not operating correctly.</p>



Display messages	Possible causes/consequences and ► Solutions
	<p>► Visit a qualified specialist workshop immediately.</p> <p>For further information about the Occupant Classification System, see (▷ page 47).</p>
<p>Front Passenger Airbag Enabled See Operator's Manual</p>	<p>The front-passenger air bag and front-passenger knee bag are enabled during the journey, even though:</p> <ul style="list-style-type: none"> <li>• a child, a small adult or an object weighing less than the system's weight threshold is located on the front-passenger seat</li> <li>or</li> <li>• the front-passenger seat is unoccupied</li> </ul> <p>The system may detect objects or forces applying additional weight on the seat.</p> <p> <b>WARNING</b></p> <p>The front-passenger front air bag and front passenger knee bag may be triggered unintentionally.</p> <p>There is an increased risk of injury.</p> <ul style="list-style-type: none"> <li>► Pull over and stop the vehicle safely as soon as possible, paying attention to road and traffic conditions.</li> <li>► Secure the vehicle against rolling away (▷ page 167).</li> <li>► Switch the ignition off.</li> <li>► Open the front-passenger door.</li> <li>► Remove the child and the child restraint system from the front-passenger seat.</li> <li>► Make sure that there are no objects on the seat adding to the weight.</li> </ul> <p>The system may otherwise detect the additional weight and interpret the seat occupant's weight as greater than it actually is.</p> <ul style="list-style-type: none"> <li>► Keep the seat unoccupied, close the front-passenger door and switch on the ignition.</li> <li>► Observe the PASSENGER AIR BAG OFF indicator lamp in the center console and the multifunction display and check the following:</li> </ul> <p>Seat unoccupied and ignition switched on:</p> <ul style="list-style-type: none"> <li>• the PASSENGER AIR BAG OFF indicator lamp must light up and remain lit. If the indicator lamp is on, OCS (Occupant Classification System) has disabled the front-passenger air bag and front-passenger knee bag (▷ page 47).</li> <li>• the <a href="#">Front Passenger Airbag Enabled See Operator's Manual</a> or <a href="#">Front Passenger Airbag Disabled See</a></li> </ul>







Display messages	Possible causes/consequences and ► Solutions
	<p><a href="#">Operator's Manual</a> display messages must not be shown in the multifunction display.</p> <ul style="list-style-type: none"> <li>► Wait for a period of at least 60 seconds until the necessary system checks have been completed.</li> <li>► Make sure that the display messages do not appear in the multifunction display.</li> </ul> <p>If these conditions are fulfilled, the front-passenger seat can be occupied again. Whether the PASSENGER AIR BAG OFF indicator lamp remains lit or goes out depends on how OCS classifies the occupant.</p> <p>If the conditions are not fulfilled, the system is not operating correctly.</p> <ul style="list-style-type: none"> <li>► Visit a qualified specialist workshop immediately.</li> </ul> <p>For further information about the Occupant Classification System, see (► page 47).</p>

### Lights







**i** Display messages about LEDs:

This display message will only appear if all LEDs have failed.

Display messages	Possible causes/consequences and ► Solutions
 <p>Check Left Cornering Light or Check Right Cornering Light</p>	<p>The left or right-hand cornering light is defective.</p> <ul style="list-style-type: none"> <li>► Visit a qualified specialist workshop.</li> </ul>
 <p>Check Left Low Beam or Check Right Low Beam</p>	<p>The left or right-hand low-beam headlamp is defective.</p> <ul style="list-style-type: none"> <li>► Visit a qualified specialist workshop.</li> </ul>
 <p>Check Rear Left Turn Signal or Check Rear Right Turn Signal</p>	<p>The rear left-hand or rear right-hand turn signal is defective.</p> <ul style="list-style-type: none"> <li>► Visit a qualified specialist workshop.</li> </ul>



Display messages	Possible causes/consequences and ► Solutions
 <p>Check Front Left Turn Signal or Check Front Right Turn Signal</p>	<p>The front left-hand or front right-hand turn signal is defective.</p> <ul style="list-style-type: none"> <li>► Visit a qualified specialist workshop.</li> </ul>
 <p>Check Left Mirror Turn Signal or Check Right Mirror Turn Signal</p>	<p>The turn signal in the left-hand or right-hand exterior mirror is defective.</p> <ul style="list-style-type: none"> <li>► Visit a qualified specialist workshop.</li> </ul>
 <p>Check Center Brake Lamp</p>	<p>The high-mounted brake lamp is faulty.</p> <ul style="list-style-type: none"> <li>► Visit a qualified specialist workshop.</li> </ul>
 <p>Check Left Tail and Brake Lamps or Check Right Tail and Brake Lamps</p>	<p>The left or right-hand tail lamp/brake lamp is defective.</p> <ul style="list-style-type: none"> <li>► Visit a qualified specialist workshop.</li> </ul>
 <p>Check Left High Beam or Check Right High Beam</p>	<p>The left or right-hand high beam is defective.</p> <ul style="list-style-type: none"> <li>► Visit a qualified specialist workshop.</li> </ul>
 <p>Rear Fog Lamp</p>	<p>The rear fog lamp is defective.</p> <ul style="list-style-type: none"> <li>► Visit a qualified specialist workshop.</li> </ul>
 <p>Check Front Left Parking Lamp or Check Front Right Parking Lamp</p>	<p>The front left or front right parking or standing lamp is defective.</p> <ul style="list-style-type: none"> <li>► Visit a qualified specialist workshop.</li> </ul>
 <p>Check Left Reverse Lamp or Check Right Reverse Lamp</p>	<p>The left or right-hand backup lamp is defective.</p> <ul style="list-style-type: none"> <li>► Check whether you are permitted to change the bulb yourself.</li> <li>or</li> <li>► Visit a qualified specialist workshop.</li> </ul>







Display messages	Possible causes/consequences and ► Solutions
 <p>Check Front Left Sidemarker Lamp or Check Front Right Sidemarker Lamp</p>	<p>The left or right front side marker lamp is defective.</p> <p>► Visit a qualified specialist workshop.</p>
 <p>Check Rear Left Sidemarker Lamp or Check Rear Right Sidemarker Lamp</p>	<p>The rear left or right side marker lamp is defective.</p> <p>► Visit a qualified specialist workshop.</p>
 <p>Check Left Daytime Running Light or Check Right Daytime Running Light</p>	<p>The left-hand or right-hand daytime running lamp is faulty.</p> <p>► Visit a qualified specialist workshop.</p>
 <p>Active Light System Inoperative</p>	<p>The active light function is defective.</p> <p>► Visit a qualified specialist workshop.</p>
 <p>Malfunction See Operator's Manual</p>	<p>The exterior lighting is defective.</p> <p>► Visit a qualified specialist workshop.</p>
 <p>Auto Lamp Function Inoperative</p>	<p>The light sensor is defective.</p> <p>► Visit a qualified specialist workshop.</p>
 <p>Switch Off Lights</p>	<p>The lights are still switched on when you leave the vehicle. A warning tone also sounds.</p> <p>► Turn the light switch to <b>AUTO</b>.</p>



Display messages	Possible causes/consequences and ► Solutions
Adaptive Highbeam Assist Inoperative	Adaptive Highbeam Assist is faulty. ► Visit a qualified specialist workshop.
Adaptive Highbeam Assist Currently Unavailable See Operator's Manual	Adaptive Highbeam Assist is deactivated and temporarily inoperative. Possible causes are: <ul style="list-style-type: none"> <li>• the windshield in the camera's field of vision is dirty.</li> <li>• visibility is impaired due to heavy rain, snow or fog.</li> </ul> ► Clean the windshield.  If the system detects that the camera is fully operational again, the <b>Adaptive Highbeam Assist Now Available</b> message is displayed.  Adaptive Highbeam Assist is operational again.

## Engine



Display messages	Possible causes/consequences and ► Solutions
 Check Coolant Level See Operator's Manual	The coolant level is too low. <b>!</b> Avoid making long journeys with too little coolant in the engine cooling system. The engine will otherwise be damaged. ► Add coolant, observing the warning notes before doing so (► page 308). ► If coolant needs to be added more often than usual, have the engine coolant system checked at a qualified specialist workshop.
	The fan motor is faulty. ► At coolant temperatures below 248 °F (120 °C), drive to the nearest qualified specialist workshop. ► Avoid subjecting the engine to heavy loads, e.g. driving in mountainous terrain, and stop-and-go traffic.





Display messages	Possible causes/consequences and ► Solutions
 <p data-bbox="138 245 359 331">Coolant Too Hot Stop Vehicle Turn Engine Off</p>	<p data-bbox="397 196 689 256">The coolant is too hot. A warning tone also sounds.</p> <p data-bbox="409 272 562 305"> <b>WARNING</b></p> <p data-bbox="397 318 1067 399">Do not drive when your engine is overheated. This can cause some fluids which may have leaked into the engine compartment to catch fire.</p> <p data-bbox="397 407 1065 464">Steam from the overheated engine can also cause serious burns which can occur just by opening the hood.</p> <p data-bbox="397 472 639 496">There is a risk of injury.</p> <ul data-bbox="397 509 1067 886" style="list-style-type: none"><li>▶ Pull over and stop the vehicle safely and switch off the engine, paying attention to road and traffic conditions.</li><li>▶ Secure the vehicle against rolling away (▷ page 167).</li><li>▶ Wait until the engine has cooled down.</li><li>▶ Make sure that the air supply to the engine radiator is not blocked, e.g. by snow, slush or ice.</li><li>▶ Do not start the engine again until the display message goes out and the coolant temperature is below 248 °F (120 °C). Otherwise, the engine could be damaged.</li><li>▶ Pay attention to the coolant temperature display.</li><li>▶ If the temperature increases again, visit a qualified specialist workshop immediately.</li></ul> <p data-bbox="397 902 1067 961">Under normal operating conditions and with the specified coolant level, the coolant temperature may rise to 248 °F (120 °C).</p>

Display messages	Possible causes/consequences and ► Solutions
	<p>The battery is not being charged. A warning tone also sounds.</p> <p>Possible causes are:</p> <ul style="list-style-type: none"> <li>• a defective alternator</li> <li>• a torn poly-V-belt</li> <li>• a malfunction in the electronics</li> </ul> <p>► Pull over and stop the vehicle safely and switch off the engine, paying attention to road and traffic conditions.</p> <p>► Secure the vehicle against rolling away (▷ page 167).</p> <p>► Open the hood.</p> <p>► Check whether the poly-V-belt is torn.</p> <p><b>If the poly-V-belt is torn:</b></p> <p><b>!</b> Do not continue driving. The engine could otherwise overheat.</p> <p>► Consult a qualified specialist workshop.</p> <p><b>If the poly-V-belt is not damaged:</b></p> <p>► Visit a qualified specialist workshop.</p>
 <p>Check Engine Oil Level At Next Refueling</p>	<p>The engine oil level has dropped to the minimum level. A warning tone also sounds.</p> <p>► Check the oil level when next refueling, at the latest (▷ page 307).</p> <p>► If necessary, add engine oil (▷ page 308).</p> <p>► Have the engine checked at a qualified specialist workshop if engine oil needs to be added more often than usual.</p> <p><b>!</b> Avoid long journeys with too little engine oil. The engine will otherwise be damaged.</p> <p>Information on approved engine oils can be obtained from any qualified specialist workshop or on the Internet at <a href="http://bevo.mercedes-benz.com">http://bevo.mercedes-benz.com</a>.</p>



Display messages	Possible causes/consequences and ► Solutions
 Check Engine Oil Level (Add 1 quart)	<p>AMG vehicles: the engine oil level is too low.</p> <ul style="list-style-type: none"> <li>► Check the oil level when next refueling, at the latest (► page 307).</li> <li>► If necessary, add engine oil (► page 308).</li> <li>► Have the engine checked at a qualified specialist workshop if engine oil needs to be added more often than usual.</li> </ul> <p><b>!</b> Avoid long journeys with too little engine oil. The engine will otherwise be damaged.</p> <p>Information on approved engine oils can be obtained from any qualified specialist workshop or on the Internet at <a href="http://bevo.mercedes-benz.com">http://bevo.mercedes-benz.com</a>.</p>
 Fuel Level Low	<p>The fuel level has dropped into the reserve range.</p> <ul style="list-style-type: none"> <li>► Refuel at the nearest gas station.</li> </ul>
 Gas Cap Loose	<p>There is only a very small amount of fuel in the fuel tank.</p> <ul style="list-style-type: none"> <li>► Refuel at the nearest gas station without fail.</li> </ul> <p>The fuel system pressure is too low. The fuel filler cap is not closed correctly or the fuel system is leaking.</p> <ul style="list-style-type: none"> <li>► Check that the fuel filler cap is correctly closed.</li> </ul> <p><b>If the fuel filler cap is not correctly closed:</b></p> <ul style="list-style-type: none"> <li>► Close the fuel filler cap.</li> </ul> <p><b>If the fuel filler cap is correctly closed:</b></p> <ul style="list-style-type: none"> <li>► Visit a qualified specialist workshop.</li> </ul>

## Driving systems

Display messages	Possible causes/consequences and ► Solutions
 Attention Assist: Take a Break!	<p>Based on certain criteria, ATTENTION ASSIST has detected fatigue or a lack of concentration on the part of the driver. A warning tone also sounds.</p> <ul style="list-style-type: none"> <li>► If necessary, take a break.</li> </ul> <p>During long journeys, take regular breaks in good time so you get enough rest.</p>
 Attention Assist Inoperative	<p>ATTENTION ASSIST is inoperative.</p> <ul style="list-style-type: none"> <li>► Visit a qualified specialist workshop.</li> </ul>

Display messages	Possible causes/consequences and ► Solutions
 <p>Vehicle Rising</p>	<p>Your vehicle is adjusting to the level you have selected.</p>
 <p>Vehicle Rising Please Wait</p>	<p>The vehicle level is too low when the vehicle is stationary. A warning tone also sounds.</p> <ul style="list-style-type: none"> <li>► Do not pull away. The vehicle level is set when the display message disappears.</li> </ul>
 <p>Stop Vehicle Vehicle Too Low</p>	<p>You have pulled away while the vehicle level is still too low. AIRMATIC sets the vehicle to the selected level after a short period.</p> <ul style="list-style-type: none"> <li>► Pull over and stop the vehicle safely as soon as possible, paying attention to road and traffic conditions.</li> <li>► Secure the vehicle against rolling away (▷ page 167).</li> <li>► Wait until the display message disappears before pulling away.</li> </ul> <p>AIRMATIC is defective. A warning tone also sounds.</p> <ul style="list-style-type: none"> <li>► Do not drive at speeds above 50 mph (80 km/h).</li> <li>► Make only slight steering movements. Otherwise, the front fender or the tires could be damaged if the steering movement is too large.</li> <li>► Listen for scraping sounds.</li> <li>► Pull over and stop the vehicle safely, paying attention to road and traffic conditions, and select a higher vehicle level. Depending on the malfunction, it may be possible to raise the vehicle.</li> <li>► Visit a qualified specialist workshop.</li> </ul>
 <p>Malfunction</p>	<p>The AIRMATIC function is restricted. The vehicle's handling characteristics may be affected.</p> <ul style="list-style-type: none"> <li>► Do not drive at speeds above 50 mph (80 km/h).</li> <li>► Visit a qualified specialist workshop.</li> </ul>
<p><b>HOLD</b></p> <p>Off</p>	<p>The HOLD function is deactivated. The vehicle is skidding. A warning tone also sounds.</p> <ul style="list-style-type: none"> <li>► Reactivate the HOLD function later (▷ page 186).</li> </ul>
<p>Radar Sensors Deactivated See Operator's Manual</p>	<p>The radar sensor system is deactivated.</p> <ul style="list-style-type: none"> <li>► Switch on the radar sensor system (▷ page 232).</li> </ul>

Display messages	Possible causes/consequences and ► Solutions
<p>Lane Keeping Assist Currently Unavailable See Operator's Manual or Active Lane Keeping Assist Currently Unavailable See Operator's Manual</p>	<p>Lane Keeping Assist or Active Lane Keeping Assist is deactivated and temporarily inoperative. Possible causes are:</p> <ul style="list-style-type: none"> <li>• the windshield in the camera's field of vision is dirty.</li> <li>• visibility is impaired due to heavy rain, snow or fog.</li> <li>• there are no lane markings for a longer period.</li> <li>• the lane markings are worn, dark or covered, e.g. by dirt or snow.</li> </ul> <p>When the causes stated above no longer apply, the display message disappears.</p> <p>Lane Keeping Assist or Active Lane Keeping Assist is operational again.</p> <p>If the display message does not disappear:</p> <ul style="list-style-type: none"> <li>► Pull over and stop the vehicle safely as soon as possible, paying attention to road and traffic conditions.</li> <li>► Secure the vehicle against rolling away (► page 167).</li> <li>► Clean the windshield.</li> </ul>
<p>Lane Keeping Assist Inoperative or Active Lane Keeping Assist Inoperative</p>	<p>Lane Keeping Assist or Active Lane Keeping Assist is defective.</p> <ul style="list-style-type: none"> <li>► Visit a qualified specialist workshop.</li> </ul>

Display messages	Possible causes/consequences and ► Solutions
<p>Blind Spot Assist Currently Unavailable See Operator's Manual or Active Blind Spot Assist Currently Unavailable See Operator's Manual</p>	<p>Blind Spot Assist or Active Blind Spot Assist is temporarily inoperative. Possible causes are:</p> <ul style="list-style-type: none"> <li>• the sensors are dirty.</li> <li>• function is impaired due to heavy rain or snow.</li> <li>• the radar sensor system is outside the operating temperature range.</li> <li>• the radar sensor system is temporarily inoperative, e.g. due to electromagnetic radiation emitted by nearby TV or radio stations or other sources of electromagnetic radiation.</li> </ul> <p>The yellow  indicator lamps also light up in the exterior mirrors.</p> <p>When the causes stated above no longer apply, the display message disappears.</p> <p>Blind Spot Assist or Active Blind Spot Assist is operational again.</p> <p>If the display message does not disappear:</p> <ul style="list-style-type: none"> <li>► Pull over and stop the vehicle safely as soon as possible, paying attention to road and traffic conditions.</li> <li>► Secure the vehicle against rolling away (&gt; page 167).</li> <li>► Clean the sensors (&gt; page 315).</li> <li>► Restart the engine.</li> </ul>
<p>Blind Spot Assist Inoperative or Active Blind Spot Assist Inoperative</p>	<p>Blind Spot Assist or Active Blind Spot Assist is defective.</p> <p>The yellow  indicator lamps also light up in the exterior mirrors.</p> <ul style="list-style-type: none"> <li>► Visit a qualified specialist workshop.</li> </ul>
<p>Park Assist Canceled</p>	<p>The driver's door is open and the driver's seat belt has not been fastened.</p> <ul style="list-style-type: none"> <li>► Repeat the parking process with the seat belt fastened and the driver's door closed.</li> </ul> <p>You have inadvertently touched the multifunction steering wheel while steering intervention was active.</p> <ul style="list-style-type: none"> <li>► While steering intervention is active, make sure that the multifunction steering wheel is not touched unintentionally.</li> </ul> <p>The vehicle has started to skid and ESP® has intervened.</p> <ul style="list-style-type: none"> <li>► Use Active Parking Assist again later (&gt; page 196).</li> </ul>





Display messages	Possible causes/consequences and ► Solutions
Park Assist Inoperative	<p>You have just carried out a large number of turning or parking maneuvers.</p> <p>Active Parking Assist will become available again after approximately ten minutes (▷ page 196).</p> <ul style="list-style-type: none"> <li>► Pull over and stop the vehicle safely as soon as possible, paying attention to road and traffic conditions.</li> <li>► Switch off and restart the engine.</li> </ul> <p>If the display message continues to be displayed:</p> <ul style="list-style-type: none"> <li>► Visit a qualified specialist workshop.</li> </ul> <p>PARKTRONIC is defective.</p> <ul style="list-style-type: none"> <li>► Visit a qualified specialist workshop.</li> </ul>
Park Assist Finished	<p>The vehicle is parked. A warning tone also sounds. The display message disappears automatically.</p>
DISTRONIC PLUS Off	<p>DISTRONIC PLUS has been deactivated (▷ page 177). If it was not deactivated by the driver, a warning tone also sounds.</p>
DISTRONIC PLUS Now Available	<p>DISTRONIC PLUS is operational again after having been temporarily unavailable. You can now reactivate DISTRONIC PLUS (▷ page 177).</p>

Display messages	Possible causes/consequences and ► Solutions
<p>DISTRONIC PLUS Currently Unavailable See Operator's Manual</p>	<p>DISTRONIC PLUS is temporarily inoperative. Possible causes are:</p> <ul style="list-style-type: none"> <li>• function is impaired due to heavy rain or snow.</li> <li>• the sensors in the radiator grill and the bumper are dirty.</li> <li>• the radar sensor system is temporarily inoperative, e.g. due to electromagnetic radiation emitted by nearby TV or radio stations or other sources of electromagnetic radiation.</li> <li>• the system is outside the operating temperature range.</li> <li>• the on-board voltage is too low.</li> </ul> <p>A warning tone also sounds. When the causes stated above no longer apply, the display message disappears. DISTRONIC is operational again. If the display message does not disappear:</p> <ul style="list-style-type: none"> <li>► Pull over and stop the vehicle safely as soon as possible, paying attention to road and traffic conditions.</li> <li>► Secure the vehicle against rolling away (▷ page 167).</li> <li>► Clean the sensors in the radiator grill and the bumper (▷ page 315).</li> <li>► Restart the engine.</li> </ul>
<p>DISTRONIC PLUS Inoperative</p>	<p>DISTRONIC PLUS is defective. The following may have also failed:</p> <ul style="list-style-type: none"> <li>• BAS PLUS (Brake Assist System PLUS)</li> <li>• PRE-SAFE® Brake</li> </ul> <p>A warning tone also sounds.</p> <ul style="list-style-type: none"> <li>► Visit a qualified specialist workshop.</li> </ul>
<p>DISTRONIC PLUS Suspended</p>	<p>You have depressed the accelerator pedal. DISTRONIC PLUS is no longer controlling the speed of the vehicle.</p> <ul style="list-style-type: none"> <li>► Remove your foot from the accelerator pedal.</li> </ul>
<p>DISTRONIC PLUS - - - mph</p>	<p>An activation condition for DISTRONIC PLUS is not fulfilled.</p> <ul style="list-style-type: none"> <li>► Check the activation conditions for DISTRONIC PLUS (▷ page 177).</li> </ul>

Display messages	Possible causes/consequences and ► Solutions
Cruise Control Inoperative	Cruise control is defective. A warning tone also sounds. ► Visit a qualified specialist workshop.
Cruise Control - - - mph	A condition for activating cruise control has not been fulfilled. You have tried to store a speed below 20 mph (30 km/h), for example. ► If conditions permit, drive faster than 20 mph (30 km/h) and store the speed. ► Check the activation conditions for cruise control (► page 175).

## Tires





Display messages	Possible causes/consequences and ► Solutions
Check Tire Pressure Soon	<p>The tire pressure loss warning system has detected a significant loss in pressure.</p> <p>A warning tone also sounds.</p> <p> <b>WARNING</b></p> <p>With tire pressures which are too low, there is a risk of the following hazards:</p> <ul style="list-style-type: none"> <li>• they may burst, especially as the load and vehicle speed increase.</li> <li>• they may wear excessively and/or unevenly, which may greatly impair tire traction.</li> <li>• the driving characteristics, as well as steering and braking, may be greatly impaired.</li> </ul> <p>There is a risk of an accident.</p> <ul style="list-style-type: none"> <li>► Stop the vehicle without making any sudden steering or braking maneuvers. Pay attention to the traffic conditions as you do so.</li> <li>► Secure the vehicle against rolling away (▷ page 167).</li> <li>► Check the tires and, if necessary, follow the instructions for a flat tire (▷ page 321).</li> <li>► Check the tire pressures and, if necessary, correct the tire pressure.</li> <li>► Restart the tire pressure loss warning system when the tire pressure is correct (▷ page 342).</li> </ul>
Check Tire Pressure Then Restart Run Flat Indicator	<p>The tire pressure loss warning system generated a display message and has not been restarted since.</p> <ul style="list-style-type: none"> <li>► Set the correct tire pressure in all four tires.</li> <li>► Restart the tire pressure loss warning system (▷ page 342).</li> </ul>
Run Flat Indicator Inoperative	<p>The tire pressure loss warning system is faulty.</p> <ul style="list-style-type: none"> <li>► Visit a qualified specialist workshop.</li> </ul>
Rectify Tire Pressure	<p>The tire pressure is too low in at least one of the tires, or the tire pressure difference between the wheels is too great.</p> <ul style="list-style-type: none"> <li>► Check the tire pressures at the next opportunity (▷ page 342).</li> <li>► If necessary, correct the tire pressure.</li> <li>► Restart the tire pressure monitor (▷ page 345).</li> </ul>



Display messages	Possible causes/consequences and ► Solutions
<p>Check Tires</p>	<p>The tire pressure in one or more tires has dropped significantly. The wheel position is displayed in the multifunction display. A warning tone also sounds.</p> <p> <b>WARNING</b></p> <p>With tire pressures which are too low, there is a risk of the following hazards:</p> <ul style="list-style-type: none"> <li>• they may burst, especially as the load and vehicle speed increase.</li> <li>• they may wear excessively and/or unevenly, which may greatly impair tire traction.</li> <li>• the driving characteristics, as well as steering and braking, may be greatly impaired.</li> </ul> <p>There is a risk of an accident.</p> <ul style="list-style-type: none"> <li>► Stop the vehicle without making any sudden steering or braking maneuvers. Pay attention to the traffic conditions as you do so.</li> <li>► Secure the vehicle against rolling away (▷ page 167).</li> <li>► Check the tires and, if necessary, follow the instructions for a flat tire (▷ page 321).</li> <li>► Check the tire pressure (▷ page 342).</li> <li>► If necessary, correct the tire pressure.</li> </ul>
<p>Warning Tire Malfunction</p>	<p>The tire pressure in one or more tires has dropped suddenly. The wheel position is shown in the multifunction display.</p> <p> <b>WARNING</b></p> <p>If you drive with a flat tire, there is a risk of the following hazards:</p> <ul style="list-style-type: none"> <li>• a flat tire affects the ability to steer or brake the vehicle.</li> <li>• you could lose control of the vehicle.</li> <li>• continued driving with a flat tire will cause excessive heat build-up and possibly a fire.</li> </ul> <p>There is a risk of an accident.</p> <ul style="list-style-type: none"> <li>► Stop the vehicle without making any sudden steering or braking maneuvers. Pay attention to the traffic conditions as you do so.</li> <li>► Secure the vehicle against rolling away (▷ page 167).</li> <li>► Check the tires and, if necessary, follow the instructions for a flat tire (▷ page 321).</li> </ul>

Display messages	Possible causes/consequences and ► Solutions
Tire Press. Monitor Currently Unavailable	Due to a source of radio interference, no signals can be received from the wheel sensors. The tire pressure monitor is temporarily malfunctioning. ► Drive on. The tire pressure monitor restarts automatically as soon as the problem has been solved.
TirePress. Sensor(s) Missing	There is no signal from the tire pressure sensor of one or several wheels. The pressure of the affected tire is not displayed in the multifunction display. ► Have the faulty tire pressure sensor replaced at a qualified specialist workshop.
Tire Pressure Monitor Inoperative No Wheel Sensors	The wheels mounted do not have a suitable tire pressure sensor. The tire pressure monitor is deactivated. ► Mount wheels with suitable tire pressure sensors. The tire pressure monitor is activated automatically after driving for a few minutes.
Tire Press. Monitor Inoperative	The tire pressure monitor is faulty. ► Visit a qualified specialist workshop.





## Vehicle

Display messages	Possible causes/consequences and ► Solutions
Shift to 'P' or 'N' To Start Engine	You have attempted to start the engine with the transmission in position <b>R</b> or <b>D</b> . ► Shift the transmission to position <b>P</b> or <b>N</b> .
Auxiliary Battery Malfunction	The auxiliary battery for the automatic transmission is no longer being charged. ► Visit a qualified specialist workshop.
Apply Brake to Shift from 'P'	You have attempted to move the transmission selector lever to position <b>D</b> , <b>R</b> or <b>N</b> without depressing the brake pedal. ► Depress the brake pedal.
Risk of Rolling Away Vehicle Not in 'P'	The driver's door is open and the transmission is in position <b>R</b> , <b>N</b> or <b>D</b> . A warning tone also sounds. ► Shift the transmission to position <b>P</b> . ► Secure the vehicle against rolling away (▷ page 167).





Display messages	Possible causes/consequences and ► Solutions
<p>Service Required Do Not Shift Gears Visit Dealer</p>	<p>You cannot change the transmission position due to a malfunction. A warning tone also sounds.</p> <p>If transmission position <b>D</b> is selected:</p> <ul style="list-style-type: none"> <li>► Drive to a qualified specialist workshop without shifting the transmission from position <b>D</b>.</li> </ul> <p>If transmission position <b>R</b>, <b>N</b> or <b>P</b> is selected:</p> <ul style="list-style-type: none"> <li>► Notify a qualified specialist workshop or breakdown service.</li> </ul>
<p>Only Shift to 'P' when Vehicle is Stationary</p>	<p>The vehicle is moving.</p> <ul style="list-style-type: none"> <li>► Pull over and stop the vehicle safely as soon as possible, paying attention to road and traffic conditions.</li> <li>► Shift the transmission to position <b>P</b>.</li> </ul>
	<p>the trunk lid is open.</p> <ul style="list-style-type: none"> <li>► Close the trunk lid.</li> </ul>
	<p>The hood is open. A warning tone also sounds.</p> <p><b>⚠ WARNING</b></p> <p>The open hood may block your view when the vehicle is in motion. There is a risk of an accident.</p> <ul style="list-style-type: none"> <li>► Pull over and stop the vehicle safely as soon as possible, paying attention to road and traffic conditions.</li> <li>► Secure the vehicle against rolling away (▷ page 167).</li> <li>► Close the hood.</li> </ul>
	<p>At least one door is open. A warning tone also sounds.</p> <ul style="list-style-type: none"> <li>► Close all the doors.</li> </ul>
 <p>Rear Left Backrest Not Latched or Rear Right Backrest Not Latched</p>	<p>The backrest in the rear is not engaged on the left-hand and/or right-hand side. A warning tone also sounds.</p> <ul style="list-style-type: none"> <li>► Push the backrest back until it engages.</li> </ul>
 <p>Lock Seat Backrest Front Left or Lock Seat Backrest Front Right</p>	<p>The driver's or front passenger's seat backrest is not engaged. A warning tone also sounds.</p> <ul style="list-style-type: none"> <li>► Push the backrest back until it engages.</li> </ul>



Display messages	Possible causes/consequences and ► Solutions
 <p>Power Steering Malfunction See Operator's Manual</p>	<p>The power steering is malfunctioning. A warning tone also sounds.</p> <p> <b>WARNING</b></p> <p>You will need to use more force to steer. There is a risk of an accident.</p> <ul style="list-style-type: none"> <li>► Check whether you are able to apply the extra force required.</li> <li>► <b>If you are able to steer safely:</b> carefully drive on to a qualified specialist workshop.</li> <li>► <b>If you are unable to steer safely:</b> do not drive on. Contact the nearest qualified specialist workshop.</li> </ul>
<p>Phone No Service</p>	<p>Your vehicle is outside the network provider's transmitter/receiver range.</p> <ul style="list-style-type: none"> <li>► Wait until the mobile phone operational readiness symbol appears in the multifunction display.</li> </ul>
 <p>Check Washer Fluid</p>	<p>The washer fluid level in the washer fluid reservoir has dropped below the minimum.</p> <ul style="list-style-type: none"> <li>► Add washer fluid (► page 309).</li> </ul>

### SmartKey

Display messages	Possible causes/consequences and ► Solutions
 <p>Key Does Not Belong to Vehicle</p>	<p>You have put the wrong SmartKey in the ignition lock.</p> <ul style="list-style-type: none"> <li>► Use the correct SmartKey.</li> </ul>
 <p>Take Your Key from Ignition</p>	<p>The SmartKey is in the ignition lock.</p> <ul style="list-style-type: none"> <li>► Remove the SmartKey.</li> </ul>
 <p>Obtain a New Key</p>	<p>The SmartKey needs to be replaced.</p> <ul style="list-style-type: none"> <li>► Visit a qualified specialist workshop.</li> </ul>
 <p>Replace Key Battery</p>	<p>The batteries of the KEYLESS-GO key are discharged.</p> <ul style="list-style-type: none"> <li>► Change the batteries (► page 79).</li> </ul>















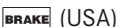



Display messages	Possible causes/consequences and ► Solutions
 <p data-bbox="136 245 359 305">Don't Forget Your Key</p>	<p data-bbox="397 196 1065 253">The display message is shown for a maximum of 60 seconds and is only a reminder.</p> <p data-bbox="397 261 1056 318">You have opened the driver's door with the engine switched off. The KEYLESS-GO key is not in the ignition lock.</p> <ul style="list-style-type: none"> <li data-bbox="397 326 1032 383">► Remember to take the KEYLESS-GO key with you when you leave the vehicle.</li> </ul>
 <p data-bbox="136 456 359 516">Key Not Detected (red display message)</p>	<p data-bbox="397 407 830 431">The KEYLESS-GO key is not in the vehicle.</p> <p data-bbox="397 440 689 464">A warning tone also sounds.</p> <p data-bbox="397 472 1047 529">If the engine is switched off, you can no longer lock the vehicle centrally or start the engine.</p> <ul style="list-style-type: none"> <li data-bbox="397 537 1065 594">► Pull over and stop the vehicle safely as soon as possible, paying attention to road and traffic conditions.</li> <li data-bbox="397 602 969 626">► Secure the vehicle against rolling away (▷ page 167).</li> <li data-bbox="397 634 718 659">► Locate the KEYLESS-GO key.</li> </ul> <p data-bbox="397 691 1065 781">The KEYLESS-GO key is not detected while the engine is running because there is interference from a strong source of radio waves. A warning tone also sounds.</p> <ul style="list-style-type: none"> <li data-bbox="397 789 1065 846">► Pull over and stop the vehicle safely as soon as possible, paying attention to road and traffic conditions.</li> <li data-bbox="397 854 969 878">► Secure the vehicle against rolling away (▷ page 167).</li> <li data-bbox="397 886 1020 911">► Operate the vehicle with the SmartKey in the ignition lock.</li> </ul>
 <p data-bbox="136 992 348 1081">Key Not Detected (white display message)</p>	<p data-bbox="397 943 941 967">The KEYLESS-GO key cannot be detected at present.</p> <ul style="list-style-type: none"> <li data-bbox="397 976 1030 1032">► Change the location of the SmartKey with the KEYLESS-GO functions in the vehicle.</li> </ul> <p data-bbox="397 1049 844 1073">If the KEYLESS-GO key is still not detected:</p> <ul style="list-style-type: none"> <li data-bbox="397 1089 1020 1114">► Operate the vehicle with the SmartKey in the ignition lock.</li> </ul>
 <p data-bbox="136 1192 336 1248">Key Detected in Vehicle</p>	<p data-bbox="397 1143 1065 1200">The KEYLESS-GO key has been detected inside the vehicle during locking.</p> <ul style="list-style-type: none"> <li data-bbox="397 1208 906 1232">► Remove the KEYLESS-GO key from the vehicle.</li> </ul>

Display messages	Possible causes/consequences and ► Solutions
 Remove 'Start' Button and Insert Key	The KEYLESS-GO key can continuously not be detected. KEYLESS-GO is temporarily malfunctioning or is defective. A warning tone also sounds. <ul style="list-style-type: none"> <li>► Insert the SmartKey into the ignition lock and turn it to the desired position.</li> <li>► Visit a qualified specialist workshop.</li> </ul>
 Close Doors to Lock Vehicle	At least one door is open. A warning tone also sounds. <ul style="list-style-type: none"> <li>► Close all doors and lock the vehicle again.</li> </ul>





### Indicator and warning lamps in the instrument cluster

#### Warning and indicator lamps overview







-  Low-beam headlamps (▷ page 118)
-  Parking lamps (▷ page 118)
-  High-beam headlamps (▷ page 119)
-  Turn signal (▷ page 119)
-  Seat belts (▷ page 265)
-  BRAKE (USA) Brakes (▷ page 266)
-  (D) (Canada) Brakes (▷ page 266)
-  ABS (▷ page 267)
-  ESP® (▷ page 269)
-  ESP® OFF (▷ page 269)
-  SPORT handling mode in AMG vehicles (▷ page 270)
-  SRS (▷ page 272)
-  Check Engine (▷ page 273)
-  Reserve fuel (▷ page 273)
-  Coolant (▷ page 273)
-  Distance warning signal (▷ page 275)
-  Tire pressure monitor (▷ page 276)



## Safety



## Seat belts









Problem	Possible causes/consequences and ► Solutions
 <p>After starting the engine, the red seat belt warning lamp lights up for 6 seconds.</p>	<p>The seat belt warning lamp reminds the driver and front passenger to fasten their seat belts.</p> <ul style="list-style-type: none"> <li>► Fasten your seat belt (▷ page 56).</li> </ul>
 <p>After starting the engine, the red seat belt warning lamp lights up. In addition, a warning tone sounds for up to six seconds.</p>	<p>The driver's seat belt is not fastened.</p> <ul style="list-style-type: none"> <li>► Fasten your seat belt (▷ page 56). The warning tone ceases.</li> </ul>
 <p>The red seat belt warning lamp lights up after the engine starts, as soon as the driver's or the front-passenger door is closed.</p>	<p>The driver or front passenger has not fastened their seat belt.</p> <ul style="list-style-type: none"> <li>► Fasten your seat belt (▷ page 56). The warning lamp goes out.</li> </ul> <p>There are objects on the front-passenger seat.</p> <ul style="list-style-type: none"> <li>► Remove the objects from the front-passenger seat and stow them in a secure place. The warning lamp goes out.</li> </ul>
 <p>The red seat belt warning lamp flashes and an intermittent audible warning sounds.</p>	<p>The driver or front passenger has not fastened their seat belt. You are driving faster than 15 mph (25 km/h) or have briefly driven faster than 15 mph (25 km/h).</p> <ul style="list-style-type: none"> <li>► Fasten your seat belt (▷ page 56). The warning lamp goes out and the intermittent warning tone ceases.</li> </ul> <p>There are objects on the front-passenger seat. You are driving faster than 15 mph (25 km/h) or have briefly driven faster than 15 mph (25 km/h).</p> <ul style="list-style-type: none"> <li>► Remove the objects from the front-passenger seat and stow them in a secure place. The warning lamp goes out and the intermittent warning tone ceases.</li> </ul>





**Safety systems**

Problem	Possible causes/consequences and ► Solutions
<p> (USA only)   (Canada only)                      The red brake system warning lamp comes on while the engine is running. A warning tone also sounds.</p>	<p> <b>WARNING</b></p> <p>The brake boosting effect is malfunctioning and the braking characteristics may be affected.                      There is a risk of an accident.</p> <ul style="list-style-type: none"> <li>► Pull over and stop the vehicle safely as soon as possible, paying attention to road and traffic conditions. Do not continue driving under any circumstances.</li> <li>► Secure the vehicle against rolling away (► page 167).</li> <li>► Consult a qualified specialist workshop.</li> <li>► Observe the additional display messages in the multifunction display.</li> </ul>
<p> (USA only)   (Canada only)                      The red brake system warning lamp comes on while the engine is running. A warning tone also sounds.</p>	<p>There is not enough brake fluid in the brake fluid reservoir.</p> <p> <b>WARNING</b></p> <p>The braking effect may be impaired.                      There is a risk of an accident.</p> <ul style="list-style-type: none"> <li>► Pull over and stop the vehicle safely as soon as possible, paying attention to road and traffic conditions. Do not continue driving under any circumstances.</li> <li>► Secure the vehicle against rolling away (► page 167).</li> <li>► Do not add brake fluid. Adding more will not remedy the malfunction.</li> <li>► Consult a qualified specialist workshop.</li> <li>► Observe the additional display messages in the multifunction display.</li> </ul>





Problem	Possible causes/consequences and ► Solutions
 <p>The yellow ABS warning lamp is lit while the engine is running.</p>	<p>ABS (Anti-lock Braking System) is deactivated due to a malfunction. BAS (Brake Assist), BAS PLUS, ESP® (Electronic Stability Program), PRE-SAFE®, PRE-SAFE® Brake, the HOLD function and hill start assist are therefore also deactivated, for example.</p> <p>ATTENTION ASSIST is deactivated.</p> <p> <b>WARNING</b></p> <p>The brake system continues to function normally, but without the functions listed above. The wheels could therefore lock if you brake hard, for example.</p> <p>The steerability and braking characteristics may be severely affected. The braking distance in an emergency braking situation can increase.</p> <p>If ESP® is not operational, ESP® is unable to stabilize the vehicle. There is an increased risk of skidding and an accident.</p> <ul style="list-style-type: none"> <li>► Observe the additional display messages in the multifunction display.</li> <li>► Drive on carefully.</li> <li>► Visit a qualified specialist workshop.</li> </ul> <p>If the ABS control unit is faulty, there is also a possibility that other systems, such as the navigation system or the automatic transmission, will not be available.</p>





Problem	Possible causes/consequences and ► Solutions
 <p>The yellow ABS warning lamp is lit while the engine is running.</p>	<p>ABS is temporarily unavailable. BAS, BAS PLUS, ESP<sup>®</sup>, EBD (electronic brake force distribution), PRE-SAFE<sup>®</sup>, PRE-SAFE<sup>®</sup> Brake, the HOLD function, hill start assist are therefore also deactivated, for example.</p> <p>Possible causes are:</p> <ul style="list-style-type: none"> <li>• self-diagnosis is not yet complete.</li> <li>• the on-board voltage may be insufficient.</li> </ul> <p>ATTENTION ASSIST is deactivated.</p> <p> <b>WARNING</b></p> <p>The brake system continues to function normally, but without the functions listed above. The front and rear wheels could therefore lock if you brake hard, for example.</p> <p>The steerability and braking characteristics may be severely affected. The braking distance in an emergency braking situation can increase.</p> <p>If ESP<sup>®</sup> is not operational, ESP<sup>®</sup> is unable to stabilize the vehicle. There is a risk of an accident.</p> <ul style="list-style-type: none"> <li>► Carefully drive on a suitable stretch of road, making slight steering movements at a speed above 12 mph (20 km/h). The functions mentioned above are available again when the warning lamp goes out.</li> </ul> <p>If the warning lamp is still on:</p> <ul style="list-style-type: none"> <li>► Observe the additional display messages in the multifunction display.</li> <li>► Drive on carefully.</li> <li>► Visit a qualified specialist workshop.</li> </ul>





Problem	Possible causes/consequences and ► Solutions
 <p>The yellow ABS warning lamp is lit while the engine is running. A warning tone also sounds.</p>	<p>EBD is not available due to a malfunction. Therefore, ABS, BAS, BAS PLUS, ESP®, PRE-SAFE®, PRE-SAFE® Brake, the HOLD function and hill start assist are also unavailable, for example. ATTENTION ASSIST is deactivated.</p> <p> <b>WARNING</b></p> <p>The brake system continues to function normally, but without the functions listed above. The front and rear wheels could therefore lock if you brake hard, for example.</p> <p>The steerability and braking characteristics may be severely affected. The braking distance in an emergency braking situation can increase.</p> <p>If ESP® is not operational, ESP® is unable to stabilize the vehicle. There is an increased risk of skidding and an accident.</p> <ul style="list-style-type: none"> <li>► Observe the additional display messages in the multifunction display.</li> <li>► Drive on carefully.</li> <li>► Visit a qualified specialist workshop.</li> </ul>
<p> (USA only)</p> <p> (Canada only)</p> <p>  </p> <p>The red brake warning lamp, the yellow ESP® and ESP® OFF warning lamps and the yellow ABS warning lamp are lit while the engine is running.</p>	<p>ABS and ESP® are not available due to a malfunction. Therefore, BAS, BAS PLUS, EBD, PRE-SAFE®, PRE-SAFE® Brake, the HOLD function and hill start assist, for example, are not available either. ATTENTION ASSIST is deactivated.</p> <p> <b>WARNING</b></p> <p>The brake system continues to function normally, but without the functions listed above. The front and rear wheels could therefore lock if you brake hard, for example.</p> <p>The steerability and braking characteristics may be severely affected. The braking distance in an emergency braking situation can increase.</p> <p>If ESP® is not operational, ESP® is unable to stabilize the vehicle. There is an increased risk of skidding and an accident.</p> <ul style="list-style-type: none"> <li>► Observe the additional display messages in the multifunction display.</li> <li>► Drive on carefully.</li> <li>► Visit a qualified specialist workshop.</li> </ul>



Problem	Possible causes/consequences and ► Solutions
 <p>The yellow ESP® warning lamp flashes while the vehicle is in motion.</p>	<p>ESP® or traction control has intervened because there is a risk of skidding or at least one wheel has started to spin. Cruise control or DISTRONIC PLUS is deactivated.</p> <ul style="list-style-type: none"> <li>► When pulling away, only depress the accelerator pedal as far as necessary.</li> <li>► Ease off the accelerator pedal while the vehicle is in motion.</li> <li>► Adapt your driving style to suit the road and weather conditions.</li> <li>► Do not deactivate ESP®.</li> </ul> <p>For exceptions, see: (▷ page 68).</p>
 <p>The yellow ESP® OFF warning lamp is lit while the engine is running.</p>	<p>ESP® is deactivated.</p> <p> <b>WARNING</b></p> <p>If ESP® is switched off, ESP® is unable to stabilize the vehicle. There is an increased risk of skidding and an accident.</p> <ul style="list-style-type: none"> <li>► Reactivate ESP®.</li> </ul> <p>For exceptions, see: (▷ page 68).</p> <ul style="list-style-type: none"> <li>► Adapt your driving style to suit the road and weather conditions.</li> </ul> <p>If ESP® cannot be activated:</p> <ul style="list-style-type: none"> <li>► Drive on carefully.</li> <li>► Have ESP® checked at a qualified specialist workshop.</li> </ul>
 <p>AMG vehicles only: The yellow SPORT handling mode warning lamp is lit while the engine is running.</p>	<p>SPORT handling mode is activated.</p> <p> <b>WARNING</b></p> <p>When SPORT handling mode is switched on, ESP® is unable to stabilize the vehicle. There is an increased risk of skidding and an accident.</p> <ul style="list-style-type: none"> <li>► Only switch to SPORT handling mode in accordance with the conditions described in the "Activating/deactivating SPORT handling mode" section (▷ page 70).</li> </ul>



Problem	Possible causes/consequences and ► Solutions
 <p>The yellow ESP® and ESP® OFF warning lamps are lit while the engine is running.</p>	<p>ESP®, BAS, BAS PLUS, PRE-SAFE®, PRE-SAFE® Brake, the HOLD function and hill start assist are not available due to a malfunction. ATTENTION ASSIST is deactivated.</p> <p> <b>WARNING</b></p> <p>The brake system continues to function normally, but without the functions listed above.</p> <p>The braking distance in an emergency braking situation can thus increase.</p> <p>If ESP® is not operational, ESP® is unable to stabilize the vehicle. There is an increased risk of skidding and an accident.</p> <ul style="list-style-type: none"> <li>► Observe the additional display messages in the multifunction display.</li> <li>► Drive on carefully.</li> <li>► Visit a qualified specialist workshop.</li> </ul>
 <p>The yellow ESP® and ESP® OFF warning lamps are lit while the engine is running.</p>	<p>ESP®, BAS, PRE-SAFE®, the HOLD function and hill start assist are temporarily unavailable.</p> <p>BAS PLUS and PRE-SAFE® Brake may also have failed. ATTENTION ASSIST is deactivated.</p> <p>self-diagnosis is not yet complete.</p> <p> <b>WARNING</b></p> <p>The brake system continues to function normally, but without the functions listed above.</p> <p>The braking distance in an emergency braking situation can thus increase.</p> <p>If ESP® is not operational, ESP® is unable to stabilize the vehicle. There is an increased risk of skidding and an accident.</p> <ul style="list-style-type: none"> <li>► Carefully drive on a suitable stretch of road, making slight steering movements at a speed above 12 mph (20 km/h). The functions mentioned above are available again when the warning lamp goes out.</li> </ul> <p>If the warning lamp is still on:</p> <ul style="list-style-type: none"> <li>► Observe the additional display messages in the multifunction display.</li> <li>► Drive on carefully.</li> <li>► Visit a qualified specialist workshop.</li> </ul>



Problem	Possible causes/consequences and ► Solutions
<p> (USA only)</p> <p> (Canada only)</p> <p>The red brake system warning lamp comes on while the vehicle is moving. A warning tone also sounds.</p>	<p>You are driving with the parking brake applied.</p> <ul style="list-style-type: none"> <li>► Release the parking brake.</li> </ul> <p>The warning lamp goes out and the warning tone ceases.</p>
<p></p> <p>The red SRS warning lamp is lit while the engine is running.</p>	<p>There is a malfunction in the SRS (Supplemental Restraint System).</p> <p> <b>WARNING</b></p> <p>The air bags or Emergency Tensioning Devices may either be triggered unintentionally or, in the event of an accident, may not be triggered.</p> <p>There is an increased risk of injury.</p> <ul style="list-style-type: none"> <li>► Drive on carefully.</li> <li>► Have SRS checked at a qualified specialist workshop immediately.</li> </ul> <p>For further information about SRS, see (► page 41).</p>





Engine	
Problem	Possible causes/consequences and ► Solutions
 <p>The yellow Check Engine warning lamp lights up while the engine is running.</p>	<p>There may be a malfunction, for example:</p> <ul style="list-style-type: none"> <li>• in the engine management</li> <li>• in the fuel injection system</li> <li>• in the exhaust system</li> <li>• in the ignition system</li> <li>• in the fuel system</li> </ul> <p>The emission limit values may be exceeded and the engine may be running in emergency mode.</p> <p>► Have the vehicle checked as soon as possible at a qualified specialist workshop.</p> <p><b>i</b> In some states, you must immediately visit a qualified specialist workshop as soon as the yellow Check Engine warning lamp lights up. This is due to the legal requirements in effect in these states. If in doubt, check whether such legal regulations apply in the state in which you are currently driving.</p>
 <p>The yellow reserve fuel warning lamp lights up while the engine is running.</p>	<p>The fuel level has dropped into the reserve range.</p> <p>► Refuel at the nearest gas station.</p>
 <p>The yellow reserve fuel warning lamp flashes while the vehicle is in motion.</p> <p>In addition, the  Check Engine warning lamp may light up.</p>	<p>The fuel system pressure is too low. The fuel filler cap is not closed correctly or the fuel system is leaking.</p> <p>► Check that the fuel filler cap is correctly closed.</p> <p>► <b>If the fuel filler cap is not correctly closed:</b> close the fuel filler cap.</p> <p>► <b>If the fuel filler cap is closed:</b> visit a qualified specialist workshop.</p>
 <p>The red coolant warning lamp lights up while the engine is running and the coolant temperature gauge is at the start of the scale.</p>	<p>The temperature sensor for the coolant temperature gauge is defective.</p> <p>The coolant temperature is no longer being monitored. There is a risk of engine damage if the coolant temperature is too high.</p> <p>► Pull over and stop the vehicle safely and switch off the engine, paying attention to road and traffic conditions. Do not continue driving under any circumstances.</p> <p>► Secure the vehicle against rolling away (▷ page 167).</p> <p>► Consult a qualified specialist workshop.</p>

Problem	Possible causes/consequences and ► Solutions
 <p>The red coolant warning lamp comes on while the engine is running.</p>	<p>The coolant level is too low.</p> <p>If the coolant level is correct, the airflow to the engine radiator may be blocked or the electric engine radiator fan may be malfunctioning.</p> <p>The coolant is too hot and the engine is no longer being cooled sufficiently.</p> <ul style="list-style-type: none"> <li>► Observe the additional display messages in the multifunction display.</li> <li>► Pull over and stop the vehicle safely and switch off the engine, paying attention to road and traffic conditions.</li> <li>► Secure the vehicle against rolling away (▷ page 167).</li> <li>► Leave the vehicle and keep a safe distance from the vehicle until the engine has cooled down.</li> <li>► Check the coolant level and add coolant, observing the warning notes (▷ page 308).</li> <li>► If you need to add coolant more often than usual, have the engine coolant system checked.</li> <li>► Make sure that the air supply to the engine radiator is not blocked, e.g. by snow, slush or ice.</li> <li>► Do not start the engine again until the coolant temperature is under 248 °F (120 °C). Otherwise, the engine could be damaged.</li> <li>► Drive to the nearest qualified specialist workshop.</li> <li>► Avoid subjecting the engine to heavy loads, e.g. driving in mountainous terrain, and stop-and-go traffic.</li> </ul>
 <p>The red coolant warning lamp comes on while the engine is running. A warning tone also sounds.</p>	<p>The coolant temperature has exceeded 248 °F (120 °C). The airflow to the engine radiator may be blocked or the coolant level may be too low.</p> <p><b>⚠ WARNING</b></p> <p>The engine is not being cooled sufficiently and may be damaged. Do not drive when your engine is overheated. This can cause some fluids which may have leaked into the engine compartment to catch fire.</p> <p>Steam from the overheated engine can also cause serious burns which can occur just by opening the hood.</p> <p>There is a risk of injury.</p> <ul style="list-style-type: none"> <li>► Observe the additional display messages in the multifunction display.</li> <li>► Pull over and stop the vehicle safely and switch off the engine, paying attention to road and traffic conditions.</li> <li>► Secure the vehicle against rolling away (▷ page 167).</li> </ul>

Problem	Possible causes/consequences and ► Solutions
	<ul style="list-style-type: none"> <li>► Leave the vehicle and keep a safe distance from the vehicle until the engine has cooled down.</li> <li>► Check the coolant level and add coolant, observing the warning notes (► page 308).</li> <li>► If you need to add coolant more often than usual, have the engine coolant system checked.</li> <li>► Make sure that the air supply to the engine radiator is not blocked, e.g. by snow, slush or ice.</li> <li>► At coolant temperatures under 248 °F (120 °C), drive to the next qualified specialist workshop.</li> <li>► Avoid subjecting the engine to heavy loads, e.g. driving in mountainous terrain, and stop-and-go traffic.</li> </ul>

### Driving systems

Problem	Possible causes/consequences and ► Solutions
 <p>The red distance warning lamp lights up while the vehicle is in motion.</p>	<p>The distance to the vehicle in front is too small for the speed selected.</p> <ul style="list-style-type: none"> <li>► Increase the distance.</li> </ul>
 <p>The red distance warning lamp lights up while the vehicle is in motion. A warning tone also sounds.</p>	<p>You are approaching a vehicle or a stationary obstacle in your line of travel at too high a speed.</p> <ul style="list-style-type: none"> <li>► Be prepared to brake immediately.</li> <li>► Pay careful attention to the traffic situation. You may have to brake or take evasive action.</li> </ul> <p>Further information on PRE-SAFE® Brake (► page 72).</p>

Tires	
Problem	Possible causes/consequences and ► Solutions
 <p>The yellow tire pressure monitor warning lamp (pressure loss/malfunction) is lit.</p>	<p>The tire pressure monitor has detected a loss of pressure in at least one of the tires.</p> <p> <b>WARNING</b></p> <p>With tire pressures which are too low, there is a risk of the following hazards:</p> <ul style="list-style-type: none"> <li>• they may burst, especially as the load and vehicle speed increase.</li> <li>• they may wear excessively and/or unevenly, which may greatly impair tire traction.</li> <li>• the driving characteristics, as well as steering and braking, may be greatly impaired.</li> </ul> <p>There is a risk of an accident.</p> <ul style="list-style-type: none"> <li>► Stop the vehicle without making any sudden steering or braking maneuvers. Pay attention to the traffic conditions as you do so.</li> <li>► Secure the vehicle against rolling away (▷ page 167).</li> <li>► Observe the additional display messages in the multifunction display.</li> <li>► Check the tires and, if necessary, follow the instructions for a flat tire (▷ page 321).</li> <li>► Check the tire pressure (▷ page 342).</li> <li>► If necessary, correct the tire pressure.</li> </ul>
 <p>The yellow tire pressure monitor warning lamp (pressure loss/malfunction) flashes for approximately one minute and then remains lit.</p>	<p>The tire pressure monitor is faulty.</p> <p> <b>WARNING</b></p> <p>The system is possibly unable to recognize or register low tire pressure.</p> <p>There is a risk of an accident.</p> <ul style="list-style-type: none"> <li>► Observe the additional display messages in the multifunction display.</li> <li>► Visit a qualified specialist workshop.</li> </ul>

Useful information .....	278
Stowage areas .....	278
Features .....	284

### Useful information

- 1 This Operator's Manual describes all models and all standard and optional equipment of your vehicle available at the time of publication of the Operator's Manual. Country-specific differences are possible. Please note that your vehicle may not be equipped with all features described. This also applies to safety-related systems and functions.
- i Read the information on qualified specialist workshops: (▷ page 26).

### Stowage areas

#### Loading guidelines

#### WARNING

If objects, luggage or loads are not secured or not secured sufficiently, they could slip, tip over or be flung around and thereby hit vehicle occupants. There is a risk of injury, particularly in the event of sudden braking or a sudden change in direction.

Always store objects so that they cannot be flung around. Secure objects, luggage or loads against slipping or tipping before the journey.

#### WARNING

Combustion engines emit poisonous exhaust gases such as carbon monoxide. Exhaust gases can enter the vehicle interior if the trunk lid is open when the engine is running, especially if the vehicle is in motion. There is a risk of poisoning.

Always switch off the engine before opening the trunk lid. Never drive with the trunk lid open.

The handling characteristics of a laden vehicle are dependent on the distribution of the load within the vehicle. For this reason, you should observe the following notes when transporting a load:

- Never exceed the maximum permissible gross vehicle weight or the gross axle weight rating of the vehicle (including occupants). The values are specified on the vehicle identification plate on the B-pillar of the driver's door.
- The trunk is the preferred place to carry objects.
- Position heavy loads as far forwards as possible and as low down in the trunk as possible.
- The load must not protrude above the upper edge of the seat backrests.
- Always place the load against the rear or front seat backrests. Make sure that the seat backrests are securely locked into place.
- Always place the load behind unoccupied seats if possible.
- Use the cargo tie down rings and the parcel nets to transport loads and luggage.
- Use cargo tie-down rings and fastening materials appropriate for the weight and size of the load.
- Secure the load with sufficiently strong and wear-resistant tie-downs. pad sharp edges for protection.

### Stowage space

#### Important safety notes

#### WARNING

If you do not correctly store objects in the vehicle interior, they can slip or be flung around, thus striking vehicle occupants. There is a risk of injury, especially when braking or abruptly changing directions.



- Always store objects so that they cannot be flung around in these or in similar situations.
- Always make sure that objects do not protrude from stowage compartments, parcel nets or stowage nets.
- Close lockable stowage compartments while driving.
- Stow and secure objects that are heavy, hard, pointy, sharp-edged, fragile or too large in the trunk.

Observe the loading guidelines (> page 278).

### Glove box

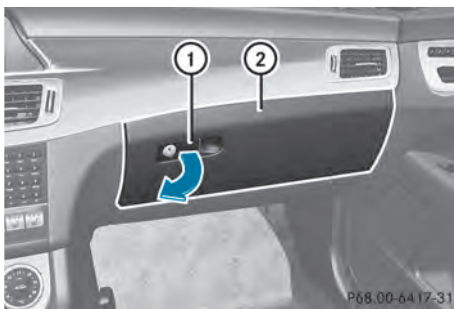

- ▶ **To open:** pull handle ① and open glove box flap ②.
- ▶ **To close:** fold glove box flap ② upwards until it engages.

**i** The glove box can be ventilated (> page 142).

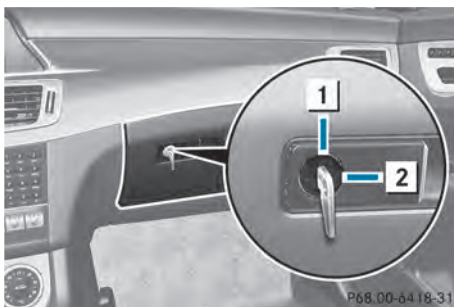

The glove box can only be locked and unlocked using the mechanical key.

- ▶ **To lock:** insert the mechanical key into the lock and turn it 90° clockwise to position ②.
- ▶ **To unlock:** insert the mechanical key into the lock and turn it 90° counter-clockwise to position ①.

### Eyeglasses compartment

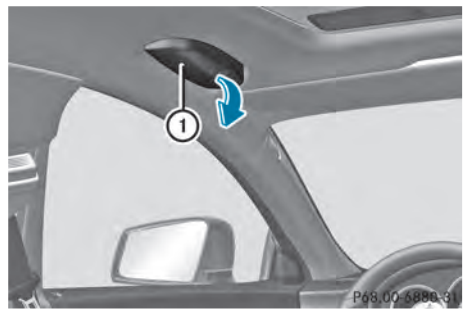

There is a compartment to stow eyeglasses in the headliner on the driver's side.

- ▶ **To open:** pull down eyeglasses compartment ① by the handle.

### Stowage compartments in the front center console



All models except AMG vehicles

- ▶ **To open:** slide the cover forwards by handle ① in the direction of the arrow until it engages.
- ▶ **To close:** briefly press the front of handle ①.



AMG vehicles

- ▶ Briefly press trim ①.

- ❗ The stowage tray can be removed.

### Stowage compartment under the armrest

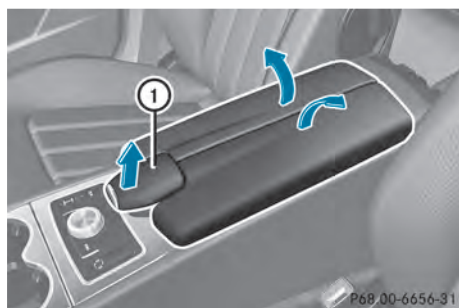

- ▶ **To open:** pull handle ① up. The armrest folds out.

- ❗ Depending on the vehicle's equipment, a 12 V socket, a USB socket, and an AUX IN connection or Media Interface are installed in the stowage compartment. A Media Interface is a universal interface for mobile audio equipment, e.g. for an iPod® or MP3 player (see the separate COMAND Operating Instructions).

### Stowage compartment under the front seats

#### ⚠ WARNING

If you exceed the maximum load for the stowage compartment, the cover may not be able to restrain the items. Items may be

thrown out of the stowage compartment and hit vehicle occupants. There is a risk of injury, particularly in the event of sudden braking or a sudden change in direction.

Never exceed the maximum permissible load for the stowage compartment. Stow and secure heavy objects in the trunk.

The maximum permissible load of the stowage compartment is 3.3 lbs (1.5 kg).

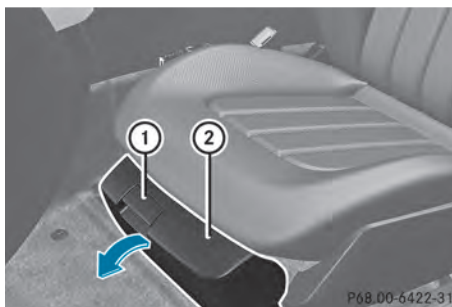

- ▶ **To open:** pull handle ① up and fold cover ② forwards.

- ❗ On vehicles with a fire extinguisher, the fire extinguisher is located in the stowage compartment under the driver's seat.

### Stowage compartments in the rear center console

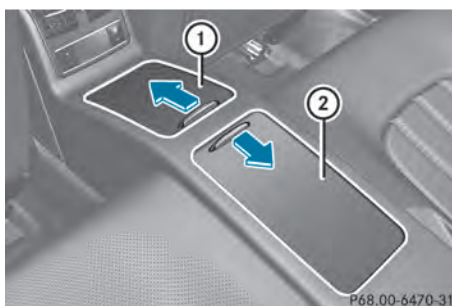

- ▶ **To open:** slide covers ① and ② in the direction of the arrow.

- ❗ There is a 12 V power socket in the front stowage compartment.

### Stowage compartment in the rear seat armrest

- ❗ Do not sit or lean your bodyweight on the armrests when they are folded out as you could damage them.
- ❗ Close the cover of the stowage compartment before folding the rear seat armrest back into the seat backrest.

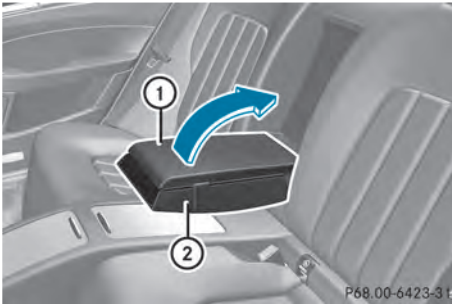

- ▶ **To open:** fold down seat armrest (2).
- ▶ Fold cover (1) of the armrest upwards.

### Storage pockets

#### ⚠ WARNING

Storage bags are intended for storing light-weight items only. Heavy objects, objects with sharp edges or fragile objects may not be transported in the storage bag. In an accident, during hard braking, or sudden maneuvers, they could be thrown around inside the vehicle and cause injury to vehicle occupants. Storage bags cannot protect transported goods in the event of an accident.

The stowage pockets are on the back of the driver's and front-passenger's seats.

### Stowage nets

Stowage nets are located in the front-passenger footwell and on the right-hand side of the trunk.

Observe the loading guidelines (▷ page 278) and the safety notes regarding stowage spaces (▷ page 278).

### Rear bench seat through-loading feature

#### Important safety notes

#### ⚠ WARNING

If the rear bench seat/rear seat and seat backrest are not engaged they could fold forwards, e.g. when braking suddenly or in the event of an accident.

- The vehicle occupant would thereby be pushed into the seat belt by the rear bench seat/rear seat or by the seat backrest. The seat belt can no longer offer the intended level of protection and could even cause injuries.
- Objects or loads in the trunk cannot be restrained by the seat backrest.

There is an increased risk of injury.

Before every trip, make sure that the seat backrests and the rear bench seat/rear seat are engaged.

Observe the loading guidelines (▷ page 278). The left-hand and right-hand rear seat backrests can be folded down separately to increase the trunk capacity.

### Folding the seat backrest forward

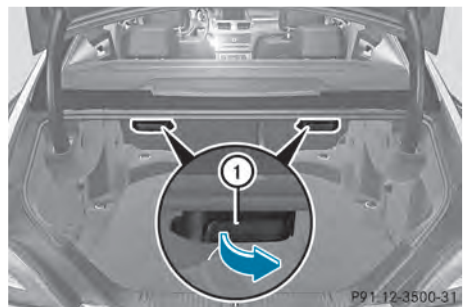

- i Vehicles with memory function: when you fold one or both parts of the rear seat

backrest forwards, the respective front seat moves forward slightly, when necessary, in order to avoid contact.

- ▶ Vehicles without memory function: if necessary, move the driver's or front-passenger seat forwards.
- ▶ Open the trunk.
- ▶ Pull right-hand or left-hand rear seat backrest release handle ①. The corresponding rear seat backrest is released.



- ▶ Fold rear seat backrest ② forwards.
- ▶ Move the driver's or front-passenger seat back if necessary.

### Folding the seat backrest back

- ! Make sure that the seat belt does not become trapped when folding the rear seat backrest back. Otherwise, it could be damaged.

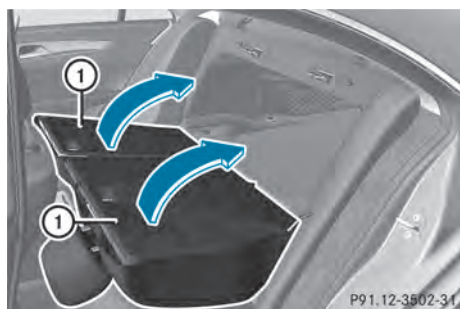

- ▶ Move the driver's or front-passenger seat forward if necessary.
- ▶ Fold rear seat backrest ① back until it engages. If the rear seat backrest is not engaged and locked, this will be shown in the multifunction display in the instrument cluster. A warning tone also sounds.
- ▶ Move the driver's or front-passenger seat back if necessary.

**i** You should always engage the rear seat backrests if you do not need the through-loading feature. This will prevent unauthorized access to the trunk from the vehicle interior.

## Securing cargo

### Cargo tie-down rings

#### General notes

Observe the following notes on securing loads:

- Observe the loading guidelines (▷ page 278).
- Secure the load using the cargo tie-down rings.
- Distribute the load on the cargo tie-down rings evenly.
- Do not use elastic straps or nets to secure a load, as these are only intended as an anti-slip protection for light loads.
- Do not route tie-downs across sharp edges or corners.
- Pad sharp edges for protection.

**Trunk**

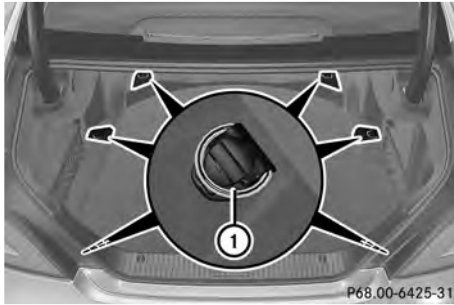

There are six cargo tie down rings ① in the trunk.

**Bag hook**

**⚠ WARNING**

The bag hooks cannot restrain heavy objects or items of luggage. Objects or items of luggage could be flung around and thereby hit vehicle occupants when braking or abruptly changing directions. There is a risk of injury. Only hang light objects on the bag hooks. Never hang hard, sharp-edged or fragile objects on the bag hooks.

❗ The bag hook can bear a maximum load of 6.6lbs (3kg) and should not be used to secure a load.

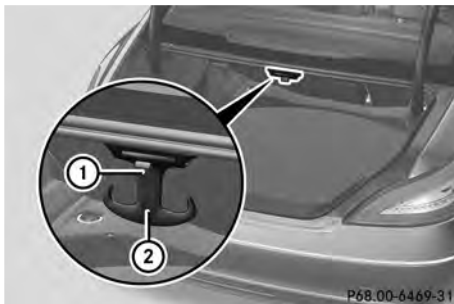

► Pull bag hook ② down by tab ①.

**Stowage well under the trunk floor**

❗ Unhook the handle before again before closing the trunk lid and clip it in securely to prevent the handle flap from protruding. Otherwise, you could damage the handle.

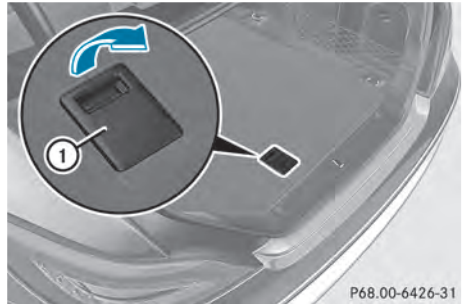

The TIREFIT kit, the vehicle tool kit, etc. are located in the stowage compartment.

► **To open:** pull handle ① up.

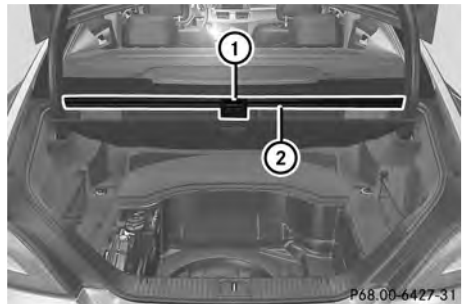

► Hook handle ① into rain trough ②.

**Roof carrier**

**Important safety notes**

**⚠ WARNING**

When you load the roof, the center of gravity of the vehicle rises and the driving characteristics change. If you exceed the maximum roof load, the driving characteristics, as well as steering and braking, will be greatly impaired. There is a risk of an accident.

Never exceed the maximum roof load and adjust your driving style.

- ❗ Mercedes-Benz recommends that you only use roof carriers that have been tested and approved for Mercedes-Benz vehicles. This helps to prevent damage to the vehicle.

Position the load on the roof carrier in such a way that the vehicle will not sustain damage even when it is in motion.

Ensure that, depending on the vehicle's equipment, you can raise the sliding sunroof fully and open the trunk lid fully when the roof carrier is installed.

- ❗ To avoid damaging or scratching the covers, do not use metallic or hard objects to open them.

The maximum roof load is 220 lbs(100 kg). An incorrectly secured roof carrier or roof load may become detached from the vehicle. You must therefore ensure that you observe the roof carrier manufacturer's installation instructions.

### Attaching the roof carrier

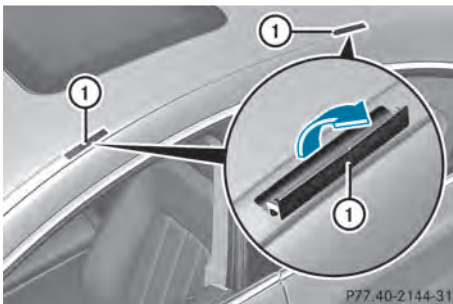

- ▶ Open covers ① carefully in the direction of the arrow.
- ▶ Only secure the roof carrier to the anchorage points under covers ①.
- ▶ Observe the manufacturer's installation instructions.

## Features

### Cup holder

#### Important safety notes

- ❗ Only use the cup holders for containers of the right size and which have lids. The drinks could otherwise spill.

#### Cup holder in the front-compartment center console

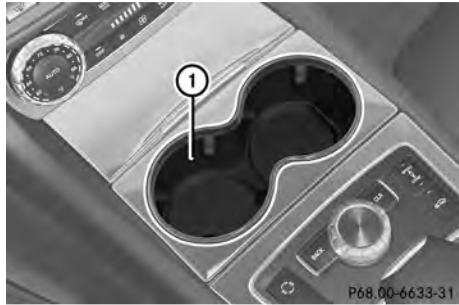

All vehicles (except AMG)

- ① Cup holder

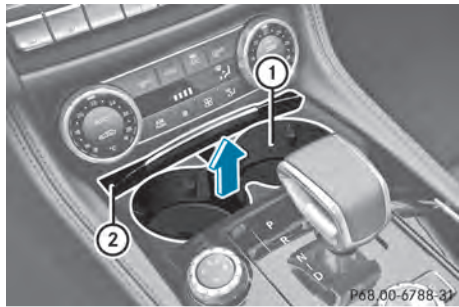

AMG vehicles

- ① Cup holder
- ② Cover

- ▶ **To open:** slide cover ② to its foremost position.

You can remove the cup holder's rubber mat for cleaning. Clean with clear, lukewarm water only.

AMG vehicles: you can remove the rubber mat of the cup holder in the direction of the

arrow to clean it. Clean with clear, lukewarm water only.

### Cup holder in the rear-compartment center console



- ▶ **To open:** slide cover ① forwards.
- ▶ **To remove the insert:** slide catch ② inwards in the direction of the arrow.
- ▶ Remove cup holder insert ③ upwards.
- ▶ **To re-install the insert:** place the insert in the stowage space.
- ▶ Slide catch ② outwards in the direction of the arrow until it engages.

You can remove the insert and the rubber mat of the cup holder to clean them. Clean them with clean, lukewarm water only.

### Cup holder in the rear seat armrest

- ❗ Do not sit on or support your body weight on the rear seat armrest when it is folded down, as you could otherwise damage it.
- ❗ Close the cup holder before folding the rear seat armrest up. Otherwise, the cup holder could be damaged.

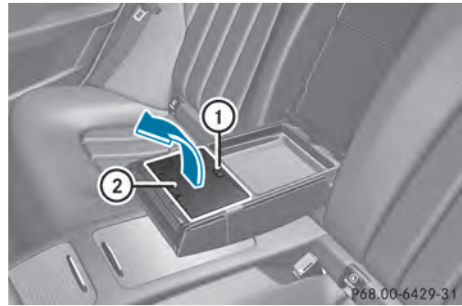

- ▶ Fold down the rear seat armrest.
- ▶ **To open:** raise the rear seat armrest cover.
- ▶ Press release catch ①. Cup holder ② folds out forwards.
- ▶ Swing the rear seat armrest cover back down, if necessary.
- ▶ **To close:** raise the rear seat armrest cover. Swing cup holder ② back until it engages.

### Bottle holder

Observe the "Important safety notes" in the "Stowage compartments" section (> page 278).

#### ⚠ WARNING

If objects in the passenger compartment are stowed incorrectly, they can slide or be thrown around and hit vehicle occupants. There is a risk of injury, particularly in the event of sudden braking or a sudden change in direction.

- Always stow objects so that they cannot be thrown around in such situations.
- Always make sure that objects do not protrude from stowage spaces, parcel nets or stowage nets.
- Close the lockable stowage spaces while driving.
- Always stow and secure heavy, hard, pointed, sharp-edged, fragile or bulky objects in the trunk/cargo compartment.

**!** Make sure that any bottles weighing more than 1.1 lb(0.5 kg) that are stored in the bottle holder, rest on the vehicle floor. The bottle holder could otherwise be damaged.

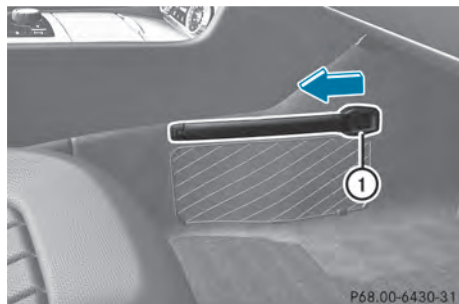

- ▶ Press the outer edge of button ① and slide in the direction of the arrow until the bottle fits into the opening.
- ▶ Insert the bottle into the bottle holder.

The bottle holder is suitable for bottles with a capacity of 25 fl. oz. (0.7 l) to 54 fl. oz. (1.5 l).

The bottle holder does not secure the bottles; it merely prevents them from tipping over.

### Sun visors

#### Overview

#### WARNING

If the mirror cover of the vanity mirror is folded up when the vehicle is in motion, you could be blinded by incident light. There is a risk of an accident.

Always keep the mirror cover folded down while driving.

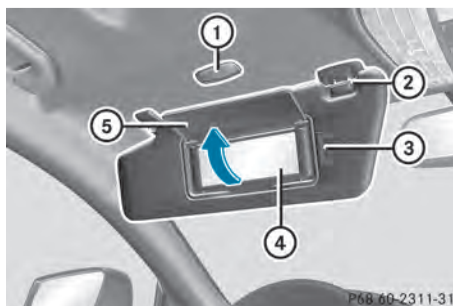

- ① Mirror light
- ② Bracket
- ③ Retaining clip, e.g. for a car park ticket
- ④ Vanity mirror
- ⑤ Mirror cover

#### Vanity mirror in the sun visor

Mirror light ① only functions if the sun visor is clipped into bracket ② and mirror cover ⑤ has been folded up.

#### Glare from the side

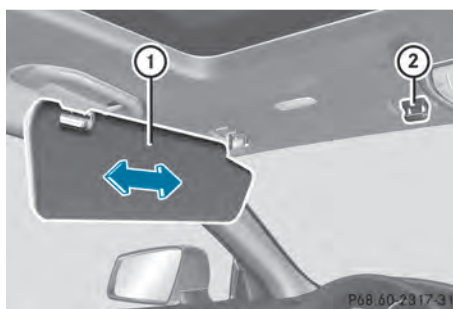

- ▶ Fold down sun visor ①.
- ▶ Pull sun visor ① out of retainer ②.
- ▶ Swing sun visor ① to the side.
- ▶ Slide sun visor ① horizontally as required.



## Rear window roller sunblind

### Important safety notes

#### WARNING

When extending or retracting, parts of the body could become trapped within the sweep of the roller sunblind. There is a risk of injury. When extending or retracting, make sure that no one has any parts of the body within the sweep of the roller sunblind. If someone becomes trapped, briefly press the button again. The opening or closing procedure will be stopped.

- ❗ Make sure that the roller sunblind can move freely. Otherwise, the roller sunblind or other objects could be damaged.

### Extending/retracting the roller sunblind



- ▶ Turn the SmartKey to position **2** in the ignition lock (▶ page 147).
- ▶ **To extend or retract:** briefly press button **1**.  
The roller sunblind fully extends or fully retracts.
- ▶ **To stop:** briefly press button **1** again.  
The roller sunblind stops briefly and moves back into the out-of-use position.

## Ashtray

### Front ashtray

- ❗ The stowage space under the ashtray is not heat resistant. Before placing lit cigarettes in the ashtray, make sure that the ashtray is properly engaged. Otherwise, the stowage space could be damaged.

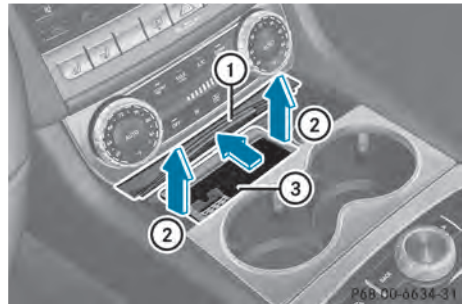

All vehicles (except AMG)

- ▶ **To open:** slide cover **1** forwards until it engages.
- ▶ **To remove the insert:** grasp insert **3** by the notch at the side and lift it up **2** and out.
- ▶ **To re-install the insert:** press insert **3** into the holder until it engages.
- ▶ **To close:** briefly press cover **1** at the front.  
The cover moves back.

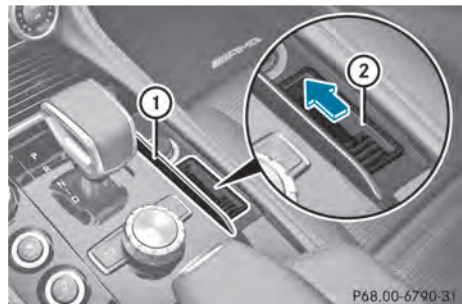

AMG vehicles

- ▶ **To open:** briefly press the trim on cover ①.  
The stowage compartment opens.
- ▶ **To remove the insert:** slide insert ② forwards in the direction of the arrow.
- ▶ Remove insert ②.
- ▶ **To re-install the insert:** place the insert into the holder and press it in the opposite direction of the arrow until it engages.
- ▶ **To close:** fold down cover ①.

**i** You can remove the ashtray insert and use the resulting compartment for stowage.

### Rear-compartment ashtray

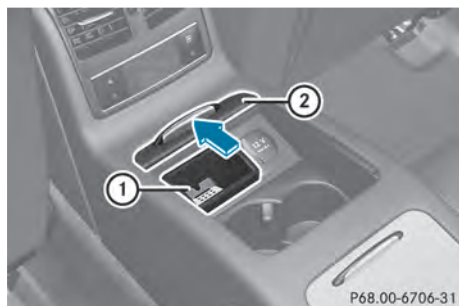

- ▶ **To open:** slide cover ② forwards.
- ▶ **To remove the insert:** pull insert ① up and out.
- ▶ **To install the insert:** install insert ① from above into the holder and press down into the holder until it engages.

### Cigarette lighter

#### **⚠ WARNING**

You can burn yourself if you touch the hot heating element or the socket of the cigarette lighter.

In addition, flammable materials can ignite if:

- the hot cigarette lighter falls
- a child holds the hot cigarette lighter to objects, for example

There is a risk of fire and injury.

Always hold the cigarette lighter by the knob. Always make sure that the cigarette lighter is out of reach of children. Never leave children unsupervised in the vehicle.

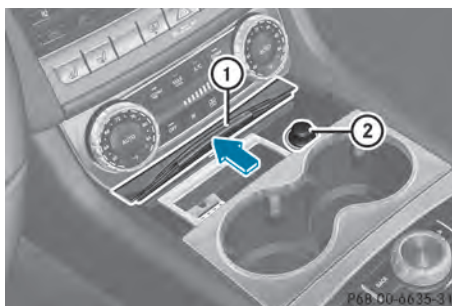

All vehicles (except AMG)

Your attention must always be focused on the traffic conditions. Only use the cigarette lighter when road and traffic conditions permit.

- ▶ Turn the SmartKey to position **2** in the ignition lock (▷ page 147).
- ▶ **To open:** slide cover ① forwards until it engages.
- ▶ Press in cigarette lighter ②.  
Cigarette lighter ② will pop out automatically when the heating element is red-hot.
- ▶ **To close:** briefly press cover ① at the front.  
The cover moves back.

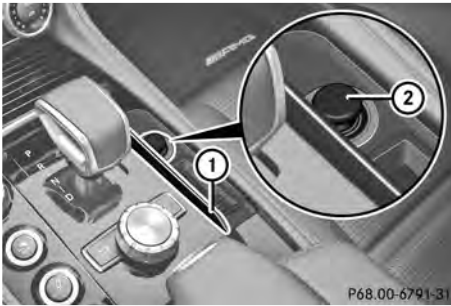

AMG vehicles

Your attention must always be focused on the traffic conditions. Only use the cigarette lighter when road and traffic conditions permit.

- ▶ Turn the SmartKey to position **2** in the ignition lock (▷ page 147).
- ▶ **To open:** briefly press the trim on cover **1**.  
The stowage compartment opens.
- ▶ Press in cigarette lighter **2**.  
Cigarette lighter **2** will pop out automatically when the heating element is red-hot.

### 12 V sockets

#### General notes

- ▶ Turn the SmartKey to position **1** in the ignition lock (▷ page 147).

The sockets can be used for accessories with a maximum draw of 180 W (15 A). Accessories include such items as lamps or chargers for mobile phones.

If you use the sockets for long periods when the engine is switched off, the battery may discharge.

- i** An emergency cut-out ensures that the on-board voltage does not drop too low. If the on-board voltage is too low, the power to the sockets is automatically cut. This ensures that there is sufficient power to start the engine.

#### Socket under the armrest

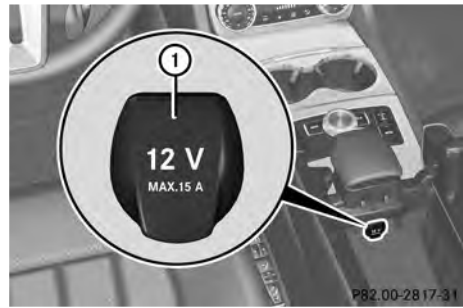

- ▶ Open the stowage compartment under the armrest (▷ page 280).
- ▶ Lift up the cover of socket **1**.

#### Socket in the front-compartment center console

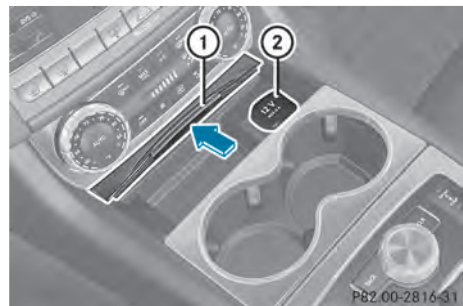

All vehicles (except AMG)

- ▶ **To open:** slide cover **1** forwards until it engages.
- ▶ Lift up the cover of socket **2**.
- ▶ **To close:** briefly press cover **1** at the front.  
The cover moves back.



AMG vehicles

- ▶ **To open:** briefly press the trim over cover ①.  
The stowage compartment opens.
- ▶ Lift up the cover of socket ②.
- ▶ **To close:** fold down cover ①.

### Socket in the rear-compartment center console

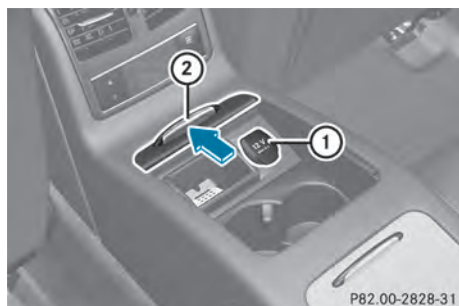

- ▶ Slide cover ② forwards.
- ▶ Lift up the cover of socket ①.

### Socket in the trunk

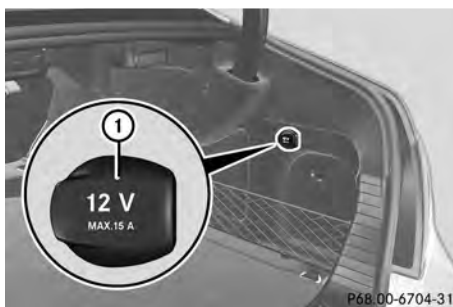

- ▶ Lift up the cover of socket ①.

### mbrace

#### Important safety notes

**!** You must have a license agreement to activate the mbrace service. Make sure that your system is activated and ready for use. To register, press the [☎ i] MB Info call button. If any of the steps mentioned are not carried out, the system may not be activated.

If you have questions about the activation, contact one of the following telephone hotlines:

- **USA:** Mercedes-Benz Customer Assistance Center at 1-800-FOR-MERCEdes (1-800-367-6372) or 1-866-990-9007
- **Canada:** Customer Service at 1-888-923-8367

Shortly after successfully registering with the service, a user ID and password will be sent to you by post. USA only: you can use this password to log onto the mbrace area under "Owners Online" at <http://www.mbusa.com>.



The system is available if:

- it has been activated and is operational
- the corresponding mobile phone network is available for transmitting data to the Customer Center

- a service subscription is available
- the starter battery is sufficiently charged
- ❶ Determining the location of the vehicle on a map is only possible if:
  - GPS reception is available.
  - the vehicle position can be forwarded to the Customer Assistance Center.

### The mbrace system

To adjust the volume during a call, proceed as follows:

- ▶ Press the  or  button on the multifunction steering wheel.

or

- ▶ Use the volume controller of the audio system/COMAND.

The system offers various services, e.g:



- Automatic and manual emergency call
- Roadside Assistance call
- MB Info call



USA only: you can find information and a description of all available features under "Owners Online" at <http://www.mbusa.com>.

### System self-test

After you have switched on the ignition, the system carries out a self-diagnosis.

A malfunction in the system has been detected if one of the following occurs:

- The indicator lamp in the SOS button does not come on during the system self-test.
- The indicator lamp in the  Roadside Assistance button does not light up during self-diagnosis of the system.
- The indicator lamp in the  MB Info call button does not light up during self-diagnosis of the system.

- The indicator lamp in one or more of the following buttons continues to light up red after the system self-diagnosis:
  - SOS button
  -  Roadside Assistance call button
  -  MB Info call button
- after the system self-diagnosis, the **Inoperative** or **Service Not Activated** message appears in the multifunction display.

If a malfunction is indicated as outlined above, the system may not operate as expected. In the event of an emergency, help will have to be summoned by other means.

Have the system checked at the nearest authorized Mercedes-Benz Center or contact the following service hotlines:

- **USA:** Mercedes-Benz Customer Assistance Center at 1-800-FOR-MERCEdes (1-800-367-6372) or 1-866-990-9007
- **Canada:** Customer Service at 1-888-923-8367

### Emergency call

#### Important safety notes

- ❗ You must have a license agreement to activate the mbrace service. Make sure that your system is activated and ready for use. To register, press the  MB Info call button. If any of the steps mentioned are not carried out, the system may not be activated.

If you have questions about the activation, contact one of the following telephone hotlines:

- **USA:** Mercedes-Benz Customer Assistance Center at 1-800-FOR-MERCEdes (1-800-367-6372) or 1-866-990-9007
- **Canada:** Customer Service at 1-888-923-8367

### General notes

An emergency call is dialed automatically if an air bag or Emergency Tensioning Device is triggered.

- ❗ You cannot end an automatically triggered emergency call yourself.

An emergency call can also be initiated manually.

As soon as the emergency call has been initiated, the indicator lamp in the SOS button flashes. The multifunction display shows the **Connecting Call** message.

The audio output is muted.

Once the connection has been made, the **Call Connected** message appears in the multifunction display.

All important information on the emergency is transmitted, for example:

- Current location of the vehicle (as determined by the GPS system)
- Vehicle identification number
- Information on the severity of the accident

Shortly after the emergency call has been initiated, a voice connection is automatically established between the Mercedes-Benz Customer Assistance Center and the vehicle occupants.

- If the vehicle occupants respond, the Mercedes-Benz Customer Assistance Center attempts to get more information on the emergency.
- If there is no response from the vehicle occupants, an ambulance is immediately sent to the vehicle.

If no voice connection can be established to the response center, the system was unable to initiate an emergency call. This can occur for instance if the relevant mobile phone network is not available. The indicator lamp in the SOS button flashes continuously.

The **Call Failed** message appears in the multifunction display and must be confirmed. In this case, summon assistance by other means.

### Making an emergency call

#### ⚠ WARNING

It can be dangerous to remain in the vehicle, even if you have pressed the SOS button in an emergency if:

- you see smoke inside or outside of the vehicle, e.g. if there is a fire after an accident
- the vehicle is on a dangerous section of road
- the vehicle is not visible or cannot easily be seen by other road users, particularly when dark or in poor visibility conditions

There is a risk of an accident and injury.

Leave the vehicle immediately in this or similar situations as soon as it is safe to do so. Move to a safe location along with other vehicle occupants. In such situations, secure the vehicle in accordance with national regulations, e.g. with a warning triangle.



- ▶ **To initiate an emergency call manually:** press cover ① briefly to open.
- ▶ Press SOS button ② briefly. The indicator lamp in SOS button ② flashes until the emergency call is concluded.
- ▶ Wait for a voice connection to the Mercedes-Benz Customer Assistance Center.
- ▶ After the emergency call, close cover ①.

- ❗ If the mobile phone network is unavailable, Mercedes-Benz will not be able to make the emergency call. If you leave the

vehicle immediately after pressing the SOS button, you will not know whether mbrace placed the emergency call. In this case, always summon assistance by other means.

### Roadside Assistance button



- ▶ Press Roadside Assistance button ①. This initiates a call to the Mercedes-Benz Customer Assistance Center. The indicator lamp in Roadside Assistance button ① flashes while the call is active. The multifunction display shows the **Connecting Call** message. The audio output is muted.

If a connection can be made, the **Call Connected** message appears in the multifunction display.

If a mobile phone network and GPS reception are available, the system transfers data to the Mercedes-Benz Customer Assistance Center, for example:

- Current location of the vehicle
- Vehicle identification number

- ❗ The COMAND display indicates that a call is active. During the call, you can change to the navigation menu by pressing the NAVI button on COMAND, for example.

Voice output is not available.

A voice connection is established between the Mercedes-Benz Customer Assistance Center and the vehicle occupants.

From the vehicle remote malfunction diagnosis, the Mercedes-Benz Customer

Assistance Center can ascertain the nature of the problem (▷ page 297).

The Mercedes-Benz Customer Assistance Center either sends a qualified Mercedes-Benz technician or arranges for your vehicle to be transported to the nearest authorized Mercedes-Benz Center. You may be charged for services such as repair work and/or towing.

Further details are available in your mbrace manual.

- ❗ The system has not been able to initiate a roadside assistance call, if:
  - the indicator lamp for Roadside Assistance call button ① is flashing continuously.
  - no voice connection to the Mercedes-Benz Customer Assistance Center was established.

This may be because the corresponding mobile phone network is not available.

The **Call Failed** message appears in the multifunction display.

- ▶ **To end a call:** press the  button on the multifunction steering wheel.

or

- ▶ Press the corresponding button for ending a phone call on COMAND.

### MB Info call button



- ▶ Press MB Info call button ①.  
This initiates a call to the Mercedes-Benz Customer Assistance Center. The indicator lamp in MB Info call button ① flashes while the connection is being made. The **Connecting Call** message appears in the multifunction display and COMAND is muted.

If a connection can be made, the **Call Connected** message appears in the multifunction display.

If a mobile phone network and GPS reception are available, the system transfers data to the Mercedes-Benz Customer Assistance Center, for example:

- Current location of the vehicle
- Vehicle identification number

- ❗ The COMAND display indicates that a call is active. During the call, you can change to the navigation menu by pressing the NAVI button on COMAND, for example.

Voice output is not available.

A voice connection is established between the Mercedes-Benz Customer Assistance Center and the vehicle occupants. You can obtain information on how to operate your vehicle's systems, on the location of the nearest authorized Mercedes-Benz Center, and on further products and services offered by Mercedes-Benz USA.

USA only: you can find further information on the mbrace system under "Owners Online" at <http://www.mbusa.com>.

- ❗ The system has not been able to initiate an MB Info call, if:
  - the indicator lamp in MB Info call button ① is flashing continuously.
  - no voice connection to the Mercedes-Benz Customer Assistance Center was established.

This may be because the corresponding mobile phone network is not available.

The **Call Failed** message appears in the multifunction display.

- ▶ **To end a call:** press the  button on the multifunction steering wheel.
- or
- ▶ Press the corresponding button for ending a phone call on COMAND.

### Call priority

When service calls are active, e.g. Roadside Assistance or MB Info calls, an emergency call can still be initiated. In this case, an emergency call will take priority and override all other active calls.

The indicator lamp of the respective button flashes until the call is ended. An emergency call can only be terminated by the Mercedes-Benz Customer Assistance Center.

All other calls can be ended by pressing:

- the  button on the multifunction steering wheel
- or the corresponding COMAND button for ending a telephone call

- ❗ When a call is initiated, the audio system is muted. The mobile phone is no longer connected to COMAND. However, if you want to use your mobile phone, do so only when the vehicle is stationary and in a safe location.

### Downloading destinations in COMAND

#### Downloading destinations

Destination Download gives you access to a data bank with over 15 million Points of Interest (POIs). These can be downloaded on the navigation system in your vehicle. If you know the destination, the address can be downloaded. Alternatively, you can obtain the location of Points of Interest (POIs)/ important destinations in the vicinity.

Furthermore, you can download routes with up to 20 way points.

You are prompted to confirm route guidance to the address entered.



- ▶ Select **Yes** with the ◀ or ▶ buttons on the COMAND system.
- ▶ Confirm with the (OK) button on the COMAND system.

The system calculates the route and subsequently starts the route guidance with the address entered.

- i** If you select **No**, the address can be saved in the address book.
- i** The Destination Download function is available if the corresponding mobile phone network is available and data transfer is possible.
- i** You can only use the Destination Download function if the vehicle is equipped with a navigation system.

### Route Assistance

This service is part of the mbrace PLUS Package and cannot be purchased separately.

- i** You can also use the Route Assistance function if your vehicle is not equipped with a navigation system.

Within the framework of this service, you receive a professional and reliable form of navigation support without having to leave your vehicle.

The customer service representative finds a suitable route depending on your vehicle's current position and the desired destination. You will then be guided live through the current route section.

### Search & Send

#### General notes

- i** To use "Search & Send", your vehicle must be equipped with mbrace and a navigation system. You must also have an mbrace service subscription.

"Search & Send" is a destination entry service. A destination address which is found on Google Maps® can be transferred via

mbrace directly to your vehicle's navigation system.

### Specifying and sending the destination address

- ▶ Go to the website <http://www.maps.google.com> and enter a destination address into the entry field.

- ▶ **To send the destination address to the e-mail address of your mbrace account:** click on the corresponding button.



#### **i** Example:

If you select 'Send to vehicle' and then 'Mercedes-Benz', the destination address will be sent to your vehicle.

- ▶ When the "Send" dialog window appears: In the relevant field, enter the e-mail address which you specified when activating your mbrace account.
- ▶ Click "Send".

- i** Information on specific commands such as "Address entry" or "Send" can be found on the website.

### Calling up destination addresses

- ▶ Switch on the ignition. The destination address is loaded into the vehicle's navigation system. A display message appears, asking whether navigation should be started.
  - ▶ Select **Yes** by sliding ←⊙→ and turning  the COMAND controller and confirm with .
- The system calculates the route and subsequently starts the route guidance with the address entered.

- i** If you select **No**, the address can be saved in the address book.

- i** If you have sent more than one destination address, each individual destination must be confirmed separately.

- i** Destination addresses are loaded in the same order as the order in which they were sent.

Please note the following if you have multiple Mercedes-Benz vehicles with mbrace and active mbrace accounts:

if multiple vehicles are registered under the same e-mail address, the destination will be sent to all the vehicles.

### Vehicle remote opening

You can use the vehicle remote opening if you have unintentionally locked your vehicle and a replacement SmartKey is not available. The vehicle can be opened by the Mercedes-Benz Customer Assistance Center.

The vehicle can be immediately opened remotely within four days of the ignition being turned off. After this time, the remote unlocking may be delayed by 15 to 60 minutes. After 30 days, the vehicle can no longer be opened remotely.

- ▶ Contact the following service hotlines:
  - **USA:** Mercedes-Benz Customer Assistance Center at 1-800-FOR-MERCEdes (1-800-367-6372) or 1-866-990-9007
  - **Canada:** Customer Service at 1-888-923-8367

You will be asked for your password.

- ▶ Return to your vehicle at the time agreed upon with the Mercedes-Benz Customer Assistance Center.

USA only: alternatively, the vehicle can be opened via:

- the Internet, under the "Owners Online" section
- the telephone application (e.g. iPhone®, Blackberry)

To do this, you will need your identification number and password.

- i** Vehicle remote opening is only possible if the corresponding mobile phone network is accessible.

### Vehicle remote closing

The remote closing feature can be used when you have forgotten to lock the vehicle and you are no longer nearby. The vehicle can then be locked by the Mercedes-Benz Customer Assistance Center.

The vehicle can be immediately remotely locked within four days of the ignition being turned off. After this time, the remote closing may be delayed by 15 to 60 minutes. After 30 days the vehicle can no longer be closed remotely.

- ▶ Contact the following service hotlines:
  - **USA:** Mercedes-Benz Customer Assistance Center at 1-800-FOR-MERCEdes (1-800-367-6372) or 1-866-990-9007
  - **Canada:** Customer Service at 1-888-923-8367
 You will be asked for your PIN.

The next time you are inside the vehicle and you switch on the ignition, the **Doors Locked Remotely** message appears in the multifunction display.

USA only: alternatively, the vehicle can be locked via:

- the Internet, under the "Owners Online" section
- the telephone application (e.g. iPhone®, Blackberry)

To do this, you will need your identification number and password.

- i** The vehicle remote closing feature is available when the relevant mobile phone network is available and data connection is possible.

## Stolen vehicle recovery service

If your vehicle has been stolen:

- ▶ Notify the police.  
The police will issue a numbered incident report.
  - ▶ This number will be forwarded to the Mercedes-Benz Customer Assistance Center together with your PIN. The Mercedes-Benz Customer Assistance Center then tries to locate the system. The Mercedes-Benz Customer Assistance Center contacts you and the local law enforcement agency if the vehicle is located. However, only the law enforcement agency is informed of the location of the vehicle.
- i** If the anti-theft alarm system is activated for longer than 30 seconds, the Mercedes-Benz Customer Assistance Center is automatically informed.

## Vehicle remote malfunction diagnosis

With the vehicle remote malfunction diagnosis (Vehicle Health Check), the Customer Assistance center can provide improved support for problems with your vehicle. During an existing call, vehicle data is transferred to the Customer Assistance center. The customer service representative can use the received data to decide what kind of assistance is required. You are then, for example, guided to the nearest authorized Mercedes-Benz Center or a recovery vehicle is called.

If vehicle data needs to be transferred during an MB Info call or a Roadside Assistance call, this is initiated by the Customer Assistance center. You will see the **Roadside Assistance Connected** message in the COMAND display. If the vehicle remote malfunction diagnosis can be started, the **Request for vehicle diagnosis received. Start vehicle diagnosis?** message appears in the display.

- ▶ Confirm the message with **Yes**.
- ▶ When the **Vehicle Diagnosis Please Start Ignition** message appears, turn the SmartKey to position **2** in the ignition lock (▷ page 147).
- ▶ When the **Please follow the instructions received by phone and move your vehicle to a safe position.** message appears, follow the customer service representative's instructions.  
The message in the display disappears.  
If you select **Cancel**, the vehicle remote malfunction diagnosis is canceled completely.  
The vehicle operating state check begins.  
You will see the **Vehicle diagnosis activated.** message.

When the diagnosis is completed, the **Transfer vehicle diagnostics data (Voice connection may be interrupted during data transfer.)** message appears. The vehicle data can now be sent to the Customer Assistance center.

- ▶ Press **OK** to confirm the message.  
The voice connection with the Customer Assistance center is terminated.  
You will see the **Vehicle Diagnosis: Transferring data...** message.  
The vehicle data is sent to the Customer Assistance center.

Depending on what the customer service representative agreed with you, the voice connection is re-established after the transfer is complete. If necessary, you will be contacted at a later time by another means, e.g. by e-mail or phone.

Further functions of the vehicle remote malfunction diagnosis include, for example:

- transfer of service data to the Customer Assistance center. If a service is overdue, the COMAND display shows a message

about various special offers at your workshop.

- monthly status information e-mail on oil level, air pressure, maintenance, brakes, etc. If applicable, you will receive information on special offers in the e-mail. USA only: this information can also be called up under "Owners Online" at <http://www.mbusa.com>.

Information on the data stored in the vehicle (> page 27).

Information on Roadside Assistance (> page 23).

### Downloading routes

Downloading routes allows you to transfer and save predefined routes in the navigation system. To do this, an SD memory card must be inserted into the COMAND system. If no SD memory card is inserted, you must insert the card into the card slot on the COMAND system before saving.

A route can be prepared and sent either by a customer service representative or via the mbrace portal on the Internet.

Each route can include up to 20 way points. Once a route has been received by the navigation system, you will see the **<route name> has been saved to memory card. Do you want to start route guidance?** message in the COMAND display. The route is saved to the SD memory card.

- ▶ **To start route guidance:** select **Yes**.  
An overview of the route is shown in the display.
- ❗ If you select **No**, the saved route can be called up later via the navigation menu.
- ▶ Select **Start**.  
Route guidance is started.
- ❗ Downloaded and saved data can be called up again in COMAND.  
You can find further information in the separate COMAND Operating Instructions.

### Speed alert

You can define the upper speed limit, which must not be exceeded by the vehicle. If this selected speed is exceeded by the vehicle, a message will be sent to the Customer Assistance center. The Customer Assistance center then forwards this information to you. You can select the way in which you receive this information beforehand. Possible options include text message, e-mail or an automated call.

The data which is sent to the Customer Assistance Center contains the following information:

- the location where the speed limit was exceeded
- the time at which the speed limit was exceeded
- the selected speed limit which was exceeded

### Geo fencing

Geo fencing allows you to select areas which the vehicle should not enter or leave. You will be informed if the vehicle crosses the boundaries of the selected areas. You can select the way in which you receive this information beforehand. Possible options include text message, e-mail or an automated call.

The area can be determined as either a circle or a polygon with a maximum of ten corners. You can specify up to ten areas simultaneously. Different settings are possible for each area.

USA only: these settings can be called up under "Owners Online" at <http://www.mbusa.com>.

Alternatively, you can trigger an MB Info call and inform the customer service representative that you wish to activate geo fencing.

Currently inactive areas can be activated by text message.

### Triggering the vehicle alarm

With this function, you can trigger the vehicle's panic alarm via text message. An alarm sounds and the exterior lighting flashes. Depending on the setting, the panic alarm lasts five or ten seconds. Afterwards, the alarm switches off.

### Garage door opener

#### Important safety notes

##### WARNING

When you operate or program the garage door with the integrated garage door opener, persons in the range of movement of the garage door can become trapped or struck by the garage door. There is a risk of injury.

When using the integrated garage door opener, always make sure that nobody is within the range of movement of the garage door.

##### WARNING

Combustion engines emit poisonous exhaust gases such as carbon monoxide. Inhaling these exhaust gases leads to poisoning. There is a risk of fatal injury. Therefore never leave the engine running in enclosed spaces without sufficient ventilation.

The HomeLink® garage door opener integrated in the rear-view mirror allows you to operate up to three different door and gate systems.

Use the integrated garage door opener only on garage doors that:

- have safety stop and reverse features and
- meet current U.S. federal safety standards

When programming a garage door opener, park the vehicle outside the garage.

- i** Certain garage door drives are incompatible with the integrated garage door opener. If you have difficulty programming the integrated garage door

opener, contact an authorized Mercedes-Benz Center.

Alternatively, you can call the following telephone assistance services:

- **USA:** Mercedes-Benz Customer Assistance Center at 1-800-FOR-MERcedes
- **Canada:** Customer Service at 1-800-387-0100
- HomeLink® hotline 1-800-355-3515 (free of charge)

More information on HomeLink® and/or compatible products is also available online at <http://www.homelink.com>.

- i** Notes on the declaration of conformity (▷ page 25).

USA: FCC ID: CB2HMIHL4

Canada: IC: 279B-HMIHL4

### Programming

#### Programming buttons

Observe the "Important safety notes" (▷ page 299).

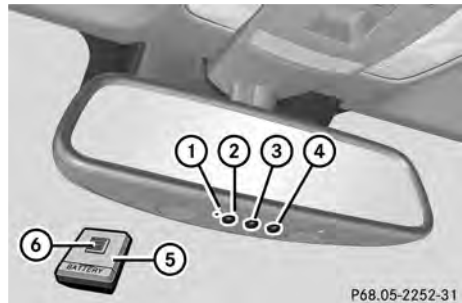

Integrated garage door opener in the rear-view mirror

Garage door remote control ⑤ is not part of the integrated garage door opener.

- ▶ The first time before programming, clear the integrated garage door opener memory (▷ page 301).
- ▶ Turn the SmartKey to position **2** in the ignition lock.

- ▶ Press and hold one of buttons ② to ④ on the integrated garage door opener. After a short time, indicator lamp ① lights up yellow.
- ① Indicator lamp ① lights up yellow as soon as button ②, ③ or ④ is programmed for the first time. If the selected button has already been programmed, indicator lamp ① will only light up yellow after ten seconds have elapsed.
- ▶ Release button ②, ③ or ④. Indicator lamp ① flashes yellow.
- ▶ Point garage door remote control ⑤ towards buttons ② to ④ on the rear-view mirror at a distance of 2 to 8 inches (5 to 20 cm).
- ① The required distance between remote control ⑤ and the integrated garage door opener depends on the garage door drive system. Several attempts might be necessary. You should test every position for at least 25 seconds before trying another position.
- ▶ Press and hold button ⑥ on remote control ⑤ until indicator lamp ① lights up green. If indicator lamp ① lights up green or flashes, then programming has been successful.
- ▶ Release button ⑥ on remote control ⑤ for the garage door drive system.
- ▶ If indicator lamp ① lights up red: repeat the programming procedure for the corresponding button on the rear-view mirror. When doing so, vary the distance between remote control ⑤ and the rear-view mirror.
- ① If the indicator lamp flashes green after successful programming, the garage door system is using a rolling code. After programming, you must synchronize the garage door opener integrated in the rear-view mirror with the receiver of the garage door system.

### Synchronizing the rolling code

Observe the "Important safety notes" (> page 299).

Your vehicle must be within reach of the garage door or exterior gate drive. Make sure that neither your vehicle nor any persons/objects are present within the sweep of the door or gate.

- ▶ Turn the SmartKey to position **2** in the ignition lock.
- ▶ Press the program button of the door or gate drive (see the door or gate drive operating instructions, e.g. under "programming of additional remote controls").
- ① Usually, you now have 30seconds to initiate the next step.
- ▶ Press previously programmed button ②, ③ or ④ of the integrated garage door opener until the door closes. The rolling code synchronization is then complete.

### Notes on programming the remote control

Canadian radio frequency laws require a "break" (or interruption) of the transmission signals after broadcasting for a few seconds. Therefore, these signals may not last long enough for the integrated garage door opener. The signal is not recognized during programming. Comparable with Canadian law, some U.S. garage door openers also feature a "break".

Proceed as follows:

- if you live in Canada
- if you have difficulties programming the garage door opener (regardless of where you live) when using the programming steps

- ▶ Press and hold one of buttons ② to ④ on the integrated garage door opener. After a short time, indicator lamp ① lights up yellow.
- ▶ Release the button. Indicator lamp ① flashes yellow.
- ▶ Press button ⑥ of garage door remote control ⑤ for two seconds, then release it for two seconds.
- ▶ Press button ⑥ again for two seconds.
- ▶ Repeat this sequence on button ⑥ of remote control ⑤ until indicator lamp ① lights up green. If indicator lamp ① turns red, repeat the process.
- ▶ Continue with the other programming steps (see above).

### Problems when programming

If you are experiencing problems programming the integrated garage door opener on the rear-view mirror, take note of the following instructions:

- Check the transmitter frequency of garage door drive remote control ⑤. This can usually be found on the back of the remote control. The integrated garage door opener is compatible with devices that have units which operate in the frequency range of 280 to 433 MHz.
- Replace the batteries in garage door remote control ⑤. This increases the likelihood that garage door remote control ⑤ will transmit a strong and precise signal to the integrated garage door opener in the rear-view mirror.
- When programming, hold remote control ⑤ at varying distances and angles from the button that you are programming. Try various angles at a distance between 2 and 12 inches (5 to 30 cm) or at the same angle but at varying distances.
- If another remote control for the same garage door drive is available, repeat the

same programming steps with this remote control. Before performing these steps, make sure that new batteries have been installed in garage door drive remote control ⑤.

- Note that some remote controls only transmit for a limited amount of time (the indicator lamp on the remote control goes out). Press button ⑥ on remote control ⑤ again before transmission ends.
- Align the antenna cable of the garage door opener unit. This can improve signal reception/transmission.

### Opening/closing the garage door

After it has been programmed, the integrated garage door opener performs the function of the garage door system remote control. Please also read the operating instructions for the garage door system.

- ▶ Turn the SmartKey to position **2** in the ignition lock.
- ▶ Press button ②, ③ or ④ which you have programmed to operate the garage door. Garage door system with a fixed code: indicator lamp ① lights up green. Garage door system with a rolling code: indicator lamp ① flashes green.
- ❗ The transmitter will transmit a signal as long as the button is pressed. The transmission is halted after a maximum of ten seconds and indicator lamp ① lights up yellow. Press button ②, ③ or ④ again if necessary.

### Clearing the memory

- ▶ Turn the SmartKey to position **2** in the ignition lock.
- ▶ Press buttons ② and ④. The indicator lamp lights up yellow.
- ▶ Press and hold buttons ② and ④ until the indicator lamp turns green.

- 1 Make sure that you clear the memory of the integrated garage door opener before selling the vehicle.

## Compass

### Calling up the compass

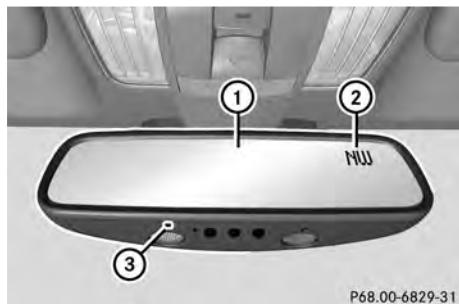

To receive a correct display in rear-view mirror ①, the compass must be calibrated and the magnetic field zone set.

- Briefly press button ③.
- Compass ② displays in which compass direction the vehicle is currently traveling: **N, NE, E, SE, S, SW, W** or **NW**.

## Setting the compass

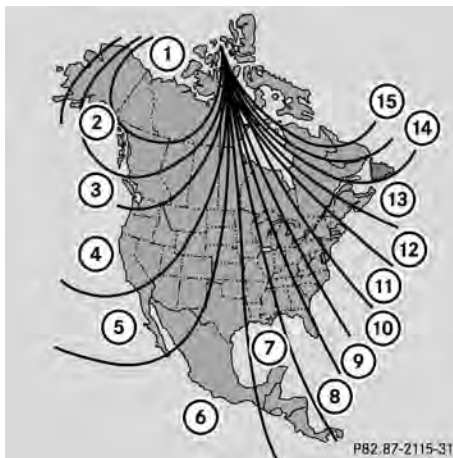

North America zone map

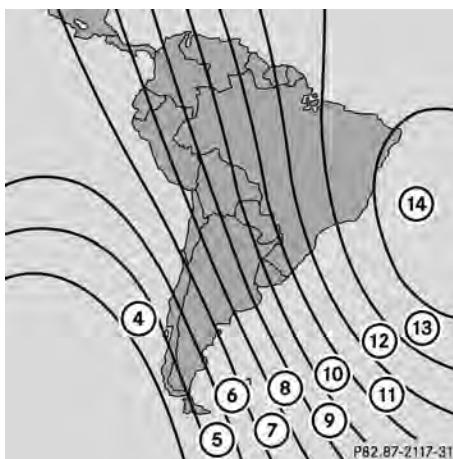

South America zone map

- Set your location using the zone maps.
- Press and hold button ③ (▷ page 302) for approximately three seconds. The zone currently selected appears in compass display ② (▷ page 302).
- **To select the zone:** press button ③ (▷ page 302) repeatedly until the desired zone is selected. The zone has been selected when compass display ② (▷ page 302) shows the heading. This takes a few seconds.



## Calibrating the compass

- ▶ Make sure that there is sufficient space for you to drive in a circle without impeding traffic.

In order to calibrate the compass correctly, do the following:

- calibrate the compass in the open and not in the vicinity of steel structures or high-voltage transmission lines.
- switch off electrical consumers such as the climate control, windshield wipers or rear window defroster.
- close all doors and the trunk lid.
- ▶ Switch on the ignition.
- ▶ Press and hold button ③ (▷ page 302) for approximately six seconds until the **C** symbol appears in compass display ② (▷ page 302).
- ▶ Drive in a full circle at approximately 3 mph (5 km/h) to 6 mph (10 km/h). When the calibration has successfully been completed, the current direction is shown in compass display ② (▷ page 302).

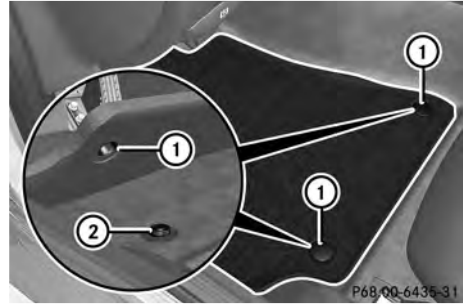

- ▶ Slide the seat backwards.
- ▶ **To install:** place the floor mat in the footwell.
- ▶ Press studs ① onto retainers ②.
- ▶ **To remove:** pull the floor mat off retainers ②.
- ▶ Remove the floor mat.

## Floor mats

### WARNING

Objects in the driver's footwell can restrict the pedal travel or obstruct a depressed pedal. The operating and road safety of the vehicle is jeopardized. There is a risk of an accident.

Make sure that all objects in the vehicle are stowed correctly, and that they cannot enter the driver's footwell. Install the floor mats securely and as specified in order to ensure sufficient clearance for the pedals. Do not use loose floor mats.



Useful information .....	306
Engine compartment .....	306
Maintenance .....	309
Care .....	311

## Useful information

- 1 This Operator's Manual describes all models and all standard and optional equipment of your vehicle available at the time of publication of the Operator's Manual. Country-specific differences are possible. Please note that your vehicle may not be equipped with all features described. This also applies to safety-related systems and functions.
- i Read the information on qualified specialist workshops: (▷ page 26).

## Engine compartment

### Hood

#### Important safety notes

#### WARNING

If the hood is unlatched, it may open up when the vehicle is in motion and block your view. There is a risk of an accident.  
Never unlatch the hood while driving.

#### WARNING

When opening and closing the hood, it may suddenly fall into the closed position. There is a risk of injury to persons within range of movement of the hood.

Open and close the hood only when no one is within its range of movement.

#### WARNING

Certain components in the engine compartment, such as the engine, radiator and parts of the exhaust system, can become very hot. Working in the engine compartment poses a risk of injury.

Where possible, let the engine cool down and touch only the components described in the following.

#### WARNING

Opening the hood when the engine is overheated or when there is a fire in the engine compartment could expose you to hot gases or other service products. There is a risk of injury.

Let an overheated engine cool down before opening the hood. If there is a fire in the engine compartment, keep the hood closed and contact the fire department.

#### WARNING

The engine compartment contains moving components. Certain components, such as the radiator fan, may continue to run or start again suddenly when the ignition is off. There is a risk of injury.

If you need to do any work inside the engine compartment,

- switch off the ignition
- never reach into the area where there is a risk of danger from moving components, such as the fan rotation area
- keep clothing away from moving parts

#### WARNING

The ignition system and the fuel injection system work under high voltage. If you touch components which are under voltage, you could get an electric shock. There is a risk of injury.

Never touch components of the ignition system or fuel injection system when the ignition is switched on.

## Opening the hood

#### WARNING

When the hood is open and the windshield wipers are set in motion, you can be injured by the wiper linkage. There is a risk of injury. Always switch off the windshield wipers and the ignition before opening the hood.

- ❗ Make sure that the windshield wipers are not folded away from the windshield. You could otherwise damage the windshield wipers or the hood.

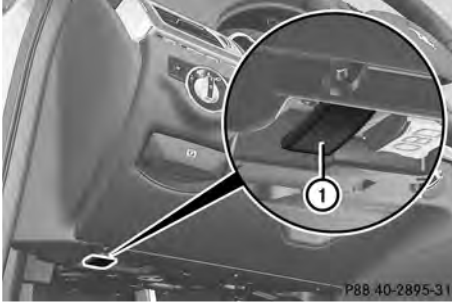

- ▶ Make sure that the windshield wipers are turned off.
- ▶ Pull release lever ① on the hood. The hood is released.

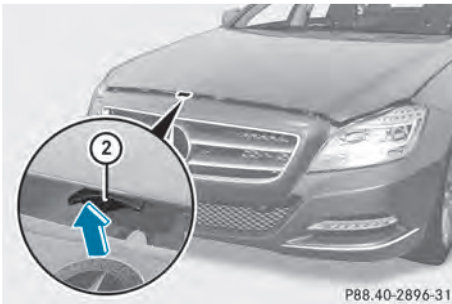

- ▶ Reach into the gap, pull hood catch handle ② up and lift the hood. If you lift the hood by approximately 15 inches (40 cm), the hood is opened and held open automatically by the gas-filled strut.

### Closing the hood

- ▶ Lower the hood and let it fall from a height of approximately 8 inches (20 cm).
- ▶ Check that the hood has engaged properly. If the hood can be raised slightly, it is not properly engaged. Open it again and close it with a little more force.

## Engine oil

### General notes

Depending on the driving style, the vehicle consumes up to 0.9 US qt (0.8 liters) of oil over a distance of 600 miles (1,000 km). The oil consumption may be higher than this when the vehicle is new or if you frequently drive at high engine speeds.

Depending on the engine, the oil dipstick may be in a different location.

When checking the oil level:

- park the vehicle on a level surface.
- the engine should be switched off for approximately five minutes if the engine is at normal operating temperature.
- if the engine is not at normal operating temperature, e.g. if the engine was only started briefly, wait about 30 minutes before carrying out the measurement.

### Checking the oil level using the oil dipstick

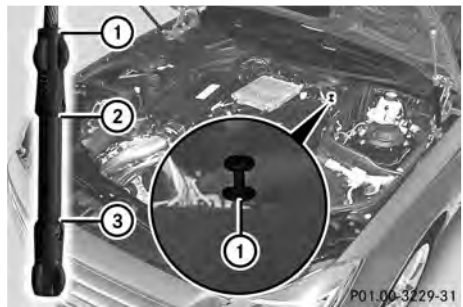

- ▶ Pull oil dipstick ① out of the dipstick guide tube.
- ▶ Wipe off oil dipstick ①.
- ▶ Slowly slide oil dipstick ① into the guide tube to the stop, and take it out again. If the level is between MIN mark ③ and MAX mark ②, the oil level is correct.
- ▶ If the oil level has dropped to MIN mark ③ or below, add 1.1 US qt (1.0 liter) of engine oil.

## Adding engine oil

### WARNING

If engine oil comes into contact with hot components in the engine compartment, it may ignite. There is a risk of fire and injury. Make sure that engine oil is not spilled next to the filler neck. Let the engine cool down and thoroughly clean the engine oil off the components before starting the engine.

### Environmental note

When adding oil, take care not to spill any. If oil enters the soil or waterways, it is harmful to the environment.

- !** Only use engine oils and oil filters that have been approved for vehicles with a service system. You can obtain a list of the engine oils and oil filters tested and approved in accordance with the Mercedes-Benz Specifications for Service Products at any Mercedes-Benz Service center.

Damage to the engine or exhaust system is caused by the following:

- using engine oils and oil filters that have not been specifically approved for the service system
  - replacing engine oil and oil filters after the interval for replacement specified by the service system has been exceeded
  - using engine oil additives.
- !** Do not add too much oil. adding too much engine oil can result in damage to the engine or to the catalytic converter. Have excess engine oil siphoned off.



Example: engine oil cap

- ▶ Turn cap ① counter-clockwise and remove it.
- ▶ Add engine oil.  
If the oil level is at or below the MIN mark on the oil dipstick, add 1.1 US qt (1.0 liter) of engine oil.
- ▶ Replace cap ① on the filler neck and turn clockwise.  
Ensure that the cap locks into place securely.
- ▶ Check the oil level again with the oil dipstick (▷ page 307).

Further information on engine oil (▷ page 375).

## Additional service products

### Checking coolant level

#### WARNING

The engine cooling system is pressurized, particularly when the engine is warm. When opening the cap, you could be scalded by hot coolant spraying out. There is a risk of injury. Let the engine cool down before opening the cap. Wear eye and hand protection when opening the cap. Open the cap slowly half a turn to allow pressure to escape.

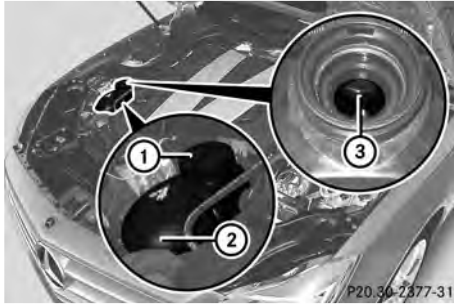

- ▶ Park the vehicle on a level surface.  
Only check the coolant level when the vehicle is on a level surface and the engine has cooled down.
- ▶ Turn the SmartKey to position **2** in the ignition lock (▷ page 147).  
On vehicles with KEYLESS-GO, press the Start/Stop button twice (▷ page 147).
- ▶ Check the coolant temperature display in the instrument cluster.  
The coolant temperature must be below 158 °F (70 °C).
- ▶ Turn the SmartKey to position **0** (▷ page 147) in the ignition lock.
- ▶ Slowly turn cap ① half a turn counter-clockwise to allow excess pressure to escape.
- ▶ Turn cap ① further counter-clockwise and remove it.  
If the coolant is at the level of marker bar ③ in the filler neck when cold, there is enough coolant in coolant expansion tank ②.  
If the coolant level is approximately 0.6 in (1.5 cm) above marker bar ③ in the fuel filler neck when warm, there is enough coolant in expansion tank ②.
- ▶ If necessary, add coolant that has been tested and approved by Mercedes-Benz.
- ▶ Replace cap ① and turn it clockwise as far as it will go.

For further information on coolant, see (▷ page 377).

## Adding washer fluid to the windshield washer system/headlamp cleaning system

### WARNING

Windshield washer concentrate is highly flammable. If it comes into contact with hot engine components or the exhaust system it could ignite. There is a risk of fire and injury. Make sure that no windshield washer concentrate is spilled next to the filler neck.



- ▶ **To open:** pull cap ① upwards by the tab.
- ▶ Add the premixed washer fluid.
- ▶ **To close:** press cap ① onto the filler neck until it engages.

The washer fluid reservoir is used for both the windshield washer system and the headlamp cleaning system.

If the washer fluid level drops below the recommended minimum of 1 liter, a message appears in the multifunction display prompting you to refill the washer fluid (▷ page 262).

Further information on windshield washer fluid/antifreeze (▷ page 378).

## Maintenance

### ASSYST PLUS

#### Service messages

The ASSYST PLUS service interval display informs you of the next service due date.

Information on the type of service and service intervals (see the separate Maintenance Booklet).

You can obtain further information from an authorized Mercedes-Benz Center or at <http://www.mbusa.com> (USA only).

- ❗ The ASSYST PLUS service interval display does not show any information on the engine oil level. Observe the notes on the engine oil level (▷ page 307).

The multifunction display shows a service message for several seconds, e.g.:

- Service A in .. Days
- Service A Due
- Service A Exceeded by .. Days

Depending on the operating conditions of the vehicle, the remaining time or distance until the next service due date is displayed.

The letter **A** or **B**, possibly in connection with a number or another letter, shows the type of service. **A** stands for a minor service and **B** for a major service.

You can obtain further information from an authorized Mercedes-Benz Center.

The ASSYST PLUS service interval display does not take into account any periods of time during which the battery is disconnected.

Maintaining the time-dependent service schedule:

- ▶ Note down the service due date displayed in the multifunction display before disconnecting the battery.

or

- ▶ After reconnecting the battery, subtract the battery disconnection periods from the service date shown on the display.

### Hiding a service message

- ▶ Press the **OK** or **←** button on the steering wheel.

### Displaying service messages

- ▶ Switch on the ignition.
- ▶ Press the **◀** or **▶** button on the steering wheel to select the **Serv.** menu.
- ▶ Press the **▲** or **▼** button to select the **ASSYST PLUS** submenu and confirm by pressing the **OK** button.  
The service due date appears in the multifunction display.

### Information about Service

#### Resetting the ASSYST PLUS service interval display

- ❗ If the ASSYST PLUS service interval display has been inadvertently reset, this setting can be corrected at a qualified specialist workshop.

Have service work carried out as described in the Maintenance Booklet. This may otherwise lead to increased wear and damage to the major assemblies or the vehicle.

A qualified specialist workshop, e.g. an authorized Mercedes-Benz Center, will reset the ASSYST PLUS service interval display after the service work has been carried out. You can also obtain further information on maintenance work, for example.

#### Special service requirements

The specified maintenance interval takes only the normal operation of the vehicle into account. Under arduous operating conditions or increased load on the vehicle, maintenance work must be carried out more frequently, for example:

- regular city driving with frequent intermediate stops
- if the vehicle is primarily used to travel short distances
- use in mountainous terrain or on poor road surfaces
- if the engine is often left idling for long periods



Under these or similar conditions, have, for example, the air filter, engine oil and oil filter replaced or changed more frequently. Under arduous operating conditions, the tires must be checked more often. Further information can be obtained at a qualified specialist workshop, e.g. an authorized Mercedes-Benz Center.

### Driving abroad

An extensive Mercedes-Benz Service network is also available in other countries. You can obtain further information from any authorized Mercedes-Benz Center.

## Care

### General notes

#### Environmental note

Dispose of empty packaging and cleaning cloths in an environmentally responsible manner.

**!** For cleaning your vehicle, do not use any of the following:

- dry, rough or hard cloths
- abrasive cleaning agents
- solvents
- cleaning agents containing solvents

Do not scrub.

Do not touch the surfaces or protective films with hard objects, e.g. a ring or ice scraper. You could otherwise scratch or damage the surfaces and protective film.

**!** Do not park the vehicle for an extended period straight after cleaning it, particularly after having cleaned the wheels with wheel cleaner. Wheel cleaners could cause increased corrosion of the brake discs and brake pads/linings. For this reason, you should drive for a few minutes after cleaning. Braking heats the brake discs and the brake pads/linings, thus drying them. The vehicle can then be parked.

Regular care of your vehicle is a condition for retaining the quality in the long term.

Use care products and cleaning agents recommended and approved by Mercedes-Benz.

### Washing the vehicle and cleaning the paintwork

#### Automatic car wash

#### WARNING

Braking efficiency is reduced after washing the vehicle. There is a risk of an accident.

After the vehicle has been washed, brake carefully while paying attention to the traffic conditions until full braking power is restored.

**!** If DISTRONIC PLUS or the HOLD function is activated, the vehicle brakes automatically in certain situations. To prevent damage to the vehicle, deactivate DISTRONIC PLUS and the HOLD function in the following or other similar situations:

- when towing the vehicle
- in the car wash

**!** Never clean your vehicle in a Touchless Automatic Car Wash as these use special cleaning agents. These cleaning agents can damage the paintwork or plastic parts.

**!** Make sure that:

- the side windows and the sliding sunroof are fully closed.
- the ventilation/heating is switched off (the OFF button has been pressed).
- the windshield wiper switch is in position **0**.

Otherwise, the vehicle might be damaged.

**!** In car washes with a towing mechanism, make sure that the automatic transmission is in transmission position **N**, otherwise the vehicle could be damaged.

- Vehicles with a SmartKey:

Do not remove the SmartKey from the ignition lock. Do not open the driver's door or front-passenger door when the engine is switched off. Otherwise, the automatic transmission selects park position **P** automatically and locks the wheels. You can prevent this by shifting the automatic transmission to **N** beforehand.

- Vehicles with KEYLESS-GO:

Do not open the driver's door or front-passenger door when the engine is switched off. Otherwise, the automatic transmission selects park position **P** automatically and locks the wheels.

Observe the following to make sure that the automatic transmission stays in position **N**:

- ▶ Make sure the vehicle is stationary and the ignition is switched off.
- ▶ Turn the SmartKey to position **2** in the ignition lock (▶ page 147).  
Use the SmartKey instead of the Start/Stop button on vehicles with KEYLESS-GO.
- ▶ Depress and hold the brake pedal.
- ▶ Shift the automatic transmission to position **N**.
- ▶ Release the brake pedal.
- ▶ Release the electric parking brake.
- ▶ Switch off the ignition and leave the SmartKey in the ignition lock.

You can wash the vehicle in an automatic car wash from the very start.

If the vehicle is very dirty, pre-wash it before cleaning it in an automatic car wash.

After using an automatic car wash, wipe off wax from the windshield and the wiper blades. This will prevent smears and reduce wiping noises caused by residue on the windshield.

### Washing by hand

In some countries, washing by hand is only allowed at specially equipped washing bays.

Observe the legal requirements in all countries concerned.

- ▶ Do not use hot water and do not wash the vehicle in direct sunlight.
- ▶ Use a soft sponge to clean.
- ▶ Use a mild cleaning agent, such as a car shampoo approved by Mercedes-Benz.
- ▶ Thoroughly hose down the vehicle with a gentle jet of water.
- ▶ Do not point the water jet directly towards the air inlet.
- ▶ Use plenty of water and rinse out the sponge frequently.
- ▶ Rinse the vehicle with clean water and dry thoroughly with a chamois.
- ▶ Do not let the cleaning agent dry on the paintwork.

When using the vehicle in winter, remove all traces of road salt deposits carefully and as soon as possible.

### Power washers

#### WARNING

The water jet from a circular jet nozzle (dirt blasters) can cause invisible exterior damage to the tires or chassis components. Components damaged in this way may fail unexpectedly. There is a risk of an accident. Do not use power washers with circular jet nozzles to clean the vehicle. Have damaged tires or chassis components replaced immediately.

- ❗ Always maintain a distance of at least 11.8 in (30 cm) between the vehicle and the power washer nozzle. Information about the correct distance is available from the equipment manufacturer.

Move the power washer nozzle around when cleaning your vehicle.

Do not aim directly at any of the following:

- tires
- door gaps, roof gaps, joints, etc.
- electrical components

- battery
- connectors
- lights
- seals
- trim
- ventilation slots

Damaged seals or electrical components can lead to leaks or failures.

## Cleaning the paintwork

**!** Do not affix:

- stickers
- films
- magnetic plates or similar items

to painted surfaces. You could otherwise damage the paintwork.

Scratches, corrosive deposits, areas affected by corrosion and damage caused by inadequate care cannot always be completely repaired. In such cases, visit a qualified specialist workshop.

- ▶ Remove dirt immediately, where possible, while avoiding rubbing too hard.
- ▶ Soak insect remains with insect remover and rinse off the treated areas afterwards.
- ▶ Soak bird droppings with water and rinse off the treated areas afterwards.
- ▶ Remove coolant, brake fluid, tree resin, oils, fuels and greases by rubbing gently with a cloth soaked in petroleum ether or lighter fluid.
- ▶ Use tar remover to remove tar stains.
- ▶ Use silicone remover to remove wax.

If water no longer forms "beads" on the paint surface, use the paint care products recommended and approved by Mercedes-Benz. This is the case approximately every three to five months, depending on the climate conditions and the care product used.

If dirt has penetrated the paint surface or if the paint has become dull, the paint cleaner recommended and approved by Mercedes-Benz should be used.

Do not use these care products in the sun or on the hood while the hood is hot.

- ▶ Use a suitable touch-up stick, e.g. MB Touch-Up Stick, to repair slight damage to the paintwork quickly and provisionally.

## Matte finish care

**!** Never polish the vehicle or the light alloy wheels. Polishing causes the finish to shine.

**!** The following may cause the paint to become shiny and thus reduce the matte effect:

- Vigorous rubbing with unsuitable materials.
- Frequent use of car washes.
- Washing the vehicle in direct sunlight.

**!** Never use paint cleaner, buffing or polishing products, or gloss preserver, e.g. wax. These products are only suitable for high-gloss surfaces. Their use on vehicles with matte finish leads to considerable surface damage (shiny, spotted areas).

Always have paintwork repairs performed at a qualified specialist workshop, e.g. an authorized Mercedes-Benz Center.

**!** Do not use wash programs with a hot wax treatment under any circumstances.

Observe these notes if your vehicle has a clear matte finish. This will help you to avoid damage to the paintwork due to incorrect treatment.

These notes also apply to light alloy wheels with a clear matte finish.

- i** The vehicle should preferably be washed by hand using a soft sponge, car shampoo and plenty of water.
- i** Use only insect remover and car shampoo from the range of recommended and approved Mercedes-Benz care products.

## Cleaning the vehicle parts

### Cleaning the wheels

- ❗ Do not use acidic wheel cleaning products to remove brake dust. This could damage wheel bolts and brake components.
- ❗ Do not park the vehicle for an extended period straight after cleaning it, particularly after having cleaned the wheels with wheel cleaner. Wheel cleaners could cause increased corrosion of the brake discs and brake pads/linings. For this reason, you should drive for a few minutes after cleaning. Braking heats the brake discs and the brake pads/linings, thus drying them. The vehicle can then be parked.

### Cleaning the windows

#### WARNING

You could become trapped by the windshield wipers if they start moving while cleaning the windshield or wiper blades. There is a risk of injury.

Always switch off the windshield wipers and the ignition before cleaning the windshield or wiper blades.

- ❗ Do not use dry cloths, abrasive products, solvents or cleaning agents containing solvents to clean the inside of the windows. Do not touch the insides of the windows with hard objects, e.g. an ice scraper or ring. There is otherwise a risk of damaging the windows.
- ❗ Clean the water drainage channels of the windshield and the rear window at regular intervals. Deposits such as leaves, petals and pollen may under certain circumstances prevent water from draining away. This can lead to corrosion damage and damage to electronic components.
- ▶ Clean the inside and outside of the windows with a damp cloth and a cleaning product that is recommended and approved by Mercedes-Benz.

## Cleaning wiper blades

#### WARNING

You could become trapped by the windshield wipers if they start moving while cleaning the windshield or wiper blades. There is a risk of injury.

Always switch off the windshield wipers and the ignition before cleaning the windshield or wiper blades.

- ❗ Do not pull the wiper blade. Otherwise, the wiper blade could be damaged.
- ❗ Do not clean wiper blades too often and do not rub them too hard. Otherwise, the graphite coating could be damaged. This could cause wiper noise.
- ❗ Hold the wiper arm securely when folding back. The windshield could be damaged if the wiper arm smacks against it suddenly.
- ▶ Fold the windshield wiper arms away from the windshield.
- ▶ Carefully clean the wiper blades with a damp cloth.
- ▶ Fold the windshield wiper arms back again before switching on the ignition.

## Cleaning the exterior lighting

- ❗ Only use cleaning agents or cleaning cloths which are suitable for plastic light lenses. Unsuitable cleaning agents or cleaning cloths could scratch or damage the plastic light lenses.
- ▶ Clean the plastic lenses of the exterior lighting using a wet sponge and a mild cleaning agent, e.g. Mercedes-Benz car shampoo or cleaning cloths.

## Mirror turn signals

- ❗ Only use cleaning agents or cleaning cloths that are suitable for plastic lenses. Unsuitable cleaning agents or cleaning cloths could scratch or damage the plastic lenses of the mirror turn signals.

- ▶ Clean the plastic lenses of the mirror turn signals in the exterior mirror housing using a wet sponge and mild cleaning agent, e.g. Mercedes-Benz car shampoo or cleaning cloths.

### Cleaning the sensors

- ⚠ If you clean the sensors with a power washer, make sure that you keep a distance of at least 11.8 in (30 cm) between the vehicle and the power washer nozzle. Information about the correct distance is available from the equipment manufacturer.

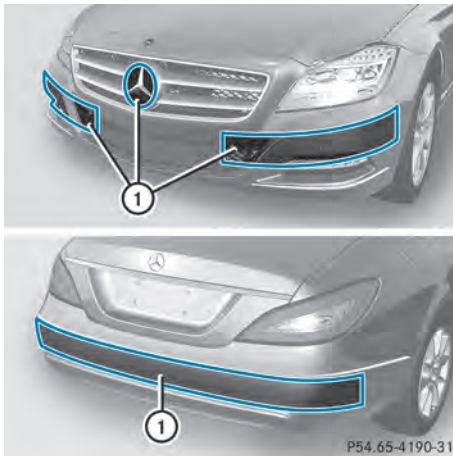

- ▶ Clean sensors ① of the driving systems with water, car shampoo and a soft cloth.

### Cleaning the rear view camera

- ⚠ Do not clean the camera lens and the area around the rear view camera with a power washer.

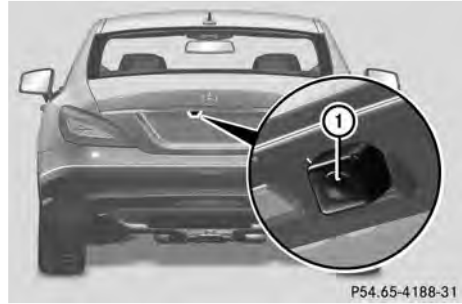

- ▶ Use clear water and a soft cloth to clean camera lens ①.

### Cleaning the exhaust pipes

- ⚠ Do not clean the exhaust pipe with acid-based cleaning agents such as sanitary cleansers or wheel cleaners.

Impurities combined with the effects of road grit and corrosive environmental factors may cause flash rust to form on the surface. You can restore the original shine of the exhaust pipe by cleaning it regularly, especially in winter and after washing.

- ▶ Clean the exhaust pipe with a care product tested and approved by Mercedes-Benz.

### Interior care

#### Cleaning the display

- ⚠ For cleaning, do not use any of the following:

- alcohol-based thinner or gasoline
- abrasive cleaning agents
- commercially-available household cleaning agents

These may damage the display surface. Do not put pressure on the display surface when cleaning. This could lead to irreparable damage to the display.

- ▶ Before cleaning the display, make sure that it is switched off and has cooled down.
- ▶ Clean the display surface using a commercially available microfiber cloth and TFT/LCD display cleaner.
- ▶ Dry the display surface using a dry microfiber cloth.

### Cleaning Night View Assist Plus

- ❗ Never clean the camera lens. When cleaning the field of vision of the driving systems, make sure that you do not spray glass cleaner on the camera lens. If the camera lens is dirty, visit a qualified specialist workshop.

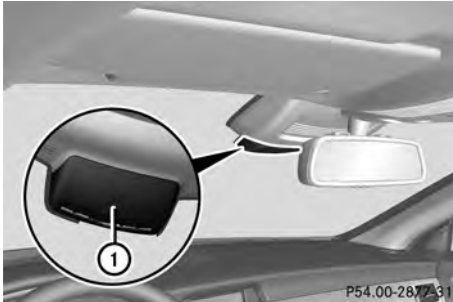

- ▶ Fold down the camera cover by recess ①.

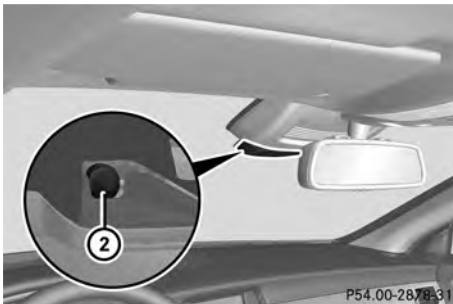

- ▶ Use a soft cloth to clean the windshield in front of camera ②.

### Cleaning the plastic trim

#### ⚠ WARNING

Care products and cleaning agents containing solvents cause surfaces in the cockpit to become porous. As a result, plastic parts may come loose in the event of air bag deployment. There is a risk of injury.

Do not use any care products and cleaning agents to clean the cockpit.

- ❗ Do not affix the following to plastic surfaces:

- stickers
- films
- scented oil bottles or similar items

You can otherwise damage the plastic.

- ❗ Do not allow cosmetics, insect repellent or sunscreen to come into contact with the plastic trim. This maintains the high-quality look of the surfaces.

- ▶ Wipe the plastic trim with a damp, lint-free cloth, e.g. a microfiber cloth.

- ▶ **Heavy soiling:** use care and cleaning products recommended and approved by Mercedes-Benz.

The surface may change color temporarily. Wait until the surface is dry again.

### Cleaning the steering wheel and gear or selector lever

- ▶ Thoroughly wipe with a damp cloth or use leather care agents that have been recommended and approved by Mercedes-Benz.

### Cleaning genuine wood and trim elements

- ❗ Do not use solvent-based cleaning agents such as tar remover, wheel cleaners, polishes or waxes. There is otherwise a risk of damaging the surface.

- ❗ Do not use chrome polish on trim pieces. The trim pieces have a chrome look but are

mostly made of anodized aluminum and can lose their shine if chrome polish is used. Use a damp, lint-free cloth instead when cleaning the trim pieces.

If the chrome-plated trim pieces are very dirty, you can use a chrome polish. If you are unsure as to whether the trim pieces are chrome-plated or not, consult an authorized Mercedes-Benz Center.

- ▶ Wipe the wooden trim and trim pieces with a damp, lint-free cloth, e.g. a microfiber cloth.
- ▶ **Heavy soiling:** use car care and cleaning products recommended and approved by Mercedes-Benz.

## Cleaning the seat covers

### General notes

- ❗ Do not use microfiber cloths to clean genuine leather, artificial leather or Alcantara® covers. If used often, these can damage the cover.
- ❗ Note that regular care is essential to ensure that the appearance and comfort of the covers is retained over time.

### Genuine leather seat covers

Leather is a natural product.

It exhibits natural surface characteristics, for example:

- Differences in the texture
- Signs of stretching and marking
- Slight nuances of color

These are characteristics of leather and not material defects.

❗ To retain the natural appearance of the leather, observe the following cleaning instructions:

- Clean genuine leather covers carefully with a damp cloth and then wipe the covers down with a dry cloth.
- Make sure that the leather does not become soaked. It may otherwise become rough and cracked.
- Only use leather care agents that have been tested and approved by Mercedes-Benz. You can obtain these from a qualified specialist workshop.

### Seat covers of other materials

❗ Observe the following when cleaning:

- Clean artificial leather covers with a cloth moistened with a solution containing 1% detergent (e.g. dish washing liquid).
- Clean cloth covers with a microfiber cloth moistened with a solution containing 1% detergent (e.g. dish washing liquid). Rub carefully and always wipe entire seat sections to avoid leaving visible lines. Leave the seat to dry afterwards. Cleaning results depend on the type of dirt and how long it has been there.
- Clean Alcantara® covers with a damp cloth. Make sure that you wipe entire seat sections to avoid leaving visible lines.

## Cleaning the seat belts

### ⚠ WARNING

Seat belts can become severely weakened if bleached or dyed. This could cause the seat belts to tear or fail, for instance, in the event of an accident. This poses an increased risk of injury or fatal injury.

Never bleach or dye the seat belts.

- ❗ Do not clean the seat belts using chemical cleaning agents. Do not dry the seat belts

by heating at temperatures above 176 °F (80 °C) or in direct sunlight.

- ▶ Use clean, lukewarm water and soap solution.

### Cleaning the headliner and carpets

- ▶ **Headliner:** if it is very dirty, use a soft brush or dry shampoo.
- ▶ **Carpets:** use the carpet and textile cleaning agents recommended and approved by Mercedes-Benz.



Useful information .....	320
Where will I find...? .....	320
Flat tire .....	321
Battery (vehicle) .....	322
Jump-starting .....	326
Towing and tow-starting .....	328
Fuses .....	331

### Useful information

**i** This Operator's Manual describes all models and all standard and optional equipment of your vehicle available at the time of publication of the Operator's Manual. Country-specific differences are possible. Please note that your vehicle may not be equipped with all features described. This also applies to safety-related systems and functions.

**i** Read the information on qualified specialist workshops: (▷ page 26).

### Where will I find...?

#### First-aid kit

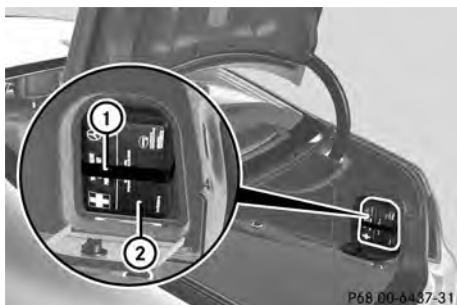

- ▶ Open the trunk lid.
- ▶ Slide the stowage net down.
- ▶ Open the stowage compartment.
- ▶ Release tensioning strap ①.
- ▶ Remove first-aid kit ②.

**i** Check the expiration date on the first-aid kit at least once a year. Replace the contents if necessary, and replace missing items.

#### Vehicle tool kit

#### General notes

The vehicle tool kit can be found in the stowage well under the trunk floor.

### Vehicles with a "Minispare" emergency spare wheel

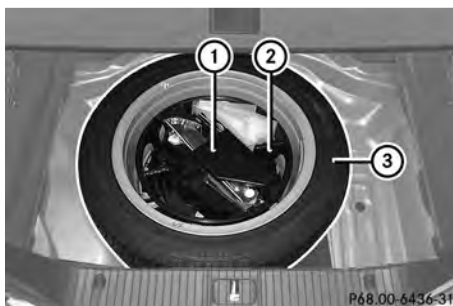

- ① Vehicle tool kit tray
- ② Stowage well
- ③ "Minispare" emergency spare wheel

- ▶ Open the trunk lid.
- ▶ Lift the trunk floor upwards (▷ page 283).

The vehicle tool kit contains:

- Folding wheel chock
- Fuse allocation chart
- Jack
- Alignment bolt
- One pair of gloves
- Lug wrench
- Towing eye

### Vehicles with a collapsible spare wheel (AMG vehicles)

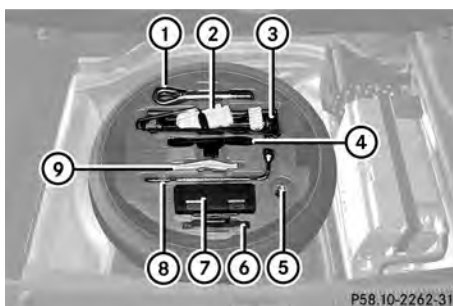

- ① Towing eye
- ② One pair of gloves
- ③ Jack
- ④ Folding wheel chock

- ⑤ Alignment bolt
- ⑥ Sheet for faulty wheel
- ⑦ Tire inflation compressor
- ⑧ Lug wrench
- ⑨ Fuse allocation chart
- ▶ Open the trunk lid.
- ▶ Lift the trunk floor upwards (▷ page 283).

## Flat tire

### Preparing the vehicle

Your vehicle may be equipped with:

- MOExtended tires (tires with run-flat properties) (▷ page 321)  
Vehicle preparation is not necessary on vehicles with MOExtended tires.
- an emergency spare wheel (▷ page 367)

Information on changing/mounting a wheel (▷ page 357).

- ▶ Stop the vehicle on solid, non-slippery and level ground, as far away as possible from traffic.
- ▶ Switch on the hazard warning lamps.
- ▶ Secure the vehicle against rolling away (▷ page 167).
- ▶ If possible, bring the front wheels into the straight-ahead position.
- ▶ Vehicles with AIRMATIC: make sure that "normal" level is selected (▷ page 189).
- ▶ Switch off the engine.
- ▶ **Vehicles without KEYLESS-GO:** remove the SmartKey from the ignition lock.
- ▶ **Vehicles with KEYLESS-GO:** open the driver's door.  
The on-board electronics now have status **O**. This is the same as the SmartKey having been removed.
- ▶ **Vehicles with KEYLESS-GO:** remove the Start/Stop button from the ignition lock (▷ page 147).

- ▶ All occupants must get out of the vehicle. Make sure that they are not endangered as they do so.
- ▶ Make sure that no one is near the danger area while a wheel is being changed. Anyone who is not directly assisting in the wheel change should, for example, stand behind the barrier.
- ▶ Get out of the vehicle. Pay attention to traffic conditions when doing so.
- ▶ Close the driver's door.

### MOExtended tires (tires with run-flat properties)

#### General notes

With MOExtended tires (tires with run flat characteristics), you can continue to drive your vehicle even if there is a total loss of pressure in one or more tires. The affected tire must not show any clearly visible damage.

You can recognize MOExtended tires by the MOExtended marking which appears on the sidewall of the tire. You will find this marking next to the tire size designation, the load-bearing capacity and the speed index (▷ page 351).

MOExtended tires may only be used in conjunction with an active tire pressure loss warning system or with an active tire pressure monitor.

#### If the pressure loss warning message appears in the multifunction display:

- Observe the instructions in the display messages (▷ page 258).
- Check the tire for damage.
- If driving on, observe the following notes.

The maximum driving distance is approximately 50 miles (80 km) when the vehicle is partially laden and approximately 18 miles (30 km) when the vehicle is fully laden.

In addition to the vehicle load, the driving distance possible depends upon:

- Speed
- Road condition
- Outside temperature

The driving distance possible in run-flat mode may be reduced by extreme driving conditions/maneuvers, or it can be increased through a moderate style of driving.

The maximum permissible distance which can be driven in run-flat mode is counted from the moment the tire pressure loss warning appears in the multifunction display.

You must not exceed a maximum speed of 50 mph (80 km/h).

**i** When replacing one or all tires, make sure that you use only tires:

- of the size specified for the vehicle and
- marked "MOExtended"

If a tire has gone flat and cannot be replaced with a MOExtended tire, a standard tire may be used as a temporary measure. Make sure that you use the proper size and type (summer or winter tire).

### Important safety notes

#### WARNING

When driving in emergency mode, the driving characteristics deteriorate, e.g. when cornering, accelerating quickly and when braking. There is a risk of an accident.

Do not exceed the stated maximum speed. Avoid abrupt steering and driving maneuvers, and driving over obstacles (curbs, potholes, off-road). This applies in particular to a laden vehicle.

Stop driving in emergency mode if:

- you hear banging noises.
- the vehicle starts to shake.
- you see smoke and smell rubber.

- ESP® is intervening constantly.
- there are tears in the sidewalls of the tire.

After driving in emergency mode, have the wheel rims checked at a qualified specialist workshop with regard to their further use. The defective tire must be replaced in every case.

### Battery (vehicle)

#### Important safety notes

Special tools and expert knowledge are required when working on the battery, e.g. removal and installing. You should therefore have all work involving the battery carried out at a qualified specialist workshop.

#### WARNING

Work carried out incorrectly on the battery can lead, for example, to a short circuit and thus damage the vehicle electronics. This can lead to function restrictions applying to safety-relevant systems, e.g. the lighting system, ABS (anti-lock braking system) or ESP® (Electronic Stability Program). The operating safety of your vehicle may be restricted. You could lose control of the vehicle, for example:

- braking
- in the event of abrupt steering maneuver and/or when the vehicle's speed is not adapted to the road conditions

There is a risk of an accident.

In the event of a short circuit or a similar incident, contact a qualified specialist workshop immediately. Do not drive any further. You should have all work involving the battery carried out at a qualified specialist workshop.

#### WARNING

Electrostatic build-up can lead to the creation of sparks, which could ignite the highly explosive gases of a battery. There is a risk of an explosion.

Before handling the battery, touch the vehicle body to remove any existing electrostatic build-up.

The highly flammable gas mixture forms when charging the battery as well as when jump-starting.

Always make sure that neither you nor the battery is electrostatically charged. A build-up of electrostatic charge can be caused, for example:

- by wearing clothing made from synthetic fibers
- due to friction between clothing and seats
- if you push or pull the battery across the carpet or other synthetic materials
- if you wipe the battery with a cloth

 **WARNING**

During the charging process, a battery produces hydrogen gas. If a short circuit occurs or sparks are created, the hydrogen gas can ignite. There is a risk of an explosion.

- Make sure that the positive terminal of a connected battery does not come into contact with vehicle parts.
- Never place metal objects or tools on a battery.
- It is important that you observe the described order of the battery terminals when connecting and disconnecting a battery.
- When jump-starting, make sure that the battery poles with identical polarity are connected.
- It is particularly important to observe the described order when connecting and disconnecting the jumper cables.
- Never connect or disconnect the battery terminals while the engine is running.

 **WARNING**

Battery acid is caustic. There is a risk of injury. Avoid contact with the skin, eyes or clothing. Do not inhale any battery gases. Do not lean

over the battery. Keep children away from batteries. Wash battery acid immediately with water and seek medical attention.

 **Environmental note**



Batteries contain dangerous substances. It is against the law to dispose of them with the household rubbish. They must be collected separately and recycled to protect the environment.



Dispose of batteries in an environmentally friendly manner. Take discharged batteries to a qualified specialist workshop or a special collection point for used batteries.

- ❗ Have the battery checked regularly at a qualified specialist workshop. Observe the service intervals in the Maintenance Booklet or contact a qualified specialist workshop for more information.
- ❗ You should have all work involving the battery carried out at a qualified specialist workshop. In the exceptional case that it is necessary for you to disconnect the battery yourself, make sure that:
  - you switch off the engine and remove the SmartKey. On vehicles with KEYLESS-GO, ensure that the ignition is switched off. Check that all the indicator lamps in the instrument cluster are off. Otherwise, electronic components, such as the alternator, may be damaged.
  - you first remove the negative terminal clamp and then the positive terminal clamp. Never swap the terminal clamps. Otherwise, the vehicle's electronic system may be damaged.
  - the transmission is locked in position **P** after disconnecting the battery. The vehicle is secured against rolling away. You can then no longer move the vehicle.

The battery and the cover of the positive terminal clamp must be installed securely during operation.

Comply with safety precautions and take protective measures when handling batteries.



Risk of explosion.



Fire, open flames and smoking are prohibited when handling the battery. Avoid creating sparks.



Battery acid is caustic. Avoid contact with skin, eyes or clothing. Wear suitable protective clothing, especially gloves, apron and faceguard.

Rinse any acid spills immediately with clear water. Contact a physician if necessary.

Wear eye protection.



Keep children away.



Observe this Operator's Manual.

For safety reasons, Mercedes-Benz recommends that you only use batteries which have been tested and approved for your vehicle by Mercedes-Benz. These batteries provide increased impact protection to prevent vehicle occupants from suffering acid burns should the battery be damaged in the event of an accident.

In order for the battery to achieve the maximum possible service life, it must always be sufficiently charged.

The vehicle battery, like other batteries, can discharge over time if you do not use the vehicle. In this case, have the battery

disconnected at a qualified specialist workshop. You can also charge the battery with a charger recommended by Mercedes-Benz. Contact a qualified specialist workshop for further information.

Have the battery condition of charge checked more frequently if you use the vehicle mainly for short trips or if you leave it standing idle for a lengthy period. Consult a qualified specialist workshop if you wish to leave your vehicle parked for a long period of time.

**i** Remove the SmartKey if you park the vehicle and do not require any electrical consumers. The vehicle will then use very little energy, thus conserving battery power.

**i** If the power supply has been interrupted, e.g. if you reconnect the battery, you will have to:

- set the clock. Information on setting the clock can be found in the separate operating instructions. On vehicles with COMAND and a navigation system, the clock is set automatically.
- reset the function for folding the exterior mirrors in/out automatically, by folding the mirrors out once (▷ page 110).

### Charging the battery

#### WARNING

During charging and jump-starting, explosive gases can escape from the battery. There is a risk of an explosion.

Particularly avoid fire, open flames, creating sparks and smoking. Ensure there is sufficient ventilation while charging and jump-starting. Do not lean over a battery.

#### WARNING

Battery acid is caustic. There is a risk of injury. Avoid contact with the skin, eyes or clothing. Do not inhale any battery gases. Do not lean

over the battery. Keep children away from batteries. Wash battery acid immediately with water and seek medical attention.

 **WARNING**

A discharged battery can freeze at temperatures below freezing point. When jump-starting the vehicle or charging the battery, gases can escape from the battery. There is a risk of an explosion.

Allow the frozen battery to thaw out before charging it or jump-starting.

 Only use battery chargers with a maximum charging voltage of 14.8 V.

 Only charge the battery using the jump-starting connection point.

The jump-starting connection point is in the engine compartment (▷ page 326).

- ▶ Open the hood (▷ page 306).
- ▶ Connect the battery charger to the positive terminal and ground point in the same order as when connecting the donor battery in the jump-starting procedure (▷ page 326).

If, at low temperatures, the indicator lamps/warning lamps in the instrument cluster do not light up, it is highly likely that the discharged battery has frozen. In this case, you may neither charge the battery nor jump-start the vehicle. The service life of a thawed-out battery may be shorter. The starting characteristics may be impaired, especially at low temperatures. Have the thawed-out battery checked at a qualified specialist workshop.

Never charge a battery still installed in the vehicle unless a battery charger unit approved by Mercedes-Benz is being used. A battery charger unit specially adapted for Mercedes-Benz vehicles and tested and approved by Mercedes-Benz is available as an accessory. It permits the charging of the battery in its installed position. Contact an authorized Mercedes-Benz Center for further

information and availability. Read the battery charger's operating instructions before charging the battery.

## Jump-starting

For the jump-starting procedure, use only the jump-starting connection point, consisting of a positive terminal and an earth point, in the engine compartment.

### WARNING

Battery acid is caustic. There is a risk of injury.

Avoid contact with the skin, eyes or clothing. Do not inhale any battery gases. Do not lean over the battery. Keep children away from batteries. Wash battery acid immediately with water and seek medical attention.

### WARNING

During charging and jump-starting, explosive gases can escape from the battery. There is a risk of an explosion.

Particularly avoid fire, open flames, creating sparks and smoking. Ensure there is sufficient ventilation while charging and jump-starting. Do not lean over a battery.

### WARNING

During the charging process, a battery produces hydrogen gas. If a short circuit occurs or sparks are created, the hydrogen gas can ignite. There is a risk of an explosion.

- Make sure that the positive terminal of a connected battery does not come into contact with vehicle parts.
- Never place metal objects or tools on a battery.
- It is important that you observe the described order of the battery terminals when connecting and disconnecting a battery.
- When jump-starting, make sure that the battery poles with identical polarity are connected.
- It is particularly important to observe the described order when connecting and disconnecting the jumper cables.
- Never connect or disconnect the battery terminals while the engine is running.

### WARNING

A discharged battery can freeze at temperatures below freezing point. When jump-starting the vehicle or charging the battery, gases can escape from the battery. There is a risk of an explosion. Allow the frozen battery to thaw out before charging it or jump-starting.

- ❗ Avoid repeated and lengthy starting attempts. Otherwise, the catalytic converter could be damaged by the non-combusted fuel.

Do not start the vehicle using a rapid charging device. If your vehicle's battery is discharged, the engine can be jump-started from another vehicle or from a second battery using jumper cables. Observe the following points:

- The battery is not accessible in all vehicles. If the other vehicle's battery is not accessible, jump-start the vehicle using a second battery or a jump-starting device.
- You may only jump-start the vehicle when the engine and exhaust system are cold.
- Do not start the engine if the battery is frozen. Let the battery thaw first.





- ▶ First, remove the jumper cables from earth point ⑤ and negative terminal ④, then from positive clamp ② and positive terminal ③. Begin each time at the contacts on your own vehicle first.
  - ▶ Close cover ① of positive clamp ② after removing the jumper cables.
  - ▶ Have the battery checked at a qualified specialist workshop.
- i** Jump-starting is not considered to be a normal operating condition.
- i** Jumper cables and further information regarding jump-starting can be obtained at any qualified specialist workshop.

## Towing and tow-starting

### Important safety notes

#### WARNING

Functions relevant to safety are restricted or no longer available if:

- the engine is not running.
- the brake system or the power steering is malfunctioning.
- there is a malfunction in the voltage supply or the vehicle's electrical system.

If your vehicle is being towed, much more force may be necessary to steer or brake. There is a risk of an accident.

In such cases, use a tow bar. Before towing, make sure that the steering moves freely.

#### WARNING

If the weight of the vehicle to be towed or tow-started is greater than the permissible gross weight of your vehicle:

- the towing eye could detach itself
- the vehicle/trailer combination could rollover.

There is a risk of an accident.

When towing or tow-starting another vehicle, its weight should not be greater than the permissible gross weight of your vehicle.

Information on your vehicle's gross vehicle weight rating can be found on the vehicle identification plate (▷ page 372).

**!** If DISTRONIC PLUS or the HOLD function is activated, the vehicle brakes automatically in certain situations. To prevent damage to the vehicle, deactivate DISTRONIC PLUS and the HOLD function in the following or other similar situations:

- when towing the vehicle
- in the car wash

**!** Only secure the tow rope or tow bar at the towing eyes. Otherwise, the vehicle could be damaged.

**!** Do not use the towing eye for recovery, this could damage the vehicle. If in doubt, recover the vehicle with a crane.

**!** When towing, pull away slowly and smoothly. If the tractive power is too high, the vehicles could be damaged.

**!** Do not tow with sling-type equipment. This could damage the vehicle.

**!** When towing vehicles with KEYLESS-GO, use the key instead of the Start/Stop button. Otherwise, the automatic transmission may shift to position **P** when the driver's or front-passenger door are opened, which could lead to damage to the transmission.

**!** The vehicle can be towed a maximum of 30 miles (50km). The towing speed of 30 mph (50 km/h) must not be exceeded. If the vehicle has to be towed more than 30 miles (50km), the entire vehicle must be raised and transported.

It is better to have the vehicle transported than to have it towed.

If the vehicle has suffered transmission damage, have it transported on a transporter or trailer.

The automatic transmission must be in position **N** when the vehicle is being towed. The battery must be connected and charged. Otherwise, you:

- cannot turn the SmartKey to position **2** in the ignition lock
- cannot shift the automatic transmission to position **N**

**i** Deactivate the automatic locking feature (▷ page 83). You could otherwise be locked out when pushing or towing the vehicle.

### Installing/removing the towing eye

#### Installing the towing eye

#### WARNING

The exhaust tail pipe may be very hot. There is a risk of burns when removing the rear cover.

Do not touch the exhaust pipe. Take particular care when removing the rear cover.

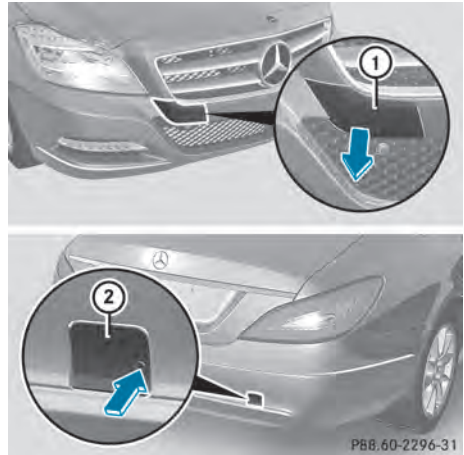

Example: towing eye covers

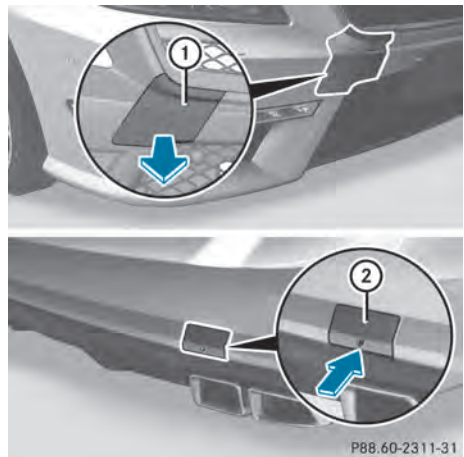

Towing eye covers (AMG vehicles)

The mountings for the removable towing eyes are located in the bumpers. They are at the front and at the rear, behind the covers.

- ▶ Remove the towing eye from the vehicle tool kit (▷ page 320).
- ▶ Pull cover **1** out of the bumper in the direction of the arrow by inserting your fingers into the recess.
- ▶ Press the mark on cover **2** inwards in the direction of the arrow.

- ▶ Take cover ② off the opening.
- ▶ Screw in and tighten the towing eye clockwise to the stop.

### Removing the towing eye

- ▶ Unscrew and remove the towing eye.
- ▶ Position the top of cover ① in the bumper and press it in at the bottom until it engages.
- ▶ Attach cover ② to the bumper and press until it engages.
- ▶ Place the towing eye in the vehicle tool kit.

### Towing the vehicle with the rear axle raised

- ❗ The ignition must be switched off if you are towing the vehicle with the rear axle raised. Intervention by ESP® could otherwise damage the brake system.

### Only possible for vehicles without 4MATIC.

- ▶ Switch on the hazard warning lamps (▷ page 120).
- ▶ Turn the SmartKey to position **0** in the ignition lock and remove the SmartKey from the ignition lock.
- ▶ When leaving the vehicle, take the SmartKey or the KEYLESS-GO key with you.

When towing your vehicle with the rear axle raised, it is important that you observe the safety instructions (▷ page 328).

### Towing a vehicle with both axles on the ground

It is important that you observe the safety instructions when towing away your vehicle (▷ page 328).

The automatic transmission automatically shifts to position **P** when you open the driver's or front-passenger door or when you remove the SmartKey from the ignition lock. In order to ensure that the automatic transmission stays in position **N** when towing the vehicle, you must observe the following points:

- ▶ Make sure that the vehicle is stationary and the SmartKey in the ignition lock is in position **0**.
- ▶ Turn the SmartKey to position **2** in the ignition lock.

On vehicles with KEYLESS-GO, use the SmartKey instead of the Start/Stop button (▷ page 147).

- ▶ Depress and hold the brake pedal.
- ▶ Shift the automatic transmission to position **N**.
- ▶ Release the brake pedal.
- ▶ Release the parking brake.
- ▶ Switch on the hazard warning lamps (▷ page 120).
- ▶ Leave the SmartKey in position **2** in the ignition lock.

- ❗ When towing with the hazard warning lamps switched on, use the combination switch as usual to signal a change of direction. In this case, only the indicator lamps for the direction of travel flash. After resetting the combination switch, the hazard warning lamp starts flashing again.

### Transporting the vehicle

- ❗ Only lash the vehicle down by the wheels or wheel rims, not by parts of the vehicle such as axle or steering components. Otherwise, the vehicle could be damaged.

The towing eye can be used to pull the vehicle onto a trailer or transporter for transporting purposes.

- ▶ Turn the SmartKey to position **2** in the ignition lock.
- ▶ Shift the automatic transmission to position **N**.

#### As soon as the vehicle is loaded:

- ▶ Prevent the vehicle from rolling away by applying the parking brake.
- ▶ Shift the automatic transmission to position **P**.
- ▶ Turn the SmartKey to position **0** in the ignition lock and remove the SmartKey from the ignition lock.
- ▶ Secure the vehicle.

#### Notes on 4MATIC vehicles

**!** Vehicles with 4MATIC must not be towed with either the front or the rear axle raised, as doing so will damage the transmission.

If the vehicle has transmission damage or damage to the front or rear axle, have it transported on a transporter or trailer.

#### In the event of damage to the electrical system

If the battery is defective, the automatic transmission will be locked in position **P**. To shift the automatic transmission to position **N**, you must provide power to the vehicle's electrical system in the same way as when jump-starting (▷ page 326).

Have the vehicle transported on a transporter or trailer.

#### Tow-starting (emergency engine starting)

**!** Vehicles with automatic transmission must not be started by tow-starting. This could otherwise damage the transmission.

You can find information on "Jump-starting" at (▷ page 326).

## Fuses

### Important safety notes

#### WARNING

If you manipulate or bridge a faulty fuse or if you replace it with a fuse with a higher amperage, the electric cables could be overloaded. This could result in a fire. There is a risk of an accident and injury.

Always replace faulty fuses with the specified new fuses having the correct amperage.

**!** Only use fuses that have been approved for Mercedes-Benz vehicles and which have the correct fuse rating for the system concerned. Otherwise, components or systems could be damaged.

The fuses in your vehicle serve to close down faulty circuits. If a fuse blows, all the components on the circuit and their functions stop operating.

Blown fuses must be replaced with fuses of the same rating, which you can recognize by the color and value. The fuse ratings are listed in the fuse allocation chart.

If a newly inserted fuse also blows, have the cause traced and rectified at a qualified specialist workshop, e.g. an authorized Mercedes-Benz Center.

### Before changing a fuse

- ▶ Secure the vehicle against rolling away (▷ page 167).
  - ▶ Switch off all electrical consumers.
  - ▶ Turn the SmartKey to position **0** in the ignition lock and remove it (▷ page 147).
- or
- ▶ On vehicles with KEYLESS-GO, make sure the ignition is switched off (▷ page 147).

All indicator lamps in the instrument cluster must be off.

The fuses are located in various fuse boxes:

- Fuse box in the engine compartment on the left-hand side of the vehicle, when viewed in the direction of travel
- fuse box in the trunk on the right-hand side, when viewed in the direction of travel

the fuse allocation chart is located in the vehicle tool kit in the stowage compartment under the trunk floor (▷ page 320).

### Fuse box in the engine compartment

#### WARNING

When the hood is open and the windshield wipers are set in motion, you can be injured by the wiper linkage. There is a risk of injury. Always switch off the windshield wipers and the ignition before opening the hood.

- ! Make sure that no moisture can enter the fuse box when the cover is open.
- ! When closing the cover, make sure that it is lying correctly on the fuse box. Moisture seeping in or dirt could otherwise impair the operation of the fuses.
- ▶ Make sure that the windshield wipers are turned off.
- ▶ Open the hood.

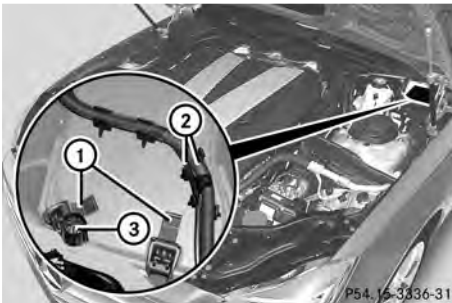

- ▶ Use a dry cloth to remove any moisture from the fuse box.
- ▶ **To open:** remove lines ② from the guides.
- ▶ Move lines ② aside. Route the lines behind connection ③ to do this.

- ▶ Open clamp ①.
- ▶ Remove the fuse box cover forwards.
- ▶ **To close:** check whether the rubber seal is lying correctly in the cover.
- ▶ Insert the cover at the rear of the fuse box into the retainer.
- ▶ Fold down cover and close clamps ①.
- ▶ Secure lines ② in the guides.
- ▶ Close the hood.

### Fuse box in the trunk

- ! Make sure that no moisture can enter the fuse box when the cover is open.
- ! When closing the cover, make sure that it is lying correctly on the fuse box. Moisture seeping in or dirt could otherwise impair the operation of the fuses.
- ▶ Open the trunk lid.



- ▶ **To open:** release cover ① at the top right and left-hand sides with a flat object.
- ▶ Open cover ① downwards in the direction of the arrow.

Useful information .....	334
Important safety notes .....	334
Operation .....	334
Winter operation .....	336
Check .....	338
Loading the vehicle .....	345
All about wheels and tires .....	349
Changing a wheel .....	357
Wheel and tire combinations .....	362
Emergency spare wheel .....	367

### Useful information

- i** This Operator's Manual describes all models and all standard and optional equipment of your vehicle available at the time of publication of the Operator's Manual. Country-specific differences are possible. Please note that your vehicle may not be equipped with all features described. This also applies to safety-related systems and functions.
- i** Read the information on qualified specialist workshops: (▷ page 26).

### Important safety notes

#### WARNING

If wheels and tires of the wrong size are used, the wheel brakes or suspension components may be damaged. There is a risk of an accident.

Always replace wheels and tires with those that fulfill the specifications of the original part.

When replacing wheels, make sure to use the correct:

- designation
- model

When replacing tires, make sure to use the correct:

- designation
- manufacturer
- model

#### WARNING

A flat tire severely impairs the driving, steering and braking characteristics of the vehicle. There is a risk of accident.

Tires without run-flat characteristics:

- do not drive with a flat tire.
- immediately replace the flat tire with your emergency spare wheel or spare wheel, or consult a qualified specialist workshop.

Tires with run-flat characteristics:

- pay attention to the information and warning notices on MOExtended tires (tires with run-flat characteristics).

Accessories that are not approved for your vehicle by Mercedes-Benz or that are not being used correctly can impair the operating safety.

Before purchasing and using non-approved accessories, visit a qualified specialist workshop and inquire about:

- suitability
- legal stipulations
- factory recommendations

Information on the dimensions and types of wheels and tires for your vehicle can be found in the "Wheel/tire combinations" section (▷ page 362).

Information on air pressure for the tires on your vehicle can be found:

- on the vehicle's Tire and Loading Information placard on the B-pillar (▷ page 345)
- on the tire pressure label on the fuel filler flap (▷ page 165)
- under "Tire pressure" (▷ page 338)

### Operation

#### Information on driving

If the vehicle is heavily loaded, check the tire pressures and correct them if necessary.

While driving, pay attention to vibrations, noises and unusual handling characteristics, e.g. pulling to one side. This may indicate that the wheels or tires are damaged. If you suspect that a tire is defective, reduce your speed immediately. Stop the vehicle as soon as possible to check the wheels and tires for damage. Hidden tire damage could also be causing the unusual handling characteristics. If you find no signs of damage, have the tires



and wheels checked at a qualified specialist workshop.

When parking your vehicle, make sure that the tires do not get deformed by the curb or other obstacles. If it is necessary to drive over curbs, speed humps or similar elevations, try to do so slowly and at an obtuse angle.

Otherwise, the tires, particularly the sidewalls, may be damaged.

### Regular checking of wheels and tires

#### WARNING

Damaged tires can cause tire inflation pressure loss. As a result, you could lose control of your vehicle. There is a risk of accident.

Check the tires regularly for signs of damage and replace any damaged tires immediately.

Regularly check the wheels and tires of your vehicle for damage at least once a month, as well as after driving off-road or on rough roads. Damaged wheels can cause a loss of tire pressure. Pay particular attention to damage such as:

- cuts in the tires
- punctures
- tears in the tires
- bulges on tires
- deformation or severe corrosion on wheels

Regularly check the tire tread depth and the condition of the tread across the whole width of the tire (▷ page 335). If necessary, turn the front wheels to full lock in order to inspect the inner side of the tire surface.

All wheels must have a valve cap to protect the valve against dirt and moisture. Do not mount anything onto the valve other than the standard valve cap or other valve caps approved by Mercedes-Benz for your vehicle. Do not use any other valve caps or systems, e.g. tire pressure monitoring systems.

Regularly check the pressure of all the tires particularly prior to long trips. Adjust the tire pressure as necessary (▷ page 338).

Observe the notes on the emergency spare wheel (▷ page 367).

The service life of tires depends, among other things, on the following factors:

- Driving style
- Tire pressure
- Distance covered

### Important safety notes on the tire tread

#### WARNING

Insufficient tire tread will reduce tire traction. The tire is no longer able to dissipate water. This means that on wet road surfaces, the risk of hydroplaning increases, in particular where speed is not adapted to suit the driving conditions. There is a risk of accident.

If the tire pressure is too high or too low, tires may exhibit different levels of wear at different locations on the tire tread. Thus, you should regularly check the tread depth and the condition of the tread across the entire width of all tires.

Minimum tire tread depth for:

- Summer tires: 1/8 in (3 mm)
- M+S tires: 1/8 in (4 mm)

For safety reasons, replace the tires before the legally prescribed limit for the minimum tire tread depth is reached.

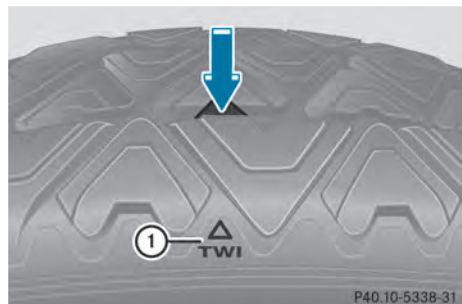

Bar indicator ① for tread wear is integrated into the tire tread.

Treadwear indicators (TWI) are required by law. Six indicators are positioned on the tire tread. They are visible once the tread depth is approximately  $\frac{1}{16}$  in (1.6 mm). If this is the case, the tire is so worn that it must be replaced.

### Selecting, mounting and replacing tires

- Only mount tires and wheels of the same type and make.  
Exception: it is permissible to install a different type or make in the event of a flat tire. Observe the "MOExtended tires (tires with run-flat characteristics)" section (▷ page 321).
- Only mount tires of the correct size onto the wheels.
- Break in new tires at moderate speeds for the first 60 miles (100 km). They only reach their full performance after this distance.
- Do not drive with tires which have too little tread depth, as this significantly reduces the traction on wet roads (hydroplaning).
- Replace the tires after six years at the latest, regardless of wear.

Observe the notes on the emergency spare wheel (▷ page 367).

### MOExtended tires (tires with run-flat properties)

With MOExtended tires (tires with run flat characteristics), you can continue to drive your vehicle even if there is a total loss of pressure in one or more tires.

MOExtended tires may only be used in conjunction with an active tire pressure loss warning system or with an active tire pressure monitor and on wheels specifically tested by Mercedes-Benz.

Notes on driving with MOExtended tires with a flat tire (▷ page 321).

- ❗ Vehicles equipped with MOExtended tires are not equipped with a TIREFIT kit at the factory. It is therefore recommended that you additionally equip your vehicle with a TIREFIT kit if you mount tires that do not feature run-flat properties, e.g. winter tires. A TIREFIT kit can be obtained from a qualified specialist workshop.

## Winter operation

### General notes

Have your vehicle winterproofed at a qualified specialist workshop at the onset of winter. Observe the notes in the "Changing a wheel" section (▷ page 357).

### Driving with summer tires

At temperatures below 45 °F (+7 °C), summer tires lose elasticity significantly, and therefore traction and braking power as well. Change the tires on your vehicle to M+S tires. Using summer tires at very cold temperatures could cause cracks to form, thereby damaging the tires permanently. Mercedes-Benz cannot accept responsibility for this type of damage.

### M+S tires

#### WARNING

M+S tires with a tire tread depth of less than  $\frac{1}{8}$  in (4 mm) are not suitable for use in winter and do not provide sufficient traction. There is a risk of an accident.

M+S tires with a tread depth of less than  $\frac{1}{8}$  in (4 mm) must be replaced immediately.

At temperatures below 45 °F (+7 °C), use winter tires or all-weather tires. Both types of tire are identified by the M+S marking.

Only winter tires bearing the  snowflake symbol in addition to the M+S marking provide the best possible grip in wintry road conditions.

Only these tires will allow driving safety systems such as ABS and ESP® to function optimally in winter. These tires have been developed specifically for driving in snow.

Use M+S tires of the same make and tread on all wheels to maintain safe handling characteristics.

Always observe the maximum permissible speed specified for the M+S tires you have mounted.

Once the winter tires are mounted:

- ▶ Check the tire pressures (▷ page 341).
- ▶ **Vehicles for Canada:** restart the tire pressure loss warning system (▷ page 342).
- ▶ Restart the tire pressure monitor (▷ page 342).

For more information on driving with the emergency spare wheel, see (▷ page 367).

### Snow chains

#### WARNING

If snow chains are installed to the front wheels, they may drag against the vehicle body or chassis components. This could cause damage to the vehicle or the tires. There is a risk of an accident.

To avoid hazardous situations:

- never install snow chains to the front wheels
- always install snow chains in pairs to the rear wheels.

**!** On vehicles with AIRMATIC, you must drive at raised vehicle level if snow chains have been mounted. The vehicle may otherwise be damaged.

**!** On some tire sizes there is not enough space for snow chains. To avoid damage to

the vehicle or tires, observe the "Wheel and tire combinations" section under "Tires and wheels".

For safety reasons, Mercedes-Benz recommends that you only use snow chains that have been specially approved for your vehicle by Mercedes-Benz, or are of a corresponding standard of quality.

If you intend to mount snow chains, please bear the following points in mind:

- Snow chains may not be mounted on all wheel/tire combinations. Permissible wheel-tire combinations (▷ page 362).
- Only use snow chains when driving on roads completely covered by snow. Remove the snow chains as soon as possible when you come to a road that is not snow-covered.
- Local regulations may restrict the use of snow chains. Observe the appropriate regulations if you wish to mount snow chains.
- Do not exceed the maximum permissible speed of 30 mph (50 km/h).

**i** You may wish to deactivate ESP® when pulling away with snow chains installed (▷ page 69). This way you can allow the wheels to spin in a controlled manner, achieving an increased driving force (cutting action).

For more information on driving with the emergency spare wheel, see (▷ page 367).

## Check

## Tire pressure specifications

## Important safety notes

**⚠ WARNING**

Tires with tire pressures that are too low or too high are associated with the following hazards:

- they can burst, in particular if the vehicle is heavily laden or when driven at high speeds.
- the tires can wear excessively and/or unevenly, which can severely impair tire traction.
- the driving, steering and braking characteristics may be severely impaired.

There is a risk of accident.

Follow recommended tire inflation pressures and check the pressure of all the tires including the spare wheel:

- monthly, at least
- if the load changes
- before beginning a long journey
- under different operating conditions, e.g. off-road driving

If necessary, correct the tire pressure.

- i** The specifications on the sample Tire and Loading Information placard and tire pressure tables are examples. Tire pressure specifications are vehicle-specific and may deviate from the data shown here. The tire pressure specifications that are valid for your vehicle can be found on the Tire and Loading Information placard and tire pressure table on the vehicle.

**General notes**

The recommended tire pressures for the tires mounted at the factory can be found on the labels described here.

**Operation with the emergency spare wheel** (▷ page 367).

Further information on tire pressures can be obtained at a qualified specialist workshop.

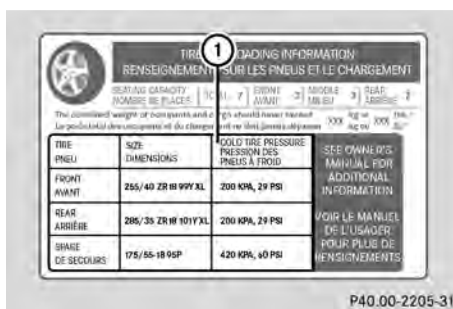
**Tire and Loading Information placard****① Recommended tire pressures**

The Tire and Loading Information placard is on the B-pillar on the driver's side (▷ page 345).

The Tire and Loading Information placard contains the recommended tire pressures for cold tires. The recommended tire pressures are valid for the maximum permissible load and up to the maximum permissible vehicle speed.

**Tire pressure table**

The tire pressure table is on the inside of the fuel filler flap.



Example: tire pressure table for all tires permitted for this vehicle by the factory

The tire pressure table contains the recommended pressures for cold tires for various operating conditions, i.e. differing load and speed conditions.

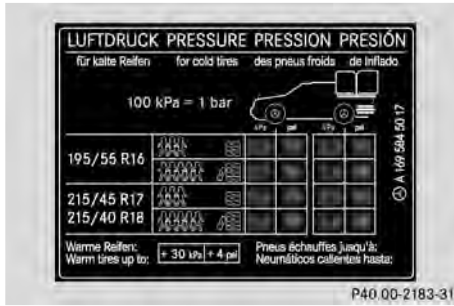

Example: tire pressure table with tire dimensions

If a tire size precedes a tire pressure, the tire pressure information following is only valid for that tire size. The load conditions "partially laden" and "fully laden" are defined in the table for different numbers of occupants and amounts of luggage. The actual number of seats may differ.

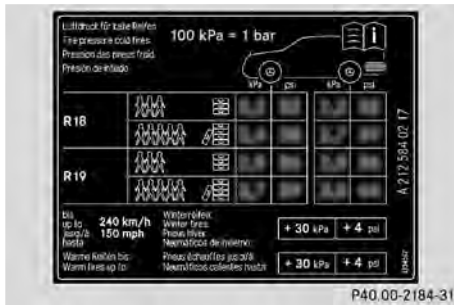

Some tire pressure tables show only the rim diameters instead of the full tire size, e.g.

**R18.** The rim diameter is part of the tire size and can be found on the tire sidewall (▷ page 351).

If the tire pressures have been set to the lower values for lighter loads and/or lower road speeds, the pressures should be reset to the higher values:

- if you want to drive with an increased load and/or
- if you want to drive at higher road speeds.

**i** The tire pressures for increased loads and/or higher road speeds, shown in the tire pressure table, may have a negative effect on driving comfort.

If the tire pressure is not set correctly, this can lead to an excessive build up of heat and a sudden loss of pressure.

For more information, contact a qualified specialist workshop.

### Important notes on tire pressure

#### **⚠ WARNING**

If the tire pressure drops repeatedly, the wheel, valve or tire may be damaged. Tire pressure that is too low may result in a tire blow-out. There is a risk of an accident.

- Check the tire for foreign objects.
- Check whether the wheel is losing air or the valve is leaking.

If you are unable to rectify the damage, contact a qualified specialist workshop.

#### **⚠ WARNING**

If you fit unsuitable accessories onto tire valves, the tire valves may be overloaded and malfunction, which can cause tire pressure loss. Due to their design, retrofitted tire pressure monitors keep the tire valve open. This can also result in tire pressure loss. There is a risk of an accident.

Only screw the standard valve cap or other valve caps approved by Mercedes-Benz for your vehicle onto the tire valve.

Use a suitable pressure gauge to check the tire pressure. The outer appearance of a tire does not permit any reliable conclusion about the tire pressure. On vehicles equipped with the electronic tire pressure monitoring system, the tire pressure can be checked using the on-board computer.

The tire temperature and pressure increase when the vehicle is in motion. This is dependent on the driving speed and the load. Therefore, you should only correct tire pressures when the tires are cold.

The tires are cold:

- if the vehicle has been parked without direct sunlight on the tires for at least three hours and
- if the vehicle has been driven for less than 1 mile (1.6 km).

The tire temperature changes depending on the outside temperature, the vehicle speed and the tire load. If the tire temperature changes by 18 °F (10 °C), the tire pressure changes by approximately 10 kPa (0.1 bar/ 1.5 psi). Take this into account when checking the pressure of warm tires. Only correct the tire pressure if it is too low for the current operating conditions. If you check the tire pressure when the tires are warm, the resulting value will be higher than if the tires were cold. This is normal. Do not reduce the tire pressure to the value specified for cold tires. The tire pressure would otherwise be too low.

Observe the recommended tire pressures for cold tires:

- on the Tire and Loading Information placard on the B-pillar on the driver's side
- in the tire pressure table on the inside of the fuel filler flap
- on the yellow label on the emergency spare wheel (depending on the vehicle equipment)

### Underinflated or overinflated tires

#### Underinflation

##### WARNING

Tires with pressure that is too low can overheat and burst as a consequence. In addition, they also suffer from excessive and/or irregular wear, which can severely impair the braking properties and the driving characteristics. There is a risk of an accident.

Avoid tire pressures that are too low in all the tires, including the spare wheel.

Underinflated tires may:

- overheat, leading to tire defects
- have an adverse effect on handling characteristics
- wear quickly and unevenly
- have an adverse effect on fuel consumption

#### Overinflation

##### WARNING

Tires with excessively high pressure can burst because they are damaged more easily by road debris, potholes etc. In addition, they also suffer from irregular wear, which can severely impair the braking properties and the driving characteristics. There is a risk of an accident.

Avoid tire pressures that are too high in all the tires, including the spare wheel.

Overinflated tires may:

- increase the braking distance
- have an adverse effect on handling characteristics
- wear quickly and unevenly
- have an adverse effect on ride comfort
- be more susceptible to damage

#### Maximum tire pressures



- ① Example: maximum permissible tire pressure

Never exceed the maximum permissible tire inflation pressure. Always observe the recommended tire pressure for your vehicle

when adjusting the tire pressure  
(▷ page 338).

- i** The actual values for tires are vehicle-specific and may deviate from the values in the illustration.

## Checking the tire pressures

### Important safety notes

Observe the notes on tire pressure  
(▷ page 338).

Information on air pressure for the tires on your vehicle can be found:

- on the vehicle's Tire and Loading Information placard on the B-pillar (▷ page 345)
- on the tire pressure label on the fuel filler flap (▷ page 165)
- in the "Tire pressure" section
- under "Tire pressure" (▷ page 338)

### Checking tire pressures manually

To determine and set the correct tire pressure, proceed as follows:

- ▶ Remove the valve cap of the tire that is to be checked.
- ▶ Press the tire pressure gauge securely onto the valve.
- ▶ Read the tire pressure and compare it with the recommended value on the Tire and Loading Information placard (▷ page 338).
- ▶ If the tire pressure is too low, increase it to the recommended value.
- ▶ If the tire pressure is too high, release air by pressing down the metal pin in the valve. Use the tip of a pen, for example. Then, check the tire pressure again using the tire pressure gauge.
- ▶ Screw the valve cap onto the valve.
- ▶ Repeat these steps for the other tires.

## Tire pressure loss warning system (Canada only)

### General notes

While the vehicle is in motion, the tire pressure loss warning system monitors the set tire pressure using the rotational speed of the wheels. This enables the system to detect significant pressure loss in a tire. If the speed of rotation of a wheel changes as a result of a loss of pressure, a corresponding warning message will appear in the multifunction display.

You can recognize the tire pressure loss warning by the **Run Flat Indicator Active Press 'OK' to Restart** message which appears in the **Serv.** menu of the multifunction display. Further information on the message display can be found under "Restarting the tire pressure loss warning system" section (▷ page 342).

### Important safety notes

The tire pressure warning system does not warn you of an incorrectly set tire pressure. Observe the notes on the recommended tire pressure (▷ page 338).

The tire pressure loss warning does not replace the need to regularly check the tire pressure. An even loss of pressure on several tires at the same time cannot be detected by the tire pressure loss warning system.

The tire pressure monitor is not able to warn you of a sudden loss of pressure, e.g. if the tire is penetrated by a foreign object. In the event of a sudden loss of pressure, bring the vehicle to a halt by braking carefully. Avoid abrupt steering maneuvers.





The function of the tire pressure loss warning system is limited or delayed if:

- snow chains are mounted on your vehicle's tires.
- road conditions are wintry.
- you are driving on sand or gravel.





- you adopt a very sporty driving style (cornering at high speeds or driving with high rates of acceleration).
- you are driving with a heavy load (in the vehicle or on the roof).

### Restarting the tire pressure loss warning system





Restart the tire pressure loss warning system if you have:

- changed the tire pressure
  - changed the wheels or tires
  - mounted new wheels or tires
- ▶ Before restarting, make sure that the tire pressures are set properly on all four tires for the respective operating conditions. The recommended tire pressures can be found on the Tire and Loading Information placard on the B-pillar on the driver's side or the tire pressure table on the fuel filler flap. The tire pressure loss warning system can only give reliable warnings if you have set the correct tire pressure. If an incorrect tire pressure is set, these incorrect values will be monitored.
- ▶ Also observe the notes in the section on tire pressures (▷ page 338).
- ▶ Make sure that the SmartKey is in position 2 in the ignition lock (▷ page 147).
- ▶ Press the  or  button on the steering wheel to select the **Serv.** menu.
- ▶ Press the  or  button on the steering wheel to select the **Tire Pressure** menu.
- ▶ Press the  button.  
The **Run Flat Indicator Active Press 'OK' to Restart** message appears in the multifunction display.

### If you wish to confirm the restart:

- ▶ Press the  button.  
The **Tire Pressure Now OK?** message appears in the multifunction display.
- ▶ Press the  or  button to select **Yes**.
- ▶ Press the  button.  
The **Run Flat Indicator Restarted** message appears in the multifunction display.  
After a teach-in period, the tire pressure loss warning system will monitor the set tire pressures of all four tires.

### If you wish to cancel the restart:

- ▶ Press the  button.  
or
- ▶ When the **Tire Pressure Now OK?** message appears, press the  or  button to select **Cancel**.
- ▶ Press the  button.  
The tire pressure values stored at the last restart will continue to be monitored.

## Tire pressure monitor

### General notes

If a tire pressure monitor is installed, the vehicle's wheels have sensors that monitor the tire pressures in all four tires. The tire pressure monitor warns you if the pressure drops in one or more of the tires. The tire pressure monitor only functions if the correct sensors are installed on all wheels.

Information on tire pressures is displayed in the multifunction display. After a few minutes of driving, the current tire pressure of each tire is shown in the **Service** menu of the multifunction display. For further information on displaying this message, refer to the "Checking the tire pressure electronically" section (▷ page 344).



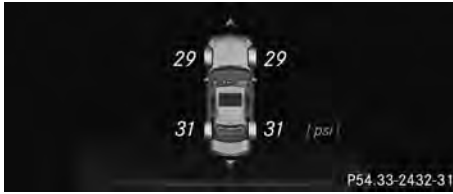

Example: current tire pressure display

## Important safety notes

### WARNING

Each tire, including the spare (if provided), should be checked at least once every two weeks when cold and inflated to the pressure recommended by the vehicle manufacturer on the Tire and Loading Information placard on the driver's door B-pillar or the tire pressure label on the inside of the fuel filler flap. If your vehicle has tires of a different size than the size indicated on the Tire and Loading Information placard or, if available, the tire pressure label, you should determine the proper tire pressure for those tires.

As an added safety feature, your vehicle has been equipped with a tire pressure monitoring system (TPMS) that illuminates a low tire pressure telltale when one or more of your tires are significantly underinflated.

Accordingly, when the low tire pressure telltale lights up, you should stop and check your tires as soon as possible, and inflate them to the proper pressure. Driving on a significantly underinflated tire causes the tire to overheat and can lead to tire failure.

Underinflation also reduces fuel efficiency and tire tread life, and may affect the vehicle's handling and stopping ability. Please note that the TPMS is not a substitute for proper tire maintenance, and it is the driver's responsibility to maintain correct tire pressure, even if underinflation has not reached the level to trigger illumination of the TPMS low tire pressure telltale.

Your vehicle has also been equipped with a TPMS malfunction indicator to indicate when the system is not operating properly. The

TPMS malfunction indicator is combined with the low tire pressure telltale. When the system detects a malfunction, the warning lamp will flash for approximately a minute and then remain continuously illuminated. This sequence will be repeated every time the vehicle is started as long as the malfunction exists. When the malfunction indicator is illuminated, the system may not be able to detect or signal low tire pressure as intended.

TPMS malfunctions may occur for a variety of reasons, including the installation of incompatible replacement or alternate tires or wheels on the vehicle that prevent the TPMS from functioning properly. Always check the TPMS malfunction telltale after replacing one or more tires or wheels on your vehicle to ensure that the replacement or alternate Tires and wheels allow the TPMS to continue to function properly.

It is the driver's responsibility to set the tire pressure to that recommended for cold tires which is suitable for the operating situation (▷ page 338). Note that the correct tire pressure for the current operating situation must first be taught-in to the tire pressure monitor. If there is a substantial loss of pressure, the warning threshold for the warning message is aligned to the reference values taught-in. Restart the tire pressure monitor after adjusting the pressure of the cold tires (▷ page 345). The current pressures are saved as new reference values. As a result, a warning message will appear if the tire pressure drops significantly.

The tire pressure monitor does not warn you of an incorrectly set tire pressure. Observe the notes on the recommended tire pressure (▷ page 338).

The tire pressure monitor is not able to warn you of a sudden loss of pressure, e.g. if the tire is penetrated by a foreign object. In the event of a sudden loss of pressure, bring the vehicle to a halt by braking carefully. Avoid sudden steering movements

The tire pressure monitor has a yellow warning lamp in the instrument cluster for indicating a pressure loss or malfunction. Whether the warning lamp flashes or lights up indicates whether a tire pressure is too low or the tire pressure monitor is malfunctioning:



- if the warning lamp is lit continuously, the tire pressure on one or more tires is significantly too low. The tire pressure monitor is not malfunctioning.
- if the warning lamp flashes for around a minute and then remains lit constantly, the tire pressure monitor is malfunctioning.

If the tire pressure monitor is malfunctioning, it may take more than ten minutes for the tire pressure warning lamp to inform you of the malfunction by flashing for approximately one minute and then remaining lit. When the malfunction has been rectified, the tire pressure warning lamp goes out after a few minutes of driving.

The tire pressure values indicated by the on-board computer may differ from those measured at a gas station with a pressure gauge. The tire pressures shown by the on-board computer refer to those measured at sea level. At high altitudes, the tire pressure values indicated by a pressure gauge are higher than those shown by the on-board computer. In this case, do not reduce the tire pressures.

The operation of the tire pressure monitor can be affected by interference from radio transmitting equipment (e.g. radio headphones, two-way radios) that may be being operated in or near the vehicle.

### Checking the tire pressure electronically

- ▶ Make sure that the SmartKey is in position 2 (▷ page 147) in the ignition lock .
- ▶ Press the  or  button on the steering wheel to select the **Serv.** menu.

- ▶ Press the  or  button to select **Tire Pressure**.

- ▶ Press the  button.

The current tire pressure of each tire is shown in the multifunction display.

If the vehicle was parked for longer than 20 minutes, the **Tire pressures will be displayed after driving a few minutes** message is shown.

After a teach-in process, the tire pressure monitor automatically detects new wheels or new sensors. As long as a clear allocation of the tire pressure value to the individual wheels is not possible, the **Tire Pressure Monitor Active** display message is shown instead of the tire pressure display. The tire pressures are already being monitored.

- ❗ If an emergency spare wheel is mounted, the system may continue to show the tire pressure of the wheel that has been removed for a few minutes. If this occurs, note that the value displayed for the position where the spare wheel is mounted is not the same as the current tire pressure of the emergency spare wheel.

### Tire pressure monitor warning messages

If the tire pressure monitor detects a pressure loss in one or more tires, a warning message is shown in the multifunction display and the yellow tire pressure monitor warning lamp comes on.

- If the **Correct Tire Pressure** message appears in the multifunction display, the tire pressure in at least one tire is too low and must be corrected at the next opportunity.
- If the **Check Tire Pressure** message appears in the multifunction display, the tire pressure in one or more tires has dropped significantly and the tires must be checked.
- If the **Tire Malfunction** appears in the multifunction display, the tire pressure in





one or more tires has dropped suddenly and the tires must be checked.

Observe the instructions and safety notes in the display messages in the "Tires" section (▷ page 258).

- ❗ If the wheel positions on the vehicle are rotated, the tire pressures may be displayed for the wrong positions for a short time. This is rectified after a few minutes of driving, and the tire pressures are displayed for the correct positions.

### Restarting the tire pressure monitor

When you restart the tire pressure monitor, all existing warning messages are deleted and the warning lamps go out. The monitor uses the currently set tire pressures as the reference values for monitoring. In most cases, the tire pressure monitor will automatically detect the new reference values after you have changed the tire pressure. However, you can also define reference values manually as described here. The tire pressure monitor then monitors the new tire pressure values.

- ▶ Set the tire pressure to the value recommended for the corresponding driving situation on the Tire and Loading Information placard on the B-pillar on the driver's side (▷ page 338).  
Additional tire pressure values for different loads can also be found on the tire pressure table on the inside of the fuel filler flap (▷ page 338).
- ▶ Make sure that the tire pressure is correct on all four wheels.
- ▶ Make sure that the SmartKey is in position 2 in the ignition lock.
- ▶ Press the  or  button on the steering wheel to select the **Serv.** menu.
- ▶ Press the  or  button to select **Tire Pressure**.
- ▶ Press the  button.  
The multifunction display shows the current tire pressure for each tire or the

Tire pressures will be displayed after driving a few minutes message.

- ▶ Press the  button.  
The multifunction display shows the **Use Current Pressures as New Reference Values** message.

#### If you wish to confirm the restart:

- ▶ Press the  button.  
The **Tire Press. Monitor Restarted** message appears in the multifunction display.

After driving for a few minutes, the system checks whether the current tire pressures are within the specified range. The new tire pressures are then accepted as reference values and monitored.

#### If you wish to cancel the restart:

- ▶ Press the  button.  
The tire pressure values stored at the last restart will continue to be monitored.

## Loading the vehicle

### Instruction labels for tires and loads

#### WARNING

Overloaded tires can overheat, causing a blowout. Overloaded tires can also impair the steering and driving characteristics and lead to brake failure. There is a risk of accident. Observe the load rating of the tires. The load rating must be at least half of the GAWR of your vehicle. Never overload the tires by exceeding the maximum load.

Two instruction labels on your vehicle show the maximum possible load.

- (1) The Tire and Loading Information placard is on the B-pillar on the driver's side. The Tire and Loading Information placard shows the maximum permissible number of occupants and the maximum permissible vehicle load. It also contains

details of the tire sizes and corresponding pressures for tires mounted at the factory.

- (2) The vehicle identification plate is on the B-pillar on the driver's side. The vehicle identification plate informs you of the gross vehicle weight rating. It is made up of the vehicle weight, all vehicle occupants, the fuel and the cargo. You can also find information about the maximum gross axle weight rating on the front and rear axle.

The maximum gross axle weight rating is the maximum weight that can be carried by one axle (front or rear axle). Never exceed the maximum load or the maximum gross axle weight rating for the front or rear axle.



① B-pillar, driver's side

- Specification for maximum gross vehicle weight ① is listed in the Tire and Loading Information placard: "The combined weight of occupants and cargo should never exceed XXX kilograms or XXX lbs."

The gross weight of all vehicle occupants, load and luggage must not exceed the specified value.

- ① The specifications shown on the Tire and Loading Information placard in the illustration are examples. The maximum permissible gross vehicle weight rating is vehicle-specific and may differ from that in the illustration. You can find the valid maximum permissible gross vehicle weight rating for your vehicle on the Tire and Loading Information placard.

Number of seats

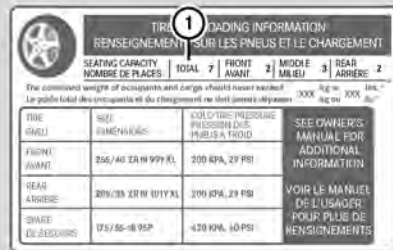

P40.00-2207-31

Maximum permissible gross vehicle weight rating

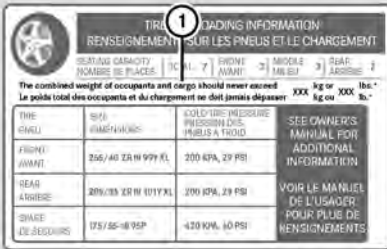

P40.00-2206-31

Maximum number of seats ① indicates the maximum number of occupants allowed to travel in the vehicle. This information can be found on the Tire and Loading Information placard.

- ① The specifications shown on the Tire and Loading Information placard in the illustration are examples. The number of seats is vehicle-specific and can differ from the details shown. The number of seats in your vehicle can be found on the Tire and Loading Information placard.

## Determining the correct load limit

### Step-by-step instructions

---

The following steps have been developed as required of all manufacturers under Title 49, Code of U.S. Federal Regulations, Part 575 pursuant to the "National Traffic and Motor Vehicle Safety Act of 1966".

- ▶ **Step 1:** Locate the statement "The combined weight of occupants and cargo should never exceed XXX kg or XXX lbs." on your vehicle's Tire and Loading Information placard.
- ▶ **Step 2:** Determine the combined weight of the driver and passengers that will be riding in your vehicle.
- ▶ **Step 3:** Subtract the combined weight of the driver and passengers from XXX kilograms or XXX lbs.
- ▶ **Step 4:** The resulting figure equals the available amount of cargo and luggage load capacity. For example, if the "XXX" amount equals 1400 lbs and there will be five 150 lbs passengers in your vehicle, the amount of available cargo and luggage load capacity is 650 lbs ( $1400 - 750 (5 \times 150) = 650$  lbs).
- ▶ **Step 5:** Determine the combined weight of luggage and cargo being loaded on the vehicle. That weight may not safely exceed the available cargo and luggage load capacity calculated in step 4.

**Example: steps 1 to 3**

The following table shows examples on how to calculate total and cargo load capacities with varying seating configurations and number and size of occupants. The following examples use a maximum load of 1500 lbs (680 kg). **This is for illustration purposes only.** Make sure you are using the actual load limit for your vehicle stated on your vehicle's Tire and Loading Information placard (▷ page 345).

The greater the combined weight of the occupants, the lower the maximum luggage load.

**Step 1**

	Example 1	Example 2	Example 3
<b>Combined maximum weight of occupants and cargo (data from the Tire and Loading Information placard)</b>	1500 lbs (680 kg)	1500 lbs (680 kg)	1500 lbs (680 kg)

**Step 2**

	Example 1	Example 2	Example 3
<b>Number of people in the vehicle (driver and occupants)</b>	5	3	1
<b>Distribution of the occupants</b>	Front: 2 Rear: 3	Front: 1 Rear: 2	Front: 1
<b>Weight of the occupants</b>	Occupant 1: 150 lbs (68 kg) Occupant 2: 180 lbs (82 kg) Occupant 3: 160 lbs (73 kg) Occupant 4: 140 lbs (63 kg) Occupant 5: 120 lbs (54 kg)	Occupant 1: 200 lbs (91 kg) Occupant 2: 190 lbs (86 kg) Occupant 3: 150 lbs (68 kg)	Occupant 1: 150 lbs (68 kg)
<b>Gross weight of all occupants</b>	750 lbs (340 kg)	540 lbs (245 kg)	150 lbs (68 kg)

## Step 3

	Example 1	Example 2	Example 3
<b>Permissible load (maximum gross vehicle weight rating from the Tire and Loading Information placard minus the gross weight of all occupants)</b>	1500 lbs (680 kg) -750 lbs (340 kg) = 750 lbs (340 kg)	1500 lbs (680 kg) -540 lbs (245 kg) =960 lbs (435 kg)	1500 lbs (680 kg) -150 lbs (68 kg) = 1350 lbs (612 kg)

## Vehicle identification plate

Even if you have calculated the total cargo carefully, you should still make sure that the gross vehicle weight rating and the gross axle weight rating are not exceeded. Details can be found on the vehicle identification plate on the B-pillar on the driver's side of the vehicle (▷ page 345).

**Permissible gross vehicle weight:** the gross weight of the vehicle, all passengers, load and trailer load/noseweight (if applicable) must not exceed the permissible gross vehicle weight.

**Gross axle weight rating:** the maximum permissible weight that can be carried by one axle (front or rear axle).

To ensure that your vehicle does not exceed the maximum permissible values (gross vehicle weight and maximum gross axle weight rating), have your loaded vehicle (including driver, occupants, cargo, and full trailer load if applicable) weighed on a suitable vehicle weighbridge.

## All about wheels and tires

## Uniform Tire Quality Grading Standards

## Overview of Tire Quality Grading Standards



Uniform Tire Quality Grading Standards are U.S. government specifications. Their purpose is to provide drivers with uniform reliable information on tire performance data. Tire manufacturers have to grade tires using three performance factors: ① tread wear grade, ② traction grade and ③ temperature grade. These regulations do not apply to Canada. Nevertheless, all tires sold in North America are provided with the corresponding quality grading markings on the sidewall of the tire.

Where applicable, the tire grading information can be found on the tire sidewall between the tread shoulder and maximum tire width.

Example:

- **Treadwear grade:** 200
- **Traction grade:** AA
- **Temperature grade:** A

All passenger car tires must conform to the statutory safety requirements in addition to these grades.

- i** The actual values for tires are vehicle-specific and may deviate from the values in the illustration.

### Treadwear

The treadwear grade is a comparative rating based on the wear rate of the tire when tested under controlled conditions on a specified U.S. government course. For example, a tire graded 150 would wear one and one-half times as well on the government course as a tire graded 100.

The relative performance of tires depends upon the actual conditions of their use, however, and may depart significantly from the norm, due to variations in driving habits, service practices and differences in road characteristics and climate conditions.

### Traction

#### WARNING

The traction grade assigned to this tire is based on straight-ahead braking traction tests, and does not include acceleration, cornering, hydroplaning, or peak traction characteristics.

- !** Avoid wheelspin. This can lead to damage to the drive train.

The traction grades, from highest to lowest, are AA, A, B, and C. Those grades represent the tire's ability to stop on a wet surface as measured under controlled conditions on specified government test surfaces of asphalt and concrete. A tire marked C may have poor traction performance.

The safe speed on a wet, snow covered or icy road is always lower than on dry road surfaces.

You should pay special attention to road conditions when temperatures are around freezing point.

Mercedes-Benz recommends a minimum tread depth of  $\frac{1}{8}$  in (4 mm) on all four winter tires. Observe the legally required minimum tire tread depth (> page 335). Winter tires can reduce the braking distance on snow-covered surfaces in comparison with summer tires.

The braking distance is still much further than on surfaces that are not icy or covered with snow. Take appropriate care when driving. Further information on winter tires (M+S tires) (> page 336).

### Temperature

#### WARNING

The temperature grade for this tire is established for a tire that is properly inflated and not overloaded. Excessive speed, underinflation, or excessive loading, either separately or in combination, can cause excessive heat build-up and possible tire failure.

The temperature grades are A (the highest), B, and C. These represent the tire's resistance to the generation of heat and its ability to dissipate heat when tested under controlled conditions on a specified indoor laboratory test wheel. Sustained high temperature can cause the material of the tire to degenerate and reduce tire life, and excessive temperature can lead to sudden tire failure. The grade C corresponds to a level of performance which all passenger car tires must meet under the Federal Motor Vehicle Safety Standard No. 109. Grades B and A represent higher levels of performance on the laboratory test wheel than the minimum required by law.



## Tire labeling

### Overview

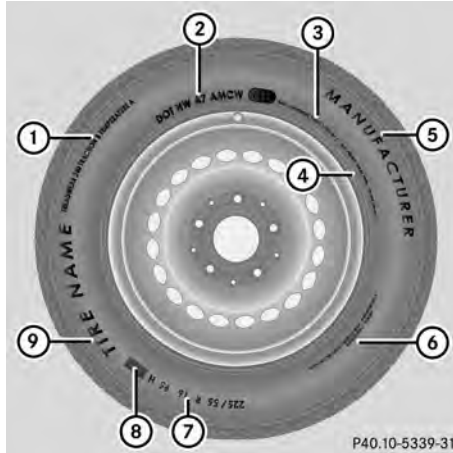

- ① Uniform Tire Quality Grading Standard (▷ page 355)
- ② DOT, Tire Identification Number (▷ page 354)
- ③ Maximum tire load (▷ page 353)
- ④ Maximum tire pressure (▷ page 340)
- ⑤ Manufacturer
- ⑥ Tire material (▷ page 354)
- ⑦ Tire size designation, load-bearing capacity and speed index (▷ page 351)
- ⑧ Load index (▷ page 353)
- ⑨ Tire name

The markings described above are on the tire in addition to the tire name (sales designation) and the manufacturer's name.

- i** Tire data is vehicle-specific and may deviate from the data in the example.

### Tire size designation, load-bearing capacity and speed rating

#### WARNING

Exceeding the stated tire load-bearing capacity and the approved maximum speed could lead to tire damage or the tire bursting. There is a risk of accident.

Therefore, only use tire types and sizes approved for your vehicle model. Observe the tire load rating and speed rating required for your vehicle.



- ① Tire width
- ② Nominal aspect ratio in %
- ③ Tire code
- ④ Rim diameter
- ⑤ Load bearing index
- ⑥ Speed rating

**General:** depending on the manufacturer's standards, the size imprinted in the tire wall may not contain any letters or may contain one letter that precedes the size description.

If there is no letter preceding the size description (as shown above): these are passenger vehicle tires according to European manufacturing standards.

If "P" precedes the size description: these are passenger vehicle tires according to U.S. manufacturing standards.

If "LT" precedes the size description: these are light truck tires according to U.S. manufacturing standards.

If "T" precedes the size description: these are compact emergency spare wheels at high tire pressure, to be used only temporarily in an emergency.

**Tire width:** tire width ① shows the nominal tire width in millimeters.

**Aspect ratio:** aspect ratio ② is the size ratio between the tire height and tire width and is shown in percent. The aspect ratio is

calculated by dividing the tire width by the tire height.

**Tire code:** tire code ③ specifies the tire type. "R" represents radial tires; "D" represents diagonal tires; "B" represents diagonal radial tires.

Optionally, tires with a maximum speed of over 149 mph (240 km/h) may have "ZR" in the size description, depending on the manufacturer (e.g. 245/40 ZR 18).

**Rim diameter:** rim diameter ④ is the diameter of the bead seat, not the diameter of the rim flange. The rim diameter is specified in inches (in).

**Load-bearing index:** load-bearing index ⑤ is a numerical code that specifies the maximum load-bearing capacity of a tire. Do not overload the tires by exceeding the specified load limit. The maximum permissible load can be found on the vehicle's Tire and Loading Information placard on the B-pillar on the driver's side (▷ page 345).

Example:

Load-bearing index 91 indicates a maximum load of 1356 lb (615 kg) that the tires can bear. For further information on the maximum tire load in kilograms and lbs, see (▷ page 353).

For further information on the load bearing index, see "Load index" (▷ page 353).

**Speed rating:** speed rating ⑥ specifies the approved maximum speed of the tire.

① Tire data is vehicle-specific and may deviate from the data in the example.

Regardless of the speed rating, always observe the speed limits. Drive carefully and adapt your driving style to the traffic conditions.

### Summer tires

Index	Speed rating
Q	up to 100 mph (160 km/h)
R	up to 106 mph (170 km/h)

Index	Speed rating
S	up to 112 mph (180 km/h)
T	up to 118 mph (190 km/h)
H	up to 130 mph (210 km/h)
V	up to 149 mph (240 km/h)
W	up to 168 mph (270 km/h)
Y	up to 186 mph (300 km/h)
ZR...Y	up to 186 mph (300 km/h)
ZR...(..Y)	over 186 mph (300 km/h)
ZR	over 149 mph (240 km/h)

- Optionally, tires with a maximum speed of over 149 mph (240 km/h) may have "ZR" in the size description, depending on the manufacturer (e.g. 245/40 ZR18).

The service specification is made up of load-bearing index ⑤ and speed rating ⑥.

- If the size description of your tire includes "ZR" and there are no service specifications, ask the tire manufacturer in order to find out the maximum speed. If a service specification is available, the maximum speed is limited according to the speed rating in the service specification. Example: 245/40 ZR18 97 Y. In this example, "97 Y" is the service specification. The letter "Y" represents the speed rating. The maximum speed of the tire is limited to 186 mph (300 km/h).
- The size description for all tires with maximum speeds of over 186 mph (300 km/h) must include "ZR", **and** the service specification must be given in parentheses. Example: 275/40 ZR 18 (99 Y). Speed rating "Y" indicates that the maximum speed of the tire is over 186 mph (300 km/h). Ask the tire manufacturer about the maximum speed.

## All-weather tires and winter tires

Index	Speed rating
Q M+S <sup>1</sup>	up to 100 mph (160 km/h)
T M+S <sup>1</sup>	up to 118 mph (190 km/h)
H M+S <sup>1</sup>	up to 130 mph (210 km/h)
V M+S <sup>1</sup>	up to 149 mph (240 km/h)

**i** Not all tires with the M+S marking provide the driving characteristics of winter tires. In addition to the M+S marking, winter tires also have the  snowflake symbol on the tire wall. Tires with this marking fulfill the requirements of the Rubber Manufacturers Association (RMA) and the Rubber Association of Canada (RAC) regarding the tire traction on snow. They have been especially developed for driving on snow.

An electronic speed limiter prevents your vehicle from exceeding the following speeds:

- all vehicles (except AMG vehicles): 130 mph (210 km/h)
- AMG vehicles: 155 mph (250 km/h)
- AMG vehicles with Performance Package: 186 mph (300 km/h)
- 

The speed rating of tires mounted at the factory may be higher than the maximum speed that the electronic speed limiter permits.

Make sure that your tires have the required speed rating, e.g. when buying new tires. The required speed rating for your vehicle can be found in the "Tires" section (▷ page 362). Further information about reading tire data can be obtained from any qualified specialist workshop.

<sup>1</sup> Or M+S  for winter tires.

## Load index



In addition to the load bearing index, load index **1** may be imprinted after the letters that identify speed index **6** on the sidewall of the tire (▷ page 351).

- If no specification is given: no text (as in the example above), represents a standard load (SL) tire
- XL or Extra Load: represents a reinforced tire
- Light Load: represents a light load tire
- C, D, E: represents a load range that depends on the maximum load that the tire can carry at a certain pressure

**i** Tire data is vehicle-specific and may deviate from the data in the example.

## Maximum load rating



Maximum tire load **1** is the maximum permissible weight for which the tire is approved.

Do not overload the tires by exceeding the specified load limit. The maximum permissible load can be found on the vehicle's Tire and Loading Information placard on the B-pillar on the driver's side (> page 345).

- 1 The actual values for tires are vehicle-specific and may deviate from the values in the illustration.

### DOT, Tire Identification Number (TIN)

U.S. tire regulations prescribe that every tire manufacturer or retreader must imprint a TIN in or on the sidewall of every tire produced.

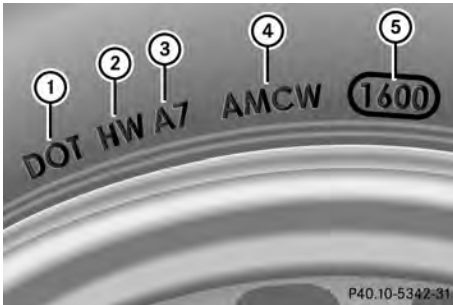

The TIN is a unique identification number. The TIN enables the tire manufacturers or retreaders to inform purchasers of recalls and other safety-relevant matters. It makes it possible for the purchaser to easily identify the affected tires.

The TIN is made up of manufacturer identification code (2), tire size (3), tire type code (4) and manufacturing date (5).

**DOT (Department of Transportation):** tire symbol (1) indicates that the tire complies with the requirements of the U.S. Department of Transportation.

**Manufacturer identification code:** manufacturer identification code (2) provides details on the tire manufacturer. New tires have a code with two symbols. Retreaded tires have a code with four symbols.

For further information about retreaded tires, see (> page 334).

**Tire size:** identifier (3) describes the tire size.

**Tire type code:** tire type code (4) can be used by the manufacturer as a code to describe specific characteristics of the tire.

**Date of manufacture:** date of manufacture (5) provides information about the age of a tire. The first and second positions represent the week of manufacture, starting with "01" for the first calendar week. Positions three and four represent the year of manufacture. For example, a tire that is marked with "3208", was manufactured in week 32 in 2008.

- 1 Tire data is vehicle-specific and may deviate from the data in the example.

### Tire characteristics



This information describes the type of tire cord and the number of layers in sidewall (1) and under tire tread (2).

- 1 Tire data is vehicle-specific and may deviate from the data in the example.

### Definition of terms for tires and loading

#### Tire ply composition and material used

Describes the number of plies or the number of layers of rubber-coated fabric in the tire tread and sidewall. These are made of steel, nylon, polyester and other materials.

#### Bar

Metric unit for tire pressure.

14.5038 pounds per square inch (psi) and

100 kilopascals (kPa) are the equivalent of 1 bar.

### **DOT (Department of Transportation)**

DOT marked tires fulfill the requirements of the United States Department of Transportation.

### **Normal occupant weight**

The number of occupants for which the vehicle is designed multiplied by 68 kilograms (150 lb).

### **Uniform Tire Quality Grading Standards**

A uniform standard to grade the quality of tires with regards to tread quality, tire traction and temperature characteristics. Ratings are determined by tire manufacturers using U.S. government testing procedures. The ratings are molded into the sidewall of the tire.

### **Recommended tire pressure**

The recommended tire pressure applies to the tires mounted at the factory.

The Tire and Loading Information placard contains the recommended tire pressures for cold tires on a fully loaded vehicle and for the maximum permissible vehicle speed.

The tire pressure table contains the recommended pressures for cold tires for various operating conditions, i.e. differing load and speed conditions.

### **Increased vehicle weight due to optional equipment**

This is the combined weight of all standard and optional equipment available for the vehicle, regardless of whether it is actually installed on the vehicle or not.

### **Rim**

This is the part of the wheel on which the tire is mounted.

### **GAWR (Gross Axle Weight Rating)**

The GAWR is the maximum gross axle weight rating. The actual load on an axle must never exceed the gross axle weight rating. The gross axle weight rating can be found on the

vehicle identification plate on the B-pillar on the driver's side.

### **Speed rating**

The speed rating is part of the tire identification. It specifies the speed range for which the tire is approved.

### **GVW (Gross Vehicle Weight)**

The gross vehicle weight includes the weight of the vehicle including fuel, tools, the spare wheel, accessories installed, occupants, luggage and the drawbar noseweight, if applicable. The gross vehicle weight must not exceed the gross vehicle weight rating GVWR as specified on the vehicle identification plate on the B-pillar on the driver's side.

### **GVWR (Gross Vehicle Weight Rating)**

The GVWR is the maximum permissible gross weight of a fully loaded vehicle (the weight of the vehicle including all accessories, occupants, fuel, luggage and the drawbar noseweight, if applicable). The gross vehicle weight rating is specified on the vehicle identification plate on the B-pillar on the driver's side.

### **Maximum loaded vehicle weight**

The maximum weight is the sum of:

- the curb weight of the vehicle
- the weight of the accessories
- the load limit
- the weight of the factory installed optional equipment

### **Kilopascal (kPa)**

Metric unit for tire pressure. 6.9 kPa corresponds to 1 psi. Another unit for tire pressure is bar. There are 100 kilopascals (kPa) to 1 bar.

### **Load index**

In addition to the load-bearing index, the load index may also be imprinted on the sidewall of the tire. This specifies the load-bearing capacity more precisely.

**Curb weight**

The weight of a vehicle with standard equipment including the maximum capacity of fuel, oil and coolant. It also includes the air-conditioning system and optional equipment if these are installed in the vehicle, but does not include passengers or luggage.

**Maximum load rating**

The maximum tire load is the maximum permissible weight in kilograms or lbs for which a tire is approved.

**Maximum permissible tire pressure**

Maximum permissible tire pressure for one tire.

**Maximum load on one tire**

Maximum load on one tire. This is calculated by dividing the maximum axle load of one axle by two.

**PSI (pounds per square inch)**

A standard unit of measure for tire pressure.

**Aspect ratio**

Relationship between tire height and tire width in percent.

**Tire pressure**

This is pressure inside the tire applying an outward force to each square inch of the tire's surface. The tire pressure is specified in pounds per square inch (psi), in kilopascal (kPa) or in bar. The tire pressure should only be corrected when the tires are cold.

**Cold tire pressure**

The tires are cold:

- if the vehicle has been parked without direct sunlight on the tires for at least three hours and
- if the vehicle has been driven for less than 1 mile (1.6 km).

**Tread**

The part of the tire that comes into contact with the road.

**Bead**

The tire bead ensures that the tire sits securely on the wheel. There are several steel wires in the bead to prevent the tire from coming loose from the wheel rim.

**Sidewall**

The part of the tire between the tread and the bead.

**Weight of optional extras**

The combined weight of those optional extras that weigh more than the replaced standard parts and more than 2.3 kilograms (5 lbs). These optional extras, such as high-performance brakes, level control, a roof rack or a high-performance battery, are not included in the curb weight and the weight of the accessories.

**TIN (Tire Identification Number)**

This is a unique identifier which can be used by a tire manufacturer to identify tires, for example for a product recall, and thus identify the purchasers. The TIN is made up of the manufacturer's identity code, tire size, tire type code and the manufacturing date.

**Load bearing index**

The load bearing index (also load index) is a code that contains the maximum load bearing capacity of a tire.

**Traction**

Traction is the result of friction between the tires and the road surface.

**Treadwear indicators**

Narrow bars (tread wear bars) that are distributed over the tire tread. If the tire tread is level with the bars, the wear limit of  $\frac{1}{16}$  in (1.6 mm) has been reached.

### Occupant distribution

The distribution of occupants in a vehicle at their designated seating positions.

### Total load limit

Rated cargo and luggage load plus 68 kilograms (150 lb) multiplied by the number of seats in the vehicle.

## Changing a wheel

### Flat tire

You can find information on what to do in the event of a flat tire in the "Breakdown assistance" section (▷ page 321). Information on driving with MOExtended tires in the event of a flat tire can be found under "MOExtended tires (tires with run-flat characteristics)" (▷ page 321).

**Vehicle with emergency spare wheel:** in the event of a flat tire, the emergency spare wheel is mounted as described under "Mounting a wheel" (▷ page 358).

### Rotating the wheels

#### WARNING

Interchanging the front and rear wheels may severely impair the driving characteristics if the wheels or tires have different dimensions. The wheel brakes or suspension components may also be damaged. There is a risk of accident.

Rotate front and rear wheels only if the wheels and tires are of the same dimensions.

**!** On vehicles equipped with a tire pressure monitor, electronic components are located in the wheel.

Tire-mounting tools should not be used near the valve. This could damage the electronic components.

Only have tires changed at a qualified specialist workshop.

Always observe the instructions and safety notes in the "Mounting a wheel" section (▷ page 358).

The wear patterns on the front and rear tires differ, depending on the operating conditions. Rotate the wheels before a clear wear pattern has formed on the tires. Front tires typically wear more on the shoulders and the rear tires in the center.

If your vehicle's tire configuration allows, you can rotate the wheels according to the intervals in the tire manufacturer's warranty book in your vehicle documents. If this is not available, the tires should then be replaced every 3,000 to 6,000 miles (5,000 to 10,000 km), or earlier if the tire wear requires this. Do not change the direction of wheel rotation.

Clean the contact surfaces of the wheel and the brake disc thoroughly every time a wheel is interchanged. Check the tire pressure and, if necessary, restart the tire pressure loss warning system or the tire pressure monitor.

### Direction of rotation

Tires with a specified direction of rotation have additional benefits, e.g. if there is a risk of hydroplaning. You will only gain these benefits if the correct direction of rotation is maintained.

An arrow on the sidewall of the tire indicates its correct direction of rotation.

### Storing wheels

Store wheels that are not being used in a cool, dry and preferably dark place. Protect the tires from oil, grease, gasoline and diesel.

### Cleaning the wheels

#### WARNING

The water jet from a circular jet nozzle (dirt blasters) can cause invisible exterior damage

to the tires or chassis components. Components damaged in this way may fail unexpectedly. There is a risk of an accident. Do not use power washers with circular jet nozzles to clean the vehicle. Have damaged tires or chassis components replaced immediately.

## Mounting a wheel

### Preparing the vehicle

- ▶ Stop the vehicle on solid, non-slippery and level ground.
- ▶ Apply the parking brake.
- ▶ Bring the front wheels into the straight-ahead position.
- ▶ Shift the transmission to position **P**.
- ▶ Vehicles with AIRMATIC: make sure that "normal" level is selected (▷ page 189).
- ▶ Switch off the engine.
- ▶ **Vehicles without KEYLESS-GO:** remove the SmartKey from the ignition lock.
- ▶ **Vehicles with KEYLESS-GO:** open the driver's door. The on-board electronics now have status **0**. This is the same as the SmartKey having been removed.
- ▶ **Vehicles with KEYLESS-GO:** remove the Start/Stop button from the ignition lock (▷ page 147).
- ▶ If included in the vehicle equipment, remove the tire-change tool kit from the vehicle (▷ page 320).
- ▶ Secure the vehicle to prevent it from rolling away.

### Securing the vehicle to prevent it from rolling away

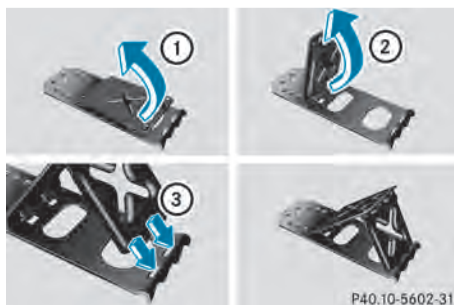

If your vehicle is equipped with a wheel chock, it can be found in the tire-change tool kit (▷ page 320).

The folding wheel chock is an additional safety measure to prevent the vehicle from rolling away, for example when changing a wheel.

- ▶ Fold both plates upwards ①.
- ▶ Fold out lower plate ②.
- ▶ Guide the lugs on the lower plate fully into the openings in base plate ③.



Securing the vehicle on level ground

- ▶ **On level ground:** place chocks or other suitable items under the front and rear of the wheel that is diagonally opposite the wheel you wish to change.





Securing the vehicle on slight downhill gradients

- **On light downhill gradients:** place chocks or other suitable items in front of the wheels of the front and rear axle.

### Raising the vehicle

#### **WARNING**

If you do not position the jack correctly at the appropriate jacking point of the vehicle, the jack could tip over with the vehicle raised. There is a risk of injury.

Only position the jack at the appropriate jacking point of the vehicle. The base of the jack must be positioned vertically, directly under the jacking point of the vehicle.

- ❗ The jack is designed exclusively for jacking up the vehicle at the jacking points. Otherwise, your vehicle could be damaged.

The following must be observed when raising the vehicle:

- to raise the vehicle, only use the vehicle-specific jack that has been tested and approved by Mercedes-Benz. If used incorrectly, the jack could tip over with the vehicle raised.
- the jack is designed only to raise and hold the vehicle for a short time while a wheel is being changed. It is not suited for performing maintenance work under the vehicle.
- avoid changing the wheel on uphill and downhill slopes.

- before raising the vehicle, secure it from rolling away by applying the parking brake and inserting wheel chocks. Never disengage the parking brake while the vehicle is raised.
- the jack must be placed on a firm, flat and non-slip surface. On a loose surface, a large, load-bearing underlay must be used. On a slippery surface, a non-slip underlay must be used, e.g. rubber mats.
- do not use wooden blocks or similar objects as a jack underlay. Otherwise, the jack will not be able to achieve its load-bearing capacity due to the restricted height.
- make sure that the distance between the underside of the tires and the ground does not exceed 1.2 in (3 cm).
- never place your hands and feet under the raised vehicle.
- never lie under the raised vehicle.
- never start the engine when the vehicle is raised.
- never open or close a door or the trunk lid when the vehicle is raised.
- make sure that no persons are present in the vehicle when the vehicle is raised.

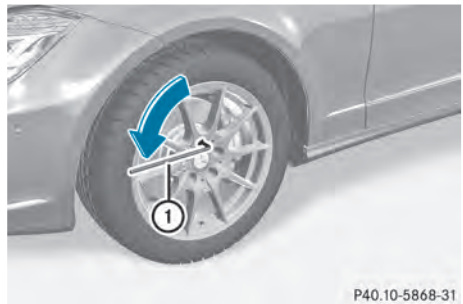

- Using lug wrench ①, loosen the bolts on the wheel you wish to change by about one full turn. Do not unscrew the bolts completely.

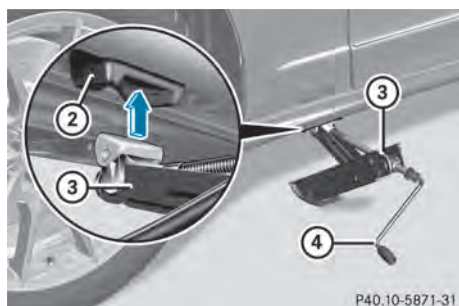

- ▶ Position jack ③ at jacking point ②.

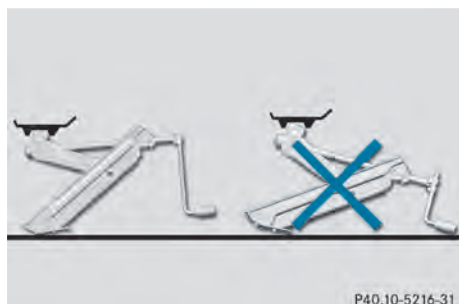

#### Example

- ▶ Make sure the foot of the jack is directly beneath the jacking point.
- ▶ Turn crank ④ clockwise until jack ③ sits completely on jacking point ② and the base of the jack lies evenly on the ground.
- ▶ Turn crank ④ until the tire is raised a maximum of 1.2 in (3 cm) off the ground.

## Removing a wheel

- ⚠ **AMG vehicles:** during removal and repositioning of the wheel, the wheel rim can strike the ceramic-brake disc and damage it. Therefore, take precautions and get a second person to assist you. Alternatively, you can use a second alignment bolt.
- ⚠ Do not place wheel bolts in sand or on a dirty surface. The bolt and wheel hub threads could otherwise be damaged when you screw them in.



- ▶ Unscrew the uppermost wheel bolt completely.
- ▶ Screw alignment bolt ① into the thread instead of the wheel bolt.
- ▶ Unscrew the remaining wheel bolts fully.
- ▶ Remove the wheel.

## Mounting a new wheel

### ⚠ WARNING

Oiled or greased wheel bolts or damaged wheel bolts/hub threads can cause the wheel bolts to come loose. As a result, you could lose a wheel while driving. There is a risk of accident.

Never oil or grease wheel bolts. In the event of damage to the threads, contact a qualified specialist workshop immediately. Have the damaged wheel bolts or hub threads replaced/renewed. Do not continue driving.

**⚠ WARNING**

If you tighten the wheel bolts or wheel nuts when the vehicle is raised, the jack could tip over. There is a risk of injury.

Only tighten the wheel bolts or wheel nuts when the vehicle is on the ground.

Always pay attention to the instructions and safety notes in the "Changing a wheel" section (> page 357).

Only use wheel bolts that have been designed for the wheel and the vehicle. For safety reasons, Mercedes-Benz recommends that you only use wheel bolts which have been approved for Mercedes-Benz vehicles and the respective wheel.

**❗ AMG vehicle with ceramic brake**

**discs:** during removal and repositioning of the wheel, the wheel rim can strike the ceramic-brake disc and damage it. Therefore, take precautions and have a second person assist you. Alternatively, you can use a second alignment bolt.

**❗** To prevent damage to the paintwork, hold the wheel securely against the wheel hub while screwing in the first wheel bolt.

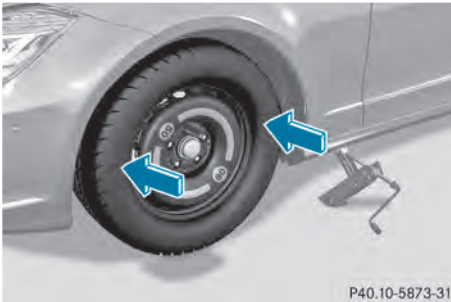

P40.10-5873-31

Positioning a wheel (example: vehicle with an emergency spare wheel)

- ▶ Clean the wheel and wheel hub contact surfaces.
- ▶ Slide the wheel to be mounted onto the alignment bolt and push it on.
- ▶ Tighten the wheel bolts until they are finger-tight.

- ▶ Unscrew the alignment bolt.
- ▶ Tighten the last wheel bolt until it is finger-tight.
- ▶ **Vehicles with a collapsible spare wheel:** inflate the collapsible spare wheel (> page 368). Only then lower the vehicle.

**Lowering the vehicle**

**⚠ WARNING**

The wheels could work loose if the wheel nuts and bolts are not tightened to the specified tightening torque. There is a risk of accident. Have the tightening torque immediately checked at a qualified specialist workshop after a wheel is changed.

**❗ Vehicles with a collapsible spare**

**wheel:** before lowering the vehicle, inflate the collapsible spare wheel with the tire inflation compressor. The wheel rim could otherwise be damaged.

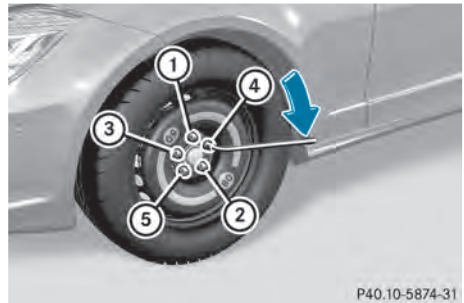

P40.10-5874-31

Tightening the wheel nuts (example: vehicle with an emergency spare wheel)

- ▶ Turn the crank of the jack counter-clockwise until the vehicle is once again standing firmly on the ground.
- ▶ Place the jack to one side.
- ▶ Tighten the wheel bolts evenly in a crosswise pattern in the sequence indicated (① to ⑤). The specified tightening torque is **96 lb-ft (130 Nm)**.
- ▶ Turn the jack back to its initial position.

- ▶ Stow the jack and the rest of the vehicle tools in the trunk again.
- ▶ Check the tire pressure of the newly mounted wheel and adjust it if necessary. Observe the recommended tire pressure (▷ page 338).

**i** Vehicles with tire pressure monitor: all wheels mounted must be equipped with functioning sensors.

## Wheel and tire combinations

### General notes

**!** For safety reasons, Mercedes-Benz recommends that you only use tires and wheels which have been approved by Mercedes-Benz specifically for your vehicle.

These tires have been specially adapted for use with the control systems, such as ABS or ESP®, and are marked as follows:

- MO = Mercedes-Benz Original
- MOE = Mercedes-Benz Original Extended (tires featuring run-flat characteristics)
- MO1 = Mercedes-Benz Original (only certain AMG tires)

Mercedes-Benz Original Extended tires may only be used on wheels that have been specifically approved by Mercedes-Benz.

Only use tires, wheels or accessories tested and approved by Mercedes-Benz. Certain characteristics, e.g. handling, vehicle noise emissions or fuel consumption, may otherwise be adversely affected. In addition, when driving with a load, tire dimension variations could cause the tires to come into contact with the bodywork and axle components. This could result in damage to the tires or the vehicle.

Mercedes-Benz accepts no liability for damage resulting from the use of tires, wheels or accessories other than those tested and approved.

Information on tires, wheels and approved combinations can be obtained from any qualified specialist workshop.

Overview of abbreviations used in the following tire tables:

- BA: both axles
- FA: front axle
- RA: rear axle

The recommended pressures for various operating conditions can be found:

- on the Tire and Loading Information placard with the recommended tire pressures on the B-pillar on the driver's side
- in the tire pressure table on the inside of the fuel filler flap

Observe the notes on recommended tire pressures under various operating conditions (▷ page 338).

Check tire pressures regularly, and only when the tires are cold. Comply with the maintenance recommendations of the tire manufacturer in the vehicle document wallet. Notes on the vehicle equipment – always equip the vehicle with:

- tires of the same size on a given axle (left/right)
- the same type of tires at a given time (summer tires, winter tires, MOExtended tires)

Vehicles with MOExtended tires are not equipped with a TIREFIT kit at the factory. It is therefore recommended that you additionally equip your vehicle with a TIREFIT kit if you mount tires that do not feature run-flat properties, e.g. winter tires. A TIREFIT kit may be obtained from a qualified specialist workshop.

**i** Not all wheel and tire combinations are available at the factory for all countries.

**i** On the following pages, you can find information on approved wheel rims and tire sizes for equipping your vehicle with winter tires. Winter tires are not available

at the factory as standard equipment or optional extras.

If you would like to equip your vehicle with approved winter tires, you may also, in certain circumstances, require rims of the appropriate size. The sizes of the approved winter tires may deviate from that of the standard tires. This is dependent on the model and the equipment installed at the factory.

The tires and wheel rims, as well as further information, can be obtained at a qualified specialist workshop.

## Tires

## CLS 550

## Summer tires

## R18

Tires	Alloy wheels
FA: 255/40 R18 99 Y XL MOExtended <sup>2</sup> RA: 285/35 R18 97 Y MOExtended <sup>2,3</sup>	FA: 8.5 J x 18 H2 Wheel offset: 1.36 in (34.5 mm) RA: 9.5 J x 18 H2 Wheel offset: 1.89 in (48 mm)

## R19

Tires	Alloy wheels
FA: 255/35 R19 96 Y XL RA: 285/30 R19 98 Y XL <sup>3</sup>	FA: 8.5 J x 19 H2 Wheel offset: 1.36 in (34.5 mm) RA: 9.5 J x 19 H2 Wheel offset: 1.89 in (48 mm)



## All-weather tires

## R18

Tires	Alloy wheels
FA: 255/40 R18 99 H XL M+S RA: 285/35 R18 97 H M+S <sup>3</sup>	FA: 8.5 J x 18 H2 Wheel offset: 1.36 in (34.5 mm) RA: 9.5 J x 18 H2 Wheel offset: 1.89 in (48 mm)

## Winter tires

## R18

Tires	Alloy wheels
BA: 255/40 R18 99 V XL M+S 	BA: 8.5 J x 18 H2 Wheel offset: 1.36 in (34.5 mm)
BA: 255/40 R18 99 V M+S  MOExtended <sup>2</sup>	BA: 8.5 J x 18 H2 Wheel offset: 1.36 in (34.5 mm)

<sup>2</sup> MOExtended tires (tires featuring run-flat characteristics) only in combination with an active tire pressure loss warning system or tire pressure monitor.

<sup>3</sup> Use of snow chains is not permitted. Observe the notes under "Snow chains".

**CLS 550 4MATIC****Summer tires****R18**

Tires	Alloy wheels
FA: 255/40 R18 99 Y XL MOExtended <sup>2</sup> RA: 285/35 R18 97 Y MOExtended <sup>2, 3</sup>	FA: 8.5 J x 18 H2 Wheel offset: 1.36 in (34.5 mm) RA: 9.5 J x 18 H2 Wheel offset: 1.89 in (48 mm)



**R19**

Tires	Alloy wheels
FA: 255/35 R19 96 Y XL RA: 285/30 R19 98 Y XL <sup>3</sup>	FA: 8.5 J x 19 H2 Wheel offset: 1.36 in (34.5 mm) RA: 9.5 J x 19 H2 Wheel offset: 1.89 in (48 mm)

**All-weather tires****R18**

Tires	Alloy wheels
FA: 255/40 R18 99 H XL M+S RA: 285/35 R18 97 H M+S <sup>3</sup>	FA: 8.5 J x 18 H2 Wheel offset: 1.36 in (34.5 mm) RA: 9.5 J x 18 H2 Wheel offset: 1.89 in (48 mm)

**Winter tires****R18**

Tires	Alloy wheels
BA: 255/40 R18 99 V XL M+S 	BA: 8.5 J x 18 H2 Wheel offset: 1.36 in (34.5 mm)
BA: 255/40 R18 99 V M+S  MOExtended <sup>2</sup>	BA: 8.5 J x 18 H2 Wheel offset: 1.36 in (34.5 mm)





<sup>2</sup> MOExtended tires (tires featuring run-flat characteristics) only in combination with an active tire pressure loss warning system or tire pressure monitor.

<sup>3</sup> Use of snow chains is not permitted. Observe the notes under "Snow chains".

**CLS 63 AMG****Summer tires****R19**

Tires	Alloy wheels
FA: 255/35 ZR19 (96 Y) XL RA: 285/30 ZR19 (98 Y) XL <sup>3</sup>	FA: 9.0 J x 19 H2 Wheel offset: 1.46 in (37 mm) RA: 10.0 J x 19 H2 Wheel offset: 1.85 in (47 mm)

**Winter tires****R19**

Tires	Alloy wheels
FA: 255/35 R19 96 V XL M+S  RA: 255/35 R19 96 V XL M+S 	FA: 9.0 J x 19 H2 Wheel offset: 1.46 in (37 mm) RA: 9.5 J x 19 H2 Wheel offset: 2.05 in (52 mm)
FA: 255/35 R19 96 V XL M+S  RA: 285/30 R19 98 V XL M+S  <sup>3</sup>	FA: 9.0 J x 19 H2 Wheel offset: 1.46 in (37 mm) RA: 10.0 J x 19 H2 Wheel offset: 1.85 in (47 mm)

**CLS 63 AMG 4MATIC****Summer tires****R19**





Tires	Alloy wheels
FA: 255/35 ZR19 (96 Y) XL RA: 285/30 ZR 19 (98 Y) XL <sup>3</sup>	FA: 9.0 J x 19 H2 Wheel offset: 1.46 in (37 mm) RA: 10.0 J x 19 H2 Wheel offset: 1.85 in (47 mm)

<sup>3</sup> Use of snow chains is not permitted. Observe the notes under "Snow chains".



## Winter tires

## R19

Tires	Alloy wheels
FA: 255/35 R19 96 V XL M+S  RA: 255/35 R19 96 V XL M+S 	FA: 9.0 J x 19 H2 Wheel offset: 1.46 in (37 mm) RA: 9.5 J x 19 H2 Wheel offset: 2.05 in (52 mm)
FA: 255/35 R19 96 V XL M+S  RA: 285/30 R19 98 V XL M+S  <sup>3</sup>	FA: 9.0 J x 19 H2 Wheel offset: 1.46 in (37 mm) RA: 10.0 J x 19 H2 Wheel offset: 1.85 in (47 mm)

## Emergency spare wheel

## Important safety notes

 **WARNING**

The wheel or tire size as well as the tire type of the spare wheel or emergency spare wheel and the wheel to be replaced may differ. Mounting an emergency spare wheel may severely impair the driving characteristics. There is a risk of an accident.

To avoid hazardous situations:

- adapt your driving style accordingly and drive carefully.
- never mount more than one spare wheel or emergency spare wheel that differs in size.
- only use a spare wheel or emergency spare wheel of a different size briefly.
- do not switch ESP<sup>®</sup> off.
- have a spare wheel or emergency spare wheel of a different size replaced at the nearest qualified specialist workshop. Observe that the wheel and tire dimensions as well as the tire type must be correct.

When using an emergency spare wheel or spare wheel of a different size, you must not exceed the maximum speed of 50 mph (80 km/h).

Snow chains must not be mounted on emergency spare wheels.

**General notes**

You should regularly check the pressure of the emergency spare wheel, particularly prior to long trips, and correct the pressure as necessary (> page 338). The applicable value is found on the wheel or under "Technical data" (> page 370).

An emergency spare wheel may also be mounted against the direction of rotation. Observe the time restriction on use as well as the speed limitation specified on the emergency spare wheel.

Replace the tires after six years at the latest, regardless of wear. This also applies to the emergency spare wheel.

**i** When you are driving with the collapsible spare wheel mounted, the tire pressure loss warning system or the tire pressure monitor cannot function reliably. Only restart the tire pressure loss warning system/the tire pressure monitor when the damaged wheel has been replaced with a new wheel.

**Vehicles with tire pressure monitor:** after mounting an emergency spare wheel,

<sup>3</sup> Use of snow chains is not permitted. Observe the notes under "Snow chains".

the system may still display the tire pressure of the removed wheel for a few minutes. The value displayed for the mounted emergency spare wheel is not the same as the current tire pressure of the emergency spare wheel.

### "Minispare" emergency spare wheel/ collapsible spare wheel

#### Removing the "Minispare" emergency spare wheel

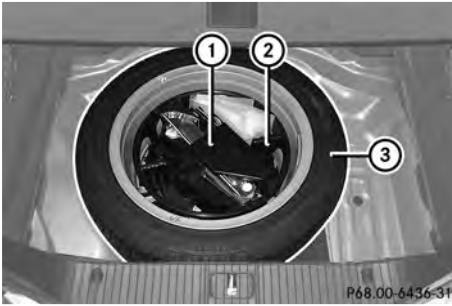

The emergency spare wheel can be found in the stowage well under the trunk floor.

- ▶ Lift the trunk floor upwards (▷ page 283).
- ▶ Turn stowage tray ② counter-clockwise and remove together with vehicle tool kit tray ①.
- ▶ Remove "Minispare" emergency spare wheel ③.

#### Removing the collapsible spare wheel (AMG vehicles)

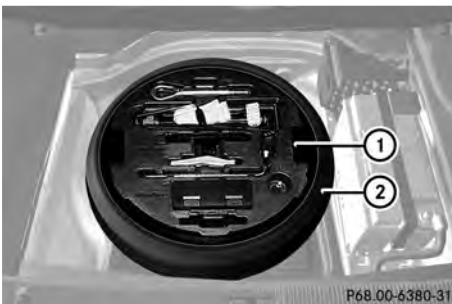

The emergency spare wheel can be found in the stowage well under the trunk floor.

- ▶ Lift the trunk floor upwards (▷ page 283).
- ▶ Reach into cutout ① in the tool holder and lift it up.
- ▶ Remove collapsible spare wheel ②.

Always observe the instructions and safety notes in the "Mounting a wheel" section (▷ page 358).

#### Stowing a used collapsible spare wheel

**!** Only place the collapsible spare wheel in the vehicle when it is dry. Otherwise, moisture may get into the vehicle.

Take the following steps to stow a used collapsible spare wheel. It will not otherwise install into the spare wheel well. Mercedes-Benz recommends that you have this work performed at a qualified specialist workshop, e.g. at an authorized Mercedes-Benz Center.

- ▶ Unscrew the valve cap from the valve.
- ▶ Use the back of the valve cap to unscrew the valve insert from the valve and release the air.
- i** Fully deflating the tires can take a few minutes.
- ▶ Screw the valve insert back into the valve.
- ▶ Screw the valve cap back on.
- ▶ Remove the protective sheet from the vehicle tool kit and pull it over the collapsible spare wheel.
- ▶ Stow the collapsible spare wheel in the emergency spare wheel well under the trunk.

#### Inflating the collapsible spare wheel

**!** Inflate the collapsible spare wheel using the tire inflation compressor before lowering the vehicle. The wheel rim could otherwise be damaged.

- ❗ Do not operate the tire inflation compressor for longer than eight minutes at a time without a break. It may otherwise overheat.

The tire inflation compressor can be operated again once it has cooled down.

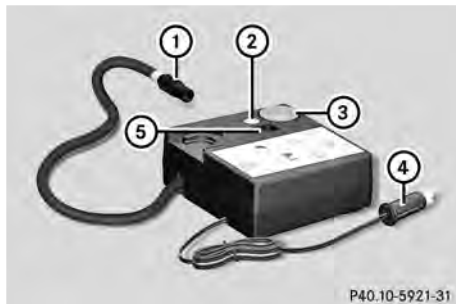

- ▶ Mount the collapsible spare wheel as described (▶ page 357).  
The collapsible spare wheel must be mounted before it is inflated.
- ▶ Pull connector ④ and the air hose out of the housing.
- ▶ Remove the cap from the valve on the collapsible spare wheel.
- ▶ Screw union nut ① on the air hose onto the valve.
- ▶ Make sure on/off switch ⑤ of the tire inflation compressor is set to **0**.
- ▶ Insert connector ④ into the cigarette lighter socket or into a 12 V socket in your vehicle.  
Observe the notes on the cigarette lighter (▶ page 288). Observe the notes on sockets (▶ page 289).
- ▶ Turn the SmartKey to position **1** in the ignition lock (▶ page 147).
- ▶ Press on/off switch ⑤ on the tire inflation compressor to **I**.  
The tire inflation compressor is switched on. The tire is inflated. The tire pressure is shown on pressure gauge ③.
- ▶ Inflate the tire to the specified tire pressure.

The specified tire pressure is printed on the yellow label of the emergency spare wheel.

- ▶ When the specified tire pressure has been reached, press on/off switch ⑤ on the electric air pump to **0**.  
The tire inflation compressor is switched off.
- ▶ Turn the SmartKey to position **0** in the ignition lock.
- ▶ If the tire pressure is higher than the specified pressure, press pressure release button ② until the correct tire pressure has been reached.
- ▶ Unscrew union nut ① on the air hose from the valve.
- ▶ Screw the valve cap onto the collapsible spare wheel valve again.
- ▶ Stow plug ④ and the air hose in the lower section of the blower housing.
- ▶ Stow the tire inflation compressor in the vehicle.

**Technical data****All vehicles (except AMG vehicles)****"Minispare" emergency spare wheel**

Tires	Alloy wheels
T 155/70 R17 110 M <sup>4,5</sup> Tire pressure: 420 kPa (4.2 bar/61 psi)	4.0 B x 17 H2 <sup>4,5</sup> Wheel offset: 1.34 in (34 mm)
T 155/60 R18 107 M Tire pressure: 420 kPa (4.2 bar/61 psi)	4.5 B x 18 H2 Wheel offset: 1.42 in (36 mm)

**AMG vehicles****Collapsible spare wheel**

Tires	Alloy wheels
175/50 - 19 97 P Tire pressure: 350 kPa (3.5 bar/51 psi)	6.5 B x 19 H2 Wheel offset: 0.55 in (14 mm)

<sup>4</sup> Not in conjunction with Sports package code 950.

<sup>5</sup> Not for CLS 550 and CLS 550 4MATIC.

<b>Useful information .....</b>	<b>372</b>
<b>Information regarding technical data .....</b>	<b>372</b>
<b>Warranty .....</b>	<b>372</b>
<b>Identification plates .....</b>	<b>372</b>
<b>Service products and filling capaci- ties .....</b>	<b>373</b>
<b>Vehicle data .....</b>	<b>379</b>

### Useful information

- ① This Operator's Manual describes all models and all standard and optional equipment of your vehicle available at the time of publication of the Operator's Manual. Country-specific differences are possible. Please note that your vehicle may not be equipped with all features described. This also applies to safety-related systems and functions.
- ① Read the information on qualified specialist workshops: (▷ page 26).

### Information regarding technical data

- ① The data stated here specifically refers to a vehicle with standard equipment. Consult an authorized Mercedes-Benz Center for the data for all vehicle variants and trim levels.

### Warranty

Your vehicle is covered under the terms of the warranties printed in the Service and Warranty Information booklet.

Your authorized Mercedes-Benz Center will replace and repair all factory-installed parts in accordance with the following warranty terms and conditions:

- New Vehicle Limited Warranty
- Emission Systems Warranty
- Emission Performance Warranty
- California, Connecticut, Maine, Massachusetts, New York, Pennsylvania, Rhode Island and Vermont Emission Control System Warranty
- State warranty enforcement laws (Lemon Laws)

Replacement parts and accessories are covered by the Mercedes-Benz Parts and

Accessories warranties. These are available at any authorized Mercedes-Benz Center.

- ① If you lose the Service and Warranty Information booklet, contact an authorized Mercedes-Benz Center to arrange a replacement. It will be mailed to you.

### Identification plates

#### Vehicle identification plate with vehicle identification number (VIN)



- ▶ Open the driver's door. You will see vehicle identification plate ①.



Example: vehicle identification plate (USA only)

- ② VIN
- ③ Paint code



Example: vehicle identification plate (Canada only)

- ② VIN
- ③ Paint code

❶ The data shown on the vehicle identification plate is used only as an example. This data is different for every vehicle and can deviate from the data shown here. You can find the data applicable to your vehicle on the vehicle identification plate.

## VIN

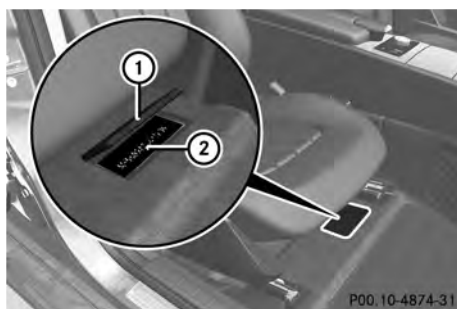

- ▶ Slide the right-hand front seat to its rearmost position.
- ▶ Fold floor covering ① upwards. You will see VIN ②.

The VIN can also be found in the following locations:

- on the lower edge of the windshield (▷ page 373)
- on the vehicle identification plate (▷ page 372)

## Engine number

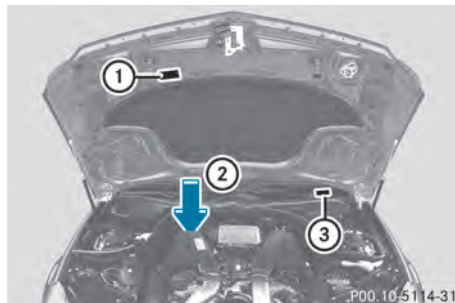

- ① Emission control information plate, including the certification of both federal and Californian emissions standards
- ② Engine number (stamped into the crankcase)
- ③ VIN (on the lower edge of the windshield)

## Service products and filling capacities

### Important safety notes

#### ⚠ WARNING

Service products may be poisonous and hazardous to health. There is a risk of injury. Comply with instructions on the use, storage and disposal of service products on the labels of the respective original containers. Always store service products sealed in their original containers. Always keep service products out of the reach of children.

#### ♻ Environmental note

Dispose of service products in an environmentally responsible manner.

Service products include the following:

- Fuels
- Lubricants (e.g. engine oil, transmission oil)
- Coolant
- Brake fluid
- Windshield washer fluid
- Climate control system refrigerant

Comply with all valid regulations with respect to handling, storing, and disposing of service fluids.

Components and service products must be matched. You should therefore only use products that have been tested and approved by Mercedes-Benz.

Information on tested and approved products can be obtained at an authorized Mercedes-Benz Center or on the Internet at <http://bevo.mercedes-benz.com>.

You can recognize service products approved by Mercedes-Benz by the following inscription on the containers:

- MB-Freigabe (e.g. MB-Freigabe 229.51)
- MB Approval (e.g. MB Approval 229.51)

Other designations or recommendations indicate a level of quality or a specification in accordance with an MB Sheet number (e.g. MB 229.5). They have not necessarily been approved by Mercedes-Benz.

## Fuel

### Important safety notes

#### WARNING

Fuel is highly flammable. If you handle fuel incorrectly, there is a risk of fire and explosion.

You must avoid fire, open flames, creating sparks and smoking. Switch off the engine and, if applicable, the auxiliary heating before refueling.

#### WARNING

Fuel is poisonous and hazardous to health. There is a risk of injury.

You must make sure that fuel does not come into contact with your skin, eyes or clothing and that it is not swallowed. Do not inhale fuel vapors. Keep fuel away from children.

If you or others come into contact with fuel, observe the following:

- Wash away fuel from skin immediately using soap and water.
- If fuel comes into contact with your eyes, immediately rinse them thoroughly with clean water. Seek medical assistance without delay.
- If fuel is swallowed, seek medical assistance without delay. Do not induce vomiting.
- Immediately change out of clothing which has come into contact with fuel.

### Tank capacity

Model	Total capacity
All models	21.1 US gal (80.0 l)

Model	Of which reserve
All models (except for AMG vehicles)	Approx. 2.4 US qt (9.0 l)
All models (AMG vehicles)	Approx. 3.7 US gal (14.0 l)

### Gasoline

#### Fuel grade

 Do not use diesel to refuel vehicles with a gasoline engine. Do not switch on the ignition if you accidentally refuel with the wrong fuel. Otherwise, the fuel will enter the fuel system. Even small amounts of the wrong fuel could result in damage to the fuel system and the engine. Notify a qualified specialist workshop and have the fuel tank and fuel lines drained completely.



**!** To ensure the longevity and full performance of the engine, only premium-grade unleaded gasoline must be used.

If standard premium-grade unleaded gasoline is unavailable and unleaded gasoline of a lower grade is used for refueling, observe the following precautions:

- only fill the fuel tank to half full with regular unleaded gasoline and fill the rest with premium-grade unleaded gasoline as soon as possible.
- do not drive at the maximum speed.
- avoid sudden acceleration and engine speeds above 3000 rpm.
- never refuel using fuel with an octane number lower than 87. Otherwise, engine failure could occur.

Only refuel using unleaded gasoline with a minimum octane rating of 91. If gasoline with a lower octane rating is used, engine damage may occur.

If unleaded gasoline is unavailable and gasoline of an octane grade lower than 91 is used, observe the following precautions:

- Only refuel using enough gasoline to reach a gas station that offers unleaded gasoline.
- Do not under any circumstances refuel using gasoline with a lower octane rating than 87. Otherwise, immediate engine damage may occur.
- Avoid sudden acceleration and engine speeds over 3,000 rpm.

Using mixtures of methanol and ethanol is not permitted. E10 fuel, a mixture of 10% ethanol and 90% unleaded gasoline, may be used.

You will usually find information about the fuel grade on the pump. If you cannot find the label on the pump, ask the staff for assistance.

**i** For further information, consult a qualified specialist workshop or on the Internet at <http://www.mbusa.com> (USA only).

Information on refueling (> page 165).

### Additives

**!** Operating the engine with fuel additives added later can lead to engine failure. Do not mix fuel additives with fuel. This does not include additives for the removal and prevention of residue buildup. Gasoline must only be mixed with additives recommended by Mercedes-Benz. Comply with the instructions for use on the product label. More information about recommended additives can be obtained from any authorized Mercedes-Benz Center.

Mercedes-Benz recommends that you use branded fuels that have additives.

Do not mix fuel additives with fuel. This causes unnecessary costs and could lead to engine failure.

Carbon deposits may form if the availability of gasoline with relevant additives is insufficient (in certain regions). In this case, Mercedes-Benz recommends additives approved for use in Mercedes-Benz vehicles; see <http://bevo.mercedes-benz.com>.

### Engine oil

#### General notes

**!** Never use engine oil or an oil filter of a specification other than is necessary to fulfill the prescribed service intervals. Do not change the engine oil or oil filter in order to achieve longer replacement intervals than those prescribed. You could otherwise cause engine damage or damage to the exhaust gas aftertreatment.

Follow the instructions in the service interval display regarding the oil change. Otherwise, you may damage the engine and the exhaust gas aftertreatment.

Comply with the important safety notes for service products when handling engine oil (> page 373).

The engine oils are matched to the performance of Mercedes-Benz engines and service intervals. You should therefore only use engine oils and oil filters that are approved for vehicles with maintenance systems.

For a list of approved engine oils and oil filters, consult an authorized Mercedes-Benz Center. Or visit the website <http://bevo.mercedes-benz.com>.

The table shows which engine oils have been approved for your vehicle.

Model	Engine model	MB Approval
CLS 550 CLS 550 4MATIC	278	229.5
CLS 63 AMG CLS 63 AMG 4MATIC	157	229.5

Use only SAE 0W-40 or SAE 5W-40 engine oils for AMG vehicles.

- MB approval is indicated on the oil containers.

### Filling capacities

The following values refer to an oil change including the oil filter.

Model	Capacity
All models (except for AMG vehicles)	8.5 US qt (8.0 l)
All models (AMG vehicles)	With external oil cooler: 9.0 US qt (8.5 l)

### Additives

- Do not use any additives in the engine oil. This could damage the engine.

### Engine oil viscosity

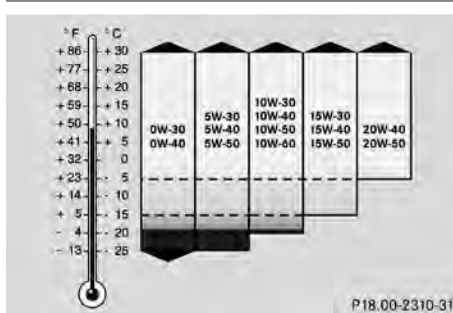

Viscosity describes the flow characteristics of a fluid. If an engine oil has a high viscosity, this means that it is thick; a low viscosity means that it is thin.

Select an engine oil with an SAE classification (viscosity) suitable for the prevailing outside temperatures. The table shows you which SAE classifications are to be used. The low-temperature characteristics of engine oils can deteriorate significantly, e.g. as a result of aging, soot and fuel deposits. It is therefore strongly recommended that you carry out regular oil changes using an approved engine oil with the appropriate SAE classification.

### Brake fluid

#### ⚠ WARNING

The brake fluid constantly absorbs moisture from the air. This lowers the boiling point of the brake fluid. If the boiling point of the brake fluid is too low, vapor pockets may form in the brake system when the brakes are applied hard. This would impair braking efficiency. There is a risk of an accident.

You should have the brake fluid renewed at the specified intervals.

Comply with the important safety notes for service products when handling brake fluid (> page 373).

The brake fluid change intervals can be found in the Maintenance Booklet.

Only use brake fluid approved by Mercedes-Benz according to MB Approval 33 1.0.

Information about approved brake fluid can be obtained at any qualified specialist workshop or on the Internet at <http://bevo.mercedes-benz.com>.

- i** Have the brake fluid regularly replaced at a qualified specialist workshop and the replacement confirmed in the Maintenance Booklet.

## Coolant

### Important safety notes

#### WARNING

If antifreeze comes into contact with hot components in the engine compartment, it may ignite. There is a risk of fire and injury.

Let the engine cool down before you add antifreeze. Make sure that antifreeze is not spilled next to the filler neck. Thoroughly clean the antifreeze from components before starting the engine.

- !** Only add coolant that has been premixed with the desired antifreeze protection. You could otherwise damage the engine.

Further information on coolants can be found in the Mercedes-Benz Specifications for Service Products, MB Specifications for Service Products 310.1, e.g. on the Internet at <http://bevo.mercedes-benz.com>. Or contact a qualified specialist workshop.

- !** Always use a suitable coolant mixture, even in countries where high temperatures prevail.

Otherwise, the engine cooling system is not sufficiently protected from corrosion and overheating.

Comply with the important safety precautions for service products when handling coolant (▷ page 373).

The coolant is a mixture of water and antifreeze/corrosion inhibitor. It performs the following tasks:

- corrosion protection
- antifreeze protection
- raising the boiling point

If the coolant has antifreeze protection down to -35 °F (-37 °C), the boiling point of the coolant during operation is approximately 266 °F (130 °C).

The antifreeze/corrosion inhibitor concentration in the engine cooling system should:

- be at least 50%. This will protect the engine cooling system against freezing down to approximately -35 °F (-37 °C).
- not exceed 55% (antifreeze protection down to -49 °F [-45 °C]). Otherwise, heat will not be dissipated as effectively.

If the vehicle has lost coolant, add equal amounts of water and antifreeze/corrosion inhibitor.

Mercedes-Benz recommends an antifreeze/corrosion inhibitor concentrate in accordance with MB Specifications for Service Products 310.1.

The coolant is checked with every maintenance interval at a qualified specialist workshop.

- i** When the vehicle is first delivered, it is filled with a coolant mixture that ensures adequate antifreeze and corrosion protection.

### Filling capacities

Model	Capacity
<b>All models (except for AMG vehicles)</b>	Approx. 13.0 US qt (12.3 l)
<b>All models (AMG vehicles)</b>	Approx. 11.5 US qt (10.9 l)

- i** Use MB 325.0 or MB 326.0 corrosion inhibitor/antifreeze.

## Windshield washer system and headlamp cleaning system

### Important safety notes

#### WARNING

Windshield washer concentrate is highly flammable. If it comes into contact with hot engine components or the exhaust system it could ignite. There is a risk of fire and injury. Make sure that no windshield washer concentrate is spilled next to the filler neck.

**!** Only use washer fluid that is suitable for plastic lamp lenses, e.g. MB SummerFit or MB WinterFit. Unsuitable washer fluid could damage the plastic lenses of the headlamps.

**!** Do not add distilled or de-ionized water to the washer fluid container. Otherwise, the level sensor may be damaged.

**!** Only MB SummerFit and MB WinterFit washer fluid should be mixed together. The spray nozzles may otherwise become blocked.

Comply with the important safety notes for service products when handling washer fluid (▷ page 373).

At temperatures above freezing:

► Fill the washer fluid reservoir with a mixture of water and windshield washer fluid, e.g. MB SummerFit.

Add 1 part MB SummerFit to 100 parts water.

At temperatures below freezing:

► Fill the washer fluid reservoir with a mixture of water and washer fluid, e.g. MB WinterFit.

Adapt the mixing ratio to the outside temperature.

- Down to 14 °F (-10 °C): mix 1 part MB WinterFit to 2 parts water.
- Down to -4 °F (-20 °C): mix 1 part MB WinterFit to 1 part water.
- Down to -20.2 °F (-29 °C): mix 2 parts MB WinterFit to 1 part water.

**i** Add windshield washer fluid, e.g. MB SummerFit or MB WinterFit, to the washer fluid all year round.

## Climate control system refrigerant

### Important safety notes

#### Type of refrigerant

The climate control system of your vehicle is filled with refrigerants R-134a.

The instruction label regarding the refrigerant type used can be found on the radiator cross member.

#### Refrigerant R-134a

**!** Only the refrigerant R-134a and the PAG oil approved by Mercedes-Benz may be used. The approved PAG oil may not be mixed with any other PAG oil that is not approved for R-134a refrigerant. Otherwise, the climate control system may be damaged.

Service work, such as topping-up refrigerant or replacing components, may only be carried out by a qualified specialist workshop. All applicable regulations must be adhered to, SAE standard J639 included.

Always have work on the climate control system carried out at a qualified specialist workshop.

### Refrigerant instruction label



Example: refrigerant instruction label

- ① Warning symbol
- ② Refrigerant filling capacity
- ③ Applicable SAE standards
- ④ PAG oil part number
- ⑤ Type of refrigerant

Warning symbols ① indicate:

- possible dangers
- having service work carried out at a qualified specialist workshop

### Filling capacities

All models	Capacity
Refrigerant	590 ± 10 g (20.8 ± 0.4 oz)
PAG oil	120 g (4.2 oz)

### Vehicle data

#### General notes

Please note that for the specified vehicle data:

- the heights specified may vary as a result of:
  - tires
  - load
  - condition of the suspension
  - optional equipment
- the vehicle length specified includes the front license plate adapter.

## Dimensions and weights



Model	Opening height ①
All models (except AMG vehicles)	69.8 in (1772 mm)
CLS 63 AMG	70.0 in (1777 mm)
CLS 63 AMG 4MATIC	71.1 in (1806 mm)

All models (except AMG vehicles)	
Vehicle length	195.1 in (4956 mm)
Vehicle width including exterior mirrors	81.7 in (2075 mm)
Vehicle height	55.3 in (1404 mm)
Wheelbase	113.1 in (2874 mm)
Turning radius	37.0 ft (11.27 m)
Maximum roof load	220 lb (100 kg)
Maximum trunk load	220 lb (100 kg)

## All models (AMG vehicles)

Vehicle length	196.7 in (4996 mm)
Vehicle width including exterior mirrors	81.7 in (2075 mm)
Vehicle height	55.4 in (1406 mm)
Wheelbase	113.1 in (2874 mm)
Turning radius	37.1 ft (11.30 m)
Maximum roof load	220 lb (100 kg)
Maximum trunk load	220 lb (100 kg)