



M-Class

Operator's Manual

M-Class Operator's Manual



1665844501

Order no. 6515 0530 13 Part no. 1665844501 Edition A 2015



Mercedes-Benz

Symbols

Registered trademarks:

- Bluetooth® is a registered trademark of Bluetooth SIG Inc.
- DTS is a registered trademark of DTS, Inc.
- Dolby and MLP are registered trademarks of DOLBY Laboratories.
- BabySmart™, ESP® and PRE-SAFE® are registered trademarks of Daimler AG.
- HomeLink® is a registered trademark of Johnson Controls.
- iPod® and iTunes® are registered trademarks of Apple Inc.
- Logic7® is a registered trademark of Harman International Industries.
- Microsoft® and Windows media® are registered trademarks of Microsoft Corporation.
- SIRIUS is a registered trademark of Sirius XM Radio Inc.
- HD Radio is a registered trademark of iBiquity Digital Corporation.
- Gracenote® is a registered trademark of Gracenote, Inc.
- ZAGATSurvey® and related brands are registered trademarks of ZagatSurvey, LLC.

In this Operator's Manual you will find the following symbols:

WARNING

Warning notes make you aware of dangers which could pose a threat to your health or life, or to the health and life of others.

Environmental note

Environmental notes provide you with information on environmentally aware actions or disposal.

 Notes on material damage alert you to dangers that could lead to damage to your vehicle.

 Practical tips or further information that could be helpful to you.

▶ This symbol indicates an instruction that must be followed.

▶ Several of these symbols in succession indicate an instruction with several steps.

(▷ This symbol tells you where you can find more information about a topic.

▷▷ This symbol indicates a warning or an instruction that is continued on the next page.

Display This font indicates a display in the multifunction display/COMAND display.

Parts of the software in the vehicle are protected by copyright © 2005 The FreeType Project <http://www.freetype.org>. All rights reserved.

Publication details

Internet

Further information about Mercedes-Benz vehicles and about Daimler AG can be found on the following websites:

<http://www.mbusa.com> (USA only)

<http://www.mercedes-benz.ca> (Canada only)

Editorial office

©Daimler AG: Not to be reprinted, translated or otherwise reproduced, in whole or in part, without written permission from Daimler AG.

Vehicle manufacturer

Daimler AG
Mercedesstraße 137
70327 Stuttgart
Germany

Welcome to the world of Mercedes-Benz

We urge you to read this Operator's Manual carefully and familiarize yourself with the vehicle before driving. For your own safety and a longer vehicle life, follow the instructions and warning notices in this manual. Ignoring them could result in damage to the vehicle or personal injury to you or others.

Vehicle damage caused by failure to follow instructions is not covered by the Mercedes-Benz Limited Warranty.

The equipment or product designation of your vehicle may vary depending on:

- model
- order
- country specification
- availability

Mercedes-Benz therefore reserves the right to introduce changes in the following areas:

- design
- equipment
- technical features

The equipment in your vehicle may therefore differ from that shown in the descriptions and illustrations.

The following are integral components of the vehicle:

- Operator's Manual
- Maintenance Booklet
- Equipment-dependent supplements

Keep these documents in the vehicle at all times. If you sell the vehicle, always pass all documents on to the new owner.

The technical documentation team at Daimler AG wishes you safe and pleasant motoring.

Mercedes-Benz USA, LLC

Mercedes-Benz Canada, Inc.

A Daimler Company

Index	4	At a glance	33
Introduction	24	Safety	43
		Opening and closing	79
		Seats, steering wheel and mirrors ..	103
		Lights and windshield wipers	119
		Climate control	137
		Driving and parking	155
		On-board computer and displays	265
		Stowage and features	333
		Maintenance and care	365
		Breakdown assistance	381
		Wheels and tires	399
		Technical data	445

- 1, 2, 3 ...**
- 115 V socket** 350
- 12 V socket**
see Sockets
- 360° camera**
Cleaning 376
Function/notes 229
- 4ETS**
see ETS/4ETS (Electronic Trac-
tion System)
- 4MATIC (permanent four-wheel
drive)** 249
- A**
- ABS (Anti-lock Braking System)**
Display message 285
Function/notes 68
Important safety notes 68
Warning lamp 321
- Accident**
Automatic measures after an acci-
dent 60
- Activating/deactivating cooling
with air dehumidification** 144
- Active Blind Spot Assist**
Activating/deactivating (on-
board computer) 276
Display message 308
Function/information 241
Trailer towing 244
- Active Curve System**
Display message 305
Function/notes 212
- Active Driving Assistance package ..** 241
- Active Lane Keeping Assist**
Activating/deactivating (on-
board computer) 276
Display message 307
Function/information 244
Trailer towing 247
- Active light function** 125
- Active Parking Assist**
Display message 308
Exiting a parking space 223
Function/notes 220
Important safety notes 220
Parking 222
Towing a trailer 224
- ADAPTIVE BRAKE** 75
- Adaptive Brake Assist**
Display message 292
Function/notes 71
- Adaptive damping system**
see ADS (Adaptive Damping System)
- Adaptive Highbeam Assist**
Display message 300
Function/notes 126
Switching on/off 126
- Additives (engine oil)** 453
- ADS (Adaptive Damping System)**
Function/notes 212
- Air bags**
Deployment 58
Display message 295
Front air bag (driver, front
passenger) 51
Important safety notes 50
Introduction 50
Knee bag 52
PASSENGER AIR BAG OFF indica-
tor lamp 45
Side impact air bag 52
Window curtain air bag 52
- Air-conditioning system**
see Climate control
- Air filter (display message)** 303
- AIR FLOW** 147
- AIRMATIC package**
ADS (Adaptive Damping System) ... 212
Function/notes 211
Level control 213
- Air vents**
Glove box 153
Important safety notes 152
Rear 153
Setting 152
Setting the center air vents 152
Setting the side air vents 153
- Alarm**
ATA (Anti-Theft Alarm system) 77
Switching off (ATA) 77
Switching the function on/off
(ATA) 77

- Alarm system**
see ATA (Anti-Theft Alarm system)
- Ambient lighting**
Setting the brightness (on-board computer) 278
Setting the color (on-board computer) 278
- AMG adaptive sport suspension system** 215
- AMG menu (on-board computer)** 281
- Anti-lock braking system**
see ABS (Anti-lock Braking System)
- Anti-Theft Alarm system**
see ATA (Anti-Theft Alarm system)
- Approach/departure angle** 194
- Ashtray** 348
- Assistance display (on-board computer)** 275
- Assistance menu (on-board computer)** 275
- ASSYST PLUS**
Displaying a service message 371
Hiding a service message 371
Notes 370
Resetting the service interval display 371
Service message 370
Special service requirements 371
- ATA (Anti-Theft Alarm system)**
Activating/deactivating 77
Function 77
Switching off the alarm 77
- ATTENTION ASSIST**
Activating/deactivating 276
Display message 304
Function/notes 233
- Audio menu (on-board computer)** 272
- Audio system**
see separate operating instructions
- Authorized Mercedes-Benz Center**
see Qualified specialist workshop
- Authorized workshop**
see Qualified specialist workshop
- AUTO lights**
Display message 300
see Lights
- Automatic car wash (care)** 372
- Automatic engine start (ECO start/stop function)** 163
- Automatic engine switch-off (ECO start/stop function)** 162
- Automatic headlamp mode** 120
- Automatic transmission**
Accelerator pedal position 171
Automatic drive program 173
Changing gear 171
DIRECT SELECT lever 168
Display message 315
Drive program display 168
Driving tips 171
Emergency running mode 177
Engaging drive position 170
Engaging neutral 169
Engaging park position automatically 169
Engaging reverse gear 169
Engaging the park position 168
Kickdown 171
Manual drive program 173
Manual drive program (AMG vehicles) 174
Manual drive program (vehicles with the ON&OFFROAD package) .. 174
Overview 168
Problem (malfunction) 177
Program selector button 172
Pulling away 160
Starting the engine 160
Steering wheel paddle shifters 172
Trailer towing 171
Transmission position display 168
Transmission positions 170
- Automatic transmission emergency mode** 177
- Axle load, permissible (trailer towing)** 460

B

- Bag hook** 339
- Ball coupling**
Installing 258
Removing 262
Storing 262
- BAS (Brake Assist System)** 68

- BAS PLUS (Brake Assist System PLUS)** 69
- Battery (SmartKey)**
- Checking 83
 - Important safety notes 83
 - Replacing 83
- Battery (vehicle)**
- Charging 389
 - Display message 301
 - Important safety notes 387
 - Jump starting 391
 - Overview 387
- Belt**
- see Seat belts
- Blind Spot Assist**
- Activating/deactivating 276
 - Display message 308
 - Notes/function 237
 - Trailer towing 239
 - see Active Blind Spot Assist
- BlueTEC**
- Adding DEF 180
- BlueTEC (DEF)** 451
- Brake Assist**
- see BAS (Brake Assist System)
- Brake fluid**
- Display message 291
 - Notes 453
- Brake lamps**
- Changing bulbs 132
 - Display message 298
- Brakes**
- ABS 68
 - Adaptive Brake Assist 71
 - BAS 68
 - BAS PLUS 69
 - Brake fluid (notes) 453
 - Display message 285
 - High-performance brake system 189
 - Important safety notes 188
 - Maintenance 189
 - Parking brake 184
 - Riding tips 188
 - Warning lamp 320
- Breakdown**
- see Flat tire
 - see Towing away
- Brightness control (instrument cluster lighting)** 35
- Bulbs**
- see Replacing bulbs
- C**
- California**
- Important notice for retail customers and lessees 26
- Calling up a malfunction**
- see Display messages
- Car**
- see Vehicle
- Care**
- 360° camera 376
 - Carpets 379
 - Car wash 372
 - Display 377
 - Exhaust pipe 376
 - Exterior lights 375
 - Gear or selector lever 378
 - Interior 377
 - Matte finish 374
 - Night View Assist Plus 377
 - Notes 371
 - Paint 373
 - Plastic trim 378
 - Power washer 373
 - Rear view camera 376
 - Roof lining 379
 - Seat belt 379
 - Seat cover 378
 - Sensors 375
 - Steering wheel 378
 - Trim pieces 378
 - Washing by hand 373
 - Wheels 374
 - Windows 375
 - Wiper blades 375
 - Wooden trim 378
- Cargo compartment cover**
- Notes/how to use 340
- Cargo compartment enlargement**
- Important safety notes 337
- Cargo compartment floor**
- Opening/closing 344
 - Stowage well (under) 344

- Cargo net**
 - Attaching 342
 - Important safety information 342
- Cargo tie down rings** 339
- Car key**
 - see SmartKey
- CD player/CD changer (on-board computer)** 273
- Center console**
 - Lower section 39
 - Upper section 38
- Central locking**
 - Automatic locking (on-board computer) 279
 - Locking/unlocking (SmartKey) 80
- Changing bulbs**
 - Brake lamps 132
 - High-beam headlamps 131
 - Low-beam headlamps 130
 - Parking lamps 131
 - Side marker lamps 131
 - Standing lamps (front) 131
- Child-proof locks**
 - Important safety notes 66
 - Rear doors 66
- Children**
 - In the vehicle 61
 - Restraint systems 62
 - Special seat belt retractor 61
- Child seat**
 - Forward-facing restraint system 65
 - LATCH-type (ISOFIX) child seat anchors 63
 - On the front-passenger seat 65
 - Rearward-facing restraint system 65
 - Top Tether 64
- Cigarette lighter** 348
- Cleaning**
 - Mirror turn signal 375
 - Trailer tow hitch 376
- Climate control**
 - Automatic climate control (3-zone) 142
 - Controlling automatically 146
 - Cooling with air dehumidification .. 144
 - Defrosting the windows 150
 - Defrosting the windshield 149
 - Dual-zone automatic climate control 139
 - General notes 138
 - Indicator lamp 146
 - Information about using automatic climate control 144
 - Maximum cooling 149
 - Overview of systems 138
 - Problems with cooling with air dehumidification 146
 - Problem with the rear window defroster 151
 - Rear control panel 142
 - Refrigerant 455
 - Refrigerant filling capacity 455
 - Setting the air distribution 148
 - Setting the airflow 148
 - Setting the air vents 152
 - Setting the climate mode (AIR FLOW) 147
 - Setting the temperature 147
 - Switching air-recirculation mode on/off 151
 - Switching on/off 144
 - Switching residual heat on/off 151
 - Switching the rear window defroster on/off 150
 - Switching the ZONE function on/off 149
- Climate control system**
 - Automatic engine start 163
 - Automatic engine switch-off 162
 - Deactivating/activating 163
 - General information 162
 - Important safety notes 162
 - Introduction 162
- Coat hooks** 342
- Cockpit**
 - Overview 34
 - see Instrument cluster
- COLLISION PREVENTION ASSIST**
 - Operation/notes 70
- COMAND**
 - ON&OFFROAD menu 255
 - see separate operating instructions
- COMAND display**
 - Cleaning 377

Combination switch	123
Combined cargo cover and net	341
Consumption statistics (on-board computer)	269
Convenience closing feature	95
Convenience opening feature	95
Coolant (engine)	
Checking the level	369
Display message	300
Filling capacity	454
Important safety notes	453
Temperature (on-board computer)	281
Temperature gauge	266
Warning lamp	328
Cooling	
see Climate control	
Copyright	31
Cornering light function	
Display message	297
Function/notes	125
Crash-responsive emergency lighting	129
Cruise control	
Activating	196
Activation conditions	196
Cruise control lever	196
Deactivating	197
Display message	311
Driving system	195
Function/notes	195
Important safety notes	196
Storing and maintaining current speed	196
Cup holder	
Center console	346
Important safety notes	345
Rear compartment	346
Temperature controlled	346
Customer Assistance Center (CAC)	29
Customer Relations Department	29

D

Dashboard

see Instrument cluster

Data

see Technical data

Daytime running lamps

Display message	299
Function/notes	120
Switching on/off (on-board computer)	277

Declarations of conformity

DEF

Adding	180
Display message	303
Filling capacity	452
Important safety notes	451

Delayed switch-off

Exterior lighting (on-board computer)	278
Interior lighting	279

Diagnostics connection

Diesel

Differential lock (display message)

Digital speedometer

DIRECT SELECT lever

Automatic transmission	168
------------------------------	-----

Display messages

ASSYST PLUS	370
Calling up (on-board computer)	284
Driving systems	304
Engine	300
General notes	284
Hiding (on-board computer)	284
KEYLESS-GO	317
Lights	297
Safety systems	285
SmartKey	317
Tires	312
Vehicle	315

Distance recorder

see Odometer

see Trip odometer

Distance warning (warning lamp)

- Distance warning function**
 - Activating/deactivating 275
 - Function/notes 70
 - Warning lamp 330
- DISTRONIC PLUS**
 - Activating 200
 - Activation conditions 200
 - Cruise control lever 200
 - Deactivating 204
 - Display message 309
 - Displays in the multifunction display 205
 - Driving tips 205
 - Function/notes 198
 - Important safety notes 199
 - Setting the specified minimum distance 203
 - Warning lamp 330
- Doors**
 - Automatic locking (on-board computer) 279
 - Automatic locking (switch) 88
 - Central locking/unlocking (SmartKey) 80
 - Control panel 42
 - Display message 316
 - Emergency locking 88
 - Emergency unlocking 88
 - Important safety notes 86
 - Opening (from inside) 87
 - Overview 86
 - Power closing feature 88
- Downhill speed regulation**
 - see DSR (Downhill Speed Regulation)
- Drinking and driving** 186
- Drive program**
 - Automatic 173
 - Display (DIRECT SELECT lever) 168
 - Manual 173
 - Manual (AMG vehicles) 174
 - Manual (vehicles with the ON&OFFROAD package) 174
 - Off-road program (vehicles with the ON&OFFROAD package) 251
 - SETUP (on-board computer) 281
 - see On-road programs
- Driver's door**
 - see Doors
- Driving abroad**
 - Mercedes-Benz Service 371
 - Symmetrical low beam 120
- Driving in mountainous terrain**
 - Approach/departure angle 194
- Driving lamps**
 - see Daytime running lamps
- Driving off-road**
 - see Off-road driving
- Driving safety systems**
 - ABS (Anti-lock Braking System) 68
 - ADAPTIVE BRAKE 75
 - Adaptive Brake Assist 71
 - BAS (Brake Assist System) 68
 - BAS PLUS (Brake Assist System PLUS) 69
 - COLLISION PREVENTION ASSIST 70
 - Distance warning function 70
 - EBD (electronic brake force distribution) 75
 - ESP® (Electronic Stability Program) 72
 - ETS/4ETS (Electronic Traction System) 72
 - Important safety information 67
 - Overview 67
 - PRE-SAFE® Brake 75
 - STEER CONTROL 77
- Driving systems**
 - 360° camera 229
 - Active Blind Spot Assist 241
 - Active Curve System 212
 - Active Driving Assistance package 241
 - Active Lane Keeping Assist 244
 - Active Parking Assist 220
 - ADS 212
 - AIRMATIC package 211
 - AMG adaptive sport suspension system 215
 - ATTENTION ASSIST 233
 - Blind Spot Assist 237
 - Cruise control 195
 - Display message 304
 - DISTRONIC PLUS 198

- | | |
|--|-----|
| HOLD function | 210 |
| Lane Keeping Assist | 239 |
| Level control (vehicles with AIR-MATIC package) | 213 |
| Level control (vehicles with the ON&OFFROAD package) | 206 |
| On-road programs | 247 |
| PARKTRONIC | 217 |
| Rear view camera | 224 |
| Driving tips | |
| Automatic transmission | 171 |
| Brakes | 188 |
| Break-in period | 156 |
| DISTRONIC PLUS | 205 |
| Downhill gradient | 188 |
| Drinking and driving | 186 |
| Driving abroad | 120 |
| Driving in winter | 190 |
| Driving on flooded roads | 190 |
| Driving on sand | 193 |
| Driving on wet roads | 190 |
| Driving over obstacles | 194 |
| Exhaust check | 186 |
| Fuel | 186 |
| General | 186 |
| Hydroplaning | 190 |
| Icy road surfaces | 190 |
| Limited braking efficiency on salted roads | 188 |
| Off-road driving | 192 |
| Off-road fording | 190 |
| Snow chains | 403 |
| Symmetrical low beam | 120 |
| Tire ruts | 194 |
| Towing a trailer | 257 |
| Traveling uphill | 194 |
| Wet road surface | 188 |
| DSR (Downhill Speed Regulation) | |
| Display message | 306 |
| Function/notes | 250 |
| DVD video | |
| Operating (on-board computer) | 273 |
| E | |
| EASY-ENTRY feature | |
| Activating/deactivating | 279 |
| Function/notes | 113 |
| EASY-EXIT feature | |
| Crash-responsive | 114 |
| Function/notes | 113 |
| Switching on/off | 279 |
| EASY-PACK load-securing kit | |
| Components and storage | 342 |
| EBD (electronic brake force distribution) | |
| Display message | 287 |
| Function/notes | 75 |
| ECO display | |
| Function/notes | 187 |
| On-board computer | 270 |
| ECO start/stop function (ML 250 BlueTEC 4MATIC) | |
| Automatic engine start | 165 |
| Automatic engine switch-off | 165 |
| General notes | 164 |
| Important safety notes | 164 |
| Introduction | 164 |
| Switching on/off | 165 |
| Electronic Stability Program | |
| see ESP [®] (Electronic Stability Program) | |
| Emergency | |
| Automatic measures after an accident | 60 |
| Emergency release | |
| Driver's door | 88 |
| Vehicle | 88 |
| Emergency spare wheel | |
| General notes | 441 |
| Important safety notes | 440 |
| Removing | 441 |
| Storage location | 441 |
| Technical data | 443 |
| Emergency Tensioning Devices | |
| Activation | 58 |
| Emergency unlocking | |
| Tailgate | 93 |
| Emissions control | |
| Service and warranty information | 25 |

- Engine**
- Check Engine warning lamp 327
 - Display message 300
 - ECO start/stop function 162
 - Engine number 447
 - Irregular running 167
 - Jump-starting 391
 - Starting problems 167
 - Starting the engine with the SmartKey 160
 - Starting with KEYLESS-GO 160
 - Switching off 183
 - Tow-starting (vehicle) 396
- Engine electronics**
- Problem (malfunction) 167
- Engine jump starting**
- see Jump starting (engine)
- Engine oil**
- Adding 368
 - Additives 453
 - Checking the oil level 367
 - Checking the oil level using the dipstick 367
 - Display message 302
 - Filling capacity 452
 - Notes about oil grades 452
 - Notes on oil level/consumption 367
 - Temperature (on-board computer) 281
 - Viscosity 453
- ESP® (Electronic Stability Program)**
- AMG menu (on-board computer) ... 281
 - Characteristics 73
 - Deactivating/activating 73
 - Display message 285
 - ETS/4ETS 72
 - Function/notes 72
 - General notes 72
 - Important safety information 73
 - Trailer stabilization 74
 - Warning lamp 323
- ETS/4ETS (Electronic Traction System)** 72
- Exhaust check** 186
- Exhaust pipe (cleaning instructions)** 376
- Exterior lighting**
- see Lights
- Exterior mirrors**
- Adjusting 114
 - Dipping (automatic) 115
 - Folding in/out (automatically) 115
 - Folding in/out (electrically) 115
 - Folding in when locking (on-board computer) 280
 - Out of position (troubleshooting) ... 115
 - Setting 115
 - Storing settings (memory function) 116
 - Storing the parking position 116
- Eyeglasses compartment** 336
- F**
- Filler cap**
- see Fuel filler flap
- Flat tire**
- MOExtended tires 383
 - Preparing the vehicle 383
 - TIREFIT kit 384
 - see Emergency spare wheel
- Floormats** 364
- Folding the rear bench seat forwards/back** 337
- Fording**
- Off-road 190
 - On flooded roads 190
- Fuel**
- Additives 449
 - Consumption statistics 269
 - Displaying the current consumption 270
 - Displaying the range 270
 - Driving tips 186
 - Flexible fuel vehicles 450
 - Fuel gauge 35
 - Grade (gasoline) 448
 - Important safety notes 448
 - Low outside temperatures 450
 - Premium-grade unleaded gasoline 448
 - Problem (malfunction) 180
 - Quality (diesel) 449

- Refueling 177
 Tank content/reserve fuel 448
- Fuel filler flap**
 Opening 179
- Fuel filter (display message)** 303
- Fuel level**
 Calling up the range (on-board computer) 270
- Fuel tank**
 Capacity 448
 Problem (malfunction) 180
- Fuses**
 Allocation chart 396
 Before changing 396
 Dashboard fuse box 397
 Fuse box in the engine compartment 397
 Fuse box under rear bench seat 398
 Important safety notes 396
- G**
- Garage door opener**
 Clearing the memory 363
 General notes 360
 Important safety notes 361
 Opening/closing the garage door .. 363
 Programming (button in the rear-view mirror) 361
- Gear indicator (on-board computer)** 281
- Genuine parts** 24
- Glove box** 335
- GTW (Gross Trailer Weight) (definition)** 421
- H**
- Handbrake**
 see Parking brake
- Hazard warning lamps** 124
- Headlamps**
 Cleaning system (function) 125
 Fogging up 127
 see Automatic headlamp mode
- Head restraints**
 Adjusting 106
 Adjusting (electrically) 107
- Adjusting (manually) 107
 Adjusting (rear) 108
 Installing/removing (rear) 108
 Luxury 107
- Heating**
 see Climate control
- High-beam headlamps**
 Adaptive Highbeam Assist 126
 Changing bulbs 131
 Display message 298
 Switching on/off 124
- Hill start assist** 161
- HOLD function**
 Deactivating 211
 Display message 307
 Function/notes 210
- Hood**
 Closing 367
 Display message 316
 Important safety notes 366
 Opening 366
- Horn** 34
- Hydroplaning** 190
- I**
- Ignition lock**
 see Key positions
- Immobilizer** 77
- Indicator lamps**
 see Warning and indicator lamps
- Indicators**
 see Turn signals
- Insect protection on the radiator** 367
- Instrument cluster**
 Overview 35
 Warning and indicator lamps 36
- Instrument cluster lighting** 266
- Interior lighting**
 Automatic control 128
 Delayed switch-off (on-board computer) 279
 Emergency lighting 129
 Manual control 128
 Overview 127
 Reading lamp 127

- Setting the brightness of the ambient lighting (on-board computer) 278
- Setting the color of the ambient lighting (on-board computer) 278

J**Jack**

- Storage location 382
- Using 425

Jump starting (engine) 391**K****KEYLESS-GO**

- Convenience closing feature 96
- Display message 317
- Locking 81
- Removing the Start/Stop button ... 159
- Start/Stop button 158
- Starting the engine 160
- Unlocking 81

Key positions

- KEYLESS-GO 158
- SmartKey 157

Kickdown

- Driving tips 171
- Manual drive program 175

Knee bag 52**L****Lamps**

- see Warning and indicator lamps

Lane detection (automatic)

- see Lane Keeping Assist

Lane Keeping Assist

- Activating/deactivating 276
- Display message 307
- Function/information 239
- see Active Lane Keeping Assist

Lap time (RACETIMER) 282**LATCH-type (ISOFIX) child seat****anchors 63****Level control (display message) 304****Level control (vehicles with AIR-MATIC package)**

- Basic settings 214
- Function/notes 213
- Important safety notes 213

Level control (vehicles with the ON&OFFROAD package)

- Basic settings 207
- Function/notes 206
- Important safety notes 206

License plate lamp (display message) 298**Light function, active**

- Display message 299

Lights

- Activating/deactivating the interior lighting delayed switch-off 279
- Active light function 125
- Adaptive Highbeam Assist 126
- Automatic headlamp mode 120
- Cornering light function 125
- Driving abroad 120
- Hazard warning lamps 124
- High beam flasher 124
- High-beam headlamps 124
- Light switch 120
- Low-beam headlamps 121
- Parking lamps 122
- Rear fog lamp 122
- Setting the brightness of the ambient lighting (on-board computer) 278
- Setting the color of the ambient lighting (on-board computer) 278
- Standing lamps 123
- Switching the daytime running lamps on/off (on-board computer) 277
- Switching the exterior lighting delayed switch-off on/off (on-board computer) 278
- Switching the surround lighting on/off (on-board computer) 278
- Turn signals 123
- see Interior lighting
- see Replacing bulbs

Light sensor (display message) 300

- Loading guidelines** 334
- Locking**
see Central locking
- Locking (doors)**
Automatic 88
Emergency locking 88
From inside (central locking button) 87
- Locking centrally**
see Central locking
- Locking verification signal (on-board computer)** 279
- Low-beam headlamps**
Changing bulbs 130
Display message 297
Setting for driving abroad (symmetrical) 120
Switching on/off 121
- LOW RANGE**
Display message 306
Off-road gear 253
- LOW RANGE off-road gear** 253
- Luggage holder (EASY-PACK load-securing kit)** 343
- Lumbar support**
Adjusting (on the seat) 108
- Luxury head restraints** 107
- M**
- M+S tires** 402
- Malfunction message**
see Display messages
- Matte finish (cleaning instructions)** 374
- mbrace**
Call priority 356
Display message 291
Downloading destinations (COMAND) 356
Downloading routes 359
Emergency call 353
General notes 352
Geo fencing 360
Locating a stolen vehicle 358
MB info call button 355
Remote vehicle locking 358
- Roadside Assistance button 354
Search & Send 357
Self-test 353
Speed alert 360
System 353
Triggering the vehicle alarm 360
Vehicle remote malfunction diagnosis 359
Vehicle remote unlocking 358
- Mechanical key**
Function/notes 82
Inserting 83
Locking vehicle 88
Removing 82
Unlocking the driver's door 88
- Media Interface**
see Separate operating instructions
- Memory card (audio)** 273
- Memory function** 116
- Message memory (on-board computer)** 284
- Mirrors**
see Exterior mirrors
see Rear-view mirror
see Vanity mirror (in the sun visor)
- Mobile phone**
Menu (on-board computer) 273
- Modifying the programming (SmartKey)** 81
- MOExtended tires** 383
- Mounting wheels**
Lowering the vehicle 428
Mounting a new wheel 427
Preparing the vehicle 424
Raising the vehicle 425
Removing a wheel 427
Securing the vehicle against rolling away 424
- MP3**
Operation 273
see separate operating instructions
- Multifunction display**
Function/notes 268
Permanent display 277
- Multifunction steering wheel**
Operating the on-board computer .. 267
Overview 37

N

Navigation

- Menu (on-board computer) 271
- see separate operating instructions

Night View Assist Plus

- Activating/deactivating 235
- Cleaning 377
- Problem (malfunction) 237

Notes on breaking-in a new vehicle

- 156

O

Occupant Classification System (OCS)

- Conditions 53
- Faults 57
- Operation 53
- System self-test 55

Occupant safety

- Automatic measures after an accident 60
- Children in the vehicle 61
- Important safety notes 45
- Pets in the vehicle 67
- PRE-SAFE® (anticipatory occupant protection) 60

OCS

- Conditions 53
- Faults 57
- Operation 53
- System self-test 55

Odometer 269**Off-road driving**

- Approach/departure angle 458
- Checklist after driving off-road 193
- Checklist before driving off-road 192
- Fording depth 457
- General information 192
- Important safety notes 191
- Maximum gradient climbing ability 458
- Traveling uphill 194

Off-road programs (vehicles with the ON&OFFROAD package)

- Displays in the COMAND display ... 255
- Function/notes 251

- Off-road program 1 252
- Off-road program 2 252

Off-road system

- 4MATIC 249
- DSR 250
- LOW RANGE off-road gear 253
- Off-road 4ETS 73
- Off-road ABS 68
- Off-road ESP® 74
- Off-road programs (vehicles with the ON&OFFROAD package) 251

Oil

- see Engine oil

On and Offroad menu (on-board computer) 281**On-board computer**

- AMG menu 281
- Assistance menu 275
- Audio menu 272
- Convenience submenu 279
- Displaying a service message 371
- Display messages 284
- DISTRONIC PLUS 205
- Factory settings submenu 281
- Important safety notes 266
- Instrument cluster submenu 277
- Lighting submenu 277
- Menu overview 269
- Message memory 284
- Navigation menu 271
- On and Offroad menu 281
- Operation 267
- RACETIMER 282
- Service menu 276
- Settings menu 277
- Standard display 269
- Telephone menu 273
- Trip menu 269
- Vehicle submenu 279
- Video DVD operation 273

On-road programs

- AUTO program 247
- Function/notes 247
- Snow program 248
- SPORT program 248
- Trailer program 249

Opening and closing the side trim panels	132
Operating safety	
Declaration of conformity	28
Important safety notes	27
Operating system	
see On-board computer	
Operator's Manual	
Vehicle equipment	25
Outside temperature display	267
Overhead control panel	41
Override feature	
Rear side windows	67
P	
Paint code number	446
Paintwork (cleaning instructions) ...	373
Panic alarm	44
Panorama roof with power tilt/sliding panel	
Important safety notes	97
Opening/closing	99
Opening/closing the roller sun-blind	100
Problem (malfunction)	101
Resetting	100
Parking	
Important safety notes	182
Parking brake	184
Position of exterior mirror, front-passenger side	116
Rear view camera	224
see PARKTRONIC	
Parking aid	
Active Parking Assist	220
see Exterior mirrors	
see PARKTRONIC	
Parking assistance	
see PARKTRONIC	
Parking brake	
Display message	288
Electric parking brake	184
Warning lamp	326
Parking lamps	
Switching on/off	122
Parking lamps (changing bulbs)	131

PARKTRONIC	
Deactivating/activating	219
Driving system	217
Function/notes	217
Important safety notes	217
Problem (malfunction)	220
Range of the sensors	217
Trailer towing	219
Warning display	218
PASSENGER AIR BAG OFF	
Indicator lamp	45
Problems (malfunction)	295
Pets in the vehicle	67
Plastic trim (cleaning instructions)	378
Power closing feature	88
Power washers	373
Power windows	
see Side windows	
PRE-SAFE® (anticipatory occupant protection)	
Display message	291
Operation	60
PRE-SAFE® Brake	
Activating/deactivating	276
Display message	293
Function/notes	75
Warning lamp	330
Program selector button	172
Protection of the environment	
General notes	24
Pulling away	
Trailer	161
Pulling away (automatic transmission)	160

Q

Qualified specialist workshop	29
--	----

R

RACETIMER (on-board computer)	282
Radar sensor system	
Activating/deactivating	279
Display message	307
Radiator cover	367

- Radio**
 - Selecting a station 272
 - see separate operating instructions
- Radio-controlled devices (installing)** 364
- Radio-wave reception/transmission in the vehicle**
 - Declaration of conformity 28
- Reading lamp** 127
- Rear compartment**
 - Setting the air vents 153
- Rear fog lamp**
 - Switching on/off 122
- Rear seats**
 - Adjusting 108
- Rear view camera**
 - Cleaning instructions 376
 - Function/notes 224
 - Switching on/off 225
- Rear-view mirror**
 - Anti-glare (manual) 114
 - Dipping (automatic) 115
- Rear window defroster**
 - Problem (malfunction) 151
 - Switching on/off 150
- Rear window wiper**
 - Replacing the wiper blade 134
 - Switching on/off 133
- Refrigerant (air-conditioning system)**
 - Important safety notes 455
- Refueling**
 - Fuel gauge 35
 - Important safety notes 177
 - Refueling process 178
 - see Fuel
- Remote control**
 - Programming (garage door opener) 361
- Replacing bulbs**
 - Important safety notes 129
 - Overview of bulb types 129
 - Removing/replacing the cover (front wheel arch) 130
- Reporting safety defects** 29
- Reserve (fuel tank)**
 - see Fuel
- Reserve fuel**
 - Display message 302
 - Warning lamp 327
 - see Fuel
- Residual heat (climate control)** 151
- Restraint system**
 - Display message 293
 - Introduction 44
 - Warning lamp 326
 - Warning lamp (function) 45
- Reversing feature**
 - Panorama sliding sunroof 98
 - Roller sunblinds 99
 - Side windows 94
 - Sliding sunroof 98
 - Tailgate 90
- Reversing lamps (display message)** 299
- Roadside Assistance (breakdown)** 26
- Roller sunblind**
 - Panorama roof with power tilt/sliding panel 99
 - Rear side windows 347
- Roof carrier** 345
- Roof lining and carpets (cleaning guidelines)** 379
- Roof load (maximum)** 456
- Route (navigation)**
 - see Route guidance (navigation)
- Route guidance (navigation)** 271

S

- Safety**
 - Children in the vehicle 61
 - Child restraint systems 62
 - Occupant Classification System (OCS) 53
- Safety system**
 - see Driving safety systems
- Seat belts**
 - Adjusting the driver's and front-passenger seat belt 49
 - Adjusting the height 48
 - Cleaning 379
 - Correct usage 47
 - Fastening 48

- Important safety guidelines 46
- Introduction 46
- Releasing 49
- Switching belt adjustment on/off
(on-board computer) 280
- Warning lamp 318
- Warning lamp (function) 49
- Seats**
- Adjusting (electrically) 106
- Adjusting the head restraint 106
- Cleaning the cover 378
- Correct driver's seat position 104
- Folding the rear bench seat for-
wards/back 337
- Important safety notes 105
- Overview 105
- Seat heating problem 110
- Seat ventilation problem 111
- Storing settings (memory func-
tion) 116
- Switching seat heating on/off 109
- Switching seat ventilation on/off .. 110
- Securing hooks** 340
- Selector lever**
- Cleaning 378
- Sensors (cleaning instructions)** 375
- Service menu (on-board com-
puter)** 276
- Service products**
- Brake fluid 453
- Coolant (engine) 453
- DEF special additives 451
- Engine oil 452
- Fuel 448
- Important safety notes 447
- Refrigerant (air-conditioning sys-
tem) 455
- Washer fluid 454
- Settings**
- Factory (on-board computer) 281
- On-board computer 277
- Setting the air distribution** 148
- Setting the airflow** 148
- SETUP (on-board computer)** 281
- Side impact air bag** 52
- Side marker lamp (display mes-
sage)** 299
- Side marker lamps (changing
bulbs)** 131
- Side windows**
- Cleaning 375
- Convenience closing feature 95
- Convenience opening feature 95
- Important safety information 93
- Opening/closing 94
- Overview 93
- Problem (malfunction) 97
- Resetting 96
- Sliding sunroof**
- Important safety notes 97
- Opening/closing 98
- Problem (malfunction) 101
- Resetting 98
- see Panorama roof with power
tilt/sliding panel
- SmartKey**
- Changing the battery 83
- Changing the programming 81
- Checking the battery 83
- Convenience closing feature 95
- Convenience opening feature 95
- Display message 317
- Door central locking/unlocking 80
- Important safety notes 80
- Loss 85
- Mechanical key 82
- Overview 80
- Positions (ignition lock) 157
- Problem (malfunction) 85
- Starting the engine 160
- Snow chains**
- Information 403
- Snow drive program 248
- Sockets**
- Center console 349
- General notes 349
- Luggage compartment 350
- Rear compartment 350
- Specialist workshop** 29
- Special seat belt retractor** 61
- Speed, controlling**
- see Cruise control
- Speedometer**
- Digital 270

- In the Instrument cluster 35
 - Segments 267
 - Selecting the unit of measurement 277
 - see Instrument cluster
 - Standing lamps**
 - Changing bulbs 131
 - Display message 299
 - Switching on/off 123
 - Start/stop function**
 - see ECO start/stop function
 - Starting (engine)** 159
 - STEER CONTROL** 77
 - Steering (display message)** 316
 - Steering wheel**
 - Adjusting (electrically) 112
 - Adjusting (manually) 111
 - Button overview 37
 - Buttons (on-board computer) 267
 - Cleaning 378
 - Important safety notes 111
 - Paddle shifters 172
 - Steering wheel heating 112
 - Storing settings (memory function) 116
 - Steering wheel heating**
 - Problem (malfunction) 113
 - Switching on/off 112
 - Steering wheel paddle shifters** 172
 - Stopwatch (RACETIMER)** 282
 - Stowage areas** 334
 - Stowage compartments**
 - Armrest (under) 336
 - Center console 336
 - Center console (rear) 336
 - Cup holders 345
 - Eyeglasses compartment 336
 - Glove box 335
 - Important safety information 335
 - Stowage net 337
 - Stowage net** 337
 - Summer tires** 402
 - Sun visor** 347
 - Surround lighting (on-board computer)** 278
 - Suspension tuning**
 - AMG adaptive sport suspension system 216
 - SETUP (on-board computer) 281
 - SUV**
 - (Sport Utility Vehicle) 27
 - Switching air-recirculation mode on/off** 151
- T
- Tachometer** 267
 - Tailgate**
 - Display message 316
 - Emergency unlocking 93
 - Important safety notes 89
 - Limiting the opening angle 93
 - Opening/closing (automatically from inside) 92
 - Opening/closing (automatically from outside) 91
 - Opening/closing (from outside) 90
 - Opening dimensions 456
 - Power closing 88
 - Tail lamps**
 - Display message 298
 - Tank**
 - see Fuel tank
 - Tank content**
 - Fuel gauge 35
 - Technical data**
 - Capacities 447
 - Emergency spare wheel 443
 - Information 446
 - Tires/wheels 428
 - Trailer loads 460
 - Vehicle data 456
 - TELEAID**
 - Call priority 356
 - Downloading destinations (COMAND) 356
 - Downloading routes 359
 - Emergency call 353
 - General notes 352
 - Geo fencing 360
 - Locating a stolen vehicle 358
 - MB info call button 355
 - Remote vehicle locking 358

- Roadside Assistance button 354
- Search & Send 357
- Self-test 353
- Speed alert 360
- System 353
- Triggering the vehicle alarm 360
- Vehicle remote malfunction diagnosis 359
- Vehicle remote unlocking 358
- Telephone**
- Accepting a call 274
- Display message 316
- Menu (on-board computer) 273
- Number from the phone book 274
- Redialing 274
- Rejecting/ending a call 274
- Telescopic rod (EASY-PACK load-securing kit)** 343
- Temperature**
- Coolant 266
- Coolant (on-board computer) 281
- Engine oil (on-board computer) 281
- Outside temperature 267
- Setting (climate control) 147
- Theft deterrent systems**
- ATA (Anti-Theft Alarm system) 77
- Immobilizer 77
- Through-loading** 337
- Time**
- see separate operating instructions
- Timing (RACETIMER)** 282
- TIREFIT kit** 384
- Tire pressure**
- Calling up (on-board computer) 408
- Checking manually 407
- Display message 312
- Important safety notes 408
- Maximum 406
- Notes 405
- Not reached (TIREFIT) 386
- Reached (TIREFIT) 386
- Recommended 404
- Tire pressure loss warning system**
- General notes 407
- Important safety notes 407
- Restarting 408
- Tire pressure monitor**
- Checking the tire pressure electronically 410
- Function/notes 408
- General notes 408
- Important safety notes 409
- Radio type approval for the tire pressure monitor 411
- Restarting 411
- Warning lamp 331
- Warning message 410
- Tires**
- Aspect ratio (definition) 422
- Average weight of the vehicle occupants (definition) 421
- Bar (definition) 420
- Changing a wheel 423
- Characteristics 420
- Checking 401
- Curb weight (definition) 422
- Definition of terms 420
- Direction of rotation 423
- Display message 312
- Distribution of the vehicle occupants (definition) 423
- DOT, Tire Identification Number (TIN) 420
- DOT (Department of Transportation) (definition) 421
- GAWR (Gross Axle Weight Rating) (definition) 421
- GTW (Gross Trailer Weight) (definition) 421
- GVW (Gross Vehicle Weight) (definition) 421
- GVWR (Gross Vehicle Weight Rating) (definition) 421
- Important safety notes 400
- Increased vehicle weight due to optional equipment (definition) 421
- Kilopascal (kPa) (definition) 421
- Labeling (overview) 417
- Load bearing index (definition) 422
- Load index 419
- Load index (definition) 421
- M+S tires 402
- Maximum loaded vehicle weight (definition) 421

- Maximum load on a tire (definition) 422
- Maximum permissible tire pressure (definition) 422
- Maximum tire load 419
- Maximum tire load (definition) 422
- MOExtended tires 402
- Optional equipment weight (definition) 422
- PSI (pounds per square inch) (definition) 422
- Replacing 423
- Service life 402
- Sidewall (definition) 422
- Speed rating (definition) 421
- Storing 424
- Structure and characteristics (definition) 420
- Temperature 416
- TIN (Tire Identification Number) (definition) 422
- Tire bead (definition) 422
- Tire pressure (definition) 422
- Tire pressures (recommended) 421
- Tire size (data) 428
- Tire size designation, load-bearing capacity, speed rating 417
- Tire tread 401
- Tire tread (definition) 422
- Total load limit (definition) 423
- Traction 416
- Traction (definition) 422
- Tread wear 416
- TWR (permissible trailer drawbar noseweight) (definition) 422
- Uniform Tire Quality Grading Standards 415
- Uniform Tire Quality Grading Standards (definition) 421
- Wear indicator (definition) 423
- Wheel and tire combination 430
- Wheel rim (definition) 421
- see Flat tire
- Top Tether** 64
- Towing a trailer**
 - Active Parking Assist 224
 - Axle load, permissible 460
 - Cleaning the trailer tow hitch 376
 - Coupling up a trailer 259
 - Decoupling a trailer 261
 - Driving tips 257
 - ESP® (Electronic Stability Program) 74
 - Important safety notes 256
 - Installing the ball coupling 258
 - Mounting dimensions 459
 - Power supply 263
 - Pulling away with a trailer 161
 - Removing the ball coupling 262
 - Storing the ball coupling 262
 - Trailer drive program 249
 - Trailer loads 460
- Towing away**
 - Important safety guidelines 393
 - Installing the towing eye 394
 - Removing the towing eye 395
 - With both axles on the ground 395
 - With the rear axle raised 395
- Tow-starting**
 - Emergency engine starting 396
 - Important safety notes 393
- Trailer coupling**
 - see Towing a trailer
- Trailer loads and drawbar noseweights** 262
- Trailer towing**
 - Active Blind Spot Assist 244
 - Active Lane Keeping Assist 247
 - Blind Spot Assist 239
 - PARKTRONIC 219
 - Permissible trailer loads and drawbar noseweights 262
- Transfer case** 177
- Transmission**
 - see Automatic transmission
- Transmission position display** 168
- Transmission position display (DIRECT SELECT lever)** 168
- Transporting the vehicle** 395
- Traveling uphill**
 - Brow of hill 195
 - Driving downhill 195
 - Maximum gradient-climbing capability 195

- Trim pieces (cleaning instructions)** 378
- Trip computer (on-board computer)** 269
- Trip odometer**
 Calling up 269
 Resetting (on-board computer) 270
- Trunk**
 see Tailgate
- Turn signals**
 Display message 297
 Switching on/off 123
- TWR (Tongue Weight Rating) (definition)** 422
- Type identification plate**
 see Vehicle identification plate
- U**
- Unlocking**
 Emergency unlocking 88
 From inside the vehicle (central unlocking button) 87
- V**
- Vanity mirror (in the sun visor)** 347
- Vehicle**
 Correct use 29
 Data acquisition 30
 Display message 315
 Equipment 25
 Individual settings 277
 Limited Warranty 30
 Loading 412
 Locking (in an emergency) 88
 Locking (SmartKey) 80
 Lowering 428
 Maintenance 26
 Parking for a long period 185
 Pulling away 160
 Raising 425
 Reporting problems 29
 Securing from rolling away 424
 Towing away 393
 Transporting 395
 Unlocking (in an emergency) 88
 Unlocking (SmartKey) 80
 Vehicle data 456
- Vehicle battery**
 see Battery (vehicle)
- Vehicle data** 456
- Vehicle data (off-road driving)**
 Approach/departure angle 458
 Forging depth 457
 Maximum gradient climbing ability 458
- Vehicle dimensions** 456
- Vehicle emergency locking** 88
- Vehicle identification number**
 see VIN
- Vehicle identification plate** 446
- Vehicle level**
 AMG adaptive sport suspension system 216
- Vehicle level (display message)** 304
- Vehicle maintenance**
 see ASSYST PLUS
- Vehicle tool kit** 382
- Video**
 Operating the DVD 273
- VIN** 446
- W**
- Warning and indicator lamps**
 ABS 321
 Brakes 320
 Check Engine 327
 Coolant 328
 Distance warning 330
 DISTRONIC PLUS 330
 ESP® 323
 ESP® OFF 324
 Overview 36
 PASSENGER AIR BAG OFF 45
 Reserve fuel 327
 Restraint system 326
 Seat belt 318
 Tire pressure monitor 331
- Warranty** 25
- Washer fluid**
 Display message 316

- Wheel and tire combination**
 - see Tires
 - Wheel bolt tightening torque** 428
 - Wheel check** 424
 - Wheels**
 - Changing a wheel 423
 - Checking 401
 - Cleaning 374
 - Cleaning (warning) 424
 - Emergency spare wheel 440
 - Important safety notes 400
 - Interchanging/changing 423
 - Mounting a new wheel 427
 - Mounting a wheel 424
 - Overview 400
 - Removing a wheel 427
 - Storing 424
 - Tightening torque 428
 - Wheel size/tire size 428
 - Window curtain air bag**
 - Display message 294
 - Operation 52
 - Windows**
 - see Side windows
 - Windshield**
 - Defrosting 149
 - Infrared reflective 364
 - Windshield washer fluid**
 - see Windshield washer system
 - Windshield washer system**
 - Adding washer fluid 370
 - Notes 454
 - Windshield wipers**
 - Problem (malfunction) 136
 - Rear window wiper 133
 - Replacing the wiper blades 133
 - Switching on/off 132
 - Winter driving**
 - Slippery road surfaces 190
 - Snow chains 403
 - Winter operation**
 - General notes 402
 - Overview 402
 - Radiator cover 367
 - Snow drive program 248
 - Winter tires**
 - M+S tires 402
 - Wiper blades**
 - Cleaning 375
 - Important safety notes 133
 - Replacing 133
 - Replacing (rear window) 134
 - Replacing (windshield) 134
 - Wooden trim (cleaning instructions)** 378
 - Workshop**
 - see Qualified specialist workshop
- Z**
- ZONE function**
 - Switching on/off 149

Protection of the environment

General notes

Environmental note

Daimler's declared policy is one of comprehensive environmental protection.

The objectives are for the natural resources that form the basis of our existence on this planet to be used sparingly and in a manner that takes the requirements of both nature and humanity into account.

You too can help to protect the environment by operating your vehicle in an environmentally responsible manner.

Fuel consumption and the rate of engine, transmission, brake and tire wear are affected by these factors:

- operating conditions of your vehicle
- your personal driving style

You can influence both factors. You should bear the following in mind:

Operating conditions:

- avoid short trips as these increase fuel consumption.
- always make sure that the tire pressures are correct.
- do not carry any unnecessary weight.
- remove roof racks once you no longer need them.
- a regularly serviced vehicle will contribute to environmental protection. You should therefore adhere to the service intervals.
- always have service work carried out at a qualified specialist workshop.

Personal driving style:

- do not depress the accelerator pedal when starting the engine.
- do not warm up the engine when the vehicle is stationary.
- drive carefully and maintain a safe distance from the vehicle in front.
- avoid frequent, sudden acceleration and braking.

- change gear in good time and use each gear only up to $\frac{2}{3}$ of its maximum engine speed.
- switch off the engine in stationary traffic.
- keep an eye on the vehicle's fuel consumption.

Environmental concerns and recommendations

Wherever the operating instructions require you to dispose of materials, first try to regenerate or re-use them. Observe the relevant environmental rules and regulations when disposing of materials. In this way you will help to protect the environment.

Genuine Mercedes-Benz parts

Environmental note

Daimler AG also supplies reconditioned major assemblies and parts which are of the same quality as new parts. They are covered by the same Limited Warranty entitlements as new parts.

! Air bags and Emergency Tensioning Devices, as well as control units and sensors for these restraint systems, may be installed in the following areas of your vehicle:

- doors
- door pillars
- door sills
- seats
- cockpit
- instrument cluster
- center console

Do not install accessories such as audio systems in these areas. Do not carry out repairs or welding. You could impair the operating efficiency of the restraint systems.

Have aftermarket accessories installed at a qualified specialist workshop.

You could jeopardize the operating safety of your vehicle if you use parts, tires and wheels as well as accessories relevant to safety which have not been approved by Mercedes. This could lead to malfunctions in safety-relevant systems, e.g. the brake system. Use only genuine Mercedes-Benz parts or parts of equal quality. Only use tires, wheels and accessories that have been specifically approved for your vehicle.

Genuine Mercedes-Benz parts are subject to strict quality control. Every part has been specifically developed, manufactured or selected for and adapted to Mercedes-Benz vehicles. Only genuine Mercedes-Benz parts should therefore be used.

More than 300,000 different genuine Mercedes-Benz parts are available for Mercedes-Benz models.

All authorized Mercedes-Benz Centers maintain a supply of genuine Mercedes-Benz parts for necessary service and repair work. In addition, strategically located parts delivery centers provide quick and reliable parts service.

Always specify the vehicle identification number (VIN) when ordering genuine Mercedes-Benz parts (> page 446).

Operator's Manual

Vehicle equipment

This Operator's Manual describes all models and all standard and optional equipment of your vehicle available at the time of going to print. Country-specific differences are possible. Bear in mind that your vehicle may not feature all functions described here. This also applies to safety-relevant systems and functions. The equipment in your vehicle may therefore differ from that shown in the descriptions and illustrations.

The original purchase agreement lists all systems installed in your vehicle.

Should you have any questions concerning equipment and operation, please consult an authorized Mercedes-Benz Center.

The Operator's Manual and Maintenance Booklet are important documents and should be kept in the vehicle.

Service and vehicle operation

Warranty

The implied warranty for your vehicle applies in accordance with the warranty terms and conditions in the Service and Warranty Information booklet.

Your authorized Mercedes-Benz Center will replace and repair all factory-installed parts in accordance with the following warranty terms and conditions:

- New Vehicle Limited Warranty
- Emission System Warranty
- Emission Performance Warranty
- California, Connecticut, Maine, Massachusetts, New York, Pennsylvania, Rhode Island and Vermont Emission Control System Warranty
- State warranty enforcement laws (lemon laws)

Replacement parts and accessories are covered by the Mercedes-Benz Parts and Accessories warranties. These are available at any authorized Mercedes-Benz Center.

- i** Should you lose your Service and Warranty Information booklet, have an authorized Mercedes-Benz Center arrange for a replacement. The new Service and Warranty Information booklet will be posted to you.

Information for customers in California

Under California law you may be entitled to a replacement of your vehicle or a refund of the purchase price or lease price, if after a reasonable number of repair attempts Mercedes-Benz USA, LLC and/or its authorized repair or service facilities fail to fix one or more substantial defects or malfunctions in the vehicle that are covered by its express warranty. During the period of 18 months from original delivery of the vehicle or the accumulation of 18,000 miles (approximately 29,000 km) on the odometer of the vehicle, whichever occurs first, a reasonable number of repair attempts is presumed for a retail buyer or lessee if one or more of the following occurs:

- (1) the same substantial defect or malfunction results in a condition that is likely to cause death or serious bodily injury if the vehicle is driven, that defect or malfunction has been subject to repair two or more times, and you have directly notified Mercedes-Benz USA, LLC in writing of the need for its repair,
- (2) the same substantial defect or malfunction of a less serious nature than category (1) has been subject to repair four or more times and you have directly notified us in writing of the need for its repair, or
- (3) the vehicle is out of service by reason of repair of the same or different substantial defects or malfunctions for a cumulative total of more than 30 calendar days.

Please send your written notice to:
 Mercedes-Benz USA, LLC
 Customer Assistance Center
 One Mercedes Drive
 Montvale, NJ 07645-0350

Maintenance

The Service and Warranty Booklet describes all the necessary maintenance work which should be done at regular intervals.

Always have the Service and Warranty Booklet with you when you bring the vehicle to an authorized Mercedes-Benz Center. The service advisor will record every service for you in the Service and Warranty Booklet.

Roadside Assistance

The Mercedes-Benz Roadside Assistance Program offers technical help in the event of a breakdown. Calls to the toll-free Roadside Assistance Hotline are answered by our agents 24 hours a day, 365 days a year.

1-800-FOR-MERCedes(1-800-367-6372) (USA)

1-800-387-0100 (Canada)

For additional information, refer to the Mercedes-Benz Roadside Assistance Program brochure (USA) or the "Roadside Assistance" section in the Service and Warranty booklet (Canada). You will find both in your vehicle literature portfolio.

Change of address or change of ownership

In the event of a change of address, please send us the "Notification of Address Change" in the Service and Guarantee booklet or simply call the Mercedes-Benz Customer Assistance Center (USA) at the hotline number 1-800-FOR-MERCedes(1-800-367-6372) or Customer Service Center (Canada) at 1-800-387-0100. This will assist us in contacting you in a timely manner should the need arise.

If you sell your Mercedes, please leave the entire literature in the vehicle so that it is available to the next owner.

If you have purchased a used car, please send us the "Notification of Used Car Purchase" in

the Service and Guarantee booklet or simply call the Mercedes-Benz Customer Assistance Center (USA) at the hotline number 1-800-FOR-MERCEDES(1-800-367-6372) or Customer Service (Canada) at 1-800-387-0100.

Vehicle operation outside the USA and Canada

If you plan to operate your vehicle in foreign countries, please be aware that:

- service facilities or replacement parts may not be readily available.
- unleaded fuel for vehicles with a catalytic converter may not be available. Leaded fuel may cause damage to the catalytic converter.
- the fuel may have a considerably lower octane rating. Unsuitable fuel can cause engine damage.

Some Mercedes-Benz models are available for delivery in Europe through our European Delivery Program. For details, consult an authorized Mercedes-Benz Center or write to one of the following addresses.

In the USA

Mercedes-Benz USA, LLC
European Delivery Department
One Mercedes Drive
Montvale, NJ 07645-0350

In Canada

Mercedes-Benz Canada, Inc.
European Delivery Department
98 Vanderhoof Avenue
Toronto, Ontario M4G 4C9

Sports Utility Vehicle

WARNING

Due to the high center of gravity, the vehicle may start to skid and roll over in the event of an abrupt steering maneuver and/or when

the vehicle's speed is not adapted to the road conditions. There is a risk of an accident.

Always adapt your speed and driving style to the vehicle's driving characteristics and to the prevailing road and weather conditions.

Utility vehicles have a significantly higher roll-over rate than other types of vehicles.

Failure to operate this vehicle safely may result in an accident, rollover of the vehicle, and severe or fatal injury.

In a rollover crash, an unbelted person is significantly more likely to die than a person wearing a seat belt.

You and all vehicle occupants should always wear your seat belts.

Operating safety

Important safety notes

WARNING

If you do not have the prescribed service/maintenance work or any required repairs carried out, this can result in malfunctions or system failures. There is a risk of an accident. Always have the prescribed service/maintenance work as well as any required repairs carried out at a qualified specialist workshop.

WARNING

If you switch off the ignition while driving, safety-relevant functions are only available with limitations, or not at all. This could affect, for example, the power steering and the brake boosting effect. You will require considerably more effort to steer and brake. There is a risk of an accident.

Do not switch off the ignition while driving.

WARNING

Flammable material such as leaves, grass or twigs may ignite if they come into contact with hot parts of the exhaust system. There is a risk of fire.

When driving off road or on unpaved roads, check the vehicle's underside regularly. In particular, remove parts of plants or other flammable materials which have become trapped. In the case of damage, contact a qualified specialist workshop.

WARNING

Modifications to electronic components, their software as well as wiring can impair their function and/or the function of other networked components. In particular, systems relevant to safety could also be affected. As a result, these may no longer function as intended and/or jeopardize the operating safety of the vehicle. There is an increased risk of an accident and injury.

Never tamper with the wiring as well as electronic components or their software. You should have all work to electrical and electronic equipment carried out at a qualified specialist workshop.

If you make any changes to the vehicle electronics, the general operating permit is rendered invalid.

! There is a risk of damage to the vehicle if:

- the vehicle becomes stuck, e.g. on a high curb or an unpaved road
- you drive too fast over an obstacle, e.g. a curb or a hole in the road
- a heavy object strikes the undercarriage or parts of the chassis

In situations like this, the body, the undercarriage, chassis parts, wheels or tires could be damaged without the damage being visible. Components damaged in this way can unexpectedly fail or, in the case of an accident, no longer withstand the strain they are designed to.

If the underbody paneling is damaged, combustible materials such as leaves, grass or twigs can gather between the underbody and the underbody paneling. If these materials come in contact with hot

parts of the exhaust system, they can catch fire.

In such situations, have the vehicle checked and repaired immediately at a qualified specialist workshop. If on continuing your journey you notice that driving safety is impaired, pull over and stop the vehicle immediately, paying attention to road and traffic conditions. In such cases, visit a qualified specialist workshop.

Declarations of conformity

Vehicle components which receive and/or transmit radio waves

USA: "The wireless devices of this vehicle comply with Part 15 of the FCC Rules. Operation is subject to the following two conditions: 1) These devices may not cause harmful interference, and 2) These devices must accept any interference received, including interference that may cause undesired operation. Changes or modifications not expressly approved by the party responsible for compliance could void the user's authority to operate the equipment."

Canada: "The wireless devices of this vehicle comply with Industry Canada license-exempt RSS standard(s). Operation is subject to the following two conditions: (1) These devices may not cause interference, and (2) These devices must accept any interference, including interference that may cause undesired operation of the device."

Diagnostics connection

The diagnostics connection is only intended for the connection of diagnostic equipment at a qualified specialist workshop.

WARNING

If you connect equipment to the diagnostics connection in the vehicle, it may affect the operation of the vehicle systems. As a result,

the operating safety of the vehicle could be affected. There is a risk of an accident.

Do not connect any equipment to a diagnostics connection in the vehicle.

WARNING

Objects in the driver's footwell can restrict the pedal travel or obstruct a depressed pedal. The operating and road safety of the vehicle is jeopardized. There is a risk of an accident.

Make sure that all objects in the vehicle are stowed correctly, and that they cannot enter the driver's footwell. Install the floor mats securely and as specified in order to ensure sufficient clearance for the pedals. Do not use loose floor mats and do not place floor mats on top of one another.

! If the engine is switched off and equipment on the diagnostics connection is used, the starter battery may discharge.

Connecting equipment to the diagnostics connection can lead to emissions monitoring information being reset, for example. This may lead to the vehicle failing to meet the requirements of the next emissions test during the main inspection.

Qualified specialist workshop

An authorized Mercedes-Benz Center is a qualified specialist workshop. It has the necessary specialist knowledge, tools and qualifications to correctly carry out the work required on your vehicle. This is especially the case for work relevant to safety.

Observe the notes in the Maintenance Booklet.

Always have the following work carried out at an authorized Mercedes-Benz Center:

- work relevant to safety
- service and maintenance work
- repair work

- alterations, installation work and modifications
- work on electronic components

Correct use

If you remove any warning stickers, you or others could fail to recognize certain dangers. Leave warning stickers in position.

Observe the following information when driving your vehicle:

- the safety notes in this manual
- the Technical Data section in this manual
- traffic rules and regulations
- laws and safety standards pertaining to motor vehicles

Problems with your vehicle

If you should experience a problem with your vehicle, particularly one that you believe may affect its safe operation, we urge you to contact an authorized Mercedes-Benz Center immediately to have the problem diagnosed and rectified. If the problem is not resolved to your satisfaction, please discuss the problem again with a Mercedes-Benz Center or contact us at one of the following addresses.

In the USA

Customer Assistance Center
Mercedes-Benz USA, LLC
One Mercedes Drive
Montvale, NJ 07645-0350

In Canada

Customer Relations Department
Mercedes-Benz Canada, Inc.
98 Vanderhoof Avenue
Toronto, Ontario M4G 4C9

Reporting safety defects

USA only:

The following text is published as required of manufacturers under Title 49, Code of U.S. Federal Regulations, Part 575 pursuant to the "National Traffic and Motor Vehicle Safety Act of 1966".

If you believe that your vehicle has a defect which could cause a crash or could cause injury or death, you should immediately inform the National Highway Traffic Safety Administration (NHTSA) in addition to notifying Mercedes-Benz USA, LLC.

If NHTSA receives similar complaints, it may open an investigation, and if it finds that a safety defect exists in a group of vehicles, it may order a recall and remedy campaign. However, NHTSA cannot become involved in individual problems between you, your dealer, or Mercedes-Benz USA, LLC.

To contact NHTSA, you may call the Vehicle Safety Hotline toll-free at 1-888-327-4236 (TTY: 1-800-424-9153); go to <http://www.safercar.gov>; or write to: Administrator, NHTSA, 400 Seventh Street, SW., Washington, DC 20590.

You can also obtain other information about motor vehicle safety from

<http://www.safercar.gov>

Limited Warranty

! Follow the instructions in this manual about the proper operation of your vehicle as well as about possible vehicle damage. Damage to your vehicle that arises from culpable contraventions against these instructions is not covered either by the Mercedes-Benz Limited Warranty or by the New or Used-Vehicle Warranty.

Data stored in the vehicle

Data recording

This vehicle is capable of recording diagnostic information relating to vehicle operation, malfunctions, and user settings. This may include

information about the performance or status of various systems, including but not limited to, engine, throttle, steering or brake systems, that is stored and can be read out with suitable devices, particularly when the vehicle is serviced. The data obtained is used to properly diagnose and service your vehicle or to further optimize and develop vehicle functions.

COMAND/mbrace (Canada: TELEAID)

If the vehicle is equipped with COMAND or mbrace, additional data about the vehicle's operation, the use of the vehicle in certain situations, and the location of the vehicle may be compiled through COMAND or the mbrace system.

For additional information please refer to the COMAND User Manual and/or the mbrace Terms and Conditions.

Event data recorders

This vehicle is equipped with an event data recorder (EDR). The main purpose of an EDR is to record data that will assist in understanding how a vehicle's systems performed in certain crash or near crash-like situations, such as during air bag deployment or when hitting a road obstacle. The EDR is designed to record data related to vehicle dynamics and safety systems for a short period of time, typically 30 seconds or less.

The EDR in this vehicle is designed to record such data as:

- how various systems in your vehicle are operating
- whether or not the driver and passenger seat belts are fastened
- how far (if at all) the driver is depressing the accelerator and/or brake pedal and
- how fast the vehicle is traveling

This data can help provide a better understanding of the circumstances in which

crashes and injuries occur. NOTE: EDR data is recorded by your vehicle only if a non-trivial crash situation occurs; no data is recorded by the EDR under normal driving conditions and no personal data (e.g., name, gender, age, and crash location) are recorded. However, other parties, such as law enforcement, can combine the EDR data with the type of personal identification data routinely acquired during a crash investigation.

Access to the vehicle and/or the EDR is needed to read data that is recorded by an EDR, and special equipment is required. In addition to the vehicle manufacturer, other parties that have the special equipment, such as law enforcement, can read the information by accessing the vehicle or the EDR.

EDR data may be used in civil and criminal matters as a tool in accident reconstruction, accident claims, and vehicle safety. Since the Crash Data Retrieval CDR tool that is used to extract data from the EDR is commercially available, Mercedes-Benz USA, LLC ("MBUSA") expressly disclaims any and all liability arising from the extraction of this information by unauthorized Mercedes-Benz personnel.

MBUSA will not share EDR data with others without the consent of the vehicle owners or, if the vehicle is leased, without the consent of the lessee. Exceptions to this representation include responses to subpoenas by law enforcement; by federal, state or local government; in connection with or arising out of litigation involving MBUSA or its subsidiaries and affiliates; or, as required by law.

Warning: The EDR is a component of the Supplemental Restraint System ("SRS") Module. Tampering with, altering, modifying or removing the EDR component may result in a malfunction of the SRS Module and other systems.

State laws or regulations regarding EDRs that conflict with federal regulation are pre-empted. This means that in the event of such conflict, the federal regulation governs. As of

February 2013, 13 states have enacted laws relating to EDRs.

Information on copyright

General information

Information on license for free and open-source software used in your vehicle and its electronic components is available on the following website:

<http://www.mercedes-benz.com/opensource>

Cockpit	34
Instrument cluster	35
Multifunction steering wheel	37
Center console	38
Overhead control panel	41
Door control panel	42

Cockpit

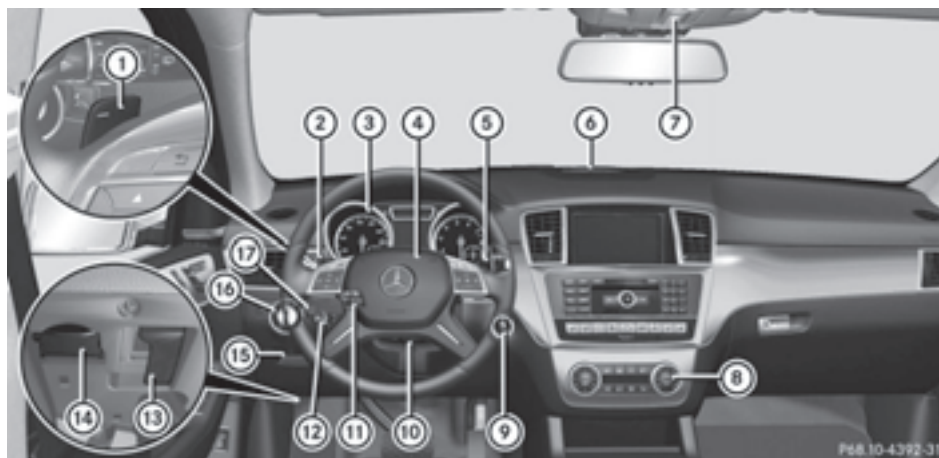

	Function	Page
①	Steering wheel paddle shifters	172
②	Combination switch	123
③	Instrument cluster	35
④	Horn	
⑤	DIRECT SELECT lever	168
⑥	PARKTRONIC warning display	217
⑦	Overhead control panel	41
⑧	Climate control systems	138
⑨	Ignition lock	157
	Start/Stop button	158

	Function	Page
⑩	Adjusts the steering wheel manually	111
⑪	Adjusts the steering wheel electrically	111
	Steering wheel heating	112
⑫	Cruise control lever	196
⑬	Opens the hood	366
⑭	Diagnostics connection	28
⑮	Electric parking brake	184
⑯	Light switch	120
⑰	Night View Assist Plus	235

Instrument cluster

Displays and controls



P54.32-9642-31

	Function	Page
①	Speedometer with segments	267
②	Fuel gage	
③	Tachometer	267

	Function	Page
④	Coolant temperature	266
⑤	Multifunction display	268
⑥	Instrument cluster lighting	266

Warning and indicator lamps



P54.32-9646-31







	Function	Page
①	Low-beam head-lamps	121
②	Parking lamps	122
③	ESP®	323
④	High-beam head-lamps	124
⑤	Electric parking brake (red) (USA only) (Canada only)	326
⑥	Electric parking brake (yellow)	326
⑦	Distance warning	330
⑧	Turn signals	123
⑨	Tire pressure monitor	331







	Function	Page
⑩	Restraint system	44
⑪	Seat belt	318
⑫	Diesel engine: pre-glow	160
⑬	Coolant	328
⑭	Rear fog lamp	122
⑮	Check Engine	327
⑯	Reserve fuel	327
⑰	ESP® OFF	323
⑱	ABS	321
⑲	Brakes (USA only) (Canada only)	320

Multifunction steering wheel



At a glance





	Function	Page
①	Multifunction display	268
②	COMAND display; see the separate operating instructions	
③	 Switches on the Voice Control System; see the separate operating instructions	
④	 Rejects or ends a call Exits phone book/redial memory  Makes or accepts a call Switches to the redial memory   Adjusts the volume  Mute	273



	Function	Page
⑤	  Selects a menu   Selects a submenu or scrolls through lists  To confirm your selection Hiding display messages	267 267 284
⑥	 Back Switches off the Voice Control System; see the separate operating instructions	267

Center console

Center console, upper section





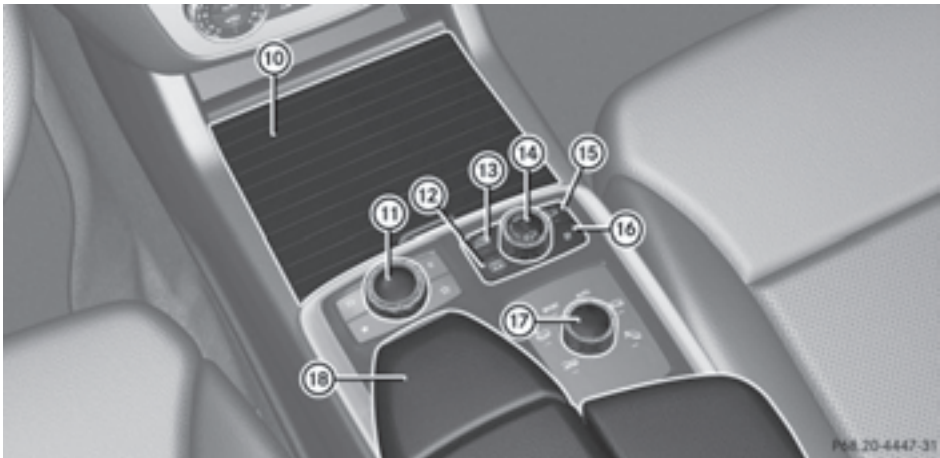

	Function	Page
①	COMAND; see the separate operating instructions	
②	 Seat heating	109
③	 Seat ventilation	110
④	 PARKTRONIC	217
⑤	 ECO start/stop function	162

	Function	Page
⑥	 Hazard warning lamps	124
⑦	 PASSENGER AIR BAG OFF indicator lamp	45
⑧	 ESP®	73

Center console, lower section







i Vehicles with the ON&OFFROAD package

	Function	Page	Function	Page
⑩	Cup holder	345	⑭  Level control	206
	Ashtray	348	⑮  DSR (Downhill Speed Regulation)	250
	Cigarette lighter	348	⑯  Manual drive program	173
	Socket	349	⑰ Selector wheel for on-road programs	247
⑪	COMAND controller; see the separate operating instructions		Selector wheel for off-road programs	251
			⑱ Stowage compartment with Media Interface	336
⑫	 ON&OFFROAD menu button	255		
⑬	 LOW RANGE off-road gear	253		



i Vehicles without the ON&OFFROAD package and AMG vehicles

	Function	Page
⑩	Cup holder	345
	Ashtray	348
	Cigarette lighter	348
	Socket	349
⑪	COMAND controller; see the separate operating instructions	
⑫	 Selects the drive program	172
	Selects the drive program (AMG vehicles)	172

	Function	Page
⑬	 DSR (Downhill Speed Regulation)	250
⑭	 Level control (vehicles with AIRMATIC package)	213
⑮	 Adaptive Damping System (vehicles with AIRMATIC package)	212
	 Adjusts AMG adaptive damping system (AMG vehicles)	216
⑯	Stowage compartment with Media Interface	336

Overhead control panel

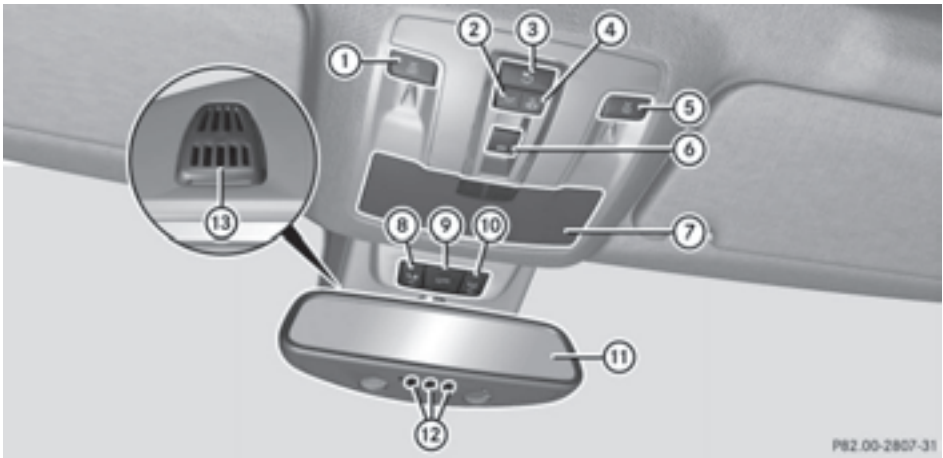













	Function	Page		Function	Page
①	Switches the left-hand reading lamp on/off	127	⑦	Eyeglasses compartment	336
②	Switches the front interior lighting on	128	⑧	Roadside Assistance call button (mbrace system)	354
③	Switches the rear interior lighting on/off	128	⑨	SOS button (mbrace system)	353
④	Switches the front interior lighting/automatic interior lighting control off	128	⑩	MB Info call button (mbrace system)	355
⑤	Switches the right-hand reading lamp on/off	127	⑪	Rear-view mirror	114
⑥	Opens/closes the sliding sunroof Opens/closes the panorama roof with power tilt/sliding panel with roller sunblinds	98 99	⑫	Buttons for the garage door opener	363
			⑬	Microphone for mbrace (emergency call system), telephone and Voice Control System ¹	

¹ Voice Control System only available in combination with COMAND. Observe the additional operating instructions.

Door control panel



	Function	Page
①	Opens the door	87
②	  Unlocks/locks the vehicle	87
③	    Stores settings for the seat, exterior mirrors and steering wheel (memory function)	116
④	Adjusting the seats	105
⑤	    Adjusts and folds the exterior mirrors in/out electrically	114

	Function	Page
⑥	 Opens/closes the side windows	94
⑦	 Opens/closes the tailgate	92
⑧	 Activates/deactivates the override feature for the side windows in the rear compartment	67

Useful information	44
Panic alarm	44
Occupant safety	44
Children in the vehicle	61
Pets in the vehicle	67
Driving safety systems	67
Theft deterrent locking system	77

Useful information

- i** This Operator's Manual describes all models and all standard and optional equipment of your vehicle available at the time of publication of the Operator's Manual. Country-specific differences are possible. Please note that your vehicle may not be equipped with all features described. This also applies to safety-related systems and functions.
- i** Read the information on qualified specialist workshops (▷ page 29).

Panic alarm



- ▶ **To activate:** press **PANIC** button ① for at least one second.
An alarm sounds and the exterior lighting flashes.
 - ▶ **To deactivate:** press **PANIC** button ① again.
- or
- ▶ Insert the SmartKey into the ignition lock.
- or
- ▶ Press the KEYLESS-GO Start/Stop button.
The KEYLESS-GO key must be in the vehicle.

Occupant safety

Restraint system: introduction

The restraint system reduces the risk of occupants hitting parts of the vehicle interior in the event of an accident. Furthermore, the restraint system may also reduce the forces exerted on the vehicle occupants when an accident occurs.

The restraint system includes:

- Seat belt system
- Air bags
- Child restraint system
- Child seat securing system

The components of the restraint system work in conjunction with each other. They can only offer the intended level of protection if all vehicle occupants:

- are correctly wearing their seat belts. (▷ page 47)
- adjust their seat and head restraint properly (▷ page 105).

The driver is also responsible for ensuring that the steering wheel has been correctly positioned. Observe the information relating to the correct driver's seat position (▷ page 104).

Always ensure the air bag can inflate properly if deployed (▷ page 50).

An air bag supplements a correctly fastened seat belt and is an additional safety device providing increased protection for vehicle occupants in appropriate accident situations. For example, if the protection already provided by a correctly fastened seat belt will suffice, the air bags are not deployed. Furthermore, only the air bags that would increase the degree of protection afforded to the vehicle occupants in the event of an accident are deployed. Seat belts and air bags generally do not protect against objects penetrating the vehicle from the outside.

Information on the restraint system operation can be found under "Triggering of belt tensioners and air bags" (▷ page 58).

See “Children in the vehicle” for information on children traveling with you as well as vehicle restraint systems (▷ page 61).

Important safety notes

WARNING

Modifications to the restraint system may cause it to no longer work as intended. The restraint system may then not perform its intended protective function and may fail in an accident or trigger unexpectedly, for example. This poses an increased risk of injury or even fatal injury.

Never modify parts of the restraint system. Never tamper with the wiring, the electronic components or their software.

If it is necessary to modify an air bag system to accommodate a person with disabilities, contact an authorized Mercedes-Benz Center for details. USA only: for further information contact our Customer Assistance Center at 1-800-FOR-MERCEDES (1-800-367-6372).

Restraint system warning lamp

The functions of the restraint system are checked after the ignition is switched on and at regular intervals while the engine is running. Therefore, malfunctions can be detected in good time.

The  restraint system warning lamp in the instrument cluster lights up when the ignition is switched on. It goes out no later than a few seconds after the engine is started. The components of the restraint system are in operational readiness.

A malfunction has occurred if the  restraint system warning lamp:

- does not light up after the ignition is switched on
- does not go out after a few seconds with the engine running
- lights up again while the engine is running

WARNING

If restraint system is malfunctioning, restraint system components may be triggered unintentionally or might not be triggered at all in the event of an accident with a high rate of vehicle deceleration. This can affect the Emergency Tensioning Device or air bag, for example. This poses an increased risk of injury or even fatal injury.

Have the restraint system checked and repaired in a qualified specialist workshop as soon as possible.

PASSENGER AIR BAG OFF indicator lamp



PASSENGER AIR BAG OFF indicator lamp ① is part of the Occupant Classification System (OCS).

The PASSENGER AIR BAG OFF indicator lamp informs you about the status of the front-passenger front air bag.

If the PASSENGER AIR BAG OFF indicator lamp:

- **is lit:** the front-passenger front air bag is deactivated. They will then not be deployed in the event of an accident.
- **does not light up:** the front-passenger front air bag is enabled. If, in the event of an accident, all deployment criteria are met, the front-passenger front air bag is deployed.

Depending on the person in the front-passenger seat, the front-passenger front air bag must either be disabled or enabled; see the following points. You must make sure of this both before and during a journey.

- **Children in a child restraint system:** whether the front-passenger front air bag is enabled or deactivated depends on the installed child restraint system, and the age and size of the child. Therefore, be sure to observe the notes on the "Occupant classification system (OCS)" (▷ page 53) and on "Children in the vehicle" (▷ page 61). There you will also find instructions on backwards- and forwards-facing child restraint systems on the front-passenger seat.
- **All other persons:** depending on the classification of the person in the front-passenger seat, the front-passenger front air bag is enabled or deactivated (▷ page 53). Be sure to observe the notes on "Seat belts" (▷ page 46) and "Air bags" (▷ page 50). There you can also find information on the correct seat position.

Seat belts

Introduction

A correctly fastened seat belt is the most effective means of restraining the movement of vehicle occupants in the event of an accident or overturn. This reduces the risk of vehicle occupants coming into contact with parts of the vehicle interior or being thrown from the vehicle. Furthermore, the seat belt helps to keep the vehicle occupants in the best position in relation to the air bag.

The seat belt system consists of:

- Seat belts
- Emergency Tensioning Devices for the front seat belts and the outer seat belts in the rear compartment
- Belt force limiters

If the seat belt is pulled quickly or suddenly from the belt sash guide, the inertia reel locks. The belt strap cannot be pulled out further.

Emergency Tensioning Devices tighten the seat belts in an accident, pulling them close against the occupant's body. They do not, however, pull vehicle occupants back towards the backrest.

Emergency Tensioning Devices do not correct an incorrect seat position or incorrectly worn seat belts.

When activated, the belt force limiters reduce the force exerted by the seat belt on the vehicle occupants.

The belt force limiters for the front seats are synchronized with the front air bags, which absorb part of the deceleration force. This makes it possible to reduce the forces to which vehicle occupants are subjected during an accident.

! If the front-passenger seat is unoccupied, do not insert the belt tongue into the buckle of the front-passenger seat. This may otherwise lead to the triggering of the Emergency Tensioning Device in the event of an accident, which will then need to be replaced.

Important safety notes

The use of seat belts and child restraint systems is required by law in:

- all 50 states
- the U.S. territories
- the District of Columbia
- all Canadian provinces

Even where this is not required by law, all vehicle occupants should correctly fasten their seat belts before starting the journey.

WARNING

If the seat belt is incorrectly fastened, it cannot protect as intended. Furthermore, an incorrectly fastened seat belt can cause additional injury, for example, in an accident, dur-

ing braking or when abruptly changing direction. This poses an increased risk of injury or even fatal injury.

Make sure that all vehicle occupants are seated properly with a correctly fastened seat belt.

WARNING

The seat belt does not offer the intended level of protection if you have not moved the backrest to an almost vertical position. When braking or in the event of an accident, you could slide underneath the seat belt and sustain abdomen or neck injuries, for example. This poses an increased risk of injury or even fatal injury.

Adjust the seat properly before beginning your journey. Always ensure that the backrest is in an almost vertical position and that the shoulder section of your seat belt is routed across the center of your shoulder.

WARNING

Persons under 5 ft (1.50 m) in height cannot fasten the seat belt correctly without an additional suitable restraint system. If the seat belt is incorrectly fastened, it cannot protect as intended. Furthermore, an incorrectly fastened seat belt can cause additional injury, for example, in an accident, during braking or an abrupt change of direction. This poses an increased risk of injury or even fatal injury.

For this reason, always secure persons under 5 ft (1.50 m) in height in suitable restraint systems.

If a child younger than 12 years and under 5 ft (1.50 m) in height is traveling in the vehicle:

- always secure the child in a child restraint system suitable for this Mercedes-Benz vehicle. The child restraint system must be appropriate to the age, weight and size of the child
- always observe the instructions and safety notes in the "Children in the vehicle" section of this Operator's Manual

(▷ page 61) in addition to the child restraint system manufacturer's installation instructions

- be sure to observe the instructions and safety notes on the "Occupant classification system (OCS)" (▷ page 53)

WARNING

The seat belts may not perform their intended protective function if:

- they are damaged, modified, extremely dirty, bleach or dyed
- the seat belt buckle is damaged or extremely dirty
- the Emergency Tensioning Devices, belt anchorages or inertia reels have been modified

Seat belts may be damaged in an accident, although the damage may not be visible, e.g. due to splinters of glass. Modified or damaged seat belts may tear or fail, e.g. in an accident. Modified Emergency Tensioning Devices could accidentally trigger or fail to deploy when necessary. This poses an increased risk of injury or even fatal injury.

Never modify the seat belts, Emergency Tensioning Devices, belt anchorages or inertia reels. Make sure that the seat belts are undamaged, not worn out and clean. Following an accident, have the seat belts checked immediately at a qualified specialist workshop.

Only use seat belts that have been approved for your vehicle by Mercedes-Benz.

Proper use of the seat belts

Observe the safety notes on the seat belt (▷ page 46).

All vehicle occupants must be wearing the seat belt correctly before beginning the journey. Also make sure that all vehicle occupants are always wearing the seat belt correctly while the vehicle is in motion.

When fastening the seat belt, always make sure that:

- the seat belt tongue is only inserted to the belt buckle belonging to that seat.
- the seat belt is tight across your body. Avoid wearing bulky clothing, e.g. a winter coat.
- the seat belt is not twisted. Only then can the forces which occur be distributed over the area of the belt.
- the shoulder section of the belt is always routed across the center of your shoulder. The shoulder section of the belt must not come into contact with your neck or be routed under your arm. If possible, adjust the seat belt to the appropriate height.
- the lap belt passes tightly and as low down as possible across your lap.

The lap belt must always be routed across your hip joints and not across your abdomen. This applies particularly to pregnant women. If necessary, push the lap belt down to your hip joint and pull it tight using the shoulder section of the belt.

- the seat belt is not routed across sharp, pointed or fragile objects. If you have such items located on or in your clothing, e.g. pens, keys or eyeglasses, store these in a suitable place.

- only one person is using a seat belt at a time. Infants and children must never travel sitting on the lap of a vehicle occupant. In the event of an accident, they could be crushed between the vehicle occupant and seat belt.

- objects are never secured with a seat belt if the seat belt is also being used by one of the vehicle's occupants.

Seat belts are only intended to secure and restrain vehicle occupants. Always observe the "Loading guidelines" for securing objects, luggage or loads (▷ page 334).

Fastening and adjusting the seat belts

Observe the safety notes on the seat belt (▷ page 46) and the notes on correct use of seat belts (▷ page 47).



- ▶ Adjust the seat (▷ page 104). The seat backrest must be in an almost vertical position.
- ▶ Pull the seat belt smoothly from belt sash guide ③ and engage belt tongue ② into belt buckle ①. The seat belt on the driver's seat and the front-passenger seat may be tightened automatically, see "Belt adjustment" (▷ page 49).
- ▶ If necessary, pull upwards on the shoulder section of the seat belt to tighten the belt across your body.

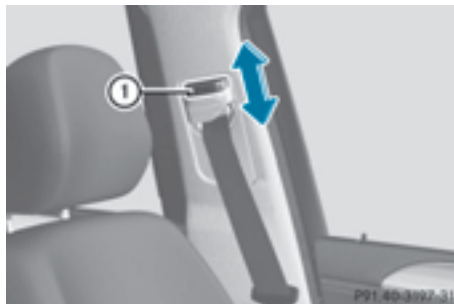

The shoulder section of the seat belt must always be routed across the center of the shoulder. Adjust the belt sash guide if necessary.

- ▶ **To raise:** slide the belt guide upwards. The belt guide will engage in various positions.
- ▶ **To lower:** hold belt guide release ① and slide the belt guide downwards.
- ▶ Let go of belt guide release ① in the desired position and make sure that the belt guide engages.

All seat belts except the driver's seat belt are equipped with a special seat belt retractor to securely fasten child restraint systems in the vehicle. Further information can be found under "Special seat belt retractor" (▷ page 61).

Releasing seat belts

! Make sure that the seat belt is fully rolled up. Otherwise, the seat belt or belt tongue will be trapped in the door or in the seat mechanism. This could damage the door, the door trim panel and the seat belt. Damaged seat belts can no longer fulfill their protective function and must be replaced. Visit a qualified specialist workshop.



- ▶ Press release button ①, hold belt tongue ② and guide it back towards belt outlet ③.

Seat belt adjustment

The seat-belt adjustment is an integral part of the PRE-SAFE® convenience function. This function adjusts the driver's and front-passenger seat belt to the upper body of the occupants.

The belt strap is tightened slightly when:



- the belt tongue is engaged in the buckle and
- the ignition is switched on

The seat-belt adjustment will apply a certain tightening force if any slack is detected between the vehicle occupant and the seat belt. Do not hold on to the seat belt tightly while it is adjusting.

You can switch the seat-belt adjustment on and off in the on-board computer (▷ page 280).

Belt warning for the driver and front passenger

The  seat belt warning lamp in the instrument cluster is a reminder that all occupants must fasten their seat belts. It may light up continuously or flash. In addition, there may be a warning tone.

Regardless of whether the driver's and front-passenger seat belts have already been fastened, the  seat belt warning lamp lights up for six seconds each time the engine is started. If, after six seconds, the driver or front-passenger seat belt has not been fastened and the doors are closed, the  seat belt warning lamp lights up. As soon as the driver's and front-passenger seat belts are fastened or a front door is opened again, the  seat belt warning lamp goes out.

If the driver's seat belt is not fastened after the engine is started, an additional warning tone will sound. This warning tone stops after

six seconds or when the driver's seat belt is fastened.

If the vehicle's speed exceeds 15 mph (25 km/h) once and the driver's and front-passenger seat belts are not fastened, a warning tone sounds. A warning tone also sounds with increasing intensity for 60 seconds or until the driver or front passenger have fastened their seat belts.

If the driver or front passenger unfasten their seat belts during the journey, the seat belt warning is activated again.

- i** For more information on the  seat belt warning lamp, see "Warning and indicator lamps in the instrument cluster, seat belts" (> page 318).

Air bags

Introduction

The installation point of an air bag can be recognized by the AIR BAG symbol.

An air bag complements the correctly fastened seat belt. It is no substitute for the seat belt. The air bag provides additional protection in applicable accident situations.

Not all air bags are deployed in an accident. The different air bag systems function independently from one another (> page 58).

However, no system available today can completely eliminate injuries and fatalities.

It is also not possible to rule out a risk of injury caused by an air bag due to the high speed at which the air bag must be deployed.

Important safety notes

WARNING

If you do not sit in the correct seat position, the air bag cannot protect as intended and could even cause additional injury when deployed. This poses an increased risk of injury or even fatal injury.

To avoid hazardous situations, always make sure that all of the vehicle's occupants:

- have fastened their seat belts correctly, including pregnant women
- are sitting correctly and maintain the greatest possible distance to the air bags
- follow the following instructions

Always make sure that there are no objects between the air bag and the vehicle's occupants.

- Adjust the seats properly before beginning your journey. Always make sure that the seat is in an almost upright position. The center of the head restraint must support the head at about eye level.
- Move the driver's and front-passenger seats as far back as possible. The driver's seat position must allow the vehicle to be driven safely.
- Only hold the steering wheel on the outside. This allows the air bag to be fully deployed.
- Always lean against the backrest while driving. Do not lean forwards or lean against the door or side window. You may otherwise be in the deployment area of the air bags.
- Always keep your feet in the footwell in front of the seat. Do not put your feet on the dashboard, for example. Your feet may otherwise be in the deployment area of the air bag.
- For this reason, always secure persons less than 5 ft (1.50 m) tall in suitable restraint systems. Up to this height, the seat belt cannot be worn correctly.

If a child is traveling in your vehicle, also observe the following notes:

- Always secure children under 12 years of age and less than 5 ft (1.50 m) in height in suitable child restraint systems.
- Child restraint systems should be installed on the rear seats.

- Only secure a child in a rearward-facing child restraint system to the front-passenger seat when the front-passenger front air bag is disabled. If the PASSENGER AIR BAG OFF indicator lamp is permanently lit, the front-passenger front air bag is disabled (▷ page 45).
- Always observe the instructions and safety notes on the "Occupant Classification System (OCS)" (▷ page 53) and on "Children in the vehicle" (▷ page 61) in addition to the child restraint system manufacturer's installation instructions.

Objects in the vehicle interior may prevent the air bag from functioning correctly. Before starting your journey and to avoid risks resulting from the speed of the air bag as it deploys, make sure that:

- there are no people, animals or objects between the vehicle occupants and an air bag.
- there are no objects between the seat, door and B-pillar.
- no hard objects, e.g. coat hangers, hang on the grab handles or coat hooks.
- no accessories, such as cup holders, are attached to the vehicle within the deployment area of an air bag, e.g. to doors, side windows, rear side trim or side walls.
- no heavy, sharp-edged or fragile objects are in the pockets of your clothing. Store such objects in a suitable place.

WARNING

If you modify the air bag cover or affix objects such as stickers to it, the air bag can no longer function correctly. There is an increased risk of injury.

Never modify an air bag cover or affix objects to it.

WARNING

Sensors to control the air bags are located in the doors. Modifications or work not performed correctly to the doors or door paneling, as well as damaged doors, can lead to the

function of the sensors being impaired. The air bags might therefore not function properly any more. Consequently, the air bags cannot protect vehicle occupants as they are designed to do. There is an increased risk of injury.

Never modify the doors or parts of the doors. Always have work on the doors or door paneling carried out at a qualified specialist workshop.

Front air bags



Driver's air bag ① inflates in front of the steering wheel; front-passenger air bag ② inflates in front of and above the glove box.

When deployed, the front air bags offer additional head and thorax protection on the front seats.

The PASSENGER AIR BAG OFF indicator lamp shows you the status of the front-passenger front air bag (▷ page 45).

Front-passenger air bag ② is only deployed if:

- the Occupant Classification System (OCS) recognizes that the front-passenger seat is occupied (▷ page 53)
- the PASSENGER AIR BAG OFF indicator lamp is not lit (▷ page 53)
- the restraint system control unit predicts a high accident severity

Driver's knee bag



Driver's knee bag ① deploys under the steering column. The driver's knee bag is triggered together with the front air bag.

The driver's knee bag offers additional thigh, knee and lower leg protection for the occupant in the driver's seat.

Side impact air bags

WARNING

Unsuitable seat covers could restrict or even prevent the deployment of the air bags integrated into the seats. Consequently, the air bags cannot protect vehicle occupants as they are designed to do. In addition, the function of the Occupant Classification System (OCS) could be restricted. This poses an increased risk of injury or even fatal injury.

You should only use seat covers that have been approved for the respective seat by Mercedes-Benz.



Front side impact air bags ① and rear side impact air bags ② inflate next to the outer cushions of the seat backrest.

When deployed, the side impact air bag offers additional protection for the thorax. Furthermore, on the front seats additional protection is offered for the pelvis. However, it does not protect your:

- head
- neck
- arms

In the event of a side impact, the side impact air bag is deployed on the side on which an impact occurs.

The side impact air bag on the front-passenger side (front) deploys in the following situations:

- the OCS system detects that the front-passenger seat is occupied, or
- the belt tongue is engaged in the buckle on the front-passenger seat

If the belt tongue is engaged in the buckle on the front-passenger seat, the side impact air bag on the front-passenger side deploys at the onset of the applicable accident situation. In this case, it will deploy regardless of whether the front-passenger seat is occupied or not.

Window curtain air bags

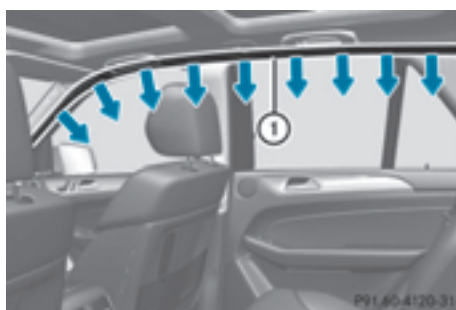

Window curtain air bags ① are integrated into the side of the roof frame and deploy in the area from the A-pillar to the C-pillar.

When deployed, the window curtain air bag offers additional protection for the head. However, it does not protect your chest or arms.

In the event of a side impact, the window curtain air bag is deployed on the side on which the impact occurs.

If the system determines that window curtain air bag deployment can offer additional protection to that provided by the seat belt, a window curtain air bag may deploy in other accident situations (▷ page 58).

Occupant Classification System (OCS)

Introduction

The Occupant Classification System (OCS) categorizes the person in the front-passenger seat. Depending on that result, the front-passenger front air bag is either enabled or deactivated.

The system does not deactivate:

- the side impact air bag
- the window curtain air bag
- the Emergency Tensioning Devices

In the following situation, the side impact air bag and Emergency Tensioning Device are disabled: the OCS system detects that the front-passenger seat is occupied, but the seat belt tongue is not inserted in the belt buckle of the front-passenger seat.

Prerequisites

To be classified correctly, the front passenger must sit:

- with the seat belt fastened correctly
- in an almost upright position with their back against the seat backrest
- with their feet resting on the floor, if possible

If the front passenger does not observe these conditions, OCS may produce a false classification, e.g. because the front passenger:

- transfers their weight by supporting themselves on a vehicle armrest
- sits in such a way that their weight is raised from the seat cushion

If it is absolutely necessary to install a child restraint system on the front-passenger seat, be sure to observe the correct positioning of the child restraint system. Never place objects under or behind the child restraint system, e.g. cushions. The entire base of the child restraint system must always rest on the seat cushion of the front-passenger seat. The backrest of the forwards-facing child restraint system must, as far as possible, be resting on the backrest of the front-passenger seat.

The child restraint system must not touch the roof or be put under strain by the head restraint. Adjust the angle of the seat backrest and the head restraint position accordingly.

Only then can OCS be guaranteed to function correctly. Always observe the child restraint system manufacturer's installation instructions.

Occupant Classification System operation (OCS)



PASSENGER AIR BAG OFF indicator lamp ① informs you whether the front-passenger front air bag is deactivated.

- ▶ Turn the SmartKey to position **1** or **2** in the ignition lock, or press the Start/Stop but-

ton once or twice on vehicles with KEY-LESS-GO.

The system carries out a self-diagnosis.

The PASSENGER AIR BAG OFF indicator lamp must light up for approximately six seconds.

The PASSENGER AIR BAG OFF indicator lamp then displays the status of the front-passenger front air bag. If the status of the front-passenger front air bag changes while the vehicle is in motion, an air bag display message may appear in the instrument cluster (▷ page 295). When the front-passenger seat is occupied, always pay attention to the PASSENGER AIR BAG OFF indicator lamp. Be aware of the status of the front-passenger front air bag both before and during the journey.

If the PASSENGER AIR BAG OFF indicator lamp:

- **is lit**, the front-passenger front air bag is deactivated. They will then not be deployed in the event of an accident.
- **does not light up**: the front-passenger front air bag is enabled. If, in the event of an accident, all deployment criteria are met, the front-passenger front air bag is deployed.

WARNING

If the PASSENGER AIR BAG OFF indicator lamp is lit, the front-passenger front air bag is disabled. It will not be deployed in the event of an accident and cannot perform its intended protective function. A person in the front-passenger seat could then, for example, come into contact with the vehicle's interior, especially if the person is sitting too close to the dashboard. This poses an increased risk of injury or even fatal injury.

When the front-passenger seat is occupied, always ensure that:

- the classification of the person in the front-passenger seat is correct and the front-passenger front air bag is enabled or disa-

bled in accordance with the person in the front-passenger seat

- the front-passenger seat has been moved back as far back as possible.
- the person is seated correctly.

Make sure, both before and during the journey, that the status of the front-passenger front air bag is correct.

WARNING

If you secure a child in a child restraint system on the front-passenger seat and the PASSENGER AIR BAG OFF indicator lamp is off, the front-passenger front air bag can deploy in the event of an accident. The child could be struck by the air bag. This poses an increased risk of injury or even fatal injury.

Make sure that the front-passenger front air bag has been disabled. The PASSENGER AIR BAG OFF indicator lamp must be lit.

WARNING

If you secure a child in a forward-facing child restraint system on the front-passenger seat and you position the front-passenger seat too close to the dashboard, the child could, in the event of an accident:

- come into contact with the vehicle's interior if the PASSENGER AIR BAG OFF indicator lamp is lit, for example
- be struck by the air bag if the PASSENGER AIR BAG OFF indicator lamp is off

This poses an increased risk of injury or even fatal injury.

Move the front-passenger seat as far back as possible. Always make sure that the shoulder belt strap is correctly routed from the vehicle belt sash guide to the shoulder belt guide on the child restraint system. The shoulder belt strap must be routed forwards and downwards from the vehicle belt sash guide. If necessary, adjust the vehicle belt sash guide and the front-passenger seat accordingly. Always observe the child restraint system manufacturer's installation instructions.

If OCS determines that:

- the front-passenger seat is unoccupied, the PASSENGER AIR BAG OFF indicator lamp lights up after the system self-test and remains lit. This indicates that the front-passenger front air bag is deactivated.
- the front-passenger seat is occupied by a child of up to 12 months old, in a standard child restraint system, the PASSENGER AIR BAG OFF indicator lamp lights up after the system self-test and remains lit. This indicates that the front-passenger front air bag is deactivated.

But in the case of a 12-month-old child, in a standard child restraint system, the PASSENGER AIR BAG OFF indicator lamp can go out after the system self-test. This indicates that the front-passenger front air bag is activated. The result of the classification is dependent on, among other factors, the child restraint system and the child's stature. It is recommended that you install the restraint system on a suitable rear seat.

- the front-passenger seat is occupied by a person of smaller stature (e.g. a teenager or small adult), the PASSENGER AIR BAG OFF indicator lamp lights up and remains lit after the system self-test depending on the result of the classification or, alternatively, goes out.
 - if the PASSENGER AIR BAG OFF indicator lamp is off, move the front-passenger seat as far back as possible. Alternatively, a person of small stature can sit on a rear seat.
 - if the PASSENGER AIR BAG OFF indicator lamp is lit, a person of smaller stature should not use the front-passenger seat.
- the front-passenger seat is occupied by an adult or a person of a stature corresponding to that of an adult, the PASSENGER AIR BAG OFF indicator lamp goes out after the system self-test. This indicates that the front-passenger front air bag is activated.

If children are traveling in the vehicle, be sure to observe the notes on "Children in the vehicle" (▷ page 61).

When OCS is malfunctioning, the red  restraint system warning lamp in the instrument cluster and the PASSENGER AIR BAG OFF indicator lamp light up simultaneously. The front-passenger front air bag is deactivated in this case and does not deploy during an accident. Have the system checked by qualified technicians as soon as possible. Consult an authorized Mercedes-Benz Center. The front-passenger seat should only be repaired at an authorized Mercedes-Benz Center.

If the front-passenger seat, the seat cover or the seat cushion is damaged, have the necessary repair work carried out at an authorized Mercedes-Benz Center.

For safety reasons, Mercedes-Benz recommends that you only use seat accessories that have been approved by Mercedes-Benz. If the driver's air bag deploys, this does not mean that the front-passenger front air bag will also deploy. The Occupant Classification System (OCS) categorizes the occupant in the front-passenger seat. Depending on that result, the front-passenger front air bag is either enabled or deactivated.

System self-test

DANGER

If the PASSENGER AIR BAG OFF indicator lamp does not light up during the system self-test, then the system is malfunctioning. The front-passenger front air bag might be triggered unintentionally or might not be triggered at all in the event of an accident with high deceleration. This poses an increased risk of injury or even fatal injury.

In this case the front-passenger seat may not be used. Do not install a child restraint system on the front-passenger seat. Have the Occupant Classification System (OCS) checked and repaired immediately at a qualified specialist workshop.

⚠ DANGER

If the PASSENGER AIR BAG OFF indicator lamp remains lit after the system self-test, the front-passenger front air bag is disabled. It will not be deployed in the event of an accident. In this case, the front-passenger front air bag cannot perform its intended protective function, e.g. when a person is seated in the front-passenger seat.

That person could, for example, come into contact with the vehicle's interior, especially if the person is sitting too close to the dashboard. This poses an increased risk of injury or even fatal injury.

When the front-passenger seat is occupied, always ensure that:

- the classification of the person in the front-passenger seat is correct and the front-passenger front air bag is enabled or disabled in accordance with the person in the front-passenger seat
- the person is seated properly with a correctly fastened seatbelt
- the front-passenger seat has been moved back as far back as possible

If the PASSENGER AIR BAG OFF indicator lamp remains lit when it should not, the front-passenger seat may not be used. Do not install a child restraint system on the front-passenger seat. Have the Occupant Classification System (OCS) checked and repaired immediately at a qualified specialist workshop.

⚠ WARNING

Objects between the seat surface and the child restraint system could affect OCS operation. This could result in the front-passenger air bag not functioning as intended during an accident. This poses an increased risk of injury or even fatal injury.

Do not place any objects between the seat surface and the child restraint system. The entire base of the child restraint system must always rest on the seat cushion of the front-passenger seat. The backrest of the forwards-

facing child restraint system must, as far as possible, be resting on the backrest of the front-passenger seat. Always comply with the child restraint system manufacturer's installation instructions.

After the system self-test, the PASSENGER AIR BAG OFF indicator lamp displays the status of the front-passenger front air bag (▷ page 53).

For more information about the OCS, see "Problems with the Occupant Classification System" (▷ page 57).

Problems with the Occupant Classification System (OCS)

Be sure to observe the notes on "System self-test" (▷ page 55).

Problem	Possible causes/consequences and ► Solutions
<p>The PASSENGER AIR BAG OFF indicator lamp lights up and remains lit, even though the front-passenger seat is occupied by an adult or a person of a stature corresponding to that of an adult.</p>	<p>The classification of the person on the front-passenger seat is incorrect.</p> <ul style="list-style-type: none"> ► Make sure the conditions for a correct classification of the person on the front-passenger seat are met (▷ page 53). ► If the PASSENGER AIR BAG OFF indicator lamp remains lit, the front-passenger seat may not be used. ► Have OCS checked as soon as possible at an authorized Mercedes-Benz Center.
<p>The PASSENGER AIR BAG OFF indicator lamp does not light up and/or does not stay on.</p> <p>The front-passenger seat is:</p> <ul style="list-style-type: none"> • unoccupied • occupied by the weight of a child up to 12 months old in a child restraint system 	<p>OCS is malfunctioning.</p> <ul style="list-style-type: none"> ► Make sure there is nothing between the seat cushion and the child seat. ► Make sure that the entire base of the child restraint system rests on the seat cushion of the front-passenger seat. The backrest of the forwards-facing child restraint system must, as far as possible, be resting on the backrest of front-passenger seat. If necessary, adjust the position of the front-passenger seat. ► When installing the child restraint system, make sure that the seat belt is tight. Do not pull the seat belt tight with the front-passenger seat adjustment. This could result in the seat belt and the child restraint system being pulled too tightly. ► Check the installation of the child restraint system. Make sure that the head restraint does not apply a load to the child restraint system. If necessary, adjust the head restraint accordingly. ► Make sure that no objects are applying additional weight onto the seat. ► If the PASSENGER AIR BAG OFF indicator lamp remains off, do not install a child restraint system on the front-passenger seat. It is recommended that you install the restraint system on a suitable rear seat. ► Have OCS checked as soon as possible at an authorized Mercedes-Benz Center.

Deployment of Emergency Tensioning Devices and air bags

Important safety notes

WARNING

The air bag parts are hot after an air bag has been deployed. There is a risk of injury.

Do not touch the air bag parts. Have a deployed air bag replaced at a qualified specialist workshop as soon as possible.

WARNING

A deployed air bag no longer offers any protection and cannot provide the intended protection in an accident. There is an increased risk of injury.

Have the vehicle towed to a qualified specialist workshop in order to have a deployed air bag replaced.

It is important for your safety and that of any passengers to have deployed air bags replaced and to have any malfunctioning air bags repaired. This will help to make sure the air bags continue to perform their protective function for the vehicle occupants in the event of a crash.

WARNING

Pyrotechnic Emergency Tensioning Devices that have been deployed are no longer operational and are unable to perform their intended protective function. This poses an increased risk of injury or even fatal injury.

Therefore, have pyrotechnic Emergency Tensioning Devices which have been triggered immediately replaced at a qualified specialist workshop.

An electric motor is used by PRE-SAFE® to trigger the tightening of the seat belt in hazardous situations. This procedure is reversible.

If the Emergency Tensioning Devices or air bags are deployed, you will hear a bang and a small amount of powder may also be

released. The  restraint system warning lamp will light up.

Only in rare cases will the bang affect your hearing. The powder released is generally not hazardous to health, it could however cause short-term breathing difficulties in people with asthma or other respiratory problems. In order to prevent breathing difficulties, you should leave the vehicle as soon as it is safe to do so, or open the window.

Air bags and pyrotechnic seat belt tensioners contain perchlorate material, which may require special handling or environmental protection measures. Check with your local government's disposal guidelines. California residents, see www.dtsc.ca.gov/HazardousWaste/Perchlorate/index.cfm.

Method of operation

During the first stage of a collision, the restraint system control unit evaluates important physical data relating to vehicle deceleration or acceleration, such as:

- Duration
- Direction
- Intensity

Based on the evaluation of this data, the restraint system control unit triggers the belt tensioners in the event of a frontal or rear collision.

An Emergency Tensioning Device can only be triggered if:

- the ignition is switched on
- the restraint system components are ready for operation, see "Restraint system warning lamp" (> page 45)
- the belt tongue is inserted into the buckle on the respective front seat

The belt tensioners in the rear compartment are triggered independently of the lock status of the seat belts.

If the restraint system control unit detects a high accident severity, additional components of the restraint system are activated independently of one another in certain frontal collision situations:

- Front air bags and driver's knee bag
- Windowbag, if the system determines that it can offer additional protection to that provided by the seat belt

Depending on the person occupying the front-passenger seat, the front-passenger air bag is activated or deactivated. The front-passenger front air bag can only be deployed in an accident if the PASSENGER AIR BAG OFF indicator lamp is off. Observe the information on the PASSENGER AIR BAG OFF indicator lamp (▷ page 45).

Your vehicle has two-stage front air bags. During the first deployment stage, the front air bag fills with propellant gas which reduces the risk of injury. The second stage is then triggered within milliseconds, filling the front air bag with the maximum amount of propellant gas.

The deployment thresholds for the Emergency Tensioning Devices and air bags are calculated on the basis of the vehicle deceleration or acceleration occurring at various points in the vehicle. This process is pre-emptive in nature. The air bag must be deployed on time, at the start of the collision.

The rate of vehicle deceleration or acceleration and the direction of the force are essentially determined by:

- distribution of the force during the impact
- collision angle
- deformation characteristics of the vehicle
- characteristics of the object with which the vehicle has collided

Factors which can only be seen and measured after the collision has occurred do not play a decisive role in the deployment of an airbag, nor do they provide an indication of air bag deployment.

The vehicle may be considerably deformed without an air bag being deployed. This is the case if only relatively easily deformable parts have been hit and a high rate of deceleration has not been reached. Conversely, an air bag may be deployed even though the vehicle suffers only minor deformation. This is the case if, for example, very rigid vehicle parts such as the longitudinal body members are hit in an accident and the rate of deceleration is sufficient.

If the restraint system control unit detects a side impact or an overturn situation, the relevant restraint system components are activated independently of one another depending on the apparent type of accident. If additional protection for the vehicle occupants is determined in this situation, the belt tensioners are also triggered.

- Side impact air bags on the side of the collision, regardless of Emergency Tensioning Device and use of the seat belt on the driver's side and the outer seats on the second row

The sidebag on the front-passenger side deploys under the following conditions:

- the OCS system detects that the front-passenger seat is occupied or
- the belt tongue has engaged in the belt buckle of the front-passenger seat.
- Window curtain air bag on the side of the collision, regardless of seat belt use and whether front-passenger seat is occupied
- Windowbags on the driver's and front-passenger sides in certain overturn situations if the system determines that they can offer additional protection to that provided by the seat belt

i Not all air bags are deployed in an accident. The various air bag systems work independently of each other.

How the air bag system works is determined by the severity of the accident detected, especially the vehicle deceleration or acceleration, and the apparent type of accident:

- frontal collision
- side impact
- rollover

PRE-SAFE® (anticipatory occupant protection system)

Introduction

In certain hazardous situations, PRE-SAFE® takes pre-emptive measures to protect the vehicle occupants.

Important safety notes

! Make sure that there are no objects in the footwell or behind the seats. There is a danger that the seats and/or objects could be damaged when PRE-SAFE® is activated.

Although your vehicle is equipped with PRE-SAFE®, the possibility of injury in the event of an accident cannot be ruled out. Always adapt your driving style to suit the prevailing road and weather conditions and maintain a safe distance from the vehicle in front. Drive carefully.

Function

PRE-SAFE® intervenes:

- in emergency braking situations, e.g. when BAS is activated
- in critical driving situations, e.g. when physical limits are exceeded and the vehicle understeers or oversteers severely
- on vehicles with the Active Driving Assistance package: if BAS PLUS intervenes powerfully or the radar sensor system detects an imminent danger of collision in certain situations

PRE-SAFE® takes the following measures depending on the hazardous situation detected:

- the front seat belts are pre-tensioned.
- if the vehicle skids, the sliding sunroof and the side windows are closed so that only a small gap remains. The panorama roof with power tilt/sliding panel is completely closed.
- vehicles with the memory function: the front-passenger seat is adjusted if it is in an unfavorable position.
- vehicles with a multicontour seat: the air pressure in the side bolsters of the seat backrest is increased.

If the hazardous situation passes without resulting in an accident, PRE-SAFE® slackens the belt pre-tensioning. On vehicles with multicontour seats, the air pressure in the side bolsters is reduced again. All settings made by PRE-SAFE® can then be reversed.

If the seat belt pre-tensioning is not reduced:

- ▶ Move the seat backrest or seat back slightly when the vehicle is stationary. The seat belt pre-tensioning is reduced and the locking mechanism is released.

The seat-belt adjustment is an integral part of the PRE-SAFE® convenience function. Information about the convenience function can be found under "Belt adjustment" (▷ page 49).

Automatic measures after an accident

Immediately after an accident, the following measures are implemented, depending on the type and severity of the impact:

- by activating the hazard warning lamps
- the emergency lighting is activated
- the vehicle doors are unlocked
- the front side windows are lowered

- in vehicles with a memory function: the electrically adjustable steering wheel is raised
- the engine is switched off
- vehicles with mbrace: automatic emergency call

Children in the vehicle

Important safety notes

Accident statistics show that children secured in the rear seats are safer than children secured in the front-passenger seat. For this reason, Mercedes-Benz strongly advises that you install a child restraint system on a rear seat. Children are generally better protected there.

If a child younger than 12 years and under 5 ft (1.50 m) in height is traveling in the vehicle:

- always secure the child in a child restraint system suitable for Mercedes-Benz vehicles. The child restraint system must be appropriate to the age, weight and size of the child
- be sure to observe the instructions and safety notes in this section in addition to the child restraint system manufacturer's installation instructions
- be sure to observe the instructions and safety notes on the "Occupant classification system (OCS)" (▷ page 53)

WARNING

If you leave children unsupervised in the vehicle, they could set it in motion by, for example:

- release the parking brake.
- shift the automatic transmission out of the parking position **P**.
- start the engine.

In addition, they may operate vehicle equipment and become trapped. There is a risk of an accident and injury.

When leaving the vehicle, always take the SmartKey with you and lock the vehicle. Never leave children unsupervised in the vehicle.

WARNING

If persons, particularly children are subjected to prolonged exposure to extreme heat or cold, there is a risk of injury, possibly even fatal. Never leave children unattended in the vehicle.

WARNING

If the child restraint system is subjected to direct sunlight, parts may get very hot. Children may burn themselves on these parts, particularly on the metal parts of the child restraint system. There is a risk of injury.

If you leave the vehicle, taking the child with you, always ensure that the child restraint system is not exposed to direct sunlight. Protect it with a blanket, for example. If the child restraint system has been exposed to direct sunlight, let it cool down before securing the child in it. Never leave children unattended in the vehicle.

Always ensure that all vehicle occupants have their seat belts fastened correctly and are sitting properly. Particular attention must be paid to children.

Observe the safety notes on the seat belt (▷ page 46) and the notes on correct use of seat belts (▷ page 47).

A booster seat may be necessary to achieve proper seat belt positioning for children over 41 lbs (18 kg) or until they reach a height where a lap/shoulder belt fits properly without a booster seat.

Special seat belt retractor

WARNING

If the seat belt is released while driving, the child restraint system will no longer be secured properly. The special seat belt retractor is disabled and the inertia reel draws in a

portion of the seat belt. The seat belt cannot be immediately refastened. There is an increased risk of injury, possibly even fatal.

Stop the vehicle immediately, paying attention to road and traffic conditions. Reactivate the special seat belt retractor and secure the child restraint system properly.

All seat belts in the vehicle, except the driver's seat belt, are equipped with a special seat belt retractor. When activated, the special seat belt retractor ensures that the seat belt cannot slacken once the child seat is secured.

Installing a child restraint system:

- ▶ Make sure you observe the child restraint system manufacturer's installation instructions.
- ▶ Pull the seat belt smoothly from the belt outlet.
- ▶ Engage seat belt tongue in belt buckle.

Activating the special seat belt retractor:

- ▶ Pull the seat belt out fully and let the inertia reel retract it again.
While the seat belt is retracting, you should hear a ratcheting sound. The special seat belt retractor is enabled.
- ▶ Push the child restraint system down so that the seat belt is tight and does not loosen.

Removing a child restraint system/deactivating the special seat belt retractor:

- ▶ Make sure you observe the child restraint system manufacturer's installation instructions.
- ▶ Press the belt buckle release button, hold the belt tongue and guide it back towards the belt outlet.
The special seat belt retractor is deactivated.

Child restraint system

The use of seat belts and child restraint systems is required by law in:

- all 50 states
- the U.S. territories
- the District of Columbia
- all Canadian provinces

If you install a rearward-facing child restraint system on the center rear seat, the rear arm rest must be folded back as far as possible.

You can obtain further information about the correct child restraint system from any authorized Mercedes-Benz Center.

WARNING

If the child restraint system is installed incorrectly on a suitable seat, it cannot protect as intended. The child cannot then be restrained in the event of an accident, heavy braking or sudden changes of direction. There is an increased risk of injury, possibly even fatal.

Make sure that you observe the child restraint system manufacturer's installation instructions and the notes on use. Please ensure, that the base of the child restraint system is always resting completely on the seat cushion. Never place objects, e.g. cushions, under or behind the child restraint system. Only use child restraint systems with the original cover designed for them. Only replace damaged covers with genuine covers.

WARNING

If the child restraint system is installed incorrectly or is not secured, it can come loose in the event of an accident, heavy braking or a sudden change in direction. The child restraint system could be thrown about, striking vehicle occupants. There is an increased risk of injury, possibly even fatal.

Always install child restraint systems properly, even if they are not being used. Make sure that you observe the child restraint system manufacturer's installation instructions.

You will find further information on stowing objects, luggage or loads under "Loading guidelines" (▷ page 334).

WARNING

Child restraint systems or their securing systems which have been damaged or subjected to a load in an accident can no longer protect as intended. The child cannot then be restrained in the event of an accident, heavy braking or sudden changes of direction. There is an increased risk of injury, possibly even fatal.

Replace child restraint systems which have been damaged or subjected to a load in an accident as soon as possible. Have the securing systems on the child restraint system checked at a qualified specialist workshop, before you install a child restraint system again.

If it is absolutely necessary to carry a child on the front-passenger seat, be sure to observe the information on the "Occupant Classification System (OCS)" (▷ page 53). There you will also find information on deactivating the front-passenger front air bag.

All child restraint systems must meet the following standards:

- U.S. Federal Motor Vehicle Safety Standards 213 and 225
- Canadian Motor Vehicle Safety Standards 213 and 210.2

Confirmation that the child restraint system corresponds to the standards can be found on an instruction label on the child restraint system. This confirmation can also be found in the installation instructions that are included with the child restraint system.

Observe the warning labels in the vehicle interior and on the child restraint system.

LATCH-type (ISOFIX) child seat securing system

WARNING

LATCH-type (ISOFIX) child restraint systems do not offer sufficient protective effect for children whose weight is greater than 48 lbs (22 kg) who are secured using the safety belt integrated in the child restraint system. In the event of an accident, a child might not be restrained correctly. This poses an increased risk of injury or even fatal injury.

If the child weighs more than 48 lbs (22 kg), only use LATCH-type (ISOFIX) child restraint systems with which the child is also secured with the vehicle seat belt. Also secure the child restraint system with the Top Tether belt, if available.

Always comply with the manufacturer's installation and operating instructions for the child restraint system used.

Before every trip, make sure that the LATCH-type (ISOFIX) child restraint system is engaged correctly in both LATCH-type (ISOFIX) securing rings

- ❗ When installing the child restraint system, make sure that the seat belt for the middle seat does not get trapped. The seat belt could otherwise be damaged.

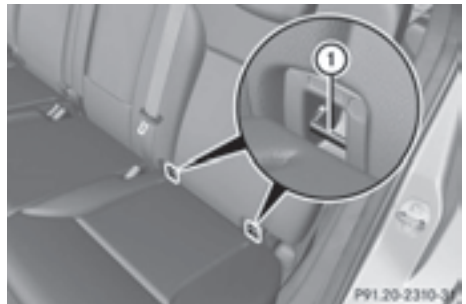

① LATCH-type (ISOFIX) securing rings

- ▶ Install the LATCH-type (ISOFIX) child restraint system on both LATCH-type (ISOFIX) securing rings ①.

ISOFIX is a standardized securing system for specially designed child restraint systems on the rear seats. LATCH-type (ISOFIX) securing rings ① for two LATCH-type (ISOFIX) child restraint systems are installed on the left and right rear seats.

Non-LATCH-type (ISOFIX) child seats may also be used and can be installed using the vehicle's seat belt system. Install child seats according to the manufacturer's instructions.

Top Tether

Introduction

Top Tether provides an additional connection between a child restraint system, secured with a LATCH-type (ISOFIX) child seat mount, and the rear seat. This helps reduce the risk of injury even further. If the child restraint system has a Top Tether belt, this should be used at all times.

Important safety notes

WARNING

If the rear seats or the rear seat backrests are not locked, they could fold forwards in the event of an accident, heavy braking or sudden changes of direction. As a result, child restraint systems cannot perform their intended protective function. Rear seats and rear seat backrests that are not locked can also cause additional injuries, e.g. in the event of an accident. This poses an increased risk of injury or even fatal injury.

Always lock the rear seats and rear seat backrests after installing a Top Tether belt. Observe the lock verification indicator. Adjust the rear seat backrests so that they are in an upright position.

Top Tether anchorage points

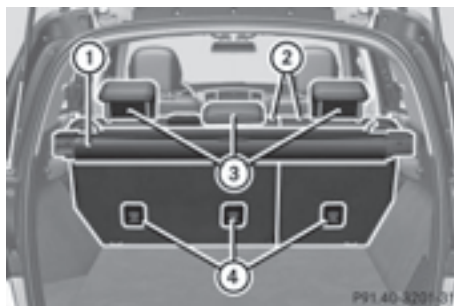

Top Tether anchorage points ④ are on the rear side of the rear seat backrests.

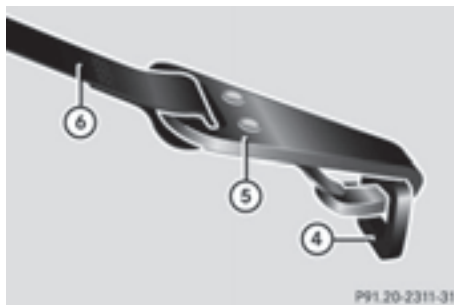

- ▶ Move head restraint ③ upwards.
- ▶ Fit the LATCH-type (ISOFIX) child restraint system with Top Tether. Make sure you observe the child restraint system manufacturer's installation instructions.
- ▶ Route Top Tether belt ⑥ under head restraint ③ between both head restraint bars.
- ▶ Guide Top Tether belt ⑥ downward between cargo compartment cover ① and rear seat backrests ②.
- ▶ Hook Top Tether hook ⑤ of Top Tether belt ⑥ into Top Tether anchorage ④.

Make sure that:

- Top Tether hook ⑤ is hooked into Top Tether anchorage ④, as shown
- Top Tether belt ⑥ is not twisted
- when cargo compartment cover ① is installed, Top Tether belt ⑥, runs

between rear seat backrests ② and cargo compartment cover ①

- when the safety net is installed, Top Tether belt ⑥ runs between rear seat backrests ② and the safety net.
- ▶ Tension Top Tether belt ⑥. Make sure you observe the child restraint system manufacturer's installation instructions.
- ▶ If necessary, push head restraint ③ back down slightly (▷ page 108). Make sure you do not interfere with the correct routing of Top Tether belt ⑥.

Child restraint system on the front-passenger seat

General notes

Accident statistics show that children secured in the rear seats are safer than children secured in the front-passenger seat. For this reason, Mercedes-Benz strongly advises that you install a child restraint system on a rear seat.

If it is absolutely necessary to install a child restraint system to the front-passenger seat, be sure to observe the instructions and safety notes on the "Occupant classification system (OCS)" (▷ page 53).

You can thus avoid the risks that could arise as a result of:

- an incorrectly categorized person in the front-passenger seat
- the unintentional deactivation of the front-passenger front air bag
- the unsuitable positioning of the child restraint system, e.g. too close to the dashboard

Rearward-facing child restraint system

If it is absolutely necessary to install a rearward-facing child restraint system on the front-passenger seat, always make sure that the front-passenger front air bag is deactivated. Only if the PASSENGER AIR BAG OFF

indicator lamp is permanently lit (▷ page 45) is the front-passenger front air bag deactivated.

Always observe the child restraint system manufacturer's installation and operating instructions.

Forward-facing child restraint system

If it is absolutely necessary to install a forward-facing child restraint system on the front-passenger seat, always move the front-passenger seat as far back as possible. The entire base of the child restraint system must always rest on the seat cushion of the front-passenger seat. The backrest of the child restraint system must, as far as possible, lie flat against the backrest of the front-passenger seat. The child restraint system must not touch the roof or be put under strain by the head restraint. Adjust the angle of the seat backrest and the head restraint position accordingly. Always make sure that the shoulder belt strap is correctly routed from the vehicle belt sash guide to the shoulder belt guide on the child restraint system. The shoulder belt strap must be routed forwards and downwards from the vehicle belt sash guide. If necessary, adjust the vehicle belt sash guide and the front-passenger seat accordingly.

Always observe the child restraint system manufacturer's installation and operating instructions.

Child-proof locks

Important safety notes

WARNING

If children are traveling in the vehicle, they could:

- open doors, thus endangering other people or road users
- exit the vehicle and be caught by oncoming traffic
- operate vehicle equipment and become trapped

There is a risk of an accident and injury.

Always activate the child-proof locks and override feature if children are traveling in the vehicle. When leaving the vehicle, always take the key with you and lock the vehicle. Never leave children unattended in the vehicle.

Override feature for:

- the rear doors (▷ page 66)
- the rear side windows (▷ page 67)

WARNING

If you leave children unsupervised in the vehicle, they could set it in motion by, for example:

- release the parking brake.
- shift the automatic transmission out of the parking position **P**.
- start the engine.

In addition, they may operate vehicle equipment and become trapped. There is a risk of an accident and injury.

When leaving the vehicle, always take the SmartKey with you and lock the vehicle. Never leave children unsupervised in the vehicle.

WARNING

If persons, particularly children are subjected to prolonged exposure to extreme heat or cold, there is a risk of injury, possibly even fatal. Never leave children unattended in the vehicle.

WARNING

If the child restraint system is subjected to direct sunlight, parts may get very hot. Children may burn themselves on these parts, particularly on the metal parts of the child restraint system. There is a risk of injury.

If you leave the vehicle, taking the child with you, always ensure that the child restraint system is not exposed to direct sunlight. Protect it with a blanket, for example. If the child restraint system has been exposed to direct sunlight, let it cool down before securing the child in it. Never leave children unattended in the vehicle.

Child-proof locks for the rear doors

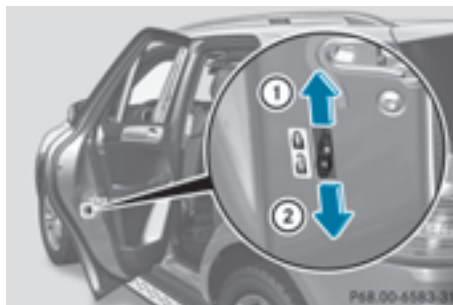

You secure each door individually with the child-proof locks on the rear doors. A door secured with a child-proof lock cannot be opened from inside the vehicle. When the vehicle is unlocked, the door can be opened from the outside.

- ▶ **To activate:** press the child-proof lock lever up in the direction of arrow ①.
- ▶ Make sure that the child-proof locks are working properly.
- ▶ **To deactivate:** press the child-proof lock lever down in the direction of arrow ②.

Override feature for the rear side windows



- **To activate/deactivate:** press button ①. If indicator lamp ② is lit, operation of the rear side windows is disabled. Operation is only possible using the switches in the driver's door. If indicator lamp ② is off, operation is possible using the switches in the rear compartment.

Pets in the vehicle

WARNING

If you leave animals unattended or unsecured in the vehicle, they could press buttons or switches, for example.

As a result, they could:

- activate vehicle equipment and become trapped, for example
- activate or deactivate systems, thereby endangering other road users

Unsecured animals could also be flung around the vehicle in the event of an accident or sudden steering or braking, thereby injuring vehicle occupants. There is a risk of an accident and injury.

Never leave animals unattended in the vehicle. Always secure animals properly during the journey, e.g. use a suitable animal transport box.

Driving safety systems

Overview of driving safety systems

In this section, you will find information about the following driving safety systems:

- **ABS (Anti-lock Braking System)** (▷ page 68)
- **BAS (Brake Assist System)** (▷ page 68)
- **BAS PLUS (Brake Assist System Plus)** (▷ page 69)
- **COLLISION PREVENTION ASSIST** (distance warning function and adaptive Brake Assist) (▷ page 70)
- **ESP® (Electronic Stability Program)** (▷ page 73)
- **EBD (Electronic Brake force Distribution)** (▷ page 75)
- **ADAPTIVE BRAKE** (▷ page 75)
- **PRE-SAFE® Brake** (▷ page 75)
- **STEER CONTROL** (▷ page 77)

Important safety notes

If you fail to adapt your driving style or become distracted, the driving safety systems can neither reduce the risk of accident nor override the laws of physics. Driving safety systems are merely aids designed to assist driving. You are responsible for the distance to the vehicle in front, for vehicle speed and for braking in good time. Always adapt your driving style to suit the prevailing road and weather conditions and maintain a safe distance from the vehicle in front. Drive carefully.

- i** The driving safety systems described only work as effectively as possible when there is adequate contact between the tires and the road surface. Please pay special attention to the notes on tires, recommended minimum tire tread depths, etc. (▷ page 400).

In wintry driving conditions, always use winter tires (M+S tires) and if necessary,

snow chains. Only in this way will the driving safety systems described in this section work as effectively as possible.

ABS (Anti-lock Braking System)

General information

ABS regulates brake pressure in such a way that the wheels do not lock when you brake. This allows you to continue steering the vehicle when braking.

The  ABS warning lamp in the instrument cluster lights up when the ignition is switched on. It goes out when the engine is running.

Important safety notes

- i** Observe the "Important safety notes" section (▷ page 67).

WARNING

If ABS is faulty, the wheels could lock when braking. The steerability and braking characteristics may be severely impaired. Additionally, further driving safety systems are deactivated. There is an increased danger of skidding and accidents.

Drive on carefully. Have ABS checked immediately at a qualified specialist workshop.

When ABS is malfunctioning, other systems, including driving safety systems, will also become inoperative. Observe the information on the ABS warning lamp (▷ page 320) and display messages which may be shown in the instrument cluster (▷ page 285).

ABS works from a speed of about 5 mph (8 km/h), regardless of road-surface conditions. ABS works on slippery surfaces, even when you only brake gently.

Braking

- ▶ **If ABS intervenes:** continue to depress the brake pedal vigorously until the braking situation is over.
- ▶ **To make a full brake application:** depress the brake pedal with full force.

If ABS intervenes when braking, you will feel a pulsing in the brake pedal.

The pulsating brake pedal can be an indication of hazardous road conditions, and functions as a reminder to take extra care while driving.

Off-road ABS

An ABS system specifically suited to off-road terrain is activated automatically once the off-road program is activated (▷ page 251).

At speeds below 20 mph (30 km/h), the front wheels lock cyclically during braking. The digging-in effect achieved in the process reduces the stopping distance on off-road terrain. This limits steering capability.

BAS (Brake Assist System)

General information

BAS operates in emergency braking situations. If you depress the brake pedal quickly, BAS automatically boosts the braking force, thus shortening the stopping distance.

Important safety notes

- i** Observe the "Important safety notes" section (▷ page 67).

WARNING

If BAS is malfunctioning, the braking distance in an emergency braking situation is increased. There is a risk of an accident.

In an emergency braking situation, depress the brake pedal with full force. ABS prevents the wheels from locking.

Braking

- ▶ Keep the brake pedal firmly depressed until the emergency braking situation is over. ABS prevents the wheels from locking.

The brakes will function as usual once you release the brake pedal. BAS is deactivated.

BAS PLUS (Brake Assist System PLUS)

General information

- i** Observe the "Important safety notes" section (▶ page 67).

BAS PLUS is only available in vehicles equipped with DISTRONIC PLUS.

For BAS PLUS to assist you, the radar sensor system must be operational.

With the help of the radar sensor system, BAS PLUS can detect obstacles that are in the path of your vehicle for an extended period of time.

If the radar sensor system is malfunctioning, BAS PLUS will not be available. The brake system is still available with complete brake boosting effect and BAS.

BAS PLUS can help you to minimize the risk of a collision with a vehicle or reduce the effects of such a collision. If BAS PLUS detects a danger of collision, you are assisted when braking.

Important safety notes

WARNING

BAS PLUS cannot always clearly identify objects and complex traffic situations.

In such cases, BAS PLUS may:

- intervene unnecessarily
- not intervene

There is a risk of an accident.

Always pay careful attention to the traffic situation and be ready to brake. Terminate the intervention in a non-critical driving situation.

WARNING

BAS PLUS does not react:

- to people or animals
- to oncoming vehicles
- to crossing traffic
- when cornering

As a result, BAS PLUS may not intervene in all critical situations. There is a risk of an accident.

Always pay careful attention to the traffic situation and be ready to brake.

In the event of snowfall or heavy rain, the recognition can be impaired.

Recognition by the radar sensor system is also impaired in the event of:

- dirt on the sensors or anything else covering the sensors
- there is interference by other radar sources
- there are strong radar reflections, for example in parking garages
- a narrow vehicle traveling in front, e.g. a motorbike
- a vehicle traveling in front on a different line relative to the center of your vehicle

Following damage to the front end of the vehicle, have the configuration and operation of the radar sensors checked at a qualified specialist workshop. This also applies to collisions at low speeds where there is no visible damage to the front of the vehicle.

Function

To avoid a collision, BAS PLUS calculates the brake force necessary if:

- you approach an obstacle, and
- BAS PLUS has detected a risk of collision

When driving at a speed under 20 mph (30 km/h): if you depress the brake pedal, BAS PLUS is activated. The increase in brake pressure will be carried out at the last possible moment.

When driving at a speed above 20 mph (30 km/h): if you depress the brake pedal sharply, BAS PLUS automatically raises the brake pressure to a value adapted to the traffic situation.

BAS PLUS provides braking assistance in hazardous situations with vehicles in front within a speed range between 4 mph (7 km/h) and 155 mph (250 km/h).

At speeds of up to approximately 40 mph (70 km/h), BAS PLUS can also react to stationary objects. Examples of stationary objects are stopped or parked vehicles.

i If BAS PLUS demands particularly high braking force, preventative passenger protection measures (PRE-SAFE®) are activated simultaneously.

► Keep the brake pedal depressed until the emergency braking situation is over. ABS prevents the wheels from locking.

BAS PLUS is deactivated and the brakes function as usual again, if:

- you release the brake pedal.
- there is no longer a risk of collision.
- no obstacle is detected in front of your vehicle.

If you have activated DSR (▷ page 250), BAS PLUS is likewise deactivated.

COLLISION PREVENTION ASSIST

General notes

COLLISION PREVENTION ASSIST consists of Adaptive Brake Assist and the distance warning function, which are described in the following.

Distance warning function

Important safety notes

i Observe the "Important safety notes" section (▷ page 67).

WARNING

The distance warning function does not react:

- to people or animals
- to oncoming vehicles
- to crossing traffic
- when cornering

Thus, the distance warning function cannot provide a warning in all critical situations. There is a risk of an accident.

Always pay careful attention to the traffic situation and be ready to brake.

WARNING

The distance warning function cannot always clearly identify objects and complex traffic situations.

In such cases, the distance warning function may:

- give an unnecessary warning
- not give a warning

There is a risk of an accident.

Always pay careful attention to the traffic situation and do not rely solely on the distance warning function.

Function

► **To activate/deactivate:** activate or deactivate the distance warning function in the on-board computer (▷ page 275).

If the distance warning function is not activated, the  symbol appears in the assistance graphics display.

The distance warning function can help you to minimize the risk of a front-end collision with a vehicle ahead or reduce the effects of such a collision. If the distance warning function detects that there is a risk of a collision, you will be warned visually and acoustically. The distance warning function cannot prevent a collision without your intervention.

Starting at a speed of around 4 mph (7 km/h), the distance warning function warns you if you rapidly approach a vehicle in front. An intermittent warning tone will then sound,

and the  distance warning lamp will light up in the instrument cluster.

► Brake immediately in order to increase the distance from the vehicle in front.

or

► Take evasive action, provided it is safe to do so.

Due to the nature of the system, particularly complicated but non-critical driving conditions may also cause the system to display a warning.

With the help of the radar sensor system, the distance warning function can detect obstacles that are in the path of your vehicle for an extended period of time.

Up to a speed of about 40 mph (70 km/h), the distance warning function can also react to stationary obstacles, such as stopped or parked vehicles.

If you approach an obstacle and the distance warning function detects a risk of a collision, the system will initially alert you both visually and acoustically.

In particular, the detection of obstacles can be impaired if:

- dirt on the sensors or anything else covering the sensors
- there is snow or heavy rain
- there is interference by other radar sources
- there are strong radar reflections, for example in parking garages
- a narrow vehicle traveling in front, e.g. a motorbike
- a vehicle traveling in front on a different line relative to the center of your vehicle
- new vehicles or after the COLLISION PREVENTION ASSIST system has been serviced

Observe the notes in the section on braking-in (▷ page 156).

Following damage to the front end of the vehicle, have the configuration and operation of the radar sensor checked at a qualified specialist workshop. This also applies to colli-

sions at low speeds where there is no visible damage to the front of the vehicle.

Adaptive Brake Assist

 Observe the "Important safety notes" section (▷ page 67).

WARNING

Adaptive Brake Assist cannot always clearly identify objects and complex traffic situations.

In such cases, Adaptive Brake Assist may:

- intervene unnecessarily
- not intervene

There is a risk of an accident.

Always pay careful attention to the traffic situation and be ready to brake. Terminate the intervention in a non-critical driving situation.

WARNING

Adaptive Brake Assist does not react:

- to people or animals
- to oncoming vehicles
- to crossing traffic
- to stationary obstacles
- when cornering

As a result, Adaptive Brake Assist may not intervene in all critical conditions. There is a risk of an accident.

Always pay careful attention to the traffic situation and be ready to brake.

Due to the nature of the system, particularly complicated but non-critical driving conditions may also cause Brake Assist to intervene.

Adaptive Brake Assist aids you in braking during hazardous situations at speeds above 4 mph (7 km/h) and uses the radar sensor system to evaluate the traffic situation.

With the help of Adaptive Brake Assist, the distance warning signal can detect obstacles that are in the path of your vehicle for an extended period of time.

Should you approach an obstacle and Adaptive Brake Assist has detected a risk of collision, Adaptive Brake Assist calculates the braking force necessary to avoid a rear-end collision. Should you apply the brakes vigorously, Adaptive Brake Assist will automatically increase the braking force to a level suitable for the traffic conditions.

- ▶ Keep the brake pedal depressed until the emergency braking situation is over. ABS prevents the wheels from locking.

The brakes will work normally again if:

- you release the brake pedal.
- there is no longer any danger of a collision.
- no obstacle is detected in front of your vehicle.

Adaptive Brake Assist is then deactivated.

Vehicles with PRE-SAFE®: if adaptive Brake Assist requires particularly high brake pressure, preventive passenger protection measures (PRE-SAFE®) are deployed simultaneously.

Up to vehicle speeds of around 155 mph (250 km/h), adaptive Brake Assist is capable of reacting to moving objects that have already been recognized as such at least once over the period of observation. Adaptive Brake Assist does not react to stationary obstacles.

If Adaptive Brake Assist is not available due to a malfunction in the radar sensor system, the brake system remains available with full brake boosting effect and BAS.

In particular, the detection of obstacles can be impaired if there is:

- dirt on the sensors or anything else covering the sensors
- there is snow or heavy rain
- there is interference by other radar sources
- there are strong radar reflections, for example in parking garages
- a narrow vehicle traveling in front, e.g. a motorbike

- a vehicle traveling in front on a different line relative to the center of your vehicle
- new vehicles or after the COLLISION PREVENTION ASSIST system has been serviced

Observe the notes in the section on braking-in (▷ page 156).

Following damage to the front end of the vehicle, have the configuration and operation of the radar sensor checked at a qualified specialist workshop. This also applies to collisions at low speeds where there is no visible damage to the front of the vehicle.

ESP® (Electronic Stability Program)

General notes

- ❗ Observe the "Important safety notes" section (▷ page 67).

ESP® monitors driving stability and traction, i.e. power transmission between the tires and the road surface.

If ESP® detects that the vehicle is deviating from the direction desired by the driver, one or more wheels are braked to stabilize the vehicle. The engine output is also modified to keep the vehicle on the desired course within physical limits. ESP® assists the driver when pulling away on wet or slippery roads. ESP® can also stabilize the vehicle during braking.

ETS/4ETS (Electronic Traction System)

ETS/4ETS traction control is part of ESP®.

Traction control brakes the drive wheels individually if they spin. This enables you to pull away and accelerate on slippery surfaces, for example if the road surface is slippery on one side. In addition, more drive torque is transferred to the wheel or wheels with traction.

Traction control remains active, even if you deactivate ESP®.

In appropriate driving situations, activate the off-road program (▷ page 251).

Off-road 4ETS (Electronic Traction System)

A 4ETS system specifically suited to off-road terrain is activated automatically once the off-road program is activated (▷ page 251).

Important safety notes

WARNING

If ESP® is malfunctioning, ESP® is unable to stabilize the vehicle. Additionally, further driving safety systems are deactivated. This increases the risk of skidding and an accident.



Drive on carefully. Have ESP® checked at a qualified specialist workshop.

! Vehicles with 4MATIC: only operate the vehicle for a maximum of ten seconds on a brake test dynamometer. Switch off the ignition.

Application of the brakes by ESP® may otherwise destroy the brake system.

! Vehicles with 4MATIC: function or performance tests may only be carried out on a 2-axle dynamometer. Before you operate the vehicle on such a dynamometer, please consult a qualified workshop. You could otherwise damage the drive train or the brake system.

ESP® is deactivated if the  warning lamp in the instrument cluster lights up continuously when the engine is running.

If the  warning lamp and the  warning lamp are lit continuously, ESP® is not available due to a malfunction.

Observe the information on warning lamps (▷ page 323) and display messages which may be shown in the instrument cluster (▷ page 285).

i Only use wheels with the recommended tire sizes. Only then will ESP® function properly.

Characteristics of ESP®

General information

If the  ESP warning lamp goes out before beginning the journey, ESP® is automatically active.

If ESP® intervenes, the  ESP® warning lamp flashes in the instrument cluster.

If ESP® intervenes:

- ▶ Do not deactivate ESP® under any circumstances.
- ▶ Only depress the accelerator pedal as far as necessary when pulling away.
- ▶ Adapt your driving style to suit the prevailing road and weather conditions.

ECO start/stop function

The ECO start/stop function switches the engine off automatically when the vehicle stops moving. The engine starts automatically when the driver wants to pull away again. ESP® remains in its previously selected status. **Example:** if ESP® was deactivated before the engine was switched off, ESP® remains deactivated when the engine is switched on again.

Deactivating/activating ESP®

Important safety notes

You can select between the following states of ESP®:

- ESP® is activated.
- ESP® is deactivated.

WARNING

If you deactivate ESP®, ESP® no longer stabilizes the vehicle. There is an increased risk of skidding and an accident.

Only deactivate ESP® in the situations described in the following.

It may be best to deactivate ESP® in the following situations:

- when using snow chains
- in deep snow
- on sand or gravel

i Activate ESP® as soon as the situations described above no longer apply. ESP® will otherwise not be able to stabilize the vehicle if the vehicle starts to skid or a wheel starts to spin.

! Avoid spinning the driven wheels for an extended period with ESP® deactivated. You could otherwise damage the drivetrain.

Deactivating/activating ESP®



► **To switch off:** press button ①.

The  ESP® OFF warning lamp in the instrument cluster lights up.

► **To switch on:** press button ①.

The  ESP® OFF warning lamp in the instrument cluster goes out.

Characteristics when ESP® is deactivated

If ESP® is deactivated and one or more wheels start to spin, the  ESP® warning lamp in the instrument cluster flashes. In such situations, ESP® will not stabilize the vehicle.

If you deactivate ESP®:

- ESP® no longer improves driving stability.
- engine torque is no longer limited and the drive wheels are able to spin.

The spinning of the wheels results in a cutting action for better traction on loose surfaces.

- traction control is still activated.
- ESP® still provides support when you brake.

Off-road ESP® (vehicles with Off-Road Engineering package)

An ESP® system specifically suited to off-road terrain is activated automatically once the off-road program is activated (► page 251).

Off-road ESP® intervenes with a delay if there is oversteering or understeering, thus improving traction.

ESP® trailer stabilization

General information

ESP® trailer stabilization is not available in AMG vehicles.

If your vehicle/trailer combination begins to swerve, ESP® assists you in this situation. ESP® slows the vehicle down by braking and limiting the engine output until the vehicle/trailer combination has stabilized.

Important safety notes

WARNING

If road and weather conditions are poor, trailer stabilization will not be able to prevent the vehicle/trailer combination from swerving. Trailers with a high center of gravity can tip over before ESP® can detect this. There is a risk of an accident.

Always adapt your driving style to the prevailing road and weather conditions.

If your vehicle with trailer (vehicle/trailer combination) begins to lurch, you can only stabilize the vehicle/trailer combination by depressing the brake firmly.

Trailer stabilisation is active above speeds of about 37 mph (60 km/h).

ESP® trailer stabilization does not work if ESP® is deactivated or disabled because of a malfunction.

EBD (Electronic Brake force Distribution)

General information

EBD monitors and controls the brake pressure on the rear wheels to improve driving stability while braking.

Important safety notes

- Observe the "Important safety notes" section for driving safety systems (> page 67).

WARNING

If EBD has malfunctioned, the rear wheels can still lock, e.g. under full braking. This increases the risk of skidding and an accident.

You should therefore adapt your driving style to the different handling characteristics. Have the brake system checked at a qualified specialist workshop.

Observe information regarding indicator and warning lamps (> page 321) as well as display messages (> page 287).

ADAPTIVE BRAKE

ADAPTIVE BRAKE enhances braking safety and offers increased braking comfort. In addition to the braking function, ADAPTIVE BRAKE also has the HOLD function (> page 210) and hill start assist (> page 161).

PRE-SAFE® Brake

General information

- Observe the "Important safety notes" section (> page 67).

PRE-SAFE® Brake is only available in vehicles with DISTRONIC PLUS.

For PRE-SAFE® Brake to assist you when driving, the radar sensor system must be operational.

With the help of the radar sensor system, PRE-SAFE® Brake can detect obstacles that are in front of your vehicle for an extended period of time.

PRE-SAFE® Brake can help you to minimize the risk of a collision with a vehicle ahead, and reduce the effects of such a collision. If PRE-SAFE® Brake has detected a risk of collision, you will be warned visually and acoustically as well as by automatic braking. PRE-SAFE® Brake cannot prevent a collision without your intervention.

Important safety notes

WARNING

PRE-SAFE® Brake will initially brake your vehicle by a partial application of the brakes if a danger of collision is detected. There may be a collision unless you also brake. Automatic emergency braking cannot prevent a collision. There is a risk of an accident.

Always apply the brakes yourself and try to take evasive action.

WARNING

PRE-SAFE® Brake cannot always clearly identify objects and complex traffic conditions.

In these cases, PRE-SAFE® Brake may:

- give an unnecessary warning and then brake the vehicle
- not give a warning or intervene

There is a risk of an accident.

Always pay particular attention to the traffic situation and be ready to brake, especially if PRE-SAFE® Brake warns you. Terminate the intervention in a non-critical driving situation.

In order to maintain the appropriate distance to the vehicle in front and thus prevent a collision, you must apply the brakes yourself.

 **WARNING**

PRE-SAFE® Brake does not react:

- to people or animals
- to oncoming vehicles
- to crossing traffic
- when cornering

As a result, PRE-SAFE® Brake may neither give warnings nor intervene in all critical situations. There is a risk of an accident.

Always pay careful attention to the traffic situation and be ready to brake.

In the event of snowfall or heavy rain, the recognition can be impaired.

Recognition by the radar sensor system is also impaired in the event of:

- dirt on the sensors or anything else covering the sensors
- interference by other radar sources
- strong radar reflections, for example in parking garages
- a narrow vehicle traveling in front, e.g. a motorbike
- a vehicle traveling in front on a different line relative to the center of your vehicle

Following damage to the front end of the vehicle, have the configuration and operation of the radar sensors checked at a qualified specialist workshop. This also applies to collisions at low speeds where there is no visible damage to the front of the vehicle.

Function

► **To activate/deactivate:** activate or deactivate PRE-SAFE® Brake in the on-board computer (▷ page 276).

If the PRE-SAFE® Brake is not activated, the  symbol appears in the multifunction display.

Starting at a speed of around 4 mph (7 km/h), this function warns you if you rapidly approach a vehicle in front. An intermittent warning tone will then sound and the 

distance warning lamp will light up in the instrument cluster.

- Brake immediately to defuse the situation.
- or
- Take evasive action provided it is safe to do so.

PRE-SAFE® Brake can also brake the vehicle automatically under the following conditions:

- the driver and front-passenger have their seat belts fastened and
- the vehicle speed is between approximately 4 mph (7 km/h) and 124 mph (200 km/h)

At speeds of up to approximately 40 mph (70 km/h) PRE-SAFE® Brake can also detect stationary objects. Examples of stationary objects are stopped or parked vehicles.

 If there is an increased risk of collision, preventive passenger protection measures (PRE-SAFE®) are activated.

If the risk of collision with the vehicle in front remains and you do not brake, take evasive action or accelerate significantly, the vehicle may perform automatic emergency braking, up to the point of full brake application. Automatic emergency braking is not performed until immediately prior to an imminent accident.

You can prevent the intervention of the PRE-SAFE® Brake at any time by:

- depressing the accelerator pedal further.
- activating kickdown.
- releasing the brake pedal.

The braking action of PRE-SAFE® Brake is ended automatically if:

- you maneuver to avoid the obstacle.
- there is no longer any danger of a collision.
- there is no longer an obstacle detected in front of your vehicle.

If you have activated DSR (▷ page 250), PRE-SAFE® Brake is deactivated.

STEER CONTROL

General information

STEER CONTROL helps you by transmitting a noticeable steering force to the steering wheel in the direction required for vehicle stabilization.

This steering assistance is provided in particular if:

- both right wheels or both left wheels are on a wet or slippery road surface when you brake.
- the vehicle starts to skid.

Important safety notes

- ❗ Observe the "Important safety notes" section (▷ page 67).

No steering support is provided from STEER CONTROL, if:

- ESP® is malfunctioning.
- the lighting is faulty.

Power steering will, however, continue to function.

Theft deterrent locking system

Immobilizer

- ▶ **To activate with the SmartKey:** remove the SmartKey from the ignition lock.
- ▶ **To activate with KEYLESS-GO:** switch the ignition off and open the driver's door.
- ▶ **To deactivate:** switch on the ignition.

The immobilizer prevents your vehicle from being started without the correct SmartKey. When leaving the vehicle, always take the SmartKey with you and lock the vehicle. Anyone can start the engine if a valid SmartKey has been left inside the vehicle.

- ❗ The immobilizer is always deactivated when you start the engine.

In the event that the engine cannot be started when the starter battery is fully

charged, the immobilizer may be faulty. Contact an authorized Mercedes-Benz Center or call 1-800-FOR-MERCEDES (in the USA) or 1-800-387-0100 (in Canada).

ATA (anti-theft alarm system)



- ▶ **To arm:** lock the vehicle with the SmartKey or KEYLESS-GO.

Indicator lamp ① flashes. The alarm system is armed after approximately 15 seconds.

- ▶ **To deactivate using the SmartKey:** unlock the vehicle with the SmartKey.

or

- ▶ Insert the SmartKey into the ignition lock.

- ▶ **To deactivate using KEYLESS-GO:** unlock the vehicle with KEYLESS-GO.

or

- ▶ Press the Start/Stop button on the dashboard. The SmartKey must be inside the vehicle.

A visual and audible alarm is triggered if the alarm system is armed and you open:

- a door
- the vehicle with the mechanical key
- the tailgate
- the hood

► **To turn the alarm off with the SmartKey:**

press the  or  button on the SmartKey.

The alarm is switched off.

or

► Insert the SmartKey into the ignition lock.

The alarm is switched off.

► **To stop the alarm using KEYLESS-GO:**

grasp the outside door handle. The SmartKey must be outside the vehicle.

The alarm is switched off.

or

► Press the Start/Stop button on the dashboard. The SmartKey must be inside the vehicle.

The alarm is switched off.

The alarm is not switched off, even if you close the open door that triggered it, for example.

i If the alarm continues for more than 30 seconds, the mbrace emergency call system automatically notifies the Customer Assistance Center. This is done either by text message or data connection. The emergency call system sends the message or data provided that:

- you have subscribed to the mbrace service.
- the mbrace service has been activated properly.
- the necessary mobile phone network is available.

Useful information	80
SmartKey	80
Doors	86
Cargo compartment	89
Side windows	93
Sliding sunroof	97

Useful information

- i** This Operator's Manual describes all models and all standard and optional equipment of your vehicle available at the time of publication of the Operator's Manual. Country-specific differences are possible. Please note that your vehicle may not be equipped with all features described. This also applies to safety-related systems and functions.
- i** Read the information on qualified specialist workshops (▷ page 29).

SmartKey

Important safety notes

WARNING

If children are left unsupervised in the vehicle, they could:

- open the doors, thus endangering other people or road users.
 - get out and disrupt traffic.
 - operate the vehicle's equipment.
- Additionally, children could set the vehicle in motion if, for example, they:
- release the parking brake.
 - shifting the automatic transmission out of park position **P**
 - Start the engine.

There is a risk of an accident and injury.

When leaving the vehicle, always take the SmartKey with you and lock the vehicle. Never leave children or animals unattended in the vehicle. Always keep the SmartKey out of reach of children.

WARNING

If persons, particularly children are subjected to prolonged exposure to extreme heat or cold, there is a risk of injury, possibly even fatal. Never leave children unattended in the vehicle.

WARNING

If you attach heavy or large objects to the SmartKey, the SmartKey could be unintentionally turned in the ignition lock. This could cause the engine to be switched off. There is a risk of an accident.

Do not attach any heavy or large objects to the SmartKey. Remove any bulky key rings before inserting the SmartKey into the ignition lock.

- !** Keep the SmartKey away from strong magnetic fields. Otherwise, the remote control function could be affected. Strong magnetic fields can occur in the vicinity of powerful electrical installations.



Do not keep the SmartKey:

- with electronic devices, e.g. a mobile phone or another SmartKey
 - with metallic objects, e.g. coins or metal foil
 - inside metallic objects, e.g. a metal case
- This can affect the functionality of the SmartKey.

Do not keep the KEYLESS-GO key in the temperature-controlled cup holder. Otherwise, the KEYLESS-GO key will not be recognized.

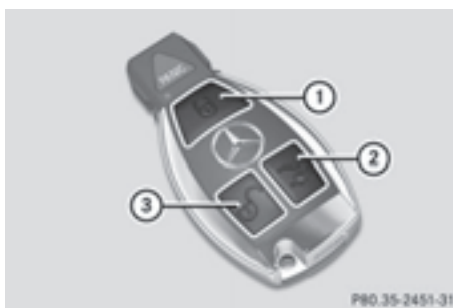
SmartKey functions



- ①  To lock the vehicle
- ②  To open/close the tailgate
- ③  To unlock the vehicle

► **To unlock centrally:** press button ③.

If you do not open the vehicle within approximately 40 seconds of unlocking:

- the vehicle is locked again.
- the theft deterrent locking system is armed again.

► **To lock centrally:** press button ①.

The SmartKey centrally locks/unlocks:

- the doors
- the tailgate
- the fuel filler flap

The turn signals flash once when unlocking and three times when locking.

You can also set an audible signal to confirm that the vehicle has been locked. The audible signal can be activated and deactivated using the on-board computer (► page 279).

When it is dark, the surround lighting also comes on if it is activated in the on-board computer (► page 278).

KEYLESS-GO

General notes

Bear in mind that the engine can be started by any of the vehicle occupants if there is a KEYLESS-GO key in the vehicle.

Locking/unlocking centrally

You can start, lock or unlock the vehicle using KEYLESS-GO. To do this, you only need carry the SmartKey with you. You can combine the functions of KEYLESS-GO with those of a conventional SmartKey. Unlock the vehicle by using KEYLESS-GO, for instance, and lock it using the  button on the SmartKey.

When locking or unlocking with KEYLESS-GO, the distance between the SmartKey and the corresponding door handle must not be greater than 3 ft (1 m).

KEYLESS-GO checks whether a valid SmartKey is in the vehicle by periodically establishing a radio connection between the vehicle and the SmartKey. This happens:

- when the external door handles are touched
- when starting the engine
- while the vehicle is in motion



► **To unlock the vehicle:** touch the inner surface of the door handle.

► **To lock the vehicle:** touch sensor surface ①.



► **Convenience closing feature:** touch recessed sensor surface ② for an extended period.

Further information on the convenience closing feature (► page 95).



If you pull on the handle of the tailgate, only the cargo compartment of the vehicle is unlocked.

Changing the settings of the locking system

You can change the settings of the locking system. This means that only the driver's door and the fuel filler flap are unlocked when the vehicle is unlocked. This is useful if you frequently travel on your own.



► **To change the setting:** press and hold down the  and  buttons simultaneously for approximately six seconds until

the battery check lamp flashes twice (▷ page 83).



i If the setting of the locking system is changed within the signal range of the vehicle, pressing the  or  button:

- locks or
- unlocks the vehicle

The SmartKey now functions as follows:

- ▶ **To unlock the driver's door:** press the  button once.
- ▶ **To unlock centrally:** press the  button twice.
- ▶ **To lock centrally:** press the  button.

The KEYLESS-GO function is changed as follows:

- ▶ **To unlock the driver's door:** touch the inner surface of the door handle on the driver's door.
- ▶ **To unlock centrally:** touch the inner surface of the door handle on the front-passenger door or the rear door.
- ▶ **To lock centrally:** touch the outer sensor surface on one of the door handles (▷ page 81).
- ▶ **To restore the factory settings:** press and hold down the  and  buttons simultaneously for approximately six seconds until the battery check lamp flashes twice (▷ page 83).



Mechanical key

General notes

If the vehicle can no longer be locked or unlocked with the SmartKey, use the mechanical key.

If you use the mechanical key to unlock and open the driver's door, the anti-theft alarm system will be triggered (▷ page 77).

There are several ways to turn off the alarm:

▶ **To deactivate the alarm with the SmartKey:** press the  or  button on the SmartKey.

or

▶ Insert the SmartKey into the ignition lock.

or

▶ **To deactivate the alarm with KEYLESS-GO:** press the Start/Stop button in the ignition lock. The SmartKey must be in the vehicle.

or

▶ Lock or unlock the vehicle using KEYLESS-GO. The SmartKey must be outside the vehicle.

If you unlock the vehicle using the mechanical key, the fuel filler flap will not be unlocked automatically.

▶ **To unlock the fuel filler flap:** insert the SmartKey into the ignition lock.

Removing the mechanical key



▶ Push release catch ① in the direction of the arrow and at the same time remove mechanical key ② from the SmartKey.

For further information about:

- unlocking the driver's door (▷ page 88)
- unlocking the cargo compartment (▷ page 93)
- locking the vehicle (▷ page 88)

Inserting the mechanical key

- ▶ Push mechanical key ② completely into the SmartKey until it engages and release catch ① is back in its basic position.

SmartKey battery

Important safety notes

WARNING

Batteries contain toxic and corrosive substances. If batteries are swallowed, it can result in severe health problems. There is a risk of fatal injury.



Keep batteries out of the reach of children. If a battery is swallowed, seek medical attention immediately.

Mercedes-Benz recommends that you have the batteries replaced at a qualified specialist workshop.



The SmartKey batteries contain perchlorate material, which may require special handling and regard for the environment. National guidelines must be observed during disposal. In California, see www.dtsc.ca.gov/HazardousWaste/Perchlorate/index.cfm.

Checking the battery



- ▶ Press the  or  button. The battery is working properly if battery check lamp ① lights up briefly.

The battery is discharged if battery check lamp ① does not light up briefly.

- ▶ Change the battery (▷ page 83).
- ❗ If the SmartKey battery is checked within the signal reception range of the vehicle, pressing the  or  button:
 - locks or
 - unlocks the vehicle
- ❗ You can get a battery at any qualified specialist workshop.

Replacing the battery

You require a CR 2025 3 V cell battery.





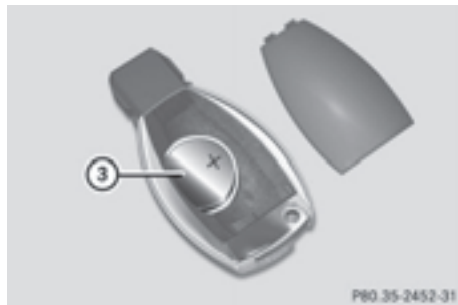

- ▶ Take the mechanical key out of the SmartKey (▷ page 82).



- ▶ Press mechanical key ② into the opening in the SmartKey in the direction of the arrow until battery compartment cover ① opens. Do not hold battery compartment cover ① closed while doing so.
- ▶ Remove battery compartment cover ①.



- ▶ Repeatedly tap the SmartKey against your palm until battery ③ falls out.
- ▶ Insert the new battery with the positive terminal facing upwards. Use a lint-free cloth to do so.
- ▶ Make sure that the surface of the battery is free of lint, grease and other contaminants.
- ▶ Insert the front tabs of battery compartment cover ① into the housing first and then press to close it.
- ▶ Insert mechanical key ② into the SmartKey.
- ▶ Check the function of all SmartKey buttons on the vehicle.

Problems with the SmartKey	
Problem	Possible causes/consequences and ► Solutions
You cannot lock or unlock the vehicle using the SmartKey.	<p>The SmartKey battery is discharged or nearly discharged.</p> <ul style="list-style-type: none"> ► Try again to lock/unlock the vehicle using the remote control function of the SmartKey. Point the tip of the SmartKey at the driver's door handle from close range and press the  or  button. <p>If this does not work:</p> <ul style="list-style-type: none"> ► Check the SmartKey battery (> page 83) and replace it if necessary (> page 83). ► Lock (> page 88) or unlock (> page 88) the vehicle using the mechanical key.
	<p>The SmartKey is faulty.</p> <ul style="list-style-type: none"> ► Lock (> page 88) or unlock (> page 88) the vehicle using the mechanical key. ► Have the SmartKey checked at a qualified specialist workshop.
You can no longer lock or unlock the vehicle using KEYLESS-GO.	<p>There is interference from a powerful source of radio waves.</p> <ul style="list-style-type: none"> ► Lock/unlock the vehicle using the remote control function of the SmartKey. Point the tip of the SmartKey at the driver's door handle from close range and press the  or  button.
	<p>There is a malfunction with KEYLESS-GO.</p> <ul style="list-style-type: none"> ► Lock/unlock the vehicle using the remote control function of the SmartKey. Point the tip of the SmartKey at the driver's door handle from close range and press the  or  button. ► Have KEYLESS-GO checked at a qualified specialist workshop. <p>If this does not work:</p> <ul style="list-style-type: none"> ► Check the SmartKey battery (> page 83) and replace it if necessary (> page 83). ► Lock (> page 88) or unlock (> page 88) the vehicle using the mechanical key.
You have lost a SmartKey.	<ul style="list-style-type: none"> ► Have the SmartKey deactivated at a qualified specialist workshop. ► Report the loss immediately to the vehicle insurers. ► If necessary, have the locks changed as well.
You have lost the mechanical key.	<ul style="list-style-type: none"> ► Report the loss immediately to the vehicle insurers. ► If necessary, have the locks changed as well.

Problem	Possible causes/consequences and ► Solutions
The engine cannot be started using the SmartKey.	<p>The on-board voltage is too low.</p> <p>► Switch off non-essential consumers, e.g. seat heating or interior lighting, and try to start the engine again.</p> <p>If this does not work:</p> <p>► Check the starter battery and charge it if necessary (▷ page 389).</p> <p>or</p> <p>► Jump-start the vehicle (▷ page 391).</p> <p>or</p> <p>► Consult a qualified specialist workshop.</p>
The engine cannot be started using KEYLESS-GO. The SmartKey is in the vehicle.	<p>A door is open. Therefore, the SmartKey cannot be detected as easily.</p> <p>► Close the door and try to start the vehicle again.</p> <hr/> <p>There is interference from a powerful source of radio waves.</p> <p>► Start your vehicle with the SmartKey in the ignition lock.</p>

Doors

Important safety notes

WARNING

If children are left unsupervised in the vehicle, they could:

- open the doors, thus endangering other people or road users.
- get out and disrupt traffic.
- operate the vehicle's equipment.

Additionally, children could set the vehicle in motion if, for example, they:

- release the parking brake.
- shifting the automatic transmission out of park position **P**
- Start the engine.

There is a risk of an accident and injury.

When leaving the vehicle, always take the SmartKey with you and lock the vehicle. Never leave children or animals unattended in the vehicle. Always keep the SmartKey out of reach of children.

WARNING

If persons, particularly children are subjected to prolonged exposure to extreme heat or cold, there is a risk of injury, possibly even fatal. Never leave children unattended in the vehicle.

WARNING

If objects, luggage or loads are not secured or not secured sufficiently, they could slip, tip over or be flung around and thereby hit vehicle occupants. There is a risk of injury, particularly in the event of sudden braking or a sudden change in direction.

Always store objects so that they cannot be flung around. Secure objects, luggage or loads against slipping or tipping before the journey.

You should preferably place luggage or loads in the cargo compartment. Observe the loading guidelines (▷ page 334).

Unlocking and opening doors from the inside

You can open a door from inside the vehicle even if it has been locked. You can only open the rear doors from inside the vehicle if they are not secured by the child-proof locks (▷ page 66).

If the vehicle has been locked with the Smart-Key or with KEYLESS-GO, opening a door from the inside will trigger the anti-theft alarm system. Switch off the alarm (▷ page 77).

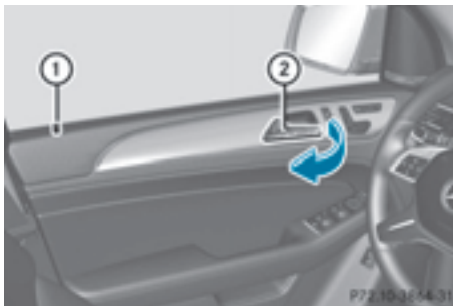

- ▶ **Front door:** pull door handle ②.
If the door is locked, locking knob ① pops up. The door is unlocked and can be opened.
- ▶ **Rear door:** pull up locking knob ① on the relevant rear door.
The rear door is unlocked and can be opened.

Centrally locking and unlocking the vehicle from the inside

You can centrally lock or unlock the vehicle from the inside. The buttons are located on both front doors.



- ① To unlock
- ② To lock

▶ **To unlock:** press button ①.

▶ **To lock:** press button ②.

If the front-passenger door is closed, the vehicle locks.

Meanwhile, the fuel filler flap will not be locked or unlocked.

You cannot unlock the vehicle centrally from the inside if the vehicle has been locked with the SmartKey or KEYLESS-GO.

You can open a front door from inside the vehicle even if it has been locked.

If the vehicle has been locked using the locking button for the central locking, or has been locked automatically, and a door is opened from the inside:

- the vehicle will be fully unlocked if it had previously been fully unlocked
- only the door which has been opened from the inside is unlocked if only the driver's door had been previously unlocked

Automatic locking feature



- ▶ **To disarm:** press and hold button ① for about five seconds until a tone sounds.
- ▶ **To arm:** press and hold button ② for about five seconds until a tone sounds.

i If you press one of the two buttons and do not hear a tone, the relevant setting has already been selected.

The vehicle is locked automatically when the ignition is switched on and the wheels are turning.

You could therefore be locked out if:

- the vehicle is being pushed.
- the vehicle is being towed.
- the vehicle is on a roller dynamometer.

You can also switch the automatic locking function on and off using the on-board computer (▷ page 279).

Power closing

Power closing pulls the doors and trunk lid into their locks automatically even if they are only partly closed.

- ▶ **To power close a door:** push the door into the lock up to the first detent position. Power closing will pull the door fully closed.
- ▶ **To power close the tailgate:** lightly press the tailgate downwards. Power closing will pull the tailgate fully closed.

Unlocking the driver's door (mechanical key)

If the vehicle can no longer be unlocked with the SmartKey, use the mechanical key.

If you use the mechanical key to unlock and open the driver's door, the anti-theft alarm system will be triggered (▷ page 77).

- ▶ Take the mechanical key out of the SmartKey (▷ page 82).
- ▶ Insert the mechanical key into the lock of the driver's door as far as it will go.



- ▶ Turn the mechanical key counter-clockwise to position 1. The door is unlocked.
- ▶ Turn the mechanical key back and remove it.
- ▶ Insert the mechanical key into the SmartKey.

Locking the vehicle (mechanical key)

If the vehicle can no longer be locked with the SmartKey, use the mechanical key.

- ▶ Open the driver's door.
- ▶ Close the front-passenger door, the rear doors and the tailgate.
- ▶ Press the locking button (▷ page 87).
- ▶ Check whether the locking knobs on the front-passenger door and the rear doors are still visible. Press down the locking knobs by hand, if necessary.
- ▶ Close the driver's door.

- ▶ Take the mechanical key out of the Smart-Key (▷ page 82).
- ▶ Insert the mechanical key into the lock of the driver's door as far as it will go.



- ▶ Turn the mechanical key clockwise as far as it will go to position **1**.
 - ▶ Turn the mechanical key back and remove it.
 - ▶ Make sure that the doors and the tailgate are locked.
 - ▶ Insert the mechanical key into the Smart-Key.
- i** If you lock the vehicle as described above, the fuel filler flap is not locked. The anti-theft alarm system is not armed.

Cargo compartment

Important safety notes

⚠ WARNING

If persons, particularly children are subjected to prolonged exposure to extreme heat or cold, there is a risk of injury, possibly even fatal. Never leave children unattended in the vehicle.

⚠ WARNING

Combustion engines emit poisonous exhaust gases such as carbon monoxide. If the tailgate is open when the engine is running, particularly if the vehicle is moving, exhaust fumes could enter the passenger compartment. There is a risk of poisoning.

Turn off the engine before opening the tailgate. Never drive with the tailgate open.

⚠ WARNING

If objects, luggage or loads are not secured or not secured sufficiently, they could slip, tip over or be flung around and thereby hit vehicle occupants. There is a risk of injury, particularly in the event of sudden braking or a sudden change in direction.

Always store objects so that they cannot be flung around. Secure objects, luggage or loads against slipping or tipping before the journey.

- !** The tailgate swings upwards and to the rear when opened. Therefore, make sure that there is sufficient clearance above and behind the tailgate.

- i** Tailgate opening dimensions (▷ page 456).

You should preferably place luggage or loads in the cargo compartment. Observe the loading guidelines (▷ page 334).

Do not leave the SmartKey in the cargo compartment. You could otherwise lock yourself out.

Vehicles without the EASY-PACK tailgate: the tailgate can be:

- opened and closed manually from outside
- unlocked from inside with the emergency release

For vehicles with the EASY-PACK tailgate you can:

- close the tailgate manually from outside
- open and close the tailgate automatically from outside
- open and close the tailgate automatically from inside
- unlock the tailgate from inside with the emergency release
- limit the opening angle of the tailgate

Tailgate reversing feature

On vehicles with tailgate remote closing feature, the tailgate is equipped with automatic obstacle recognition with a reversing feature. If a solid object blocks or restricts the tailgate when automatically opening or closing, this procedure is stopped. If the tailgate is stopped during the closing procedure, it will open again automatically. The automatic obstacle recognition with reversing function is only an aid. It is not a substitute for your attentiveness when opening and closing the tailgate.

WARNING

The reversing feature does not react:

- to soft, light and thin objects, e.g. small fingers
- over the last 1/3 in (8 mm) of the closing movement

This means that the reversing feature cannot prevent someone being trapped in these situations. There is a risk of injury.

Make sure that no body parts are in close proximity during the closing procedure.

If somebody becomes trapped:

- press the  button on the SmartKey, or
- press the remote operating switch on the driver's door, or
- press the closing or locking button on the tailgate, or
- pull the handle on the tailgate

Opening and closing manually from outside

Opening



- ▶ Press the  button on the SmartKey.
- ▶ Pull handle ①.
- ▶ Raise the tailgate.

Vehicles with the EASY-PACK tailgate: if you pull handle ① and then release it, the tailgate opens automatically.

Closing



- ▶ Pull the tailgate down using recess ①.
- ▶ Allow the tailgate to drop into the lock.
- ▶ Lock the vehicle if necessary with the  button on the SmartKey or with KEYLESS-GO.

i If a KEYLESS-GO key is detected in the cargo compartment, the tailgate will not lock.

Opening/closing automatically from outside

Important safety notes

WARNING

Parts of the body could become trapped during automatic closing of the tailgate. Moreover, people, e.g. children, may be standing in the closing area or may enter the closing area during the closing process. There is a risk of injury.

Make sure that nobody is in the vicinity of the closing area during the closing process.

Use one of the following options to stop the closing process:

- press the  button on the SmartKey.
- press the remote operating switch on the driver's door.
- press the closing or locking button on the tailgate.
- pull the handle on the tailgate.

WARNING

Combustion engines emit poisonous exhaust gases such as carbon monoxide. If the tailgate is open when the engine is running, particularly if the vehicle is moving, exhaust fumes could enter the passenger compartment. There is a risk of poisoning.

Turn off the engine before opening the tailgate. Never drive with the tailgate open.

! The tailgate swings upwards and to the rear when opened. Therefore, make sure that there is sufficient clearance above and behind the tailgate.

- i** Tailgate opening dimensions (▷ page 456).
- i** Notes on the reversing feature for the tailgate (▷ page 90).

Opening the tailgate automatically

You can open the tailgate automatically with the SmartKey or the handle in the tailgate.

- ▶ Press and hold the  button on the SmartKey until the tailgate opens.
- or
- ▶ If the tailgate is unlocked, pull the handle and let it go again immediately.

Closing the tailgate automatically

WARNING

Parts of the body could become trapped during automatic closing of the tailgate. Moreover, people, e.g. children, may be standing in the closing area or may enter the closing area during the closing process. There is a risk of injury.

Make sure that nobody is in the vicinity of the closing area during the closing process.

Use one of the following options to stop the closing process:

- press the  button on the SmartKey.
- press the remote operating switch on the driver's door.
- press the closing or locking button on the tailgate.
- pull the handle on the tailgate.

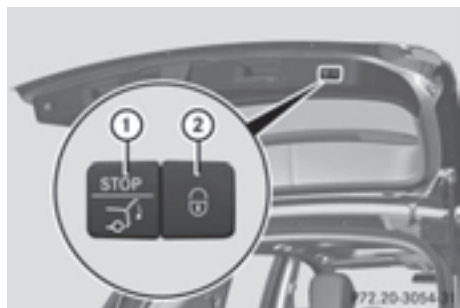

Closing and locking button (example: vehicle with EASY-PACK tailgate and KEYLESS-GO)

- ▶ **To close:** press closing button ① on the tailgate.

or

- ▶ Press and hold the  button on the SmartKey until the tailgate closes.

Vehicles with the EASY-PACK tailgate and KEYLESS-GO: you can simultaneously close and lock the tailgate.

- ▶ Press locking button ② on the tailgate. If a KEYLESS-GO key is detected outside the vehicle, the tailgate closes and locks. All the doors must be shut and the SmartKey located in the vicinity of the tailgate.

- ❗ The tailgate cannot be opened and closed with the SmartKey if there is a SmartKey in the ignition.

If the tailgate touches an object while closing, the closing procedure is interrupted and the tailgate reopens.

- ❗ If a KEYLESS-GO key is detected in the cargo compartment, the tailgate will not lock.

Opening/closing automatically from inside

Important safety notes

WARNING

Parts of the body could become trapped during automatic closing of the tailgate. Moreover, people, e.g. children, may be standing in the closing area or may enter the closing area during the closing process. There is a risk of injury.

Make sure that nobody is in the vicinity of the closing area during the closing process.

Use one of the following options to stop the closing process:

- press the  button on the SmartKey.
- press the remote operating switch on the driver's door.

- press the closing or locking button on the tailgate.
- pull the handle on the tailgate.

WARNING

Combustion engines emit poisonous exhaust gases such as carbon monoxide. If the tailgate is open when the engine is running, particularly if the vehicle is moving, exhaust fumes could enter the passenger compartment. There is a risk of poisoning.

Turn off the engine before opening the tailgate. Never drive with the tailgate open.

- ❗ The tailgate swings upwards and to the rear when opened. Therefore, make sure that there is sufficient clearance above and behind the tailgate.

- ❗ Tailgate opening dimensions (▷ page 456).

- ❗ Notes on the reversing feature for the tailgate (▷ page 90).

Opening and closing



You can open and close the tailgate from the driver's seat when the vehicle is stationary and unlocked.

- ▶ **To open:** pull remote operating switch ① for the tailgate until the tailgate opens.
- ▶ **To close:** turn the SmartKey to position 1 or 2 in the ignition lock.
- ▶ Press remote operating switch for tailgate ① until the tailgate is closed.

Limiting the opening angle of the tailgate

Important safety notes

- ⚠ Make sure there is sufficient clearance to open the tailgate fully when setting the opening angle. The tailgate could otherwise be damaged. Ideally, set the opening angle outside.

Activating

You can limit the opening angle of the tailgate. This is possible in the top half of its opening range, up to approximately 4 in (10 cm) before the stop.

This could be useful, for example, if there is insufficient space above the tailgate.

- ▶ **To open the tailgate:** pull the handle on the tailgate.
- ▶ **To stop the opening procedure at the desired position:** press the closing button (▷ page 91) in the tailgate or pull the handle on the outside of the tailgate again.
- ▶ **To store the position:** press and hold the closing button in the tailgate until you hear a short tone.
The opening angle limiter is activated. The tailgate will now stop in the stored position when opening.

Deactivating

- ▶ Press and hold the closing button (▷ page 91) in the tailgate until you hear two short tones.

Tailgate emergency release

Important safety notes

- ⚠ The tailgate swings upwards and to the rear when opened. Therefore, make sure that there is sufficient clearance above and behind the tailgate.

- ⓘ Tailgate opening dimensions (▷ page 456).

If the tailgate can no longer be opened from outside the vehicle, use the emergency release on the inside of the tailgate.

Opening

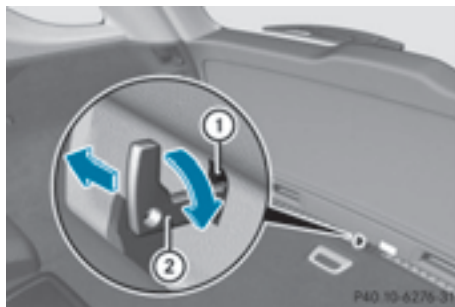

- ▶ Take the mechanical key out of the Smart-Key (▷ page 82).
- ▶ Insert mechanical key ② into the opening in paneling ①.
- ▶ Turn mechanical key ② 90° clockwise.
- ▶ Push mechanical key ② in the direction of the arrow and open the tailgate.
- ▶ Insert the mechanical key into the Smart-Key.
- ⓘ When you lock the vehicle (▷ page 88), the cargo compartment is also locked.

Side windows

Important safety notes

⚠ WARNING

While opening the side windows, body parts could become trapped between the side window and the door frame as the side window moves. There is a risk of injury.

Make sure that nobody touches the side window during the opening procedure. If somebody becomes trapped, release the switch or pull the switch to close the side window again.

⚠ WARNING

While closing the side windows, body parts in the closing area could become trapped. There is a risk of injury.

When closing make sure that no parts of the body are in the closing area. If somebody becomes trapped, release the switch or press the switch to open the side window again.

⚠ WARNING

If children operate the side windows they could become trapped, particularly if they are left unsupervised. There is a risk of injury.

Activate the override feature for the rear side windows. When leaving the vehicle, always take the SmartKey with you and lock the vehicle. Never leave children unsupervised in the vehicle.

Side window reversing feature

The side windows are equipped with an automatic reversing feature. If a solid object blocks or restricts a side window during the closing process, the side window opens again automatically. However, the automatic reversing feature is only an aid and does not relieve you of the responsibility of paying attention when closing a side window.

⚠ WARNING

The reversing feature does not react:

- to soft, light and thin objects, e.g. small fingers
- over the last 1/6 in (4 mm) of the closing movement
- during resetting
- when closing the side window again manually immediately after automatic reversing

This means that the reversing feature cannot prevent someone being trapped in these situations. There is a risk of injury.

Make sure that no body parts are in close proximity during the closing procedure. If

someone becomes trapped, press the switch to open the side window again.

Opening and closing the side windows

The switches for all side windows are located on the driver's door. There is also a switch on each door for the corresponding side window. The switches on the driver's door take precedence.



- ① Front left
- ② Front right
- ③ Rear right
- ④ Rear left

► Turn the SmartKey to position **1** or **2** in the ignition lock.

► **To open:** press the corresponding switch.

► **To close:** pull the corresponding switch.

i If you press/pull the switch beyond the point of resistance, automatic operation is started in the corresponding direction. You can stop automatic operation by pressing/pulling the switch again.

i You can continue to operate the side windows after you switch off the engine or remove the SmartKey. This function is available for up to five minutes or until the driver's or front-passenger door is opened.

i The side windows cannot be operated from the rear when the override feature for the side windows is activated (► page 67).

Convenience opening

General notes

You can ventilate the vehicle before you start driving. To do this, the SmartKey is used to carry out the following functions simultaneously:

- unlock the vehicle
- open the side windows
- open the sliding sunroof or the panorama roof with power tilt/sliding panel and the roller sunblinds
- switch on the seat ventilation for the driver's seat

i The convenience opening feature can only be operated using the SmartKey. The SmartKey must be close to the vehicle. For vehicles without KEYLESS-GO, the SmartKey must be near the driver's door handle.

Convenience opening

► **Vehicles without KEYLESS-GO:** point the tip of the SmartKey at the door handle on the driver's door.

► Press and hold the  button until the side windows and the sliding sunroof or the panorama roof with power tilt/sliding panel are in the desired position.

If the roller sunblinds of the panorama roof with power tilt/sliding panel are closed, the roller sunblinds are opened first.

► Press and hold the  button again until the panorama roof with power tilt/sliding panel is in the desired position.

► **To interrupt convenience opening:** release the  button.

Convenience closing feature

Important safety notes



WARNING

When the convenience closing feature is operating, parts of the body could become trapped

in the closing area of the side window and the sliding sunroof. There is a risk of injury.



Observe the complete closing procedure when the convenience closing feature is operating. Make sure that no body parts are in close proximity during the closing procedure.

When you lock the vehicle, you can simultaneously:

- close the side windows
- close the sliding sunroof or the panorama roof with power tilt/sliding panel

On vehicles with a panorama roof with power tilt/sliding panel, you can then close the roller sunblinds.

Proceed as follows if someone is trapped:

- Release the  button to interrupt the closing procedure.
- Press and hold the  button to open.

Vehicles with KEYLESS-GO:

- Release the sensor surfaces on the exterior door handle to interrupt the closing procedure.
- To open, pull the same door handle immediately and hold it firmly. The door windows and the sliding sunroof will open for as long as the door handle is held but the door is not opened.

i Notes on the automatic reversing feature for:

- the side window (▷ page 94)
- the sliding sunroof (▷ page 98)

Using the SmartKey

The SmartKey must be in the vicinity of the vehicle, on vehicles without KEYLESS-GO the SmartKey must be near the door handle.



► **Vehicles without KEYLESS-GO:** point the tip of the SmartKey at the door handle on the driver's door.

► Press and hold the  button until the side windows and the sliding sunroof or the

panorama roof with power tilt/sliding panel are fully closed.

- ▶ Make sure that all the side windows and the sliding sunroof or panorama roof with power tilt/sliding panel are closed.

On vehicles with a panorama roof with power tilt/sliding panel:

- ▶ Press and hold the  button again until the roller sunblinds of the panorama roof with power tilt/sliding panel close.
- ▶ **To interrupt convenience closing:** release the  button.

Using KEYLESS-GO

The KEYLESS-GO key must be outside the vehicle. All the doors must be closed.



- ▶ Touch recessed sensor surface ① on the door handle until the side windows and the sliding sunroof or the panorama roof with power tilt/sliding panel are fully closed.
- ▶ **i** Make sure you only touch recessed sensor surface ①.
- ▶ Make sure that all the side windows and the sliding sunroof or panorama roof with power tilt/sliding panel are closed.

On vehicles with a panorama roof with power tilt/sliding panel:

- ▶ Touch recessed sensor surface ① on the door handle again until the roller sunblinds of the panorama roof with power tilt/sliding panel close.

- ▶ **To interrupt convenience closing:** release recessed sensor surface ① on the door handle.

Resetting the side windows

If a side window can no longer be closed fully, you must reset it.

- ▶ Close all the doors.
- ▶ Turn the SmartKey to position **1** or **2** in the ignition lock.
- ▶ Pull the corresponding switch on the door control panel until the side window is completely closed. (▶ page 94)
- ▶ Hold the switch for an additional second.

If the side window opens again slightly:

- ▶ Immediately pull the corresponding switch on the door control panel until the side window is completely closed (▶ page 94).
- ▶ Hold the switch for an additional second.
- ▶ If the corresponding side window remains closed after the button has been released, the side window has been reset correctly. If this is not the case, repeat the steps above again.

Problems with the side windows

WARNING

If you close a side window again immediately after it has been blocked or reset, the side window closes with increased or maximum force. The reversing feature is then not active. Parts of the body could be trapped in the closing area in the process. This poses an increased risk of injury or even fatal injury.

Make sure that no parts of the body are in the closing area. To stop the closing process, release the switch or push the switch again to reopen the side window.

Problem	Possible causes/consequences and ► Solutions
A side window cannot be closed because it is blocked by objects, e.g. leaves in the window guide.	<ul style="list-style-type: none"> ► Remove the objects. ► Close the side window.
A side window cannot be closed and you cannot see the cause.	<p>If a side window is obstructed during closing and reopens again slightly:</p> <ul style="list-style-type: none"> ► Immediately after the window blocks, pull the corresponding switch again until the side window has closed. The side window is closed with increased force. <p>If a side window is obstructed again during closing and reopens again slightly:</p> <ul style="list-style-type: none"> ► Immediately after the window blocks, pull the corresponding switch again until the side window has closed. The side window is closed without the anti-entrapment feature.

Sliding sunroof

Important safety notes

Your vehicle may be equipped with a sliding sunroof or a panorama roof with power tilt/sliding panel. In this section, the term "sliding sunroof" refers to both types of sliding sunroof.

WARNING

While opening and closing the sliding sunroof, body parts in close proximity could become trapped. There is a risk of injury.

Make sure that no body parts are in close proximity during the opening and closing procedures.

If somebody becomes trapped:

- release the switch immediately, or
- during automatic operation, push the switch briefly in any direction

The opening or closing procedure will be stopped.

WARNING

If children operate the sliding sunroof they could become trapped, particularly if they are left unsupervised. There is a risk of injury.

When leaving the vehicle, always take the SmartKey with you and lock the vehicle. Never leave children unsupervised in the vehicle.

! Only open the sliding sunroof if it is free of snow and ice. Otherwise, malfunctions may occur.

Do not allow anything to protrude from the sliding sunroof. Otherwise, the seals could be damaged.

i Resonance noises can occur in addition to the usual airflow noises when the sliding sunroof is open. They are caused by minor pressure fluctuations in the vehicle interior. Change the position of the sliding sunroof or open a side window. The noise will be reduced or eliminated.

Sliding sunroof reversing feature

The sliding sunroof is equipped with an automatic reversing feature. If a solid object blocks or restricts the sliding sunroof during the closing process, the sliding sunroof opens again automatically. However, the automatic reversing feature is only an aid and does not relieve you of the responsibility of paying attention when closing the sliding sunroof.

⚠ WARNING

The reversing feature does not react:

- to soft, light and thin objects, e.g. small fingers
- over the last 1/6 in (4 mm) of the closing movement
- during resetting
- when closing the sliding sunroof again manually immediately after automatic reversing

This means that the reversing feature cannot prevent someone being trapped in these situations. There is a risk of injury.

Make sure that no body parts are in close proximity during the closing procedure.

If somebody becomes trapped:

- release the switch immediately, or
- during automatic operation, push the switch briefly in any direction

The closing process is stopped.

Operating the sliding sunroof

Opening and closing



Overhead control panel

- ① To raise
- ② To open
- ③ To close/lower

▶ Turn the SmartKey to position **1** or **2** in the ignition lock.

▶ Press or pull the switch in the corresponding direction.

i If you press the switch beyond the point of resistance, an automatic opening/closing process is started in the corresponding direction. You can stop automatic operation by operating the switch again.

When opening and raising the roof, automatic operation is only available if the sliding sunroof is in the closed position.

The sun protection cover automatically opens along with the sliding sunroof. You can open or close the sun protection cover manually when the sliding sunroof is raised or closed.

i You can continue to operate the sliding sunroof after switching off the engine or removing the SmartKey from the ignition lock. This function is available for up to five minutes or until the driver's or front-passenger door is opened.

Resetting

! If the sliding sunroof still cannot be opened or closed fully after resetting, contact a qualified specialist workshop.

Reset the sliding sunroof if it does not move smoothly.

- ▶ Turn the SmartKey to position **1** or **2** in the ignition lock.
- ▶ Raise the sliding sunroof fully at the rear (▷ page 98).
- ▶ Keep the switch pressed for another second.
- ▶ Make sure that the sliding sunroof can be fully opened and closed again (▷ page 98).
- ▶ If this is not the case, repeat the steps above again.

Operating the panorama roof with power tilt/sliding panel



Overhead control panel

- ① To raise
- ② To open
- ③ To close/lower

The panorama roof with power tilt/sliding panel can only be operated when the roller sunblind is open (▷ page 100).

- ▶ **To open and close:** turn the SmartKey to position **1** or **2** in the ignition lock.
- ▶ Press or pull the switch in the corresponding direction.
- ❗ If you press the switch beyond the point of resistance, an automatic opening/closing process is started in the corresponding direction. You can stop automatic operation by operating the switch again. The automatic raising feature is available only when the sliding sunroof is closed.

Operating the roller sunblinds for the panorama roof with power tilt/sliding panel

Important safety notes

WARNING

When opening or closing the roller sunblind, parts of the body could be trapped between the roller sunblind and the frame or sliding sunroof. There is a risk of injury.

When opening or closing make sure that no parts of the body are in the sweep of the roller sunblind.

If somebody becomes trapped:

- release the switch immediately, or
- during automatic operation, push the switch briefly in any direction

The opening or closing procedure will be stopped.

The roller sunblinds shield the vehicle interior from sunlight. The roller sunblinds can only be opened and closed together when the panorama roof with power tilt/sliding panel is closed.

Roller sunblind reversing feature

The roller sunblinds are equipped with an automatic reversing feature. If a solid object blocks or restricts a roller sunblind during the closing process, the roller sunblind opens again automatically. However, the automatic reversing feature is only an aid and does not relieve you of the responsibility of paying attention when closing the roller sunblinds.

WARNING

The reversing feature especially does not react to soft, light and thin objects such as small fingers. This means that the reversing feature cannot prevent someone being trapped in these situations. There is a risk of injury.

When closing make sure that no parts of the body are in the sweep of the roller sunblind.

If somebody becomes trapped:

- release the switch immediately, or
- during automatic operation, push the switch briefly in any direction

The closing process is stopped.

Opening and closing the roller sunblinds



Overhead control panel

- ① To open
- ② To open
- ③ To close

▶ Turn the SmartKey to position **1** or **2** in the ignition lock.

▶ Press or pull the switch in the corresponding direction.

i If you press/pull the switch beyond the point of resistance, automatic operation is started in the corresponding direction. You can stop automatic operation by pressing/pulling the switch again.

Resetting the panorama roof with power tilt/sliding panel and the roller sunblinds

! If the panorama roof with power tilt/sliding panel and the roller sunblinds cannot be fully opened or closed after resetting, contact a qualified specialist workshop.



Overhead control panel

- ① To open
- ② To open
- ③ To close

Reset the panorama roof with power tilt/sliding panel and the roller sunblinds if the panorama roof with power tilt/sliding panel or the roller sunblinds do not move smoothly.

▶ Turn the SmartKey to position **1** or **2** in the ignition lock.

▶ Pull the switch repeatedly to the point of resistance in the direction of arrow **③** until the panorama roof with power tilt/sliding panel is fully closed.

▶ Keep the switch pulled for an additional second.

▶ Pull the switch repeatedly to the point of resistance in the direction of arrow **③** until the roller sunblinds are fully closed.

▶ Keep the switch pulled for an additional second.

▶ Make sure that the panorama roof with power tilt/sliding panel (▷ page 99) and the roller sunblinds (▷ page 100) can be fully opened again.

▶ If this is not the case, repeat the steps above again.

Problems with the sliding sunroof

Your vehicle may be equipped with a sliding sunroof or a panorama roof with power tilt/sliding panel. In this section, the term "sliding sunroof" refers to both types of sliding sunroof.

WARNING

If you close the sliding sunroof again immediately after it has been blocked or reset, the sliding sunroof closes with increased or maximum force. The reversing feature is then not active. Parts of the body could be trapped in the closing area in the process. This poses an increased risk of injury or even fatal injury.



Make sure that no parts of the body are in the closing area.

If somebody becomes trapped:

- release the switch immediately, or
- during automatic operation, push the switch briefly in any direction

The closing process is stopped.

 If the sliding sunroof still cannot be opened or closed as a result of a malfunction, contact a qualified specialist workshop.

Problem	Possible causes/consequences and ► Solutions
The sliding sunroof cannot be closed and you cannot see the cause.	<p>If the sliding sunroof is obstructed during closing and reopens again slightly:</p> <p>► Immediately after the sliding sunroof blocks, pull the  switch in the overhead control panel down to the point of resistance and hold it until the sliding sunroof is closed. The sliding sunroof is closed with increased force.</p> <p>If the sliding sunroof is obstructed again during closing and then reopens slightly:</p> <p>► Immediately after the sliding sunroof blocks, pull the  switch in the overhead control panel down to the point of resistance and hold it until the sliding sunroof is closed. The sliding sunroof is closed without the anti-entrapment feature.</p>

 Note on the automatic reversing feature of the sliding sunroof (► page 98).

Useful information	104
Correct driver's seat position	104
Seats	105
Steering wheel	111
Mirrors	114
Memory function	116

Useful information

i This Operator's Manual describes all models and all standard and optional equipment of your vehicle available at the time of publication of the Operator's Manual. Country-specific differences are possible. Please note that your vehicle may not be equipped with all features described. This also applies to safety-related systems and functions.

i Read the information on qualified specialist workshops (▷ page 29).

Correct driver's seat position

⚠ WARNING

You could lose control of your vehicle if you do the following while driving:

- adjust the driver's seat, head restraint, steering wheel or mirrors
- fasten the seat belt

There is a risk of an accident.

Adjust the driver's seat, head restraint, steering wheel and mirror and fasten your seat belt before starting the engine.



- ▶ Observe the safety guidelines on seat adjustment (▷ page 105).
- ▶ Make sure that seat ③ is adjusted properly.

Electrical seat adjustment (▷ page 106)

When adjusting the seat, make sure that:

- you are as far away from the driver's air bag as possible.
 - you are sitting in a normal upright position.
 - you can fasten the seat belt properly.
 - you have moved the backrest to an almost vertical position.
 - you have set the seat cushion angle so that your thighs are gently supported.
 - you can depress the pedals properly.
- ▶ Check whether the head restraint is adjusted properly.

When doing so, make sure that you have adjusted the head restraint so that the back of your head is supported at eye level by the center of the head restraint. Also make sure that you have adjusted the head restraint so that the back of your head is as close to the head restraint as possible. This will be the case if the head restraint is adjusted correctly (▷ page 107).

- ▶ Observe the safety guidelines on steering wheel adjustment (▷ page 111).
 - ▶ Make sure that steering wheel ① is adjusted properly.
- Adjusting the steering wheel manually (▷ page 111)
- Adjusting the steering wheel electrically (▷ page 112)

When adjusting the steering wheel, make sure that:

- you can hold the steering wheel with your arms slightly bent.
 - you can move your legs freely.
 - you can see all the displays in the instrument cluster clearly.
- ▶ Observe the safety guidelines for seat belts (▷ page 46).

- ▶ Check whether you have fastened seat belt ② properly (▷ page 48).

The seat belt should:

- fit snugly across your body
 - be routed across the middle of your shoulder
 - be routed in your pelvic area across the hip joints
- ▶ Before starting off, adjust the rear-view mirror and the exterior mirrors in such a way that you have a good view of road and traffic conditions (▷ page 114).
- ▶ **Vehicles with a memory function:** save the seat, steering wheel and exterior mirror settings with the memory function (▷ page 116).

Seats

Important safety notes

WARNING

Children could become trapped if they adjust the seats, particularly when unattended. There is a risk of injury.

When leaving the vehicle, always take the SmartKey with you and lock the vehicle. Never leave children unsupervised in the vehicle.

WARNING

You could lose control of your vehicle if you do the following while driving:

- adjust the driver's seat, head restraint, steering wheel or mirrors
- fasten the seat belt

There is a risk of an accident.

Adjust the driver's seat, head restraint, steering wheel and mirror and fasten your seat belt before starting the engine.

WARNING

If you adjust the seat height carelessly, you or other vehicle occupants could be trapped and thereby injured. Children in particular could

accidentally press the electrical seat adjustment buttons and become trapped. There is a risk of injury.

While moving the seats, make sure that your hands or other body parts do not get under the lever assembly of the seat adjustment system.

WARNING

When you adjust a seat, you or other vehicle occupants could become trapped, e.g. on the seat guide rail. There is a risk of injury.

Make sure when adjusting a seat that no one has any body parts in the sweep of the seat.

WARNING

If head restraints are not installed and adjusted correctly, they cannot provide protection as intended. There is an increased risk of injury in the head and neck area, e.g. in the event of an accident or when braking.

Always drive with the head restraints installed. Before driving off, make sure for every vehicle occupant that the center of the head restraint supports the back of the head at about eye level.

WARNING

The seat belt does not offer the intended level of protection if you have not moved the backrest to an almost vertical position. When braking or in the event of an accident, you could slide underneath the seat belt and sustain abdomen or neck injuries, for example. This poses an increased risk of injury or even fatal injury.

Adjust the seat properly before beginning your journey. Always ensure that the backrest is in an almost vertical position and that the shoulder section of your seat belt is routed across the center of your shoulder.

WARNING

According to accident statistics, children are safer when properly restrained on the rear seats than on the front-passenger seat. Thus,

we strongly recommend that children be placed in the rear seat whenever possible. Regardless of seating position, children 12 years old and under must be seated and properly secured in an appropriately sized child restraint system or booster seat recommended for the size and weight of the child. For additional information, see the "Children in the vehicle" section.

A child's risk of serious or fatal injuries is significantly increased if the child restraints are not properly secured in the vehicle and/or the child is not properly secured in the child restraint.

! To avoid damage to the seats and the seat heating, observe the following information:

- keep liquids from spilling on the seats. If liquid is spilled on the seats, dry them as soon as possible.
- if the seat covers are damp or wet, do not switch on the seat heating. The seat heating should also not be used to dry the seats.
- clean the seat covers as recommended; see "Interior care".
- do not transport heavy loads on the seats. Do not place sharp objects on the seat cushions, e.g. knives, nails or tools. The seats should only be occupied by passengers, if possible.
- when the seat heating is in operation, do not cover the seats with insulating materials, e.g. blankets, coats, bags, seat covers, child seats or booster seats.

! Make sure that there are no objects in the footwell under or behind the seats when moving the seats back. There is a risk that the seats and/or the objects could be damaged.

i It is not possible to remove the head restraints from the front seats. The rear-compartment head restraints, however, can be removed (▷ page 108).

For more information, contact a qualified specialist workshop.

i Further related subjects:

- Important safety notes on air bags (▷ page 50)
- Cargo compartment enlargement (folding down the rear bench seat) (▷ page 337)
- Securing children in the vehicle (▷ page 62)

Adjusting the seats electrically



- ① Head restraint height
- ② Seat cushion angle
- ③ Seat height
- ④ Seat fore-and-aft adjustment
- ⑤ Backrest angle

i Vehicles with memory function: if PRE-SAFE® has been triggered, the front-passenger seat will be moved to a better position if it was previously in an unfavorable position.

i You can store the seat settings using the memory function (▷ page 116).

Adjusting the head restraints

General notes

Pay attention to the important safety notes (▷ page 105).

Do not rotate the head restraints of the front and rear seats. Otherwise, you cannot adjust the height and angle of the head restraints to the correct position.

Adjusting the head restraints manually

Adjusting the head restraint height



- ▶ **To raise:** pull the head restraint up to the desired position.
- ▶ **To lower:** press release catch ① in the direction of the arrow and push the head restraint down to the desired position.

Adjusting the fore/aft position of the head restraint



With this function you can adjust the distance between the head restraint and the back of the seat occupant's head.

- ▶ **To adjust forwards:** pull the head restraint forwards in the direction of the arrow until it engages.

There are several notches.

- ▶ **To move backwards:** press and hold release button ① and push the head restraint backwards.
- ▶ When the head restraint is in the desired position, release the button and make sure that the head restraint is engaged in position.

- ❗ Adjust the head restraint so that the back of your head is as close to the head restraint as possible.

Adjusting the head restraints electrically

- ▶ **To adjust the head restraint height:** slide the switch for head restraint adjustment (▷ page 106) up or down in the direction of the arrow.

Adjusting the luxury head restraints



- ▶ **To adjust the side bolsters of the head restraint:** push or pull right and/or left-hand side bolster ① into the desired position.
- ▶ **To adjust the fore/aft position of the head restraint:** push or pull the head restraint in the direction of arrow ②.

- ❗ Adjust the head restraint so that the back of your head is as close to the head restraint as possible.

Rear seat head restraints

Adjusting the rear seat head restraint height



- ▶ Once the head restraint is fully lowered, press release catch ①.
- ▶ **To raise:** pull the head restraint up to the desired position.
- ▶ **To lower:** press release catch ① and push the head restraint down until it is in the desired position.

Removing and installing the rear seat head restraints

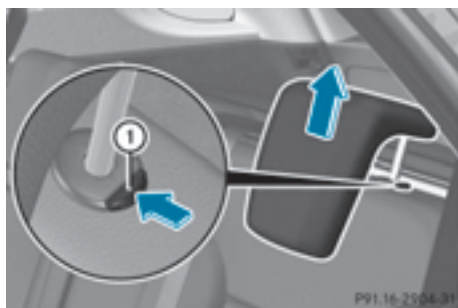

- ▶ **To remove:** pull the head restraint up to the stop.
- ▶ Press release catch ① and pull the head restraint out of the guides.
- ▶ **To re-install:** insert the head restraint so that the notches on the bar are on the left when viewed in the direction of travel.
- ▶ Push the head restraint down until you hear it engage in position.

Adjusting the angle of the rear seat backrests

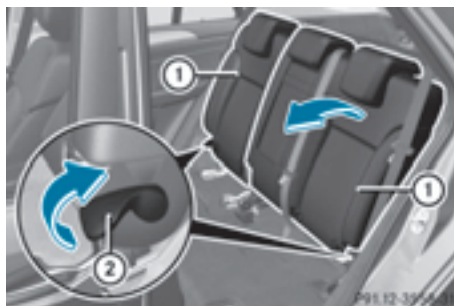

You can adjust the angle of the backrests in the second row of seats. There are ten detent positions to choose from.

- ▶ Pull the left or right release lever ② upwards in the direction of the arrow until relevant backrest ① is fully released.
- ▶ Pull backrest ① forwards in the direction of the arrow and allow it to engage.
- ▶ To ensure that the backrest has engaged, lean firmly against backrest ①.

Adjusting the multicontour seat

You can set the multicontour seat using COMAND. See the separate COMAND Operating Instructions.

Adjusting the 4-way lumbar support

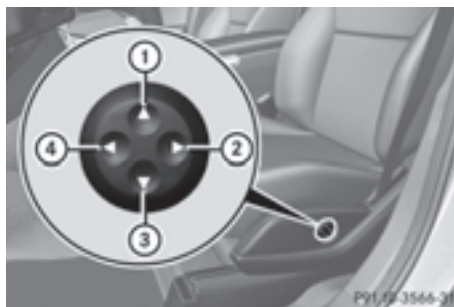

- ① To raise the backrest contour
- ② To soften the backrest contour

- ③ To lower the backrest contour
- ④ To harden the backrest contour

You can adjust the contour of the front seat backrests individually to provide optimum support for your back.

Switching the seat heating on/off

Switching on/off

WARNING

Repeatedly switching on the seat heating can cause the seat cushion and backrest pads to become very hot. The health of persons with limited temperature sensitivity or a limited ability to react to excessively high temperatures may be affected or they may even suffer burn-like injuries. There is a risk of injury.

Therefore, do not switch the seat heating on repeatedly.



Driver's and front-passenger seat

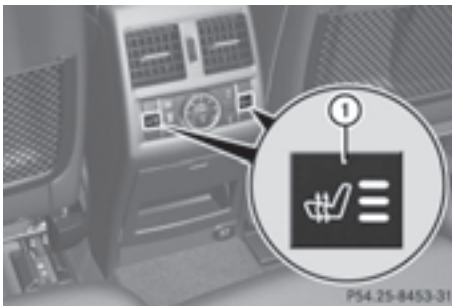

Rear seats

The three red indicator lamps in the button indicate the heating level you have selected. The system automatically switches down from level **3** to level **2** after approximately eight minutes.

The system automatically switches down from level **2** to level **1** after approximately ten minutes.

The system automatically switches off approximately 35 minutes after it is set to level **1**.

- ▶ Turn the SmartKey to position **1** or **2** in the ignition lock (▷ page 157).
 - ▶ **To switch on:** press button ① repeatedly until the desired heating level is set.
 - ▶ **To switch off:** press button ① repeatedly until all the indicator lamps go out.
- i** If the battery voltage is too low, the seat heating may switch off.

Problems with the seat heating

Problem	Possible causes/consequences and ► Solutions
The seat heating has switched off prematurely or cannot be switched on.	<p>The on-board voltage is too low because too many electrical consumers are switched on.</p> <p>► Switch off electrical consumers that you do not need, such as the rear window defroster or interior lighting.</p> <p>Once the battery is sufficiently charged, the seat heating will switch back on automatically.</p>

Switching the seat ventilation on/off

Switching on/off



The three blue indicator lamps in the buttons indicate the ventilation level you have selected.

- Turn the SmartKey to position **2** in the ignition lock (► page 157).
- **To switch on:** press button ① repeatedly until the desired ventilation level is set.
- **To switch off:** press button ① repeatedly until all the indicator lamps go out.

- i** If the battery voltage is too low, the seat ventilation may switch off.
- i** You can open the side windows and the sliding sunroof using the "Convenience opening" feature (► page 95). The seat ventilation of the driver's seat automatically switches to the highest level.

Problems with the seat ventilation

Problem	Possible causes/consequences and ► Solutions
The seat ventilation has switched off prematurely or cannot be switched on.	<p>The on-board voltage is too low because too many electrical consumers are switched on.</p> <p>► Switch off electrical consumers that you do not need, such as the rear window defroster or interior lighting.</p> <p>Once the battery is sufficiently charged, the seat ventilation will switch back on automatically.</p>

Steering wheel

Important safety notes

WARNING

You could lose control of your vehicle if you do the following while driving:

- adjust the driver's seat, head restraint, steering wheel or mirrors
- fasten the seat belt

There is a risk of an accident.

Adjust the driver's seat, head restraint, steering wheel and mirror and fasten your seat belt before starting the engine.

WARNING

Children could injure themselves if they adjust the steering wheel. There is a risk of injury.

When leaving the vehicle, always take the SmartKey with you and lock the vehicle. Never leave children unsupervised in the vehicle.

Adjusting the steering wheel manually

WARNING

If the steering wheel is unlocked while the vehicle is in motion, it could change position unexpectedly. This could cause you to lose control of the vehicle. There is a risk of an accident.

Before starting off, make sure the steering wheel is locked. Never unlock the steering wheel while the vehicle is in motion.



① Release lever

② To adjust the steering wheel height

③ To adjust the steering wheel position (fore-and-aft adjustment)

- Push release lever ① down completely. The steering column is unlocked.
- Adjust the steering wheel to the desired position.
- Push release lever ① up completely. The steering column is locked.
- Check if the steering column is locked. When doing so, try to push the steering wheel up or down or try to move it in the fore-and-aft direction.

Adjusting the steering wheel electrically

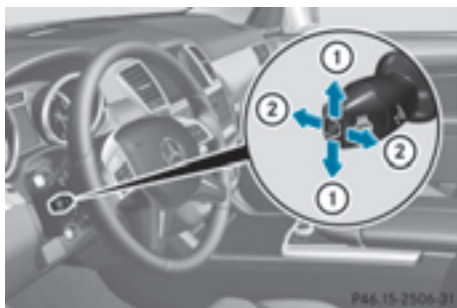

- ① To adjust the steering wheel height
- ② To adjust the steering wheel position (fore-and-aft adjustment)

The steering wheel can also be adjusted when the SmartKey is removed from the ignition lock.

- i Further related subjects:
 - EASY-ENTRY/EXIT feature (▷ page 113)
 - Storing settings (▷ page 116)

Steering wheel heating

Switching on/off

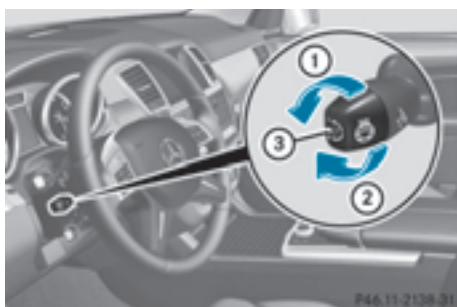

- ▶ Turn the SmartKey to position **2** in the ignition lock (▷ page 157).
- ▶ **To switch on/off:** turn the lever in the direction of arrow ① or ②. Indicator lamp ③ lights up or goes out.

Vehicles without KEYLESS-GO: when you remove the SmartKey from the ignition lock, the steering wheel heating is deactivated.

Vehicles with KEYLESS-GO: when you switch off the ignition and open the driver's door, the steering wheel heating is deactivated.

Problems with the steering wheel heating

Problem	Possible causes/consequences and ► Solutions
The steering wheel heating has switched off prematurely or cannot be switched on.	The on-board voltage is too low because too many electrical consumers are switched on. ► Switch off electrical consumers that you do not need, such as the rear window defroster or interior lighting.

EASY-ENTRY/EXIT feature

Important safety notes

WARNING

When the EASY-ENTRY/EXIT feature adjusts the steering wheel, you and other vehicle occupants – particularly children – could become trapped. There is a risk of injury.

While the EASY-ENTRY/EXIT feature is making adjustments, make sure that no one has any body parts in the sweep of the steering wheel.

Move the steering wheel adjustment lever if there is a risk of entrapment by the steering wheel. The adjustment process is stopped.

Press one of the memory function position buttons. This function is only available on vehicles with memory function.

WARNING

If children activate the EASY-ENTRY/EXIT feature, they can become trapped, particularly when unattended. There is a risk of injury.

When leaving the vehicle, always take the SmartKey with you and lock the vehicle. Never leave children unsupervised in the vehicle.

WARNING

If you drive off while the EASY-ENTRY/EXIT feature is making adjustments, you could lose control of the vehicle. There is a risk of an accident.

Always wait until the adjustment process is complete before driving off.

The EASY-ENTRY/EXIT feature makes getting in and out of your vehicle easier.

You can activate and deactivate the EASY-ENTRY/EXIT feature in the on-board computer (► page 279).

Position of the steering wheel when the EASY-ENTRY/EXIT feature is active

The steering wheel swings upwards when you:

- remove the SmartKey from the ignition lock
- open the driver's door with KEYLESS-GO in position **1**
- open the driver's door and the SmartKey is in position **0** or **1** in the ignition lock

 The steering wheel only moves upwards if it has not already reached the upper stop.

Position of the steering wheel for driving

The steering wheel is moved to the last selected position when:

- the driver's door is closed
- you insert the SmartKey into the ignition lock
- or
- you press the Start/Stop button once on vehicles with KEYLESS-GO

When you close the driver's door with the ignition switched on, the steering wheel is also automatically moved to the previously set position.

The last position of the steering wheel is stored when you switch off the ignition or

when you store the setting with the memory function (▷ page 116).

Crash-responsive EASY-EXIT feature

If the crash-responsive EASY-EXIT feature is triggered in an accident, the steering column will move upwards when the driver's door is opened. This occurs irrespective of the position of the SmartKey in the ignition lock. This makes it easier to exit the vehicle and rescue the occupants.

The crash-responsive EASY-EXIT feature is only operational if the EASY-EXIT/ENTRY feature is activated in the on-board computer (▷ page 279).

Mirrors

Rear-view mirror



- ▶ **Anti-glare mode:** flick anti-glare lever ① forwards or back.

Exterior mirrors

Adjusting the exterior mirrors

WARNING

The exterior mirror on the front-passenger side reduces the size of the image. Visible objects are actually closer than they appear. This means that you could misjudge the distance from road users traveling behind, e.g. when changing lane. There is a risk of an accident.

For this reason, always make sure of the actual distance from the road users traveling behind by glancing over your shoulder.



- ▶ Turn the SmartKey to position **1** or **2** in the ignition lock (▷ page 157).
- ▶ Press button ① for the left-hand exterior mirror or button ② for the right-hand exterior mirror.
The indicator lamp in the corresponding button lights up in red.
The indicator lamp goes out again after some time. You can adjust the selected mirror using adjustment button ③ as long as the indicator lamp is lit.
- ▶ Press adjustment button ③ up, down, or to the left or right until you have adjusted the exterior mirror to the correct position. You should have a good overview of traffic conditions.

The convex exterior mirrors provide a larger field of vision.

The exterior mirrors are heated automatically if the rear window defroster is switched on and the outside temperature is low.

Folding the exterior mirrors in or out electrically



- ▶ Turn the SmartKey to position **1** or **2** in the ignition lock (▷ page 157).
- ▶ Briefly press button ①. Both exterior mirrors fold in or out.
- ❗ Make sure that the exterior mirrors are always folded out fully while driving. They could otherwise vibrate.
- ❗ If you are driving faster than 30 mph (47 km/h), you can no longer fold in the exterior mirrors.

Setting the exterior mirrors

If the battery has been disconnected or completely discharged, the exterior mirrors must be reset. The exterior mirrors will otherwise not fold in when you select the "Fold in mirrors when locking" function in the on-board computer (▷ page 280).

- ▶ Turn the SmartKey to position **1** in the ignition lock (▷ page 157).
- ▶ Briefly press button ①.

Folding the exterior mirrors in or out automatically

If the "Fold in mirrors when locking" function is activated in the on-board computer: (▷ page 280)

- the exterior mirrors fold in automatically as soon as you lock the vehicle from the outside.
- the exterior mirrors fold out again automatically as soon as you unlock the vehicle and then open the driver's or front-passenger door.

Exterior mirror pushed out of position

If an exterior mirror has been pushed out of position, proceed as follows:

- ▶ **Vehicles without electrically folding exterior mirrors:** move the exterior mirror into the correct position manually.
- ▶ **Vehicles with electrically folding exterior mirrors:** press and hold button for folding the mirrors ① (▷ page 115) until you hear a click and then the mirror engage in position. The mirror housing is engaged again and you can adjust the exterior mirrors as usual (▷ page 114).

Automatic anti-glare mirrors

The rear-view mirror and the exterior mirror on the driver's side automatically go into anti-glare mode if the following conditions are met simultaneously:

- the ignition is switched on and
 - incident light from headlamps strikes the sensor in the rear-view mirror.
- ❗ The mirrors do not go into anti-glare mode if reverse gear is engaged or if the interior lighting is switched on.

Parking position for the exterior mirror on the front-passenger side

Setting and storing the parking position

Using reverse gear

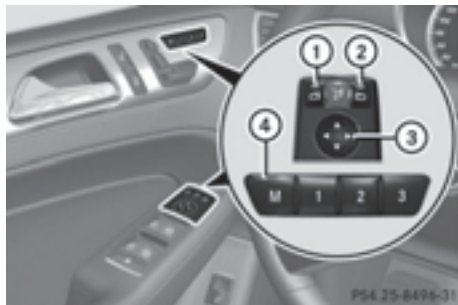

- ① Button for the driver's side exterior mirror
- ② Button for the front-passenger side exterior mirror
- ③ Adjustment button
- ④ Memory button **M**

You can position the front-passenger side exterior mirror in such a way that you can see the rear wheel on that side as soon as you engage reverse gear. You can store this position.

- ▶ Bring the vehicle to a standstill.
- ▶ Turn the SmartKey to position **2** in the ignition lock (▷ page 157).
- ▶ Press button ② for the exterior mirror on the front-passenger side.
- ▶ Engage reverse gear.
The exterior mirror on the front-passenger side moves to the preset parking position.
- ▶ Use adjustment button ③ to adjust the exterior mirror to a position that allows you to see the rear wheel and the curb.
The parking position is stored.
- i** If you shift the transmission to another position, the exterior mirror on the front-passenger side returns to the driving position.

Using the memory button

You can position the front-passenger side exterior mirror in such a way that you can see the rear wheel on that side as soon as you engage reverse gear. This setting can be stored using memory button **M** ④.

- ▶ Turn the SmartKey to position **2** in the ignition lock (▷ page 157).
- ▶ With the exterior mirror on the front-passenger side activated, use adjustment button ③ to adjust the exterior mirror. In the exterior mirror, the rear wheel and the curb should be visible.
- ▶ Press memory button **M** ④ and one of the arrows on adjustment button ③ within three seconds.
The parking position is stored if the exterior mirror does not move.
- ▶ If the mirror moves out of position, repeat the steps.

Calling up a stored parking position setting

- ▶ Turn the SmartKey to position **2** in the ignition lock (▷ page 157).
- ▶ Adjust the exterior mirror on the front-passenger side using button ②.
- ▶ Engage reverse gear.
The exterior mirror on the front-passenger side moves to the stored parking position.

The exterior mirror on the front-passenger side moves back to its original position:

- as soon as you exceed a speed of 9 mph (15 km/h)
- if you press button ① for the exterior mirror on the driver's side

Memory function

Storing settings

WARNING

If you use the memory function on the driver's side while driving, you could lose control of

the vehicle as a result of the adjustments being made. There is a risk of an accident. Only use the memory function on the driver's side when the vehicle is stationary.

WARNING

When the memory function adjusts the seat or steering wheel, you and other vehicle occupants – particularly children – could become trapped. There is a risk of injury.

While the memory function is making adjustments, make sure that no one has any body parts in the sweep of the seat or steering wheel. If somebody becomes trapped, immediately release the memory function position button. The adjustment process is stopped.

WARNING

Children could become trapped if they activate the memory function, particularly when unattended. There is a risk of injury.

When leaving the vehicle, always take the SmartKey with you and lock the vehicle. Never leave children unsupervised in the vehicle.

With the memory function, you can store up to three different settings, e.g. for three different people.

The following settings are stored as a single memory preset:

- position of the seat, backrest and head restraint
- driver's side: steering wheel position
- driver's side: position of the exterior mirrors on the driver's and front-passenger sides



- ▶ Adjust the seat (▷ page 106).
- ▶ On the driver's side, adjust the steering wheel (▷ page 112) and the exterior mirrors (▷ page 114).
- ▶ Press the **M** memory button and then press one of the storage position buttons **1**, **2** or **3** within three seconds. The settings are stored in the selected preset position. A tone sounds when the settings have been completed.

The memory function can still be used if the SmartKey has been removed.

Calling up a stored setting

- ▶ Press the button for storage position **1**, **2** or **3**. Keep pressing until the seat, steering wheel and exterior mirrors are in the stored position.
-  The setting procedure is interrupted as soon as you release the storage position buttons.

Useful information	120
Exterior lighting	120
Interior lighting	127
Replacing bulbs	129
Windshield wipers	132

Useful information

i This Operator's Manual describes all models and all standard and optional equipment of your vehicle available at the time of publication of the Operator's Manual. Country-specific differences are possible. Please note that your vehicle may not be equipped with all features described. This also applies to safety-related systems and functions.

i Read the information on qualified specialist workshops (▷ page 29).

Exterior lighting

General notes

For reasons of safety, Mercedes-Benz recommends that you drive with the lights switched on even during the daytime. In some countries, operation of the headlamps varies due to legal requirements and self-imposed obligations.

Driving abroad

Conversion to symmetrical low beam

Switch the headlamps to symmetrical low beam in countries in which traffic drives on the opposite side of the road from the country where the vehicle is registered. This prevents glare to oncoming traffic. When using symmetrical lights, the edge of the road is not lit as widely and as far ahead as normal.

Have the headlamps converted at a qualified specialist workshop as close to the border as possible before driving in these countries.

Conversion to asymmetrical low beam after returning

Have the headlamps converted back to asymmetrical low-beam headlamps at a qualified specialist workshop as soon as possible after crossing the border again.

Setting the exterior lighting

Setting options

Exterior lighting can be set using:

- the light switch
- the combination switch (▷ page 123)
- the on-board computer (▷ page 277)

Light switch

Operation



- 1** Left-hand standing lamps
- 2** Right-hand standing lamps
- 3** Parking lamps, license plate and instrument cluster lighting
- 4** **AUTO** Automatic headlamp mode, controlled by the light sensor
- 5** Low-beam/high-beam headlamps
- 6** Rear fog lamp

If you hear a warning tone when you leave the vehicle, the lights may still be switched on.

► Turn the light switch to **AUTO**.

The exterior lighting (except the parking/standing lamps) switches off automatically if you:

- remove the SmartKey from the ignition lock
- open the driver's door with the SmartKey in position 0.

Automatic headlamp mode

WARNING







When the light switch is set to **AUTO**, the low-beam headlamps may not be switched on

automatically if there is fog, snow or other causes of poor visibility due to the weather conditions such as spray. There is a risk of an accident.

In such situations, turn the light switch to .

The automatic headlamp feature is only an aid. The driver is responsible for the vehicle's lighting at all times.



- 1  Left-hand standing lamps
- 2  Right-hand standing lamps
- 3  Parking lamps, license plate and instrument cluster lighting
- 4  Automatic headlamp mode, controlled by the light sensor
- 5  Low-beam/high-beam headlamps
- 6  Rear fog lamp

AUTO is the favored light switch setting. The light setting is automatically selected according to the brightness of the ambient light (exception: poor visibility due to weather conditions such as fog, snow or spray):



- SmartKey in position **1** in the ignition lock: the parking lamps are switched on or off automatically depending on the brightness of the ambient light.
- With the engine running: if you have activated the daytime running lamps function via the on-board computer, the daytime running lamps or the low-beam headlamps and parking lamps are switched on or off automatically depending on the brightness of the ambient light.

► **To switch on automatic headlamp mode:** turn the light switch to **AUTO**.

Only for Canada:



The daytime running lamps improve the visibility of your vehicle during the day. The daytime running lamps function is required by law in Canada. It cannot therefore be deactivated.

When the engine is running and the vehicle is stationary: if you move the selector lever from a drive position to **P**, the daytime running lamps/low-beam headlamps go out after three minutes.

When the engine is running, the vehicle is stationary and in bright ambient light: if you turn the light switch to , the daytime running lamps and parking lamps switch on. If the engine is running and you turn the light switch to , the manual settings take precedence over the daytime running lamps.

USA only:

The daytime running lamps improve the visibility of your vehicle during the day. To do this, the daytime running lamps function must be switched on using the on-board computer (> page 277).

If the engine is running and you turn the light switch to  or , the manual settings take precedence over the daytime running lamps.

- i** In the USA, the daytime running lamps are deactivated upon delivery from the factory.

Low-beam headlamps

WARNING

When the light switch is set to **AUTO**, the low-beam headlamps may not be switched on automatically if there is fog, snow or other causes of poor visibility due to the weather conditions such as spray. There is a risk of an accident.

In such situations, turn the light switch to .



- 1 Left-hand standing lamps
- 2 Right-hand standing lamps
- 3 Parking lamps, license plate and instrument cluster lighting
- 4 **AUTO** Automatic headlamp mode, controlled by the light sensor
- 5 Low-beam/high-beam headlamps
- 6 Rear fog lamp

Even if the light sensor does not detect that it is dark, the parking lamps and low-beam headlamps switch on when the ignition is switched on and the light switch is set to the position. This is a particularly useful function in the event of rain and fog.

- ▶ **To switch on the low-beam headlamps:** turn the SmartKey in the ignition lock to position 2 or start the engine.
- ▶ Turn the light switch to . The green indicator lamp in the instrument cluster lights up.

Rear fog lamp



- 1 Left-hand standing lamps
- 2 Right-hand standing lamps

- 3 Parking lamps, license plate and instrument cluster lighting
- 4 **AUTO** Automatic headlamp mode, controlled by the light sensor
- 5 Low-beam/high-beam headlamps
- 6 Rear fog lamp

The rear fog lamp improves visibility of your vehicle for the traffic behind in the event of thick fog. Please take note of the country-specific regulations for the use of rear fog lamps.

- ▶ **To switch on the rear fog lamps:** turn the SmartKey in the ignition lock to position 2 or start the engine.
- ▶ Turn the light switch to or **AUTO**.
- ▶ Press the button. The yellow indicator lamp in the instrument cluster lights up.
- ▶ **To switch off the rear fog lamp:** press the button. The yellow indicator lamp in the instrument cluster goes out.

Parking lamps

- ⚠ If the battery has been excessively discharged, the parking lamps or standing lamps are automatically switched off to enable the next engine start. Always park your vehicle safely and sufficiently lit according to legal standards. Avoid the continuous use of the parking lamps for several hours. If possible, switch on the right or the left standing lamp.



- 1 Left-hand standing lamps
- 2 Right-hand standing lamps
- 3 Parking lamps, license plate and instrument cluster lighting
- 4 **AUTO** Automatic headlamp mode, controlled by the light sensor
- 5 Low-beam/high-beam headlamps
- 6 Rear fog lamp

► **To switch on:** turn the light switch to . The green indicator lamp in the instrument cluster lights up.

Standing lamps



- 1 Left-hand standing lamps
- 2 Right-hand standing lamps
- 3 Parking lamps, license plate and instrument cluster lighting
- 4 **AUTO** Automatic headlamp mode, controlled by the light sensor
- 5 Low-beam/high-beam headlamps
- 6 Rear fog lamp

Switching on the standing lamps ensures the corresponding side of the vehicle is illuminated.

- **To switch on the standing lamps:** the SmartKey is not in the ignition lock or it is in position **0**.
- Turn the light switch to (left-hand side of the vehicle) or (right-hand side of the vehicle).

Combination switch

Turn signal

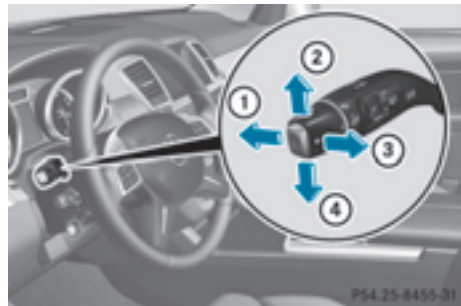

- ① High-beam headlamps
- ② Turn signal, right
- ③ High-beam flasher
- ④ Turn signal, left

- **To indicate briefly:** press the combination switch briefly to the pressure point in the direction of arrow ② or ④. The corresponding turn signal flashes three times.
- **To indicate:** press the combination switch beyond the pressure point in the direction of arrow ② or ④.

High-beam headlamps

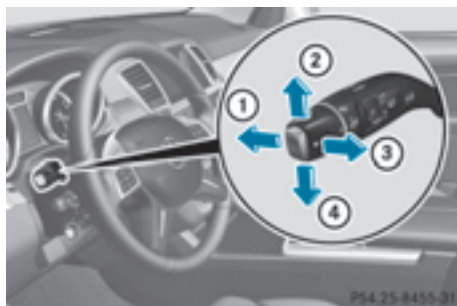

- ① High-beam headlamps
- ② Turn signal, right
- ③ High-beam flasher
- ④ Turn signal, left

► **To switch on the high-beam headlamps:** turn the SmartKey in the ignition lock to position **2** or start the engine.

► Turn the light switch to  or **AUTO**.

► Press the combination switch beyond the pressure point in the direction of arrow ①. In the **AUTO** position, the high-beam headlamps are only switched on when it is dark and the engine is running.

The blue  indicator lamp in the instrument cluster lights up when the high-beam headlamps are switched on.

► **To switch off the high-beam headlamps:** move the combination switch back to its normal position.

The blue  indicator lamp in the instrument cluster goes out.

i Vehicles with Adaptive Highbeam Assist: when Adaptive Highbeam Assist is active, it controls activation of the high-beam headlamps (► page 126).

High-beam flasher

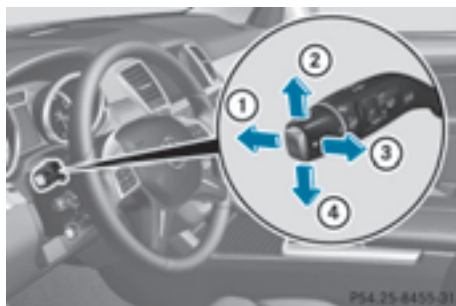

- ① High-beam headlamps
- ② Turn signal, right
- ③ High-beam flasher
- ④ Turn signal, left

► **To switch on:** turn the SmartKey in the ignition lock to position **1** or **2** or start the engine.

► Pull the combination switch in the direction of arrow ③.

Hazard warning lamps



► **To switch on the hazard warning lamps:** press button ①.

All turn signals flash. If you now switch on a turn signal using the combination switch, only the turn signal lamp on the corresponding side of the vehicle will flash.

► **To switch off the hazard warning lamps:** press button ①.

The hazard warning lamps automatically switch on if:

- an air bag is deployed or
- the vehicle decelerates rapidly from a speed of above 45 mph (70 km/h) and comes to a standstill

The hazard warning lamps switch off automatically if the vehicle reaches a speed of above 6 mph (10 km/h) again after a full brake application.

- ❗ The hazard warning lamps still operate if the ignition is switched off.

Headlamp cleaning system

The headlamps are cleaned automatically if the "Wipe with washer fluid" function is operated five times (▷ page 132) while the lights are on and the engine is running. When you switch off the ignition, the automatic headlamp cleaning system is reset and counting is resumed from 0.

Active light function



The active light function is a system that moves the headlamps according to the steering movements of the front wheels. In this way, relevant areas remain illuminated while driving. This allows you to recognize pedestrians, cyclists and animals.

Active: when the lights are switched on.

Cornering light function



The cornering light function improves the illumination of the road over a wide angle in the direction you are turning, enabling better visibility in tight bends, for example. It can only be activated when the low-beam headlamps are switched on.

Active:

- if you are driving at speeds below 25 mph (40 km/h) and switch on the turn signal or turn the steering wheel
- if you are driving at speeds between 25 mph (40 km/h) and 45 mph (70 km/h) and turn the steering wheel

The cornering lamp may remain lit for a short time, but is automatically switched off after no more than three minutes.

Adaptive Highbeam Assist

General notes



You can use this function to set the headlamps to change between low beam and high beam automatically. The system recognizes vehicles with their lights on, either approaching from the opposite direction or traveling in front of your vehicle, and consequently switches the headlamps from high beam to low beam.

The system automatically adapts the low-beam headlamp range depending on the distance to the other vehicle. Once the system no longer detects any other vehicles, it reactivates the high-beam headlamps.

The system's optical sensor is located behind the windshield near the overhead control panel.

Important safety notes

WARNING

Adaptive Highbeam Assist does not recognize road users:

- who have no lights, e.g. pedestrians
- who have poor lighting, e.g. cyclists
- whose lighting is blocked, e.g. by a barrier

In very rare cases, Adaptive Highbeam Assist may fail to recognize other road users that

have lights, or may recognize them too late. In this or similar situations, the automatic high-beam headlamps will not be deactivated or activated regardless. There is a risk of an accident.

Always carefully observe the traffic conditions and switch off the high-beam headlamps in good time.

Adaptive Highbeam Assist cannot take into account road, weather or traffic conditions. Adaptive Highbeam Assist is only an aid. You are responsible for adjusting the vehicle's lighting to the prevailing light, visibility and traffic conditions.

In particular, the detection of obstacles can be restricted if there is:

- poor visibility, e.g. due to fog, heavy rain or snow
- dirt on the sensors or the sensors are obscured

Switching Adaptive Highbeam Assist on/off

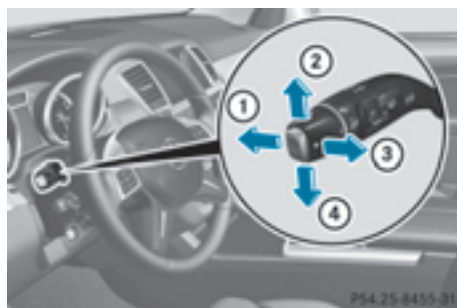

- ① High-beam headlamps
- ② Turn signal, right
- ③ High-beam flasher
- ④ Turn signal, left

- **To switch on:** turn the light switch to **AUTO**.
- Press the combination switch beyond the pressure point in the direction of arrow ①. The  indicator lamp in the multifunction display lights up when it is dark and the

light sensor activates the low-beam headlamps.



If you are driving at speeds above approximately 16 mph (25 km/h):

The headlamp range is set automatically depending on the distance between the vehicle and other road users.

If you are driving at speeds above approximately 19 mph (30 km/h) and no other road users have been detected:

The high-beam headlamps are switched on automatically. The  indicator lamp in the instrument cluster also lights up.

If you are driving at speeds below approximately 16 mph (25 km/h) or other road users have been detected or the roads are adequately lit:

The high-beam headlamps are switched off automatically. The  indicator lamp in the instrument cluster goes out. The  indicator lamp in the multifunction display remains lit.

- ▶ **To switch off:** move the combination switch back to its normal position or move the light switch to another position. The  indicator lamp in the multifunction display goes out.

Headlamps fogged up on the inside





Certain climatic and physical conditions may cause moisture to form in the headlamp. This moisture does not affect the functionality of the headlamp.

Interior lighting

Overview of interior lighting



Overhead control panel

- ①  To switch the left-hand front reading lamp on/off
- ②  To switch the front interior lighting on
- ③  To switch the on/off
- ④  To switch the front interior lighting/automatic interior lighting control off
- ⑤  To switch the right-hand front reading lamp on/off
- ⑥ To switch the automatic interior lighting control on

Interior lighting control

General notes





In order to prevent the vehicle's battery from discharging, the interior lighting functions are automatically deactivated after some time except for when the SmartKey is in position **2** in the ignition lock.

The color and brightness of the ambient lighting can be adjusted using the on-board computer (▷ page 278).

Automatic interior lighting control



Overhead control panel

- ①  To switch the left-hand front reading lamp on/off
- ②  To switch the front interior lighting on
- ③  To switch the rear interior lighting on/off
- ④  To switch the front interior lighting/automatic interior lighting control off
- ⑤  To switch the right-hand front reading lamp on/off
- ⑥ To switch the automatic interior lighting control on

► **To switch on:** set the switch to center position ⑥.

► **To switch off:** set the switch to the  position.

The interior lighting automatically switches on if you:





- unlock the vehicle
- open a door
- remove the SmartKey from the ignition lock.

The interior light is activated for a short while when the SmartKey is removed from the ignition lock. You can activate this delayed switch-off using the on-board computer (> page 279).

Manual interior lighting control



Overhead control panel

- ①  To switch the left-hand front reading lamp on/off
- ②  To switch the front interior lighting on
- ③  To switch the rear interior lighting on/off
- ④  To switch the front interior lighting/automatic interior lighting control off
- ⑤  To switch the right-hand front reading lamp on/off
- ⑥ To switch the automatic interior lighting control on

► **To switch the front interior lighting on:** set the switch to the  position.

► **To switch the interior lighting off:** set the switch to the  position or (if the door is closed) to the center position.

► **To switch the rear interior lighting on/off:** press the  button.

► **To switch the reading lamps on/off:** press the  button.

Crash-responsive emergency lighting

The interior lighting is activated automatically if the vehicle is involved in an accident.

► **To switch off the crash-responsive emergency lighting:** press the hazard warning lamp button.

or

► Lock and then unlock the vehicle using the SmartKey.

Replacing bulbs

Important safety notes

DANGER

Xenon bulbs carry a high voltage. You can get an electric shock if you remove the cover of the Xenon bulb and touch the electrical contacts. There is a risk of fatal injury.

Never touch the parts or the electrical contacts of the Xenon bulb. Always have work on the Xenon bulbs carried out at a qualified specialist workshop.

If your vehicle is equipped with Xenon bulbs, you can recognize this by the following: the cone of light from the Xenon bulbs moves from the top to the bottom and back again when you start the engine. For this to be observed, the lights must be switched on before starting the engine.

WARNING

Bulbs, lamps and connectors can get very hot when operating. If you change a bulb, you could burn yourself on these components. There is a risk of injury.

Allow these components to cool down before changing a bulb.

Do not use a bulb that has been dropped or if its glass tube has been scratched.

The bulb may explode if:

- you touch it
- it is hot

- you drop it
- you scratch it

Only operate bulbs in enclosed lamps designed for that purpose. Only install spare bulbs of the same type and the specified voltage.

Marks on the glass tube reduce the service life of the bulbs. Do not touch the glass tube with your bare hands. If necessary, clean the glass tube when cold with alcohol or spirit and rub it off with a lint-free cloth.

Protect bulbs from moisture during operation. Do not allow bulbs to come into contact with liquids.

There are bulbs other than the Xenon bulbs that you cannot replace. Replace only the bulbs listed (▷ page 129). Have the bulbs that you cannot replace yourself changed at a qualified specialist workshop.

If you require assistance changing bulbs, consult a qualified specialist workshop.

If the new bulb still does not light up, consult a qualified specialist workshop.

Bulbs and lamps are an important aspect of vehicle safety. You must therefore make sure that these function correctly at all times.

Have the headlamp setting checked regularly.

Overview: changing bulbs/bulb types

You can change the following bulbs. The bulb type can be found in the legend.

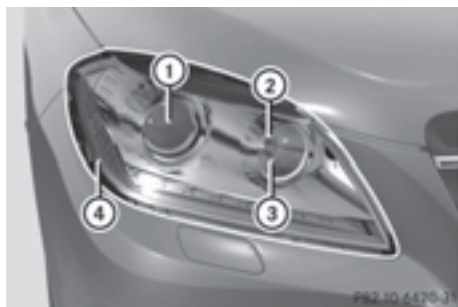

Halogen headlamps

- ① Low-beam headlamp: H7 55 W
- ② High-beam headlamp: H7 55 W
- ③ Parking lamp/standing lamp: W 5 W BV
- ④ Side marker lamp: WY 5 W

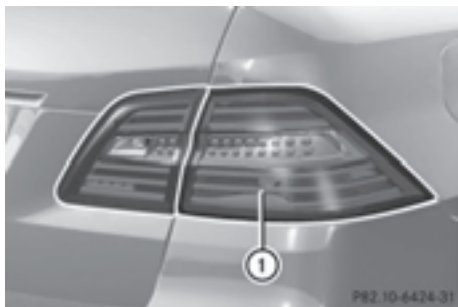

Tail lamp

- ① Brake lamp: P 21 W-L

Changing the front bulbs

Removing and installing the cover in the front wheel housing

You must remove the cover from the front wheel housing before you can change the front bulbs.



- ▶ **To remove:** switch off the lights.
- ▶ Turn the front wheels inwards.
- ▶ Remove securing pin ② using a suitable tool.
- ▶ Slide cover ① up and remove it.
- ▶ **To install:** insert cover ① again and slide it down until it engages.
- ▶ Insert securing pin ②.

Low-beam headlamps (halogen headlamps)

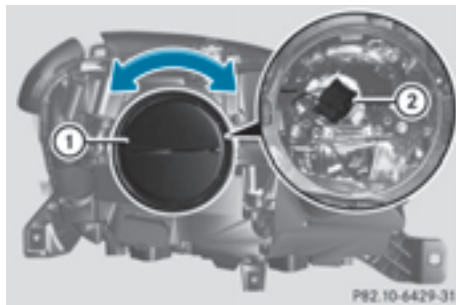

- ▶ Remove the cover in the front wheel housing (▷ page 130).
- ▶ Turn housing cover ① counter-clockwise and pull it out.
- ▶ Turn bulb holder ② counter-clockwise and pull it out.
- ▶ Take the bulb out of bulb holder ②.
- ▶ Insert the new bulb into bulb holder ②.
- ▶ Insert bulb holder ② into the lamp and turn it clockwise.

- ▶ Align housing cover ① and turn it clockwise until it engages.
- ▶ Replace the cover in the front wheel housing (▷ page 130).

High-beam headlamps (halogen headlamps)

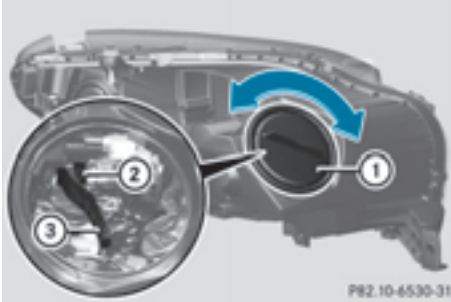

- ▶ Switch off the lights.
- ▶ Open the hood.
- ▶ Turn housing cover ① counter-clockwise and pull it out.
- ▶ Pull lever ③ upwards and remove bulb holder ②.
- ▶ Take the bulb out of bulb holder ②.
- ▶ Insert the new bulb into bulb holder ②.
- ▶ Simultaneously press bulb holder ② and pull lever ③ downwards.
- ▶ Align housing cover ① and turn it clockwise until it engages.

Parking lamps/standing lamps (halogen headlamps)

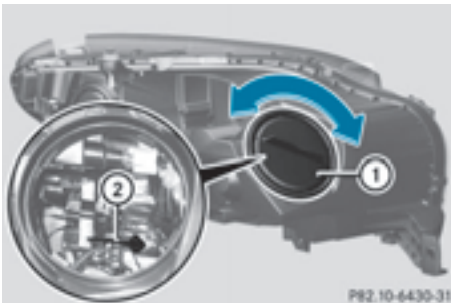

- ▶ Switch off the lights.
- ▶ Open the hood.
- ▶ Turn housing cover ① counter-clockwise and pull it out.
- ▶ Pull out bulb holder ②.
- ▶ Take the bulb out of bulb holder ②.
- ▶ Insert the new bulb into bulb holder ②.
- ▶ Insert bulb holder ②.
- ▶ Align housing cover ① and turn it clockwise until it engages.

Side marker lamps

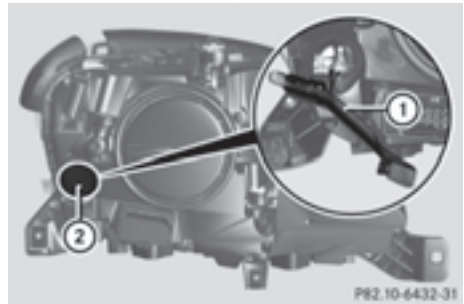

- ▶ Remove the cover in the front wheel housing (▷ page 130).
- ▶ Turn cap ② counter-clockwise and remove it.
- ▶ Pull out bulb holder ①.
- ▶ Take the bulb out of bulb holder ①.
- ▶ Insert the new bulb into bulb holder ①.
- ▶ Insert bulb holder ①.
- ▶ Align cap ② and turn it clockwise until it engages.
- ▶ Replace the cover in the front wheel housing (▷ page 130).

Changing the rear bulbs

Opening and closing the service flap



Left-hand service flap



Right-hand service flap

You must open the service flap in the cargo compartment before you can change the bulbs in the brake lamp.

- ▶ **To open:** release service flap ① at the top, e.g. with a screwdriver, and swing it downward in the direction of the arrow.
- ▶ Right side: remove the first-aid kit beforehand and pull the parcel net down.
- ▶ **To close:** reinsert service flap ①.

Brake lamp

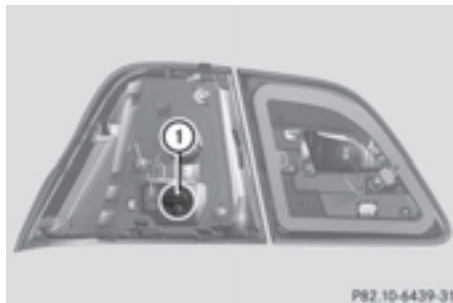

- ▶ Switch off the lights.
- ▶ Open the cargo compartment.
- ▶ Open the service flap (> page 132).
- ▶ Turn bulb holder ① counter-clockwise and remove it.
- ▶ Take bulb out of bulb holder ①.
- ▶ Insert the new bulb into bulb holder ①.
- ▶ Insert bulb holder ① into the lamp and turn it clockwise.
- ▶ Close the service flap (> page 132).

Windshield wipers

Switching the windshield wipers on/off

- ⚠ Do not operate the windshield wipers when the windshield is dry, as this could damage the wiper blades. Moreover, dust that has collected on the windshield can scratch the glass if wiping takes place when the windshield is dry.

If it is necessary to switch on the windshield wipers in dry weather conditions, always use washer fluid when operating the windshield wipers.

- ⚠ If the windshield wipers leave smears on the windshield after the vehicle has been washed in an automatic car wash, wax or other residues may be the reason for this. Clean the windshield using washer fluid after washing the vehicle in an automatic car wash.

! Intermittent wiping with rain sensor: due to optical influences and the windshield becoming dirty in dry weather conditions, the windshield wipers may be activated inadvertently. This could then damage the windshield wiper blades or scratch the windshield.

For this reason, you should always switch off the windshield wipers in dry weather.

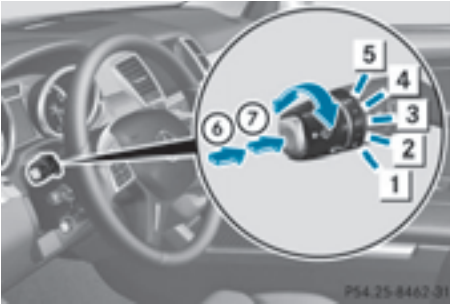

Combination switch

- 1 **0** Windshield wiper off
- 2 **...** Intermittent wipe, low (rain sensor set to low sensitivity)
- 3 **....** Intermittent wipe, high (rain sensor set to high sensitivity)
- 4 **—** Continuous wipe, slow
- 5 **==** Continuous wipe, fast
- 6 Single wipe
- 7 To wipe with washer fluid

► Switch on the ignition.

► Turn the combination switch to the corresponding position.

In the **...** or **....** position, the appropriate wiping frequency is set automatically according to the intensity of the rain. In the **....** position, the rain sensor is more sensitive than in the **...** position, causing the windshield wipers to wipe more frequently.

If the wiper blades are worn, the windshield will no longer be wiped properly. This could prevent you from observing the traffic conditions.

Switching the rear window wiper on/off

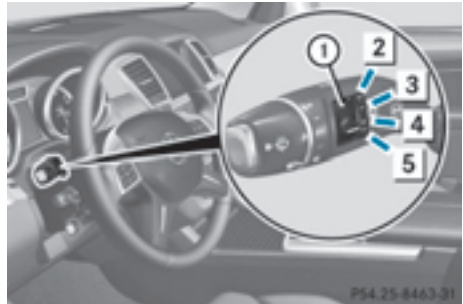

Combination switch

- ① Rear window wiper switch
- 2 To wipe with washer fluid
- 3 **I** To switch on intermittent wiping
- 4 **0** To switch off intermittent wiping
- 5 To wipe with washer fluid

► Turn the SmartKey to position **1** or **2** in the ignition lock (▷ page 157).

► Turn switch ① on the combination switch to the corresponding position.

When the rear window wiper is switched on, the icon appears in the instrument cluster.

Replacing the wiper blades

Important safety notes

WARNING

If the windshield wipers begin to move while you are changing the wiper blades, you could be trapped by the wiper arm. There is a risk of injury.

Always switch off the windshield wipers and ignition before changing the wiper blades.

! Never open the hood/tailgate if a wiper arm has been folded away from the windshield/rear window.

Never fold a windshield wiper arm without a wiper blade back onto the windshield/rear window.

Hold the windshield wiper arm firmly when you change the wiper blade. If you release the wiper arm without a wiper blade and it falls onto the windshield/rear window, the windshield/rear window may be damaged by the force of the impact.

Mercedes-Benz recommends that you have the wiper blades changed at a qualified specialist workshop.

- ❗ To avoid damaging the wiper blades, make sure that you touch only the wiper arm of the wiper.

Changing the windshield wiper blades

Removing the wiper blades

- ▶ Remove the SmartKey from the ignition lock.
- ▶ Fold the wiper arm away from the windshield.



- ▶ Firmly press release knob ① and pull wiper blade ② upwards from the wiper arm in the direction of the arrow.

Installing the wiper blades



- ▶ Position new wiper blade ① in the retainer on the wiper arm and slide it into place in the direction of the arrow. The wiper blade audibly engages.
- ▶ Make sure that the wiper blade is seated correctly.
- ▶ Fold the wiper arm back onto the windshield.

Replacing the rear window wiper blade

Removing a wiper blade



- ▶ Remove the SmartKey from the ignition lock.
- ▶ Fold wiper arm ① away from the rear window until it engages.
- ▶ Position wiper blade ② at a right angle to wiper arm ①.
- ▶ Hold wiper arm ① and press wiper blade ② in the direction of the arrow until it releases.
- ▶ Remove wiper blade ②.

Installing a wiper blade

- ▶ Place new wiper blade ② onto wiper arm ①.
- ▶ Hold wiper arm ① and press wiper blade ② in the opposite direction to the arrow until it engages.
- ▶ Make sure that wiper blade ② is seated correctly.
- ▶ Position wiper blade ② parallel to wiper arm ①.
- ▶ Fold wiper arm ① back onto the rear window.

Problems with the windshield wipers

Problem	Possible causes/consequences and ► Solutions
The windshield wipers are jammed.	<p>Leaves or snow, for example, may be obstructing the windshield wiper movement. The wiper motor has been deactivated.</p> <ul style="list-style-type: none"> ► For safety reasons, you should remove the SmartKey from the ignition lock. <p>or</p> <ul style="list-style-type: none"> ► Switch off the engine using the Start/Stop button and open the driver's door. ► Remove the cause of the obstruction. ► Switch the windshield wipers back on.
The windshield wipers fail completely.	<p>The windshield wiper drive is malfunctioning.</p> <ul style="list-style-type: none"> ► Select another wiper speed on the combination switch. ► Have the windshield wipers checked at a qualified specialist workshop.

Useful information	138
Overview of climate control systems	138
Operating the climate control systems	144
Setting the air vents	152

Useful information

- i** This Operator's Manual describes all models and all standard and optional equipment of your vehicle available at the time of publication of the Operator's Manual. Country-specific differences are possible. Please note that your vehicle may not be equipped with all features described. This also applies to safety-related systems and functions.
- i** Read the information on qualified specialist workshops (▷ page 29).

Overview of climate control systems

General notes

Observe the settings recommended on the following pages. The windows could otherwise fog up.

To prevent the windows from fogging up:

- switch off climate control only briefly
- switch on air-recirculation mode only briefly
- switch on the cooling with air dehumidification function
- switch on the defrost windshield function briefly, if required

Climate control regulates the temperature and the humidity in the vehicle interior and filters undesirable substances out of the air.

Climate control can only be operated when the engine is running. Optimum operation is only achieved with the side windows and roof closed.

The residual heat function can only be activated or deactivated with the ignition switched off (▷ page 151).

- i** Ventilate the vehicle for a brief period during warm weather, e.g. using the convenience opening feature (▷ page 95). This will speed up the cooling process and the desired interior temperature will be reached more quickly.

- i** The integrated filter filters out most particles of dust and soot and completely filters out pollen. It also reduces gaseous pollutants and odors. A clogged filter reduces the amount of air supplied to the vehicle interior. For this reason, you should always observe the interval for replacing the filter, which is specified in the Maintenance Booklet. As it depends on environmental conditions, e.g. heavy air pollution, the interval may be shorter than stated in the Maintenance Booklet.
- i** It is possible that the residual heat function may be activated automatically an hour after the SmartKey has been removed in order to dry the air-conditioning system. The vehicle is then ventilated for 30 minutes.

Control panel for dual-zone automatic climate control

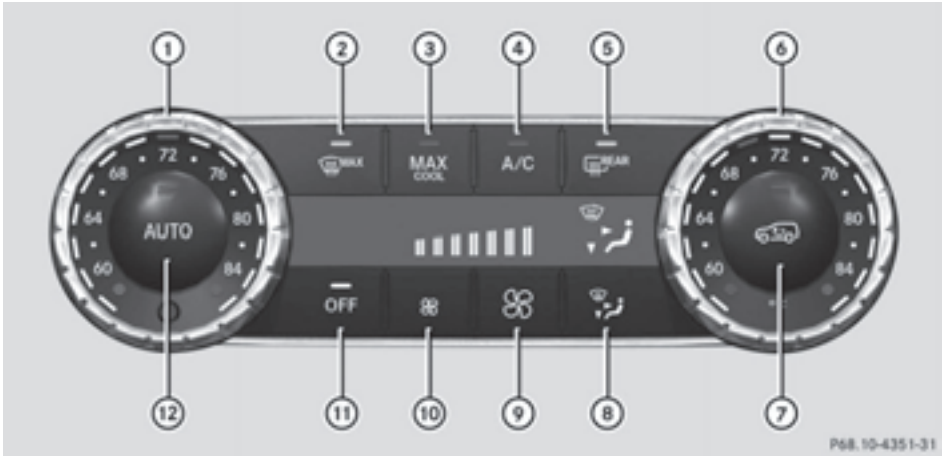

USA only

Front control panel

- ① To set the temperature, left (▷ page 147)
- ② To defrost the windshield (▷ page 149)
- ③ To switch maximum cooling on/off (▷ page 149)
- ④ To switch cooling with air dehumidification on/off (▷ page 144)
- ⑤ To switch the rear window defroster on/off (▷ page 150)
- ⑥ To set the temperature, right (▷ page 147)
- ⑦ To activate/deactivate air-recirculation mode (▷ page 151)
- ⑧ To set the air distribution (▷ page 148)
- ⑨ To increase the airflow (▷ page 148)
- ⑩ To reduce the airflow (▷ page 148)
- ⑪ To switch climate control on/off (▷ page 144)
- ⑫ To set climate control to automatic (▷ page 146)

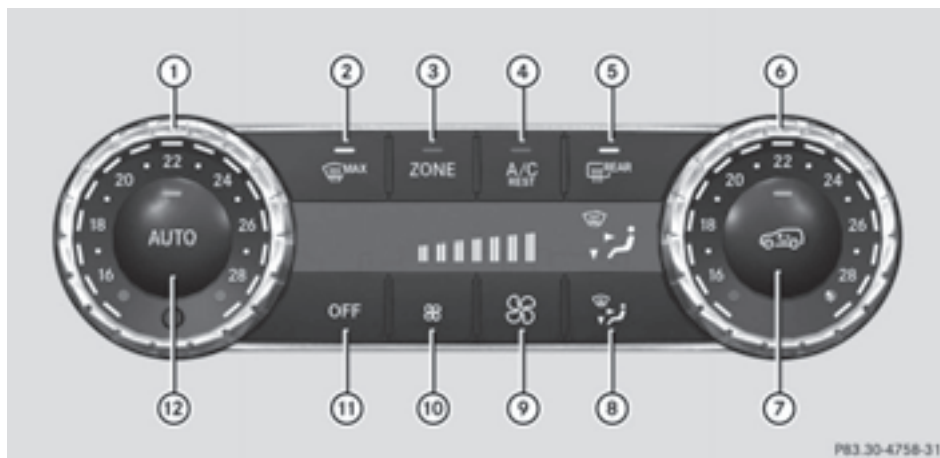

Canada only

Front control panel

- ① To set the temperature, left (▷ page 147)
- ② To defrost the windshield (▷ page 149)
- ③ To switch the ZONE function on/off (▷ page 149)
- ④ To switch cooling with air dehumidification on/off (▷ page 144)
To switch the residual heat function on/off (▷ page 151)
- ⑤ To switch the rear window defroster on/off (▷ page 150)
- ⑥ To set the temperature, right (▷ page 147)
- ⑦ To activate/deactivate air-recirculation mode (▷ page 151)
- ⑧ To set the air distribution (▷ page 148)
- ⑨ To increase the airflow (▷ page 148)
- ⑩ To reduce the airflow (▷ page 148)
- ⑪ To switch climate control on/off (▷ page 144)
- ⑫ To set climate control to automatic (▷ page 146)

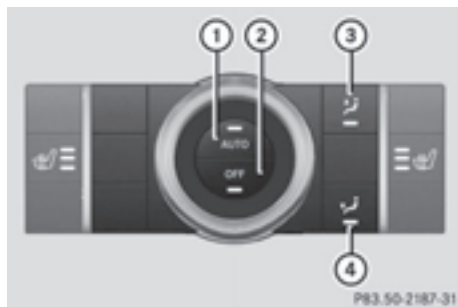



Rear control panel

- ① To set rear-compartment climate control to automatic
- ② To switch rear-compartment climate control on/off

- ③ To direct the airflow through the rear air vents
- ④ To direct the airflow through the footwell vents

Optimum use of dual-zone automatic climate control

The following contains notes and recommendations on optimum use of the dual-zone automatic climate control.

- Activate climate control using the **AUTO** and  buttons. The indicator lamps in the **AUTO** and  buttons light up.
- Set the temperature to 72 °F (22 °C).
- Only use the "Windshield defrosting" function briefly until the windshield is clear again.
- Only use air-recirculation mode briefly, e.g. if there are unpleasant outside odors or when in a tunnel. The windows could otherwise fog up, since no fresh air is drawn into the vehicle in air-recirculation mode.
- Use the ZONE function to adopt the temperature settings on the driver's side for the front-passenger side as well. The indicator lamp above the  button goes out.
- **Vehicles with COMAND:** if you change the settings of the climate control system, the climate status display appears for approximately three seconds at the bottom of the screen in the COMAND display. See also the separate COMAND operating instructions. You will see the current settings of the various climate control functions.

During automatic engine switch-off, the climate control system only operates at a reduced capacity. If you require the full climate control output, you can switch off the ECO start/stop function by pressing the ECO button (▷ page 163).

Control panel for 3-zone automatic climate control

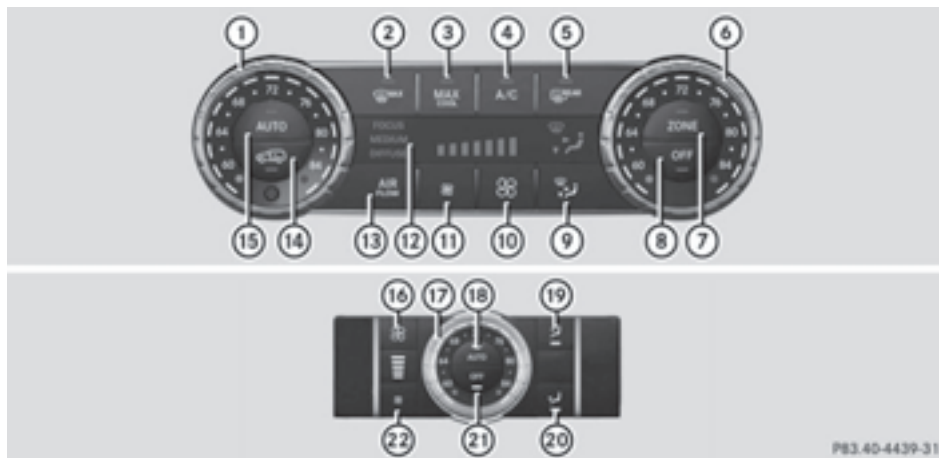

USA only

Front control panel

- ① To set the temperature, left (▷ page 147)
- ② To defrost the windshield (▷ page 149)
- ③ To switch maximum cooling on/off (▷ page 149)
- ④ To switch cooling with air dehumidification on/off (▷ page 144)
- ⑤ To switch the rear window defroster on/off (▷ page 150)
- ⑥ To set the temperature, right (▷ page 147)
- ⑦ To switch the ZONE function on/off (▷ page 149)
- ⑧ To switch climate control on/off (▷ page 144)
- ⑨ To set the air distribution (▷ page 148)
- ⑩ To increase the airflow (▷ page 148)
- ⑪ To reduce the airflow (▷ page 148)
- ⑫ Display
- ⑬ To adjust the climate mode settings (▷ page 147)
- ⑭ To activate/deactivate air-recirculation mode (▷ page 151)
- ⑮ To set climate control to automatic (▷ page 146)

Rear control panel

- ⑯ To increase the airflow (▷ page 148)
- ⑰ To set the temperature (▷ page 147)
- ⑱ To set rear-compartment climate control to automatic (▷ page 146)
- ⑲ To direct the airflow through the rear air vents (▷ page 148)
- ⑳ To direct the airflow through the footwell vents (▷ page 148)
- ㉑ To switch rear-compartment climate control on/off (▷ page 144)
- ㉒ To reduce the airflow (▷ page 148)

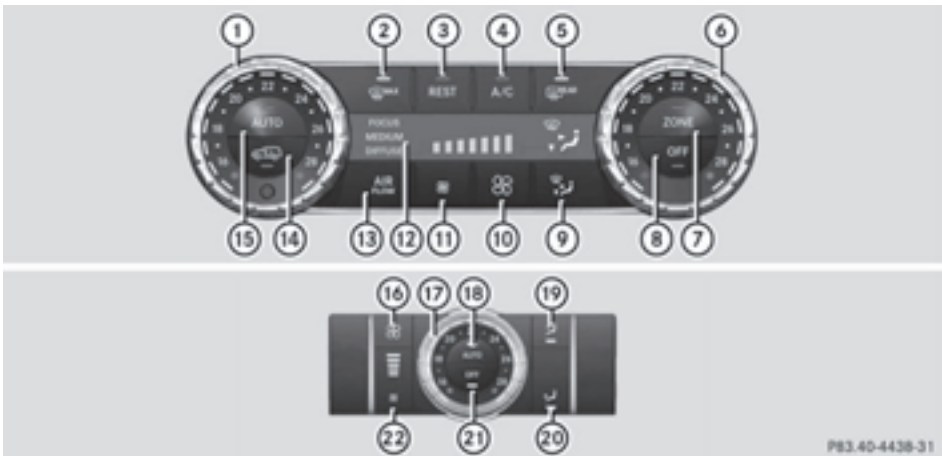

Canada only

Front control panel

- ① To set the temperature, left (▷ page 147)
- ② To defrost the windshield (▷ page 149)
- ③ To switch the residual heat function on/off (▷ page 151)
- ④ To switch cooling with air dehumidification on/off (▷ page 144)
- ⑤ To switch the rear window defroster on/off (▷ page 150)
- ⑥ To set the temperature, right (▷ page 147)
- ⑦ To switch the ZONE function on/off (▷ page 149)
- ⑧ To switch climate control on/off (▷ page 144)
- ⑨ To set the air distribution (▷ page 148)
- ⑩ To increase the airflow (▷ page 148)
- ⑪ To reduce the airflow (▷ page 148)
- ⑫ Display
- ⑬ To adjust the climate mode settings (▷ page 147)
- ⑭ To activate/deactivate air-recirculation mode (▷ page 151)
- ⑮ To set climate control to automatic (▷ page 146)

Rear control panel

- ⑯ To increase the airflow (▷ page 148)
- ⑰ To set the temperature (▷ page 147)
- ⑱ To set rear-compartment climate control to automatic (▷ page 146)
- ⑲ To direct the airflow through the rear air vents (▷ page 148)
- ⑳ To direct the airflow through the footwell vents (▷ page 148)
- ㉑ To switch rear-compartment climate control on/off (▷ page 144)
- ㉒ To reduce the airflow (▷ page 148)

Optimum use of 3-zone automatic climate control

The following contains instructions and recommendations to enable you to get the most out of your 3-zone automatic climate control.

- Activate climate control using the **AUTO** and **A/C** buttons. The indicator lamps above the **AUTO** and **A/C** buttons light up.
- In automatic mode, you can also use the **AIR FLOW** button to set a climate mode (FOCUS/MEDIUM/DIFFUSE). The MEDIUM level is recommended.
- Set the temperature to 72 °F (22 °C).
- Only use the "Windshield defrosting" function briefly until the windshield is clear again.
- Only use air-recirculation mode briefly, e.g. if there are unpleasant outside odors or when in a tunnel. The windows could otherwise fog up, since no fresh air is drawn into the vehicle in air-recirculation mode.
- Use the ZONE function to adopt the temperature settings on the driver's side for the front-passenger side and the rear compartment as well. The indicator lamp above the **ZONE** button goes out.
- Use the residual heat function if you want to heat or ventilate the vehicle interior when the ignition is switched off. The residual heat function can only be activated or deactivated with the ignition switched off.
- **Vehicles with COMAND:** if you change the settings of the climate control system, the climate status display appears for approximately three seconds at the bottom of the screen in the COMAND display. See also the separate COMAND operating instructions. You will see the current settings of the various climate control functions.

During automatic engine switch-off, the climate control system only operates at a reduced capacity. If you require the full climate control output, you can switch off the ECO start/stop function by pressing the ECO button (▷ page 163).

Operating the climate control systems

Switching climate control on/off

General notes

When the climate control is switched off, the air supply and air circulation are also switched off. The windows could fog up. Therefore, switch off climate control only briefly

- **i** Switch on climate control primarily using the **AUTO** button (▷ page 146).

In the rear compartment, you can also switch climate control on and off using the **AUTO** and **OFF** buttons.

Activating/deactivating

- ▶ Turn the SmartKey to position **2** in the ignition lock (▷ page 157).

- ▶ **To activate:** press the **AUTO** button. The indicator lamp in the **AUTO** button lights up. Airflow and air distribution are set to automatic mode.

or

- ▶ Press the **OFF** button. The indicator lamp in the **OFF** button goes out. The previously selected settings are restored.

- ▶ **To deactivate:** press the **OFF** button. The indicator lamp in the **OFF** button lights up.

Activating/deactivating cooling with air dehumidification

General notes

If you deactivate the "Cooling with air-dehumidification" function, the air inside the vehicle will not be cooled. The air inside the vehicle will also not be dehumidified. The windows can fog up more quickly. Therefore, only deactivate the "Cooling with air-dehumidification" function briefly.









The "Cooling with air dehumidification" function is only available when the engine is running. The air inside the vehicle is cooled and dehumidified according to the temperature selected.

Condensation may drip from the underside of the vehicle when it is in cooling mode. This is normal and not a sign that there is a malfunction.



Activating/deactivating



Example:  button

- ▶ **To activate:** press the  /  button. The indicator lamp in the  /  button lights up.
- ▶ **To deactivate:** press the  /  button. The indicator lamp in the  /  button goes out. The "Cooling with air dehumidification" function has a delayed switch-off feature.

Problems with the "Cooling with air dehumidification" function

Problem	Possible causes/consequences and ► Solutions
<p>The indicator lamp in the  /  button flashes three times or remains off. The "Cooling with air dehumidification" function cannot be switched on.</p>	<p>Cooling with air dehumidification has been deactivated due to a malfunction.</p> <p>► Visit a qualified specialist workshop.</p>

Setting climate control to automatic

General notes

If you deactivate the "Cooling with air-dehumidification" function, the air inside the vehicle will not be cooled. The air inside the vehicle will also not be dehumidified. The windows can fog up more quickly. Therefore, only deactivate the "Cooling with air-dehumidification" function briefly.







In automatic mode, the set temperature is maintained automatically at a constant level. The system automatically regulates the temperature of the dispensed air, the airflow and the air distribution.

Automatic mode will achieve optimal operation if cooling with air dehumidification is also activated. If necessary, cooling with air dehumidification can be deactivated.

In the rear compartment, you can also switch climate control for the rear seats to automatic mode using the  button.

Activating/switching



- Turn the SmartKey to position **2** in the ignition lock (► page 157).
 - Set the desired temperature.
 - **To activate:** press the  button. The indicator lamp in the  button lights up. Automatic air distribution and airflow are activated.
 - **To switch to manual mode:** press the  button.
- or
- Press the  or  button. The indicator lamp in the  button goes out.

3-zone automatic climate control: when automatic mode is activated, you can select a climate mode (► page 147).

Adjusting the climate mode settings

You can select the following climate mode settings in automatic mode:

- FOCUS** high airflow that is set slightly cooler
- MEDIUM** medium airflow, standard setting
- DIFFUSE** low airflow that is set slightly warmer and with less draft



- ▶ Turn the SmartKey to position **2** in the ignition lock (▷ page 157).
- ▶ Press the **AUTO** button.
- ▶ Press the **AIR FLOW** button repeatedly until the desired climate mode appears in the display.

Setting the temperature

Dual-zone automatic climate control

Different temperatures can be set for the driver's and front-passenger sides.

- ▶ Turn the SmartKey to position **2** in the ignition lock (▷ page 157).
- ▶ **To increase/reduce:** turn control ① or ⑥ clockwise or counter-clockwise (▷ page 139).
Only change the temperature setting in small increments. Start at 72 °F (22 °C).

3-zone automatic climate control

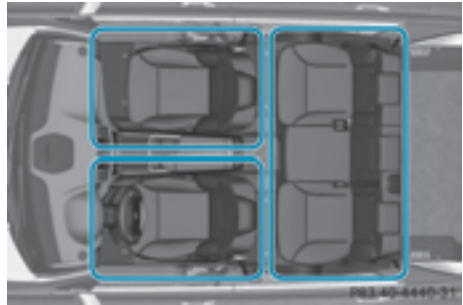

Automatic climate control zones







You can select different temperature settings for the driver's and front-passenger sides as well as for the rear compartment.

- ▶ Turn the SmartKey to position **2** in the ignition lock (▷ page 157).
- ▶ **To increase/reduce the temperature in the front:** turn control ① or ⑥ clockwise or counter-clockwise (▷ page 142).
Only change the temperature setting in small increments. Start at 72 °F (22 °C).
- ▶ **To increase/reduce the temperature in the rear compartment using the front control panel:** press the **ZONE** button. The indicator lamp in the **ZONE** button goes out.
- ▶ Turn control ① clockwise or counter-clockwise (▷ page 142).
Only change the temperature setting in small increments. Start at 72 °F (22 °C). The temperature setting for the driver's side is adopted for the rear compartment and the front-passenger side.
- ▶ **To increase/decrease the rear compartment temperature using the rear control panel:** turn control ⑰ clockwise or counter-clockwise on the rear control panel (▷ page 142).
Only change the temperature setting in small increments. Start at 72 °F (22 °C).



Setting the air distribution

Air distribution settings

Front control panel

-  Directs the airflow through the center vents
-  Directs air through the footwell air vents
-  Directs the airflow through the center and footwell vents
-  Directs air through the defroster vents
-  Directs the airflow through the defroster and center vents (Canada only)
-  Directs air through the defroster and footwell vents
-  Directs the airflow through the defroster, center and footwell air vents (Canada only)

Rear control panel

-  Directs the airflow through the rear center and rear side air vents
-  Directs air through the footwell air vents

i Using the rear control panel, you can also activate both air distribution positions simultaneously. In order to do this, press both air distribution buttons. The air is then routed through all rear air vents.

i Regardless of the air distribution setting, airflow is always directed through the side air vents. The side air vents can only be closed when the controls on the side air vents are turned downwards.



Adjusting



- ▶ Turn the SmartKey to position **2** in the ignition lock (▷ page 157).
- ▶ Press the  button repeatedly until the desired symbol appears in the display.

Setting the airflow





- ▶ Turn the SmartKey to position **2** in the ignition lock (▷ page 157).
- ▶ **To increase:** press the  button.
- ▶ **To reduce:** press the  button.

i You can use 3-zone automatic climate control to set the airflow in the rear compartment separately.



Switching the ZONE function on/off



- ▶ **To switch on:** press the  button. The indicator lamp above the  button lights up.

Dual-zone automatic climate control: the temperature setting for the driver's side is not adopted for the front-passenger side.

3-zone automatic climate control: the temperature setting for the driver's side is not adopted for the front-passenger side and the rear compartment.

- ▶ **To switch off:** press the  button. The indicator lamp above the  button goes out.

Dual-zone automatic climate control: the temperature setting for the driver's side is adopted for the front-passenger side.

3-zone automatic climate control: the temperature setting for the driver's side is adopted for the front-passenger side and the rear compartment.

Defrosting the windshield



General notes

You can use this function to defrost the windshield or to defrost the inside of the windshield and the side windows.

Switch off the "Windshield defrosting" function as soon as the windshield is clear again.



Switching on/off

- ▶ Turn the SmartKey to position **2** in the ignition lock (▷ page 157).



- ▶ **To activate:** press the  button. The indicator lamp in the  button lights up.

The climate control system switches to the following functions:



- high airflow
- high temperature
- air distribution to the windshield and front side windows
- air-recirculation mode off

- ▶ **To deactivate:** press the  button. The indicator lamp in the  button goes out. The previously selected settings are restored. Air-recirculation mode remains deactivated.

or

- ▶ Press the  button. The indicator lamp in the  button goes out. Airflow and air distribution are set to automatic mode.

or

- ▶ Turn controls  or  clockwise or counter-clockwise:

Dual-zone climate control (▷ page 139)

3-zone automatic climate control

(▷ page 142)

or



- ▶ Press the  or  button.

MAX COOL maximum cooling

The MAX COOL function is only available in vehicles for the USA.



MAX COOL is only operational when the engine is running.



- ▶ **To activate:** press the  button. The indicator lamp in the button lights up.
- ▶ **To activate:** press off-road button  again. The indicator lamp goes out. The previously selected settings are restored.

When you activate MAX COOL, climate control switches to the following functions:



- maximum cooling
- maximum airflow
- air-recirculation mode on

Defrosting the windows

Windows fogged up on the inside

- ▶ Activate the  /  cooling with air dehumidification function.
 - ▶ Activate automatic mode .
 - ▶ If the windows continue to fog up, activate the "windshield defrosting" function (> page 149).
- i** You should only select this setting until the windshield is clear again.

Windows fogged up on the outside

- ▶ Press the  button repeatedly until the  or  symbol appears in the display.
- i** You should only select this setting until the windshield is clear again.

Rear window defroster



General notes

The rear window defroster has a high current draw. You should therefore switch it off as soon as the rear window is clear. Otherwise, the rear window defroster switches off automatically after several minutes.

If the battery voltage is too low, the rear window defroster may switch off.

Switching on/off



- ▶ Turn the SmartKey to position **2** in the ignition lock (> page 157).
- ▶ Press the  button. The indicator lamp in the  button lights up or goes out.

Problems with the rear window defroster

Problem	Possible causes/consequences and ► Solutions
The rear window defroster has deactivated prematurely or cannot be activated.	The battery has not been sufficiently charged. ► Switch off any consumers that are not required, e.g. reading lamps, interior lighting or the seat heating. When the battery is sufficiently charged, the rear window defroster can be activated again.

Activating/deactivating air-recirculation mode

General notes



You can deactivate the flow of fresh air if unpleasant odors are entering the vehicle from outside. The air already inside the vehicle will then be recirculated.

If you switch on air-recirculation mode, the windows can fog up more quickly, in particular at low temperatures. Only use air-recirculation mode briefly to prevent the windows from fogging up.

Activating/deactivating





The operation of air-recirculation mode is the same for all control panels.

- Turn the SmartKey to position **2** in the ignition lock (► page 157).
- **To activate:** press the  button. The indicator lamp in the  button lights up.
- ❗ In the event of high pollution levels (3-zone automatic climate control only) or at

high outside temperatures, air-recirculation mode is automatically activated. When air-recirculation mode is activated automatically, the indicator lamp in the  button is not lit.

Outside air is added after about 30 minutes.

- **To deactivate:** press the  button. The indicator lamp in the  button goes out.
- ❗ Air-recirculation mode deactivates automatically:
 - after approximately five minutes at outside temperatures below approximately 41 °F (5 °C)
 - after approximately five minutes if cooling with air dehumidification is deactivated
 - after approximately 30 minutes at outside temperatures above approximately 41 °F (5 °C) if the "Cooling with air dehumidification" function is activated

Activating/deactivating the residual heat function

General notes

The residual heat function is only available on vehicles for Canada.

It is possible to make use of the residual heat of the engine to continue heating the stationary vehicle for up to 30 minutes after the engine has been switched off. The heating time depends on the set interior temperature.

Switching on/off



► **To activate:** press the **REST** / **A/C REST** button. The indicator lamp in the **REST** / **A/C REST** button lights up.

i The blower will run at a low speed regardless of the airflow setting.

i If you activate the residual heat function at high temperatures, only the ventilation will be activated. The blower runs at medium speed.

► **To deactivate:** press the **REST** / **A/C REST** button. The indicator lamp in the **REST** / **A/C REST** button goes out.

Residual heat is deactivated automatically:

- after approximately 30 minutes
- when the ignition is switched on
- if the battery voltage drops

Setting the air vents

Important safety notes

WARNING

Very hot or very cold air can flow from the air vents. This could result in burns or frostbite in the immediate vicinity of the air vents. There is a risk of injury.

Make sure that all vehicle occupants always maintain a sufficient distance to the air outlets. If necessary, redirect the airflow to another area of the vehicle interior.

In order to ensure the direct flow of fresh air through the air vents into the vehicle interior, please observe the following notes:

- keep the air inlet grille on the hood and in the engine compartment on the front-passenger side free of blockages, such as ice, snow or leaves.
 - never cover the air vents or air intake grilles in the vehicle interior.
- i** For virtually draft-free ventilation, adjust the sliders of the air vents to the center position.

Setting the center air vents



- ① Center air vent, left
- ② Center air vent, right
- ③ Center vent thumbwheel, right
- ④ Center vent thumbwheel, left

► **To open/close:** turn thumbwheels ③ and ④ to the right or left.

Setting the side air vents



- ① Side window defroster vent
- ② Side air vent
- ③ Control for side air vent

► **To open/close:** turn thumbwheel ③ up or down.

Setting the glove box air vent

❗ Close the air vent when heating the vehicle.

At high outside temperatures, open the air vent and activate the "cooling with air dehumidification" function. Otherwise, temperature-sensitive items stored in the glove box could be damaged.

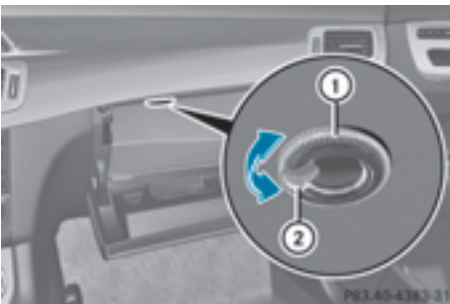

- ① Air vent thumbwheel
- ② Air vent

When automatic climate control is activated, the glove box can be ventilated, for instance to cool its contents. The level of airflow depends on the airflow and air distribution settings.

► **To open/close:** turn thumbwheel ① clockwise or counter-clockwise.

Setting the rear-compartment air vents

Setting the center vents in the rear compartment

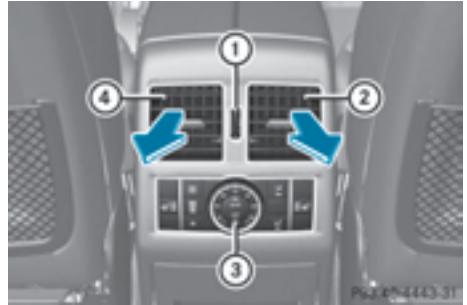

Example: center vents with rear control panel

- ① Rear-compartment air vent thumbwheel
- ② Rear-compartment air vent, right
- ③ Rear control panel
- ④ Rear-compartment air vent, left

► **To open/close:** turn thumbwheel ① up or down.

Setting the B-pillar air vent

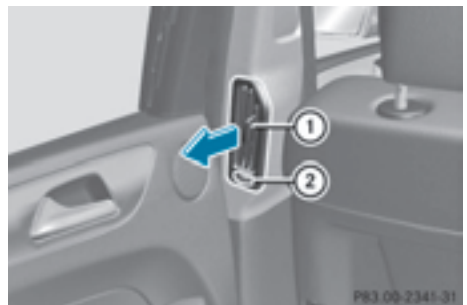

- ① B-pillar air vent
- ② Thumbwheel for B-pillar air vent

► **To open/close:** turn thumbwheel ② to the left or right.

Useful information	156
Notes on breaking-in a new vehicle	156
Driving	156
Automatic transmission	168
Refueling	177
Parking	182
Driving tips	186
Driving systems	195
Towing a trailer	256

Useful information

- i** This Operator's Manual describes all models and all standard and optional equipment of your vehicle available at the time of publication of the Operator's Manual. Country-specific differences are possible. Please note that your vehicle may not be equipped with all features described. This also applies to safety-related systems and functions.
- i** Read the information on qualified specialist workshops (▷ page 29).

Notes on breaking-in a new vehicle

Important safety notes

The sensor system of some driving and driving safety systems adjusts automatically while a certain distance is being driven after the vehicle has been delivered or after repairs. Full system effectiveness is not reached until the end of this teach-in procedure.

New and replaced brake pads and discs only reach their optimum braking effect after several hundred kilometers of driving. Compensate for this by applying greater force to the brake pedal.

The first 1000 miles (1500 km)

The more you look after the engine when it is new, the more satisfied you will be with its performance in the future.

- You should therefore drive at varying vehicle and engine speeds for the first 1000 miles (1500 km).
- Avoid heavy loads, e.g. driving at full throttle, during this period.
- Change gear in good time, before the tachometer needle is $\frac{2}{3}$ of the way to the red area of the tachometer.

- Do not manually shift to a lower gear to brake the vehicle.
- Try to avoid depressing the accelerator pedal beyond the point of resistance (kick-down).

After 1000 miles (1500 km), you can increase the engine speed gradually and accelerate the vehicle to full speed.

Additional breaking-in notes for AMG vehicles:

- Do not drive faster than 85 mph (140 km/h) for the first 1,000 miles (1,500 km).
- Only allow the engine to reach a maximum engine speed of 4,500 rpm briefly.
- Change gear in good time.
- Ideally, for the first 1,000 miles (1,500 km), drive in program **C**.

i You should also observe these notes on breaking in if the engine or parts of the drive train on your vehicle have been replaced.

i Always observe the respective speed limits.

Driving

Important safety notes

WARNING

Objects in the driver's footwell can restrict the pedal travel or obstruct a depressed pedal.

The operating and road safety of the vehicle is jeopardized. There is a risk of an accident.

Make sure that all objects in the vehicle are stowed correctly, and that they cannot enter the driver's footwell. Install the floormats securely and as specified in order to ensure sufficient clearance for the pedals. Do not use loose floormats and do not place floormats on top of one another.

⚠ WARNING

Unsuitable footwear can hinder correct usage of the pedals, e.g.:

- shoes with thick soles
- shoes with high heels
- slippers

There is a risk of an accident.

Wear suitable footwear to ensure correct usage of the pedals.

⚠ WARNING

If you switch off the ignition while driving, safety-relevant functions are only available with limitations, or not at all. This could affect, for example, the power steering and the brake boosting effect. You will require considerably more effort to steer and brake. There is a risk of an accident.

Do not switch off the ignition while driving.

⚠ WARNING

If the parking brake has not been fully released when driving, the parking brake can:

- overheat and cause a fire
- lose its hold function.

There is a risk of fire and an accident. Release the parking brake fully before driving off.

! Warm up the engine quickly. Do not use the engine's full performance until it has reached operating temperature.

Only shift the automatic transmission to the desired drive position when the vehicle is stationary.

Where possible, avoid spinning the drive wheels when pulling away on slippery roads. You could otherwise damage the drive train.

! **AMG vehicles:** at low engine oil temperatures below 68 °F (+20 °C), the maximum engine speed is restricted in order to protect the engine. To protect the engine and maintain smooth engine operation, avoid

driving at full throttle when the engine is cold.

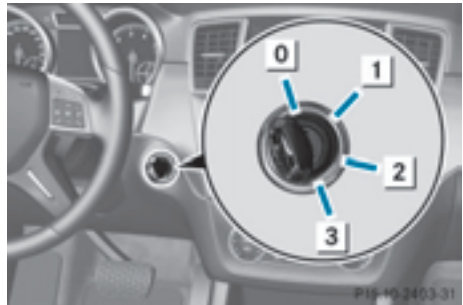
Key positions**SmartKey**

- 0 To remove the SmartKey
- 1 Power supply for some consumers, such as the windshield wipers
- 2 Ignition (power supply for all consumers) and drive position
- 3 To start the engine

As soon as the ignition is switched on, all the indicator lamps in the instrument cluster light up. If an indicator lamp does not go out after starting the engine or lights up while driving, see (▷ page 320).

If the SmartKey is in position **0** in the ignition lock for an extended period of time, it can no longer be turned in the ignition lock. The steering is then locked. To unlock, remove the SmartKey and reinsert it into the ignition lock. The steering is locked when you remove the SmartKey from the ignition lock.

► Remove the SmartKey when the engine is switched off. The starter battery could otherwise be discharged.

If you cannot turn the SmartKey in the ignition lock, the starter battery may not be charged sufficiently.

- ▶ Check the starter battery and recharge if necessary (▷ page 389).

or

- ▶ Jump-start the vehicle (▷ page 391).

- i** The SmartKey can be turned in the ignition lock even if it is not the correct SmartKey for the vehicle. The ignition is not switched on. The engine cannot be started.

KEYLESS-GO

General notes

Vehicles with KEYLESS-GO are equipped with a SmartKey featuring an integrated KEYLESS-GO function and a detachable Start/Stop button.

The Start/Stop button must be inserted in the ignition lock and the SmartKey must be in the vehicle.

When you insert the Start/Stop button into the ignition lock, the system needs approximately two seconds recognition time. You can then use the Start/Stop button.

Pressing the Start/Stop button several times in succession corresponds to the different key positions in the ignition lock. This is only the case if you are not depressing the brake pedal.

If you depress the brake pedal and press the Start/Stop button, the engine starts immediately.

A check which periodically establishes a radio connection between the vehicle and the SmartKey determines whether a valid SmartKey is in the vehicle. This occurs, for example, when starting the engine.

To start the vehicle without actively using the SmartKey:

- the Start/Stop button must be inserted in the ignition lock.
- the SmartKey must be in the vehicle.
- the vehicle must not be locked with the SmartKey or KEYLESS-GO (▷ page 81).

Do not keep the SmartKey:

- with electronic devices, e.g. a mobile phone or another SmartKey
- with metallic objects, e.g. coins or metal foil
- inside metallic objects, e.g. a metal case

This can impair the functionality of the KEYLESS-GO key.

Do not keep the KEYLESS-GO key in the temperature-controlled cup holder (▷ page 346). Otherwise, the KEYLESS-GO key will not be recognized.

If you lock the vehicle with the SmartKey's remote control or with KEYLESS-GO, after a short time:

- you will not be able to switch on the ignition with the Start/Stop button.
- you will not be able to start the engine with the Start/Stop button until the vehicle is unlocked again.

If you lock the vehicle centrally using the button on the front door (▷ page 87), you can continue to start the engine with the Start/Stop button.

- i** The engine can be turned off while the vehicle is in motion by pressing and holding the Start/Stop button for approximately three seconds. This function operates independently of the ECO start/stop automatic engine switch-off function.

Key positions with KEYLESS-GO

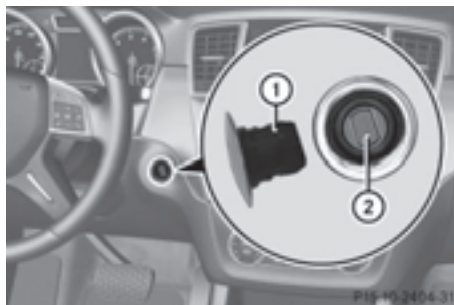

- ① Start/Stop button
- ② Ignition lock

As soon as the ignition is switched on, all the indicator lamps in the instrument cluster light up. If an indicator lamp does not go out after starting the engine or lights up while driving, see (▷ page 320).

If Start/Stop button ① has not yet been pressed, this corresponds to the SmartKey being removed from the ignition.

▶ **To switch on the power supply:** press Start/Stop button ① once.

The power supply is switched on. You can now activate the windshield wipers, for example.

i The power supply is switched off again if:

- the driver's door is opened and
- you press Start/Stop button ① twice when in this position.

▶ **To switch on the ignition:** press Start/Stop button ① twice.

The ignition is switched on.

i The ignition is switched off when:

- the driver's door is opened and
- you press Start/Stop button ① once when in this position.



③ Start/Stop button USA

④ Start/Stop button Canada

Removing the Start/Stop button

You can remove the Start/Stop button from the ignition lock and start the vehicle as normal using the SmartKey.

It is only possible to switch between KEY-LESS-GO mode and SmartKey operation when the transmission is in position **P**.

▶ Remove Start/Stop button ① from ignition lock ②.

i You do not have to remove the Start/Stop button from the ignition lock when you leave the vehicle. You should, however, always take the SmartKey with you when leaving the vehicle. As long as the SmartKey is in the vehicle:

- the vehicle can be started using the Start/Stop button
- electrically powered equipment can be operated.

Starting the engine

Important safety notes

⚠ WARNING

If children are left unsupervised in the vehicle, they could:

- open the doors, thus endangering other people or road users.
- get out and disrupt traffic.
- operate the vehicle's equipment.

Additionally, children could set the vehicle in motion if, for example, they:

- release the parking brake.
- shifting the automatic transmission out of park position **P**
- Start the engine.

There is a risk of an accident and injury.

When leaving the vehicle, always take the SmartKey with you and lock the vehicle. Never leave children or animals unattended in the vehicle. Always keep the SmartKey out of reach of children.

⚠ WARNING

Combustion engines emit poisonous exhaust gases such as carbon monoxide. Inhaling these exhaust gases leads to poisoning. There is a risk of fatal injury. Therefore never leave the engine running in enclosed spaces without sufficient ventilation.

⚠ WARNING

Flammable materials introduced through environmental influence or by animals can ignite if in contact with the exhaust system or parts of the engine that heat up. There is a risk of fire.

Carry out regular checks to make sure that there are no flammable foreign materials in the engine compartment or in the exhaust system.

- ❗ Do not depress the accelerator when starting the engine.



General notes

- ⓘ **Vehicles with a gasoline engine:** the catalytic converter is preheated for up to 30 seconds after a cold start. The sound of the engine may change during this time.

Automatic transmission

- ▶ Shift the transmission to position **P** (▷ page 168).
The transmission position display in the multifunction display shows **P** (▷ page 168).
- ⓘ You can start the engine in transmission position **P** and **N**.

Starting procedure with the SmartKey

- ▶ **To start a gasoline engine:** turn the SmartKey to position **3** in the ignition lock (▷ page 157) and release it as soon as the engine is running.
- ▶ **To start a diesel engine:** turn the SmartKey to position **2** in the ignition lock (▷ page 157).
The  preglow indicator lamp in the instrument cluster lights up.
- ▶ When the  preglow indicator lamp goes out, turn the SmartKey to position **3** (▷ page 157) and release it as soon as the engine is running.

- ⓘ You can start the engine without preglow if the engine is warm.

Using KEYLESS-GO to start the engine

- ▶ Depress the brake pedal and keep it depressed.
- ▶ **To start a gasoline engine:** press the Start/Stop button (▷ page 158) once. The engine starts.
- ▶ **To start a diesel engine:** press the Start/Stop button once (▷ page 158). Preglow is activated and the engine starts.

- ⓘ The Start/Stop button can be used to start the vehicle without inserting the SmartKey into the ignition lock. The Start/Stop button must be inserted in the ignition lock and the SmartKey must be in the vehicle. This mode for starting the engine operates independently of the ECO start/stop automatic engine start function.

Pulling away**Automatic transmission****⚠ WARNING**

If the engine speed is above the idling speed and you engage transmission position **D** or **R**, the vehicle could pull away suddenly. There is a risk of an accident.

When engaging transmission position **D** or **R**, always firmly depress the brake pedal and do not simultaneously accelerate.

- ▶ Depress the brake pedal and keep it depressed.
- ▶ Shift the transmission to position **D** or **R** (▷ page 168).
- ▶ Release the brake pedal.
- ▶ Carefully depress the accelerator pedal. The electric parking brake (▷ page 184) is automatically released.

The red **PARK** (USA only) or **(P)** (Canada only) indicator lamp in the instrument cluster goes out.

i It is only possible to shift the transmission from position **P** to the desired position if you depress the brake pedal. Only then is the parking lock released. If the brake pedal is not depressed, the DIRECT SELECT lever can still be moved but the parking lock remains engaged.

i The vehicle locks centrally once you have pulled away. The locking knobs in the doors drop down.

You can open the doors from the inside at any time.

You can also deactivate the automatic locking feature (▷ page 279).

i Upshifts take place at higher engine speeds after a cold start. This helps the catalytic converter to reach its operating temperature more quickly.

Pulling away with a trailer



To ensure that you do not roll backwards when pulling away on an uphill slope, engage the electric parking brake.

- ▶ Press and hold handle ①. The electric parking brake continues to brake and prevent the vehicle from rolling backwards.

The red **PARK** (USA only) or **(P)** (Canada only) indicator lamp in the instrument cluster remains on.

- ▶ Depress the accelerator pedal.
- ▶ As soon as the vehicle/trailer combination is held by the driving force of the engine, release lever ①. The electric parking brake is released. The red **PARK** (USA only) or **(P)** (Canada only) indicator lamp in the instrument cluster goes out.

Hill start assist

Hill start assist helps you when pulling away forwards or in reverse on an uphill gradient. It holds the vehicle for a short time after you have removed your foot from the brake pedal. This gives you enough time to move your foot from the brake pedal to the accelerator pedal and to depress it before the vehicle begins to roll.

WARNING

After a short time, hill start assist will no longer brake your vehicle and it could roll away. There is a risk of an accident and injury. Therefore, quickly move your foot from the brake pedal to the accelerator pedal. Never leave the vehicle when it is held by hill start assist.

- ▶ Remove your foot from the brake pedal. The vehicle is then held for about a second.
- ▶ Pull away.

Hill start assist is not active if:

- you are pulling away on a level road or on a downhill gradient.
- the transmission is in position **N**.
- the electric parking brake is applied.
- ESP® is malfunctioning.

ECO start/stop function (all vehicles except the ML 250 BlueTEC 4MATIC)

Introduction

This section describes the ECO start/stop function for all vehicles except the ML 250 BlueTEC 4MATIC. Information about the ECO start/stop function on the ML 250 BlueTEC 4MATIC (▷ page 164).

The ECO start/stop function switches the engine off automatically if the vehicle is stopped under certain conditions.

The engine starts automatically when the driver wants to pull away again. The ECO start/stop function thereby helps you to reduce the fuel consumption and emissions of your vehicle.

Important safety notes

WARNING

If the engine is switched off automatically and you exit the vehicle, the engine is restarted automatically. The vehicle may begin moving. There is a risk of accident and injury.

If you wish to exit the vehicle, always turn off the ignition and secure the vehicle against rolling away.

General notes



① ECO start/stop display

If the **ECO** symbol is shown in green in the multifunction display, the ECO start/stop function switches the engine off automatically if the vehicle stops moving.

Every time you switch on the engine using the SmartKey or the Start/Stop button, the ECO start/stop function is activated.

If the ECO start/stop function has been manually deactivated (▷ page 163) or a malfunction has caused the system to be deactivated, the **ECO** symbol is not displayed.

AMG vehicles: the ECO start/stop function is only available in drive program **C**.

For further information on automatic engine switch-off (▷ page 162) and automatic engine start (▷ page 163).

Automatic engine switch-off

If the vehicle is braked to a standstill in **D** or **N**, the ECO start/stop function switches off the engine automatically.

The ECO start/stop function is operational and the **ECO** symbol is displayed in green in the multifunction display, if:

- the indicator lamp in the ECO button is lit green.
- no off-road program has been selected.
- the outside temperature is within the range that is suitable for the system.
- the engine is at normal operating temperature.
- the set temperature for the vehicle interior has been reached.
- the battery is sufficiently charged.
- the system detects that the windshield is not fogged up when the air-conditioning system is switched on.
- the hood is closed.
- the driver's door is closed and the driver's seat belt is fastened.

If conditions for automatic engine switch-off have not been fulfilled, the **ECO** symbol will be shown in yellow.

i All of the vehicle's systems remain active when the engine has been stopped automatically.

i The HOLD function can be activated if the engine has been switched off automatically. It is then not necessary to continue applying the brakes during the automatic

stop phase. When you depress the accelerator pedal, the engine starts automatically and the braking effect of the HOLD function is deactivated.

i All vehicles (apart from AMG vehicles): automatic engine switch-off can take place a maximum of four times consecutively (initial stop then repeated three times). The **ECO** symbol is shown in yellow in the multifunction display after the engine has been started automatically for the fourth time. When the **ECO** symbol is shown in green in the multifunction display, automatic engine switch-off is again possible.

i AMG vehicles: times which the engine can be automatically switched off.

Automatic engine start

The engine starts automatically if:

- you switch off the ECO start/stop function by pressing the ECO button.
- in transmission position **D** or **N** the brake pedal is released and the HOLD function is not active.
- you depress the accelerator pedal.
- you engage reverse gear **R**.
- you move the transmission out of position **P**.
- you switch to drive program **S** or **M** (AMG vehicles).
- you switch to an off-road program (except for AMG vehicles).
- you unfasten your seat belt or open the driver's door.
- the vehicle starts to roll.
- the brake system requires this.
- the temperature in the vehicle interior deviates from the set range.
- the system detects moisture on the windshield when the air-conditioning system is switched on.
- the battery's condition of charge is too low.

i Shifting the transmission to position **P** does not start the engine.

i If you shift the transmission from **R** to **D**, the ECO start/stop function is available again once the **ECO** symbol reappears in green in the multifunction display.

Deactivating/activating the ECO start/stop function

All vehicles (except AMG vehicles)



► **To deactivate:** press ECO button ①. Indicator lamp ② and the **ECO** ECO symbol in the multifunction display go out.

► **To activate:** press ECO button ①. Indicator lamp ② lights up. If all conditions for automatic engine switch-off (▷ page 162) are fulfilled, the **ECO** symbol is shown in green in the multifunction display.

If not all conditions for automatic engine switch-off (▷ page 162) are fulfilled, the **ECO** symbol is shown in yellow in the multifunction display. If this is the case, the ECO start/stop function is not available.

i If indicator lamp ② is off, the ECO start/stop function has been deactivated manually or as the result of a malfunction. The engine will then not be switched off automatically when the vehicle stops.

AMG vehicles



► **To switch off:** in drive program **C**, press ECO button ①.

or

► Switch to drive program **S** or **M** (▷ page 172). Indicator lamp ② and the **ECO** ECO symbol in the multifunction display go out.

► **To activate:** press ECO button ①. Indicator lamp ② lights up. If drive program **S** or **M** is active, the automatic transmission switches to drive program **C**. If all conditions for automatic engine switch-off (▷ page 162) are fulfilled, the **ECO** symbol is shown in green in the multifunction display.

If the conditions for automatic engine switch-off are not all fulfilled (▷ page 162), the **ECO** symbol is lit yellow. If this is the case, the ECO start/stop function is not available.

❗ If indicator lamp ② is off, the ECO start/stop function has been deactivated manually or as the result of a malfunction. The engine will then not be switched off automatically when the vehicle stops.

ECO start/stop function (ML 250 BlueTEC 4MATIC)

Introduction

The ECO start/stop function switches the engine off automatically if the vehicle is stopped under certain conditions.

The engine starts automatically when the driver wants to pull away again. The ECO start/stop function thereby helps you to reduce the fuel consumption and emissions of your vehicle.

Important safety notes

⚠ WARNING

If the engine is switched off automatically and you exit the vehicle, the engine is restarted automatically. The vehicle may begin moving. There is a risk of accident and injury.

If you wish to exit the vehicle, always turn off the ignition and secure the vehicle against rolling away.

General notes

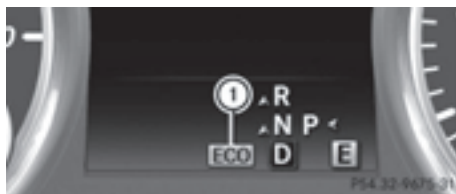

① ECO start/stop display

If the engine has been switched off automatically by the ECO start/stop function, the **ECO** symbol is shown in the multifunction display.

Every time you switch on the engine using the SmartKey or the Start/Stop button, the ECO start/stop function is activated.

For further information on automatic engine switch-off (▷ page 165) and automatic engine start (▷ page 165).

Automatic engine switch-off

If the vehicle is braked to a standstill in **D** or **N**, the ECO start/stop function switches off the engine automatically.

The ECO start/stop function is operational when:

- the indicator lamp in the ECO button is lit green.
- no off-road program has been selected.
- the outside temperature is within the range that is suitable for the system.
- the engine is at normal operating temperature.
- the set temperature for the vehicle interior has been reached.
- the battery is sufficiently charged.
- the system detects that the windshield is not fogged up when the air-conditioning system is switched on.
- the hood is closed.
- the driver's door is closed and the driver's seat belt is fastened.

i All of the vehicle's systems remain active when the engine has been stopped automatically.

i The HOLD function can also be activated if the engine has been switched off automatically. It is then not necessary to continue applying the brakes during the automatic stop phase. When you depress the accelerator pedal, the engine starts automatically and the braking effect of the HOLD function is deactivated.

i The engine can be switched off automatically a maximum of four times (first stop and three subsequent stops) in succession.

Automatic engine start

The engine starts automatically if:

- you switch off the ECO start/stop function by pressing the ECO button.
- in transmission position **D** or **N** the brake pedal is released and the HOLD function is not active.
- you depress the accelerator pedal.
- you engage reverse gear **R**.
- you move the transmission out of position **P**.
- you switch to an off-road program.
- you unfasten your seat belt or open the driver's door.
- the vehicle starts to roll.
- the brake system requires this.
- the temperature in the vehicle interior deviates from the set range.
- the system detects moisture on the windshield when the air-conditioning system is switched on.
- the battery's condition of charge is too low.

i Shifting the transmission to position **P** does not start the engine.

Deactivating/activating the ECO start/stop function



ECO button

► **To deactivate:** press ECO button ①. Indicator lamp ② goes out.

► **To activate:** press ECO button ①. Indicator lamp ② lights up.

If the indicator lamp on the ECO button is off, the ECO start/stop function has been deactivated manually or as the result of a malfunction.

Problems with the engine	
Problem	Possible causes/consequences and ► Solutions
The engine does not start. The starter motor can be heard.	<ul style="list-style-type: none"> • There is a malfunction in the engine electronics. • There is a malfunction in the fuel supply. <p>► Before attempting to start the engine again, turn the SmartKey in the ignition back to position 0 or press the Start/Stop button repeatedly until all indicator lamps in the instrument cluster go out.</p> <p>► Try to start the engine again (▷ page 159). Avoid excessively long and frequent attempts to start the engine as these will drain the battery.</p> <p>If the engine does not start after several attempts:</p> <p>► Consult a qualified specialist workshop.</p>
The engine does not start. You cannot hear the starter motor.	<p>The on-board voltage is too low because the battery is too weak or discharged.</p> <p>► Jump-start the vehicle (▷ page 391).</p> <p>If the engine does not start despite attempts to jump-start it:</p> <p>► Consult a qualified specialist workshop.</p> <p>The starter motor was exposed to a thermal load that was too high.</p> <p>► Allow the starter motor to cool down for approximately two minutes.</p> <p>► Try to start the engine again.</p> <p>If the engine still does not start:</p> <p>► Consult a qualified specialist workshop.</p>
Vehicles with a gasoline engine: The engine is not running smoothly and is misfiring.	<p>There is a malfunction in the engine electronics or in a mechanical component of the engine management system.</p> <p>► Only depress the accelerator pedal slightly. Otherwise, non-combusted fuel may get into the catalytic converter and damage it.</p> <p>► Have the cause rectified immediately at a qualified specialist workshop.</p>
The coolant temperature gauge shows a value above 248 °F (120 °C).	<p>The coolant level is too low. The coolant is too hot and the engine is no longer being cooled sufficiently.</p> <p>► Stop as soon as possible and allow the engine and the coolant to cool down.</p> <p>► Check the coolant level (▷ page 369). Observe the warning notes as you do so and add coolant if necessary.</p>

Automatic transmission

Important safety notes

WARNING

If the engine speed is above the idling speed and you engage transmission position **D** or **R**, the vehicle could pull away suddenly. There is a risk of an accident.

When engaging transmission position **D** or **R**, always firmly depress the brake pedal and do not simultaneously accelerate.

WARNING

The automatic transmission switches to neutral position **N** when you switch off the engine. The vehicle may roll away. There is a risk of an accident.

After switching off the engine, always switch to parking position **P**. Prevent the parked vehicle from rolling away by applying the parking brake.

DIRECT SELECT lever

Overview of transmission positions



- P** Park position with parking lock
- R** Reverse gear
- N** Neutral
- D** Drive

The DIRECT SELECT lever is on the right of the steering column.

- i** The DIRECT SELECT lever always returns to its original position. The current trans-

mission position **P**, **R**, **N** or **D** appears in the transmission position display (▷ page 168) in the multifunction display.

Transmission position and drive program display

- !** If the transmission position display in the multifunction display is not working, you should pull away carefully to check whether the desired transmission position is engaged. Ideally, you should select transmission position **D** and, in AMG vehicles, drive program **C** or **S**.



Transmission position and drive program display

- ① Transmission position display
- ② Drive program display

The current transmission position and drive program appear in the multifunction display.

- i** The arrows in the transmission position display show how and into which transmission positions you can change using the DIRECT SELECT lever.

Engaging park position P

- !** If the engine speed is too high or the vehicle is moving, do not shift the automatic transmission directly from **D** to **R**, from **R** to **D** or directly to **P**. The automatic transmission could otherwise be damaged.



- P** Park position with parking lock
- R** Reverse gear
- N** Neutral
- D** Drive

- ▶ Push the DIRECT SELECT lever in the direction of arrow **P**.

Engaging park position **P** automatically

Park position **P** is automatically engaged if:

- you switch off the engine using the SmartKey and remove the SmartKey.
- you switch off the engine using the Start/Stop button and open one of the front doors.
- you open the driver's door when the vehicle is stationary or driving at very low speed and the transmission is in position **D** or **R**.

Engaging reverse gear **R**

! Only shift the automatic transmission to **R** when the vehicle is stationary.

- ▶ If the transmission is in position **D** or **N**: push the DIRECT SELECT lever up past the first point of resistance.
- ▶ If the transmission is in position **P**: depress the brake pedal and push the DIRECT SELECT lever up past the first point of resistance.

Shifting to neutral **N**

WARNING

If children are left unsupervised in the vehicle, they could:

- open the doors, thus endangering other people or road users.
- get out and disrupt traffic.
- operate the vehicle's equipment.

Additionally, children could set the vehicle in motion if, for example, they:

- release the parking brake.
- shifting the automatic transmission out of park position **P**
- Start the engine.

There is a risk of an accident and injury.

When leaving the vehicle, always take the SmartKey with you and lock the vehicle. Never leave children or animals unattended in the vehicle. Always keep the SmartKey out of reach of children.

- ▶ If the transmission is in position **D** or **R**: push the DIRECT SELECT lever up or down to the first point of resistance.
- ▶ If the transmission is in position **P**: depress the brake pedal and push the DIRECT SELECT lever up or down to the first point of resistance.

If the engine has been switched off, the automatic transmission automatically shifts to **N**.

If you want the automatic transmission to remain in neutral **N**, e.g. when having the vehicle cleaned in an automatic car wash with a towing system, observe the following notes:

Using the SmartKey:

- Make sure that the ignition is switched on.
- When the vehicle is stationary, depress the brake pedal and keep it depressed.
- Shift to neutral **N**.
- Release the brake pedal.

- If the electric parking brake is engaged, release it.
- Switch off the ignition and leave the SmartKey in the ignition lock.

Using KEYLESS-GO:

- Make sure that the ignition is switched on.
- When the vehicle is stationary, depress the brake pedal and keep it depressed.
- Engage park position **P**.
- Release the brake pedal.
- Remove the Start/Stop button from the ignition lock.
- Insert the SmartKey into the ignition lock.
- Switch on the ignition.
- Depress the brake pedal and keep it depressed.
- Shift to neutral **N**.
- Release the brake pedal.
- If the electric parking brake is engaged, release it.
- Switch off the ignition and leave the SmartKey in the ignition lock.

Engaging drive position **D**

- ▶ If the transmission is in position **R** or **N**: push the DIRECT SELECT lever down past the first point of resistance.
- ▶ If the transmission is in position **P**: depress the brake pedal and push the DIRECT SELECT lever down past the first point of resistance.

Transmission positions

P

Park position

Do not shift the transmission into position **P** (▷ page 182) unless the vehicle is stationary. The parking lock should not be used as a brake when parking. Always apply the electronic parking brake in addition to the parking lock in order to secure the vehicle.

If the vehicle electronics are malfunctioning, the transmission may be locked in position **P**. Have the vehicle electronics checked immediately at a qualified specialist workshop.

The automatic transmission shifts to **P** automatically if you:

- remove the SmartKey
- switch off the engine when in **R** or **D** and open one of the front doors

R

Reverse gear

Only shift the transmission to **R** when the vehicle is stationary.

N**Neutral**

Do not shift the transmission to **N** while driving. Otherwise, the automatic transmission could be damaged.

No power is transmitted from the engine to the drive wheels.

Releasing the brake pedal will allow you to move the vehicle freely, e.g. to push it or tow it.

If ESP® is deactivated or faulty: only shift the transmission to position **N** if the vehicle is in danger of skidding, e.g. on icy roads.

If you switch off the engine using the SmartKey or the Start/Stop button, the automatic transmission shifts to neutral **N** automatically.

! Rolling in neutral **N** can damage the drive train.

D**Drive**

The automatic transmission changes gear automatically. All forward gears are available.

Driving tips**Changing gear**

The automatic transmission shifts to the individual gears automatically when it is in transmission position **D**. This automatic gear shifting behavior is determined by:

- the selected drive program (▷ page 172)
- the position of the accelerator pedal (▷ page 171)
- the road speed

Accelerator pedal position

Your style of driving influences how the automatic transmission shifts gear:

- little throttle: early upshifts
- more throttle: late upshifts

Kickdown

Use kickdown for maximum acceleration.

- ▶ Depress the accelerator pedal beyond the pressure point.
The automatic transmission shifts to a lower gear depending on the engine speed.
- ▶ Ease off the accelerator pedal once the desired speed is reached.
The automatic transmission shifts back up.

Rocking the vehicle free

Shifting the transmission repeatedly between gears **D** and **R** may help to free the vehicle if it has become stuck in slush or snow. The vehicle's engine management system limits the speed to a maximum of 5 mph (9 km/h) when shifting back and forth. To shift back and forth between transmission positions **D** and **R**, move the DIRECT SELECT lever up and down past the point of resistance.

Towing a trailer

- ▶ Drive in the middle of the engine speed range on uphill gradients.
- ▶ Depending on the uphill or downhill gradient, use left-hand steering wheel paddle shifter (▷ page 172) to select a lower gear, even if cruise control or DISTRONIC PLUS are activated.

Program selector button

General notes



Vehicles with the ON&OFFROAD package

- ▶ Press program selector button ①. The letter **M** appears in the multifunction display. The manual drive program **M** is activated.



AMG vehicles

- ▶ Press program selector button ① repeatedly until the letter for the desired gearshift program appears in the multifunction display.

The program selector button allows you to choose between different driving characteristics.

In AMG vehicles, drive program **E** is called drive program **C**.

- ① The permanent drive program **M** is available on the following vehicles:

- Vehicles with the ON&OFFROAD package
- AMG vehicles

Further information about permanent drive program **M** (▷ page 174).

As well as this permanent drive program **M**, you can also activate temporary drive program **M** (▷ page 173).

- ① **AMG vehicles:** the automatic transmission switches to automatic drive program **C** each time the engine is started.

Drive program on vehicles with the ON&OFFROAD package

M Manual	Permanent manual gear-shifting
-----------------	--------------------------------

Drive programs on AMG vehicles

C Controlled Efficiency	Comfortable, economical driving
S Sport	Sporty driving style
M Manual	Permanent manual gear-shifting

- ① For further information on the automatic drive program, see (▷ page 173).

Steering wheel paddle shifters



In the manual drive program, you can change gears manually using steering wheel paddle shifters ① and ②.

Further information about permanent drive program **M** (▷ page 174).

Further information about temporary drive program **M** (▷ page 173).

- i** You can only change gear with the steering wheel paddle shifters when the transmission is in position **D**.

Automatic drive program

Automatic drive programs **E** and **S**

Drive program **E** (drive program **C** on MAG vehicles) is characterized by the following:

- comfort-oriented engine and transmission settings
- optimal fuel consumption resulting from the automatic transmission shifting up sooner
- the vehicle pulling away more gently in forward and reverse gears, unless the accelerator pedal is depressed fully
- increased sensitivity. This improves driving stability on slippery road surfaces, for example
- the automatic transmission shifting up sooner. This results in the vehicle being driven at lower engine speeds and the wheels being less likely to spin

Drive program **S** is characterized by the following:

- sporty engine and transmission settings
- the automatic transmission shifting up later
- the fuel consumption possibly being higher as a result of the later automatic transmission shift points

Manual drive program **M**

General notes

In this drive program, you can briefly change gear yourself by using the steering wheel paddle shifters. The transmission must be in position **D**.

All vehicles (except AMG vehicles): you can activate manual drive program **M** using the steering wheel paddle shifters.

AMG vehicles: you can activate manual drive program **M** in automatic drive programs **C** and **S**.

Vehicles with the ON&OFFROAD package: if manual drive program **M** is deactivated using the program selector button, you can activate manual drive program **M** using the steering wheel paddle shifters.

- i** As well as temporary drive program **M**, you can also activate permanent drive program **M** (▷ page 172).

Further information about permanent drive program **M** (▷ page 174).

Activating

- ▶ Shift the transmission to position **D**.
- ▶ Pull the left or right steering wheel paddle shifter (▷ page 172).
Manual drive program **M** is temporarily activated. The selected gear and **M** appear in the multifunction display.

Shifting gears

If you pull on the left or right steering wheel paddle shifter, the automatic transmission switches to manual drive program **M** for a limited amount of time. Depending on which paddle shifter is pulled, the automatic transmission immediately shifts into the next gear down or up, if permitted.

- ▶ **To shift up:** pull the right-hand steering wheel paddle shifter (▷ page 172).
The automatic transmission shifts up to the next gear.

- i** If the maximum engine speed on the currently engaged gear is reached and you continue to accelerate, the automatic

transmission automatically shifts up in order to prevent engine damage.

- ▶ **To shift down:** pull on the left-hand steering wheel paddle shifter (▷ page 172).

The automatic transmission shifts down to the next gear.

- ❗ If the engine exceeds the maximum engine speed when shifting down, the automatic transmission protects against engine damage by not shifting down.
- ❗ Automatic down shifting occurs when coasting.

Shift recommendation

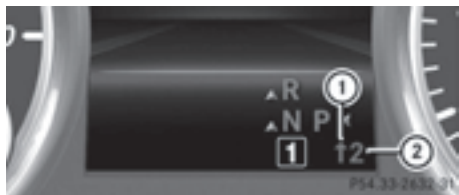

The gearshift recommendations assist you in adopting an economical driving style. The recommended gear is shown in the multifunction display.

- ▶ Shift to recommended gear ② according to gearshift recommendation ① when shown in the multifunction display of the instrument cluster.

Deactivating

If you have activated manual drive program **M**, it will remain active for a certain amount of time. Under certain conditions the minimum amount of time is extended, e.g. in the case of lateral acceleration, during an overrun phase or when driving on steep terrain.

If manual drive program **M** has been deactivated, the automatic transmission shifts into the automatic drive program that was last selected.

You can also deactivate manual drive program **M** yourself:

- ▶ Pull on the right-hand steering wheel paddle shifter and hold it in place (▷ page 172).
- or

- ▶ Use the DIRECT SELECT lever to switch the transmission position.
- or

- ▶ **AMG vehicles:** use the program selector button to change the drive program (▷ page 172).

Manual drive program **M** is deactivated.

The automatic transmission switches into the drive program that was last selected, **C** or **S**.

or

- ▶ **Vehicles with the**

ON&OFFROAD package: use the selector wheel to switch to the on-road program (▷ page 247) or the off-road program (▷ page 251).

Manual drive program

General information

In this drive program, you can permanently change gear yourself by using the steering wheel paddle shifters. The transmission must be in position **D**.

- ❗ As well as this permanent drive program **M**, you can also activate temporary drive program **M** (▷ page 173).

Switching on the manual drive program

In manual drive program **M**, you can change gear using the steering wheel paddle shifters if the transmission is in position **D**. You can see the currently selected drive program and which gear is engaged in the multifunction display.

- ▶ **AMG vehicles:** press the program selector button (▷ page 172) until **M** appears in the multifunction display.
- ▶ **Vehicles with the ON&OFFROAD package:** press the program selector button (▷ page 172). The letter **M** appears in the multifunction display.

Shifting up (all vehicles except AMG vehicles)



- ▶ If corresponding gearshift recommendation ① appears in the multifunction display on the instrument cluster, pull on the right-hand steering wheel paddle shifter (▷ page 172). The automatic transmission shifts to recommended gear ②.

Shifting up (AMG vehicles)

- ▶ **!** In manual drive program **M**, the automatic transmission does not shift up automatically even when the engine limiting speed for the current gear is reached. When the engine limiting speed is reached, the fuel supply is cut to prevent the engine from overrevving. Always make sure that the engine speed does not reach the red area of the tachometer. There is otherwise a risk of engine damage.

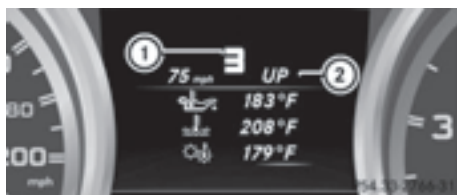

- ① Gear indicator
- ② Upshift indicator

Before the engine speed reaches the red area, an upshift indicator will be shown in the multifunction display.

- ▶ If the color in the speedometer multifunction display changes to red and the **UP** display message is shown, shift up a gear.

Downshifting

- ▶ Pull the left-hand steering wheel paddle shifter (▷ page 172). The automatic transmission shifts down to the next gear.

Maximum acceleration

- ▶ Pull the left-hand steering wheel paddle shifter until the transmission selects the optimum gear according to the speed.
- ▶ **i** If you slow down or stop without shifting down, the automatic transmission automatically shifts down.

Kickdown

You can also use kickdown for maximum acceleration in manual drive program **M**.

- ▶ Depress the accelerator pedal beyond the pressure point. The automatic transmission shifts to a lower gear depending on the engine speed.
- ▶ Shift back up once the desired speed is reached.

- ▶ **i All vehicles (except AMG vehicles):** if you apply full throttle, the automatic transmission shifts up to the next gear when the maximum engine speed is reached. This prevents the engine from overrevving.

- i AMG vehicles:** it is not possible to use kickdown in manual drive program **M**.

Switching off the manual drive program

- ▶ **Vehicles with the ON&OFFROAD package:** press the program selector button (▷ page 172).
The **M** message in the multifunction display goes out.
- ▶ **AMG vehicles:** press the program selector button (▷ page 172) repeatedly until **C** or **S** appears in the multifunction display.

Problems with the transmission

Problem	Possible causes/consequences and ► Solutions
The transmission has problems shifting gear.	The transmission is losing oil. ► Have the transmission checked at a qualified specialist workshop immediately.
The acceleration ability is deteriorating. The transmission no longer changes gear.	The transmission is in emergency mode. It is only possible to shift into second gear and reverse gear. ► Stop the vehicle. ► Shift the transmission to position P . ► Switch off the engine. ► Wait at least ten seconds before restarting the engine. ► Shift the transmission to position D or R . If D is selected, the transmission shifts into second gear; if R is selected, the transmission shifts into reverse gear. ► Have the transmission checked at a qualified specialist workshop immediately.

Transfer case

❗ Performance tests may only be carried out on a 2-axle dynamometer. The brake system or transfer case could otherwise be damaged. Contact a qualified specialist workshop for a performance test.

❗ Because ESP® is an automatic system, the engine and ignition must be switched off (SmartKey in position **0** or **1** or Start/Stop button in position **0** or **1**) when the electric parking brake is being tested on a brake dynamometer (maximum 10 seconds).

Braking triggered automatically by ESP® may seriously damage the brake system.

❗ Vehicles with 4MATIC must not be towed with either the front or the rear axle raised, as doing so will damage the transmission.

This section is only valid for vehicles with 4-wheel drive (4MATIC). Power is always transmitted to both axles.

Refueling

Important safety notes

WARNING

Fuel is highly flammable. If you handle fuel incorrectly, there is a risk of fire and explosion.

You must avoid fire, open flames, creating sparks and smoking. Switch off the engine and, if applicable, the auxiliary heating before refueling.

WARNING

Fuel is poisonous and hazardous to health. There is a risk of injury.

You must make sure that fuel does not come into contact with your skin, eyes or clothing and that it is not swallowed. Do not inhale fuel vapors. Keep fuel away from children.

If you or others come into contact with fuel, observe the following:

- Wash away fuel from skin immediately using soap and water.
- If fuel comes into contact with your eyes, immediately rinse them thoroughly with clean water. Seek medical assistance without delay.
- If fuel is swallowed, seek medical assistance without delay. Do not induce vomiting.
- Immediately change out of clothing which has come into contact with fuel.

WARNING

Electrostatic buildup can create sparks and ignite fuel vapors. There is a risk of fire and explosion.

Always touch the vehicle body before opening the fuel filler flap or touching the fuel pump nozzle. Any existing electrostatic buildup is thereby discharged.

WARNING

Vehicles with a diesel engine:

If you mix diesel fuel with gasoline, the flash point is lower than that of pure diesel fuel. When the engine is running, exhaust system components could overheat without being noticed. There is a risk of fire.

Never refuel with gasoline. Never mix gasoline with diesel fuel.

- ❗ Do not use gasoline to refuel vehicles with a diesel engine. Do not use diesel to refuel vehicles with a gasoline engine. Do not switch on the ignition if you accidentally refuel with the wrong fuel. Otherwise, the fuel will enter the fuel system. Even small amounts of the wrong fuel could result in damage to the fuel system and the engine. The repair costs are high. Notify a qualified specialist workshop and have the fuel tank and fuel lines drained completely.

- ❗ Do not use diesel to refuel vehicles with a gasoline engine. Do not switch on the ignition if you accidentally refuel with the wrong fuel. Otherwise, the fuel will enter the fuel system. Even small amounts of the wrong fuel could result in damage to the fuel system and the engine. Notify a qualified specialist workshop and have the fuel tank and fuel lines drained completely.

- ❗ Overfilling the fuel tank could damage the fuel system.

- ❗ Take care not to spill any fuel on painted surfaces. You could otherwise damage the paintwork.

- ❗ Use a filter when refueling from a fuel can. Otherwise, the fuel lines and/or injection system could be blocked by particles from the fuel can.

Do not get into the vehicle again during the refueling process. Otherwise, electrostatic charge could build up again.

If you overfill the fuel tank, fuel could spray out when the fuel pump nozzle is removed.

- ℹ Flexible Fuel vehicles can be recognized by the **Ethanol up to E85** sticker on the inside of the fuel filler flap.

For further information on fuel and fuel quality (> page 448).

Refueling

General information

Pay attention to the important safety notes (> page 177).

The fuel filler flap is unlocked or locked automatically when you open or close the vehicle with the SmartKey or with KEYLESS-GO.

The position of the fuel filler cap is displayed  in the instrument cluster. The arrow next to the filling pump indicates the side of the vehicle.

Opening the fuel filler flap

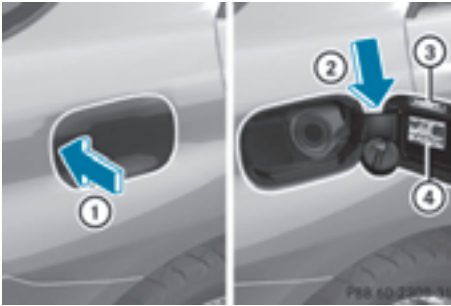

- ① To open the fuel filler flap
 - ② To insert the fuel filler cap
 - ③ Fuel type to be used
 - ④ Tire pressure table
- ▶ Switch the engine off.
 - ▶ Remove the SmartKey from the ignition lock.
 - ▶ KEYLESS-GO: open the driver's door. This corresponds to key position **0**: "key removed". The driver's door can be closed again.
 - ▶ Press the fuel filler flap in the direction of arrow ①. The fuel filler flap swings up.
 - ▶ Turn the fuel filler flap counter-clockwise and remove it.
 - ▶ Insert the fuel filler cap into the holder bracket on the inside of filler flap ②.
 - ▶ Completely insert the filler neck of the fuel pump nozzle into the tank, hook in place and refuel.
 - ▶ Only fill the tank until the pump nozzle switches off.
- i** Vehicles with a diesel engine: the filler neck is designed for refueling at diesel filling pumps.
 - i** Do not add any more fuel after the pump stops filling for the first time. Otherwise, fuel may leak out.

Closing the fuel filler flap

- ▶ Replace the cap on the filler neck and turn clockwise until it engages audibly.
- ▶ Close the fuel filler flap.

- i** Close the fuel filler flap before locking the vehicle.
- i** If you are driving with the fuel filler cap open, the reserve fuel warning lamp flashes.

In addition, the Check Engine warning lamp may light up (▷ page 327).

A message appears in the multifunction display (▷ page 302).

For further information on warning and indicator lamps in the instrument cluster, see (▷ page 327).

Problems with fuel and the fuel tank

This section provides descriptions of and solutions to safety-relevant problems. Descriptions of and solutions to further problems can be found in the Digital Operator's Manual.

Problem	Possible causes/consequences and ► Solutions
Fuel is leaking from the vehicle.	<p>The fuel line or the fuel tank is faulty.</p> <p> WARNING</p> <p>Risk of explosion or fire.</p> <ul style="list-style-type: none"> ► Turn the SmartKey to position 0 in the ignition lock and remove it immediately (▷ page 157). ► Do not restart the engine under any circumstances. ► Consult a qualified specialist workshop.

DEF (BlueTEC vehicles only)

Important notes on use

To function properly, BlueTEC exhaust gas aftertreatment must be operated with the reducing agent DEF. Adding DEF is one of the tasks performed during maintenance. Under normal operating conditions, a tank of DEF lasts until the next service due date.

When the supply of DEF is almost used up, the **Check Additive See Operator's Manual** message is shown in the multifunction display.

If you drive the vehicle faster than 10 mph (16 km/h), the **Check Additive See Operator's Manual** message goes out after approximately one minute.

When the supply of DEF is down to a reserve of approximately 1 gal (3.8 l) the **Refill AdBlue/DEF See Operator's Manual** message is shown in the multifunction display.

When the DEF supply drops to a minimum, the **Remaining Starts: 16** message is shown in the multifunction display.

If the **Refill AdBlue/DEF No Start in XXXX km** message is shown in the multifunction display, you can still drive the vehicle over the distance shown. If DEF is not refilled, you will subsequently be **unable to start the engine**. If the **Refill AdBlue/DEF Eng.**

Start Not Poss message appears in the multifunction display and the engine does not start, you must add DEF.

- Add at least 1 gal (3.8 l) of DEF.
- Switch on the ignition for at least 60 seconds.
- Start the engine.

 Have the DEF tank refilled at a qualified specialist workshop.

Use the special DEF refill bottle when adding DEF between maintenance intervals. Contact an authorized Mercedes-Benz Center with any questions or, if necessary, contact Roadside Assistance (▷ page 26).

If the outside temperature is below 12 °F (-11 °C) it may be difficult to top up. If DEF is frozen and there is an active warning indicator, it may not be possible to add DEF. Park the vehicle in a warmer place, e.g. in a garage, until DEF has become fluid again. It will then be possible to add DEF again. Alternatively, have the DEF tank refilled at a qualified specialist workshop.

Further information about BlueTEC exhaust gas aftertreatment and DEF is available at any authorized Mercedes-Benz Center.

Important safety notes on the refilling procedure

DEF is a water-soluble fluid for the exhaust gas aftertreatment of diesel engines. It is:

- not poisonous
- colorless and odorless
- not flammable

When you open the DEF container, small amounts of ammonia vapor may be released.

Ammonia vapors have a pungent odor and are particularly irritating to the skin, to mucous membranes and to the eyes. You may experience a burning sensation in your eyes, nose and throat. Coughing and watering of the eyes are possible.

Do not inhale ammonia vapors. Fill the DEF tank only in well-ventilated areas.

DEF must not come into contact with your skin, eyes or clothing and must not be swallowed. Keep DEF away from children.

If you or other persons come into contact with DEF, observe the following:

- Rinse DEF from your skin immediately with soap and water.
- If DEF comes into contact with your eyes, immediately rinse them thoroughly with clean water. Seek medical assistance without delay.
- If DEF has been swallowed, rinse your mouth out immediately. Drink plenty of water. Seek medical assistance without delay.
- Change out of clothing contaminated with DEF immediately.

! Only use DEF in accordance with ISO 2224 1. Do not mix any additives with DEF, and do not dilute DEF with water. This may destroy the BlueTEC exhaust gas aftertreatment system.

! The vehicle must be parked on level ground to fill the DEF tank. The DEF tank can only be filled as intended with the vehicle parked on a level surface. This avoids false level readings. Filling the tank is not

permitted if the vehicle is not parked on a level surface. There is a danger of overfilling, which could result in damage to components of the BlueTEC exhaust gas aftertreatment.

! Rinse surfaces that have come into contact with DEF immediately with water or remove DEF using a damp cloth and cold water. If the DEF has already crystallized, use a sponge and cold water to clean it. DEF residues crystallize after time and contaminate the affected surfaces.

! DEF is not a fuel additive and must not be added to the fuel tank. If DEF is added to the fuel tank, this can lead to engine damage.

For further information on DEF, see (▷ page 451).

You will find further information on DEF in the printed Operator's Manual under "Technical data".

Opening the DEF filler cap



The fuel filler flap is unlocked or locked automatically when you open or close the vehicle with the SmartKey or with KEYLESS-GO.

- ▶ Switch the ignition off.
- ▶ Press the fuel filler flap in the direction of arrow ①. The fuel filler flap swings up.
- ▶ Turn blue DEF filler cap ② counter-clockwise and remove it. DEF filler cap ② is secured with a plastic strip.

DEF refill bottle

! Only screw on the DEF refill bottle hand-tight. It could otherwise be damaged.



- ▶ Unscrew the protective cap from DEF refill bottle ①.
- ▶ Place DEF refill bottle ① on the filler neck as shown and screw it on clockwise until hand-tight.
- ▶ Press DEF refill bottle ① towards the filler neck.
The DEF tank is filled. This may take up to one minute.
- i** When DEF refill bottle ① is no longer pressed, filling stops and the bottle may be taken off again after being only partially emptied.
- ▶ Release DEF refill bottle ①.
- ▶ Turn DEF refill bottle ① counter-clockwise and remove it.
- ▶ Screw the protective cap onto DEF refill bottle ① again.

DEF refill bottles can be obtained at many gas stations or at an authorized Mercedes-Benz Center. Refill bottles without a threaded cap do not provide overfill protection. DEF may leak if overfilled. Mercedes Benz offers special refill bottles with a threaded seal. These are available at any authorized Mercedes-Benz Center.

Closing the DEF filler cap



- ▶ Mount DEF filler cap ② on the filler neck and turn it clockwise.
- ▶ To close the fuel filler flap, press it in the direction of arrow ①.
- ▶ Drive faster than 10 mph (16 km/h).
The **Check Additive See Operator's Manual** message goes out after approximately one minute.
- i** If the **Check Additive See Operator's Manual** message continues to be shown in the multifunction display, you must add more DEF.

Parking

Important safety notes

⚠ WARNING

Flammable material such as leaves, grass or twigs may ignite if they come into contact with hot parts of the exhaust system or exhaust gas flow. There is a risk of fire.

Park the vehicle so that no flammable materials come into contact with parts of the vehicle which are hot. Take particular care not to park on dry grassland or harvested grain fields.

⚠ WARNING

If you switch off the ignition while driving, safety-relevant functions are only available with limitations, or not at all. This could affect, for example, the power steering and the brake boosting effect. You will require considerably

more effort to steer and brake. There is a risk of an accident.

Do not switch off the ignition while driving.

 **WARNING**

If you leave children unsupervised in the vehicle, they could set it in motion by, for example:

- release the parking brake.
- shift the automatic transmission out of the parking position **P**.
- start the engine.

In addition, they may operate vehicle equipment and become trapped. There is a risk of an accident and injury.

When leaving the vehicle, always take the SmartKey with you and lock the vehicle. Never leave children unsupervised in the vehicle.

 Always secure the vehicle correctly against rolling away. Otherwise, the vehicle or its drivetrain could be damaged.

To ensure that the vehicle is secured against rolling away unintentionally:

- the electric parking brake must be applied.
- the transmission must be in position **P** and the SmartKey must be removed from the ignition lock.
- the front wheels must be turned towards the curb on steep uphill or downhill gradients.
- the empty vehicle must be secured at the front axle with a wheel chock or similar, for example, on uphill or downhill gradients.
- a laden vehicle must also be secured at the rear axle with a wheel chock or similar, for example, on uphill or downhill gradients.

Switching off the engine

Important safety notes

 **WARNING**

The automatic transmission switches to neutral position **N** when you switch off the engine.

The vehicle may roll away. There is a risk of an accident.

After switching off the engine, always switch to parking position **P**. Prevent the parked vehicle from rolling away by applying the parking brake.

Using the SmartKey

- ▶ Apply the electric parking brake.
- ▶ Shift the transmission to position **P**.
- ▶ Turn the SmartKey to position **0** in the ignition lock and remove it. The immobilizer is activated.

 If you turn off the engine with the SmartKey and then remove it from the ignition lock or open a front door, the automatic transmission shifts to **P** automatically.

Using KEYLESS-GO

- ▶ Apply the electric parking brake.
- ▶ Shift the transmission to position **P**.
- ▶ Press the Start/Stop button (▷ page 158). The engine stops and all the indicator lamps in the instrument cluster go out.

 If you turn off the engine with the Start/Stop button, the automatic transmission shifts to **N**. If you then open one of the front doors, the automatic transmission shifts to **P**.

 In the event of an emergency, the engine can be turned off while the vehicle is in motion by pressing and holding the Start/Stop button for three seconds.

Electric parking brake

General notes

WARNING

If you leave children unsupervised in the vehicle, they could set it in motion by, for example:

- release the parking brake.
- shift the automatic transmission out of the parking position **P**.
- start the engine.

In addition, they may operate vehicle equipment and become trapped. There is a risk of an accident and injury.

When leaving the vehicle, always take the SmartKey with you and lock the vehicle. Never leave children unsupervised in the vehicle.

The function of the electric parking brake is dependent on the on-board voltage. If the on-board voltage is low or there is a malfunction in the system, it may not be possible to apply the released parking brake.

- ▶ If this is the case, only park the vehicle on level ground and secure it to prevent it rolling away.
- ▶ Shift the automatic transmission to position **P**.

It may not be possible to release an applied parking brake if the on-board voltage is low or there is a malfunction in the system. Contact a qualified specialist workshop.

-  The electric parking brake performs a function test at regular intervals while the engine is switched off. The sounds that can be heard while this is occurring are normal.

Applying/releasing manually



- ▶ **To engage:** push handle ①.

When the electric parking brake is engaged, the **PARK** (USA only) or **(P)** (Canada only) red indicator lamp lights up in the instrument cluster.

-  The electric parking brake can also be applied when the SmartKey is removed.

- ▶ **To release:** pull handle ①.

The red **PARK** (USA only) or **(P)** (Canada only) indicator lamp in the instrument cluster goes out.

-  The electric parking brake can only be released:
 - if the SmartKey is in position **1** in the ignition lock (▷ page 157) or
 - if the ignition was switched on using the Start/Stop button.

To ensure that you do not roll backwards when pulling away on an uphill slope, engage the electric parking brake (▷ page 161).

Applying automatically

The electric parking brake is applied automatically:

- if DISTRONIC PLUS brings the vehicle to a standstill or
- if the HOLD function is keeping the vehicle stationary

In addition, at least one of the following conditions must be fulfilled:

- the engine is switched off.
- the driver's door is open and the seat belt is not fastened.
- the vehicle is stationary for a lengthy period.

The red **PARK** (USA only) or **(P)** (Canada only) indicator lamp in the instrument cluster lights up.

- i** The electric parking brake is not automatically engaged if the engine is switched off by the ECO start/stop function.

Releasing automatically

The electric parking brake is released automatically when all of the following conditions are fulfilled:

- the engine is running.
- the transmission is in position **D** or **R**.
- the seat belt has been fastened.
- you depress the accelerator pedal.

If the transmission is in position **R**, the trunk lid must be closed.

If your seat belt is not fastened, the following conditions must be fulfilled to automatically release the electric parking brake:

- the driver's door is closed.
- you have shifted out of transmission position **P** or you have previously driven faster than 2 mph (3 km/h).

- i** Ensure that you do not depress the accelerator pedal unintentionally. Otherwise the parking brake will be released and the vehicle will start to move.

Emergency braking

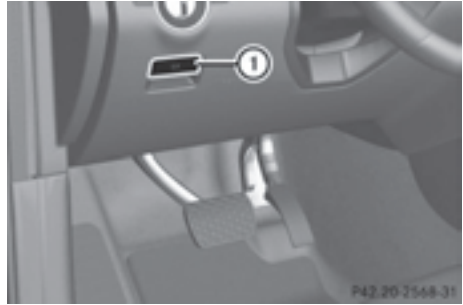

- ▶ While driving, push handle ① of the electric parking brake.

The vehicle can also be braked during an emergency by using the electric parking brake.

- i** The vehicle is braked for as long as the handle of the electric parking brake is pressed. The longer the electric parking brake handle is depressed, the greater the braking force.

During braking:

- a warning tone sounds
- the **Release Park. Brake** message appears
- the red **PARK** (USA only) or **(P)** (Canada only) indicator lamp in the instrument cluster flashes

When the vehicle has been braked to a standstill, the electric parking brake is engaged.

Parking the vehicle for a long period

If you leave the vehicle parked for longer than four weeks, the battery may be damaged by exhaustive discharging.

- ▶ Connecting a trickle charger.

- i** You can obtain information about trickle chargers from a qualified specialist workshop.

If you leave the vehicle parked for longer than six weeks, the vehicle may suffer damage as a result of lack of use.

- ▶ Visit a qualified specialist workshop and seek advice.

Driving tips

General notes

Important safety notes

WARNING

If you switch off the ignition while driving, safety-relevant functions are only available with limitations, or not at all. This could affect, for example, the power steering and the brake boosting effect. You will require considerably more effort to steer and brake. There is a risk of an accident.

Do not switch off the ignition while driving.

WARNING

If you operate mobile communication equipment while driving, you will be distracted from traffic conditions. You could also lose control of the vehicle. There is a risk of an accident.

Only operate this equipment when the vehicle is stationary.

Observe the legal requirements for the country in which you are driving. Some jurisdictions prohibit the driver from using a mobile phone while driving a vehicle.

If you make a call while driving, always use hands-free mode. Only operate the telephone when the traffic situation permits. If you are unsure, pull over to a safe location and stop before operating the telephone.

Bear in mind that at a speed of only 30 mph (approximately 50 km/h) the vehicle covers a distance of 44 ft (approximately 14 m) per second.

Drive sensibly – save fuel

Observe the following tips to save fuel:

- ▶ The tires should always be inflated to the recommended tire pressure.
- ▶ Remove unnecessary loads.
- ▶ Remove roof carriers when they are not needed.
- ▶ Warm up the engine at low engine speeds.
- ▶ Avoid frequent acceleration or braking.
- ▶ Have all maintenance work carried out as indicated by the service intervals in the Maintenance Booklet or by the service interval display.

Fuel consumption also increases when driving in cold weather, in stop-start traffic and in hilly terrain.

Drinking and driving

WARNING

Drinking and driving and/or taking drugs and driving are very dangerous combinations. Even a small amount of alcohol or drugs can affect your reflexes, perceptions and judgment.

The possibility of a serious or even fatal accident is greatly increased when you drink or take drugs and drive.

Do not drink or take drugs and drive or allow anyone to drive who has been drinking or taking drugs.

Emission control

WARNING

Combustion engines emit poisonous exhaust gases such as carbon monoxide. Inhaling these exhaust gases leads to poisoning. There is a risk of fatal injury. Therefore never leave the engine running in enclosed spaces without sufficient ventilation.

Certain engine systems are designed to keep the level of poisonous components in exhaust fumes within legal limits.

These systems only work at peak efficiency if they are serviced exactly in accordance with the manufacturer's specifications. For this reason, all work on the engine must be carried out by qualified and authorized Mercedes-Benz technicians.

The engine settings must not be changed under any circumstances. Furthermore, all specific service work must be carried out at regular intervals and in accordance with the Mercedes-Benz service requirements. Details can be found in the Maintenance Booklet.

ECO display



Example: ECO display

The ECO display provides feedback on how economical your driving characteristics are. The ECO display assists you in achieving the most economical driving style for the selected settings and prevailing conditions. Your driving style can significantly influence the vehicle's consumption.

The ECO display consists of three bars:

- **Acceleration**
- **Constant**
- **Coasting**

The percent value is the average value of the three bars. The three bars and the mean value begin at the value of 50%. A higher percentage indicates a more economical driving style.

The ECO display does not indicate the actual fuel consumption. A fixed percentage count in the ECO display does not indicate a fixed consumption.

Apart from driving style, consumption is dependent on many factors such as, e.g.:

- load
- tire pressure
- cold start
- choice of route
- electrical consumers switched on

These factors are not included in the ECO display.

The evaluation of your driving style is carried out using the following three categories:

- **Acceleration** (evaluation of all acceleration processes):
 - The bar fills up: moderate acceleration, especially at higher speeds
 - The bar empties: sporty acceleration
- **Constant** (assessment of driving behavior at all times):
 - The bar fills up: constant speed and avoidance of unnecessary acceleration and deceleration
 - The bar empties: fluctuations in speed
- **Coasting** (assessment of all deceleration processes):
 - The bar fills up: anticipatory driving, keeping your distance and early release of the accelerator. The vehicle can coast without use of the brakes.
 - The bar empties: frequent braking

i An economical driving style specially requires driving at moderate engine speeds.

To achieve a higher value in the categories **Acceleration** and **Constant**, observe the gearshift recommendations.

i On long journeys at a constant speed, e.g. on the highway, only the bar for **Constant** will change.

i The ECO display summarizes the driving characteristics from the start of the journey to its completion. For this reason, the bars change dynamically at the beginning of the journey. On longer journeys, there are

fewer changes. For more dynamic changes, carry out a manual reset.

For further information on the ECO display, see (▷ page 270).

Braking

Important safety notes

WARNING

If you shift down on a slippery road surface in an attempt to increase the engine's braking effect, the drive wheels could lose their grip. There is an increased danger of skidding and accidents.

Do not shift down for additional engine braking on a slippery road surface.

Downhill gradients

 On long and steep gradients, you must reduce the load on the brakes by shifting early to a lower gear. This allows you to take advantage of the engine braking effect and helps avoid overheating and excessive wear of the brakes.

When you take advantage of the engine braking effect, a drive wheel may not turn for some time, e.g. on a slippery road surface. This could cause damage to the drive train. This type of damage is not covered by the Mercedes-Benz warranty.

Do not depress the brake pedal continuously while the vehicle is in motion, e.g. causing the brakes to rub by constantly applying light pressure to the pedal. This results in excessive and premature wear to the brake pads.

Heavy and light loads

WARNING

If you rest your foot on the brake pedal while driving, the braking system can overheat. This increases the stopping distance and can even cause the braking system to fail. There is a risk of an accident.

Never use the brake pedal as a footrest. Never depress the brake pedal and the accelerator pedal at the same time.

 Depressing the brake pedal constantly results in excessive and premature wear to the brake pads.

If the brakes have been subjected to a heavy load, do not stop the vehicle immediately. Drive on for a short while. This allows the air-flow to cool the brakes more quickly.

Wet roads

If you have driven for a long time in heavy rain without braking, there may be a delayed reaction from the brakes when braking for the first time. This may also occur after the vehicle has been washed or driven through deep water.

You then have to depress the brake pedal more firmly. Maintain a greater distance from the vehicle in front.

After driving on a wet road or having the vehicle washed, brake firmly while paying attention to the traffic conditions. This will warm up the brake discs, thereby drying them more quickly and protecting them against corrosion.

Limited braking performance on salt-treated roads

If you drive on salted roads, a layer of salt residue may form on the brake discs and brake pads. This can result in a significantly longer braking distance.

- Brake occasionally to remove any possible salt residue. Make sure that you do not endanger other road users when doing so.
- Carefully depress the brake pedal and the beginning and end of a journey.
- Maintain a greater distance to the vehicle ahead.

Servicing the brakes

! If the red brake warning lamp lights up in the instrument cluster and you hear a warning tone while the engine is running, the brake fluid level may be too low. Observe additional warning messages in the multi-function display.

The brake fluid level may be too low due to brake pad wear or leaking brake lines.

Have the brake system checked immediately. This work should be carried out at a qualified specialist workshop.

! A function or performance test should only be carried out on a 2-axle dynamometer. If you are planning to have the vehicle tested on such a dynamometer, contact an authorized Mercedes-Benz Center to obtain further information first. Otherwise, you could damage the drive train or the brake system.

! Because ESP® is an automatic system, the engine and ignition must be switched off (SmartKey in position **0** or **1** or Start/Stop button in position **0** or **1**) when the electric parking brake is being tested on a brake dynamometer (maximum 10 seconds).

Braking triggered automatically by ESP® may seriously damage the brake system.

All checks and maintenance work on the brake system must be carried out at a qualified specialist workshop. Consult a qualified specialist workshop to arrange this.

Have brake pads installed and brake fluid replaced at a qualified specialist workshop.

If the brake system has only been subject to moderate loads, you should test the functionality of your brakes at regular intervals. To do so, depress the brake pedal firmly when driving at a high speed. This improves the grip of the brake pads.

You can find a description of Brake Assist (BAS) on (▷ page 68) or of BAS PLUS on (▷ page 69).

Mercedes-Benz recommends that you only have brake pads/linings installed on your vehicle which have been approved for Mercedes-Benz vehicles or which correspond to an equivalent quality standard. Brake pads/linings which have not been approved for Mercedes-Benz vehicles or which are not of an equivalent quality could affect your vehicle's operating safety.

Mercedes-Benz recommends that you only use brake fluid that has been specially approved for your vehicle by Mercedes-Benz, or which corresponds to an equivalent quality standard. Brake fluid which has not been approved for Mercedes-Benz vehicles or which is not of an equivalent quality could affect your vehicle's operating safety.

High-performance brake system for AMG vehicles

The high-performance brake system is only available on AMG vehicles.

The high-performance brake system is designed for heavy loads. This may lead to noise when braking. This will depend on:

- speed
- braking force
- environmental conditions, such as temperature and humidity

The wear of individual components of the brake system, such as the brake pads/linings or brake discs, depends on the individual driving style and operating conditions.

For this reason, it is impossible to state a mileage that will be valid under all circumstances. An aggressive driving style will lead to high wear. You can obtain further information about this from your authorized Mercedes-Benz Center.

New and replaced brake pads and discs only reach their optimum braking effect after several hundred kilometers of driving. Compensate for this by applying greater force to the brake pedal. Keep this in mind, and adapt

your driving and braking accordingly during this break-in period.

Excessive heavy braking results in correspondingly high brake wear. Observe the  brake wear warning lamp in the instrument cluster and note any brake status messages in the multifunction display. Especially for high performance driving, it is important to maintain and have the brake system checked regularly.

Driving on wet roads

Hydroplaning

If water has accumulated to a certain depth on the road surface, there is a danger of hydroplaning occurring, even if:

- you drive at low speeds.
- the tires have adequate tread depth.

For this reason, in the event of heavy rain or in conditions in which hydroplaning may occur, you must drive in the following manner:

- lower your speed.
- avoid ruts.
- avoid sudden steering movements.
- brake carefully.

Driving on flooded roads

! Do not drive through flooded areas. Check the depth of any water before driving through it. Drive slowly through standing water. Otherwise, water may enter the vehicle interior or the engine compartment. This can damage the electronic components in the engine or the automatic transmission. Water can also be drawn in by the engine's air suction nozzles and this can cause engine damage.

i Vehicles with the AIRMATIC package: set the raised level before driving through standing water.

Off-road fording

! Under no circumstances should you accelerate before entering the water. The bow wave could cause water to enter and damage the engine and other assemblies.

! Do not open any of the vehicle's doors while fording. Otherwise, water could get into the vehicle interior and damage the vehicle's electronics and interior equipment.

- Establish how deep the water is and the characteristics of the body of water before fording.
- **Vehicles with the AIRMATIC package:** select the highest possible vehicle level.
- Shift to a lower gear using the left-hand steering wheel paddle shifter.
- Avoid high engine speeds.
- Enter and exit the water at a flat place and at a steady walking pace.
- Drive slowly and at an even speed through the water.
- Do not stop.
- Water offers a high degree of resistance, and the ground is slippery and in some cases unstable. Therefore, it is difficult and dangerous to pull away in the water.
- Ensure that a bow wave does not form as you drive.
- Clean any mud from the tire tread after fording.
- Apply the brakes to dry them after fording.

Always observe the fording depth values (> page 457).

Winter driving

WARNING

If you shift down on a slippery road surface in an attempt to increase the engine's braking effect, the drive wheels could lose their grip. There is an increased danger of skidding and accidents.

Do not shift down for additional engine braking on a slippery road surface.

DANGER

If the exhaust pipe is blocked or adequate ventilation is not possible, poisonous gases such as carbon monoxide (CO) may enter the vehicle. This is the case, e.g. if the vehicle becomes trapped in snow. There is a risk of fatal injury.

If you leave the engine or the auxiliary heating running, make sure the exhaust pipe and area around the vehicle are clear of snow. To ensure an adequate supply of fresh air, open a window on the side of the vehicle that is not facing into the wind.

Have your vehicle winter-proofed at a qualified specialist workshop at the onset of winter.

Drive particularly carefully on slippery road surfaces. Avoid sudden acceleration, steering and braking maneuvers. Do not use the cruise control or DISTRONIC PLUS.

If the vehicle threatens to skid or cannot be stopped when moving at low speed:

- Shift the transmission to position **N**.

Vehicles with the ON&OFFROAD package: if driving in snow or with snow chains, select the snow program (▷ page 248) with the off-road program selector wheel in the center console.

i Vehicles with a diesel engine: do not cover the radiator, e.g. with a protective cover. The measuring function of the onboard diagnosis system may otherwise provide inaccurate values. Some of these values are required by law and must therefore always be accurate.

The outside temperature indicator is not designed to serve as an ice-warning device and is therefore unsuitable for that purpose. Changes in the outside temperature are displayed after a short delay.

Indicated temperatures just above the freezing point do not guarantee that the road surface is free of ice. The road may still be icy, especially in wooded areas or on bridges. You should pay special attention to road conditions when temperatures are around the freezing point.

For more information on driving with snow chains, see (▷ page 403).

For more information on driving with summer tires, see (▷ page 402).

Observe the notes in the "Winter operation" section (▷ page 402).

Off-road driving

Important safety notes

WARNING

If you drive on a steep incline at an angle or turn when driving on an incline, the vehicle could slip sideways, tip and rollover. There is a risk of an accident.

Always drive on a steep incline in the line of fall (straight up or down) and do not turn the vehicle.

WARNING

If the vehicle level is high, the vehicle center of gravity is raised. This could cause the vehicle to tip over more easily on uphill or downhill gradients. There is a risk of an accident.

Select the lowest possible vehicle level.

When driving off-road, sand, mud and water, possibly mixed with oil, for example, could get into the brakes. This could result in a reduced braking effect or in total brake failure and also in increased wear and tear. The braking characteristics change depending on the material ingressing the brakes. Clean the brakes after driving off-road. If you detect a reduced braking effect or grinding noises, have the brake system checked in a qualified specialist workshop as soon as possible. Adapt your driving style to the different braking characteristics.

Driving off-road increases the likelihood of damage to the vehicle, which, in turn, can lead to failure of the mechanical assembly or systems. Adapt your driving style to suit the terrain conditions. Drive carefully. Have damage to the vehicle rectified immediately at a qualified specialist workshop.

Do not switch to transmission position **N** when driving off-road. You could lose control of the vehicle if you attempt to brake using the service brake. If the gradient is too steep, drive backwards in reverse gear.

General notes

Read this section carefully before driving your vehicle off-road. Practice by driving over more gentle off-road terrain first.

Familiarize yourself with the characteristics of your vehicle and the gear shift operation before driving through difficult terrain.

The following driving systems are specially adapted to off-road driving:

- Off-road program 1 and 2 (vehicles with the ON&OFFROAD package) (▷ page 251)
- LOW RANGE off-road gear (vehicles with the ON&OFFROAD package) (▷ page 253)
- Differential lock (vehicles with the ON&OFFROAD package) (▷ page 252)
- Off-road ABS (▷ page 68)
- Off-road 4ETS (▷ page 73)
- AIRMATIC package (vehicle level) (▷ page 211)
- DSR (Downhill Speed Regulation) (▷ page 250)

Observe the following notes:

- Stop the vehicle before starting to drive along an off-road route.
- **For vehicles with the AIRMATIC package:** select a vehicle level that is suitable for the off-road terrain. To avoid damaging the vehicle, make sure there is always sufficient ground clearance.

- Check that items of luggage and loads are stowed safely and are well secured (▷ page 339).
- Always keep the engine running and in gear when driving on a downhill gradient. Activate DSR (▷ page 250).
- Always keep the doors, tailgate, windows and sliding sunroof closed while driving.
- Adapt your speed to the terrain. The rougher, steeper or more rutted the terrain, the slower your speed should be.
- Drive slowly and at an even speed through the water. Ensure that a bow wave does not form as you drive.
- Drive with extreme care on unfamiliar off-road routes where visibility is poor. For safety reasons, get out of the vehicle first and survey the off-road route.
- Look out for obstacles, such as rocks, holes, tree stumps and furrows.
- Check the depth of water before fording rivers and streams.
- When fording, do not stop and do not switch off the engine.
- On sand, drive quickly to overcome the rolling resistance. Otherwise the vehicle's wheels could become stuck in loose ground.
- Do not jump with the vehicle as this will interrupt the vehicle's propulsion.
- Always keep the engine running and in gear when driving on a slope.
- Do not shift the automatic transmission to transmission position **N**.

i Do not use the HOLD function when driving off-road, on steep uphill or downhill gradients or on slippery or loose surfaces. The HOLD function cannot hold the vehicle on such surfaces.

Checklist before driving off-road

! If the engine oil warning lamp lights up while the vehicle is in motion, stop the vehicle in a safe place as soon as possible.

Check the engine oil level. The engine oil warning lamp warning must not be ignored. Continuing the journey while the symbol is displayed could lead to engine damage.

- ▶ **Engine oil level:** check the engine oil level and add oil if necessary.

When driving on steep gradients, the engine oil level must be sufficiently high to ensure a correct oil supply in the vehicle.

- ▶ **DEF tank (BlueTEC vehicles):** check the level and top up if necessary (▷ page 180).
- ▶ **Tire-changing tool kit:** check that the jack is working and make sure you have the lug wrench, a robust tow cable and a folding spade in the vehicle.
- ▶ **Wheels and tires:** check the tire tread depth and tire pressure.
- ▶ Check for damage and remove any foreign objects, e.g. small stones, from the wheels/tires.
- ▶ Replace any missing valve caps.
- ▶ Replace dented or damaged wheels.
- ▶ **Rims:** dented or bent rims can result in a loss of tire pressure and damage the tire bead. Therefore, check your rims before driving off-road and replace them as required.

Checklist after driving off-road

- ❗ If you detect damage to the vehicle after driving off-road, have the vehicle checked immediately at a qualified specialist workshop.
- ▶ **Vehicles with the ON&OFFROAD package:** activate the on-road program (▷ page 251).
- ▶ Deactivate the LOW RANGE off-road gear (▷ page 253).
- ▶ Deactivate DSR (▷ page 250).
- ▶ **Vehicles with the AIRMATIC package:** lower the vehicle to a ride height suitable for the road conditions, e.g. to the highway/high-speed level.

- ▶ Clean the headlamps and rear lights and check for damage.
- ▶ Clean the front and rear license plates.
- ▶ Clean the wheels/tires with a water jet and remove any foreign objects.
- ▶ Clean the wheels, wheel housings and the vehicle underside with a water jet; check for any foreign objects and damage.
- ▶ Check whether twigs or other parts of plants have become trapped. These increase the risk of fire and can damage fuel pipes, brake hoses or the rubber bellows of the axle joints and propeller shafts.
- ▶ After the trip, examine without fail the entire undercarriage, wheels, tires, brakes, bodywork structure, steering, chassis and exhaust system for damage.
- ▶ After driving for extended periods across sand, mud, gravel, water or in similarly dirty conditions, have the brake discs, wheels, brake pads/linings and axle joints checked and cleaned.
- ▶ If you detect strong vibrations after off-road travel, check for foreign objects in the wheels and drive train and remove them if necessary. Foreign objects can disturb the balance and cause vibrations.

Driving over rough terrain places greater demands on your vehicle than driving on normal roads. After driving off-road, check the vehicle. This allows you to detect damage promptly and reduce the risk of an accident to yourself and other road users.

Driving on sand

Observe the following rules when driving on sand:

- **Vehicles with the ON&OFFROAD package:** select off-road program 1 (▷ page 251).
- **Vehicles with the AIRMATIC package:** select a raised vehicle level.
- Avoid high engine speeds.

- Use the left-hand steering wheel paddle shifter to shift to a lower gear appropriate to the terrain.
- Drive quickly to overcome the rolling resistance. Otherwise the vehicle's wheels could become stuck in loose ground.
- Drive in the tracks of other vehicles if possible. Make sure that:
 - the tire ruts are not too deep.
 - the sand is sufficiently firm.
 - the ground clearance of the vehicle is sufficient.

Tire ruts and gravel roads

! Check that the ruts are not too deep and that your vehicle has sufficient clearance. Otherwise, your vehicle could be damaged or bottom out and get stuck.

Observe the following rules when driving along ruts in off-road terrain or on roads with loose gravel:

- **Vehicles with the AIRMATIC package:** select a raised vehicle level.
- Avoid high engine speeds.
- Shift to a lower gear using the left-hand steering wheel paddle shifter.
- Drive slowly.
- Where ruts are too deep, drive with the wheels of one side on the center grassy area, if possible.

Driving over obstacles

! Obstacles could damage the floor of the vehicle or components of the chassis. Ask passengers for guidance when driving over large obstacles. The passenger should always keep a safe distance from the vehicle when doing so in order to avoid injury as a result of unexpected vehicle movements. After driving off-road or over obstacles, check the vehicle for possible damage, especially to the underbody and the components of the chassis.



Observe the following rules when driving over tree stumps, large stones and other obstacles:

- Select the LOW RANGE (▷ page 253) off-road gear.
- Raise the vehicle level.
- Avoid high engine speeds.
- Shift to a lower gear using the left-hand steering wheel paddle shifter.
- Drive very slowly.
- Drive straight over the center of obstacles.

Traveling uphill

Approach/departure angle

WARNING

If you drive on a steep incline at an angle or turn when driving on an incline, the vehicle could slip sideways, tip and rollover. There is a risk of an accident.

Always drive on a steep incline in the line of fall (straight up or down) and do not turn the vehicle.

- Observe the rules on off-road driving.
- Do not drive at an angle on slopes, inclines or gradients, but instead follow the direct line of fall. The maximum gradient-climbing capability of your vehicle is 100%, which corresponds to an approach/departure angle of 45°. Note that the climbing ability of your vehicle depends on the terrain conditions.

- When driving down an incline, make use of the engine's braking effect. Observe the engine speed; do not overrev the engine.
- Before driving on extreme uphill and downhill gradients, select the LOW RANGE off-road gear (▷ page 253).
- Drive slowly.
- Avoid high engine speeds. Drive at appropriate engine speeds (maximum 3,000 rpm).
- Use the left-hand paddle shifter to shift into a lower gear in good time on long and steep downhill gradients.
- Check the brakes after prolonged off-road driving.

i Hill start assist will aid you when pulling away on a hill.

For further information about hill start assist, see (▷ page 161).

Do not switch to transmission position **N** when driving off-road. If you try to brake the vehicle using the service brake, you could lose control of the vehicle. If the gradient is too steep for your vehicle, drive back down in reverse gear.

Always observe the approach/departure angle values (▷ page 458).

Maximum gradient-climbing capability

Always observe the maximum gradient climbing ability values (▷ page 458).

Hilltops

When driving up an uphill gradient, slightly reduce pressure on the accelerator immediately before reaching the brow of the hill. Use the vehicle's own impetus to drive over the top of the hill.

This style of driving prevents:

- the vehicle from lifting off the ground on the brow of a hill
- the vehicle from traveling too quickly down the other side

Driving downhill

- Drive slowly.
- Do not drive at an angle down steep inclines. Steer into the line of fall and drive with the front wheels aligned straight. Otherwise, the vehicle could slip sideways, tip and rollover.
- Shift to a lower gear using the left-hand paddle shifter before tackling steep downhill gradients.
- Activate DSR. If this is not sufficient, brake gently. When doing so, make sure that the vehicle is facing in the direction of the line of fall.
- Check that the brakes are working normally after a long downhill stretch.

i The special off-road ABS setting enables a precise, brief and repeated locking of the front wheels. This causes them to dig into loose earth. Be aware that the front wheels easily skid across the ground surface if completely braked and therefore lose their ability to steer.

Driving systems

Cruise control

General notes

Cruise control maintains a constant road speed for you. It brakes automatically in order to avoid exceeding the set speed. You must select a lower gear in good time on long and steep downhill gradients, especially if the vehicle is laden or towing a trailer. By doing so, you will make use of the braking effect of the engine. This relieves the load on the brake system and prevents the brakes from overheating and wearing too quickly.

Use cruise control only if road and traffic conditions make it appropriate to maintain a steady speed for a prolonged period. You can store any road speed above 20 mph (30 km/h).

- i** Cruise control should not be activated when driving off-road.

Important safety notes

If you fail to adapt your driving style, cruise control can neither reduce the risk of an accident nor override the laws of physics. Cruise control cannot take into account the road, traffic and weather conditions. Cruise control is only an aid. You are responsible for the distance to the vehicle in front, for vehicle speed, for braking in good time and for staying in your lane.

Do not use cruise control:

- in road and traffic conditions which do not allow you to maintain a constant speed e.g. in heavy traffic or on winding roads
- on slippery road surfaces. Braking or accelerating could cause the drive wheels to lose traction and the vehicle could then skid
- when there is poor visibility, e.g. due to fog, heavy rain or snow

If there is a change of drivers, advise the new driver of the speed stored.

Cruise control lever

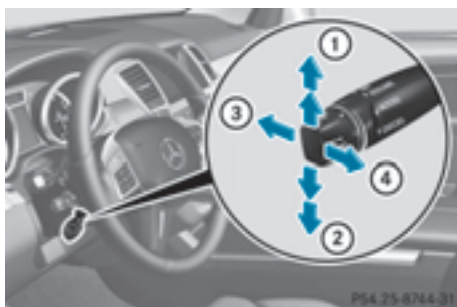

- ① To activate or increase speed
- ② To activate or reduce speed
- ③ To deactivate cruise control
- ④ To activate at the current speed/last stored speed

When you activate cruise control, the stored speed is shown in the multifunction display for five seconds.

Activation conditions

To activate cruise control, all of the following activation conditions must be fulfilled:

- the electric parking brake must be released.
- you are driving faster than 20 mph (30 km/h).
- ESP® must be active, but not intervening.
- the transmission must be in position **D**.
- DSR must be deactivated.
- off-road program 2 must be deactivated (vehicles with the ON&OFFROAD package).

Storing, maintaining and calling up a speed

Storing and maintaining a speed

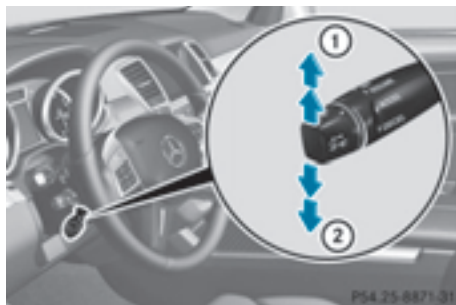

- ▶ Accelerate the vehicle to the desired speed.
- ▶ Briefly press the cruise control lever up ① or down ②.
- ▶ Remove your foot from the accelerator pedal.
Cruise control is activated. The vehicle automatically maintains the stored speed.

You can accept the current speed if you are driving faster than 20 mph (30 km/h).

- i** Cruise control may be unable to maintain the stored speed on uphill gradients. The stored speed is resumed when the gradient evens out. Cruise control maintains the stored speed on downhill gradients by automatically applying the brakes.

Storing or calling up a speed

WARNING

If you call up the stored speed and it differs from the current speed, the vehicle accelerates or decelerates. If you do not know the stored speed, the vehicle could accelerate or brake unexpectedly. There is a risk of an accident.

Pay attention to the road and traffic conditions before calling up the stored speed. If you do not know the stored speed, store the desired speed again.



- ▶ Briefly pull the cruise control lever towards you ①.
- ▶ Remove your foot from the accelerator pedal.
The first time cruise control is activated, it stores the current speed or regulates the speed of the vehicle to the previously stored speed.

Setting a speed

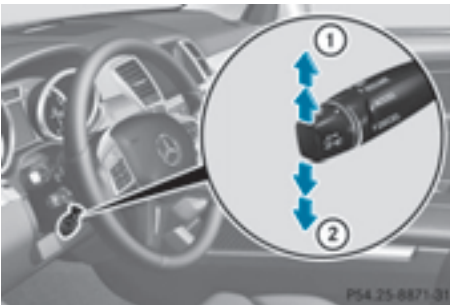

Keep in mind that it may take a brief moment until the vehicle has accelerated or braked to the speed set.

- ▶ Press the cruise control lever up ① for a higher speed or down ② for a lower speed.
- ▶ **To adjust the set speed in 1 mph increments (1 km/h increments):** briefly press the cruise control lever up ① or down ② to the pressure point. Every time the cruise control lever is pressed up ① or down ② the last speed stored is increased or reduced.
- ▶ **To adjust the set speed in 5 mph increments (10 km/h increments):** briefly press the cruise control lever up ① or down ② to the pressure point. Every time the cruise control lever is pressed up ① or down ② the last speed stored is increased or reduced.

i Cruise control is not deactivated if you depress the accelerator pedal. For example, if you accelerate briefly to overtake, cruise control adjusts the vehicle's speed to the last speed stored after you have finished overtaking.

Deactivating cruise control

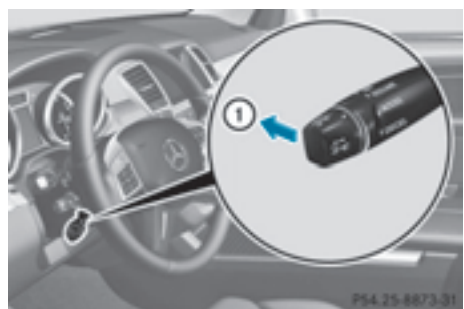

There are several ways to deactivate cruise control:

- ▶ Briefly press the cruise control lever forwards ①.
- or
- ▶ Brake.

Cruise control is automatically deactivated if:

- you engage the electric parking brake
- you are driving at less than 20 mph (30 km/h)
- ESP® intervenes or you deactivate ESP®
- you activate DSR
- you activate off-road program 2 on vehicles with the ON&OFFROAD package
- you shift the transmission to position **N** while driving

If cruise control is deactivated, you will hear a warning tone. You will see the **Cruise Control Off** message in the multifunction display for approximately five seconds.

- i** When you switch off the engine, the last speed stored is cleared.

DISTRONIC PLUS

General notes

DISTRONIC PLUS regulates the speed and automatically helps you maintain the distance to the vehicle detected in front. DISTRONIC PLUS brakes automatically so that the set speed is not exceeded.

You must select a lower gear in good time on long and steep downhill gradients, especially if the vehicle is laden or towing a trailer. By doing so, you will make use of the braking effect of the engine. This relieves the load on the brake system and prevents the brakes from overheating and wearing too quickly.

If DISTRONIC PLUS detects a slower-moving vehicle in front, your vehicle is braked in order to maintain the preset distance to the vehicle in front.

If DISTRONIC PLUS detects that there is a risk of a collision, you will be warned visually and acoustically. DISTRONIC PLUS cannot prevent a collision without your intervention. An intermittent warning tone will then sound and the distance warning lamp will light up in the instrument cluster. Brake immediately in order to increase the distance to the vehicle

in front or take evasive action provided it is safe to do so.

For DISTRONIC PLUS to assist you, the radar sensor system must be operational.

If there is no vehicle in front, DISTRONIC PLUS operates in the same way as cruise control in the speed range between 20 mph (Canada: 30 km/h) and 120 mph (Canada: 200 km/h). If a vehicle is driving in front of you, it operates in the speed range between 0 mph (0 km/h) and 120 mph (Canada: 200 km/h).

Do not use DISTRONIC PLUS while driving on roads with steep gradients.

As DISTRONIC PLUS transmits radar waves, it can resemble the radar detectors of the responsible authorities. You can refer to the relevant chapter in the Operator's Manual if questions are asked about this.

- i** USA only:

This device has been approved by the FCC as a "Vehicular Radar System". The radar sensor is intended for use in an automotive radar system only. Removing, tampering with, or altering the device will void any warranties, and is not permitted by the FCC. Do not tamper with, alter, or use in any non-approved way.

Any unauthorized modification to this device could void the user's authority to operate the equipment.

- i** Canada only: This device complies with RSS-210 of Industry Canada. Operation is subject to the following two conditions:

1. This device may not cause harmful interference, and
 2. this device must accept any interference received, including interference that may cause undesired operation of the device.
- Removal, tampering, or altering of the device will void any warranties, and is not permitted. Do not tamper with, alter, or use in any non-approved way.

Any unauthorized modification to this device could void the user's authority to operate the equipment.

Important safety notes

WARNING

DISTRONIC PLUS does not react to:

- people or animals
- stationary obstacles on the road, e.g. stopped or parked vehicles
- oncoming and crossing traffic

As a result, DISTRONIC PLUS may neither give warnings nor intervene in such situations.

There is a risk of an accident.

Always pay careful attention to the traffic situation and be ready to brake.

WARNING

DISTRONIC PLUS cannot always clearly identify other road users and complex traffic situations.

In such cases, DISTRONIC PLUS may:

- give an unnecessary warning and then brake the vehicle
- neither give a warning nor intervene
- accelerate unexpectedly

There is a risk of an accident.

Continue to drive carefully and be ready to brake, in particular when warned to do so by DISTRONIC PLUS.

WARNING

DISTRONIC PLUS brakes your vehicle with up to 40% of the maximum braking force. If this braking force is insufficient, DISTRONIC PLUS warns you visually and audibly. There is a risk of an accident.

In such cases, apply the brakes yourself and try to take evasive action.

! If DISTRONIC PLUS or the HOLD function is activated, the vehicle brakes automatically in certain situations. To prevent damage to the vehicle, deactivate DISTRONIC PLUS and the HOLD function in the following or other similar situations:

- when towing the vehicle
- in the car wash

If you fail to adapt your driving style, DISTRONIC PLUS can neither reduce the risk of accident nor override the laws of physics. DISTRONIC PLUS cannot take into account the road, traffic and weather conditions. DISTRONIC PLUS is only an aid. You are responsible for the distance to the vehicle in front, for vehicle speed, for braking in good time and for staying in your lane.

Do not use DISTRONIC PLUS:

- in road and traffic conditions which do not allow you to maintain a constant speed e.g. in heavy traffic or on winding roads
- on slippery road surfaces. Braking or accelerating could cause the drive wheels to lose traction and the vehicle could then skid
- when there is poor visibility, e.g. due to fog, heavy rain or snow

DISTRONIC PLUS may not detect narrow vehicles driving in front, e.g. motorcycles, or vehicles driving on a different line.

In particular, the detection of obstacles can be impaired if:

- dirt on the sensors or anything else covering the sensors
- snow or heavy rain
- interference by other radar sources
- strong radar reflections, for example, in parking garages

If DISTRONIC PLUS no longer detects a vehicle in front, DISTRONIC PLUS may unexpectedly accelerate the vehicle to the stored speed.

This speed may:

- be too high if you are driving in a filter lane or an exit lane
- be so high when driving in the right-hand lane that you overtake vehicles in the left-hand lane
- be so high when driving in the left-hand lane that you overtake vehicles in the right-hand lane

If there is a change of drivers, advise the new driver of the speed stored.

Cruise control lever

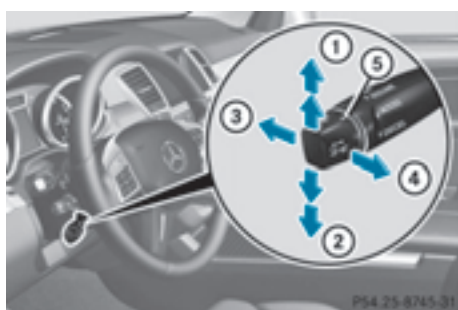

- ① To activate or increase speed
- ② To activate or reduce speed
- ③ To deactivate DISTRONIC PLUS
- ④ To activate at the current speed/last stored speed
- ⑤ To set the specified minimum distance

Activating DISTRONIC PLUS

Activation conditions

In order to activate DISTRONIC PLUS, the following conditions must be fulfilled:

- the engine must be started. It may take up to two minutes after pulling away before DISTRONIC PLUS is operational.
- the electric parking brake must be released.
- ESP® must be active, but not intervening.
- the transmission must be in position **D**.

- the driver's door must be closed when you shift from **P** to **D** or your seat belt must be fastened.
- the front-passenger door and rear doors must be closed.
- off-road program 2 must be deactivated (vehicles with the ON&OFFROAD package).
- DSR must be deactivated.
- the vehicle must not skid.

Activating

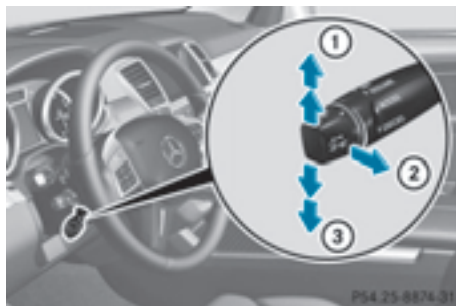

- ▶ Briefly pull the cruise control lever towards you ② or press it up ① or down ③ . DISTRONIC PLUS is selected.
- ▶ **To adjust the set speed in 1 mph increments (1 km/h increments):** briefly press the cruise control lever up ① to the pressure point for a higher speed or down ③ for a lower speed. Every time the cruise control lever is pressed up or down, the last speed stored is increased or reduced.

or

- ▶ **To adjust the set speed in 5 mph increments (10 km/h increments):** briefly press the cruise control lever up ① past

the pressure point for a higher speed or down ③ for a lower speed. Every time the cruise control lever is pressed up or down, the last speed stored is increased or reduced.

- ▶ Remove your foot from the accelerator pedal. Your vehicle adapts its speed to that of the vehicle in front, but only up to the desired stored speed.

When driving at speeds below 20 mph (30 km/h), you can only activate DISTRONIC PLUS if the vehicle in front has been detected and is shown in the multifunction display. If the vehicle in front is no longer detected and displayed, for example because it has changed lanes, DISTRONIC PLUS is deactivated. You will hear a warning tone if this is the case.

- ⓘ If you do not fully release the accelerator pedal, the **DISTRONIC PLUS Passive** message appears in the multifunction display. The set distance to a slower-moving vehicle in front will then not be maintained. You will be driving at the speed you determine by the position of the accelerator pedal.

Activating at the current speed/last stored speed

⚠ WARNING

If you call up the stored speed and it differs from the current speed, the vehicle accelerates or decelerates. If you do not know the stored speed, the vehicle could accelerate or brake unexpectedly. There is a risk of an accident.

Pay attention to the road and traffic conditions before calling up the stored speed. If you do not know the stored speed, store the desired speed again.

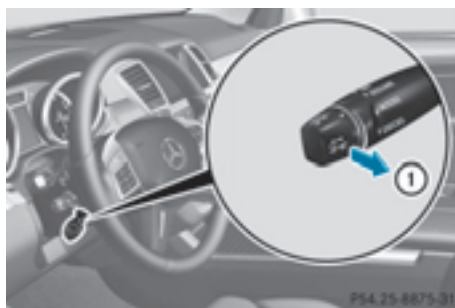

- ▶ Briefly pull the cruise control lever towards you ①.
- ▶ Remove your foot from the accelerator pedal. DISTRONIC PLUS is activated. The first time it is activated, the current speed is stored. Otherwise, it sets the vehicle cruise speed to the previously stored value.

Driving with DISTRONIC PLUS

Pulling away and driving

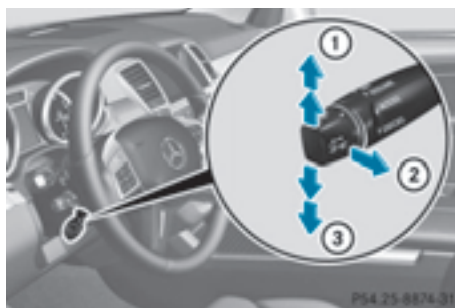

- ▶ **If you want to pull away with DISTRONIC PLUS:** remove your foot from the brake pedal.
 - ▶ Briefly pull the cruise control lever towards you ② or press it up ① or down ③ .
- or
- ▶ Accelerate briefly. Your vehicle pulls away and adapts its speed to that of the vehicle in front.

If there is no vehicle in front, DISTRONIC PLUS operates in the same way as cruise control.

If DISTRONIC PLUS detects that the vehicle in front has slowed down, it brakes your vehicle. In this way, the distance you have selected is maintained.

If DISTRONIC PLUS detects a faster-moving vehicle in front, it increases the driving speed. However, the vehicle is only accelerated up to the speed you have stored.

If you depress the brake, DISTRONIC PLUS is deactivated unless your vehicle is stationary.

Changing lanes

If you change to the passing lane, DISTRONIC PLUS supports you when:

- you are driving faster than 40 mph (60 km/h)
- DISTRONIC PLUS is maintaining the distance to a vehicle in front
- you switch on the appropriate turn signal
- DISTRONIC PLUS does not detect a danger of collision

If these conditions are fulfilled, your vehicle is accelerated. Acceleration will be interrupted if changing lanes takes too long or if the distance between your vehicle and the vehicle in front becomes too small.

- i** When changing lanes, DISTRONIC PLUS monitors the left lane on left-hand drive vehicles and the right lane on right-hand drive vehicles.

Stopping

WARNING

When leaving the vehicle, even if it is braked only by DISTRONIC PLUS, it could roll away if:

- there is a malfunction in the system or in the voltage supply.
- DISTRONIC PLUS has been deactivated with the cruise control lever, e.g. by a vehicle occupant or from outside the vehicle.
- the electrical system in the engine compartment, the battery or the fuses have been tampered with.

- the battery is disconnected.
- the accelerator pedal has been depressed, e.g. by a vehicle occupant.

There is a risk of an accident.

If you wish to exit the vehicle, always turn off DISTRONIC PLUS and secure the vehicle against rolling away.

If DISTRONIC PLUS detects that the vehicle in front is stopping, it brakes your vehicle until it is stationary.

Once your vehicle is stationary, it remains stationary and you do not need to depress the brake.

After a time, the electric parking brake secures the vehicle and relieves the service brake.

Depending on the specified minimum distance, your vehicle will come to a standstill at a sufficient distance behind the vehicle in front. The specified minimum distance is set using the control on the cruise control lever.

The electric parking brake automatically secures the vehicle if DISTRONIC PLUS is activated and:

- the driver's door is open and the driver's seat belt is unfastened.
- the engine is switched off, unless it is automatically switched off by the ECO start/stop function.
- a system malfunction occurs.
- the power supply is not sufficient.

On steep uphill or downhill inclines or if there is a malfunction, the transmission may also automatically be shifted into position **P**.

Setting a speed

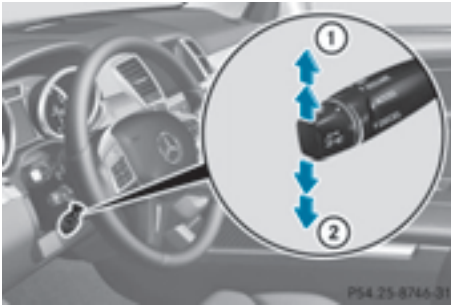

Keep in mind that it may take a brief moment until the vehicle has accelerated or braked to the speed set.

- ▶ Press the cruise control lever up ① for a higher speed or down ② for a lower speed.
 - ▶ **To adjust the set speed in 1 mph increments (1 km/h increments):** briefly press the cruise control lever up ① or down ② to the pressure point. Every time the cruise control lever is pressed up ① or down ② the last speed stored is increased or reduced.
 - ▶ **To adjust the set speed in 5 mph increments (10 km/h increments):** briefly press the cruise control lever up ① or down ② to the pressure point. Every time the cruise control lever is pressed up ① or down ②, the last speed stored is increased or reduced.
- i** If you accelerate to overtake, DISTRONIC PLUS adjusts the vehicle's speed to the last speed stored after you have finished overtaking.

Setting the specified minimum distance

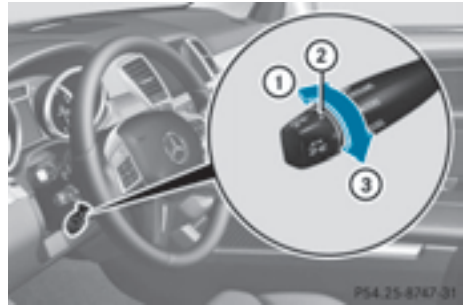

You can set the specified minimum distance for DISTRONIC PLUS by varying the time span between one and two seconds. With this function, you can set the minimum distance that DISTRONIC PLUS keeps to the vehicle in front, dependent on vehicle speed. You can see this distance in the multifunction display (▷ page 205).

- ▶ **To increase:** turn control ② in direction ③. DISTRONIC PLUS then maintains a greater distance between your vehicle and the vehicle in front.
 - ▶ **To decrease:** turn control ② in direction ①. DISTRONIC PLUS then maintains a shorter distance between your vehicle and the vehicle in front.
- i** Make sure that you maintain a sufficiently safe distance from the vehicle in front. Adjust the distance to the vehicle in front if necessary.

Deactivating DISTRONIC PLUS

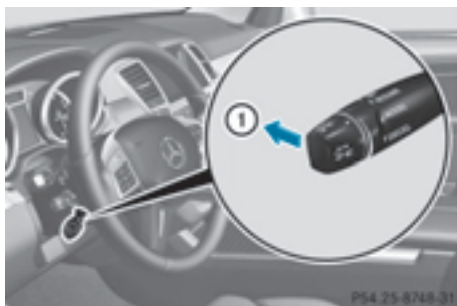

There are several ways to deactivate DISTRONIC PLUS:

▶ Briefly press the cruise control lever forwards ①.

or

▶ Brake, unless the vehicle is stationary.

When you deactivate DISTRONIC PLUS, you will see the **DISTRONIC PLUS Off** message in the multifunction display for approximately five seconds.

i The last speed stored remains stored until you switch off the engine.

i DISTRONIC PLUS is not deactivated if you depress the accelerator pedal. If you accelerate to overtake, DISTRONIC PLUS adjusts the vehicle's speed to the last speed stored after you have finished overtaking.

DISTRONIC PLUS is automatically deactivated if:

- you engage the electric parking brake or if the vehicle is automatically secured with the electric parking brake
- you are driving slower than 15 mph (25 km/h) and there is no vehicle in front, or if the vehicle in front is no longer detected
- ESP® intervenes or you deactivate ESP®
- the transmission is in the **P**, **R** or **N** position
- you pull the cruise control lever towards you in order to pull away and the front-

passenger door or one of the rear doors is open

- you activate DSR
- you activate off-road program 2 on vehicles with the ON&OFFROAD package
- the vehicle has skidded

If DISTRONIC PLUS is deactivated, you will hear a warning tone. You will see the **DISTRONIC PLUS Off** message in the multifunction display for approximately five seconds.

Displays in the instrument cluster

Displays in the speedometer



Example: DISTRONIC PLUS displays in the speedometer

When DISTRONIC PLUS is activated, one or two segments ② in the set speed range light up.

If DISTRONIC PLUS detects a vehicle in front, segments ② between speed of the vehicle in front ① and stored speed ③ light up.

i For design reasons, the speed displayed in the speedometer may differ slightly from the speed set for DISTRONIC PLUS.

Display when DISTRONIC PLUS is deactivated



- ① Vehicle in front, if detected
- ② Distance indicator, current distance to the vehicle in front
- ③ Specified minimum distance to the vehicle in front; adjustable
- ④ Own vehicle

In the Assistance menu of the on-board computer, you can select the assistance display.

- ▶ Select the **Distance Display** function using the on-board computer (> page 275).

Display when DISTRONIC PLUS is activated



- ① Vehicle in front, if detected
- ② Specified minimum distance to the vehicle in front; adjustable
- ③ Own vehicle
- ④ DISTRONIC PLUS activated

In the Assistance menu of the on-board computer, you can select the assistance display.

- ▶ Select the **Distance Display** function using the on-board computer (> page 275).

You will see the stored speed for about five seconds when you activate DISTRONIC PLUS.

Tips for driving with DISTRONIC PLUS

General notes

Pay particular attention in the following traffic situations:

- cornering, going into and coming out of a bend
- vehicles traveling on a different line
- other vehicles changing lanes
- narrow vehicles
- obstructions and stationary vehicles
- crossing vehicles

In such situations, brake if necessary. DISTRONIC PLUS is then deactivated.

Cornering, going into and coming out of a bend

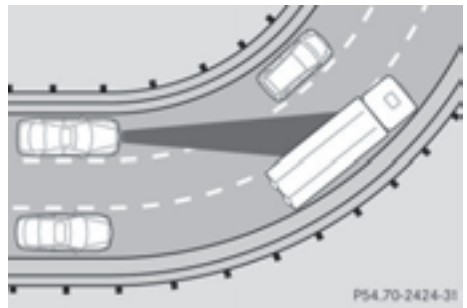

The ability of DISTRONIC PLUS to detect vehicles when cornering is limited. Your vehicle may brake unexpectedly or late.

Vehicles traveling on a different line

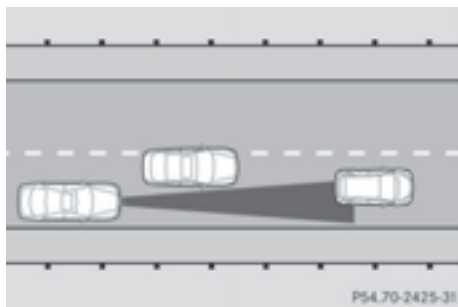

DISTRONIC PLUS may not detect vehicles traveling on a different line. The distance to the vehicle in front will be too short.

Other vehicles changing lanes

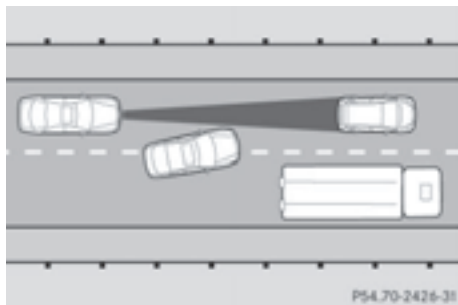

DISTRONIC PLUS has not detected the vehicle cutting in yet. The distance to this vehicle will be too short.

Narrow vehicles

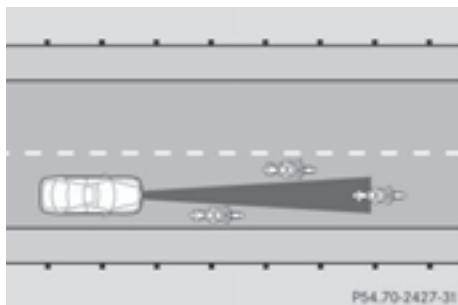

DISTRONIC PLUS has not yet detected the vehicle in front on the edge of the road,

because of its narrow width. The distance to the vehicle in front will be too short.

Obstructions and stationary vehicles

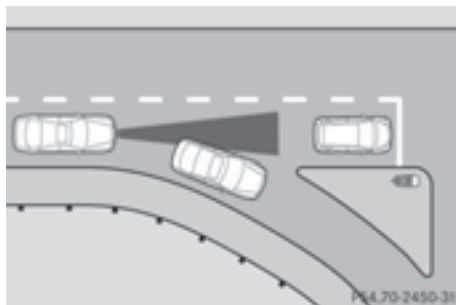

DISTRONIC PLUS does not brake for obstacles or stationary vehicles. If, for example, the detected vehicle turns a corner and reveals an obstacle or stationary vehicle, DISTRONIC PLUS will not brake for these.

Crossing vehicles

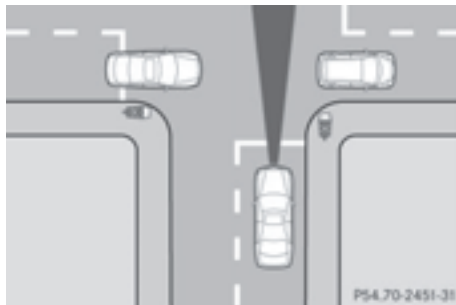

DISTRONIC PLUS may mistakenly detect vehicles that are crossing your lane. Activating DISTRONIC PLUS at traffic lights with crossing traffic, for example, could cause your vehicle to pull away unintentionally.

Level control (vehicles with the ON&OFFROAD package)

Important safety notes

Level control adapts the vehicle level automatically to the current operating and driving situation. This results in reduced fuel consumption and improved handling.

Make changes to the vehicle level while the vehicle is in motion. This enables the vehicle to adjust to the new level as quickly as possible.

The vehicle level may change visibly if you park the vehicle and the outside temperature changes. If the temperature drops, the vehicle level is lower; with an increase in temperature, the vehicle level rises.

If you unlock the vehicle or open a door, the vehicle begins to compensate for load discrepancies while still parked. However, for significant level changes, such as after the vehicle has been stationary for a long period, the engine must be on. For safety reasons, the vehicle is only lowered when the doors are closed. Lowering is interrupted if a door is opened, and it continues once the door has been closed.

For information about driving off-road, see (▷ page 191).

WARNING

When the vehicle is being lowered, people could become trapped if their limbs are between the vehicle body and the wheels or underneath the vehicle. There is a risk of injury.

Make sure no one is underneath the vehicle or in the immediate vicinity of the wheel arches when the vehicle is being lowered.

WARNING

When you drive with the vehicle raised, the driving characteristics could be impaired by the vehicle's raised center of gravity. The vehicle could rollover more easily, for example on a bend. There is a risk of an accident.

Always select as low a vehicle level as possible and adjust your driving style.

WARNING

When you drive with the chassis lowered or raised, the vehicle's braking and driving characteristics can be significantly impaired. You could also exceed the permissible vehicle

height if the chassis is raised. There is a risk of an accident.

Adjust the vehicle level before pulling away.

WARNING

Due to the high center of gravity, the vehicle may start to skid and roll over in the event of an abrupt steering maneuver and/or when the vehicle's speed is not adapted to the road conditions. There is a risk of an accident.

Always adapt your speed and driving style to the vehicle's driving characteristics and to the prevailing road and weather conditions.

 When driving on extremely rough terrain, select a high vehicle level in good time. Make sure there is always sufficient ground clearance. You will otherwise damage the vehicle.

- Utility vehicles have a significantly higher rollover rate than other types of vehicles. Failure to operate this vehicle safely may result in an accident, rollover of the vehicle, and severe or fatal injury.
- In a rollover crash, an unbelted person is significantly more likely to die than a person wearing a seat belt. You and all vehicle occupants should always wear your seat belts.

Basic settings

The extent to which the vehicle is raised or lowered depends on the basic setting selected.

Select:

- highway/high-speed level for driving on normal roads
- off-road level 1 for driving on easily negotiable off-road terrain
- off-road level 2 for driving on normal off-road terrain
- off-road level 3 for freeing the vehicle in particularly rough terrain at low speeds only

The individual vehicle levels differ from highway level as follows:

- highway level: +/-0 in (+/-0 mm)
- high-speed level: -0.6 in (-15 mm)
- off-road level 1: + 1.2 in (+ 30 mm)
- off-road level 2: + 2.3 in (+ 60 mm)
- off-road level 3: + 3.6 in (+ 90 mm)

Highway/high-speed level

- ! Make sure that there is enough ground clearance when the vehicle is being lowered. It could otherwise hit the ground, damaging the underbody.



- 1 Selector wheel
- 2 To raise the level
- 3 Indicator lamps
- 4 To lower the level

► Start the engine.

- **Selector wheel 1 engaged:** briefly press selector wheel 1. Selector wheel 1 extends.

If one or more indicator lamps 3 are on:

- Turn selector wheel 1 counter-clockwise 4 until all indicator lamps 3 that are lit start to flash.

The vehicle is lowered to highway level. As soon as the next lowest level is reached, the indicator lamp stops flashing and goes out.



During the adjustment, the **Lowering** message, for example, appears in the multifunction display.

If you press the  or **OK** button on the multifunction steering wheel, the message will disappear. Once highway level has been reached, all indicator lamps 3 go out.

The vehicle automatically selects highway level if you are driving at a speed above 70 mph (115 km/h) or if you drive at a speed between 62 mph (100 km/h) and 70 mph (115 km/h) for approximately 20 seconds. The vehicle is lowered to high-speed level if you are traveling at higher speeds.

Off-road levels

General notes

- Only select off-road level 3 for driving off-road in particularly rough terrain.
- Adjust your driving style to the altered handling characteristics.
- Do not drive at speeds above 12 mph (20 km/h).



Only select an off-road level when this is appropriate for road conditions. Otherwise, fuel consumption increases and handling may be affected.

- ▶ Start the engine.
- ▶ **Selector wheel ① engaged:** briefly press selector wheel ①.
Selector wheel ① extends.
- ▶ **To raise:** turn selector wheel ① clockwise ②.
The vehicle is raised.

or

- ▶ **To lower:** turn selector wheel ① counterclockwise ④.
The vehicle is lowered.

Indicator lamps ③ for the desired off-road level flash:



- Off-road level 1: the lower indicator lamp flashes
- Off-road level 2: the lower and center indicator lamps flash
- Off-road level 3: all three indicator lamps flash



The vehicle adjusts to the off-road level selected. As soon as an off-road level is reached, the corresponding indicator lamp stops flashing and lights up constantly.

Raising the vehicle

During the adjustment, the **Vehicle Rising** message, for example, appears in the multifunction display.

The vehicle rises from highway level to off-road level 1.

If you press the  or  button on the multifunction steering wheel, the message will disappear.

- ❗ Up to off-road level 2, you can hide the messages using the  or  button on the multifunction steering wheel.

Once off-road level 2 has been reached, the lower and center indicator lamps of the selector wheel are on.



While the adjustment from off-road level 2 to off-road level 3 is taking place, you will see a message such as the following in the multifunction display: **Vehicle Rising Max. Speed 12 mph (20 km/h)**.

The **Max. Speed 12 mph (20 km/h)** message draws your attention to the maximum speed permitted for off-road level 3.

Once off-road level 3 has been reached, you will see a message shown in white in the multifunction display, for example: **Max. Speed 12 mph (20 km/h)**.

If you drive above 20 km/h at off-road level 3, you will see the following message shown in red in the multifunction display: **Vehicle Lowering Max. Speed 12 mph (20 km/h)**.

- ❗ You cannot clear these messages.

You also hear a warning. The vehicle is lowered and off-road level 3 is canceled.

If you continue to increase your speed, the red message continues to be shown in the multifunction display. The newly set level is not displayed until the vehicle has been set to a level suitable for the current speed.

Lowering the vehicle



If you maintain or reduce your speed, you will see a message in white in the display while the vehicle is being lowered, such as the following: **Lowering Max. Speed 12 mph (20 km/h)**.

The vehicle is lowered to off-road level 2.

If you select an off-road level when driving at too high a speed, the **Drive More Slowly** message appears in the multifunction display.

You can select from the following:

- Off-road level 1 at speeds up to 60 mph (100 km/h)
- Off-road level 2 at speeds up to 40 mph (65 km/h)
- Off-road level 3 at speeds up to 12 mph (20 km/h)

If you are driving above 50 mph (80 km/h) or drive between 40 mph (65 km/h) and 50 mph (80 km/h) for longer than 20 seconds, off-road level 2 will be canceled. The vehicle is lowered to off-road level 1.

You will see a message in the multifunction display, for example: **Lowering**.

If you are driving above 70 mph (115 km/h) or drive between 62 mph (100 km/h) and 70 mph (115 km/h) for longer than 20 seconds, off-road level 1 will be canceled. Depending on the vehicle's speed and the ADS mode selected (▷ page 212), the vehicle is automatically lowered to highway or high-speed level.

You will see a message in the multifunction display, for example: **Lowering**.

HOLD function

General notes

The HOLD function can assist the driver in the following situations:

- when pulling away, especially on steep slopes
- when maneuvering on steep slopes
- when waiting in traffic

The vehicle is kept stationary without the driver having to depress the brake pedal.

The braking effect is canceled and the HOLD function deactivated when you depress the accelerator pedal to pull away.

i Do not use the HOLD function when driving off-road, on steep uphill or downhill gradients or on slippery or loose surfaces. The HOLD function cannot hold the vehicle on such surfaces.

Important safety notes

⚠ WARNING

When leaving the vehicle, it can still roll away despite being braked by the HOLD function if:

- there is a malfunction in the system or in the voltage supply.
- the HOLD function has been deactivated by pressing the accelerator pedal or the brake pedal, e.g. by a vehicle occupant.
- the electrical system in the engine compartment, the battery or the fuses have been tampered with.
- the battery is disconnected

There is a risk of an accident.

If you wish to exit the vehicle, always turn off the HOLD function and secure the vehicle against rolling away.

! If DISTRONIC PLUS or the HOLD function is activated, the vehicle brakes automatically in certain situations. To prevent damage to the vehicle, deactivate DISTRONIC PLUS and the HOLD function in the following or other similar situations:

- when towing the vehicle
- in the car wash

Deactivating the HOLD function
(▷ page 211).

Activation conditions

You can activate the HOLD function if:

- the vehicle is stationary
- the engine is running or if it has been automatically switched off by the ECO start/stop function
- the driver's door is closed or your seat belt is fastened
- the electric parking brake is released
- the transmission is in position **D**, **R** or **N**
- DISTRONIC PLUS is deactivated

Activating the HOLD function



- ▶ Make sure that the activation conditions are met.
- ▶ Depress the brake pedal.
- ▶ Quickly depress the brake pedal further until ① appears in the multifunction display. The HOLD function is activated. You can release the brake pedal.

i If depressing the brake pedal the first time does not activate the HOLD function, wait briefly and then try again.

Deactivating the HOLD function

The HOLD function is deactivated automatically if:

- you accelerate and the transmission is in position **D** or **R**.
- you shift the transmission to position **P**.
- you depress the brake pedal again with a certain amount of pressure until ① disappears from the multifunction display.
- you secure the vehicle using the electric parking brake.
- you activate DISTRONIC PLUS.

i After a time, the electric parking brake secures the vehicle and relieves the service brake.

The electric parking brake automatically secures the vehicle if the HOLD function is activated and:

- the driver's door is open and the driver's seat belt is unfastened.
- the engine is switched off, unless it is automatically switched off by the ECO start/stop function.
- a system malfunction occurs.
- the power supply is not sufficient.

On steep uphill or downhill inclines or if there is a malfunction, the transmission may also be automatically shifted into position **P**.

AIRMATIC package

General notes

AIRMATIC regulates the level of your vehicle. As well as level control (▷ page 213), your vehicle can be equipped with ADS (Adaptive Damping System) (▷ page 212) and ACTIVE CURVE SYSTEM (▷ page 212).

Observe the notes on driving with a trailer (▷ page 257).

ADS (Adaptive Damping System)

General notes

ADS adapts the damping characteristics to the current operating and driving situation.

This depends on:

- your driving style
- the road surface conditions
- the ADS setting
- the vehicle level setting

Your selection remains stored even if you remove the SmartKey from the ignition lock.

Sports tuning

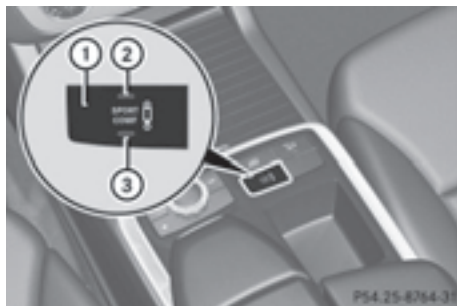

Example: vehicles without the ON&OFFROAD package

- ① Suspension tuning button
- ② Indicator lamp for sports tuning
- ③ Indicator lamp for comfort tuning

▶ Start the engine.

- ▶ Press button ①.
Indicator lamp ② lights up. Sports suspension tuning is selected. The vehicle is lowered by 0.6 in (15 mm).

The firmer suspension tuning in Sport mode ensures even better contact with the road. Select this mode when employing a sporty driving style, e.g. on winding country roads.

Comfort tuning

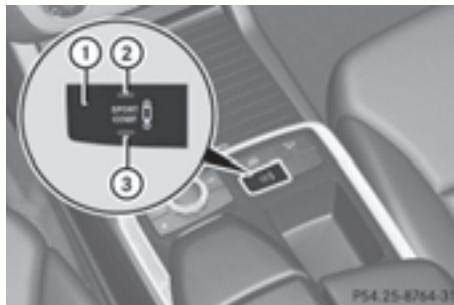

Example: vehicles without the ON&OFFROAD package

- ① Suspension tuning button
- ② Indicator lamp for sports tuning
- ③ Indicator lamp for comfort tuning

- ▶ Press button ①.
Indicator lamp ③ lights up. Comfort tuning is selected. The vehicle is raised by 0.6 in (15 mm).

In comfort mode, the driving characteristics of your vehicle are more comfortable. Therefore, select this mode if you favor a more comfortable driving style. Select comfort mode also when driving fast on straight roads, e.g. on straight stretches of highway.

Active Curve System

The Active Curve System uses active stabilizers to optimize both driving comfort and vehicle agility. Depending on the ADS mode selected (> page 212), the Active Curve System also changes the setting.

If you select ADS comfort mode:

- rolling movement is reduced in the event of changing surface undulations
- the roll angle when cornering is reduced
- the driving style is agile

If you select ADS sport mode:

- the roll angle is reduced significantly
- the driving style is even more agile

Level control

Important safety notes

WARNING

When the vehicle is being lowered, people could become trapped if their limbs are between the vehicle body and the wheels or underneath the vehicle. There is a risk of injury.

Make sure no one is underneath the vehicle or in the immediate vicinity of the wheel arches when the vehicle is being lowered.

WARNING

When you drive with the vehicle raised, the driving characteristics could be impaired by the vehicle's raised center of gravity. The vehicle could rollover more easily, for example on a bend. There is a risk of an accident.

Always select as low a vehicle level as possible and adjust your driving style.

WARNING

When you drive with the chassis lowered or raised, the vehicle's braking and driving characteristics can be significantly impaired. You could also exceed the permissible vehicle height if the chassis is raised. There is a risk of an accident.

Adjust the vehicle level before pulling away.

WARNING

Due to the high center of gravity, the vehicle may start to skid and roll over in the event of an abrupt steering maneuver and/or when the vehicle's speed is not adapted to the road conditions. There is a risk of an accident.

Always adapt your speed and driving style to the vehicle's driving characteristics and to the prevailing road and weather conditions.

-  When driving on extremely rough terrain, select a high vehicle level in good time. Make sure there is always sufficient ground clearance. You will otherwise damage the vehicle.

-  When you raise the vehicle in such a way that not all wheels have contact with the ground, remove the SmartKey from the ignition lock.

- Utility vehicles have a significantly higher rollover rate than other types of vehicles. Failure to operate this vehicle safely may result in an accident, rollover of the vehicle, and severe or fatal injury.
- In a rollover crash, an unbelted person is significantly more likely to die than a person wearing a seat belt. You and all vehicle occupants should always wear your seat belts.

General notes

Further information about "Driving off-road" ([▷ page 191](#)).

Level control adapts the vehicle level automatically to the current operating and driving situation. This results in reduced fuel consumption and improved handling.

If you select ADS comfort mode ([▷ page 212](#)), the vehicle is lowered to high-speed level as the speed increases. As the vehicle speed decreases, the vehicle is raised back up to highway level.

If you select ADS sport mode ([▷ page 212](#)), the vehicle skips highway level and lowers directly to high-speed level depending on the basic setting ([▷ page 214](#)).

Make changes to the vehicle level while the vehicle is in motion. This enables the vehicle to adjust to the new level as quickly as possible.

The vehicle level may change visibly if you park the vehicle and the outside temperature changes. If the temperature drops, the vehicle level is lower; with an increase in temperature, the vehicle level rises.

If you unlock the vehicle or open a door, the vehicle begins to compensate for load discrepancies while still parked. However, for significant level changes, such as after the vehicle has been stationary for a long period, the engine must be on. For safety reasons,

the vehicle is only lowered when the doors are closed. Lowering is interrupted if a door is opened, and it continues once the door has been closed.

Basic settings (excluding AMG vehicles)

The extent to which the vehicle is raised or lowered depends on the basic setting selected. Select raised level for off-road driving or highway/high-speed level for normal roads.

The individual vehicle levels differ from highway level as follows:

- highway level: +/-0 in (+/-0 mm)
- high-speed level: -0.6 in (-15 mm)
- raised level: +2.3 in (+60 mm)

Basic settings for AMG vehicles

The extent to which the vehicle is raised or lowered depends on the AMG adaptive sport suspension setting selected. Select the raised level for off-road driving or highway/high-speed level for normal roads.

The raised level corresponds to a vehicle level raised by 50 mm when compared with highway level in comfort mode.

Raised level

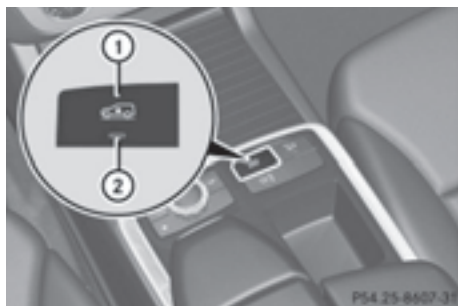

Only select raised level if this is appropriate for the road conditions. Otherwise, fuel consumption may increase and handling may be affected.



- ▶ Start the engine.

If indicator lamp ② is not lit:

- ▶ Press button ①.
Indicator lamp ② flashes. The vehicle rises to raised level.



During the adjustment, the **Vehicle Rising** message, for example, appears in the multifunction display.

If you press the  or  button on the multifunction steering wheel, the message will disappear.

Once the vehicle has reached raised level, indicator lamp ② remains lit. The **Vehicle Rising** message disappears from the multifunction display.

If you try to select raised level at a speed above 40 mph (64 km/h), the **Drive More Slowly** message appears in the multifunction display.

Highway/high-speed level

- ⚠ Make sure that there is enough ground clearance when the vehicle is being lowered. It could otherwise hit the ground, damaging the underbody.

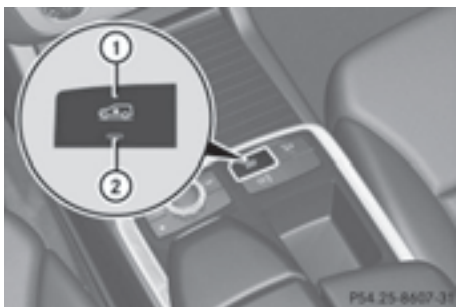

- ① Level control button
- ② Level control indicator lamp

► Start the engine.

If indicator lamp ② is lit:

- Press button ①.
Indicator lamp ② flashes. The vehicle is adjusting to highway/high-speed level.



During the adjustment, the **Lowering** message, for example, appears in the multifunction display.

If you press the  or **OK** button on the multifunction steering wheel, the message will disappear.

Once highway level has been reached, indicator lamp ② goes out. The **Lowering** message disappears from the multifunction display.

The vehicle automatically adjusts to highway level when you:

- drive faster than 50 mph (80 km/h).
- drive between 40 mph (64 km/h) and 50 mph (80 km/h) for approximately 20 seconds.

Depending on the ADS mode selected (► page 212), the vehicle is lowered to high-speed level at high speeds.

AMG adaptive sport suspension system

Important safety notes

WARNING

When the vehicle is being lowered, people could become trapped if their limbs are between the vehicle body and the wheels or underneath the vehicle. There is a risk of injury.

Make sure no one is underneath the vehicle or in the immediate vicinity of the wheel arches when the vehicle is being lowered.

WARNING

The vehicle is lowered if:

- you have selected the Comfort or Sport suspension tuning and
- lock the vehicle after switching off the engine

Persons in the vicinity of the wheel arch or the underbody may thus become trapped. There is a risk of injury.

Make sure that nobody is in the vicinity of the wheel arch or the underbody when you switch off the engine.

 The vehicle is lowered by approximately 10 mm if:

- you have selected the Sport or Comfort suspension tuning and
- you switch off the engine and then
- lock the vehicle

When parking, position your vehicle so that it does not make contact with the curb as the vehicle is lowered. Your vehicle could otherwise be damaged.

Vehicle level

Level control adapts the vehicle level automatically to the current operating and driving situation. Level control ensures the best possible suspension and constant ground clearance, even with a laden vehicle. This improves driving safety and fuel consumption.

The AIRMATIC package and ACTIVE CURVE SYSTEM are always components of AMG adaptive suspension system (▷ page 211). Due to the sportier suspension settings compared to standard vehicles, the levels and speed thresholds for sinking and raising the vehicle are different.

In Comfort and Sport driving modes, after locking the vehicle it lowers to the Sport+ level. When locking the vehicle at the raised level, the vehicle does not lower.

The settings will remain stored after you switch off the engine. When starting the engine, the selected setting, e.g. AMG adaptive suspension system Comfort, is restored.

- i** The vehicle level may change visibly if you park the vehicle and the outside temperature changes. If the temperature drops, the vehicle level lowers; with an increase in temperature, the vehicle level rises.

Suspension tuning

General notes

The electronically controlled damping system works continuously. This improves driving safety and ride comfort.

The damping is tuned individually to each wheel and depends on:

- your driving style
- the road surface conditions
- your individual selection of Sport, Sport + or Comfort

Your selection remains stored even if you remove the SmartKey from the ignition lock.

Sport mode

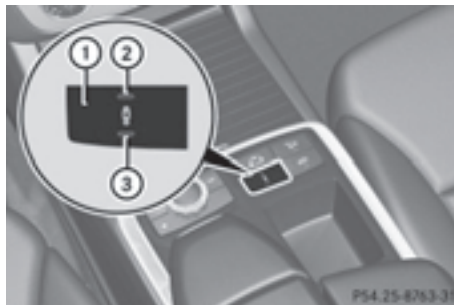

The firmer suspension tuning in Sport mode ensures even better contact with the road. Select this mode when employing a sporty driving style, e.g. on winding country roads.

- ▶ Press button ① once.
Indicator lamp ② lights up. You have selected Sport mode.
The **AMG Suspension System SPORT** message appears in the multifunction display.

Sport + mode

The very firm setting of the suspension tuning in Sport + mode ensures the best possible contact with the road. Select this mode preferably when driving on race circuits.

If indicator lamps ③ and ② are off:

- ▶ Press button ① twice.
Indicator lamps ③ and ② light up. You have selected Sport + mode. The vehicle is lowered by 10 mm.
The **AMG Suspension System SPORT +** message appears in the multifunction display.

If indicator lamp ② lights up:

- ▶ Press button ① once.
Second indicator lamp ③ lights up. You have selected Sport + mode. The vehicle is lowered by 10 mm.
The **AMG Suspension System SPORT +** message appears in the multifunction display.

Comfort mode

In comfort mode, the driving characteristics of your vehicle are more comfortable. Select this mode if you prefer a comfortable driving style. Select comfort mode also when driving fast on straight roads, e.g. on straight stretches of freeway.

- ▶ Press button ① repeatedly until indicator lamps ③ and ② go out. You have selected Comfort mode. The vehicle is raised by 10 mm compared with Sport + suspension tuning.

The **AMG Suspension System COMFORT** message appears in the multifunction display.

PARKTRONIC

Important safety notes

PARKTRONIC is an electronic parking aid with ultrasonic sensors. It indicates visually and audibly the distance between your vehicle and an object.

PARKTRONIC is only an aid. It is not a replacement for your attention to your immediate surroundings. You are always responsible for safe maneuvering, parking and exiting a parking space. When maneuvering, parking or pulling out of a parking space, make sure that there are no persons, animals or objects in the area in which you are maneuvering.

- ❗ When parking, pay particular attention to objects above or below the sensors, such as flower pots or trailer drawbars. PARKTRONIC does not detect such objects when they are in the immediate vicinity of the vehicle. You could damage the vehicle or the objects.

The sensors may not detect snow and other objects that absorb ultrasonic waves.

Ultrasonic sources such as an automatic car wash, the compressed-air brakes on a truck or a pneumatic drill could cause PARKTRONIC to malfunction.

PARKTRONIC may not function correctly on uneven terrain.

PARKTRONIC is activated automatically when you:

- switch on the ignition
- shift the transmission to position **D**, **R** or **N**
- Release the electric parking brake

PARKTRONIC is deactivated at speeds above 11 mph (18 km/h). It is reactivated at lower speeds.

PARKTRONIC monitors the area around your vehicle using six sensors in the front bumper and four sensors in the rear bumper.

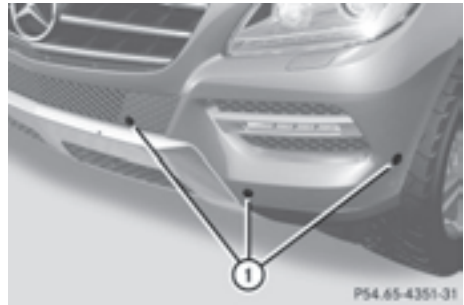

- ① Sensors in the front bumper, left-hand side (example)

Range of the sensors

General notes

PARKTRONIC does not take objects into consideration that are:

- below the detection range, e.g. people, animals or objects
- above the detection range, e.g. overhanging loads, truck overhangs or loading ramps.



Side view

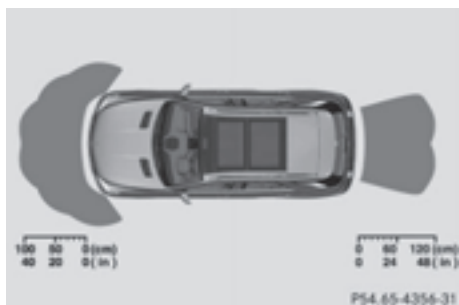

Top view

The sensors must be free from dirt, ice or slush. They can otherwise not function correctly. Clean the sensors regularly, taking care not to scratch or damage them (► page 375).

Front sensors

Center	Approx. 40 in (approx. 100 cm)
Corners	Approx. 24 in (approx. 60 cm)

Rear sensors

Center	Approx. 48 in (approx. 120 cm)
Corners	Approx. 32 in (approx. 80 cm)

Minimum distance

Center	Approx. 8 in (approx. 20 cm)
Corners	Approx. 6 in (approx. 15 cm)

If there is an obstacle within this range, the relevant warning displays light up and a warning tone sounds. If the distance falls below the minimum, the distance may no longer be shown.

Warning displays



Warning display for the front area

- ① Segments on the left-hand side of the vehicle
- ② Segments on the right-hand side of the vehicle
- ③ Segments showing operational readiness

The warning displays show the distance between the sensors and the obstacle. The warning display for the front area is located on the dashboard above the center air vents. The warning display for the rear area is in the roof lamp in the rear compartment.

The warning display for each side of the vehicle is divided into five yellow and two red segments. PARKTRONIC is operational if yellow segments showing operational readiness ③ light up.

The selected transmission position and the direction in which the vehicle is rolling determine which warning display is active when the engine is running.

Transmission position	Warning display
D	Front area activated
R, N or the vehicle is rolling backwards	Rear and front areas activated
P	No areas activated

One or more segments light up as the vehicle approaches an obstacle, depending on the vehicle's distance from the obstacle.

From the:

- sixth segment onwards, you will hear an intermittent warning tone for approximately two seconds.
- seventh segment onwards, you will hear a warning tone for approximately two seconds. This indicates that you have now reached the minimum distance.

Deactivating/activating PARKTRONIC



- ① Indicator lamp
- ② To deactivate/activate PARKTRONIC

If indicator lamp ① is on then PARKTRONIC is deactivated. Active Parking Assist is then also deactivated.

- i** PARKTRONIC is automatically activated when you turn the SmartKey to position **2** in the ignition lock.

Towing a trailer

- !** Fold in the ball coupling if the trailer tow hitch is not required. PARKTRONIC measures the minimum detection range to an obstacle from the bumper, not the ball coupling.

PARKTRONIC is deactivated for the rear area when you establish an electrical connection between your vehicle and a trailer.

Problems with PARKTRONIC

Problem	Possible causes/consequences and ► Solutions
<p>Only the red segments in the PARKTRONIC warning displays are lit. You also hear a warning tone for approximately two seconds.</p> <p>PARKTRONIC is deactivated after approximately five seconds, and the indicator lamp in the PARKTRONIC button lights up.</p>	<p>PARKTRONIC has malfunctioned and has switched off.</p> <p>► If problems persist, have PARKTRONIC checked at a qualified specialist workshop.</p>
<p>Only the red segments in the PARKTRONIC warning displays are lit. PARKTRONIC is deactivated after approximately five seconds.</p>	<p>The PARKTRONIC sensors are dirty or there is interference.</p> <p>► Clean the PARKTRONIC sensors (▷ page 375).</p> <p>► Switch the ignition back on.</p>
	<p>The problem may be caused by an external source of radio or ultrasound waves.</p> <p>► See if PARKTRONIC functions in a different location.</p>

Active Parking Assist

General notes

Active Parking Assist is an electronic parking aid with ultrasound. It measures the road on both sides of the vehicle. A parking symbol indicates a suitable parking space. Active steering intervention can assist you during parking.

You may also use PARKTRONIC (▷ page 217).

Important safety notes

Active Parking Assist is merely an aid. It is not a replacement for your attention to your immediate surroundings. You are always responsible for safe maneuvering, parking and exiting a parking space. When maneuvering, parking or pulling out of a parking space, make sure that there are no persons, animals or objects in the area in which you are maneuvering.

When PARKTRONIC is switched off, Active Parking Assist is also unavailable.

WARNING

While parking or pulling out of a parking space, the vehicle swings out and can drive onto areas of the oncoming lane. This could result in a collision with another road user. There is a risk of an accident.

Pay attention to other road users. Stop the vehicle if necessary or cancel the Active Parking Assist parking procedure.

- ❗ If unavoidable, you should drive over obstacles such as curbs slowly and not at a sharp angle. Otherwise, you may damage the wheels or tires.

Active Parking Assist may possibly indicate parking spaces which are not suitable for parking, for example:

- where parking or stopping is prohibited
- in front of driveways or entrances and exits
- on unsuitable surfaces

Parking tips:

- On narrow roads, drive as close to the parking space as possible.
- Parking spaces that are littered or overgrown might be identified or measured incorrectly.
- Parking spaces that are partially occupied by trailer drawbars might not be identified as such or be measured incorrectly.
- Snowfall or heavy rain may lead to a parking space being measured inaccurately.
- Pay attention to the PARKTRONIC (▷ page 218) warning messages during the parking procedure.
- At any time, you can intervene in the steering procedure to correct it. Active Parking Assist will then be canceled.
- When transporting a load which protrudes from your vehicle, you should not use Active Parking Assist.
- Never use Active Parking Assist when snow chains are installed.
- Make sure that the tire pressures are always correct. This has a direct influence on the parking characteristics of the vehicle.

Use Active Parking Assist for parking spaces:

- that are parallel to the direction of travel
- that are on straight roads, not bends
- that are on the same level as the road, e.g. not on the pavement

Detecting parking spaces

Objects located above the height range of Active Parking Assist will not be detected when the parking space is measured. These are not taken into account when the parking

procedure is calculated, e.g. overhanging loads, tail sections or loading ramps of goods vehicles.

WARNING

If there are objects above the detection range, Active Parking Assist may turn prematurely. You may cause a collision as a result. There is a risk of an accident.

If there are objects above the detection range, stop and deactivate Active Parking Assist.

For further information on the detection range (▷ page 217).

Active Parking Assist does not support you with parking spaces parallel to the direction of travel if:

- the parking space is on a curb
- the system reads the parking space as being blocked, for example by foliage or grass paving blocks
- the area is too small for the vehicle to maneuver into
- the parking space is bordered by an obstacle, e.g. a tree, a post or a trailer



- ① Detected parking space on the left
- ② Parking symbol
- ③ Detected parking space on the right

Active Parking Assist is switched on automatically when driving forwards. The system is operational at speeds of up to approximately 22 mph (35 km/h). While in operation, the system independently locates and measures parking spaces on both sides of the vehicle.

Active Parking Assist will only detect parking spaces:

- that are parallel to the direction of travel
- that are at least 59 in (1.5 m) wide
- that are at least 51 in (1.3 m) longer than your vehicle

When driving at speeds below 19 mph (30 km/h), you will see parking symbol as a status indicator in the instrument cluster. When a parking space has been detected, an arrow towards the right or the left also appears. By default, Active Parking Assist only displays parking spaces on the front-passenger side. Parking spaces on the driver's side are displayed as soon as the turn signal on the driver's side is activated. When parking on the driver's side, this must remain switched on until you acknowledge the use of Active Parking Assist by pressing the **OK** button on the multifunction steering wheel.

A parking space is displayed while you are driving past it, and until you are approximately 50 ft (15 m) away from it.

Parking

WARNING

Active Parking Assist merely aids you by intervening actively in the steering. If you do not brake there is a risk of an accident.

Always apply the brakes yourself when maneuvering and parking.

- ▶ Stop the vehicle when the parking space symbol shows the desired parking space in the instrument cluster.
- ▶ Shift the transmission to position **R**. The **Start Park Assist? Yes: OK No: ** message appears in the multifunction display.

- ▶ **To cancel the procedure:** press the **** button on the multifunction steering wheel or pull away.

or

- ▶ **To park using Active Parking Assist:** press the **OK** button on the multifunction steering wheel.

The **Park Assist Active Accelerate and Brake Observe Surroundings** message appears in the multifunction display.

- ▶ Let go of the multifunction steering wheel.
- ▶ Back up the vehicle, being ready to brake at all times. When backing up, drive at a speed below approximately 6 mph (10 km/h). Otherwise Active Parking Assist will be canceled.
- i** In tight parking spaces, you will achieve the best parking results by backing up as far as possible. When doing so, also observe the PARKTRONIC messages.
- ▶ Stop as soon as PARKTRONIC sounds the continuous warning tone, if not before. Maneuvering may be required in tight parking spaces.

The **Park Assist active Select D Observe surroundings** message appears in the multifunction display.

- ▶ Shift the transmission to position **D** while the vehicle is stationary. Active Parking Assist immediately steers in the other direction.

The **Park Assist active Accelerate and brake Observe surroundings** message appears in the multifunction display.

- i** You will achieve the best results by waiting for the steering procedure to complete before pulling away.
- ▶ Drive forwards and be ready to brake at all times.
- ▶ Stop as soon as PARKTRONIC sounds the continuous warning tone, if not before.

The **Park Assist active Select R Observe surroundings** message appears in the multifunction display.

As soon as the parking procedure is complete, the **Park Assist switched off** message appears and a warning tone sounds.

Active Parking Assist no longer supports you with steering interventions. When Active Parking Assist is finished, you must steer again yourself. PARKTRONIC is still available.

Parking tips:

- The way your vehicle is positioned in the parking space after parking is dependent on various factors. These include the position and shape of the vehicles parked in front and behind it and the conditions of the location. It may be the case that Active Parking Assist guides you too far into a parking space, or not far enough into it. In some cases, it may also lead you across or onto the curb. If necessary, you should cancel the parking procedure with Active Parking Assist.
- You can also select preselect transmission position **D**. The vehicle redirects and does not drive as far into the parking space. Should the gear change occur too soon to achieve a sensible parking position, the parking procedure will be aborted.

Exiting a parking space

In order that Active Parking Assist can support you when you exit the parking space:

- you need to have parked using Active Parking Assist.
 - the border of the parking space must be high enough at the front and the rear. A curb stone is too small, for example.
 - the border of the parking space must not be too wide, as the position of the vehicle must not exceed an angle of 45° to the starting position as it is maneuvered into the parking space.
 - a maneuvering distance of at least 3.3 ft (1.0 m) must be available.
- ▶ Start the engine.
 - ▶ Release the electric parking brake.

- ▶ Switch on the turn signal in the direction you are pulling away.
- ▶ Shift the transmission to position **D** or **R**. The **Start Park Assist? Yes: OK No: ** message appears in the multifunction display.

- ▶ **To cancel the procedure:** press the  button on the multifunction steering wheel or pull away.

or

- ▶ **To exit a parking space using Active Parking Assist:** press the  button on the multifunction steering wheel.

The **Park Assist Active Accelerate and Brake Observe Surroundings** message appears in the multifunction display.

- ▶ Let go of the multifunction steering wheel.
- ▶ Reverse the vehicle or drive forwards, being ready to brake at all times. Do not exceed a maximum speed of approximately 6 mph (10 km/h) when exiting a parking space. Otherwise Active Parking Assist will be canceled.
- ▶ Stop as soon as PARKTRONIC sounds the continuous warning tone, if not before.
- ▶ Shift the transmission to position **D** or **R** as required while the vehicle is stationary. Active Parking Assist immediately steers in the other direction.

- ▶ **i** You will achieve the best results by waiting for the steering procedure to complete before pulling away.

If you back up after activation, the steering wheel is moved to the straight-ahead position.

- ▶ Drive forwards or back up the vehicle, being ready to brake at all times.
- ▶ Stop as soon as PARKTRONIC sounds the continuous warning tone, if not before.
- ▶ Drive forwards and back up as prompted by the PARKTRONIC warning displays, several times if necessary.

Once you have exited the parking space completely, the steering wheel is moved to the straight-ahead position. You hear a tone and

the **Park Assist Finished** message appears in the multifunction display. You will then have to steer and merge into traffic on your own. PARKTRONIC is still available. You can take over the steering, before the vehicle has exited the parking space completely. This is useful, for example when you recognize that it is already possible to pull out of the parking space.

Canceling Active Parking Assist

- ▶ Stop the movement of the multifunction steering wheel or steer yourself. Active Parking Assist will be canceled at once. The **Park Assist Canceled** message appears in the multifunction display.

or

- ▶ Press the PARKTRONIC button on the center console (▷ page 219). PARKTRONIC is switched off and Active Parking Assist is immediately canceled. The **Park Assist Canceled** message appears in the multifunction display.

Active Parking Assist is canceled automatically if:

- the electric parking brake is engaged
- transmission position **P** is selected
- parking using Active Parking Assist is no longer possible
- you are driving faster than 6 mph (10 km/h)
- a wheel spins, ESP[®] intervenes or fails. The  warning lamp lights up in the instrument cluster.

A warning tone sounds. The parking symbol goes out and the **Park Assist Canceled** message appears in the multifunction display.

If Active Parking Assist is canceled, you must steer again yourself.

Towing a trailer

For vehicles with a trailer tow hitch, the minimum length for parking spaces is slightly increased.

If you have attached a trailer to your vehicle, you should not use Active Parking Assist. Once the electrical connection is established between your vehicle and the trailer, Active Parking Assist is no longer available. PARKTRONIC is deactivated for the rear area.

Rear view camera

General notes



Rear view camera ① is in the handle on the tailgate.

Rear view camera ① is an optical parking and maneuvering aid. It shows the area behind your vehicle with guide lines in the COMAND display.

The area behind the vehicle is displayed as a mirror image, as in the rear view mirror.

- ❗ The text of messages shown in the COMAND display depends on the language setting. The following are examples of rear view camera messages in the COMAND display.

Important safety notes

The rear view camera is only an aid. It is not a replacement for your attention to your immediate surroundings. You are always responsible for safe maneuvering and parking. When maneuvering or parking, make sure that there are no persons, animals or objects in the area in which you are maneuvering.

Under the following circumstances, the rear view camera will not function, or will function in a limited manner:

- if the tailgate is open
- in heavy rain, snow or fog
- at night or in very dark places
- if the camera is exposed to very bright light
- if the area is lit by fluorescent bulbs or LED lighting (the display may flicker)
- if there is a sudden change in temperature, e.g. when driving into a heated garage in winter
- if the camera lens is dirty or obstructed
- if the rear of your vehicle is damaged. In this event, have the camera position and setting checked at a qualified specialist workshop

The field of vision and other functions of the rear view camera may be restricted due to additional accessories on the rear of the vehicle (e.g. license plate holder, bicycle rack).

Activating/deactivating the rear view camera



- ▶ **To activate:** make sure that the SmartKey is in position **2** in the ignition lock.
- ▶ Make sure that the function "show rear view camera display" is selected in COMAND.
- ▶ Engage reverse gear.
The area behind the vehicle is shown in the COMAND display with guide lines.
- ▶ **To change the function mode for vehicles with trailer tow hitch:** using the

COMAND controller, select symbol ① for the "Reverse parking" function or symbol ② for "Coupling up a trailer" (see the separate COMAND operating instructions). The symbol of the selected function is highlighted.

To deactivate: the rear view camera deactivates if you shift the transmission to **P** or after driving forwards a short distance.

Displays in the COMAND display

The rear view camera may show a distorted view of obstacles, show them incorrectly or not at all. The rear view camera does not show objects in the following positions:

- very close to the rear bumper
- under the rear bumper
- in the area immediately above the tailgate handle

! Objects not at ground level may appear to be further away than they actually are, e.g.:

- the bumper of a parked vehicle
- the drawbar of a trailer
- the ball coupling of a trailer tow hitch
- the rear section of an HGV
- a slanted post

Use the guidelines only for orientation. Approach objects no further than the bottom-most guideline.

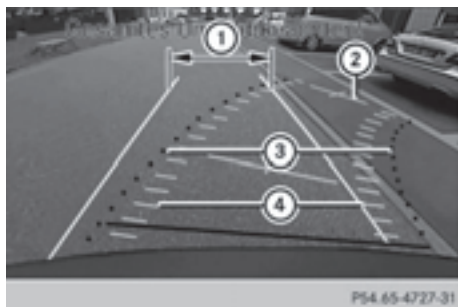

- ① White guide line without turning the steering wheel, vehicle width including the exterior mirrors (static)
- ② Yellow guide line at a distance of approximately 13 ft (4.0 m) from the rear of the vehicle
- ③ Red guide line for the vehicle width including the exterior mirrors, for current steering wheel angle (dynamic)
- ④ Yellow lane marking tires at current steering wheel angle (dynamic)

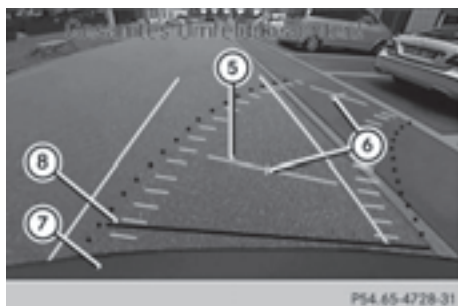

- ⑤ Yellow guide line at a distance of approximately 3 ft (1.0 m) from the rear of the vehicle
- ⑥ Vehicle center axle (marker assistance)
- ⑦ Bumper
- ⑧ Red guide line at a distance of approximately 10 in (0.25 m) from the rear of the vehicle

The guide lines are shown when the transmission is in position **R**.

The distance specifications only apply to objects that are at ground level.



Additional messages for vehicles with PARKTRONIC

- ① Front warning display
- ② Additional PARKTRONIC measurement operational readiness indicator
- ③ Rear warning display

Vehicles with PARKTRONIC: if PARKTRONIC is operational (▷ page 218), an additional operational readiness indicator will appear in COMAND display ②. If the PARKTRONIC warning displays are active or light up, warning displays ① and ③ are also active or light up correspondingly in the COMAND display.

"Reverse parking" function

Backing up straight into a parking space without turning the steering wheel



- ① White guide line without turning the steering wheel, vehicle width including the exterior mirrors (static)
- ② Red guide line for the vehicle width including the exterior mirrors, for current steering wheel angle (dynamic)

- ③ Yellow guide line at a distance of approximately 3 ft (1.0 m) from the rear of the vehicle
- ④ Red guide line at a distance of approximately 10 in (0.25 m) from the rear of the vehicle

- ▶ Make sure that the rear view camera is switched on (▷ page 225). The lane and the guide lines are shown.
- ▶ With the help of white guide line ①, check whether the vehicle will fit into the parking space.
- ▶ Using white guide line ① as a guide, carefully back up until you reach the end position. Red guide line ④ is then at the end of the parking space. The vehicle is almost parallel in the parking space.

Reverse perpendicular parking with the steering wheel at an angle



Turning the steering wheel

- ① Red guide line for the vehicle width including the exterior mirrors, for current steering wheel angle (dynamic)
- ② Parking space marking
- ▶ Make sure that the rear view camera is switched on (▷ page 225). The lane and the guide lines are shown.
- ▶ Drive past the parking space and bring the vehicle to a standstill.
- ▶ While the vehicle is at a standstill, turn the steering wheel in the direction of the park-

ing space until red guide line ① reaches parking space marking ②.

- ▶ Keep the steering wheel in that position and back up carefully.



Backing up with the steering wheel turned

- ① Red guide line for the vehicle width including the exterior mirrors, for current steering wheel angle (dynamic)
- ▶ Stop the vehicle when it is almost exactly in front of the parking space. The white lane should be as close to parallel with the parking space marking as possible.



Driving to the final position

- ① White guide line at current steering wheel angle
- ② Parking space marking
- ▶ Turn the steering wheel to the center position while the vehicle is stationary.

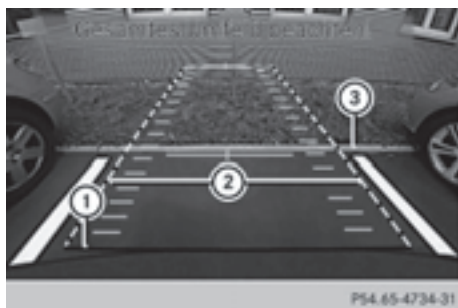

- ① Red guide line at a distance of approximately 10 in (0.25 m) from the rear of the vehicle
- ② White guide line without turning the steering wheel
- ③ End of parking space

► Back up carefully until you have reached the final position. Red guide line ① is then at end of parking space ③. The vehicle is almost parallel in the parking space.

"Coupling up a trailer" function

! The following distance specifications refer to trailer tow hitches with ball coupling that have been approved for this vehicle by Mercedes-Benz. Distances may differ if you use other ball couplings. In this case, take into account that actual distances will not match the following distance specifications. Otherwise you could damage the trailer and vehicle.



- ① Vehicle center point on the yellow guide line at a distance of approximately 3 ft (1.0 m) from the rear of the vehicle
- ② Trailer drawbar
- ③ Ball coupling

This function is only available on vehicles with a trailer tow hitch.

- Set the height of trailer drawbar ② so that it is slightly higher than ball coupling ③.
- Position the vehicle centrally in front of trailer drawbar ②.



- ① Ball coupling
- ② Red guide line at a distance of approximately 10 in (0.25 m) from the ball coupling
- ③ Trailer drawbar marker assistant
- ④ Trailer drawbar
- ⑤ Symbol for the "Coupling up a trailer" function

► Use the COMAND controller to select symbol ⑤, see the separate operating instructions for COMAND. The "Coupling up a trailer" function is selected. The distance specifications now only

apply to objects that are at the same level as the ball coupling.

- ▶ Back up carefully, making sure that trailer drawbar marker assistant ③ points approximately in the direction of trailer drawbar ④.
- ▶ Reverse carefully until trailer drawbar ④ reaches red guide line ②.
- ▶ Couple up the trailer (▷ page 257).

360° camera (surround view)

General notes

The 360° camera is a system consisting of four cameras.

The system analyzes images from the following cameras:

- Rear view camera
- Front camera
- Two cameras in the exterior rear view mirrors

The cameras capture the immediate surroundings of the vehicle. The system supports you, e.g. when parking or if vision is restricted at an exit.

The 360° camera images can be shown in full screen mode or in seven different split-screen views on the COMAND display. A split-screen view also includes a top view of the vehicle. This view is calculated from the data supplied by the installed cameras (virtual camera).

The seven split-screen views are:

- top view and picture from the rear view camera (130° viewing angle)
- top view and picture from the front camera (without displaying the maximum steering wheel angle)
- top view and enlarged rear view
- top view and enlarged front view
- top view and trailer view (vehicles with trailer tow hitch)

- top view and rear-view images from the exterior mirror cameras (rear wheel view)
- top view and forward-view images from the exterior mirror cameras (front wheel view)

i The top view and trailer view are available for vehicles equipped with a trailer tow hitch.

When the function is active and you shift the transmission from position **D** or **R** to **N**, you see the previous view in the COMAND display. The dynamic guidelines are hidden.

When you change between transmission positions **D** and **R**, you see the previously selected front or rear view.

Important safety notes

The 360° camera is only an aid. It is not a replacement for your attention to your immediate surroundings. You are always responsible for safe maneuvering and parking. When maneuvering or parking, make sure that there are no persons, animals or objects in the area in which you are maneuvering.

The 360° camera may show a distorted view of obstacles, show them incorrectly or not at all. It cannot show objects in the following areas:

- under the front bumper
- very close to the front bumper
- very close to the rear bumper
- under the rear bumper
- in close range above the handle on the trunk lid
- very close to the exterior mirrors

You are always responsible for safety, and must always pay attention to your surroundings when parking and maneuvering. This applies to the areas behind, in front of and beside the vehicle. You could otherwise endanger yourself and others.

The 360° camera will not function or will function in a limited manner:

- if the doors are open
- if the exterior mirrors are folded in

- if the tailgate is open
- in heavy rain, snow or fog
- at night or in very dark places
- if the cameras are exposed to very bright light
- if the area is lit by fluorescent bulbs or LED lighting (the display may flicker)
- if there is a sudden change in temperature, e.g. when driving into a heated garage in winter
- if the camera lenses are dirty or covered
- if the vehicle components in which the cameras are installed are damaged. In this event, have the camera position and setting checked at a qualified specialist workshop.

Do not use the 360° camera in this case. You can otherwise injure others or cause damage to objects or the vehicle.

Activation conditions

The 360° camera image can be displayed if:

- your vehicle is equipped with a 360° camera
- COMAND is switched on, see the separate COMAND operating instructions
- the **360° Camera** function is activated

Activating the 360° camera using the SYS button

- ▶ Press and hold the **[SYS]** button for longer than 2 seconds, see the separate COMAND operating instructions.
Depending on whether position **D** or **R** is engaged, the following is shown:
 - full screen display with the image from the front camera
 - full screen display with the image from the rear view camera

Activating the 360° camera with COMAND

- ▶ Press the **[SYS]** button, see the separate COMAND operating instructions.
- ▶ Select **System** by turning **[⊙]** the COMAND controller and press **[⊙]** to confirm.
- ▶ Select **360° camera** and press **[⊙]** to confirm.

Depending on whether position **D** or **R** is engaged, the following is shown:

- a split screen with top view and the image from the front camera or
- a split screen with top view and the image from the rear view camera

For further information about the COMAND controller, see the separate COMAND operating instructions.



Activating the 360° camera using reverse gear

The 360° camera images can be automatically displayed by engaging reverse gear.

- ▶ Make sure that the SmartKey is in position **2** in the ignition lock.
- ▶ Make sure that the **Activation by R gear** function is selected in COMAND, see the separate COMAND operating instructions.
- ▶ **To show the 360° camera image:** engage reverse gear.
The COMAND display shows the area behind the vehicle in split screen:
 - vehicle with guide lines
 - top view of the vehicle

Selecting the split-screen and full screen displays

- ▶ **To switch between split screen views:** switch to the line with the vehicle icons by sliding **[⊙]** the COMAND controller.
- ▶ Turn **[⊙]** the COMAND controller and select one of the vehicle symbols.

- **To switch to full screen mode:** select **Full Screen** by turning  the COMAND controller and press  to confirm.

Displays in the COMAND display

Important safety notes

! Objects not at ground level may appear to be further away than they actually are, e.g.:

- the bumper of a parked vehicle
- the drawbar of a trailer
- the ball coupling of a trailer tow hitch
- the rear section of an HGV
- a slanted post

Use the guidelines only for orientation. Approach objects no further than the bottom-most guideline.

Top view with picture from the rear view camera

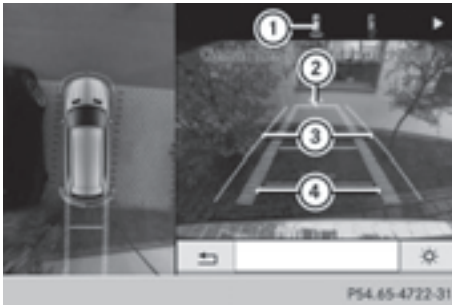

- ① Symbol for the split screen setting with top view and rear view camera image
- ② Yellow guide line at a distance of approximately 13 ft (4.0 m) from the rear of the vehicle
- ③ Yellow guide line for the vehicle width including the exterior mirrors, for current steering wheel angle (dynamic)
- ④ Yellow lane marking tires at current steering wheel angle (dynamic)

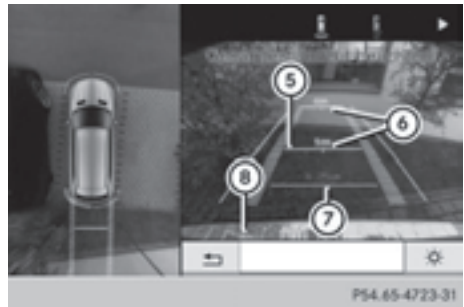

- ⑤ Yellow guide line at a distance of approximately 3 ft (1.0 m) from the rear of the vehicle
- ⑥ Vehicle center axle (marker assistance)
- ⑦ Red guide line at a distance of approximately 12 in (0.30 m) from the rear of the vehicle
- ⑧ Bumper

The guide lines are shown when the transmission is in position **R**.

The distance specifications only apply to objects that are at ground level.

Top view with picture from the front camera

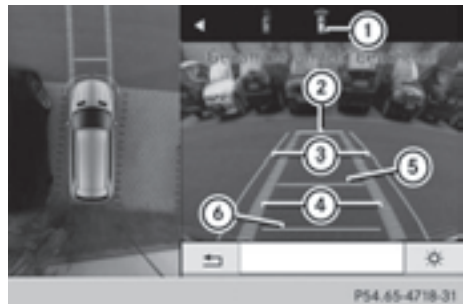

- ① Symbol for the split screen setting with top view and front camera image
- ② Yellow guide line at a distance of approximately 13 ft (4.0 m) from the front of the vehicle
- ③ Yellow guide line for the vehicle width including the exterior mirrors, for current steering wheel angle (dynamic)
- ④ Yellow lane marking tires at current steering wheel angle (dynamic)

- ⑤ Yellow guide line at a distance of approximately 3 ft (1.0 m) from the front of the vehicle
- ⑥ Red guide line at a distance of approximately 12 in (0.30 m) from the front of the vehicle

Top view and enlarged rear view

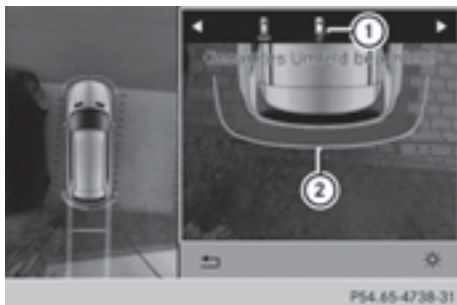

- ① Symbol for the split screen setting with top view and rear view camera image enlarged
- ② Red guide line at a distance of approximately 12 in (0.30 m) from the rear of the vehicle

This view assists you in estimating the distance to the vehicle behind you.

- i** This setting can also be selected as an enlarged front view.

Top view with images from the exterior mirror cameras

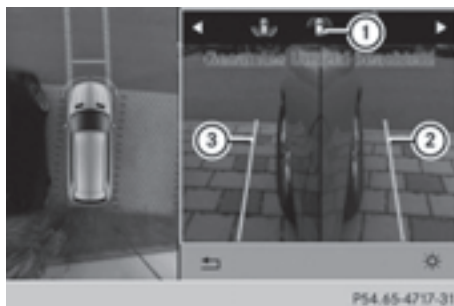

- ① Symbol for the setting with the top view and forward view from the exterior mirror cameras
- ② Yellow guide line for the vehicle width including the exterior mirrors (right side of vehicle)
- ③ Yellow guide line for the vehicle width including the exterior mirrors (left side of vehicle)

Top view with trailer view

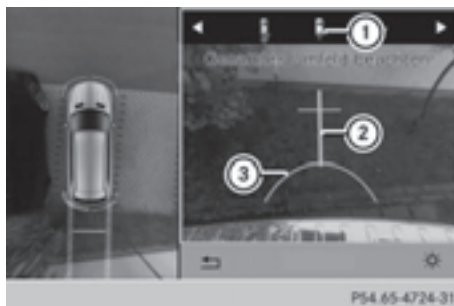

- ① Symbol for the trailer view setting
- ② Trailer drawbar marker assistant
- ③ Red guide line at a distance of approximately 12 in (0.30 m) from the ball coupling

Wide-angle function



Example: full screen mode with PARKTRONIC display



- ① Symbol for the full screen setting with rear view camera image
- ② PARKTRONIC warning display

If the vehicle is equipped with PARKTRONIC and the function is active (▷ page 219), warning displays ② in the COMAND display are also active or light up accordingly.

PARKTRONIC appears:

- in split screen view as red or yellow brackets around the vehicle icon in the top view, or
 - in the full screen view, on the right-hand side at the bottom as red or yellow brackets around the vehicle icon
- i** The full screen display can also be selected as front view.

Exiting 360° camera display mode

As soon as your vehicle exceeds a speed of 19 mph (30 km/h) with the function activated, the function switches off. The COMAND display switches back to the previously selected view. You can also switch the display by selecting the  symbol in the display and pressing  the COMAND controller to confirm.

ATTENTION ASSIST

General notes

ATTENTION ASSIST helps you during long, monotonous journeys, such as on highways. It is active in the range between 50 mph (80 km/h) and 112 mph (180 km/h). If ATTENTION ASSIST detects typical indicators of fatigue or increasing lapses in concentration on the part of the driver, it suggests you take a break.

Important safety notes

ATTENTION ASSIST is only an aid to the driver. It might not always recognize fatigue or increasing inattentiveness in time or fail to recognize them at all. The system is not a substitute for a well-rested and attentive driver.

The functionality of ATTENTION ASSIST is restricted and warnings may be delayed or not occur at all:

- if the road condition is poor, e.g. if the surface is uneven or if there are potholes
 - if there is a strong side wind
 - if you have adopted a sporty driving style with high cornering speeds or high rates of acceleration
 - if you are predominantly driving slower than 50 mph (80 km/h) or faster than 112 mph (180 km/h)
 - if the time has been set incorrectly
 - in active driving situations, such as when you change lanes or change your speed
- ATTENTION ASSIST is reset when you continue your journey and starts assessing your tiredness again if:
- you switch off the engine.
 - you take off your seat belt and open the driver's door, e.g. for a change of drivers or to take a break.

Activating ATTENTION ASSIST

- ▶ Activate ATTENTION ASSIST using the on-board computer (▷ page 276).

When ATTENTION ASSIST is deactivated, the  symbol appears in the multifunction display in the assistance graphic display.

ATTENTION ASSIST is activated automatically after the engine is started up.

Warning and display messages in the multifunction display

If fatigue or increasing lapses in concentration are detected, a warning appears in the multifunction display: **Attention Assist: Take a Break!**

In addition to the message shown in the multifunction display, you will then hear a warning tone.

- ▶ If necessary, take a break.
- ▶ Confirm the message by pressing the  button on the steering wheel.

On long journeys, take regular breaks in good time to allow yourself to rest properly. If you do not take a break, you will be warned again after 15 minutes at the earliest. The precondition for this is that ATTENTION ASSIST still detects typical indicators of fatigue or increasing lapses in concentration.

Night View Assist Plus

General notes

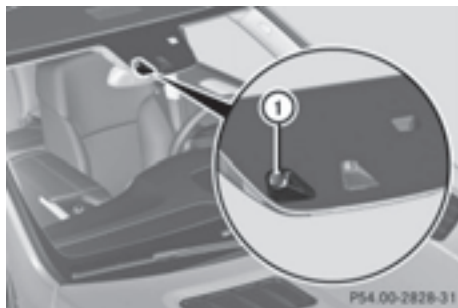

In addition to the illumination provided by the normal headlamps, Night View Assist Plus uses infrared light to illuminate the road. Night View Assist Plus camera ① picks up the infrared light and displays a monochrome image in COMAND. The image displayed in COMAND corresponds to a road lit up by high-beam headlamps. This enables you to see the road's course and any obstacles in good time. If pedestrian recognition is activated, pedestrians recognized by the system are highlighted in the Night View Assist Plus display.

Light from the headlamps of oncoming vehicles does not affect the Night View Assist Plus display in the multifunction display. This is also the case if you cannot switch on the high-beam headlamps due to oncoming traffic.

- ① Infrared light is not visible to the human eye and therefore does not glare. Night View Assist Plus can therefore remain switched on even if there is oncoming traffic.

Important safety notes

Night View Assist Plus is only an aid and is not a substitute for attentive driving. Do not rely on the Night View Assist Plus display. You are responsible for the distance to the vehicle in front, for vehicle speed and for braking in good time. Drive carefully and always adapt your driving style to suit the prevailing road and traffic conditions.

The system may be impaired or may not function if:

- there is poor visibility, e.g. due to snow, rain, fog or spray
- the windshield is dirty, fogged up or covered, for instance by a sticker, in the vicinity of the camera
- on bends, on uphill gradients or downhill gradients

Pedestrian recognition may be impaired or inoperative if:

- pedestrians are partially or entirely obscured by objects, e.g. parked vehicles
- the silhouette of the pedestrian in the Night View Assist Plus display is incomplete or interrupted, e.g. by powerful light reflections
- pedestrians do not contrast adequately from the background
- pedestrians are not in an upright position, e.g. sitting, squatting or lying

Activating Night View Assist Plus

Activation conditions

You can only activate Night View Assist Plus if:

- the SmartKey is in position **2** in the ignition lock.
- it is dark.
- the light switch is in the **AUTO** or  position.
- reverse gear has not been engaged.

Activating Night View Assist Plus



- ▶ Make sure that COMAND is switched on.
- ▶ Press button **1**.
The Night View Assist Plus display appears in the COMAND display.

You can read about how to adjust the brightness of the COMAND display in the COMAND operating instructions.

- i** The infrared headlamps only switch on when the vehicle is being driven at speeds of approximately 6 mph (10 km/h). This means that you do not have the full visual range while the vehicle is stationary and cannot check whether Night View Assist Plus is working.

Pedestrian recognition



- 1** Night View Assist Plus display
- 2** Pedestrian recognized
- 3** Framing
- 4** Symbol for active pedestrian recognition
- i** Animals are not recognized by pedestrian recognition.

Night View Assist Plus is able to recognize pedestrians by typical characteristics, e.g. a silhouette in the shape of a person.

Pedestrian recognition is then switched on automatically if:

- Night View Assist Plus is activated.
- you are driving faster than approximately 6 mph (10 km/h).
- the surroundings are dark, e.g. when driving outside built-up areas without street lighting.

If pedestrian recognition is active, symbol **4** appears. If pedestrians are detected, they are highlighted with framing **3**. If the pedestrian recognition system has brought a pedestrian to your attention, look through the windshield to evaluate the situation. The actual distance to objects and pedestrians cannot be gaged accurately by looking at a screen.

It may be the case that objects are highlighted as well as pedestrians.

Fogged up or dirty windshield

If the windshield in front of the camera is fogged up or dirty on the inside or outside, the Night View Assist Plus display is affected.

- ▶ **To defrost:** check the automatic air conditioning settings (> page 150) and fold down the camera cover (> page 377).
- ▶ **To defrost the inside of the windshield:** fold down the camera cover (> page 377) and clean the windshield (> page 375).

Problems with Night View Assist Plus

Problem	Possible causes/consequences and ► Solutions
The picture quality of Night View Assist Plus has deteriorated.	The windshield wipers are smearing the windshield. ► Replace the wiper blades (▷ page 133).
	The windshield is smeared after the vehicle has been cleaned in a car wash. ► Clean the windshield (▷ page 375).
	There is windshield chip damage in the camera's field of vision. ► Replace the windshield.
	The windshield is fogged up on the inside. ► Defrost the windshield (▷ page 150).
	The windshield is iced up. ► De-ice the windshield (▷ page 149).
	There is dirt on the inside of the windshield. ► Clean the inside of the windshield (▷ page 375).

Lane Tracking package

General notes

The Lane Tracking package consists of Blind Spot Assist (▷ page 237) and Lane Keeping Assist (▷ page 239).

Blind Spot Assist

General notes

Blind Spot Assist uses a radar sensor system to monitor the areas on both sides of your vehicle. It supports you from a speed of approximately 20 mph (30 km/h). A warning display in the exterior mirrors draws your attention to vehicles detected in the monitored area. If you then switch on the corresponding turn signal to change lanes, you will also receive an optical and audible collision warning. Blind Spot Assist uses sensors in the rear bumper for monitoring purposes.

Important safety notes

WARNING

Blind Spot Assist does not react to:

- vehicles overtaken too closely on the side, placing them in the blind spot area
- vehicles which approach with a large speed differential and overtake your vehicle

As a result, Blind Spot Assist may not give warnings in such situations. There is a risk of an accident.

Always observe the traffic conditions carefully, and maintain a safe lateral distance.

Blind Spot Assist is only an aid. It may fail to detect some vehicles and is no substitute for attentive driving.

USA only:

This device has been approved by the FCC as a "Vehicular Radar System". The radar sensor is intended for use in an automotive radar system only. Removing, tampering with, or altering the device will void any

warranties, and is not permitted by the FCC. Do not tamper with, alter, or use in any non-approved way.

Any unauthorized modification to this device could void the user's authority to operate the equipment.

Monitoring range of the sensors

In particular, the detection of obstacles can be impaired if:

- there is dirt on the sensors or anything else covering the sensors
- there is poor visibility, e.g. due to fog, heavy rain, snow or spray
- there are narrow vehicles, e.g. motorcycles or bicycles
- the road has very wide lanes
- the road has narrow lanes
- you are not driving in the middle of the lane
- there are barriers or similar lane borders

Vehicles in the monitoring range are then not indicated.

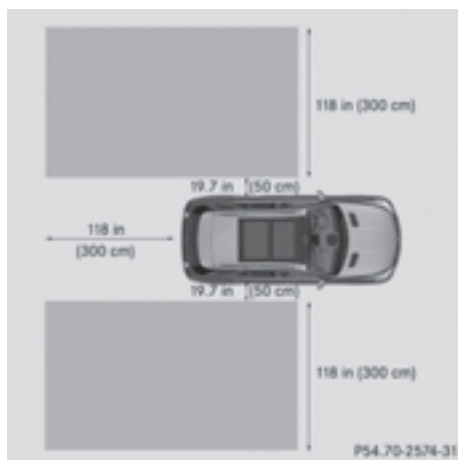

Blind Spot Assist monitors the area up to 10 ft (3 m) behind your vehicle and directly next to your vehicle, as shown in the diagram.

If the lanes are narrow, vehicles driving in the lane beyond the lane next to your vehicle may be indicated, especially if the vehicles are not driving in the middle of their lane. This may be

the case if there are vehicles driving at the inner edge of their lanes.

Due to the nature of the system:

- warnings may be issued in error when driving close to crash barriers or similar solid lane borders.
- the warning is canceled when driving for an extended period next to long vehicles, such as trucks.

The two radar sensors for Blind Spot Assist are integrated into the sides of the rear bumper. Make sure that the bumper is free of dirt, ice or slush in the vicinity of the sensors. The sensors must not be covered, for example by cycle racks or overhanging loads. Following a severe impact or in the event of damage to the bumpers, have the condition of the radar sensors checked at a qualified specialist workshop. Blind Spot Assist may otherwise not work properly.

Indicator and warning display

Blind Spot Assist is not active at speeds below approximately 20 mph (30 km/h). Vehicles in the monitoring range are then not indicated.



① Yellow indicator lamp/red warning lamp

When Blind Spot Assist is activated, indicator lamp ① in the exterior mirrors lights up yellow at speeds of up to 20 mph (30 km/h). At speeds above 20 mph (30 km/h), the indicator lamp goes out and Blind Spot Assist is operational.

If a vehicle is detected within the blind spot monitoring range at speeds above 20 mph (30 km/h), warning lamp ① on the corre-

sponding side lights up red. This warning is always emitted when a vehicle enters the blind spot monitoring range from behind or from the side. When you overtake a vehicle, the warning only occurs if the difference in speed is less than 7 mph (12 km/h).

The yellow indicator lamp goes out if reverse gear is engaged. In this event, Blind Spot Assist is no longer active.

The brightness of the indicator/warning lamps is adjusted automatically according to the ambient light.

Collision warning

If a vehicle is detected in the monitoring range of Blind Spot Assist and you switch on the corresponding turn signal, a double warning tone sounds. Red warning lamp ① flashes. If the turn signal remains on, detected vehicles are indicated by the flashing of red warning lamp ①. There are no further warning tones.

Switching on Blind Spot Assist

- ▶ Make sure that the radar sensor system (▷ page 279) and Blind Spot Assist (▷ page 276) are activated in the on-board computer.
- ▶ Turn the SmartKey to position **2** in the ignition lock.
 - Warning lamps ① in the exterior mirrors light up red for approximately 1.5 seconds and then turn yellow.

Towing a trailer

When you attach a trailer, make sure you have correctly established the electrical connection. This can be accomplished by checking the trailer lighting. In this event, Blind Spot Assist is deactivated. The indicator lamp in the exterior mirrors lights up yellow, and the **Blind Spot Assist Currently Unavailable See Operator's Manual** message appears in the multifunction display.

- ① You can deactivate the indicator lamps in the exterior mirrors.

To do so, switch off Blind Spot Assist when:

- the SmartKey is in position **2** in the ignition lock
- the engine is not running
- the electrical connection to the trailer has been established

Lane Keeping Assist

General notes

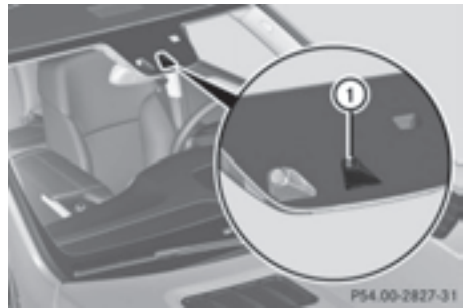

- ① Lane Keeping Assist camera

Lane Keeping Assist monitors the area in front of your vehicle by means of a camera ① at the top of the windshield. Lane Keeping Assist detects lane markings on the road and warns you before you leave your lane unintentionally.

If you select **km** on the on-board computer in the **Display Unit Speed-/Odometer** function (▷ page 277), Lane Keeping Assist is active starting at a speed of 60 km/h. If the **miles** display unit is selected, the assistance range begins at 40 mph.

A warning may be given if a front wheel passes over a lane marking. It will warn you by means of intermittent vibration in the steering wheel for up to 1.5 seconds.

Important safety notes

WARNING

Lane Keeping Assist may not always clearly recognize lane markings.

In this case, Lane Keeping Assist may:

- give an unnecessary warning
- not give a warning

There is a risk of an accident.

Always pay particular attention to the traffic situation and stay in lane, in particular if warned by Lane Keeping Assist.

WARNING

The Lane Keeping Assist warning does not return the vehicle to the original lane. There is a risk of an accident.

You should always steer, brake or accelerate yourself, in particular if warned by Lane Keeping Assist.

If you fail to adapt your driving style, Lane Keeping Assist can neither reduce the risk of an accident nor override the laws of physics. Lane Keeping Assist cannot take into account the road, traffic and weather conditions. Lane Keeping Assist is merely an aid. You are responsible for the distance to the vehicle in front, for vehicle speed, for braking in good time and for staying in your lane.

The Lane Keeping Assist does not keep the vehicle in the lane.

The system may be impaired or may not function if:

- there is poor visibility, e.g. due to insufficient illumination of the road, or due to snow, rain, fog or spray
- there is glare, e.g. from oncoming traffic, the sun or reflections (e.g. when the road surface is wet)
- the windshield is dirty, fogged up, damaged or covered, for instance by a sticker, in the vicinity of the camera
- there are no, several or unclear lane markings for a lane, e.g. in areas with road construction work
- the lane markings are worn away, dark or covered up, e.g. by dirt or snow

- the distance to the vehicle in front is too small and the lane markings thus cannot be detected
- the lane markings change quickly, e.g. lanes branch off, cross one another or merge
- the road is narrow and winding
- there are strong shadows cast on the lane

Switching on Lane Keeping Assist

- ▶ Switch on Active Lane Keeping Assist using the on-board computer; to do so, select **Standard** or **Adaptive** (▷ page 276). If you drive at speeds above 40 mph (60 km/h) and lane markings are detected, the lines in the assistance graphics display (▷ page 275) are shown in green. Lane Keeping Assist is ready for use.

Standard

If **Standard** is selected, no warning vibration occurs if:

- you switch on the turn signals. In this event, the warnings are suppressed for a certain period of time.
- a driving safety system intervenes, such as ABS, BAS or ESP®.

Adaptive

When **Adaptive** is selected, no warning vibration occurs if:

- you switch on the turn signals. In this event, the warnings are suppressed for a certain period of time.
- a driving safety system intervenes, e.g. ABS, BAS or ESP®.
- you accelerate hard, e.g. kickdown.
- you brake hard.
- you steer actively, e.g. swerve to avoid an obstacle or change lanes quickly.
- you cut the corner on a sharp bend.

In order that you are warned only when necessary and in good time if you cross the lane marking, the system recognizes certain conditions and warns you accordingly.

The warning vibration occurs earlier if:

- you approach the outer lane marking on a bend.
- the road has very wide lanes, e.g. a highway.
- the system recognizes solid lane markings.

The warning vibration occurs later if:

- the road has narrow lanes.
- you cut the corner on a bend.

Active Driving Assistance package

General notes

The Active Driving Assistance package consists of DISTRONIC PLUS (▷ page 198), Active Blind Spot Assist (▷ page 241) and Active Lane Keeping Assist (▷ page 244).

Active Blind Spot Assist

General notes

Active Blind Spot Assist uses a radar sensor system to monitor the side areas of your vehicle which are behind the driver. A warning display in the exterior mirrors draws your attention to vehicles detected in the monitored area. If you then switch on the corresponding turn signal to change lanes, you will also receive a visual and audible collision warning. If a risk of lateral collision is detected, corrective braking may help you avoid a collision. Before a course-correcting brake application, Active Blind Spot Assist evaluates the space in the direction of travel and at the sides of the vehicle. For this, Active Blind Spot Assist uses radar sensors which are pointed in the direction of travel.

Active Blind Spot Assist supports you from a speed of approximately 20 mph (30 km/h).

Important safety notes

Active Blind Spot Assist is only an aid. It may fail to detect some vehicles and is no substitute for attentive driving.

WARNING

Active Blind Spot Assist does not react to:

- vehicles overtaken too closely on the side, placing them in the blind spot area
- vehicles which approach with a large speed differential and overtake your vehicle

As a result, Active Blind Spot Assist may neither give warnings nor intervene in such situations. There is a risk of an accident.

Always observe the traffic conditions carefully, and maintain a safe lateral distance.

i USA only: This device has been approved by the FCC as a "Vehicular Radar System". The radar sensor is intended for use in an automotive radar system only. Removal, tampering, or altering of the device will void any warranties, and is not permitted by the FCC. Do not tamper with, alter, or use in any non-approved way.

Any unauthorized modification to this device could void the user's authority to operate the equipment.

i Canada only: This device complies with RSS-210 of Industry Canada. Operation is subject to the following two conditions:

1. This device may not cause harmful interference, and
2. This device must accept any interference received, including interference that may cause undesired operation of the device.

Removal, tampering, or altering of the device will void any warranties, and is not permitted. Do not tamper with, alter, or use in any non-approved way.

Any unauthorized modification to this device could void the user's authority to operate the equipment.

Radar sensors

The Active Blind Spot Assist radar sensors are integrated into the front and rear bumpers and behind a cover in the radiator trim. Make sure that the bumpers and the cover in the radiator grill are free of dirt, ice or slush. The

rear sensors must not be covered, e.g. by bicycle racks or overhanging loads. Following a severe impact or in the event of damage to the bumpers, have the function of the radar sensors checked at a qualified specialist workshop. Active Blind Spot Assist may otherwise no longer work properly.

Monitoring area

WARNING

Active Blind Spot Assist does not detect all traffic situations and road users. There is a risk of an accident.

Always make sure that there is sufficient distance on the side for other traffic or obstacles.

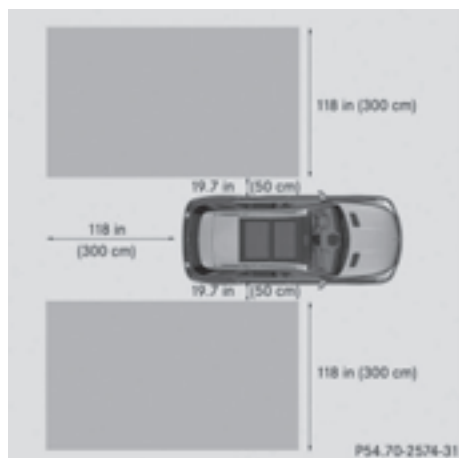

Active Blind Spot Assist monitors the area up to 10 ft (3.0 m) behind your vehicle and directly next to your vehicle, as shown in the diagram. For this purpose, Active Blind Spot Assist uses radar sensors in the rear bumper. In particular, the detection of obstacles can be impaired if:

- there is dirt on the sensors or anything else covering the sensors
- there is poor visibility, e.g. due to fog, heavy rain, snow or spray

Vehicles in the monitoring range are then not indicated.

Active Blind Spot Assist may not detect narrow vehicles, such as motorcycles or bicycles, or may only detect them too late.

If the lanes are narrow, vehicles driving in the lane beyond the lane next to your vehicle may be indicated, especially if the vehicles are not driving in the middle of their lane. This may be the case if there are vehicles at the inner edge of your lane.

Due to the nature of the system:

- warnings may be issued in error when driving close to crash barriers or similar solid lane borders.
- warnings may be interrupted when driving alongside particularly long vehicles, e.g. trucks, for a prolonged time.

Indicator and warning display



① Yellow indicator lamp/red warning lamp

Active Blind Spot Assist is not active at speeds below approximately 20 mph (30 km/h). Vehicles in the monitoring range are then not indicated.

When Active Blind Spot Assist is activated, indicator lamp ① in the exterior mirrors lights up yellow at speeds of up to 20 mph (30 km/h). At speeds above 20 mph (30 km/h), the indicator lamp goes out and Active Blind Spot Assist is operational.

If a vehicle is detected within the blind spot monitoring range at speeds above 20 mph (30 km/h), warning lamp ① on the corresponding side lights up red. This warning is always emitted when a vehicle enters the blind spot monitoring range from behind or

from the side. When you overtake a vehicle, the warning only occurs if the difference in speed is less than 7 mph (12 km/h).

The yellow indicator lamp goes out if reverse gear is engaged. In this event, Active Blind Spot Assist is no longer active.

The brightness of the indicator/warning lamps is adjusted automatically according to the ambient light.

Visual and acoustic collision warning

If you switch on the turn signals to change lanes and a vehicle is detected in the side monitoring range, you receive a visual and acoustic collision warning. You then hear a double warning tone and red warning lamp ① flashes. If the turn signal remains on, detected vehicles are indicated by the flashing of red warning lamp ①. There are no further warning tones.

Course-correcting brake application

If Active Blind Spot Assist detects a risk of a lateral collision in the monitoring range, a course-correcting brake application is carried out. This is meant to assist you in avoiding a collision.

WARNING

A course-correcting brake application cannot always prevent a collision. There is a risk of an accident.

Always steer, brake or accelerate yourself, especially if Active Blind Spot Assist warns you or makes a course-correcting brake application. Always maintain a safe distance at the sides.



If a course-correcting brake application occurs, red warning lamp ① flashes in the exterior mirror and a dual warning tone sounds. In addition, display ② underlining the danger of a side collision appears in the multifunction display.

In very rare cases, the system may make an inappropriate brake application. A course-correcting brake application may be interrupted at any time if you steer slightly in the opposite direction or accelerate.

The course-correcting brake application is available in the speed range between 20 mph (30 km/h) and 120 mph (200 km/h).

Either no braking application, or a course-correcting brake application adapted to the driving situation occurs if:

- there are vehicles or obstacles, e.g. crash barriers, located on both sides of your vehicle.
- a vehicle approaches you too closely at the side.
- you have adopted a sporty driving style with high cornering speeds.
- you clearly brake or accelerate.
- a driving safety system intervenes, e.g. ESP® or PRE-SAFE® Brake.
- ESP® is switched off.
- the off-road program is activated (vehicles without the ON&OFFROAD package).
- off-road program 1 or 2 is activated (vehicles with the ON&OFFROAD package).

- the LOW RANGE off-road gear is activated (vehicles with the ON&OFFROAD package).
- a loss of tire pressure or a defective tire is detected.

Switching on Active Blind Spot Assist



- ▶ Make sure that the radar sensor system (▷ page 279) and Active Blind Spot Assist (▷ page 276) are activated in the on-board computer.
- ▶ Turn the SmartKey to position **2** in the ignition lock.
Warning lamps ① in the exterior mirrors light up red for approximately 1.5 seconds and then turn yellow.

Towing a trailer

When you attach a trailer, make sure you have correctly established the electrical connection. This can be accomplished by checking the trailer lighting. Active Blind Spot Assist is then deactivated. The indicator lamp lights up yellow in the exterior mirrors and the **Active Blind Spot Assist Currently Unavailable See Operator's Manual** message appears in the multifunction display.

Active Lane Keeping Assist

General notes

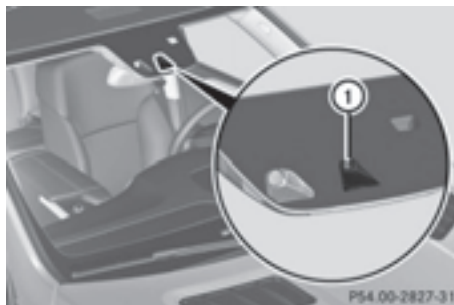

Active Lane Keeping Assist monitors the area in front of your vehicle by means of camera ① at the top of the windshield. Active Lane Keeping Assist detects lane markings on the road and warns you before you leave your lane unintentionally. If you do not react to the warning, a lane-correcting application of the brakes can bring the vehicle back into the original lane.

If you select **km** in the **Display Unit Speed-/Odometer**: function on the on-board computer (▷ page 277), Active Lane Keeping Assist is activated starting at a speed of 60 km/h. If the **miles** display unit is selected, the assistance range begins at 40 mph.

Important safety notes

If you fail to adapt your driving style, Active Lane Keeping Assist can neither reduce the risk of accident nor override the laws of physics. Lane Keeping Assist cannot take into account the road, traffic and weather conditions. Lane Keeping Assist is merely an aid. You are responsible for the distance to the vehicle in front, for vehicle speed, for braking in good time and for staying in your lane.

Active Lane Keeping Assist cannot continuously keep your vehicle in its lane.

WARNING

Active Lane Keeping Assist cannot always clearly detect lane markings.

In such cases, Active Lane Keeping Assist can:

- give an unnecessary warning and then make a course-correcting brake application to the vehicle
- not give a warning or intervene

There is a risk of an accident.

Always pay particular attention to the traffic situation and keep within the lane, especially if Active Lane Keeping Assist alerts you. Terminate the intervention in a non-critical driving situation.

The system may be impaired or may not function if:

- there is poor visibility, e.g. due to insufficient illumination of the road, or due to snow, rain, fog or spray
- there is glare, e.g. from oncoming traffic, the sun or reflections (e.g. when the road surface is wet)
- the windshield is dirty, fogged up, damaged or covered, for instance by a sticker, in the vicinity of the camera
- there are no, several or unclear lane markings for a lane, e.g. in areas with road construction work
- the lane markings are worn away, dark or covered up, e.g. by dirt or snow
- the distance to the vehicle in front is too small and the lane markings thus cannot be detected
- the lane markings change quickly, e.g. lanes branch off, cross one another or merge
- the road is narrow and winding
- there are highly variable shade conditions on the roadway
- no vehicle is detected in the adjacent lane and there are broken lane markings

Warning vibration in the steering wheel

A warning may be given if a front wheel passes over a lane marking. It will warn you by

means of intermittent vibration in the steering wheel for up to 1.5 seconds.

In order that you are warned only when necessary and in good time if you cross the lane marking, the system recognizes certain conditions and warns you accordingly.

The warning vibration occurs earlier if:

- you approach the outer lane marking on a bend.
- the road has very wide lanes, e.g. a highway.
- the system recognizes solid lane markings.

The warning vibration occurs later if:

- the road has narrow lanes.
- you cut the corner on a bend.

Lane-correcting brake application

WARNING

A lane-correcting brake application cannot always bring the vehicle back into the original lane. There is a risk of an accident.

Always steer, brake or accelerate yourself, especially if Active Lane Keeping Assist warns you or makes a lane-correcting brake application.

WARNING

Active Lane Keeping Assist does not detect traffic conditions or road users. In very rare cases, the system may make an inappropriate brake application, e.g. after intentionally driving over a solid lane marking. There is a risk of an accident.

An inappropriate brake application may be interrupted at any time if you steer slightly in the opposite direction. Always make sure that there is sufficient distance on the side for other traffic or obstacles.



If a lane-correcting brake application occurs, display ① appears in the multifunction display.

If you leave your lane, under certain circumstances the vehicle will brake briefly on one side. This is meant to assist you in bringing the vehicle back to the original lane.

This function is available in the range between 40 mph and 120 mph (60 km/h and 200 km/h).

A lane-correcting brake application can only be made after driving over a solid, recognizable lane marking. Before this, a warning must be given by means of intermittent vibration in the steering wheel. In addition, a lane with lane markings on both sides must be recognized. The brake application also slightly reduces vehicle speed.

i A further lane-correcting brake application can only occur after your vehicle has returned to the original lane.

No lane-correcting brake application occurs if:

- you clearly and actively steer, brake or accelerate.
- you cut the corner on a sharp bend.
- you have switched on the turn signal.
- a driving safety system intervenes, e.g. ESP®, PRE-SAFE® Brake or Active Blind Spot Assist.
- you have adopted a sporty driving style with high cornering speeds or high rates of acceleration.
- ESP® is switched off.

- the transmission is not in position **D**.
- on vehicles with a trailer tow hitch, the electrical connection to the trailer has been correctly established.
- the off-road program is activated (vehicles without the ON&OFFROAD package).
- off-road program 1 or 2 is activated (vehicles with the ON&OFFROAD package).
- the LOW RANGE off-road gear is activated (vehicles with the ON&OFFROAD package).
- a loss of tire pressure or a defective tire has been detected and displayed.

Active Lane Keeping Assist does not detect traffic situations or road users. An inappropriate brake application may be interrupted at any time if you:

- steer slightly in the opposite direction
- switch on the turn signal
- clearly brake or accelerate

A lane-correcting brake application is interrupted automatically if:

- a driving safety system intervenes, e.g. ESP®, PRE-SAFE® Brake or Active Blind Spot Assist.
- lane markings can no longer be recognized.

Switching on Active Lane Keeping Assist

► Switch on Active Lane Keeping Assist using the on-board computer; to do so, select **Standard** or **Adaptive** (▷ page 276).

If you drive at speeds above 40 mph (60 km/h) and lane markings are detected, the lines in the assistance graphics display (▷ page 275) are shown in green. Lane Keeping Assist is ready for use.

When **Standard** is selected, no warning vibration occurs if:

- you switch on the turn signals. In this event, the warnings are suppressed for a certain period of time.
- a driving safety system intervenes, such as ABS, BAS or ESP®.

When **Adaptive** is selected, no warning vibration occurs if:

- you switch on the turn signals. In this event, the warnings are suppressed for a certain period of time.
- a driving safety system intervenes, e.g. ABS, BAS or ESP®.
- you accelerate hard, e.g. kickdown.
- you brake hard.
- you steer actively, e.g. swerve to avoid an obstacle or change lanes quickly.
- you cut the corner on a sharp bend.



Towing a trailer

When you attach a trailer, make sure you have correctly established the electrical connection. This can be accomplished by checking the trailer lighting.

On-road programs (vehicles with the ON&OFFROAD package)

General notes

The on-road programs assist you during on-road driving and the off-road programs when driving off-road (> page 251).

The following program messages remain in the multifunction display until the corresponding vehicle level has been set. Up to off-road level 2, you can hide the program messages using the  or  button on the multifunction steering wheel.

AUTO program



Select the AUTO program for a more comfortable ride under all normal driving conditions.

Your selection remains stored even if you remove the SmartKey from the ignition lock.

- ▶ **Selector wheel ① engaged:** briefly press selector wheel ①.
Selector wheel ① extends.
- ▶ **To select:** turn selector wheel ① until indicator lamp ② comes on.
AUTO indicator ③ appears in the multifunction display.
 - Highway level is set.
 - ADS (Adaptive Damping System) adapts comfortable damping characteristics to the current operating and driving conditions.
 - The automatic transmission selects the automatic drive program for a comfortable driving style that provides for optimum fuel consumption.

SPORT program



Select the SPORT program for sporty, dynamic handling.

Your selection remains stored even if you remove the SmartKey from the ignition lock.

- ▶ **Selector wheel ① engaged:** briefly press selector wheel ①.
Selector wheel ① extends.
- ▶ **To select:** turn selector wheel ① until indicator lamp ② comes on.
SPORT indicator ③ appears in the multi-function display.
 - High-speed level, -15 mm compared to highway level, is set.
 - ADS (Adaptive Damping System) adapts sporty damping characteristics to the current operating and driving conditions.
 - The automatic transmission selects the automatic drive program for a sporty driving style.
 - The sporty accelerator pedal curve is selected, e.g. the accelerator pedal no

longer has to be pressed as far to accelerate.

- The sporty steering curve is selected, e.g. greater force is required when steering.

- ① You cannot select the SPORT program if LOW RANGE has been selected. The **Drive Program SPORT Not in LOW RANGE** message then appears in the multi-function display.

Snow program



Select the snow program for driving in snow with or without snow chains.

- ▶ **Selector wheel ① engaged:** briefly press selector wheel ①.
Selector wheel ① extends.
- ▶ **To select:** turn selector wheel ① until indicator lamp ② comes on.
Snow indicator ③ appears in the multi-function display.

- Highway level is set.
- ADS (Adaptive Damping System) adapts comfortable damping characteristics to the current operating and driving conditions.
- 4ETS and the differential lock are adapted for driving on snow-covered roads.
- The automatic transmission selects the automatic drive program for a comfortable driving style that provides for optimum fuel consumption.
- The soft accelerator pedal curve is selected, e.g. the accelerator pedal must be pressed significantly further to accelerate.
- The optimum gear for pulling away is engaged.

- ▶ **Selector wheel ① engaged:** briefly press selector wheel ①.
Selector wheel ① extends.
- ▶ **To select:** turn selector wheel ① until indicator lamp ② comes on.
Trailer indicator ③ appears in the multi-function display.
 - Highway level is set.
 - ADS (Adaptive Damping System) adapts comfortable damping characteristics to the current operating and driving conditions.
 - The automatic transmission selects the automatic drive program for a comfortable driving style that provides for optimum fuel consumption, changing gear at optimum points.
 - While pulling away, the differential locks are engaged.

Trailer program



Select the trailer program when towing a trailer.

Off-road driving systems

4MATIC (permanent four-wheel drive)

If you fail to adapt your driving style, 4MATIC can neither reduce the risk of accident nor override the laws of physics. 4MATIC cannot take account of road, weather and traffic conditions. 4MATIC is only an aid. You are responsible for the distance to the vehicle in front, for vehicle speed, for braking in good time and for staying in your lane.

! Never tow the vehicle with one axle raised. This may damage the transfer case. Damage of this sort is not covered by the Mercedes-Benz Limited Warranty. All wheels must remain either on the ground or be fully raised. Observe the instructions for towing the vehicle with all wheels in full contact with the ground.

! A function or performance test should only be carried out on a two-axle dynamometer. Before you operate the vehicle on such a dynamometer, please consult a

qualified workshop. You could otherwise damage the drive train or the brake system.

4MATIC ensures that all four wheels are permanently driven. Together with ESP® and 4ETS, it improves the traction of your vehicle whenever a drive wheel spins due to insufficient grip.

- ❗ In wintry driving conditions, the maximum effect of 4MATIC can only be achieved if you use winter tires (M+S tires), with snow chains if necessary.

Further information about "Driving off-road" (▷ page 191).

DSR (Downhill Speed Regulation)

Important safety notes

DSR assists you when driving downhill. It keeps the speed of travel at the speed set on the on-board computer. The steeper the downhill gradient, the greater the DSR braking effect on the vehicle. When driving on flat stretches of road or on an uphill gradient, the DSR braking effect is minimal or nonexistent.

DSR controls the set speed when it is active and the automatic transmission is in the **D**, **R** or **N** position. By accelerating or braking, you can always drive at a higher or a lower speed than that set on the on-board computer.

Further information about "Driving off-road" (▷ page 191).

If you fail to adapt your driving style, DSR can neither reduce the risk of accident nor override the laws of physics. DSR cannot take account of road, weather and traffic conditions. DSR is only an aid. You are responsible for the distance to the vehicle in front, for vehicle speed, for braking in good time and for staying in your lane.

You are always responsible for keeping control of the vehicle and for assessing whether the downhill gradient can be managed. DSR may not always be able to keep to the set speed, depending on road surface and tire conditions. Select a set speed suitable for the

prevailing conditions and when necessary, apply the brakes manually.

⚠ WARNING

If the speed driven and the set speed deviate and you activate DSR on a slippery road surface, the wheels may lose traction. There is an increased danger of skidding and accidents.

Before switching DSR on, please take into consideration the road surface and the difference between driving speed and the set speed.

Activating DSR

⚠ WARNING

If you drive faster than the set speed and activate DSR, the vehicle will decelerate on downhill gradients. If you do not know the set speed, the vehicle could decelerate unexpectedly. There is a risk of an accident.

Decelerate the vehicle to the set speed before activating DSR. If you do not know what the stored set speed is, store the desired set speed again.



Example: vehicles with the ON&OFFROAD package

- ① DSR button
- ② DSR indicator lamp

- ▶ Press button ①. Indicator lamp ② lights up.

The  DSR symbol appears in the multifunction display.

You can only activate DSR when driving at speeds below 25 mph (40 km/h).

If the current vehicle speed is too high, the  DSR symbol appears in the multifunction display with the **Max. speed 25 mph** message (Canada: **40 km/h**).

- i** You cannot activate DSR if the SPORT on-road program is activated. The  DSR symbol and the **Not in Drive Program SPORT** message then appears in the multifunction display.

Deactivating DSR

- ▶ Press button **①**.
Indicator lamp **②** goes out.
The  DSR symbol appears in the multifunction display with the **Off** message.

DSR switches off automatically if you drive faster than 28 mph (Canada: 45 km/h). The  DSR symbol appears in the multifunction display with the **Off** message. The status indicator in the multifunction display goes out. You also hear a warning. On vehicles with the ON&OFFROAD package, if you select a different on-road/off-road program, DSR is also deactivated.

Changing the set speed

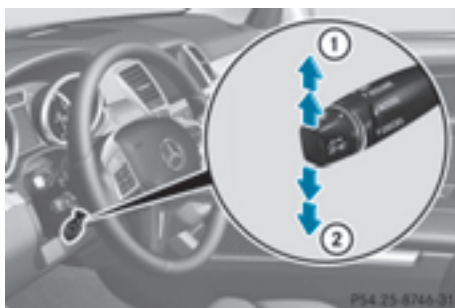

- ▶ **To increase or decrease in 1 mph increments (Canada: 1 km/h increments):** briefly press the cruise control lever up **①**

for a higher set speed or down **②** for a lower set speed.

The set speed appears in the multifunction display with the  DSR symbol. It is also displayed in status indicator **③**.

When DSR is activated, you can change the set speed to a value between 1 mph and 11 mph (Canada: between 2 km/h and 18 km/h).

- i** The DSR set speed is always changed in 1 mph increments (Canada: 1 km/h increments). This is regardless of whether you press the cruise control lever to or beyond the pressure point.

Off-road programs (vehicles with the ON&OFFROAD package)

General notes

The off-road programs assist you in driving off-road. The engine's performance characteristics and the gearshifting characteristics of the automatic transmission are adapted for this purpose. ABS, ESP® and 4ETS programs especially adapted to off-road driving are activated. An accelerator pedal curve suitable for the terrain is selected, i.e. the accelerator pedal must be depressed further to accelerate.

Do not use the off-road programs on roads that are snow-covered or icy or if you have mounted snow chains on your vehicle.

For information on driving off-road, see (> page 191).

The following program messages are shown in the multifunction display until the applicable vehicle level is set. Up to off-road level 2, you can hide the program messages using the  or the **OK** button on the multifunction steering wheel.

Off-road program 1



- ▶ **Selector wheel ① engaged:** briefly press selector wheel ①.
Selector wheel ① extends.
- ▶ **To select:** turn selector wheel ① until indicator lamp ② comes on.
Off-road indicator ③ appears in the multi-function display.
Off-road level 1 is set to +1.2 in (+30 mm) above the vehicle's "highway" level.

Off-road program 1 switches to the AUTO program if you drive faster than 70 mph (110 km/h).

Select off-road program 1 for gentle off-road terrain, e.g. for gravel or sand surfaces or tracks. The engine's torque is restricted to a limited degree and the drive wheels can spin. The spinning wheels produce a cutting effect for better traction.

You can only activate off-road program 1 when driving at speeds of 60 mph (100 km/h) or below. The **Drive Program OFFROAD 1 Max. 60 mph (100 km/h)** message appears in the multifunction display.

Off-road program 2



- ▶ **Selector wheel ① engaged:** briefly press selector wheel ①.
Selector wheel ① extends.
- ▶ **To select:** turn selector wheel ① until indicator lamp ② comes on.
Off-road indicator ③ appears in the multi-function display.
 - Off-road level 1 is set to +2.4 in (+60 mm) above the vehicle's "highway" level.
 - DSR is switched on.
 - The differential lock is closed.

Off-road program 2 automatically switches to off-road program 1 if you drive faster than 30 mph (45 km/h).

Select off-road program 2 for rough terrain, e.g. for steep and/or rough terrain or driving on rocky terrain.

i Your vehicle has an automatically activated differential lock for the transfer case. It controls the balance between the front and rear axles.

The differential lock improves the vehicle's traction. 4ETS (▷ page 73) controls the balance between both wheels on an axle.

You can only activate off-road program 2 when driving at speeds of 25 mph (40 km/h) or below.

LOW RANGE off-road gear (vehicles with the ON&OFFROAD package)

Important safety notes

WARNING

If you select the LOW RANGE off-road gear on a slippery road surface, the wheels could lose traction:

- if you remove your foot from the accelerator pedal when driving
- if off road ABS intervenes when braking

If the wheels lose traction, the vehicle can no longer be steered. There is an increased danger of skidding and accidents.

Never select the LOW RANGE off-road gear when driving on slippery road surfaces.

WARNING

If you do not wait for the transfer case gear change process to complete, the transfer case could remain in the neutral position. The power transmission to the driven wheels is then interrupted. There is a danger of the vehicle rolling away unintentionally. There is a risk of an accident.

Wait until the transfer case shift process is completed.

Do not turn off the engine while changing gear and do not shift the automatic transmission to another position.

General notes

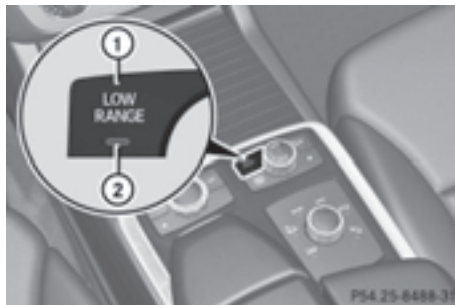

- ① LOW RANGE off-road gear button
- ② LOW RANGE off-road gear indicator lamp

HIGH RANGE	Position for all normal on-road driving conditions
-------------------	--

LOW RANGE	Off-road position for driving off-road and fording The transmission ratio between the engine and wheels is only approximately one third of that in the HIGH RANGE road position. Drive torque is thus proportionately higher.
------------------	--

Do not use LOW RANGE:

- on slippery road surfaces, e.g. in the case of slush
- on snow or ice-covered roads
- if you have mounted snow chains to your vehicle

The LOW RANGE off-road gear assists you in driving off-road and when fording. When LOW RANGE is engaged, the engine's performance characteristics and the gearshifting characteristics of the automatic transmission are adapted for this purpose.

Further information about "Driving off-road" (▷ page 191). You will find information about driving safety systems in conjunction with

LOW RANGE in the "Safety" section (▷ page 67).

From HIGH RANGE to LOW RANGE

! Only change from LOW RANGE to HIGH RANGE if:

- the engine is running.
- the transmission is in position **N**
- you are driving at a speed below 40 km/h

▶ Press LOW RANGE button ①.
Indicator lamp ② flashes.

When the gear change is complete, indicator lamp ② lights up. LOW RANGE indicator appears in the multifunction display and in the status indicator.

While indicator lamp ② is flashing, you can cancel the gear change by pressing LOW RANGE button ① again.

i You cannot activate LOW RANGE if the SPORT on-road program is activated. The **LOW RANGE Not in Drive Program SPORT** message then appears in the multifunction display.

From LOW RANGE to HIGH RANGE

! Only change from LOW RANGE to HIGH RANGE if:

- the engine is running.
- the transmission is in position **N**
- you are driving at a speed below 70 km/h

▶ Press LOW RANGE button ①.
Indicator lamp ② flashes.

When the gear change is complete, indicator lamp ② goes out. In the multifunction display, the **LOW RANGE Off** message appears and status indicator ③ goes out.

While indicator lamp ② is flashing, you can cancel the gear change by pressing LOW RANGE button ① again.

Messages in the multifunction display

If a gear change process has not been successful, the following messages may be displayed in the multifunction display:

Display messages	Possible causes/consequences and ► Solutions
LOW RANGE Max. Speed 40 km/h	You have been driving faster than 40 km/h. Additionally, the indicator lamp on the button in the center console blinks. ► Drive more slowly to carry out the gear change process.
LOW RANGE Shift to Position N Briefly	The transmission is in position D and you are driving at below 40 km/h. ► Shift the transmission to N to complete the gear change process.
LOW RANGE Shifting Canceled Please Reactivate	The gear change process was not carried out. ► Ensure that all gear change conditions are fulfilled and carry out the gear change process again.
LOW RANGE Stop Apply Parking Brake	A warning tone also sounds. The gear change process has not been completed. LOW RANGE is in the neutral position. There is no connection between the engine and the drive wheels. ! Do not drive any further. You could otherwise damage the vehicle's drive train. ► Stop the vehicle. Take into account the road and traffic conditions when doing this. ► Depress the electric parking brake (▷ page 184). ► Carry out the gear change process again. If the gear change process has been carried out, the LOW RANGE Stop Apply Parking Brake message disappears.

ON&OFFROAD menu in the COMAND display (vehicles with the ON&OFFROAD package)



You can display some driving systems, driving programs and additional information in the COMAND display.

- Make sure that the SmartKey is in position **2** in the ignition lock.
- Make sure that COMAND is activated, see the separate COMAND operating instructions.
- Press function button **①**.
The corresponding displays appear in the COMAND display:
 - level control
 - steering angle
 - vehicle's angle of inclination

- uphill or downhill gradient in percentage
- on-road/off-road program selected
- condition of the differential lock for the transfer case
- the LOW RANGE off-road gear is selected
- condition of the LOW RANGE off-road gear
- the on-road trailer program is selected

Towing a trailer

Important safety notes

WARNING

Installing an unsuitable ball coupling may result in overloading of the trailer tow hitch and the rear axle. This applies especially if the ball coupling in question is longer or angled differently. This could seriously impair the driving characteristics and the trailer can come loose. There is a risk of an accident.

You should only ever install a ball coupling that has the permissible dimensions and that is designed to meet your trailer-towing requirements. Do not modify the ball coupling or the trailer tow hitch.

You will find the values approved by the manufacturer on the vehicle identification plates and those for the towing vehicle under "Technical data" (▷ page 460).

WARNING

If the ball coupling is not installed correctly or not secured with the bolt provided and the corresponding spring cotter, the trailer may come loose. There is a risk of an accident.

Always install and secure the ball coupling as described. Before every journey, ensure that the ball coupling is secured with the bolt and the corresponding spring cotter.

WARNING

If you rest your foot on the brake pedal while driving, the braking system can overheat. This increases the stopping distance and can even

cause the braking system to fail. There is a risk of an accident.

Never use the brake pedal as a footrest. Never depress the brake pedal and the accelerator pedal at the same time.

WARNING

When the vehicle/trailer combination begins to lurch, you could lose control of it. The vehicle/trailer combination could even rollover. There is a risk of an accident.

On no account should you attempt to straighten up the vehicle/trailer combination by increasing the speed. Reduce vehicle speed and do not countersteer. Apply the brake as necessary.

- ❗ Depressing the brake pedal constantly results in excessive and premature wear to the brake pads.

Please observe the manufacturer's operating instructions for the trailer coupling if a detachable trailer coupling is used.

Couple and uncouple the trailer carefully. If you do not couple the trailer to the towing vehicle correctly, the trailer could become detached.

Make sure that the following values are not exceeded:

- the permissible trailer drawbar noseweight
- the permissible trailer load
- the permissible rear axle load of the towing vehicle
- the maximum permissible gross vehicle weight of both the towing vehicle and the trailer

The applicable permissible values, which must not be exceeded, can be found:

- in the vehicle documents
- on the identification plates for the trailer tow hitch and the trailer
- on the vehicle identification plate

If the values differ, the lowest value applies.

When towing a trailer, your vehicle's handling characteristics will be different in comparison with when driving without a trailer.

The vehicle/trailer combination:

- is heavier
- is restricted in its acceleration and gradient-climbing capability
- has an increased braking distance
- is affected more by strong crosswinds
- demands more sensitive steering
- has a larger turning radius

This could impair the handling characteristics.

When towing a trailer, always adjust your speed to the current road and weather conditions. Do not exceed the maximum permissible speed for your vehicle/trailer combination.

Notes on towing a trailer

General notes

- Do not exceed the legally prescribed maximum speed for vehicle/trailer combinations in the relevant country.
This lowers the risk of an accident.
 - Only install an approved trailer coupling on your vehicle.
Further information on availability and on installation is available from any authorized Mercedes-Benz Center.
 - The bumpers of your vehicle are not suitable for installing detachable trailer couplings.
 - Do not install hired trailer couplings or other detachable trailer couplings on the bumpers of your vehicle.
 - If you no longer need the ball coupling, remove it from the ball coupling recess.
This will reduce the risk of damage to the ball coupling.
- i** When towing a trailer, set the tire pressure on the rear axle of the towing vehicle

for a maximum load; see the tire pressure table in the fuel filler flap (▷ page 421).

Please note that when towing a trailer, PARKTRONIC (▷ page 217) and Blind Spot Assist (▷ page 237) are only available with limitations, or not at all.

- i** On vehicles without level control, the height of the ball coupling will alter according to the load placed on the vehicle. If necessary, use a trailer with a height-adjustable drawbar.

You will find installing dimensions and loads under "Technical data" (▷ page 459).

Driving tips

- i** Observe the information on ESP® trailer stabilization (▷ page 74) and on pulling away with a trailer (▷ page 161).

The maximum permissible speed for vehicle/trailer combinations depends on the type of trailer. Before beginning the journey, check the trailer's documents to see what the maximum permissible speed is. Observe the legally prescribed maximum speed in the relevant country.

For certain Mercedes-Benz vehicles, the maximum permissible rear axle load is increased when towing a trailer. See "Technical data" to find out whether this applies to your vehicle (▷ page 460). If you utilize any of the added maximum rear axle load when towing a trailer, the vehicle/trailer combination may not exceed a maximum speed of 60 mph (100 km/h) for reasons concerning the operating permit. This also applies in countries in which the permissible maximum speed for vehicle/trailer combinations is above 60 mph (100 km/h).

When towing a trailer, your vehicle's handling characteristics will be different in comparison with when driving without a trailer.

Use the left-hand paddle shifter to shift into a lower gear in good time on long and steep downhill gradients.

i This also applies if you have activated cruise control or DISTRONIC PLUS.

This will use the braking effect of the engine, so that less braking will be required to maintain the speed. This relieves the load on the brake system and prevents the brakes from overheating and wearing too quickly. If you need additional braking, depress the brake pedal repeatedly rather than continuously.

Driving tips

If the trailer swings from side to side:

- ▶ Do not accelerate.
- ▶ Do not counter-steer.
- ▶ Brake if necessary.
- Maintain a greater distance from the vehicle in front than when driving without a trailer.
- Avoid braking abruptly. If possible, brake gently at first to allow the trailer to run on. Then, increase the braking force rapidly.
- The values given for gradient-climbing capabilities from a standstill refer to sea level. When driving in mountainous areas, note that the power output of the engine and, consequently, the vehicle's gradient-climbing capability, decreases with increasing altitude.

Installing the ball coupling

⚠ WARNING

If the ball coupling is not correctly installed and secured, it can come loose during the journey and endanger other road users. There is a risk of an accident and injury.

Always install and secure the ball coupling as described. Before every journey, ensure that the ball coupling is secured with the bolt and the corresponding spring cotter.

⚠ WARNING

If the ball coupling is not installed correctly or not secured with the bolt provided and the

corresponding spring cotter, the trailer may come loose. There is a risk of an accident.

Always install and secure the ball coupling as described. Before every journey, ensure that the ball coupling is secured with the bolt and the corresponding spring cotter.

⚠ WARNING

If the ball coupling is not installed and secured correctly the trailer may come loose. There is a risk of an accident.

Install and secure the ball coupling as described in the ball coupling installation instructions. Make sure that the ball coupling is installed and secured correctly before every journey.

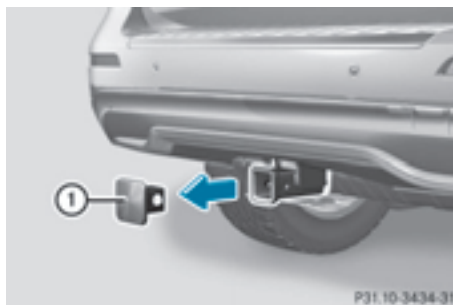

Cover cap

- ▶ Pull protective cap ① in the direction of the arrow, out of the ball coupling recess.
- ▶ Place protective cap ① in the ball coupling recess.

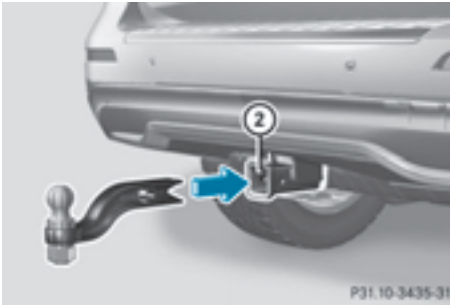

Ball coupling recess

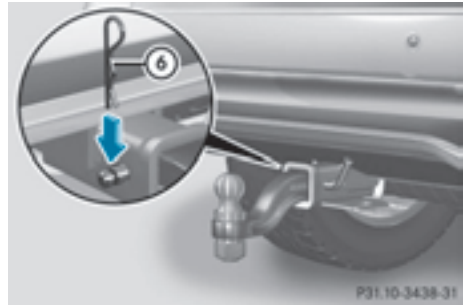

Bolt and spring cotter

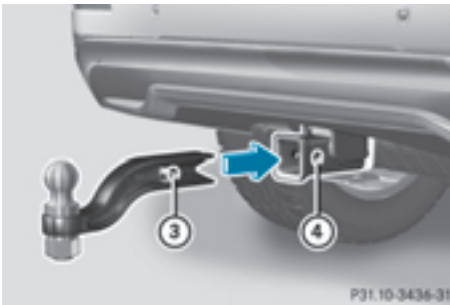

Holes in the ball coupling and ball coupling recess

- ▶ Insert the ball coupling horizontally into ball coupling recess ② in the direction of the arrow until the holes in ball coupling ③ are in line with the holes in ball coupling recess ④.

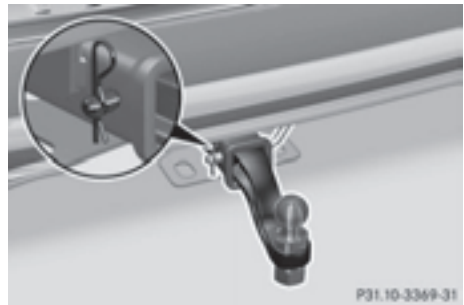

Correctly installed and secured ball coupling

- ▶ Check the ball coupling, bolt and spring cotter for correct installation.

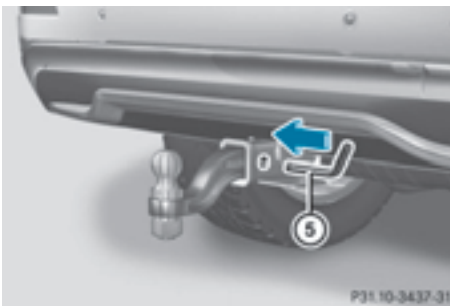

Bolt

- ▶ Slide bolt ⑤ into the hole in the ball coupling recess and the ball coupling to the stop.

If the ball coupling cannot be correctly mounted, remove the ball coupling. Under these circumstances, the ball coupling must not be used for trailer towing.

If the ball coupling cannot be locked and the key cannot be removed, remove the ball coupling and clean it. If the ball coupling can still not be installed (locked) after it has been cleaned, remove the ball coupling. The trailer tow hitch must then not be used to tow a trailer, as safe operation cannot be guaranteed.

Have the entire trailer tow hitch checked at a qualified specialist workshop.

Coupling up a trailer

- ❗ Do not connect the trailer's brake system (if featured) to the hydraulic brake system

of the towing vehicle, as the latter is equipped with an anti-lock brake system. Doing so will result in a loss of function of the brake systems of both the vehicle and the trailer.

- ▶ Make sure that the automatic transmission is set to position **P**.
- ▶ Apply the vehicle's electric parking brake.
- ▶ Start the engine.
- ▶ **Vehicles with the AIRMATIC package:** select highway level.
- ▶ **Vehicles with ADS:** set ADS to **AUTO** or **COMF**.
- ▶ Switch off the engine.
- ▶ Close all doors and the tailgate.
- ▶ Couple up the trailer.
- ▶ Establish all electrical connections.
- ▶ Check that the trailer lighting system is working.

i Vehicles with the AIRMATIC package: with a trailer attached, the vehicle will always remain at highway level. When coupling up a trailer, please observe the following:

- Unless highway level has been set manually, the vehicle is automatically lowered to highway level. This is the case if a speed of 5 mph (8 km/h) is reached.
- High-speed level is not available.

These restrictions apply to all accessories powered through a connection to the trailer power socket of your vehicle, e.g. a bicycle carrier.

Observe the maximum permissible trailer dimensions (width and length).

Most U.S. states and all Canadian provinces require by law:

- Safety chains between the towing vehicle and the trailer. The chains should be cross-wound under the trailer drawbar. They must be fastened to the vehicle's trailer coupling, not to the bumper or the axle.

Leave enough play in the chains to make tight cornering possible.

- A separate brake system for certain types of trailer.
- A safety switch for braked trailers. Check the specific legal requirements applicable to your state.

If the trailer detaches from the towing vehicle, the safety switch applies the trailer's brakes.

Towing a trailer

There are numerous legal requirements concerning the towing of a trailer, e.g. speed restrictions. Make sure that your car/trailer combination complies with the local regulations:

- in your place of residence
- in the location to which you are driving

The police and local authorities can provide reliable information.

Observe the following when towing a trailer:

- To gain driving experience and to become accustomed to the new handling characteristics, you should practice the following in a traffic-free location:
 - cornering
 - stopping
 - backing up
- Before driving, check:
 - trailer tow hitch
 - safety switch for braked trailers
 - safety chains
 - electrical connections
 - lights
 - wheels
- Adjust the exterior mirrors to provide an unobstructed view of the rear section of the trailer.
- If the trailer has electronically controlled brakes, pull away carefully. Brake manually

using the brake controller and check whether the brakes function correctly.

- Secure any objects on the trailer to prevent the cargo from slipping when the vehicle is in motion.
- When you couple up a trailer, check at regular intervals that the load is firmly secured. If the trailer is equipped with trailer lights and brakes, check the trailer to ensure that these are working.
- Bear in mind that the handling will be less stable when towing a trailer than when driving without one. Avoid sudden steering movements.
- The vehicle/trailer combination is heavier, accelerates more slowly, has a decreased gradient climbing capability and a longer braking distance.

It is more susceptible to side winds and requires more careful steering.

- If possible, do not brake suddenly, but instead depress the brake pedal moderately at first so that the trailer can activate its brakes. Then increase the pressure on the brake pedal.
- If the automatic transmission repeatedly shifts between gears on uphill or downhill gradients, shift to a lower gear using the left-hand steering wheel paddle shifter. A lower gear and lower speed reduce the risk of engine failure.
- When driving downhill, shift to a lower gear to utilize the engine's braking effect.

Avoid continuous brake application as this may overheat the vehicle brakes and, if installed, the trailer brakes.

- If the coolant temperature increases dramatically while the air-conditioning system is switched on, switch off the air-conditioning system.

Coolant heat can also be dissipated by opening the windows and switching the

ventilation blower and the interior temperature to the highest level.

- When overtaking, pay particular attention to the extended length of your vehicle/trailer combination.

Due to the length of the vehicle/trailer combination, you require additional road space in relation to the vehicle you are overtaking before you can change back to the original lane.

Decoupling a trailer

WARNING

If you uncouple a trailer with the overrun brake engaged, you could trap your hand between the vehicle and the trailer drawbar. There is a risk of injury.

Do not uncouple a trailer if the overrun brake is engaged.

WARNING

Vehicles with level control:

The vehicle is lowered as soon as you disconnect the trailer cable. This could result in your limbs or those of other people that are between the vehicle body and tires or underneath the vehicle being trapped. There is a risk of injury.

Make sure that nobody is in the immediate vicinity of the wheel housings or under the vehicle when you disconnect the trailer cable.

- ❗ Do not disconnect a trailer with an engaged overrun brake. Otherwise, your vehicle could be damaged by the rebounding of the overrun brake.
- ▶ Make sure that the automatic transmission is set to position **P**.
- ▶ Apply the vehicle's electric parking brake.
- ▶ Start the engine.
- ▶ Close all doors and the tailgate.
- ▶ Apply the trailer's parking brake.

- ▶ Detach the trailer cable and decouple the trailer.
- ▶ Switch off the engine.

Permissible trailer loads and drawbar loads

Weight specifications

Maximum permissible gross vehicle weight rating

The gross trailer weight is calculated by adding the weight of the trailer to the weight of the load and equipment on the trailer.

You will find installing dimensions and loads under "Technical data" (▷ page 459).

Permissible noseweight

You will find installing dimensions and loads under "Technical data" (▷ page 459).

Loading a trailer

- When loading the trailer, make sure that neither the permissible gross weight of the trailer nor the gross vehicle weight is exceeded. The permissible gross vehicle weight is indicated on the identification plate on the B-pillar on the driver's side of the vehicle.

You can find the maximum permissible values on the type plates of your vehicle and the trailer. When calculating how much weight the vehicle and trailer may carry, pay attention to the respective lowest values.

- The trailer drawbar load on the ball coupling must be added to the rear axle load to avoid exceeding the permissible gross axle weight. The permissible gross vehicle weight is indicated on the identification plate on the B-pillar on the driver's side of the vehicle.

- i** Mercedes-Benz recommends a trailer load where the trailer drawbar noseweight

accounts for 8% to 15% of the trailer's permissible gross weight.

- i** The weight of additional accessories, passengers, and cargo reduces the permissible trailer load and drawbar load for your vehicle.

Checking the vehicle and trailer weight

- To check that the weights of the towing vehicle and the trailer comply with the maximum permissible values, have the vehicle/trailer combination (including the driver, passengers, and cargo with a fully laden trailer) weighed on a calibrated weigh-bridge.
- Check the gross axle weight rating of the front and rear axles, the gross weight of the trailer and trailer drawbar load.

Removing the ball coupling

- ▶ Remove the spring cotter.
- ▶ Remove the bolt from the ball coupling recess.
- ▶ Remove the ball coupling from the ball coupling recess.
- ▶ Clean the ball coupling if it is dirty.
- ▶ Stow the ball coupling so that it cannot be thrown around.

Observe the loading guidelines (▷ page 334) and the safety notes regarding stowage spaces (▷ page 335).

Information on cleaning and care of the trailer tow hitch can be found at (▷ page 376).

Storing the ball coupling

WARNING

Do not carry the ball coupling in the vehicle interior if it is not secured.

Otherwise, you and others could be injured by the ball coupling being thrown around if you:

- brake sharply
- change direction suddenly
- are involved in an accident

Trailer power supply

! You can connect accessories with a maximum power consumption of 240 W to the permanent power supply.

You must not charge a trailer battery using the power supply.

The trailer socket of your vehicle is equipped at the factory with a permanent power supply.

The permanent power supply is supplied via trailer socket pin 4.

The trailer's permanent power supply is switched off in the event of low vehicle supply voltage and after six hours at the latest.

A qualified specialist workshop can provide more information about installing the trailer electrics.

Useful information	266
Important safety notes	266
Displays and operation	266
Menus and submenus	269
Display messages	284
Warning and indicator lamps in the instrument cluster	318

Useful information

- i** This Operator's Manual describes all models and all standard and optional equipment of your vehicle available at the time of publication of the Operator's Manual. Country-specific differences are possible. Please note that your vehicle may not be equipped with all features described. This also applies to safety-related systems and functions.
- i** Read the information on qualified specialist workshops (▷ page 29).

Important safety notes

WARNING

If you operate information systems and communication equipment integrated in the vehicle while driving, you will be distracted from traffic conditions. You could also lose control of the vehicle. There is a risk of an accident. Only operate the equipment when the traffic situation permits. If you are not sure that this is possible, park the vehicle paying attention to traffic conditions and operate the equipment when the vehicle is stationary.

WARNING

If the instrument cluster has failed or malfunctioned, you may not recognize function restrictions in systems relevant to safety. The operating safety of your vehicle may be impaired. There is a risk of an accident.

Drive on carefully. Have the vehicle checked at a qualified specialist workshop immediately.

You must observe the legal requirements for the country in which you are currently driving when operating the on-board computer.

The on-board computer only shows messages or warnings from certain systems in the multifunction display. You should therefore make sure your vehicle is operating safely at all

times. Otherwise, a vehicle that is not operating safely may cause an accident.

For an overview, see the instrument panel illustration (▷ page 35).



Displays and operation

Instrument cluster lighting

The lighting in the instrument cluster, in the displays and the controls in the vehicle interior can be adjusted using the brightness control knob.

The brightness control knob is located on the bottom left of the instrument cluster (▷ page 35).

- ▶ Turn the brightness control knob clockwise or counter-clockwise.

If the light switch is set to ,  or , the brightness is dependent upon the brightness of the ambient light.

- i** The light sensor in the instrument cluster automatically controls the brightness of the multifunction display.

In daylight, the displays in the instrument cluster are not illuminated.

Coolant temperature display

WARNING

Opening the hood when the engine is overheated or when there is a fire in the engine compartment could expose you to hot gases or other service products. There is a risk of injury.

Let an overheated engine cool down before opening the hood. If there is a fire in the engine compartment, keep the hood closed and contact the fire department.

- !** A display message is shown if the coolant temperature is too high.

If the coolant temperature is over 248 °F (120 °C), do not continue driving. The engine will otherwise be damaged.

The coolant temperature gauge is in the instrument cluster on the right-hand side (▷ page 35).

Under normal operating conditions and with the specified coolant level, the coolant temperature may rise to 248 °F (120 °C).

Tachometer

! Do not drive in the overrevving range, as this could damage the engine.

The red band in the tachometer indicates the engine's overrevving range.

The fuel supply is interrupted to protect the engine when the red band is reached.

Outside temperature display

You should pay special attention to road conditions when temperatures are around freezing point.

Bear in mind that the outside temperature display indicates the temperature measured and does not record the road temperature.

The outside temperature display is in the multifunction display (▷ page 268).

Changes in the outside temperature are displayed after a short delay.

Speedometer with segments

The segments in the speedometer indicate which speed range is available.

- Cruise control activated (▷ page 195):
The segments light up from the stored speed to the maximum speed.
- DISTRONIC PLUS activated (▷ page 198):
One or two segments in the set speed range light up.
- DISTRONIC PLUS detects a vehicle in front:
The segments between the speed of the vehicle in front and the stored speed light up.

Operating the on-board computer

Overview







- ① Multifunction display
- ② Switches on the Voice Control System; see the separate operating instructions
- ③ Right control panel
- ④ Left control panel
- ⑤ Back button



► **To activate the on-board computer:** turn the SmartKey to position **1** in the ignition lock.



You can control the multifunction display and the settings in the on-board computer using the buttons on the multifunction steering wheel.

Left control panel



	<ul style="list-style-type: none"> • Calls up the menu and menu bar
	<p>Press briefly:</p> <ul style="list-style-type: none"> • Scrolls in lists • Selects a submenu or function • In the Audio menu: selects a stored station, an audio track or a video scene • In the Tel (telephone) menu: switches to the phone book and selects a name or telephone number
	<p>Press and hold:</p> <ul style="list-style-type: none"> • In the Audio menu: selects the previous/next station or selects an audio track or a video scene using rapid scrolling • In the Tel (Telephone) menu: starts rapid scrolling if the phone book is open
	<p>Press and hold:</p> <ul style="list-style-type: none"> • In the Audio menu: selects the previous/next station or selects an audio track or a video scene using rapid scrolling • In the Tel (Telephone) menu: starts rapid scrolling if the phone book is open
	<ul style="list-style-type: none"> • Confirms a selection/display message • In the Tel (telephone) menu: switches to the telephone book and starts dialing the selected number • In the Audio menu: stops the station search function at the desired station

Right control panel

	<ul style="list-style-type: none"> • Rejects or ends a call • Exits phone book/redial memory
	<ul style="list-style-type: none"> • Makes or accepts a call • Switches to the redial memory

	• Adjusts the volume
	
	• Mute

Back button

	<p>Press briefly:</p> <ul style="list-style-type: none"> • Back • Switches off the Voice Control System; see the separate operating instructions • Hides display messages/calls up the last Trip menu function used • Exits the telephone book/redial memory
	<p>Press and hold:</p> <ul style="list-style-type: none"> • Calls up the standard display in the Trip menu

Multifunction display

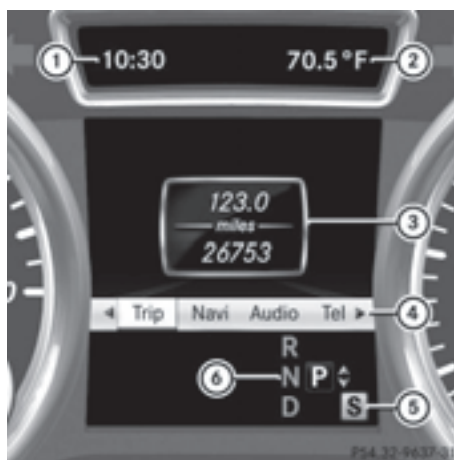

- ① Time
- ② Permanent display: outside temperature or speed (> page 277)
- ③ Text field
- ④ Menu bar

- ⑤ Drive program (▷ page 168)
- ⑥ Transmission position (▷ page 168)
- ▶ **To show menu bar** ④: press the ◀ or ▶ button on the steering wheel.

Menu bar ④ disappears after a few seconds. Text field ③ shows the selected menu or submenu as well as display messages.

i You can set the time using the audio system or COMAND; see the separate operating instructions.

The following messages may appear in the multifunction display:

- ⬆ Gearshift recommendation, when shifting manually (▷ page 173)
- ◀ **P** ▶ Active Parking Assist (▷ page 220)
- CRUISE** Cruise control (▷ page 195)
- LOW RANGE** LOW RANGE off-road gear (▷ page 253)
-  Adaptive Highbeam Assist (▷ page 126)
- ECO** ECO start/stop function (▷ page 162)
- HOLD** HOLD function (▷ page 210)

Menus and submenus

Menu overview

Press the ◀ or ▶ button on the steering wheel to call up the menu bar and select a menu.

Operating the on-board computer (▷ page 267).

Depending on the equipment installed in the vehicle, you can call up the following menus:

- **Trip** menu (▷ page 269)
- **Navi** menu (navigation instructions) (▷ page 271)
- **Audio** menu (▷ page 272)
- **Tel** menu (telephone) (▷ page 273)

- **DriveAssist** menu (assistance) (▷ page 275)
- **Serv** menu (▷ page 276)
- **Sett** menu (settings) (▷ page 277)
- **ON&OFFROAD** menu (▷ page 281)
- **AMG** menu in AMG vehicles (▷ page 281)

Trip menu

Standard display



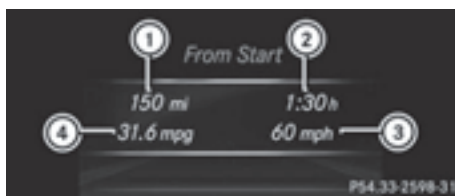

- ▶ Press and hold the  button on the steering wheel until the **Trip** menu with trip odometer ① and odometer ② is shown.

Trip computer "From Start" or "From Reset"



Example: trip computer "From Start"

- ① Distance
- ② Time
- ③ Average speed
- ④ Average fuel consumption
- ▶ Press the ◀ or ▶ button on the steering wheel to select the **Trip** menu.
- ▶ Press  or  to select **From Start** or **From Reset**.

The values in the **From Start** submenu are calculated from the start of a journey, while the values in the **From Reset** submenu are

calculated from the last time the submenu was reset (▷ page 270).

The **From Start** trip computer is automatically reset when:

- the ignition has been switched off for more than four hours.
- 999 hours have been exceeded.
- 9,999 miles have been exceeded.

The **From Reset** trip computer is automatically reset if the value exceeds 9,999 hours or 99,999 miles.

ECO display



Example: ECO display

The ECO display is not available for AMG vehicles.

- ▶ Press the or button on the steering wheel to select the **Trip** menu.
- ▶ Select **ECO DISPLAY** with or .

If the ignition remains switched off for longer than four hours, the ECO display will be automatically reset.

For further information on the ECO display, see (▷ page 187).

Displaying the range and current fuel consumption

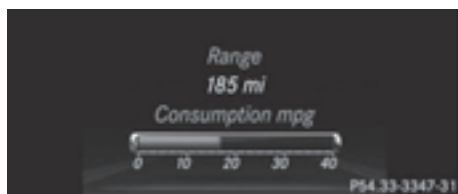

- ▶ Press the or button on the steering wheel to select the **Trip** menu.
- ▶ Press the or button to select the approximate range and the current fuel consumption (not for AMG vehicles).

The approximate range that can be covered depends on the fuel level and your current driving style. If there is only a small amount of fuel left in the fuel tank, the display shows a vehicle being refueled instead of the range.

Digital speedometer



- ① Shift recommendation (▷ page 173)
- ② Digital speedometer

Gearshift recommendation ① is not given on AMG vehicles.

- ▶ Press the or button on the steering wheel to select the **Trip** menu.
- ▶ Press the or button to select the digital speedometer.

Resetting values

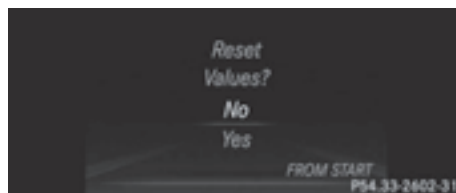

Example: resetting the trip computer "From Start"

- ▶ Press the or button on the steering wheel to select the **Trip** menu.
- ▶ Press the or button to select the function that you wish to reset.

- ▶ Press the button.
- ▶ Press the button to select **Yes** and press the button to confirm.

You can reset the values of the following functions:

- Trip odometer
- "From Start" trip computer
- "From Reset" trip computer
- ECO display

- i** If you reset the values in the ECO display, the values in the "From start" trip computer are also reset. If you reset the values in the "From start" trip computer, the values in the ECO display are also reset.

Navigation system menu

Displaying navigation instructions

In the **Navi** menu, the multifunction display shows navigation instructions.

For more information, see the separate operating instructions.

- ▶ Switch on the audio system with Becker® MAP PILOT or COMAND; see the separate operating instructions.
- ▶ Press the or button on the steering wheel to select the **Navi** menu.

Route guidance not active



- ① Direction of travel
- ② Current road

Route guidance active

No change of direction announced



- ① Distance to the destination
- ② Distance to the next change of direction
- ③ Current road
- ④ "Follow the road's course" symbol

Change of direction announced without a lane recommendation



- ① Road into which the change of direction leads
- ② Distance to change of direction and visual distance display
- ③ Change-of-direction symbol

When a change of direction is announced, you will see symbol ③ for the change of direction and distance graphic ②. The distance indicator shortens towards the top of the display as you approach the point of the announced change of direction.

Change of direction announced with a lane recommendation



- ① Road into which the change of direction leads
- ② Distance to change of direction and visual distance display
- ③ Recommended lane and new lane during a change of direction
- ④ Lanes not recommended
- ⑤ Recommended lane
- ⑥ Change-of-direction symbol

On multilane roads, new lane recommendations can be displayed for the next change of direction if the digital map supports this data. During the change of direction, new lanes may be added.

Recommended lane and new lane during a change of direction ③: in this lane you will be able to complete the next two changes of direction without changing lane.

Lane not recommended ④: you will not be able to complete the next change of direction if you stay in this lane.

Recommended lane ⑤: in this lane you will only be able to complete the next change of direction without changing lane.

Other status indicators of the navigation system







- : you have reached the destination or an intermediate destination.
- **New Route...** or **Calculating Route:** calculating a new route.
- **Off Map** or **Off Mapped Road:** the vehicle position is outside the area of the digital map (off-map position).
- **No Route:** no route could be calculated to the selected destination.

Audio menu



Selecting a radio station



- ① Waveband
 - ② Station frequency with memory position
- i** Station ② is displayed with the station frequency or station name. The memory position is only displayed along with station ② if this has been stored.

- ▶ Switch on COMAND and select Radio; see the separate operating instructions.
- ▶ Press the  or  button on the steering wheel to select the **Audio** menu.
- ▶ **To select a stored station:** briefly press the  or  button.
- ▶ **To select a station from the station list:** press and briefly hold the  or  button.

If no station list is received:

- ▶ **To select a station using the station search:** press and briefly hold the  or  button.

i For information on switching waveband and storing stations; see the separate operating instructions.

i SIRIUS XM satellite radio functions like a normal radio.

For more information on satellite radio operation, see the separate operating instructions.

Operating an audio player or audio media



Audio data from various audio devices or media can be played, depending on the equipment installed in the vehicle.

- ▶ Switch on COMAND Online and select audio CD or MP3 mode, see the separate operating instructions.
- ▶ Press the ◀ or ▶ button on the steering wheel to select the **Audio** menu.
- ▶ **To select the next/previous track:** briefly press the ▲ or ▼ button.
- ▶ **To select a track from the track list (rapid scrolling):** press and hold the ▲ or ▼ button until the desired track has been reached ①.

If you press and hold ▲ or ▼, the rapid scrolling speed is increased. Not all audio drives or data carriers support this function.

If track information is stored on the audio device or medium, the multifunction display will show the number and title of the track. The current track does not appear in audio AUX mode (**A**uxiliary audio mode: external audio source connected).

Video DVD operation

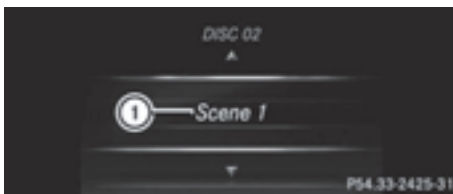

Example: CD/DVD changer display

- ▶ Switch on COMAND and select video DVD; see the separate operating instructions.
- ▶ Press the ◀ or ▶ button on the steering wheel to select the **Audio** menu.
- ▶ **To select the next/previous scene:** briefly press the ▲ or ▼ button.
- ▶ **To select a scene from the scene list (rapid scrolling):** press and hold the ▲ or ▼ button until desired scene ① has been reached.

Telephone menu

Introduction

WARNING

If you operate information systems and communication equipment integrated in the vehicle while driving, you will be distracted from traffic conditions. You could also lose control of the vehicle. There is a risk of an accident.

Only operate the equipment when the traffic situation permits. If you are not sure that this is possible, park the vehicle paying attention to traffic conditions and operate the equipment when the vehicle is stationary.

When telephoning, you must observe the legal requirements for the country in which you are currently driving.

- ▶ Switch on the mobile phone (see the separate operating instructions).
- ▶ Switch on COMAND (see the separate operating instructions).
- ▶ Establish a Bluetooth® connection to COMAND; see the separate operating instructions.
- ▶ Press the ◀ or ▶ button on the steering wheel to select the **Te1** menu.

You will see one of the following display messages in the multifunction display:

- ▶ **Phone READY** or the name of the network provider: the mobile phone has found a network and is ready to receive.
- ▶ **Phone No Service**: there is no network available or the mobile phone is searching for a network.

Accepting a call

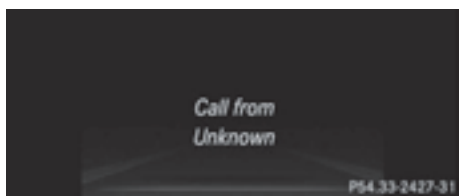

Example: incoming call

If someone calls you when you are in the **Te1** menu, a display message appears in the multifunction display.

- ▶ Press the  button on the steering wheel to accept an incoming call.





You can accept a call even if you are not in the **Te1** menu.

Rejecting or ending a call

- ▶ Press the  button on the steering wheel.





You can end or reject a call even if you are not in the **Te1** menu.

Dialing a number from the phone book







- ▶ Press the  or  button on the steering wheel to select the **Te1** menu.
- ▶ Press the ,  or  button to switch to the phone book.

- ▶ Press the  or  button to select the desired name.



or

- ▶ **To begin rapid scrolling:** press and hold the  or  button for longer than one second. Rapid scrolling stops when you release the button or reach the end of the list.
- ▶ **If only one telephone number is stored for a name:** press the  or  button to start dialing.

or







- ▶ **If there is more than one number for a particular name:** press the  or  button to display the numbers.
- ▶ Press the  or  button to select the number you want to dial.
- ▶ Press the  or  button to start dialing.

or

- ▶ **To exit the telephone book:** press the  or  button.

Redialing

The on-board computer saves the last names or numbers dialed in the redial memory.

- ▶ Press the  or  button on the steering wheel to select the **Te1** menu.
- ▶ Press the  button to switch to the redial memory.
- ▶ Press the  or  button to select the desired name or number.
- ▶ Press the  or  button to start dialing.

or

- ▶ **To exit the redial memory:** press the  or  button.

Assistance menu

Introduction



In the **DriveAssist** menu, you have the following options:

- Displaying the assistance graphic (▷ page 275)
- Activating/deactivating the distance warning function (▷ page 275)
- Activating/deactivating PRE-SAFE® Brake (▷ page 276)
- Activating/deactivating ATTENTION ASSIST (▷ page 276)
- Activating/deactivating Blind Spot Assist or Active Blind Spot Assist (▷ page 276)
- Activating/deactivating Lane Keeping Assist or Active Lane Keeping Assist (▷ page 276)

Displaying the assistance graphic



- ▶ Press the or button on the steering wheel to select the **DriveAssist** menu.
- ▶ Press or to select **Assistance Graphic**.
- ▶ Press the button.
The multifunction display shows the DISTRONIC PLUS distance display in the assistance graphic.

The assistance graphic displays the status of and information from the following driving systems or driving safety systems:

- ATTENTION ASSIST (▷ page 233)
- DISTRONIC PLUS (▷ page 205)
- Lane Keeping Assist (▷ page 239) or Active Lane Keeping Assist (▷ page 244)
- Distance warning function (▷ page 70)
- PRE-SAFE® Brake (▷ page 75)
- DSR (▷ page 250)
- Off-road program (vehicles with the ON&OFFROAD package) (▷ page 251)







Activating/deactivating the distance warning function

- ▶ Press the or button on the steering wheel to select the **DriveAssist** menu.
- ▶ Press or to select **Distance Warning**.
- ▶ Press the button.
The current selection is displayed.
- ▶ **To activate/deactivate:** press the button again.
When the distance warning function is deactivated, the assistance graphic shows the symbol in the multifunction display.

Further information on the distance warning function (▷ page 70).







Activating/deactivating PRE-SAFE® Brake

PRE-SAFE® Brake is only available in vehicles with DISTRONIC PLUS.

- ▶ Press  or  on the steering wheel to select the **DriveAssist** menu.
- ▶ Press the  or  button to select **PRE-SAFE Brake**.
- ▶ Press the  button.
The current selection is displayed.
- ▶ **To activate/deactivate:** press the  button again.
When PRE-SAFE® Brake is deactivated, the assistance graphic shows the  symbol in the multifunction display.





For more information on PRE-SAFE® Brake, see (▷ page 75).



Activating/deactivating ATTENTION ASSIST

- ▶ Press the  or  button on the steering wheel to select the **DriveAssist** menu.
- ▶ Press the  or  button to select **ATTENTION ASSIST**.
- ▶ Press the  button.
The current selection is displayed.
- ▶ **To activate/deactivate:** press the  button again.
When ATTENTION ASSIST is deactivated, the  symbol appears in the multifunction display in the assistance graphics display.

For further information about ATTENTION ASSIST, see (▷ page 233).









Activating/deactivating Blind Spot Assist

- ▶ Press  or  on the steering wheel to select the **DriveAssist** menu.
- ▶ Press the  or  button to select **Blind Spot Assist**.

- ▶ Press the  button.
The current selection is displayed.
- ▶ **To activate/deactivate:** press the  button again.

For further information about Active Blind Spot Assist, see (▷ page 241).

Activating/deactivating Lane Keeping Assist

- ▶ Press  or  on the steering wheel to select the **DriveAssist** menu.
- ▶ Press  or  to select **Lane Keeping Assist**.
- ▶ Press the  button.
The current selection is displayed.
- ▶ Press  to confirm.
- ▶ Press the  or  button to set **Off**, **Standard** or **Adaptive**.
When Lane Keeping Assist or Active Lane Keeping Assist is activated, the multifunction display shows the lane markings as bright lines in the assistance graphic.
- ▶ Press the  button to save the setting.

For further information about Lane Keeping Assist, see (▷ page 239).

For further information about Active Lane Keeping Assist, see (▷ page 244).

Maintenance menu



In the **Serv** menu, you have the following options:

- Calling up display messages in message memory (▷ page 284)
- Restarting the tire pressure loss warning system (▷ page 408)

- Checking the tire pressure electronically (▷ page 408)
- Calling up the service due date (▷ page 371)

Settings menu

Introduction



In the **Sett.** menu, you have the following options:

- Changing the instrument cluster settings (▷ page 277)
- Changing the light settings (▷ page 277)
- Changing the vehicle settings (▷ page 279)
- Changing the convenience settings (▷ page 279)
- Restoring the factory settings (▷ page 281)

Instrument cluster submenu

Selecting the unit of measurement for distance

The **Display Unit Speed-/Odometer:** function allows you to choose whether certain displays appear in kilometers or miles in the multifunction display.

- ▶ Press the or button on the steering wheel to select the **Settings** menu.
- ▶ Press the or button to select the **Instrument Cluster** submenu.
- ▶ Press to confirm.

- ▶ Press the or button to select the **Display Unit Speed-/Odometer** function.

You will see the selected setting: **km** or **miles**.

- ▶ Press the button to save the setting.

The selected unit of measurement for distance applies to:

- Digital speedometer in the **Trip** menu
- Odometer and the trip odometer
- Trip computer
- Current consumption and the range
- Navigation messages in the **Navi** menu
- Cruise control
- DISTRONIC PLUS
- ASSYST PLUS service interval display

Selecting the permanent display function

You can determine whether the multifunction display permanently shows your speed or the outside temperature.

- ▶ Press the or button on the steering wheel to select the **Sett** menu.
- ▶ Press the or button to select the **Instrument Cluster** submenu.
- ▶ Press to confirm.
- ▶ Press the or button to select the **Permanent Display:** function. You will see the selected setting **Outside Temperature** or **Speedometer [mph]/Speedometer [km/h]**.
- ▶ Press the button to save the setting.

- i** The speed is highlighted in km/h or in mph conversely to your speedometer.

Light submenu

Setting the daytime running lamps

- i** This function is not available in Canada.
- ▶ Press the or button on the steering wheel to select the **Sett.** menu.
- ▶ Press the or button to select the **Light** submenu.

- ▶ Press **OK** to confirm.
- ▶ Press **▼** or **▲** to select the **Daytime Running Lights** function.
If the **Daytime Running Lights** function has been switched on, the cone of light and the **☼** symbol in the multifunction display are shown in orange.
- ▶ Press the **OK** button to save the setting.

Further information on daytime running lamps (▷ page 120).

Setting the brightness of the ambient lighting

- ▶ Press the **◀** or **▶** button on the steering wheel to select the **Sett.** menu.
- ▶ Press the **▼** or **▲** button to select the **Light** submenu.
- ▶ Press **OK** to confirm.
- ▶ Press the **▼** or **▲** button to select the **Amb. Light +/-** function.
You will see the selected setting.
- ▶ Press **OK** to confirm.
- ▶ Press the **▼** or **▲** button to adjust the brightness to any level from **Off** to **Level 5** (bright).
- ▶ Press the **OK** or **↩** button to save the setting.

Setting the ambient lighting color

- ▶ Press the **◀** or **▶** button on the steering wheel to select the **Sett.** menu.
- ▶ Press the **▼** or **▲** button to select the **Lights** submenu.
- ▶ Press **OK** to confirm.
- ▶ Press the **▼** or **▲** button to select the **Ambient Light Color** function.
- ▶ Press **OK** to confirm.
- ▶ Press the **▼** or **▲** button to set the color to **SOLAR**, **NEUTRAL** or **POLAR**.
- ▶ Press the **OK** or **↩** button to save the setting.

Surround lighting and exterior lighting delayed switch-off

- ▶ Press the **◀** or **▶** button on the steering wheel to select the **Sett.** menu.
- ▶ Press the **▼** or **▲** button to select the **Lights** submenu.
- ▶ Press **OK** to confirm.
- ▶ Press **▼** or **▲** to select the **Surround Lighting** function.
When the **Surround Lighting** function is activated, the light cone and the area around the vehicle are displayed in orange in the multifunction display.
- ▶ Press the **OK** button to save the setting.

Deactivating delayed switch-off of the exterior lighting temporarily:

- ▶ Before leaving the vehicle, turn the SmartKey to position **0** in the ignition lock.
- ▶ Turn the SmartKey to position **2** in the ignition lock.
The exterior lighting delayed switch-off is deactivated.

Delayed switch-off of the exterior lighting is reactivated the next time you start the engine.

If you have activated the **Surround Lighting** function and the light switch is set to **AUTO**, the following functions are activated when it is dark:







- **surround lighting:** the exterior lighting remains lit for 40 seconds after unlocking with the SmartKey. If you start the engine, the surround lighting is switched off and automatic headlamp mode is activated (▷ page 120).
- **exterior lighting delayed switch-off:** the exterior lighting remains lit for 60 seconds after the engine is switched off. If you close all the doors and the tailgate, the exterior lighting goes off after 5 seconds.

i Depending on your vehicle's equipment, when the surround lighting and delayed switch-off exterior lighting are on, the following light up:

- Parking lamps
- Daytime running lamps
- Side marker lamps
- Surround lighting in the exterior mirrors

Activating/deactivating the interior lighting delayed switch-off







If you activate the **Interior Lighting Delay** function, the interior lighting remains on for 20 seconds after you remove the SmartKey from the ignition lock.

- ▶ Press the  or  button on the steering wheel to select the **Sett.** menu.
- ▶ Press the  or  button to select the **Light** submenu.
- ▶ Press **OK** to confirm.
- ▶ Press the  or  button to select the **Interior Lighting Delay** function.
If the **Interior Lighting Delay** function has been switched on, the vehicle interior is displayed in orange in the multifunction display.
- ▶ Press the **OK** button to save the setting.

Vehicle submenu

Activating/deactivating the automatic door locking mechanism







If you activate the **Automatic Door Lock** function, the vehicle is centrally locked above a speed of approximately 9 mph (15 km/h).

- ▶ Press the  or  button on the steering wheel to select the **Sett.** menu.
- ▶ Press the  or  button to select the **Vehicle** submenu.
- ▶ Press **OK** to confirm.
- ▶ Press the  or  button to select the **Automatic Door Lock** function.
When the **Automatic Door Lock** function is activated, the vehicle doors are displayed in orange in the multifunction display.
- ▶ Press the **OK** button to save the setting.







For further information on the automatic locking feature, see (▷ page 88).

Activating/deactivating the acoustic locking verification signal

If you switch on the **Acoustic Lock** function, an acoustic signal sounds when you lock the vehicle.

- ▶ Press the  or  button on the steering wheel to select the **Sett.** menu.
- ▶ Press  or  to select the **Vehicle** submenu.
- ▶ Press **OK** to confirm.
- ▶ Press the  or  button to select the **Acoustic Lock** function.
If the **Acoustic Lock** function is activated, the  symbol in the multifunction display lights up orange.
- ▶ Press the **OK** button to save the setting.

Activating/deactivating the radar sensor system

- ▶ Press the  or  button on the steering wheel to select the **Sett.** menu.
- ▶ Press  or  to select the **Vehicle** submenu.
- ▶ Press **OK** to confirm.
- ▶ Press the  or  button to select **Radar Sensor (See Oper. Manual)**:
You will see the selected setting: **Enabled** or **Disabled**.
- ▶ Press the **OK** button to save the setting.

The following systems are switched off when the radar sensor system is deactivated:

- DISTRONIC PLUS (▷ page 198)
- BAS PLUS (▷ page 69)
- PRE-SAFE® Brake (▷ page 75)
- Blind Spot Assist (▷ page 237)
- Active Blind Spot Assist (▷ page 241)

Convenience submenu

Activating/deactivating the EASY-ENTRY/EXIT feature

WARNING

When the EASY-ENTRY/EXIT feature adjusts the steering wheel, you and other vehicle

occupants – particularly children – could become trapped. There is a risk of injury.

While the EASY-ENTRY/EXIT feature is making adjustments, make sure that no one has any body parts in the sweep of the steering wheel.

If somebody becomes trapped:

- press one of the memory function position buttons, or
- move the switch for steering wheel adjustment in the opposite direction to that in which the steering wheel is moving.

The adjustment process is stopped.

- ▶ Press the ◀ or ▶ button on the steering wheel to select the **Sett.** menu.
- ▶ Press the ▼ or ▲ button to select the **Convenience** submenu.
- ▶ Press **OK** to confirm.
- ▶ Press the ▼ or ▲ button to select the **Easy Entry/Exit:** function.
If the **Easy Entry/Exit** function is activated, the vehicle steering wheel is displayed in orange in the multifunction display.
- ▶ Press the **OK** button to save the setting.

Further information on the EASY-ENTRY/EXIT feature (▷ page 113).

Switching the belt adjustment on/off

- ▶ Press the ◀ or ▶ button on the steering wheel to select the **Sett.** menu.
- ▶ Press the ▼ or ▲ button to select the **Convenience** submenu.
- ▶ Press **OK** to confirm.
- ▶ Press the ▼ or ▲ button to select the **Belt Adjustment** function.
If the **Belt Adjustment** function is activated, the vehicle seat belt is shown in orange in the multifunction display.
- ▶ Press the **OK** button to save the setting.

For further information on belt adjustment, see (▷ page 49).

Switching the fold-in mirrors when locking feature on/off

This function is only available on vehicles with the memory function (▷ page 116).

When you activate the **Auto. Mirror Folding** function, the exterior mirrors are folded in when the vehicle is locked. If you unlock the vehicle and then open a door, the exterior mirrors fold out again.

- ▶ Press the ◀ or ▶ button on the steering wheel to select the **Sett.** menu.
- ▶ Press the ▼ or ▲ button to select the **Convenience** submenu.
- ▶ Press **OK** to confirm.
- ▶ Press the ▼ or ▲ button to select the **Auto. Mirror Folding** function.
If the **Auto. Mirror Folding** function is activated, the vehicle's exterior mirror is displayed in orange in the multifunction display.
- ▶ Press the **OK** button to save the setting.



- ① To fold the exterior mirrors in or out

If you have switched the **Auto. Mirror Folding** on and you fold the exterior mirrors in using button ①, they will not fold out automatically (▷ page 115).

You can then only fold out the exterior mirrors using button ①.

Restoring the factory settings

- ▶ Press the or button on the steering wheel to select the **Sett.** menu.
- ▶ Press the or button to select the **Factory Setting** submenu.
- ▶ Press to confirm.
The **Reset All Settings?** message appears.
- ▶ Press the or button to select **No** or **Yes**.
- ▶ Press to confirm the selection.
If you select **Yes**, the multifunction display shows a confirmation message.

For safety reasons, the **Daytime Running Lights** function in the **Lights** submenu is only reset if the vehicle is stationary.

ON&OFFROAD menu



Example: multifunction display

- ▶ Press the or button on the steering wheel to select the **ON&OFFROAD** menu.
- You can set the current settings to appear in the **ON&OFFROAD** menu:
- On-road program (▷ page 247)
 - Off-road program (▷ page 251)

AMG menu in AMG vehicles

AMG displays

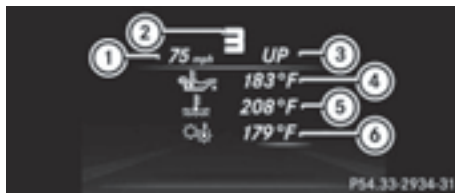

- ① Digital speedometer
 - ② Gear indicator
 - ③ Upshift indicator
 - ④ Engine oil temperature
 - ⑤ Coolant temperature
 - ⑥ Transmission fluid temperature
- ▶ Press or on the steering wheel to select the **AMG** menu.

Upshift indicator **UP** ③ indicates that the engine has reached the overrevving range when in the manual gearshift program.

Upshift indicator **UP** ③ fades out other messages until you have shifted up.

If the engine oil temperature is below 176 °F (80 °C), oil temperature ④ is shown in blue. Avoid driving at full engine output during this time.

If the transmission fluid temperature is below 122 °F (50 °C), oil temperature ⑥ is shown in blue. Avoid driving at full engine output during this time.

SETUP



- ① Drive program (**C/S/M**)
- ② ESP® mode (**ON/OFF**)
- ③ Suspension tuning (**COMFORT/SPORT/SPORT+**)

SETUP shows the drive program, the ESP® (Electronic Stability Program) mode and the suspension tuning.

- ▶ Press or on the steering wheel to select the **AMG** menu.
- ▶ Press the button repeatedly until SETUP is displayed.

RACETIMER

Displaying and starting RACETIMER

The RACETIMER is only intended for use on a closed race circuit. Do not use the function on public roads.



- ① Lap
- ② RACETIMER

You can start the RACETIMER when the engine is running or if the SmartKey is in position **2** in the ignition lock.

- ▶ Press or on the steering wheel to select the **AMG** menu.
- ▶ Press the button repeatedly until the RACETIMER is shown.
- ▶ **To start:** press the button to start the RACETIMER.

Displaying the intermediate time



- ▶ Press the or button to select **Interm. Time**.
- ▶ Press to confirm. The intermediate time is displayed for five seconds.

Starting a new lap



- ① RACETIMER
 - ② Fastest lap time (best lap)
 - ③ Lap
- ▶ Press to confirm **New Lap**.

i It is possible to store a maximum of sixteen laps. The 16th lap can only be completed with **Finish Lap**.

Stopping the RACETIMER

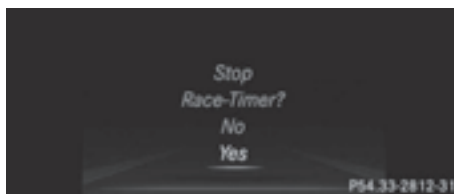

- ▶ Press the button on the steering wheel.
- ▶ Press to confirm **Yes**.

The RACETIMER interrupts timing when you stop the vehicle and turn the SmartKey to position **1** in the ignition lock. If you turn the SmartKey to position **2** or **3** and then press to confirm **Start**, timing is continued.

Resetting the current lap

- ▶ Stop the RACETIMER.
- ▶ Press the or button to select **Reset Lap**.
- ▶ Press to reset the lap time to "0".

Deleting all laps



If you switch off the engine, the RACETIMER is reset to "0" after 30 seconds. All laps are deleted.

You cannot delete individual stored laps. If you have stopped 16 laps, the current lap does not have to be reset.

- ▶ Reset the current lap.
- ▶ Press to confirm **Reset**. **Reset Race Timer?** appears in the multi-function display.
- ▶ Press the button to select **Yes** and press the button to confirm. All laps are deleted.

Overall statistics



- ① RACETIMER overall evaluation
- ② Total time driven
- ③ Average speed
- ④ Distance covered
- ⑤ Maximum speed

This function is shown if you have stored at least one lap and stopped the RACETIMER.

- ▶ Press or on the steering wheel to select the **AMG** menu.
- ▶ Press the button repeatedly until the overall evaluation is shown.

Lap statistics



- ① Lap
- ② Lap time
- ③ Average lap speed
- ④ Lap length
- ⑤ Top speed during lap

This function is only available if you have stored at least two laps and have stopped the RACETIMER.

- ▶ Press or on the steering wheel to select the **AMG** menu.
- ▶ Press the button repeatedly until the lap evaluation is shown. Each lap is shown in a separate submenu. The fastest lap is indicated by flashing symbol ①.
- ▶ Press the or button to select a different lap evaluation.

Display messages

Introduction

General notes

Display messages appear in the multifunction display.

Display messages with graphic displays may be shown in simplified form in the Operator's Manual and may differ from the messages shown in the multifunction display.



Please respond in accordance with the display messages and follow the additional notes in this Operator's Manual.

Certain display messages are accompanied by an audible warning tone or a continuous tone.

When you stop and park the vehicle, please observe the notes on:

- HOLD function (▷ page 210)
- Parking (▷ page 182)

Hiding display messages







- ▶ Press the  or  button on the steering wheel to hide the display message. The display message is cleared.

The multifunction display shows high-priority display messages in red. Some high-priority display messages cannot be hidden.

The multifunction display shows these messages continuously until the causes for the messages have been remedied.

Message memory

The on-board computer saves certain display messages in the **message memory**. You can call up the display messages:

- ▶ Press the  or  button on the steering wheel to select the **Serv.** menu. If there are display messages, the multifunction display shows **2 Messages**, for example.
- ▶ Press the  or  button to select the entry, e.g. **2 Messages**.
- ▶ Press  to confirm.
- ▶ Press the  or  button to scroll through the display messages.

When the ignition is switched off, all display messages are deleted, apart from some high-priority display messages. Once the causes of the high-priority display messages have been rectified, the corresponding display messages are also deleted.

Safety systems

Display messages



Currently Unavailable See Operator's Manual

Possible causes/consequences and ► Solutions

ABS (Anti-lock Braking System), ESP[®] (Electronic Stability Program), BAS (Brake Assist), PRE-SAFE[®], the HOLD function, hill start assist and ESP[®] trailer stabilization are temporarily unavailable.

COLLISION PREVENTION ASSIST, BAS PLUS and PRE-SAFE[®] Brake may also have failed.

In addition, the ,  and  warning lamps light up in the instrument cluster.

ATTENTION ASSIST is deactivated.

Possible causes are:

- Self-diagnosis is not yet complete.
- The on-board voltage may be insufficient.

 **WARNING**

The brake system continues to function normally, but without the functions listed above. The wheels could therefore lock if you brake hard, for example.

The steerability and braking characteristics may be severely affected. The braking distance in an emergency braking situation can increase.

If ESP[®] is not operational, ESP[®] is unable to stabilize the vehicle. There is an increased risk of skidding and an accident.

► Carefully drive a suitable distance, making slight steering movements at a speed above 12 mph (20 km/h).

If the display message disappears, the functions mentioned above are available again.





If the display message continues to be displayed:

- Drive on carefully.
- Visit a qualified specialist workshop.





Inoperative See Operator's Manual









ABS, ESP[®], BAS, PRE-SAFE[®], the HOLD function, hill start assist and ESP[®] trailer stabilization are unavailable due to a malfunction. COLLISION PREVENTION ASSIST, BAS PLUS and PRE-SAFE[®] Brake may also have failed.

The **BRAKE** (USA only) /  (Canada only), ,  and  warning lamps in the instrument cluster also light up.









ATTENTION ASSIST is deactivated.















 **WARNING**







Display messages	Possible causes/consequences and ► Solutions
	<p>The brake system continues to function normally, but without the functions listed above. The wheels could therefore lock if you brake hard, for example.</p> <p>The steerability and braking characteristics may be severely affected. The braking distance in an emergency braking situation can increase.</p> <p>If ESP® is not operational, ESP® is unable to stabilize the vehicle. There is an increased risk of skidding and an accident.</p> <ul style="list-style-type: none"> ► Drive on carefully. ► Visit a qualified specialist workshop immediately.
<div data-bbox="90 517 171 560" style="border: 1px solid black; padding: 2px; width: fit-content;">  </div> <p data-bbox="87 564 316 651">Currently Unavailable See Operator's Manual</p>	<p>ESP®, BAS, PRE-SAFE®, the HOLD function, hill start assist and ESP® trailer stabilization are unavailable due to a malfunction. COLLISION PREVENTION ASSIST, BAS PLUS and PRE-SAFE® Brake may also have failed.</p> <p>In addition, the  and  warning lamps light up in the instrument cluster.</p> <p>The self-diagnosis function might not be complete, for example. ATTENTION ASSIST is deactivated.</p> <p>⚠ WARNING</p> <p>The brake system continues to function normally, but without the functions listed above. The wheels could therefore lock if you brake hard, for example.</p> <p>The braking distance in an emergency braking situation can thus increase.</p> <p>If ESP® is not operational, ESP® is unable to stabilize the vehicle. There is an increased risk of skidding and an accident.</p> <ul style="list-style-type: none"> ► Carefully drive a suitable distance, making slight steering movements at a speed above 12 mph (20 km/h). If the display message disappears, the functions mentioned above are available again. <p>If the display message continues to be displayed:</p> <ul style="list-style-type: none"> ► Drive on carefully. ► Visit a qualified specialist workshop.

Display messages	Possible causes/consequences and ► Solutions
 <p data-bbox="116 229 331 284">Inoperative See Operator's Manual</p>	<p data-bbox="370 180 1014 304">ESP®, BAS, PRE-SAFE®, the HOLD function, hill start assist and ESP® trailer stabilization are unavailable due to a malfunction. COLLISION PREVENTION ASSIST, BAS PLUS and PRE-SAFE® Brake may also have failed.</p> <p data-bbox="370 316 988 370">In addition, the  and  warning lamps light up in the instrument cluster.</p> <p data-bbox="370 379 723 405">ATTENTION ASSIST is deactivated.</p> <p data-bbox="384 422 535 448">▲ WARNING</p> <p data-bbox="370 464 1031 549">The brake system continues to function normally, but without the functions listed above. The wheels could therefore lock if you brake hard, for example.</p> <p data-bbox="370 560 1031 614">The braking distance in an emergency braking situation can thus increase.</p> <p data-bbox="370 625 1031 679">If ESP® is not operational, ESP® is unable to stabilize the vehicle. There is an increased risk of skidding and an accident.</p> <ul data-bbox="370 695 764 756" style="list-style-type: none"> ► Drive on carefully. ► Visit a qualified specialist workshop.
   <p data-bbox="116 884 331 938">Inoperative See Operator's Manual</p>	<p data-bbox="370 786 1031 871">EBD (electronic brake force distribution), ABS, ESP®, BAS, PRE-SAFE®, the HOLD function, hill start assist and ESP® trailer stabilization are unavailable due to a malfunction.</p> <p data-bbox="370 882 869 936">COLLISION PREVENTION ASSIST, BAS PLUS and PRE-SAFE® Brake may also have failed.</p> <p data-bbox="370 948 1031 1002">In addition, the ,  and  warning lamps light up in the instrument cluster and a warning tone sounds.</p> <p data-bbox="370 1013 723 1038">ATTENTION ASSIST is deactivated.</p> <p data-bbox="384 1056 535 1082">▲ WARNING</p> <p data-bbox="370 1098 1031 1182">The brake system continues to function normally, but without the functions listed above. The wheels could therefore lock if you brake hard, for example.</p> <p data-bbox="370 1193 1031 1278">The steerability and braking characteristics may be severely affected. The braking distance in an emergency braking situation can increase.</p> <p data-bbox="370 1289 1031 1343">If ESP® is not operational, ESP® is unable to stabilize the vehicle. There is an increased risk of skidding and an accident.</p> <ul data-bbox="370 1359 897 1420" style="list-style-type: none"> ► Drive on carefully. ► Visit a qualified specialist workshop immediately.

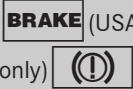

Display messages	Possible causes/consequences and ► Solutions
<p>PARK (USA only) (P) (Canada only)</p> <p>Please Release Parking Brake</p>	<p>The red PARK (USA only)/(P) (Canada only) indicator lamp flashes and a warning tone sounds. A condition for automatic release of the electric parking brake is not fulfilled (► page 184). You are driving with the electric parking brake applied.</p> <p>► Release the electric parking brake manually.</p> <p>The red PARK (USA only)/(P) (Canada only) indicator lamp flashes and a warning tone sounds. You are using the electric parking brake for emergency braking (► page 184).</p>
<p>PARK (USA only) (P) (Canada only)</p> <p>Parking Brake See Operator's Manual</p>	<p>The yellow (P) warning lamp lights up. The electric parking brake is malfunctioning.</p> <p>To apply:</p> <ul style="list-style-type: none"> ► Switch the ignition off. ► Press the electric parking brake handle for at least ten seconds. ► Shift the transmission to P. ► Consult a qualified specialist workshop. <p>The yellow (P) warning lamp and the red PARK (USA only)/(P) (Canada only) indicator lamp lights up. The electric parking brake is malfunctioning.</p> <p>To release:</p> <ul style="list-style-type: none"> ► Switch off the ignition and turn it back on. ► Release the electric parking brake manually. <p>or</p> <ul style="list-style-type: none"> ► Release the electric parking brake automatically (► page 184). <p>If the electric parking brake still cannot be released:</p> <ul style="list-style-type: none"> ► Do not drive on. ► Consult a qualified specialist workshop.













Display messages	Possible causes/consequences and ► Solutions
	<p>The red  (USA only)/ (Canada only) indicator lamp flashes and the yellow  warning lamp lights up. The electric parking brake is malfunctioning.</p> <p>To release:</p> <ul style="list-style-type: none"> ► Switch off the ignition and turn it back on. ► Release the electric parking brake manually. <p>To apply:</p> <ul style="list-style-type: none"> ► Switch off the ignition and turn it back on. ► Apply the electric parking brake manually. <p>If the red  (USA only)/ (Canada only) indicator lamp continues to flash:</p> <ul style="list-style-type: none"> ► Do not drive on. ► Secure the vehicle against rolling away (▷ page 424). ► Shift the transmission to P. ► Turn the front wheels towards the curb. ► Consult a qualified specialist workshop.
	<p>The yellow  warning lamp lights up. The red  (USA only)/ (Canada only) indicator lamp flashes for about ten seconds after the electric parking brake has been applied or released. It then goes out or remains lit. The electric parking brake is malfunctioning.</p> <ul style="list-style-type: none"> ► Switch off the ignition and turn it back on. ► Apply the electric parking brake. <p>If it is not possible to engage the electric parking brake:</p> <ul style="list-style-type: none"> ► Shift the transmission to P. ► Visit a qualified specialist workshop. <p>If it is not possible to release the electric parking brake:</p> <ul style="list-style-type: none"> ► Release the electric parking brake automatically (▷ page 184). <p>If the electric parking brake still cannot be released:</p> <ul style="list-style-type: none"> ► Consult a qualified specialist workshop.

Display messages	Possible causes/consequences and ► Solutions
	<p>The yellow  warning lamp lights up. If you manually apply or release the electric parking brake, the red  (USA only)/ (Canada only) indicator lamp flashes.</p> <p>The electric parking brake is malfunctioning. It is not possible to apply the electric parking brake manually.</p> <ul style="list-style-type: none"> ► Shift the transmission to P. ► Visit a qualified specialist workshop.
<p> (USA only)  (Canada only)</p> <p>Parking Brake Inoperative</p>	<p>The yellow  warning lamp lights up. The red  (USA only)/ (Canada only) indicator lamp flashes for about ten seconds after the electric parking brake has been applied or released. It then goes out or remains lit.</p> <p>The electric parking brake is malfunctioning, e.g. because of overvoltage or undervoltage.</p> <ul style="list-style-type: none"> ► Remove the cause for the overvoltage or undervoltage, e.g. by charging the battery or restarting the engine. ► Engage or release the electric parking brake. <p>If it remains impossible to apply or release the electric parking brake:</p> <ul style="list-style-type: none"> ► Switch off the ignition and turn it back on. ► Engage or release the electric parking brake. <p>If the electric parking brake still cannot be released:</p> <ul style="list-style-type: none"> ► Consult a qualified specialist workshop.
<p> (USA only)  (Canada only)</p> <p>Turn On the Ignition to Release the Parking Brake</p>	<p>The yellow  warning lamp lights up and the red  (USA only)/ (Canada only) indicator lamp flashes.</p> <p>It is not possible to apply the electric parking brake manually.</p> <ul style="list-style-type: none"> ► Shift the transmission to P. ► Visit a qualified specialist workshop. <p>The red  (USA only)/ (Canada only) indicator lamp lights up.</p> <p>You attempted to release the electric parking brake while the ignition was switched off.</p> <ul style="list-style-type: none"> ► SmartKey: turn the SmartKey to position 1 in the ignition lock. ► KEYLESS-GO: switch on the ignition.

Display messages	Possible causes/consequences and ► Solutions
 <p>BRAKE (USA only)  (Canada only) Check Brake Fluid Level</p>	<p>There is not enough brake fluid in the brake fluid reservoir. In addition, the BRAKE (USA only)/ (Canada only) warning lamp lights up in the instrument cluster and a warning tone sounds.</p> <p> WARNING</p> <p>The braking effect may be impaired. There is a risk of an accident.</p> <ul style="list-style-type: none"> ► Pull over and stop the vehicle safely as soon as possible, paying attention to road and traffic conditions. Do not continue driving under any circumstances. ► Secure the vehicle against rolling away (► page 182). ► Consult a qualified specialist workshop. ► Do not add brake fluid. This does not correct the malfunction.
 <p>Brake Wear</p>	<p>The brake pads/linings have reached their wear limit.</p> <ul style="list-style-type: none"> ► Visit a qualified specialist workshop.
 <p>mbrace Inoperative</p>	<p>USA only: one or more of the main functions in the mbrace system are malfunctioning. Canada only: one or more of the main functions of the TELEAID system are malfunctioning.</p> <ul style="list-style-type: none"> ► USA only: have the mbrace system checked at a qualified specialist workshop. ► Canada only: have the TELEAID system checked at a qualified specialist workshop.
<p>PRE-SAFE Inoperative See Operator's Manual</p>	<p>Important functions of PRE-SAFE® have failed. All other occupant safety systems, e.g. air bags, remain available.</p> <ul style="list-style-type: none"> ► Visit a qualified specialist workshop immediately.

Display messages	Possible causes/consequences and ► Solutions
<p>PRE-SAFE Functions Currently Limited See Operator's Manual</p>	<p>Vehicles without the Active Driving Assistance package: Adaptive Brake Assist is temporarily inoperative. Possible causes are:</p> <ul style="list-style-type: none"> • function is impaired due to heavy rain or snow. • the sensor in the bumper is dirty. • the radar sensor system is temporarily inoperative, e.g. due to electromagnetic radiation emitted by nearby TV or radio stations or other sources of electromagnetic radiation. • AMG vehicles: ESP® is deactivated. • the system is outside the operating temperature range. • the on-board voltage is too low. <p>When the causes stated above no longer apply, the display message disappears.</p> <p>Adaptive Brake Assist is operational again.</p> <p>If the display message does not disappear:</p> <ul style="list-style-type: none"> ► Pull over and stop the vehicle safely as soon as possible, paying attention to road and traffic conditions. ► Secure the vehicle against rolling away (▷ page 182). ► Clean the bumpers (▷ page 375). ► Restart the engine. ► AMG vehicles: reactivate ESP® (▷ page 73).

Display messages	Possible causes/consequences and ► Solutions
<p>PRE-SAFE Functions Currently Limited See Operator's Manual</p>	<p>Vehicles with the Active Driving Assistance package: PRE-SAFE® Brake is temporarily inoperative. Possible causes are:</p> <ul style="list-style-type: none"> • function is impaired due to heavy rain or snow. • the sensors in the radiator trim and the bumper are dirty. • the radar sensor system is temporarily inoperative, e.g. due to electromagnetic radiation emitted by nearby TV or radio stations or other sources of electromagnetic radiation. • AMG vehicles: ESP® is deactivated. • the system is outside the operating temperature range. • the on-board voltage is too low. <p>When the causes stated above no longer apply, the display message disappears. PRE-SAFE® Brake is operational again.</p> <p>If the display message does not disappear:</p> <ul style="list-style-type: none"> ► Pull over and stop the vehicle safely as soon as possible, paying attention to road and traffic conditions. ► Secure the vehicle against rolling away (► page 182). ► Clean the sensors in the radiator trim and the bumper (► page 375). ► Restart the engine. ► AMG vehicles: reactivate ESP® (► page 73).
<p>PRE-SAFE Functions Limited See Operator's Manual</p>	<p>Vehicles without the Active Driving Assistance package: Adaptive Brake Assist is faulty. The distance warning function may also have failed.</p> <p>Vehicles with the Active Driving Assistance package: PRE-SAFE® Brake is faulty. BAS PLUS or the distance warning function may also have failed.</p> <ul style="list-style-type: none"> ► Visit a qualified specialist workshop.
<p> Restraint Sys. Malfunction Service Required</p>	<p>The restraint system is faulty.</p> <p>The  warning lamp also lights up in the instrument cluster.</p> <p>⚠ WARNING</p> <p>The air bags or Emergency Tensioning Devices may either be triggered unintentionally or, in the event of an accident, may not be triggered.</p> <p>There is an increased risk of injury.</p> <ul style="list-style-type: none"> ► Visit a qualified specialist workshop. <p>For further information about the restraint system, see (► page 44).</p>

Display messages	Possible causes/consequences and ► Solutions
 <p>Front Left Malfunction Service Required or Front Right Malfunction Service Required</p>	<p>The restraint system has malfunctioned at the front on the left or right. The  warning lamp also lights up in the instrument cluster.</p> <p> WARNING</p> <p>The air bags or Emergency Tensioning Devices may either be triggered unintentionally or, in the event of an accident, may not be triggered.</p> <p>There is an increased risk of injury.</p> <p>► Visit a qualified specialist workshop.</p>
 <p>Rear Left Malfunction Service Required or Rear Right Malfunction Service Required</p>	<p>The restraint system has malfunctioned at the rear on the left or right. The  warning lamp also lights up in the instrument cluster.</p> <p> WARNING</p> <p>The air bags or Emergency Tensioning Devices may either be triggered unintentionally or, in the event of an accident, may not be triggered.</p> <p>There is an increased risk of injury.</p> <p>► Visit a qualified specialist workshop.</p>
 <p>Rear Center Malfunction Service Required</p>	<p>The restraint system has malfunctioned at the rear center. The  warning lamp also lights up in the instrument cluster.</p> <p> WARNING</p> <p>The air bags or Emergency Tensioning Devices may either be triggered unintentionally or, in the event of an accident, may not be triggered.</p> <p>There is an increased risk of injury.</p> <p>► Visit a qualified specialist workshop.</p>
 <p>Left Side Curtain Airbag Malfunction Service Required or Right Side Curtain Airbag Malfunction Service Required</p>	<p>There is a malfunction in the left-hand or right-hand window curtain air bag. The  warning lamp also lights up in the instrument cluster.</p> <p> WARNING</p> <p>The left or right window curtain air bag may either be triggered unintentionally or, in the event of an accident, may not be triggered.</p> <p>There is an increased risk of injury.</p> <p>► Visit a qualified specialist workshop.</p>

Display messages	Possible causes/consequences and ► Solutions
<p>Front Passenger Airbag Disabled See Operator's Manual</p>	<p>The front-passenger air bag is deactivated during the journey, even though:</p> <ul style="list-style-type: none"> • an adult or • a person larger than a certain size is occupying the front-passenger seat <p>If additional forces are applied to the seat, the system may interpret the occupant's weight as lower than it actually is.</p> <p> WARNING</p> <p>The front-passenger air bag does not deploy during an accident. There is an increased risk of injury.</p> <ul style="list-style-type: none"> ► Pull over and stop the vehicle safely as soon as possible, paying attention to road and traffic conditions. ► Secure the vehicle against rolling away (► page 182). ► Switch the ignition off. ► Have the occupant get out of the vehicle. ► Keep the seat unoccupied, close the front-passenger door and switch on the ignition. ► Observe the PASSENGER AIR BAG OFF indicator lamp in the center console and the multifunction display and check the following: <p>Seat unoccupied and ignition switched on:</p> <ul style="list-style-type: none"> • the PASSENGER AIR BAG OFF indicator lamp must light up and remain lit. If the indicator lamp is on, OCS has deactivated the front-passenger air bag (► page 53). • the Front Passenger Airbag Enabled See Operator's Manual or Front Passenger Airbag Disabled See Operator's Manual display messages must not be shown in the multifunction display. <ul style="list-style-type: none"> ► Wait for a period of at least 60 seconds until the necessary system checks have been completed. ► Make sure that the display messages do not appear in the multifunction display. <p>If these conditions are fulfilled, the front-passenger seat can be occupied again. Whether the PASSENGER AIR BAG OFF indicator lamp remains lit or goes out depends on how OCS classifies the occupant.</p> <p>If the conditions are not fulfilled, the system is not operating correctly.</p> <ul style="list-style-type: none"> ► Visit a qualified specialist workshop immediately.





Display messages	Possible causes/consequences and ► Solutions
<p>Front Passenger Airbag Enabled See Operator's Manual</p>	<p>The front-passenger air bag is enabled during the journey, even though:</p> <ul style="list-style-type: none"> • a child, a small adult or an object weighing less than the system's weight threshold is located on the front-passenger seat or • the front-passenger seat is unoccupied <p>The system may detect objects or forces applying additional weight on the seat.</p> <p> WARNING</p> <p>The air bag may deploy unintentionally. There is an increased risk of injury.</p> <ul style="list-style-type: none"> ► Pull over and stop the vehicle safely as soon as possible, paying attention to road and traffic conditions. ► Secure the vehicle against rolling away (▷ page 182). ► Switch the ignition off. ► Open the front-passenger door. ► Remove the child and the child restraint system from the front-passenger seat. ► Make sure that there are no objects on the seat adding to the weight. The system may otherwise detect the additional weight and interpret the seat occupant's weight as greater than it actually is. ► Keep the seat unoccupied, close the front-passenger door and switch on the ignition. ► Observe the PASSENGER AIR BAG OFF indicator lamp in the center console and the multifunction display and check the following: Seat unoccupied and ignition switched on: <ul style="list-style-type: none"> • the PASSENGER AIR BAG OFF indicator lamp must light up and remain lit. When the indicator lamp is on, OCS (Occupant Classification System) has disabled the front-passenger air bag (▷ page 53). • the Front Passenger Airbag Enabled See Operator's Manual or Front Passenger Airbag Disabled See Operator's Manual display messages must not be shown in the multifunction display. ► Wait for a period of at least 60 seconds until the necessary system checks have been completed. ► Make sure that the display messages do not appear in the multifunction display.







Display messages	Possible causes/consequences and ► Solutions
	<p>If these conditions are fulfilled, the front-passenger seat can be occupied again. Whether the PASSENGER AIR BAG OFF indicator lamp remains lit or goes out depends on how OCS classifies the occupant.</p> <p>If the conditions are not fulfilled, the system is not operating correctly.</p> <p>► Visit a qualified specialist workshop immediately.</p>

Lights



i Display messages about LEDs:

This display message will only appear if all LEDs have failed.



Display messages	Possible causes/consequences and ► Solutions
 Check Left Cornering Light or Check Right Cornering Light	<p>The left or right-hand cornering light is defective.</p> <p>► Visit a qualified specialist workshop.</p>
 Check Left Low Beam or Check Right Low Beam	<p>The left or right-hand low-beam headlamp is defective.</p> <p>► Check whether you are permitted to replace the bulb yourself (> page 129).</p> <p>or</p> <p>► Visit a qualified specialist workshop.</p>
 Check Trailer Left Turn Signal or Check Trailer Right Turn Signal	<p>The left or right-hand trailer turn signal lamp is defective.</p> <p>► Observe the separate operating instructions provided by the trailer manufacturer.</p>
 Check Rear Left Turn Signal or Check Rear Right Turn Signal	<p>The rear left-hand or rear right-hand turn signal is defective.</p> <p>► Check whether you are permitted to replace the bulb yourself (> page 129).</p> <p>or</p> <p>► Visit a qualified specialist workshop.</p>



Display messages	Possible causes/consequences and ► Solutions
 <p>Check Front Left Turn Signal or Check Front Right Turn Signal</p>	<p>The front left-hand or front right-hand turn signal is defective.</p> <p>► Visit a qualified specialist workshop.</p>
 <p>Check Left Mirror Turn Signal or Check Right Mirror Turn Signal</p>	<p>The turn signal in the left-hand or right-hand exterior mirror is defective.</p> <p>► Visit a qualified specialist workshop.</p>
 <p>Check Center Brake Lamp</p>	<p>The high-mounted brake lamp is faulty.</p> <p>► Visit a qualified specialist workshop.</p>
 <p>Check Left Brake Lamp or Check Right Brake Lamp</p>	<p>The left or right-hand brake lamp is defective.</p> <p>► Check whether you are permitted to replace the bulb yourself (► page 129).</p> <p>or</p> <p>► Visit a qualified specialist workshop.</p>
 <p>Check Left Tail and Brake Lamps or Check Right Tail and Brake Lamps</p>	<p>The left or right-hand tail lamp/brake lamp is defective.</p> <p>► Check whether you are permitted to replace the bulb yourself (► page 129).</p> <p>or</p> <p>► Visit a qualified specialist workshop.</p>
 <p>Check Left High Beam or Check Right High Beam</p>	<p>The left or right-hand high beam is defective.</p> <p>► Check whether you are permitted to replace the bulb yourself (► page 129).</p> <p>or</p> <p>► Visit a qualified specialist workshop.</p>
 <p>License Plate Lamp</p>	<p>The left or right-hand license plate lamp is defective.</p> <p>► Visit a qualified specialist workshop.</p>







Display messages	Possible causes/consequences and ► Solutions
 <p>Check Front Left Parking Lamp or Check Front Right Parking Lamp</p>	<p>The front left or front right parking or standing lamp is defective.</p> <ul style="list-style-type: none"> ► Check whether you are permitted to replace the bulb yourself (▷ page 129). <p>or</p> <ul style="list-style-type: none"> ► Visit a qualified specialist workshop.
 <p>Backup Light</p>	<p>The backup lamp is defective.</p> <ul style="list-style-type: none"> ► Visit a qualified specialist workshop.
 <p>Check Front Left Sidemarkers Lamp or Check Front Right Sidemarkers Lamp</p>	<p>The left or right front side marker lamp is defective.</p> <ul style="list-style-type: none"> ► Visit a qualified specialist workshop.
 <p>Check Left Tail Lamp or Check Right Tail Lamp</p>	<p>The left or right-hand tail lamp is defective.</p> <p>or</p> <p>The rear left or right side marker lamp is defective.</p> <ul style="list-style-type: none"> ► Visit a qualified specialist workshop.
 <p>Check Left Daytime Running Light or Check Right Daytime Running Light</p>	<p>The left-hand or right-hand daytime running lamp is faulty.</p> <ul style="list-style-type: none"> ► Visit a qualified specialist workshop.
 <p>Active Light System Inoperative</p>	<p>The active light function is defective.</p> <ul style="list-style-type: none"> ► Visit a qualified specialist workshop.
 <p>Malfunction See Operator's Manual</p>	<p>The exterior lighting is defective.</p> <ul style="list-style-type: none"> ► Visit a qualified specialist workshop. <p>Vehicles with trailer tow hitch: a fuse may have blown.</p> <ul style="list-style-type: none"> ► Check the fuses (▷ page 396). ► If necessary, replace the blown fuse. Observe the warning notes. <p>If the display message continues to be displayed:</p> <ul style="list-style-type: none"> ► Visit a qualified specialist workshop.







Display messages	Possible causes/consequences and ► Solutions
 <p>Auto Lamp Function Inoperative</p>	<p>The light sensor is defective.</p> <p>► Visit a qualified specialist workshop.</p>
 <p>Switch Off Lights</p>	<p>The lights are still switched on when you leave the vehicle. A warning tone also sounds.</p> <p>► Turn the light switch to AUTO.</p>
<p>Adaptive Highbeam Assist Inoperative</p>	<p>Adaptive Highbeam Assist is faulty.</p> <p>► Visit a qualified specialist workshop.</p>
<p>Adaptive Highbeam Assist Currently Unavailable See Operator's Manual</p>	<p>Adaptive Highbeam Assist is deactivated and temporarily inoperative. Possible causes are:</p> <ul style="list-style-type: none"> • the windshield in the camera's field of vision is dirty. • visibility is impaired due to heavy rain, snow or fog. <p>► Clean the windshield.</p> <p>If the system detects that the camera is fully operational again, the Adaptive Highbeam Assist Now Available message is displayed.</p> <p>Adaptive Highbeam Assist is operational again.</p>





Engine





Display messages	Possible causes/consequences and ► Solutions
 <p>Check Coolant Level See Operator's Manual</p>	<p>The coolant level is too low.</p> <p>! Avoid making long journeys with too little coolant in the engine cooling system. The engine will otherwise be damaged.</p> <p>► Add coolant, observing the warning notes before doing so (▷ page 369).</p> <p>► If coolant needs to be added more often than usual, have the engine coolant system checked at a qualified specialist workshop.</p>
	<p>The fan motor is faulty.</p> <p>► At coolant temperatures below 248 °F (120 °C), drive to the nearest qualified specialist workshop.</p> <p>► Avoid subjecting the engine to heavy loads, e.g. driving in mountainous terrain, and stop-and-go traffic.</p>



Display messages	Possible causes/consequences and ► Solutions
 <p data-bbox="116 228 333 316">Coolant Too Hot Stop Vehicle Turn Engine Off</p>	<p data-bbox="372 178 659 236">The coolant is too hot. A warning tone also sounds.</p> <p data-bbox="383 253 535 284"> WARNING</p> <p data-bbox="372 298 1031 379">Do not drive when your engine is overheated. This can cause some fluids which may have leaked into the engine compartment to catch fire.</p> <p data-bbox="372 391 1028 445">Steam from the overheated engine can also cause serious burns which can occur just by opening the hood.</p> <p data-bbox="372 456 611 481">There is a risk of injury.</p> <ul style="list-style-type: none"> <li data-bbox="372 493 1028 547">► Pull over and stop the vehicle safely and switch off the engine, paying attention to road and traffic conditions. <li data-bbox="372 558 936 584">► Secure the vehicle against rolling away (► page 182). <li data-bbox="372 595 788 620">► Wait until the engine has cooled down. <li data-bbox="372 632 983 686">► Make sure that the air supply to the engine radiator is not blocked, e.g. by snow, slush or ice. <li data-bbox="372 697 1031 778">► Do not start the engine again until the display message goes out and the coolant temperature is below 248 °F (120 °C). Otherwise, the engine could be damaged. <li data-bbox="372 790 893 815">► Pay attention to the coolant temperature display. <li data-bbox="372 826 1012 880">► If the temperature increases again, visit a qualified specialist workshop immediately. <p data-bbox="372 892 1031 946">Under normal operating conditions and with the specified coolant level, the coolant temperature may rise to 248 °F (120 °C).</p>
 <p data-bbox="116 1015 353 1072">See Operator's Manual</p>	<p data-bbox="372 965 708 1023">The battery is not being charged. A warning tone also sounds.</p> <p data-bbox="372 1034 581 1059">Possible causes are:</p> <ul style="list-style-type: none"> <li data-bbox="372 1070 613 1096">• a defective alternator <li data-bbox="372 1107 572 1133">• a torn poly-V-belt <li data-bbox="372 1144 717 1169">• a malfunction in the electronics <ul style="list-style-type: none"> <li data-bbox="372 1181 1028 1235">► Pull over and stop the vehicle safely and switch off the engine, paying attention to road and traffic conditions. <p data-bbox="372 1257 1031 1283">! Do not continue driving. The engine could otherwise overheat.</p> <ul style="list-style-type: none"> <li data-bbox="372 1294 936 1319">► Secure the vehicle against rolling away (► page 182). <li data-bbox="372 1331 799 1356">► Consult a qualified specialist workshop.

Display messages	Possible causes/consequences and ► Solutions
 <p>Stop Vehicle See Operator's Manual</p>	<p>The battery is no longer being charged and the battery charge level is too low.</p> <p>A warning tone also sounds.</p> <ul style="list-style-type: none"> ► Pull over and stop the vehicle safely and switch off the engine, paying attention to road and traffic conditions. ► Secure the vehicle against rolling away (▷ page 182). ► Observe the instructions in the display message  See Operator's Manual. ► Consult a qualified specialist workshop.
 <p>Check Engine Oil At Next Refueling</p>	<p>The engine oil level has dropped to the minimum level.</p> <p>A warning tone also sounds.</p> <ul style="list-style-type: none"> ► Check the oil level when next refueling, at the latest (▷ page 367). ► If necessary, add engine oil (▷ page 368). ► Have the engine checked at a qualified specialist workshop if the engine oil needs topping up more often than usual. <p>! Avoid long journeys with too little engine oil. The engine will otherwise be damaged.</p> <p>Information on approved engine oils can be obtained from any qualified specialist workshop or on the Internet at http://bevo.mercedes-benz.com.</p>
 <p>Check Engine Oil Level (Add 1 quart)</p>	<p>AMG vehicles: the engine oil level is too low.</p> <ul style="list-style-type: none"> ► Check the oil level when next refueling, at the latest (▷ page 367). ► If necessary, add engine oil (▷ page 368). ► Have the engine checked at a qualified specialist workshop if the engine oil needs topping up more often than usual. <p>! Avoid long journeys with too little engine oil. The engine will otherwise be damaged.</p> <p>Information on approved engine oils can be obtained from any qualified specialist workshop or on the Internet at http://bevo.mercedes-benz.com.</p>
 <p>Fuel Level Low</p>	<p>The fuel level has dropped into the reserve range.</p> <ul style="list-style-type: none"> ► Refuel at the nearest gas station.
	<p>There is only a very small amount of fuel in the fuel tank.</p> <ul style="list-style-type: none"> ► Refuel at the nearest gas station without fail.



Display messages	Possible causes/consequences and ► Solutions
 <p>Gas Cap Loose</p>	<p>The fuel system pressure is too low. The fuel filler cap is not closed correctly or the fuel system is leaking.</p> <ul style="list-style-type: none"> ► Check that the fuel filler cap is correctly closed. <p>If the fuel filler cap is not correctly closed:</p> <ul style="list-style-type: none"> ► Close the fuel filler cap. <p>If the fuel filler cap is correctly closed:</p> <ul style="list-style-type: none"> ► Visit a qualified specialist workshop.
 <p>Ultra Low-sulfur Diesel Fuel Only</p>	<p>Vehicles with a diesel engine: the fuel level has fallen below the reserve range.</p> <ul style="list-style-type: none"> ► Refuel at the nearest gas station. ► Only use commercially available vehicular ULTRA-LOW SULFUR HIGHWAY DIESEL FUEL (ULSD, 15 ppm sulfur MAXIMUM).
 <p>Replace Air Filter</p>	<p>Vehicles with a diesel engine: the engine air filter is dirty and must be replaced.</p> <ul style="list-style-type: none"> ► Visit a qualified specialist workshop.
 <p>Check Fuel Filter</p>	<p>Vehicles with a diesel engine: there is water in the fuel filter. The water must be drained off.</p> <ul style="list-style-type: none"> ► Visit a qualified specialist workshop.
 <p>Check Additive See Operator's Manual</p>	<p>The DEF tank is almost empty.</p> <ul style="list-style-type: none"> ► Have the DEF tank filled as soon as possible at a qualified specialist workshop (► page 180).
 <p>Remaining Starts: 16</p>	<p>The DEF level has fallen to a minimum. You can start the engine a further 16 times.</p> <ul style="list-style-type: none"> ► Have the DEF tank filled immediately at a qualified specialist workshop (► page 180). <p>i You can start the engine a further 16 times. If DEF is not added, it will then not be possible to restart the engine. Refill the DEF tank with approximately 1 gal (3.8 l) DEF (► page 180).</p>

Driving systems	
Display messages	Possible causes/consequences and ► Solutions
 <p>Attention Assist: Take a Break!</p>	<p>Based on certain criteria, ATTENTION ASSIST has detected fatigue or a lack of concentration on the part of the driver. A warning tone also sounds.</p> <ul style="list-style-type: none"> ► If necessary, take a break. <p>During long journeys, take regular breaks in good time so you get enough rest.</p>
 <p>Attention Assist Inoperative</p>	<p>ATTENTION ASSIST is inoperative.</p> <ul style="list-style-type: none"> ► Visit a qualified specialist workshop.
 <p>Drive More Slowly</p>	<p>You cannot change the vehicle level. Possible causes are:</p> <ul style="list-style-type: none"> • you are driving too fast for the selected vehicle level. • you are towing a trailer. • the trailer-coupling socket is being used, e.g. for a bicycle rack. <ul style="list-style-type: none"> ► Drive more slowly and then select the desired vehicle level again. <ul style="list-style-type: none"> • Vehicles with the ON&OFFROAD package (► page 206) • Vehicles with the AIRMATIC package (► page 213) ► Observe the notes on towing a trailer (► page 257).
 <p>Compressor Is Cooling</p>	<p>You have selected a higher vehicle level. The compressor first needs to cool down because of frequent level changes.</p> <ul style="list-style-type: none"> ► Drive in a manner appropriate for the current vehicle level. ► Make sure that there is sufficient ground clearance. ► Allow the compressor to cool down. <p>When the compressor has cooled down, the display message disappears. The vehicle then continues rising to the selected level.</p>
 <p>ABC Malfunction</p>	<p>AIRMATIC is malfunctioning.</p> <ul style="list-style-type: none"> ► Drive as appropriate for the current vehicle level, but do not exceed 50 mph (80 km/h). ► Make sure that there is sufficient ground clearance. ► Have the vehicle checked at a qualified specialist workshop.

Display messages	Possible causes/consequences and ► Solutions
 <p>Max. Speed 12 mph</p>	<p>You are exceeding the speed permissible for the selected off-road level.</p> <p>In addition, the vehicle level display appears between the vehicle icon and the display message, and a warning tone sounds.</p> <p> WARNING</p> <p>The vehicle could tip and rollover. There is a risk of an accident.</p> <ul style="list-style-type: none"> ► Adjust your driving style to the altered handling characteristics. ► Only make slight steering movements and avoid fast steering movements. ► Do not exceed 12 mph (20 km/h) until the vehicle has reached off-road level 2.
<p>ACTIVE CURVE SYSTEM malfunctioning</p>	<p>The Active Curve System is faulty. The vehicle's handling characteristics may be affected.</p> <ul style="list-style-type: none"> ► Do not drive at speeds above 50 mph (80 km/h). ► Have the vehicle checked at a qualified specialist workshop.
<p>ACTIVE CURVE SYSTEM Malfunction See Operator's Manual</p>	<p>The Active Curve System is faulty. The vehicle's handling characteristics are severely impaired. A warning tone also sounds.</p> <p> WARNING</p> <p>There is a risk of an accident.</p> <ul style="list-style-type: none"> ► Drive on carefully. ► Adjust your driving style to the altered handling characteristics. ► Avoid sudden acceleration in tight bends and fast steering movements. ► Do not drive at speeds above 50 mph (80 km/h). ► Visit a qualified specialist workshop immediately.
 <p>Raising Max. Speed 12 mph</p>	<p>The vehicle is being adjusted to off-road level 3. The display message informs you of the maximum speed permissible for off-road level 3.</p> <ul style="list-style-type: none"> ► Do not drive at speeds above 12 mph (20 km/h).
 <p>Lowering Max. Speed 12 mph</p>	<p>The vehicle is being lowered from off-road level 3 to off-road level 2. The display message informs you of the maximum speed permissible for off-road level 3.</p> <ul style="list-style-type: none"> ► Do not exceed 12 mph (20 km/h) until the vehicle has reached off-road level 2.

Display messages	Possible causes/consequences and ► Solutions
 <p>Different. Lock Sys. Malfunction</p>	<p>The differential lock is faulty.</p> <ul style="list-style-type: none"> ► Do not drive at speeds above 50 mph (80 km/h). ► Have the vehicle checked at a qualified specialist workshop.
 <p>Different. Locking Sys. Cooling Down Please Wait</p>	<p>The differential lock is too hot and has been disengaged.</p> <ul style="list-style-type: none"> ► Drive on carefully. ► Allow the differential lock to cool down. The differential lock re-engages as soon as it has cooled down.
<p>LOW RANGE Stop Apply Parking Brake</p>	<p>A gearshift process has been canceled. LOW RANGE is in the neutral position. There is no connection between the engine and the drive wheels.</p> <ul style="list-style-type: none"> ► Pull over and stop the vehicle safely as soon as possible, paying attention to road and traffic conditions. ► Apply the electric parking brake. Do not continue driving under any circumstances. ► Repeat the gearshift process.
<p>LOW RANGE Malfunction To Park, Apply Brake</p>	<p>LOW RANGE is malfunctioning.</p> <ul style="list-style-type: none"> ► Do not drive at speeds above 50 mph (80 km/h). ► When parking, secure the vehicle against rolling away (▷ page 182). ► Have the vehicle checked at a qualified specialist workshop.
<p>LOW RANGE Max. Speed 25 mph</p>	<p>You have exceeded the maximum speed for the gearshift process.</p> <ul style="list-style-type: none"> ► Drive more slowly. The gear change is made.
<p>LOW RANGE Max. Speed 40 mph</p>	<p>You have exceeded the maximum speed for the gearshift process.</p> <ul style="list-style-type: none"> ► Drive more slowly. The gear change is made.
<p>LOW RANGE Shift to Position N Briefly</p>	<p>You have reduced the vehicle speed, but the automatic transmission is not in position N.</p> <ul style="list-style-type: none"> ► Briefly shift the automatic transmission to position N.
<p>LOW RANGE Shifting Canceled Please Reactivate</p>	<p>The gearshift process has been canceled.</p> <ul style="list-style-type: none"> ► Repeat the gearshift process.
 <p>Inoperative</p>	<p>DSR (Downhill Speed Regulation) is deactivated due to a malfunction.</p> <ul style="list-style-type: none"> ► Have DSR checked at a qualified specialist workshop.

Display messages	Possible causes/consequences and ► Solutions
<div style="border: 1px solid black; padding: 2px; display: inline-block; margin-bottom: 5px;">HOLD</div> Off	The HOLD function is deactivated. the vehicle is skidding. A warning tone also sounds. ► Reactivate the HOLD function later (▷ page 210).
Radar Sensors Deactivated See Operator's Manual	The radar sensor system is deactivated. ► Switch on the radar sensor system (▷ page 279).
Lane Keeping Assist Currently Unavailable See Operator's Manual or Active Lane Keeping Assist Currently Unavailable See Operator's Manual	Lane Keeping Assist or Active Lane Keeping Assist is deactivated and temporarily inoperative. Possible causes are: <ul style="list-style-type: none"> • the windshield in the camera's field of vision is dirty. • visibility is impaired due to heavy rain, snow or fog. • there are no lane markings for a longer period. • the lane markings are worn, dark or covered, e.g. by dirt or snow. When the causes stated above no longer apply, the display message disappears. Lane Keeping Assist or Active Lane Keeping Assist is operational again. If the display message does not disappear: <ul style="list-style-type: none"> ► Pull over and stop the vehicle safely as soon as possible, paying attention to road and traffic conditions. ► Secure the vehicle against rolling away (▷ page 182). ► Clean the windshield.
Lane Keeping Assist Inoperative or Active Lane Keeping Assist Inoperative	Lane Keeping Assist or Active Lane Keeping Assist is defective. ► Visit a qualified specialist workshop.

Display messages	Possible causes/consequences and ► Solutions
<p>Blind Spot Assist Currently Unavailable See Operator's Manual or Active Blind Spot Assist Currently Unavailable See Operator's Manual</p>	<p>Blind Spot Assist or Active Blind Spot Assist is temporarily inoperative. Possible causes are:</p> <ul style="list-style-type: none"> • the sensors are dirty. • function is impaired due to heavy rain or snow. • the radar sensor system is outside the operating temperature range. • the radar sensor system is temporarily inoperative, e.g. due to electromagnetic radiation emitted by nearby TV or radio stations or other sources of electromagnetic radiation. <p>The yellow  indicator lamps also light up in the exterior mirrors.</p> <p>When the causes stated above no longer apply, the display message disappears.</p> <p>Blind Spot Assist or Active Blind Spot Assist is operational again.</p> <p>If the display message does not disappear:</p> <ul style="list-style-type: none"> ► Pull over and stop the vehicle safely as soon as possible, paying attention to road and traffic conditions. ► Secure the vehicle against rolling away (▷ page 182). ► Clean the sensors (▷ page 375). ► Restart the engine. <p>Blind Spot Assist or Active Blind Spot Assist is deactivated while towing a trailer.</p> <p>You have established the electrical connection between the trailer and your vehicle.</p> <ul style="list-style-type: none"> ► Press  on the steering wheel to confirm the display message.
<p>Blind Spot Assist Inoperative or Active Blind Spot Assist Inoperative</p>	<p>Blind Spot Assist or Active Blind Spot Assist is defective.</p> <p>The yellow  indicator lamps also light up in the exterior mirrors.</p> <ul style="list-style-type: none"> ► Visit a qualified specialist workshop.
<p>Park Assist Canceled</p>	<p>The driver's door is open and the driver's seat belt has not been fastened.</p> <ul style="list-style-type: none"> ► Repeat the parking process with the seat belt fastened and the driver's door closed. <p>You have inadvertently touched the multifunction steering wheel while steering intervention was active.</p> <ul style="list-style-type: none"> ► While steering intervention is active, make sure that the multifunction steering wheel is not touched unintentionally.

Display messages	Possible causes/consequences and ► Solutions
	<p>The vehicle has started to skid and ESP® has intervened.</p> <p>► Use Active Parking Assist again later (▷ page 220).</p>
<p>Park Assist Inoperative</p>	<p>You have just carried out a large number of turning or parking maneuvers.</p> <p>Active Parking Assist will become available again after approximately ten minutes (▷ page 220).</p> <p>► Pull over and stop the vehicle safely as soon as possible, paying attention to road and traffic conditions.</p> <p>► Switch off and restart the engine.</p> <p>If the display message continues to be displayed:</p> <p>► Visit a qualified specialist workshop.</p> <p>PARKTRONIC is defective.</p> <p>► Visit a qualified specialist workshop.</p>
<p>Park Assist Finished</p>	<p>The vehicle is parked. A warning tone also sounds.</p> <p>The display message disappears automatically.</p>
<p>DISTRONIC PLUS Off</p>	<p>DISTRONIC PLUS has been deactivated (▷ page 198).</p> <p>If it was deactivated automatically, a warning tone also sounds.</p>
<p>DISTRONIC PLUS Now Available</p>	<p>DISTRONIC PLUS is operational again after having been temporarily unavailable. You can now reactivate DISTRONIC PLUS (▷ page 198).</p>

Display messages	Possible causes/consequences and ► Solutions
<p>DISTRONIC PLUS Currently Unavailable See Operator's Manual</p>	<p>DISTRONIC PLUS is temporarily inoperative. Possible causes are:</p> <ul style="list-style-type: none"> • function is impaired due to heavy rain or snow. • the sensors in the radiator trim and the bumper are dirty. • the radar sensor system is temporarily inoperative, e.g. due to electromagnetic radiation emitted by nearby TV or radio stations or other sources of electromagnetic radiation. • the system is outside the operating temperature range. • the on-board voltage is too low. <p>A warning tone also sounds.</p> <p>When the causes stated above no longer apply, the display message disappears.</p> <p>DISTRONIC is operational again.</p> <p>If the display message does not disappear:</p> <ul style="list-style-type: none"> ► Pull over and stop the vehicle safely as soon as possible, paying attention to road and traffic conditions. ► Secure the vehicle against rolling away (▷ page 182). ► Clean the sensors in the radiator trim and the bumper (▷ page 375). ► Restart the engine.
<p>DISTRONIC PLUS Inoperative</p>	<p>DISTRONIC PLUS is defective.</p> <p>BAS PLUS (Brake Assist PLUS) and PRE-SAFE® Brake may be inoperative as well.</p> <p>A warning tone also sounds.</p> <ul style="list-style-type: none"> ► Visit a qualified specialist workshop.
<p>DISTRONIC PLUS Suspended</p>	<p>You have depressed the accelerator pedal. DISTRONIC PLUS is no longer controlling the speed of the vehicle.</p> <ul style="list-style-type: none"> ► Remove your foot from the accelerator pedal.
<p>DISTRONIC PLUS - - - mph</p>	<p>An activation condition for DISTRONIC PLUS is not fulfilled.</p> <ul style="list-style-type: none"> ► Check the activation conditions for DISTRONIC PLUS (▷ page 198).









Display messages	Possible causes/consequences and ► Solutions
Cruise Control Inoperative	Cruise control is defective. ► Visit a qualified specialist workshop.
Cruise Control --- mph	A condition for activating cruise control has not been fulfilled. You have tried to store a speed below 20 mph (30 km/h), for example. ► If conditions permit, drive faster than 20 mph (30 km/h) and store the speed. ► Check the activation conditions for cruise control (► page 195).

Tires	
Display messages	Possible causes/consequences and ► Solutions
Check Tire Pressure Soon	<p>The tire pressure loss warning system has detected a significant loss in pressure.</p> <p>A warning tone also sounds.</p> <p>Possible causes:</p> <ul style="list-style-type: none"> • you have changed the positions of the wheels and tires or installed new wheels and tires. • the tire pressure in one or more tires is not correct. <p> WARNING</p> <p>With tire pressures which are too low, there is a risk of the following hazards:</p> <ul style="list-style-type: none"> • they may burst, especially as the load and vehicle speed increase. • they may wear excessively and/or unevenly, which may greatly impair tire traction. • the driving characteristics, as well as steering and braking, may be greatly impaired. <p>There is a risk of an accident.</p> <ul style="list-style-type: none"> ► Stop the vehicle without making any sudden steering or braking maneuvers. Pay attention to the traffic conditions as you do so. ► Secure the vehicle against rolling away (▷ page 182). ► Check the tires and, if necessary, follow the instructions for a flat tire (▷ page 383). ► Check the tire pressures and, if necessary, correct the tire pressure. ► Restart the tire pressure loss warning system when the tire pressure is correct (▷ page 408).
Check Tire Pressure Then Restart Run Flat Indicator	<p>The tire pressure loss warning system generated a display message and has not been restarted since.</p> <ul style="list-style-type: none"> ► Set the correct tire pressure in all four tires. ► Restart the tire pressure loss warning system (▷ page 408).
Run Flat Indicator Inoperative	<p>The tire pressure loss warning system is faulty.</p> <ul style="list-style-type: none"> ► Visit a qualified specialist workshop.

Display messages	Possible causes/consequences and ► Solutions
Please Correct Tire Pressure	<p>The tire pressure is too low in at least one of the tires, or the tire pressure difference between the wheels is too great.</p> <ul style="list-style-type: none"> ► Check the tire pressures at the next opportunity (▷ page 408). ► If necessary, correct the tire pressure. ► Restart the tire pressure monitor (▷ page 411).
Check Tires	<p>The tire pressure in one or more tires has dropped significantly. The wheel position is displayed in the multifunction display. A warning tone also sounds.</p> <p> WARNING</p> <p>With tire pressures which are too low, there is a risk of the following hazards:</p> <ul style="list-style-type: none"> • they may burst, especially as the load and vehicle speed increase. • they may wear excessively and/or unevenly, which may greatly impair tire traction. • the driving characteristics, as well as steering and braking, may be greatly impaired. <p>There is a risk of an accident.</p> <ul style="list-style-type: none"> ► Stop the vehicle without making any sudden steering or braking maneuvers. Pay attention to the traffic conditions as you do so. ► Secure the vehicle against rolling away (▷ page 182). ► Check the tires and, if necessary, follow the instructions for a flat tire (▷ page 383). ► Check the tire pressure (▷ page 408). ► If necessary, correct the tire pressure.







Display messages	Possible causes/consequences and ► Solutions
Warning Tire Malfunction	<p>The tire pressure in one or more tires has dropped suddenly. The wheel position is shown in the multifunction display.</p> <p> WARNING</p> <p>If you drive with a flat tire, there is a risk of the following hazards:</p> <ul style="list-style-type: none"> • a flat tire affects the ability to steer or brake the vehicle. • you could lose control of the vehicle. • continued driving with a flat tire will cause excessive heat build-up and possibly a fire. <p>There is a risk of an accident.</p> <ul style="list-style-type: none"> ► Stop the vehicle without making any sudden steering or braking maneuvers. Pay attention to the traffic conditions as you do so. ► Secure the vehicle against rolling away (► page 182). ► Check the tires and, if necessary, follow the instructions for a flat tire (► page 383).
Tire Press. Monitor Currently Unavailable	<p>Due to a source of radio interference, no signals can be received from the wheel sensors. The tire pressure monitor is temporarily malfunctioning.</p> <ul style="list-style-type: none"> ► Drive on. The tire pressure monitor restarts automatically as soon as the problem has been solved.
Wheel Sensor Missing	<p>There is no signal from the tire pressure sensor of one or several wheels. The pressure of the affected tire is not displayed in the multifunction display.</p> <ul style="list-style-type: none"> ► Have the faulty tire pressure sensor replaced at a qualified specialist workshop.
Tire Pressure Monitor Inoperative No Wheel Sensors	<p>The wheels mounted do not have a suitable tire pressure sensor. The tire pressure monitor is deactivated.</p> <ul style="list-style-type: none"> ► Mount wheels with suitable tire pressure sensors. The tire pressure monitor is activated automatically after driving for a few minutes.
Tire Press. Monitor Inoperative	<p>The tire pressure monitor is faulty.</p> <ul style="list-style-type: none"> ► Visit a qualified specialist workshop.



Vehicle	
Display messages	Possible causes/consequences and ► Solutions
Shift to 'P' or 'N' to Start Engine	<p>You have attempted to start the engine with the transmission in position R or D.</p> <ul style="list-style-type: none"> ► Shift the transmission to position P or N.
Auxiliary Battery Malfunction	<p>The auxiliary battery for the automatic transmission is no longer being charged.</p> <ul style="list-style-type: none"> ► Visit a qualified specialist workshop at the next opportunity. ► Until then, set the automatic transmission to position P before you switch off the engine. ► Before leaving the vehicle, apply the electric parking brake. ► Secure the vehicle against rolling away (► page 182).
Apply Brake to Shift from 'P'	<p>You have attempted to move the transmission selector lever to position D, R or N without depressing the brake pedal.</p> <ul style="list-style-type: none"> ► Depress the brake pedal.
Transmission Not in P Risk of Vehicle Rolling Away	<p>The driver's door is open and the transmission is in position R, N or D.</p> <p>A warning tone also sounds.</p> <ul style="list-style-type: none"> ► Shift the transmission to position P. ► Secure the vehicle against rolling away (► page 182).
Service Required Do Not Shift Gears Visit Dealer	<p>You cannot change the transmission position due to a malfunction. A warning tone also sounds.</p> <p>If transmission position D is selected:</p> <ul style="list-style-type: none"> ► Drive to a qualified specialist workshop without shifting the transmission from position D. <p>If transmission position R, N or P is selected:</p> <ul style="list-style-type: none"> ► Notify a qualified specialist workshop or breakdown service.
Only Shift to 'P' when Vehicle is Stationary	<p>The vehicle is moving.</p> <ul style="list-style-type: none"> ► Stop the vehicle safely as soon as possible, paying attention to road and traffic conditions. ► Shift the transmission to position P.

Display messages	Possible causes/consequences and ► Solutions
	<p>The tailgate is open.</p> <p> WARNING</p> <p>When the engine is running, exhaust gases can enter the vehicle interior if the tailgate is open.</p> <p>There is a risk of poisoning.</p> <p>► Close the tailgate.</p>
	<p>The hood is open.</p> <p> WARNING</p> <p>The open hood may block your view when the vehicle is in motion.</p> <p>There is a risk of an accident.</p> <p>► Pull over and stop the vehicle safely as soon as possible, paying attention to road and traffic conditions.</p> <p>► Secure the vehicle against rolling away (► page 182).</p> <p>► Close the hood.</p>
	<p>At least one door is open.</p> <p>A warning tone also sounds.</p> <p>► Close all the doors.</p>
 <p>Power Steering Malfunction See Operator's Manual</p>	<p>The power steering is malfunctioning.</p> <p>A warning tone also sounds.</p> <p> WARNING</p> <p>You will need to use more force to steer.</p> <p>There is a risk of an accident.</p> <p>► Check whether you are able to apply the extra force required.</p> <p>► If you are able to steer safely: carefully drive on to a qualified specialist workshop.</p> <p>► If you are unable to steer safely: do not drive on. Contact the nearest qualified specialist workshop.</p>
<p>No Service</p>	<p>Your vehicle is outside the network provider's transmitter/receiver range.</p> <p>► Wait until the mobile phone operational readiness symbol appears in the multifunction display.</p>
 <p>Check Washer Fluid</p>	<p>The washer fluid level in the washer fluid reservoir has dropped below the minimum.</p> <p>► Add washer fluid (► page 370).</p>

Display messages	Possible causes/consequences and ► Solutions
Wiper malfunctioning	The windshield wipers are malfunctioning. ► Visit a qualified specialist workshop.
Hazard warning lamps malfunctioning	The hazard warning lamps are faulty. ► Visit a qualified specialist workshop.

SmartKey



Display messages	Possible causes/consequences and ► Solutions
 Key Does Not Belong to Vehicle	You have put the wrong SmartKey in the ignition lock. ► Use the correct SmartKey.
 Take Your Key from Ignition	The SmartKey is in the ignition lock. ► Remove the SmartKey.
 Obtain a New Key	The SmartKey needs to be replaced. ► Visit a qualified specialist workshop.
 Replace Key Battery	The batteries of the KEYLESS-GO key are discharged. ► Change the batteries (▷ page 83).
 Don't Forget Your Key	This display message is displayed for a maximum of 60 seconds and is simply a reminder. You have opened the driver's door with the engine switched off. The KEYLESS-GO key is not in the ignition lock. ► Remember to take the KEYLESS-GO key with you when you leave the vehicle.
 Key Not Detected (red display message)	The KEYLESS-GO key is not in the vehicle. A warning tone also sounds. If the engine is switched off, you can no longer lock the vehicle centrally or start the engine. ► Pull over and stop the vehicle safely as soon as possible, paying attention to road and traffic conditions. ► Secure the vehicle against rolling away (▷ page 182). ► Locate the KEYLESS-GO key.



Display messages	Possible causes/consequences and ► Solutions
	<p>The KEYLESS-GO key is not detected while the engine is running because there is interference from a strong source of radio waves. A warning tone also sounds.</p> <ul style="list-style-type: none"> ► Pull over and stop the vehicle safely as soon as possible, paying attention to road and traffic conditions. ► Secure the vehicle against rolling away (▷ page 182). ► Operate the vehicle with the SmartKey in the ignition lock.
 <p>Key Not Detected (white display message)</p>	<p>The KEYLESS-GO key cannot be detected at present.</p> <ul style="list-style-type: none"> ► Change the location of the SmartKey with the KEYLESS-GO functions in the vehicle. <p>If the KEYLESS-GO key is still not detected:</p> <ul style="list-style-type: none"> ► Operate the vehicle with the SmartKey in the ignition lock.
 <p>Remove 'Start' Button and Insert Key</p>	<p>KEYLESS-GO is temporarily malfunctioning or is defective. A warning tone also sounds.</p> <ul style="list-style-type: none"> ► Insert the SmartKey into the ignition lock and turn it to the desired position. ► Visit a qualified specialist workshop.

Warning and indicator lamps in the instrument cluster







Safety



Seat belts



Problem	Possible causes/consequences and ► Solutions
 <p>After starting the engine, the red seat belt warning lamp lights up for 6 seconds.</p>	<p>The seat belt warning lamp reminds the driver and front passenger to fasten their seat belts.</p> <ul style="list-style-type: none"> ► Fasten your seat belt (▷ page 48).
 <p>After starting the engine, the red seat belt warning lamp lights up. In addition, a warning tone sounds for up to 6 seconds.</p>	<p>The driver's seat belt is not fastened.</p> <ul style="list-style-type: none"> ► Fasten your seat belt (▷ page 48). The warning tone ceases.









Problem	Possible causes/consequences and ► Solutions
 <p>The red seat belt warning lamp lights up after the engine starts, as soon as the driver's or the front-passenger door is closed.</p>	<p>The driver or front passenger has not fastened their seat belt.</p> <ul style="list-style-type: none"> ► Fasten your seat belt (▷ page 48). The warning lamp goes out. <p>There are objects on the front-passenger seat.</p> <ul style="list-style-type: none"> ► Remove the objects from the front-passenger seat and stow them in a secure place. The warning lamp goes out.
 <p>The red seat belt warning lamp flashes and an intermittent audible warning sounds.</p>	<p>The driver or front passenger has not fastened their seat belt. The vehicle is being driven faster than 15 mph (25 km/h) or has briefly been driven faster than 15 mph (25 km/h).</p> <ul style="list-style-type: none"> ► Fasten your seat belt (▷ page 48). The warning lamp goes out and the intermittent warning tone ceases. <p>There are objects on the front-passenger seat. The vehicle is being driven faster than 15 mph (25 km/h) or has briefly been driven faster than 15 mph (25 km/h).</p> <ul style="list-style-type: none"> ► Remove the objects from the front-passenger seat and stow them in a secure place. The warning lamp goes out and the intermittent warning tone ceases.





Safety systems



Problem	Possible causes/consequences and ► Solutions
<p> (USA only)  (Canada only)</p> <p>The red brake system warning lamp comes on while the engine is running. A warning tone also sounds.</p>	<p> WARNING</p> <p>The brake boosting effect is malfunctioning and the braking characteristics may be affected. There is a risk of an accident.</p> <ul style="list-style-type: none"> ► Pull over and stop the vehicle safely as soon as possible, paying attention to road and traffic conditions. Do not continue driving under any circumstances. ► Secure the vehicle against rolling away (▷ page 182). ► Consult a qualified specialist workshop. ► Observe the additional display messages in the multifunction display.
<p> (USA only)  (Canada only)</p> <p>The red brake system warning lamp comes on while the engine is running. A warning tone also sounds.</p>	<p>There is not enough brake fluid in the brake fluid reservoir.</p> <p> WARNING</p> <p>The braking effect may be impaired. There is a risk of an accident.</p> <ul style="list-style-type: none"> ► Pull over and stop the vehicle safely as soon as possible, paying attention to road and traffic conditions. Do not continue driving under any circumstances. ► Secure the vehicle against rolling away (▷ page 182). ► Do not add brake fluid. Adding more will not remedy the malfunction. ► Consult a qualified specialist workshop. ► Observe the additional display messages in the multifunction display.





Problem	Possible causes/consequences and ► Solutions
 <p>The yellow ABS warning lamp is lit while the engine is running.</p>	<p>ABS (Anti-lock Braking System) is deactivated due to a malfunction. For this reason, BAS (Brake Assist), BAS PLUS, ESP® (Electronic Stability Program), PRE-SAFE®, PRE-SAFE® Brake, COLLISION PREVENTION ASSIST, the HOLD function, hill start assist and ESP® trailer stabilization are also deactivated, for example. ATTENTION ASSIST is deactivated.</p> <p> WARNING</p> <p>The brake system continues to function normally, but without the functions listed above. The wheels could therefore lock if you brake hard, for example.</p> <p>The steerability and braking characteristics may be severely affected. The braking distance in an emergency braking situation can increase.</p> <p>If ESP® is not operational, ESP® is unable to stabilize the vehicle. There is an increased risk of skidding and an accident.</p> <ul style="list-style-type: none"> ► Observe the additional display messages in the multifunction display. ► Drive on carefully. ► Visit a qualified specialist workshop. <p>If the ABS control unit is faulty, there is also a possibility that other systems, such as the navigation system or the automatic transmission, will not be available.</p>





Problem	Possible causes/consequences and ► Solutions
 <p>The yellow ABS warning lamp is lit while the engine is running.</p>	<p>ABS is temporarily unavailable. Therefore, BAS, BAS PLUS, ESP®, EBD (electronic brake force distribution), PRE-SAFE®, PRE-SAFE® Brake, COLLISION PREVENTION ASSIST, the HOLD function, hill start assist, and ESP® trailer stabilization, for example, are also deactivated.</p> <p>ATTENTION ASSIST is deactivated.</p> <p>Possible causes are:</p> <ul style="list-style-type: none"> • Self-diagnosis is not yet complete. • The on-board voltage may be insufficient. <p> WARNING</p> <p>The brake system continues to function normally, but without the functions listed above. The front and rear wheels could therefore lock if you brake hard, for example.</p> <p>The steerability and braking characteristics may be severely affected. The braking distance in an emergency braking situation can increase.</p> <p>If ESP® is not operational, ESP® is unable to stabilize the vehicle. There is a risk of an accident.</p> <p>► Carefully drive a suitable distance, making slight steering movements at a speed above 12 mph (20 km/h). The functions mentioned above are available again when the warning lamp goes out.</p> <p>If the warning lamp is still on:</p> <ul style="list-style-type: none"> ► Observe the additional display messages in the multifunction display. ► Drive on carefully. ► Visit a qualified specialist workshop.

Problem	Possible causes/consequences and ► Solutions
 <p>The yellow ABS warning lamp is lit while the engine is running. A warning tone also sounds.</p>	<p>EBD is malfunctioning. Therefore, ABS, BAS, BAS PLUS, ESP®, PRE-SAFE®, PRE-SAFE® Brake, COLLISION PREVENTION ASSIST, the HOLD function, hill start assist and ESP® trailer stabilization, for example, are not available either. ATTENTION ASSIST is deactivated.</p> <p> WARNING</p> <p>The brake system continues to function normally, but without the functions listed above. The front and rear wheels could therefore lock if you brake hard, for example.</p> <p>The steerability and braking characteristics may be severely affected. The braking distance in an emergency braking situation can increase.</p> <p>If ESP® is not operational, ESP® is unable to stabilize the vehicle. There is an increased risk of skidding and an accident.</p> <ul style="list-style-type: none"> ► Observe the additional display messages in the multifunction display. ► Drive on carefully. ► Visit a qualified specialist workshop.
<p> (USA only)</p> <p> (Canada only)</p> <p>  </p> <p>The red brake warning lamp, the yellow ESP® and ESP® OFF warning lamps and the yellow ABS warning lamp are lit while the engine is running.</p>	<p>ABS and ESP® are malfunctioning. Therefore, BAS, BAS PLUS, PRE-SAFE®, PRE-SAFE® Brake, COLLISION PREVENTION ASSIST, the HOLD function, hill start assist and ESP® trailer stabilization, for example, are also not available. ATTENTION ASSIST is deactivated.</p> <p> WARNING</p> <p>The brake system continues to function normally, but without the functions listed above. The front and rear wheels could therefore lock if you brake hard, for example.</p> <p>The steerability and braking characteristics may be severely affected. The braking distance in an emergency braking situation can increase.</p> <p>If ESP® is not operational, ESP® is unable to stabilize the vehicle. There is an increased risk of skidding and an accident.</p> <ul style="list-style-type: none"> ► Observe the additional display messages in the multifunction display. ► Drive on carefully. ► Visit a qualified specialist workshop.



Problem	Possible causes/consequences and ► Solutions
 <p>The yellow ESP® warning lamp flashes while the vehicle is in motion.</p>	<p>ESP® or traction control has intervened because there is a risk of skidding or at least one wheel has started to spin. Cruise control or DISTRONIC PLUS is deactivated.</p> <ul style="list-style-type: none"> ► When pulling away, only depress the accelerator pedal as far as necessary. ► Ease off the accelerator pedal while the vehicle is in motion. ► Adapt your driving style to suit the road and weather conditions. ► Do not deactivate ESP®. <p>In rare cases (► page 73), it may be best to deactivate ESP®.</p>
 <p>The yellow ESP® OFF warning lamp is lit while the engine is running.</p>	<p>ESP® is deactivated.</p> <p> WARNING</p> <p>If ESP® is switched off, ESP® is unable to stabilize the vehicle. There is an increased risk of skidding and an accident.</p> <ul style="list-style-type: none"> ► Reactivate ESP®. <p>In rare cases (► page 73), it may be best to deactivate ESP®.</p> <ul style="list-style-type: none"> ► Adapt your driving style to suit the road and weather conditions. <p>If ESP® cannot be activated:</p> <ul style="list-style-type: none"> ► Have ESP® checked at a qualified specialist workshop.
 <p>The yellow ESP® and ESP® OFF warning lamps are lit while the engine is running.</p>	<p>ESP®, BAS, BAS PLUS, PRE-SAFE®, PRE-SAFE® Brake, COLLISION PREVENTION ASSIST, the HOLD function, hill start assist and ESP® trailer stabilization are not available due to a malfunction. ATTENTION ASSIST is deactivated.</p> <p> WARNING</p> <p>The brake system continues to function normally, but without the functions listed above. The braking distance in an emergency braking situation can thus increase.</p> <p>If ESP® is not operational, ESP® is unable to stabilize the vehicle. There is an increased risk of skidding and an accident.</p> <ul style="list-style-type: none"> ► Observe the additional display messages in the multifunction display. ► Drive on carefully. ► Visit a qualified specialist workshop.

Problem	Possible causes/consequences and ► Solutions
  <p>The yellow ESP[®] and ESP[®] OFF warning lamps are lit while the engine is running.</p>	<p>ESP[®], BAS, PRE-SAFE[®], the HOLD function, hill start assist and ESP[®] trailer stabilization are temporarily unavailable. COLLISION PREVENTION ASSIST, BAS PLUS and PRE-SAFE[®] Brake may also have failed. ATTENTION ASSIST is deactivated. Self-diagnosis is not yet complete.</p> <p> WARNING</p> <p>The brake system continues to function normally, but without the functions listed above. The braking distance in an emergency braking situation can thus increase. If ESP[®] is not operational, ESP[®] is unable to stabilize the vehicle. There is an increased risk of skidding and an accident.</p> <p>► Carefully drive a suitable distance, making slight steering movements at a speed above 12 mph (20 km/h). The functions mentioned above are available again when the warning lamp goes out.</p> <p>If the warning lamp is still on:</p> <ul style="list-style-type: none"> ► Observe the additional display messages in the multifunction display. ► Drive on carefully. ► Visit a qualified specialist workshop.

Problem	Possible causes/consequences and ► Solutions
<p>  (USA only)  (Canada only) The red electric parking brake indicator lamp flashes or lights up and/or  warning lamp for the electric parking brake lights up. </p>	<p>► Observe the additional display messages in the multifunction display.</p>
<p>  The red restraint system warning lamp is lit while the engine is running. </p>	<p>The restraint system is faulty.</p> <p> WARNING</p> <p>The air bags or Emergency Tensioning Devices may either be triggered unintentionally or, in the event of an accident, may not be triggered.</p> <p>There is an increased risk of injury.</p> <p>► Observe the additional display messages in the multifunction display.</p> <p>► Drive on carefully.</p> <p>► Have the restraint system checked at a qualified specialist workshop immediately.</p> <p>For further information about the restraint system, see (► page 44).</p>

Engine	
Problem	Possible causes/consequences and ► Solutions
 <p>The yellow Check Engine warning lamp lights up while the engine is running.</p>	<p>There may be a malfunction, for example:</p> <ul style="list-style-type: none"> • in the engine management • in the fuel injection system • in the exhaust system • in the ignition system (for vehicles with gasoline engines) • in the fuel system <p>The emission limit values may be exceeded and the engine may be in emergency mode.</p> <p>► Have the vehicle checked as soon as possible at a qualified specialist workshop.</p> <p>i In some states, you must immediately visit a qualified specialist workshop as soon as the yellow Check Engine warning lamp lights up. This is due to the legal requirements in effect in these states. If in doubt, check whether such legal regulations apply in the state in which you are currently driving.</p> <p>Vehicles with a diesel engine: the fuel tank has been run dry (► page 180).</p> <p>► Start the engine three to four times after refueling. If the yellow Check Engine warning lamp goes out, emergency running mode is canceled. The vehicle need not be checked.</p>
 <p>The yellow reserve fuel warning lamp lights up while the engine is running.</p>	<p>The fuel level has dropped into the reserve range.</p> <p>► Refuel at the nearest gas station.</p>
 <p>The yellow reserve fuel warning lamp flashes while the vehicle is in motion.</p> <p>In addition, the  Check Engine warning lamp may light up.</p>	<p>The fuel system pressure is too low. The fuel filler cap is not closed correctly or the fuel system is leaking.</p> <p>► Check that the fuel filler cap is correctly closed.</p> <p>► If the fuel filler cap is not correctly closed: close the fuel filler cap.</p> <p>► If the fuel filler cap is closed: visit a qualified specialist workshop.</p>





Problem	Possible causes/consequences and ► Solutions
 <p>The red coolant warning lamp lights up while the engine is running and the coolant temperature gauge is at the start of the scale.</p>	<p>The temperature sensor for the coolant temperature gage is defective.</p> <p>The coolant temperature is no longer being monitored. There is a risk of engine damage if the coolant temperature is too high.</p> <ul style="list-style-type: none">► Pull over and stop the vehicle safely and switch off the engine, paying attention to road and traffic conditions. Do not continue driving under any circumstances.► Secure the vehicle against rolling away (▷ page 182).► Consult a qualified specialist workshop.

Problem	Possible causes/consequences and ► Solutions
 <p>The red coolant warning lamp comes on while the engine is running.</p>	<p>The coolant level is too low.</p> <p>! Avoid making long journeys with too little coolant in the engine cooling system. The engine will otherwise be damaged.</p> <p>If the coolant level is correct, the airflow to the engine radiator may be blocked or the electric engine radiator fan may be malfunctioning.</p> <p>The coolant is too hot and the engine is no longer being cooled sufficiently.</p> <ul style="list-style-type: none"> ► Observe the additional display messages in the multifunction display. ► Pull over and stop the vehicle safely and switch off the engine, paying attention to road and traffic conditions. ► Secure the vehicle against rolling away (► page 182). ► Leave the vehicle and keep a safe distance from the vehicle until the engine has cooled down. ► Check the coolant level and add coolant, observing the warning notes (► page 369). ► If you need to add coolant more often than usual, have the engine coolant system checked. ► Make sure that the air supply to the engine radiator is not blocked, e.g. by snow, slush or ice. ► Do not start the engine again until the coolant temperature is below 248 °F (120 °C). Otherwise, the engine could be damaged. ► Drive to the nearest qualified specialist workshop. ► Avoid subjecting the engine to heavy loads, e.g. driving in mountainous terrain, and stop-and-go traffic.
 <p>The red coolant warning lamp comes on while the engine is running. A warning tone also sounds.</p>	<p>The coolant temperature has exceeded 248 °F (120 °C). The airflow to the engine radiator may be blocked or the coolant level may be too low.</p> <p>▲ WARNING</p> <p>The engine is not being cooled sufficiently and may be damaged. Do not drive when your engine is overheated. This can cause some fluids which may have leaked into the engine compartment to catch fire.</p> <p>Steam from the overheated engine can also cause serious burns which can occur just by opening the hood.</p> <p>There is a risk of injury.</p>

Problem	Possible causes/consequences and ► Solutions
	<ul style="list-style-type: none"> ► Observe the additional display messages in the multifunction display. ► Pull over and stop the vehicle safely and switch off the engine, paying attention to road and traffic conditions. ► Secure the vehicle against rolling away (▷ page 182). ► Leave the vehicle and keep a safe distance from the vehicle until the engine has cooled down. ► Check the coolant level and add coolant, observing the warning notes (▷ page 369). ► If you need to add coolant more often than usual, have the engine coolant system checked. ► Make sure that the air supply to the engine radiator is not blocked, e.g. by snow, slush or ice. ► At coolant temperatures below 248 °F (120 °C), drive to the nearest qualified specialist workshop. ► Avoid subjecting the engine to heavy loads, e.g. driving in mountainous terrain, and stop-and-go traffic.

Driving systems

Problem	Possible causes/consequences and ► Solutions
 <p>The red distance warning function warning lamp comes on while the vehicle is moving. A warning tone also sounds.</p>	<p>You are approaching a vehicle or a stationary obstacle in your line of travel at too high a speed.</p> <ul style="list-style-type: none"> ► Be prepared to brake immediately. ► Pay careful attention to the traffic situation. You may have to brake or take evasive action. <p>Further information on DISTRONIC PLUS (▷ page 198). Further information on PRE-SAFE® Brake (▷ page 75). Further information on the distance warning function (▷ page 70).</p>

Tires	
Problem	Possible causes/consequences and ► Solutions
 <p>The yellow tire pressure monitor warning lamp (pressure loss/malfunction) is lit.</p>	<p>The tire pressure monitor has detected a loss of pressure in at least one of the tires.</p> <p> WARNING</p> <p>With tire pressures which are too low, there is a risk of the following hazards:</p> <ul style="list-style-type: none"> • they may burst, especially as the load and vehicle speed increase. • they may wear excessively and/or unevenly, which may greatly impair tire traction. • the driving characteristics, as well as steering and braking, may be greatly impaired. <p>There is a risk of an accident.</p> <ul style="list-style-type: none"> ► Stop the vehicle without making any sudden steering or braking maneuvers. Pay attention to the traffic conditions as you do so. ► Secure the vehicle against rolling away (▷ page 182). ► Observe the additional display messages in the multifunction display. ► Check the tires and, if necessary, follow the instructions for a flat tire (▷ page 383). ► Check the tire pressure (▷ page 408). ► If necessary, correct the tire pressure.
 <p>The yellow tire pressure monitor warning lamp (pressure loss/malfunction) flashes for approximately one minute and then remains lit.</p>	<p>The tire pressure monitor is faulty.</p> <p> WARNING</p> <p>The system is possibly unable to recognize or register low tire pressure.</p> <p>There is a risk of an accident.</p> <ul style="list-style-type: none"> ► Observe the additional display messages in the multifunction display. ► Visit a qualified specialist workshop.

Useful information	334
Stowage areas	334
Features	345

Useful information

- i** This Operator's Manual describes all models and all standard and optional equipment of your vehicle available at the time of publication of the Operator's Manual. Country-specific differences are possible. Please note that your vehicle may not be equipped with all features described. This also applies to safety-related systems and functions.
- i** Read the information on qualified specialist workshops (▷ page 29).

Stowage areas

Loading guidelines

WARNING

If objects, luggage or loads are not secured or not secured sufficiently, they could slip, tip over or be flung around and thereby hit vehicle occupants. There is a risk of injury, particularly in the event of sudden braking or a sudden change in direction.

Always store objects so that they cannot be flung around. Secure objects, luggage or loads against slipping or tipping before the journey.

WARNING

Combustion engines emit poisonous exhaust gases such as carbon monoxide. If the tailgate is open when the engine is running, particularly if the vehicle is moving, exhaust fumes could enter the passenger compartment. There is a risk of poisoning.

Turn off the engine before opening the tailgate. Never drive with the tailgate open.

WARNING

The exhaust tail pipe and tail pipe trim can become very hot. If you come into contact with these parts of the vehicle, you could burn yourself. There is a risk of injury.

Always be particularly careful around the exhaust tail pipe and the tail pipe trim. Allow these components to cool down before touching them.

The gross vehicle weight (GVW) is the vehicle weight including fuel, vehicle tool kit, spare wheel, installed accessories, vehicle occupants and luggage/cargo.

The gross load limit and the gross vehicle weight rating (GVWR) for your vehicle must never be exceeded. The gross load limit and the GVWR are specified on the vehicle identification plate on the B-pillar of the driver's door (▷ page 412).

The load must also be distributed so that the weight on each axle never exceeds the gross axle weight rating (GAWR) for the front and rear axles. The specifications for GVWR and GAWR are on the vehicle identification plate on the B-pillar of the driver's door (▷ page 412).

Observe the notes on loading the vehicle (▷ page 412).

The handling characteristics of a laden vehicle are dependent on the distribution of the load within the vehicle. For this reason, you should observe the following notes when transporting a load:

- Never exceed the maximum permissible gross vehicle weight or the gross axle weight rating of the vehicle (including occupants).
- The cargo compartment is the preferred place to carry objects.
- Position heavy loads as far forwards as possible and as low down in the cargo compartment as possible.
- The load must not protrude above the upper edge of the seat backrests.
- Always place the load against the rear or front seat backrests. Make sure that the seat backrests are securely locked into place.
- Always place the load behind unoccupied seats if possible.

- Use the cargo tie-down rings and the parcel nets to transport loads and luggage.
- Use cargo tie-down rings and fastening materials appropriate for the weight and size of the load.
- Hook in the cargo net when loading.
- Secure the load with sufficiently strong and wear-resistant tie-downs. Pad sharp edges for protection.

Stowage space

Important safety notes

WARNING

If objects in the passenger compartment are stowed incorrectly, they can slide or be thrown around and hit vehicle occupants. There is a risk of injury, particularly in the event of sudden braking or a sudden change in direction.

- Always stow objects so that they cannot be thrown around in such situations.
- Always make sure that objects do not protrude from stowage spaces, parcel nets or stowage nets.
- Close the lockable stowage spaces while driving.
- Stow and secure objects that are heavy, hard, pointy, sharp-edged, fragile or too large in the cargo compartment.

Observe the loading guidelines (▷ page 334).

Glove box



- ▶ **To open:** pull handle ① and open glove box flap ②.
- ▶ **To close:** fold glove box flap ② upwards until it engages.

 The glove box can be cooled (▷ page 153).



- ① Glove box unlocked
- ② Glove box locked

The glove box can be locked and unlocked using the mechanical key.



Partition ① for stowing flat objects is located in the upper section of the glove box. It can be removed to increase the stowage space in the glove box.

- ▶ **To remove:** pull partition ① forwards and out
- ▶ **To install:** insert partition ① and push it back until it engages.

Stowage compartment under the armrest

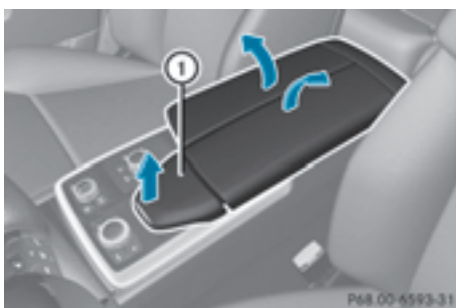

- ▶ **To open:** pull handle ① up. The armrest folds out.

In the stowage compartment, there is a stowage tray.

- ⓘ Depending on the vehicle equipment, a USB connection or a Media Interface is installed in the stowage compartment. A Media Interface is a universal interface for mobile audio equipment, e.g. for an iPod® or MP3 player (see the separate COMAND Operating Instructions).
- ⓘ There is a removable stowage tray in the storage compartment, in which objects such as an iPod® can be stored.

Eyeglasses compartment



- ▶ **To open:** press marking ①. The eyeglasses compartment opens downwards.
- ▶ **To close:** press marking ① again and the eyeglasses compartment returns upwards and engages.

Make sure that the eyeglasses compartment is always closed while the vehicle is in motion.

Stowage compartment in the front center console



- ▶ **To open:** slide cover ① forwards. Stowage compartment ② appears.
- ▶ **To close:** pull cover ① back as far as it will go.

Stowage compartment in the rear center console



- ▶ **To open:** briefly press the stowage compartment marking. The stowage compartment opens.

- i** Depending on the vehicle's equipment, there may be open stowage spaces above and below the stowage compartment.

Stowage net

WARNING

Vehicles with the Occupant Classification System (OCS):

If the gross weight of the objects in the stowage net on the back of the front-passenger seat is greater than 4.4 lb (2 kg), OCS cannot correctly assess the occupant's weight category. The front-passenger front air bag could deploy without cause, or may fail to deploy in the event of an accident. This poses an increased risk of injury or even fatal injury.

Never exceed the permissible gross weight of 4.4 lb (2 kg). Stow and secure heavy objects in the cargo compartment.

Stowage nets are located in the front-passenger footwell and on the back of the driver's and the front-passenger seat.

Observe the loading guidelines (▷ page 334) and the safety notes regarding stowage spaces (▷ page 335).

Through-loading facility in the rear

If objects or loads are not secured when being transported in the through-loading facility, they could slip or be thrown around and thereby hit vehicle occupants.

Observe the loading guidelines (▷ page 334) and the safety notes regarding stowage spaces (▷ page 335).

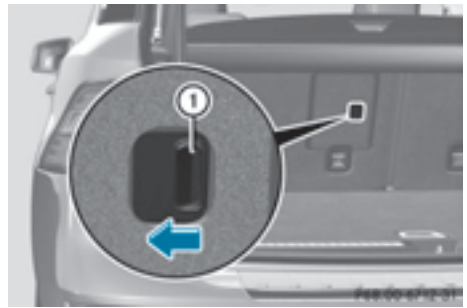

The through-loading facility is opened from the cargo compartment.

- ▶ Release the seat backrests in the second row of seats and tilt them in the cargo/load position (▷ page 108).
- ▶ Fold down the rear seat armrest.
- ▶ Pull the center head restraint on the rear bench seat into the uppermost position (▷ page 106).
- ▶ Slide release catch ① to the left and swing flap ② to the left until it is lying on the rear side of the rear bench seat.

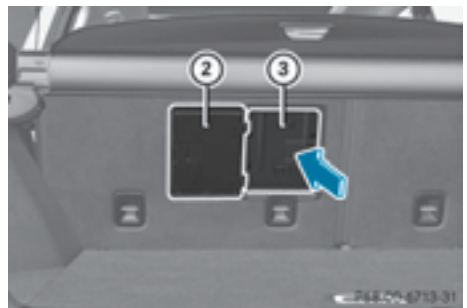

- ▶ Push cover ③ forward until it is lying on the rear seat armrest.

Cargo compartment enlargement

Important safety notes

WARNING

If the rear bench seat/rear seat and seat backrest are not engaged they could fold for-

wards, e.g. when braking suddenly or in the event of an accident.

- The vehicle occupant would thereby be pushed into the seat belt by the rear bench seat/rear seat or by the seat backrest. The seat belt can no longer offer the intended level of protection and could even cause injuries.
- Objects or loads in the trunk/cargo compartment cannot be restrained by the seat backrest.

There is an increased risk of injury.

Before every trip, make sure that the seat backrests and the rear bench seat/rear seat are engaged.

- ❗ Fold the seat cushion upwards before folding the rear bench seat forward. Otherwise, the backrests may be damaged.

When the backrest is folded forwards, the front seats should not be moved to their rearmost position. Otherwise, the front seats and the rear bench seat could be damaged.

Observe the loading guidelines (▷ page 334).

The left-hand and right-hand rear seat backrests can be folded forwards separately to increase the cargo compartment capacity.

Folding the rear bench seat forwards

- ❗ The backrest is heavy. Therefore, take care when folding it down. Make sure that the head restraints are pushed all the way in so that the backrests and seat cushions are not damaged.



- ❗ If the driver's or front-passenger seat is set for a larger person, it may not be possible to fold the rear bench seat forwards. In this case, move the front seats as far forward as possible.

- ▶ Move the head restraints to the lowest position (▷ page 108).
- ▶ Fold seat cushion ① upwards.



- ▶ Pull release handle ② upwards in the direction of the arrow until the backrest is fully released.
- ▶ Fold the backrest forwards until it reaches the cargo compartment position.

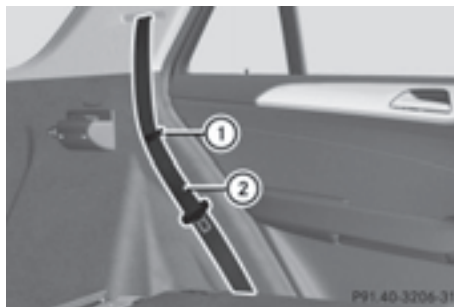

- ▶ Guide seat belts ② under respective clips ①.

Folding the rear bench seat back



- ▶ Fold seat backrest ② back until it engages. Make sure not to trap the seat belt while doing so.
- ▶ Swing seat cushion ① back.
- ▶ Pull up and adjust the head restraints if necessary (▶ page 108).

Securing cargo

Cargo tie-down rings

General notes

WARNING

The Top Tether anchorages cannot secure a load. If you secure a load with the Top Tether anchorages, the Top Tether anchorages could be pulled out during braking, abrupt changes in direction or in the event of an accident. The load could slip, tip over or be flung around and thereby hit vehicle occupants. There is a risk of injury.

Only use the cargo tie down rings when securing a load.

Observe the following notes on securing loads:

- Secure the load using the cargo tie-down rings.
- Distribute the load on the cargo tie-down rings evenly.
- Do not use elastic straps or nets to secure a load, as these are only intended as an anti-slip protection for light loads.

- Do not route tie-downs across sharp edges or corners.
- Pad sharp edges for protection.

Cargo compartment

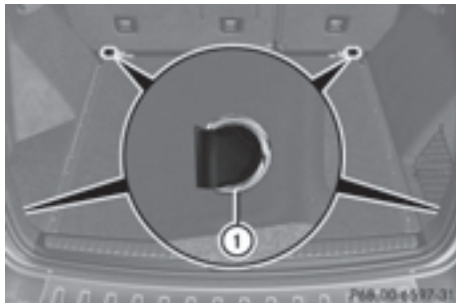

There are four cargo tie-down rings ① in the cargo compartment.

Before using the cargo tie-down rings on the front right-hand side of the cargo compartment, the stowage net must be pushed down.

Bag hook

WARNING

The bag hooks cannot restrain heavy objects or items of luggage. Objects or items of luggage could be flung around and thereby hit vehicle occupants when braking or abruptly changing directions. There is a risk of injury. Only hang light objects on the bag hooks. Never hang hard, sharp-edged or fragile objects on the bag hooks.

- ❗ The bag hook can bear a maximum load of 6.6lbs (3kg) and should not be used to secure a load.



There is a bag hook in the cargo compartment on the left-hand side.

- ▶ Press bag hook marking ①.
- ▶ Turn bag hook ① until it engages.

Securing hooks

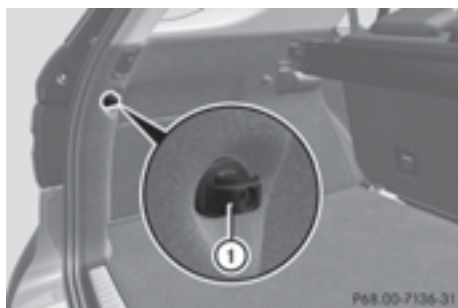

There is one securing hook ① on each side of the cargo compartment.

Only secure lightweight luggage items on the securing hooks (maximum 9 lbs (4 kg)).

Cargo compartment cover

Important safety notes

WARNING

On its own, the cargo compartment cover cannot secure or restrain heavy objects, items of luggage and heavy loads. You could be hit by an unsecured load during sudden changes in direction, braking or in the event of an accident. There is an increased risk of injury or even fatal injury.

Always store objects so that they cannot be flung around. Secure objects, luggage or loads against slipping or tipping over, e.g. by using tie downs, even if you are using the cargo compartment cover.

- ❗ When loading the vehicle, make sure that you do not stack the load in the cargo compartment higher than the lower edge of the side windows. Do not place heavy objects on top of the cargo compartment cover.

A cargo compartment cover or a combined cargo cover and net (cargo compartment cover with cargo net) is installed, depending on equipment, behind the rear bench seat backrest.

Extending/retracting the cargo compartment cover

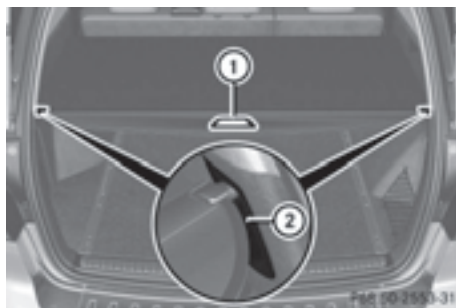

- ▶ **To extend:** pull the cargo compartment cover back by grab handle ① and clip it into retainers ② on the left and right.
- ▶ **To retract:** unhook the cargo compartment cover from left-hand and right-hand retainers ②.
- ▶ Guide cargo compartment cover forwards by grab handle ① until it is completely rolled up.

Removing/installing the cargo compartment cover (without integrated cargo net)

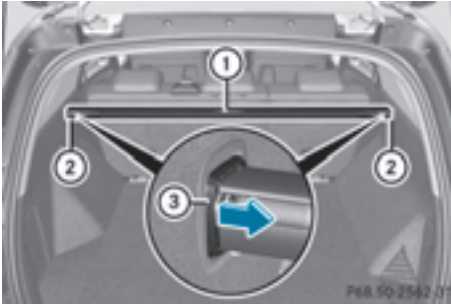

- ▶ **To remove:** make sure that cargo compartment cover ① is rolled up.
- ▶ Push end cap ③ of cargo compartment cover ① in the direction of the arrow on the right or left-hand side.
- ▶ Push cargo compartment cover ① into opposite anchorage ②.
- ▶ Remove cargo compartment cover ①.
- ▶ **To install:** if installed, remove the protective caps from the side panels of the seat row in which the cargo compartment cover is to be installed. Use a suitable object here, e.g. a coin.
- ▶ Install the protective caps to the side panels of the other seat row.
- ▶ Place cargo compartment cover ① into anchorage ② on the right or left-hand side.
- ▶ Push in opposite end cap ③ of cargo compartment cover ① in the direction of the arrow and insert cargo compartment cover ① into opposite anchorage ②.

Removing/installing the combined cargo cover and net (cargo compartment cover with integrated cargo net)

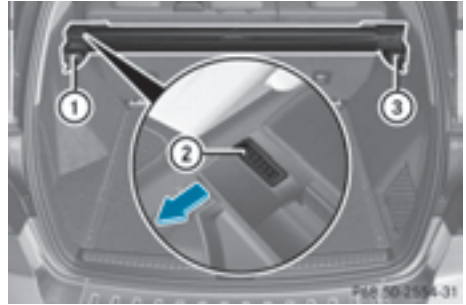

- You can install and remove the combined cargo cover and net from the cargo compartment.
- ▶ Make sure that the cargo net and the cargo compartment cover are rolled up.
 - ▶ **To remove:** press button ②.
 - ▶ Swing the combined cargo cover and net in the direction of the arrow.
 - ▶ First, detach the combined cargo cover and net from left-hand catch ① and then remove it from right-hand fixture ③.
 - ▶ **To install:** push the combined cargo cover and net up to the stop into right-hand fixture ③.
 - ▶ Place the combined cargo cover and net into the left-hand fixture and push it into catch ① until the combined cargo cover and net engages audibly.



- ▶ Make sure that red lock status indicator ④ is no longer visible. The combined cargo

cover and net will otherwise not be locked in place.

Cargo net in combined cargo cover and net

Important safety notes

WARNING

On its own, the cargo net cannot secure or restrain heavy objects, items of luggage and heavy loads. You could be hit by an unsecured load during sudden changes in direction, braking or in the event of an accident. There is an increased risk of injury or even fatal injury.

Always store objects so that they cannot be flung around. Secure objects, luggage or loads against slipping or tipping over, e.g. by using tie downs, even if you are using the cargo net.

It is important to use a cargo net if you load the vehicle with small objects above the seat backrests. For safety reasons, always use a cargo net when transporting loads.

Attaching the cargo net

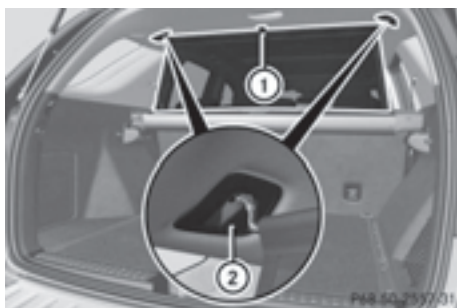

- ▶ Pull the cargo net up by tab ① and hook it into eyelets ② using both hands.

Coat hooks on the tailgate

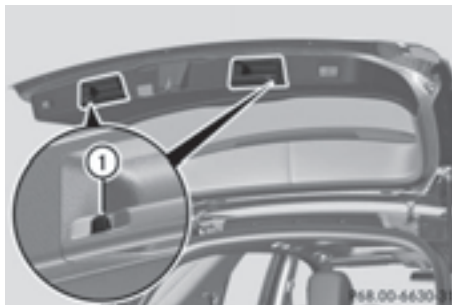

- ① Coat hook

EASY-PACK load-securing kit

Components and storage

The EASY-PACK load-securing kit allows you to use your cargo compartment for a variety of purposes. The accessory parts are located under the cargo compartment floor.

- ▶ Open the trunk floor (▷ page 344).

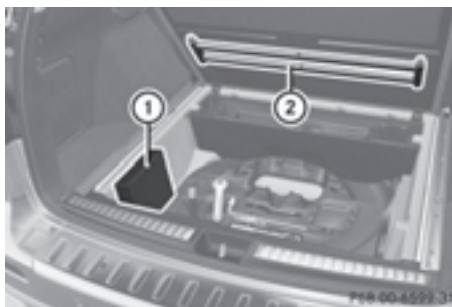

EASY-PACK load-securing kit accessory parts

- ① Bag containing the brackets and luggage holder
- ② Telescopic rod

Inserting the brackets into the loading rail

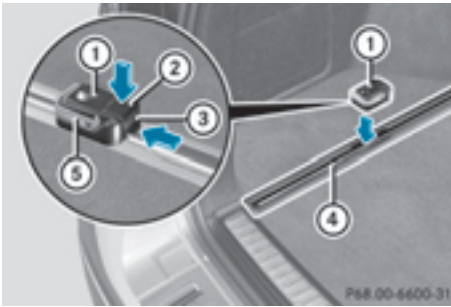

- ▶ Insert bracket ① into the center of loading rail ④.
- ▶ Press release button ② and push bracket ① into the desired position in loading rail ④.
- ▶ Let go of release button ②.
- ▶ Press locking button ③. Bracket ① is locked in loading rail ④.
- ▶ If necessary, fold cargo tie-down ring ⑤ upwards.

Luggage holder

! Only use the luggage holder to secure cargo with a maximum weight of 15.4 lbs (7 kg) and with dimensions that the luggage holder can safely and securely contain.

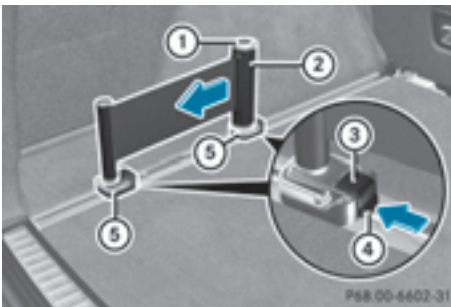

The luggage holder can be used to secure light loads against the side wall of the cargo compartment to prevent them from moving around.

- ▶ **To install:** insert two brackets ⑤ into the left or right loading rail (▷ page 342).
- ▶ Press release button ① of the luggage holder and pull the strap out slightly.
- ▶ Insert luggage holder ② into brackets ⑤ and, while doing so, press release button ③ and push the luggage holder downwards until it engages.
- ▶ Press release button ① of the luggage holder and pull the strap out in the direction of the arrow.
- ▶ Place the load between the strap and the cargo compartment side wall.
- ▶ Using one hand, press locking button ① of the luggage holder.
- ▶ With your other hand, let the strap go slowly until the load is secured.
- ▶ Make sure that locking button ④ on brackets ⑤ is pressed. This keeps brackets ⑤ in place on the loading rail.
- ▶ **To remove:** press release button ③ on respective bracket ⑤ and remove luggage holder ② by pulling upwards and out.

Telescopic rod

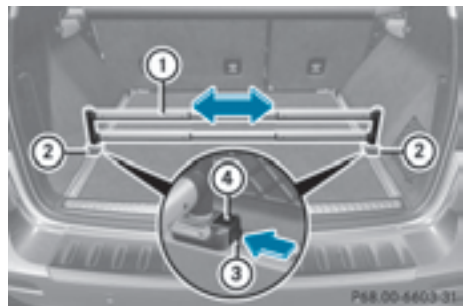

The telescopic rod can be used to secure the load against the rear seats to prevent it from moving around.

- ▶ **To install:** insert one bracket ② into both the left and the right loading rails and slide it to the desired position (▷ page 342).
- ▶ Insert telescopic rod ① into brackets ② and, while doing so, press release but-

ton ④ and push the rod downwards until it engages.

- ▶ Make sure that locking button ③ on brackets ② is pressed. This keeps brackets ② in place on the loading rail.
- ▶ **To remove:** press release button ④ on respective bracket ② and remove telescopic rod ① by pulling it upwards and out.



- ▶ Fold out hook ③ on the underside of the cargo compartment floor in the direction of the arrow.

Stowage well under the cargo compartment floor

WARNING

If you drive when the cargo compartment floor is open, objects could be flung around, thus striking vehicle occupants. There is a risk of injury, particularly in the event of sudden braking or a sudden change in direction.

Always close the cargo compartment floor before a journey.

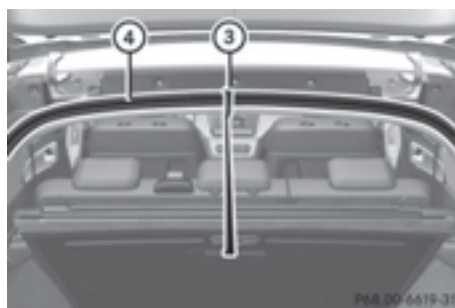

- ▶ Attach hook ③ to the cargo compartment's upper seal ④.
- ▶ **To close:** detach hook ③ from the cargo compartment's upper seal ④.
- ▶ Fasten hook ③ to the bracket on the underside of the cargo compartment floor.
- ▶ Fold the trunk floor down.
- ▶ Press the cargo compartment floor down ② until it engages.



A removable insert under the cargo compartment floor contains the parts of the EASY-PACK load-securing kit. The tire-change tool kit is stored beneath this insert.

- ▶ **To open:** holding the ribbing, press handle ① downwards ②. Handle ① folds up.
- ▶ Swing the cargo compartment floor upwards using handle ① until it rests against the cargo compartment cover.

- ▶ **i** To remove the cargo compartment floor, undo the press studs below the cargo compartment floor. When you re-install the cargo compartment floor, fasten it with the press studs.

Roof carrier

Important safety notes

WARNING

When you load the roof, the center of gravity of the vehicle rises and the driving characteristics change. If you exceed the maximum roof load, the driving characteristics, as well as steering and braking, will be greatly impaired. There is a risk of an accident.

Never exceed the maximum roof load and adjust your driving style.

- !** Mercedes-Benz recommends that you only use roof carriers that have been tested and approved for Mercedes-Benz vehicles. This helps to prevent damage to the vehicle.

Position the load on the roof carrier in such a way that the vehicle will not sustain damage even when it is in motion.

Depending on the vehicle equipment, ensure that when the roof carrier is installed you can:

- raise the sliding sunroof fully
- open the panorama roof with power tilt/sliding panel fully
- open the tailgate fully

The maximum roof load is 220 lbs(100 kg).

Attaching the roof carrier



- ▶ Secure the roof carrier to roof rails **①**. In doing so, observe the manufacturer's installation instructions.

Features

Cup holder

Important safety notes

WARNING

If objects in the passenger compartment are stowed incorrectly, they can slide or be thrown around and hit vehicle occupants. There is a risk of injury, particularly in the event of sudden braking or a sudden change in direction.

- Always stow objects so that they cannot be thrown around in such situations.
- Always make sure that objects do not protrude from stowage spaces, parcel nets or stowage nets.
- Close the lockable stowage spaces while driving.
- Stow and secure objects that are heavy, hard, pointy, sharp-edged, fragile or too large in the cargo compartment.

Observe the loading guidelines (▷ page 334).

- !** Only use the cup holders for containers of the right size and which have lids. The drinks could otherwise spill.

Do not keep the KEYLESS-GO key in the temperature-controlled cup holder (▷ page 346). Otherwise, the KEYLESS-GO key will not be recognized.

The stowage compartments in the doors provide space for bottles with a capacity of up to 34 fl. oz. (1.0 l).

The bottles are not secured or prevented from tipping over. Therefore, do not place any open drink containers in the stowage compartments.

Cup holder in the front-compartment center console



- ① Cup holder
- ② Cover

- ▶ **To open:** slide cover ② to its foremost position.
- ▶ **To close:** pull cover ② back as far as it will go.

You can remove the cup holder's rubber mat for cleaning. Clean with clear, lukewarm water only.

Temperature-controlled cup holder in the front-compartment center console



- ① Cup holder
- ② Residual heat indicator lamp
- ③ Switch

The temperature-controlled cup holder can be used to keep cold drinks cool and warm drinks warm.

- ▶ Turn the SmartKey to position **2** in the ignition lock.
- ▶ **To switch on the cooling function:** press and hold button ③ until the blue indicator lamp on the button lights up.
- ▶ **To switch on the heating function:** press and hold button ③ until the red indicator lamp on the button lights up.
- ▶ **To switch off the function:** press and hold button ③ until the indicator lamp on the button goes out.

When the heating function is used, the metal insert of the cup holder is heated. Once a certain temperature is reached, residual heat indicator lamp ② lights up. This means that the metal insert of the cup holder is hot. For this reason, you must not reach into the cup holder metal insert.

Do not use hard or sharp objects to clean the cup holder. Use only a soft cloth to clean it.

Cup holder in the rear seat armrest

- ⚠ Do not sit on or support your body weight on the rear seat armrest when it is folded down, as you could otherwise damage it.



- ▶ Fold down the rear seat armrest. Cup holder ① is located in the rear seat armrest.

Sun visors

Overview

WARNING

If the mirror cover of the vanity mirror is folded up when the vehicle is in motion, you could be blinded by incident light. There is a risk of an accident.

Always keep the mirror cover folded down while driving.

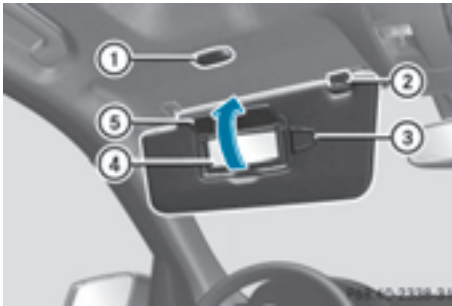

- ① Mirror light
- ② Bracket
- ③ Retaining clip, e.g. for a car park ticket
- ④ Vanity mirror
- ⑤ Mirror cover

Vanity mirror in the sun visor

Mirror light ① only functions if the sun visor is clipped into bracket ② and mirror cover ⑤ has been folded up.

Glare from the side

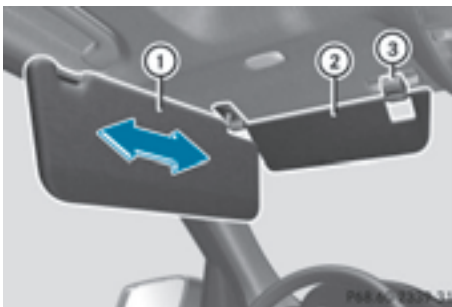

- ▶ Fold down sun visor ①.
- ▶ Pull sun visor ① out of retainer ③.
- ▶ Swing sun visor ① to the side.
- ▶ Slide sun visor ① horizontally as required.
- ▶ Fold down additional sun visor ② to the windshield.

Roller sunblinds on the rear side windows

! Always guide the roller sunblind by hand. Do not let it snap back suddenly as this would damage the automatic roller mechanism.

! Do not drive the vehicle with the roller sunblind hooked in and the side windows opened simultaneously. The roller sunblind can jump out of the retainers and spring back suddenly when driving at high speeds, e.g. when driving on the freeway. This could damage the inertia reel. Therefore, either close the side window or retract the roller sunblind before driving at high speeds.

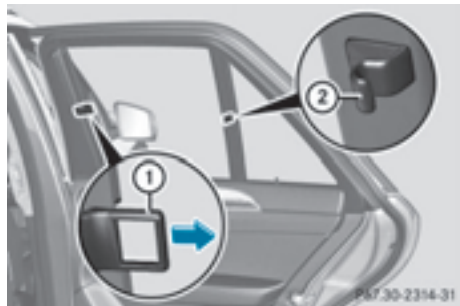

- ▶ **To extend:** pull the roller sunblind out by tab ① and hook it onto retainers ② at the back of the window.

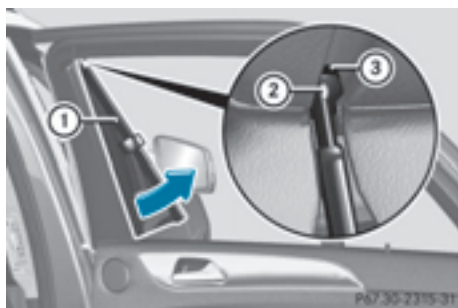

The roller sunblind can be hooked back into place should it pop out from the top of the guide rail.

- ▶ Tilt pull-out profile ① as illustrated.
- ▶ Slip guide bush ② into open area of guide rail ③.
- ▶ Straighten up pull-out profile ① again.

Ashtray

Front ashtray

- ❗ The holder under the ashtray is not heat resistant. Before placing lit cigarettes in the ashtray, make sure that the ashtray is properly engaged. Otherwise, the holder could be damaged.

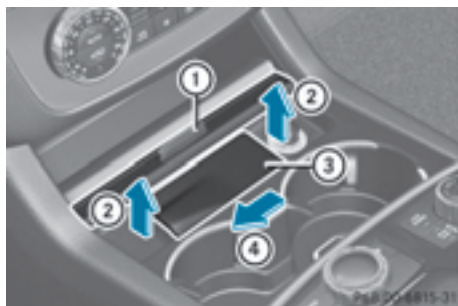

- ▶ **To open:** slide cover ① to its foremost position.
- ▶ Fold cover ② of the insert upwards.
- ▶ **To remove the insert:** push insert ③ to the left ④.
- ▶ Insert ③ slides out slightly to the right.
- ▶ Lift insert ③ up ② and out.

- ▶ **To re-install the insert:** place insert ③ into the holder and press it down on the right until it engages.
- ▶ **To close:** pull cover ① back as far as it will go.

Rear-compartment ashtray

- ❗ Close the ashtray when it is not in use and before you fold the rear seats forward. You can otherwise damage the ashtray.

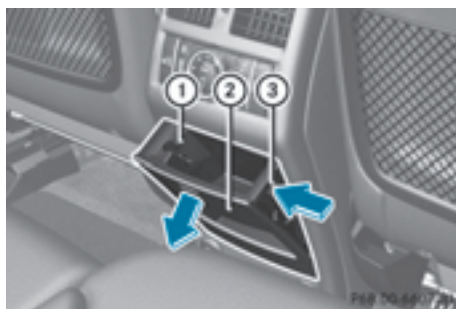

- ▶ **To open:** briefly press cover ② at the top. The ashtray opens.
- ▶ **To remove the insert:** push into recess ③ from the right.
- ▶ Ashtray insert ① slides out slightly to the right.
- ▶ Lift insert ① up and out.
- ▶ **To re-install the insert:** place insert ① into the holder and press down on the right until it engages.

Vehicles without a Rear Seat Entertainment System have an ashtray in the center console in the rear compartment.

Cigarette lighter

⚠ WARNING

You can burn yourself if you touch the hot heating element or the socket of the cigarette lighter.

In addition, flammable materials can ignite if:

- the hot cigarette lighter falls
- a child holds the hot cigarette lighter to objects, for example

There is a risk of fire and injury.

Always hold the cigarette lighter by the knob. Always make sure that the cigarette lighter is out of reach of children. Never leave children unsupervised in the vehicle.

- !** The cigarette lighter in the center console in the front compartment is not intended for operating the tire inflation compressor.



Your attention must always be focused on the traffic conditions. Only use the cigarette lighter when road and traffic conditions permit.

- ▶ Turn the SmartKey to position **2** in the ignition lock (▷ page 157).
- ▶ **To open:** slide cover **1** to its foremost position.
- ▶ Press in cigarette lighter **2**. Cigarette lighter **2** will pop out automatically when the heating element is red-hot.
- ▶ **To close:** pull cover **1** back as far as it will go.

12 V sockets

General notes

- ▶ Turn the SmartKey to position **1** in the ignition lock (▷ page 157).

With the exception of the socket in the front center console, all sockets can be used for accessories with a maximum current draw of 240 W (20 A). The socket in the front center console can be used for accessories with a maximum current draw of 180 W (15 A). Accessories include such items as lamps or chargers for mobile phones.

If you use the sockets for long periods when the engine is switched off, the battery may discharge.

- i** An emergency cut-out ensures that the on-board voltage does not drop too low. If the on-board voltage is too low, the power to the sockets is automatically cut. This ensures that there is sufficient power to start the engine.

Socket in the front-compartment center console

- !** The socket is not suitable for operating the tire inflation compressor.



- ▶ **To open:** slide cover **1** to its foremost position.
- ▶ Lift up the cover of socket **2**.
- ▶ **To close:** pull cover **1** back as far as it will go.

Socket in the rear-compartment center console



- ▶ Lift up the cover of socket ①.

Vehicles with the Rear Seat Entertainment System have two sockets in the center console in the rear compartment.

Socket in the cargo compartment



- ▶ Lift up the cover of socket ①.

115 V socket

Important safety notes

DANGER

When a suitable device is connected, the 115 V power socket will be carrying a high voltage. You could receive an electric shock if the connector cable or the 115 V power socket is pulled out of the trim or is damaged or wet. There is a risk of fatal injury.

- Use only connector cables that are dry and free of damage.
- When the ignition is off, make sure that the 115 V power socket is dry.
- Have the 115 V power socket checked or replaced immediately at a qualified specialized workshop if it is damaged or has been pulled out of the trim.
- Never plug the connector cable into a 115 V power socket that is damaged or has been pulled out of the trim.

DANGER

If you reach into the power socket or plug inappropriate devices into the power socket, you could receive an electric shock. There is a risk of fatal injury.

Only connect appropriate devices to the power socket.

- ⚠ Note that work and repairs on the 115 V power socket should only be carried out by qualified specialist personnel.

General notes

115 V power socket provides an alternating voltage of 115 V so that small electronic devices can be connected. These devices, such as games consoles, chargers and laptops, should not consume more than a maximum of 150 watts altogether.

Requirements for operation of these devices:

- the electronic device that you connect has a suitable connector and conforms to standards specific to the country you are in.
- the plug of the electronic device is plugged correctly into 115 V power socket.
- the maximum wattage of the device to be connected must not exceed 150 watts.
- the on-board power supply is within a permissible voltage range.
- the 12 V sockets in the rear compartment and the cargo compartment are operational.

Using the 115 V power socket

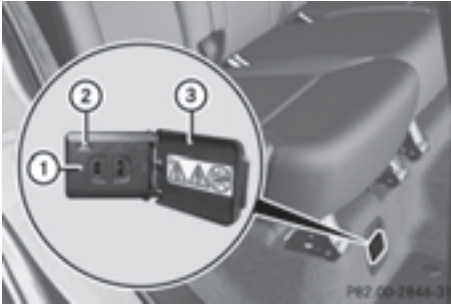

- ▶ **To switch on:** switch the ignition on.
- ▶ Open flap ③.
- ▶ Insert the plug of the electronic device into 115 V power socket ①. Indicator lamp ② lights up.
- ▶ **To turn off:** disconnect the plug from 115 V power socket ①. Ensure that you do not pull on the cord.

Problems with the 115 V power socket

Problem	Possible causes/consequences and ► Solutions
The warning lamp on the 115 V power socket is not lit.	The on-board voltage is too low because the battery is too weak. ► Start the engine. or ► Charge the battery (▷ page 389). If the indicator lamp still does not light up: ► Visit a qualified specialist workshop.
	The temperature of the DC/AC converter is temporarily too high. ► Remove the electronic device connector from the 115 V socket. ► Let the DC/AC converter cool down. If the indicator lamp still does not light up after cooling down the converter: ► Visit a qualified specialist workshop.
	You have connected an electronic device that has a constant nominal power of less than 150 watts, but a very high switch-on current. This device will not work. If you connect such a device, the 115 V power socket will not supply it with power. ► Connect a suitable device.

mbrace

General notes

You must have a license agreement to activate the mbrace service. Make sure that your system is activated and operational. To log in, press the  MB Info call button. If any of the steps mentioned are not carried out, the system may not be activated.

If you have questions about the activation, contact one of the following telephone hot-lines:

- **USA:** Mercedes-Benz Customer Assistance Center at 1-800-FOR-MERCEdes (1-800-367-6372) or 1-866-990-9007
- **Canada:** Customer Service at 1-888-923-8367

Shortly after successfully registering with the service, a user ID and password will be sent to you by post.



USA only: you can use this password to log onto the mbrace area under "Owners Online" at <http://www.mbusa.com>.

The system is available if:

- it has been activated and is operational
 - the corresponding mobile phone network is available for transmitting data to the Customer Center
 - a service subscription is available
 - the starter battery is sufficiently charged
- i** Determining the location of the vehicle on a map is only possible if:
- GPS reception is available.
 - the vehicle position can be forwarded to the Customer Assistance Center.

The mbrace system

To adjust the volume during a call, proceed as follows:

- ▶ Press the  or  button on the multifunction steering wheel.

or

- ▶ Use the volume controller of the audio system/COMAND.

The system offers various services, e.g.:





- Automatic and manual emergency call
- Roadside Assistance call
- MB Info call

USA only: you can find information and a description of all available features under "Owners Online" at <http://www.mbusa.com>.

System self-test

After you have switched on the ignition, the system carries out a self-diagnosis.

A malfunction in the system has been detected if one of the following occurs:

- The indicator lamp in the SOS button does not come on during the system self-test.
- The indicator lamp in the  Roadside Assistance button does not light up during self-diagnosis of the system.
- The indicator lamp in the  MB Info call button does not light up during self-diagnosis of the system.
- The indicator lamp in one or more of the following buttons continues to light up red after the system self-diagnosis:
 - SOS button
 -  Roadside Assistance call button
 -  MB Info call button
- After the system self-diagnosis, the **Inoperative** or **Service Not Activated** message appears in the multifunction display.

If a malfunction is indicated as outlined above, the system may not operate as expected. In the event of an emergency, help will have to be summoned by other means.

Have the system checked at the nearest authorized Mercedes-Benz Center or contact the following service hotlines:

- **USA:** Mercedes-Benz Customer Assistance Center at 1-800-FOR-MERCEdes (1-800-367-6372) or 1-866-990-9007
- **Canada:** Customer Service at 1-888-923-8367

Emergency call

Important safety notes

WARNING

It can be dangerous to remain in the vehicle, even if you have pressed the SOS button in an emergency if:

- you see smoke inside or outside of the vehicle, e.g. if there is a fire after an accident
- the vehicle is on a dangerous section of road
- the vehicle is not visible or cannot easily be seen by other road users, particularly when dark or in poor visibility conditions

There is a risk of an accident and injury.

Leave the vehicle immediately in this or similar situations as soon as it is safe to do so. Move to a safe location along with other vehicle occupants. In such situations, secure the vehicle in accordance with national regulations, e.g. with a warning triangle.

You must have a license agreement to activate the mbrace service. Make sure that your system is activated and operational. To register, press the  MB Info call button. If any of the steps mentioned are not carried out, the system may not be activated.

If you have questions about the activation, contact one of the following telephone hotlines:

- **USA:** Mercedes-Benz Customer Assistance Center at 1-800-FOR-MERCEdes (1-800-367-6372) or 1-866-990-9007
- **Canada:** Customer Service at 1-888-923-8367

General notes

An emergency call is dialed automatically if an air bag or Emergency Tensioning Device is triggered.

- i** You cannot end an automatically triggered emergency call yourself.

An emergency call can also be initiated manually.

As soon as the emergency call has been initiated, the indicator lamp in the SOS button flashes. The multifunction display shows the **Connecting Call** message.

The audio output is muted.

Once the connection has been made, the **Call Connected** message appears in the multifunction display.

All important information on the emergency is transmitted, for example:

- current location of the vehicle (as determined by the GPS system)
- vehicle identification number
- information on the severity of the accident

Shortly after the emergency call has been initiated, a voice connection is automatically established between the Customer Assistance Center and the vehicle occupants.

- If the vehicle occupants respond, the Mercedes-Benz Customer Assistance Center attempts to get more information on the emergency.
- If there is no response from the vehicle occupants, an ambulance is immediately sent to the vehicle.

If no voice connection can be established to the Mercedes-Benz Customer Assistance Center, the system has been unable to initiate an emergency call.

This can occur, for example, if the relevant mobile phone network is not available. The indicator lamp in the SOS button flashes continuously.

The **Call Failed** message appears in the multifunction display and must be confirmed.

In this case, summon assistance by other means.

Making an emergency call

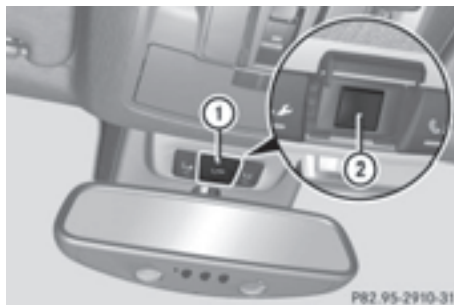

- ▶ **To initiate an emergency call manually:** press cover ① briefly to open.
- ▶ Press SOS button ② briefly. The indicator lamp in SOS button ② flashes until the emergency call is concluded.
- ▶ Wait for a voice connection to the Mercedes-Benz Customer Assistance Center.
- ▶ After the emergency call, close cover ①.

- i** If the mobile phone network is unavailable, mbrace will not be able to make the emergency call. If you leave the vehicle immediately after pressing the SOS button, you will not know whether mbrace placed the emergency call. In this case, always summon assistance by other means.

Roadside Assistance button



- ▶ Press Roadside Assistance button ①.
This initiates a call to the Mercedes-Benz Customer Assistance Center.
The indicator lamp in Roadside Assistance button ① flashes while the call is active.
The multifunction display shows the **Connecting Call** message. The audio output is muted.

If a connection can be made, the **Call Connected** message appears in the multifunction display.

If a mobile phone network and GPS reception are available, the system transfers data to the Mercedes-Benz Customer Assistance Center, for example:

- current location of the vehicle
- vehicle identification number

- ① The audio system or COMAND display indicates that a call is active. During the call, you can change to the navigation menu by pressing the NAVI button on COMAND, for example.

Voice output is not available.

A voice connection is established between the Mercedes-Benz Customer Assistance Center and the vehicle occupants.

From the vehicle remote malfunction diagnosis, the Mercedes-Benz Customer Assistance Center can ascertain the nature of the problem (▶ page 359).

The Mercedes-Benz Customer Assistance Center either sends a qualified Mercedes-Benz technician or makes arrangements for your vehicle to be transported to the nearest authorized Mercedes-Benz Center.

You may be charged for services such as repair work and/or towing.

Further details are available in your mbrace manual.

- ① The system has not been able to initiate a Roadside Assistance call, if:

- the indicator lamp for Roadside Assistance call button ① is flashing continuously.
- no voice connection to the Mercedes-Benz Customer Assistance Center was established.

This can occur if the relevant mobile phone network is not available, for example.

The **Call Failed** message appears in the multifunction display.

- ▶ **To end a call:** press the  button on the multifunction steering wheel.

or

- ▶ Press the corresponding button for ending a phone call on the audio system or on COMAND.

MB Info call button



- ▶ Press MB Info call button ①.
This initiates a call to the Mercedes-Benz Customer Assistance Center.
The indicator lamp in MB Info call button ① flashes while the connection is being made.
The multifunction display shows the **Connecting Call** message. The audio system is muted.

If a connection can be made, the **Call Connected** message appears in the multifunction display.

If a mobile phone network and GPS reception are available, the system transfers data to the Mercedes-Benz Customer Assistance Center, for example:

- current location of the vehicle
- vehicle identification number

i The audio system or COMAND display indicates that a call is active. During the call, you can change to the navigation menu by pressing the NAVI button on COMAND, for example.

Voice output is not available.

A voice connection is established between the Mercedes-Benz Customer Assistance Center and the vehicle occupants.

You receive information about operating your vehicle, about the nearest authorized Mercedes-Benz Center and about other products and services from Mercedes-Benz.

USA only: you can find further information on the mbrace system under "Owners Online" at <http://www.mbusa.com>.

i The system has not been able to initiate an MB Info call, if:

- the indicator lamp in MB Info call button  is flashing continuously.
- no voice connection to the Mercedes-Benz Customer Assistance Center was established.

This can occur if the relevant mobile phone network is not available, for example.

The **Call Failed** message appears in the multifunction display.

► **To end a call:** press the  button on the multifunction steering wheel.

or

► Press the corresponding button for ending a phone call on the audio system or on COMAND.

Call priority

When service calls are active, e.g. Roadside Assistance or MB Info calls, an emergency call can still be initiated. In this case, an emergency call will take priority and override all other active calls.

The indicator lamp of the respective button flashes until the call is ended.

An emergency call can only be terminated by the Mercedes-Benz Customer Assistance Center.

All other calls can be ended by pressing:

- the  button on the multifunction steering wheel
- the corresponding button on the audio system or on COMAND for ending a telephone call

i When a call is initiated, the audio system is muted. The mobile phone is no longer connected to COMAND. However, if you want to use your mobile phone, do so only when the vehicle is stationary and in a safe location.

Downloading destinations in COMAND

Downloading destinations

Downloading destinations gives you access to a database with over 15 million points of interest (POIs). These can be downloaded on the navigation system in your vehicle. If you know the destination, the address can be downloaded. Alternatively, you can obtain the location of Points of Interest (POIs)/important destinations in the vicinity.

Furthermore, you can download routes with up to 20 way points.

You are prompted to confirm route guidance to the address entered.

The system calculates the route and subsequently starts the route guidance with the address entered.

i If you select **No**, the address can be saved in the address book.

- i** The destination download function is available if the relevant mobile phone network is available and data transfer is possible.
- i** The destination download function can only be used if the vehicle is equipped with a navigation system.

Route Assistance

This service is part of the mbrace PLUS Package and cannot be purchased separately.

- i** You can also use the Route Assistance function if your vehicle is not equipped with a navigation system.

Within the framework of this service, you receive a professional and reliable form of navigation support without having to leave your vehicle.

The customer service representative finds a suitable route depending on your vehicle's current position and the desired destination. You will then be guided live through the current route section.

Search & Send

General notes

- i** To use "Search & Send", your vehicle must be equipped with mbrace and a navigation system. Additionally, an mbrace service subscription must be completed.



"Search & Send" is a destination entry service. A destination address which is found on Google Maps® can be transferred via mbrace directly to your vehicle's navigation system.

Specifying and sending the destination address

- ▶ Go to the website <http://www.maps.google.com> and enter a destination address into the entry field.
- ▶ **To send the destination address to the e-mail address of your mbrace account:** click on the corresponding button on the website.

- i** Example:
If you select 'Send to vehicle' and then 'Mercedes-Benz', the destination address will be sent to your vehicle.
- ▶ When the "Send" dialog window appears:
Enter the e-mail address you specified when setting up your mbrace account into the corresponding field.
- ▶ Click "Send".
- i** Information on specific commands such as "Address entry" or "Send" can be found on the website.

Calling up destination addresses

- ▶ Switch on the ignition.
The destination address is loaded into the vehicle's navigation system.
A display message appears, asking whether navigation should be started.
- ▶ Select **Yes** by turning  or sliding  to the COMAND controller and press  to confirm.
The system calculates the route and subsequently starts the route guidance with the address entered.

- i** If you select **No**, the address can be saved in the address book.
- i** If you have sent more than one destination address, each individual destination must be confirmed separately.
- i** Destination addresses are loaded in the same order as the order in which they were sent.

If you own multiple Mercedes-Benz vehicles with mbrace and activated mbrace accounts:

If multiple vehicles are registered under the same e-mail address, the destination will be sent to all the vehicles.

Vehicle remote opening

You can use the vehicle remote opening if you have unintentionally locked your vehicle and a replacement SmartKey is not available.

The vehicle can be opened by the Mercedes-Benz Customer Assistance Center.

The vehicle can be immediately opened remotely within four days of the ignition being turned off. After this time, the remote unlocking may be delayed by 15 to 60 minutes. After 30 days, the vehicle can no longer be opened remotely.

► Contact the following service hotlines:

- **USA:** Mercedes-Benz Customer Assistance Center at 1-800-FOR-MERcedes (1-800-367-6372) or 1-866-990-9007
- **Canada:** Customer Service at 1-888-923-8367

You will be asked for your password.

► Return to your vehicle at the time agreed upon with the Mercedes-Benz Customer Assistance Center.

USA only: alternatively, the vehicle can be opened via:

- the Internet, under the "Owners Online" section
- the telephone applications (e.g. iPhone®, Blackberry)

To do this, you will need your identification number and password.

- ❗ Vehicle remote opening is only possible if the corresponding mobile phone network is accessible.

Vehicle remote closing

The vehicle remote locking feature can be used when you have forgotten to lock the vehicle and you are no longer nearby.

The vehicle can then be locked by the Mercedes-Benz Customer Assistance Center.

The vehicle can be immediately remotely locked within four days of the ignition being turned off. After this time, remote locking

may be delayed by 15 to 60 minutes. After 30 days the vehicle can no longer be locked remotely.

► Contact the following service hotlines:

- **USA:** Mercedes-Benz Customer Assistance Center at 1-800-FOR-MERcedes (1-800-367-6372) or 1-866-990-9007
- **Canada:** Customer Service at 1-888-923-8367

You will be asked for your password.

The next time you are inside the vehicle and you switch on the ignition, the **Doors Locked Remotely** message appears in the multifunction display.

USA only: alternatively, the vehicle can be locked via:

- the Internet, under the "Owners Online" section
- the telephone applications (e.g. iPhone®, Blackberry)

To do this, you will need your identification number and password.

- ❗ The vehicle remote closing feature is available when the relevant mobile phone network is available and data connection is possible.

Stolen vehicle recovery service

If your vehicle has been stolen:

- Notify the police.
The police will issue a numbered incident report.
- This number will be forwarded to the Mercedes-Benz Customer Assistance Center together with your PIN.
The Mercedes-Benz Customer Assistance Center then tries to locate the system. The Mercedes-Benz Customer Assistance Center contacts you and the local law enforcement agency if the vehicle is located.
However, only the law enforcement agency is informed of the location of the vehicle.

- ❗ If the anti-theft alarm system is activated for longer than 30 seconds, the Mercedes-Benz Customer Assistance Center is automatically notified.

Vehicle remote malfunction diagnosis

With the vehicle remote malfunction diagnosis (Vehicle Health Check), the Customer Assistance center can provide improved support for problems with your vehicle. During an existing call, vehicle data is transferred to the Customer Assistance center. The customer service representative can use the received data to decide what kind of assistance is required. You are then, for example, guided to the nearest authorized Mercedes-Benz Center or a recovery vehicle is called.

If vehicle data needs to be transferred during an MB Info call or a Roadside Assistance call, this is initiated by the Customer Assistance center. You will see the **Roadside Assistance Connected** message in the COMAND display. If the vehicle remote malfunction diagnosis can be started, the **Request for vehicle diagnosis received. Start vehicle diagnosis?** message appears in the display.

- ▶ Confirm the message with **Yes**.
- ▶ When the **Vehicle Diagnosis Please start ignition** message appears, turn the SmartKey to position **2** in the ignition lock (▷ page 157).
- ▶ When the **Please follow the instructions received by phone and move your vehicle to a safe position.** message appears, follow the customer service representative's instructions. The message in the display disappears. If you select **Cancel**, the vehicle remote malfunction diagnosis is canceled completely. The vehicle operating state check begins. You will see the **Vehicle diagnosis activated.** message.

When the diagnosis is completed, the **Send vehicle diagnostics data/(Voice connection may be/interrupted during data transfer)** message appears. The vehicle data can now be sent to the Customer Assistance center.

- ▶ Press **OK** to confirm the message. The voice connection with the Customer Assistance center is terminated. You will see the **Vehicle Diagnosis: Transferring data...** message. The vehicle data is sent to the Customer Assistance center.

Depending on what the customer service representative agreed with you, the voice connection is re-established after the transfer is complete. If necessary, you will be contacted at a later time by another means, e.g. by e-mail or phone.

Further functions of the vehicle remote malfunction diagnosis include, for example:

- transfer of service data to the Customer Assistance center. If a service is overdue, the COMAND display shows a message about various special offers at your workshop.
- monthly status information e-mail on oil level, air pressure, maintenance, brakes, etc. If applicable, you will receive information on special offers in the e-mail. USA only: this information can also be called up under "Owners Online" at <http://www.mbusa.com>.

Information on the data stored in the vehicle (▷ page 30).

Information on Roadside Assistance (▷ page 26).

Downloading routes

Downloading routes allows you to transfer and save predefined routes in the navigation system. To do this, an SD memory card must be inserted into the COMAND system. If no SD memory card is inserted, you must insert

the card into the card slot on the COMAND system before saving.

A route can be prepared and sent either by a customer service representative or via the mbrace portal on the Internet.

Each route can include up to 20 way points. Once a route has been received by the navigation system, you will see the **<route name> has been saved to memory card. Do you want to start route guidance?** message in the COMAND display. The route is saved to the SD memory card.

► **To start route guidance:** select **Yes**.

An overview of the route is shown in the display.

❗ If you select **No**, the saved route can be called up later via the navigation menu.

► Select **Start**.

Route guidance is started.

❗ Downloaded and saved data can be called up again in COMAND.

You can find further information in the separate COMAND Operating Instructions.

Speed alert

You can define the upper speed limit, which must not be exceeded by the vehicle.

If this selected speed is exceeded by the vehicle, a message will be sent to the Customer Assistance Center. The Customer Assistance Center then forwards this information to you. You can select the way in which you receive this information beforehand. Possible options include text message, e-mail or an automated call.

The data you receive contains the following information:

- the location where the speed limit was exceeded
- the time at which the speed limit was exceeded
- the selected speed limit which was exceeded

Geo fencing

Geo fencing allows you to select areas which the vehicle should not enter or leave. You will be informed if the vehicle crosses the boundaries of the selected areas. You can select the way in which you receive this information beforehand. Possible options include text message, e-mail or an automated call.

The area can be determined as either a circle or a polygon with a maximum of ten corners. You can specify up to ten areas simultaneously. Different settings are possible for each area.

USA only: these settings can be called up under "Owners Online" at <http://www.mbusa.com>.

Alternatively, you can trigger an MB Info call and inform the customer service representative that you wish to activate geo fencing.

Currently inactive areas can be activated by text message.

Triggering the vehicle alarm

With this function, you can trigger the vehicle's panic alarm via text message. An alarm sounds and the exterior lighting flashes. Depending on the setting, the panic alarm lasts five or ten seconds. Afterwards, the alarm switches off.

Garage door opener

General notes

The HomeLink® garage door opener integrated in the rear-view mirror allows you to operate up to three different door and gate systems.

Use the integrated garage door opener only on garage doors that:

- have safety stop and reverse features and
- meet current U.S. federal safety standards

Once programmed, the integrated garage door opener in the rear-view mirror will assume the function of the garage door system's remote

control. Please also read the operating instructions for the garage door system.

When programming a garage door opener, park the vehicle outside the garage. Do not run the engine while programming.

Certain garage door drives are incompatible with the integrated garage door opener. If you have difficulty programming the integrated garage door opener, contact an authorized Mercedes-Benz Center.

Alternatively, you can call the following telephone assistance services:

- **USA:** Mercedes-Benz Customer Assistance Center at 1-800-FOR-MERCEdes
- **Canada:** Customer Service at 1-800-387-0100
- HomeLink® hotline 1-800-355-3515 (free of charge)

More information on HomeLink® and/or compatible products is also available online at <http://www.homelink.com>.

Notes on the declaration of conformity (▷ page 28).

USA: FCC ID: CB2HMIHL4

Canada: IC: 279B-HMIHL4

Important safety notes

WARNING

When you operate or program the garage door with the integrated garage door opener, persons in the range of movement of the garage door can become trapped or struck by the garage door. There is a risk of injury.

When using the integrated garage door opener, always make sure that nobody is within the range of movement of the garage door.

WARNING

Combustion engines emit poisonous exhaust gases such as carbon monoxide. Inhaling these exhaust gases leads to poisoning. There is a risk of fatal injury. Therefore never leave

the engine running in enclosed spaces without sufficient ventilation.

Programming

Programming buttons

Pay attention to the "Important safety notes" (▷ page 361).



Garage door remote control ⑤ is not included with the integrated garage door opener.

► Turn the SmartKey to position **2** in the ignition lock (▷ page 157).

► Select one of buttons ② to ④ to use to control the garage door drive.

► **To start programming mode:** press and hold one of buttons ② to ④ on the integrated garage door opener.

The garage door opener is now in programming mode. After a short time, indicator lamp ① lights up yellow.

Indicator lamp ① lights up yellow as soon as button ②, ③ or ④ is programmed for the first time. If the selected button has already been programmed, indicator lamp ① will only light up yellow after ten seconds have elapsed.

► Release button ②, ③ or ④. Indicator lamp ① flashes yellow.

► **To program the remote control:** point garage door remote control ⑤ towards buttons ② to ④ on the rear-view mirror at a distance of 2 to 8 inches (5 to 20 cm).

- ▶ Press and hold button ⑥ on remote control ⑤ until indicator lamp ① lights up green. When indicator lamp ① lights up green: programing is finished.

When indicator lamp ① flashes green: programing was successful. The next step is to synchronize the rolling code.

- ▶ Release button ⑥ on remote control ⑤ for the garage door drive system. If indicator lamp ① lights up red: repeat the programing procedure for the corresponding button on the rear-view mirror. When doing so, vary the distance between remote control ⑤ and the rear-view mirror.

The required distance between remote control ⑤ and the integrated garage door opener depends on the garage door drive system. Several attempts might be necessary. You should test every position for at least 25 seconds before trying another position.

Synchronizing the rolling code

Pay attention to the "Important safety notes" (> page 361).

If the garage door system uses a rolling code, you will also have to synchronize the garage door system with the integrated garage door opener in the rear-view mirror. To do this you will need to use the programing button on the door drive control panel. The programing button may be positioned at different locations depending on the manufacturer. It is usually located on the door drive unit on the garage ceiling.

Familiarize yourself with the garage door drive operating instructions, e.g. under "Programing of additional remote controls", before carrying out the following steps.

Your vehicle must be within reach of the garage door or gate opener drive. Make sure that neither your vehicle nor any persons/objects are present within the sweep of the door or gate.

- ▶ Turn the SmartKey to position 2 in the ignition lock (> page 157).
- ▶ Get out of the vehicle.
- ▶ Press the programing button on the door drive unit. Usually, you now have 30 seconds to initiate the next step.
- ▶ Get into the vehicle.
- ▶ Press previously programed button ②, ③ or ④ on the integrated garage door opener until the door closes. The rolling code synchronization is then complete.

Notes on programing the remote control

Canadian radio frequency laws require a "break" (or interruption) of the transmission signals after broadcasting for a few seconds. Therefore, these signals may not last long enough for the integrated garage door opener. The signal is not recognized during programing. Comparable with Canadian law, some U.S. garage door openers also feature a "break".

Proceed as follows:

- if you live in Canada
- if you have difficulties programing the garage door opener (regardless of where you live) when using the programing steps.
- ▶ Press and hold one of buttons ② to ④ on the integrated garage door opener. After a short time, indicator lamp ① lights up yellow.
- ▶ Release the button. Indicator lamp ① flashes yellow.
- ▶ Press button ⑥ of garage door remote control ⑤ for two seconds, then release it for two seconds.
- ▶ Press button ⑥ again for two seconds.
- ▶ Repeat this sequence on button ⑥ of remote control ⑤ until indicator lamp ① lights up green. When indicator lamp ① lights up green: programing is finished.

When indicator lamp ① flashes green: programming was successful. The next step is to synchronize the rolling code.

- ▶ Release button ⑥ of remote control ⑤ of the garage door drive.

If indicator lamp ① lights up red: repeat the programming process for the corresponding button on the rear-view mirror. When doing so, vary the distance between remote control ⑤ and the rear-view mirror.

The required distance between remote control ⑤ and the integrated garage door opener depends on the garage door drive system. Several attempts might be necessary. You should test every position for at least 25 seconds before trying another position.

Problems when programming

If you are experiencing problems programming the integrated garage door opener on the rear-view mirror, take note of the following instructions:

- Check the transmitter frequency used by garage door drive remote control ⑤ and whether it is supported. The transmitter frequency can usually be found on the back of the garage door drive remote control.

The integrated garage door opener is compatible with devices that have units which operate in the frequency range of 280 to 433 MHz.

- Replace the batteries in garage door remote control ⑤. This increases the likelihood that garage door remote control ⑤ will transmit a strong and precise signal to the integrated garage door opener.
- When programming, hold remote control ⑤ at varying distances and angles from the button which you are programming. Try various angles at a distance between 2 and 12 inches (5 to 30 cm) or at the same angle but at varying distances.
- If another remote control is available for the same garage door drive, repeat the same programming steps with this remote control.

Before performing these steps, make sure that new batteries have been installed in garage door drive remote control ⑤.

- Note that some remote controls only transmit for a limited amount of time (the indicator lamp on the remote control goes out). Press button ⑥ on remote control ⑤ again before transmission ends.
- Align the antenna cable of the garage door opener unit. This can improve signal reception/transmission.

Opening/closing the garage door

After it has been programmed, the integrated garage door opener performs the function of the garage door system remote control. Please also read the operating instructions for the garage door system.

- ▶ Turn the SmartKey to position **2** in the ignition lock (▷ page 157).
- ▶ Press button ②, ③ or ④ which you have programmed to operate the garage door.
 - Garage door system with a fixed code: indicator lamp ① lights up green.
 - Garage door system with a rolling code: indicator lamp ① flashes green.

The transmitter will transmit a signal as long as the button is pressed. The transmission is halted after a maximum of ten seconds and indicator lamp ① lights up yellow. Press button ②, ③ or ④ again if necessary.

Clearing the memory

Make sure that you clear the memory of the integrated garage door opener before selling the vehicle.

- ▶ Turn the SmartKey to position **2** in the ignition lock (▷ page 157).
- ▶ Press and hold buttons ② and ④.
 - The indicator lamp initially lights up yellow and then green.
- ▶ Release buttons ② and ④.
 - The memory of the integrated garage door opener in the rear-view mirror is cleared.

Floormats

WARNING

Objects in the driver's footwell can restrict the pedal travel or obstruct a depressed pedal. The operating and road safety of the vehicle is jeopardized. There is a risk of an accident.

Make sure that all objects in the vehicle are stowed correctly, and that they cannot enter the driver's footwell. Install the floormats securely and as specified in order to ensure sufficient clearance for the pedals. Do not use loose floormats and do not place floormats on top of one another.

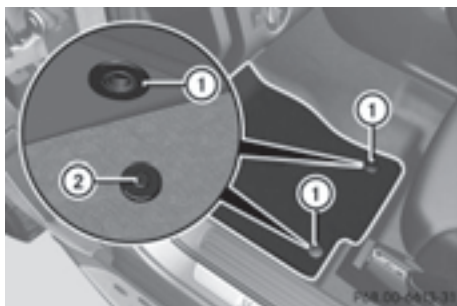

Floormat on the driver's side (example)

- ▶ **Driver's seat/front-passenger seat:** slide the respective seat back.
- ▶ **Rear seats:** slide the respective seat forwards.
- ▶ **To install:** place the floormat in the footwell.
- ▶ Press studs ① onto retainers ②.
- ▶ **To remove:** pull the floormat from retainers ②.
- ▶ Remove the floormat.

Infrared reflective windshield

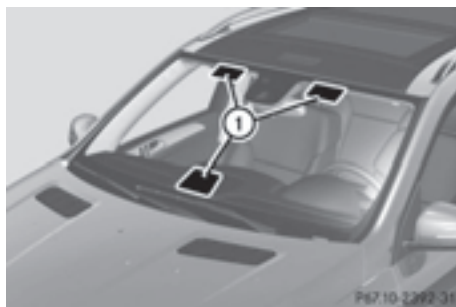

The infrared reflecting glass prevents the vehicle interior from becoming too hot. It also blocks radio waves up into the gigahertz range.

To enable operation of radio-controlled equipment, e.g. toll recording systems, areas on the windshield are permeable to radio waves ①. In these areas, you can install radio-controlled systems.

These areas can best be seen from outside the vehicle by observing the light reflected off the windshield.

Useful information	366
Engine compartment	366
ASSYST PLUS	370
Care	371

Useful information

- i** This Operator's Manual describes all models and all standard and optional equipment of your vehicle available at the time of publication of the Operator's Manual. Country-specific differences are possible. Please note that your vehicle may not be equipped with all features described. This also applies to safety-related systems and functions.
- i** Read the information on qualified specialist workshops (▷ page 29).

Engine compartment

Hood

Important safety notes

WARNING

If the hood is unlatched, it may open up when the vehicle is in motion and block your view. There is a risk of an accident.
Never unlatch the hood while driving.

WARNING

When opening and closing the hood, it may suddenly fall into the closed position. There is a risk of injury to persons within range of movement of the hood.
Open and close the hood only when no one is within its range of movement.

WARNING

Opening the hood when the engine is overheated or when there is a fire in the engine compartment could expose you to hot gases or other service products. There is a risk of injury.

Let an overheated engine cool down before opening the hood. If there is a fire in the engine compartment, keep the hood closed and contact the fire department.

WARNING

The engine compartment contains moving components. Certain components, such as the radiator fan, may continue to run or start again suddenly when the ignition is off. There is a risk of injury.

If you need to do any work inside the engine compartment:

- switch off the ignition
- never reach into the area where there is a risk of danger from moving components, such as the fan rotation area
- remove jewelry and watches
- keep items of clothing and hair, for example, away from moving parts

WARNING

The ignition system and the fuel injection system work under high voltage. If you touch components which are under voltage, you could get an electric shock. There is a risk of injury.

Never touch components of the ignition system or fuel injection system when the ignition is switched on.

Opening the hood

WARNING

Certain components in the engine compartment, such as the engine, radiator and parts of the exhaust system, can become very hot. Working in the engine compartment poses a risk of injury.

Where possible, let the engine cool down and touch only the components described in the following.

WARNING

When the hood is open and the windshield wipers are set in motion, you can be injured by the wiper linkage. There is a risk of injury.
Always switch off the windshield wipers and the ignition before opening the hood.

- !** Make sure that the windshield wipers are not folded away from the windshield. You could otherwise damage the windshield wipers or the hood.



- ▶ Make sure that the windshield wipers are turned off.
- ▶ Pull release lever ① on the hood. The hood is released.



- ▶ Reach into the gap, pull hood catch handle ② up and lift the hood. If you lift the hood by approximately 15 in (40 cm), the hood is opened and held open automatically by the gas-filled strut.

Closing the hood

- ▶ Lower the hood and let it fall from a height of approximately 8 in (20 cm).
- ▶ Check that the hood has engaged properly. If the hood can be raised slightly, it is not properly engaged. Open it again and close it with a little more force.

Radiator

Vehicles with a diesel engine: do not cover the radiator, for example with a winter front or bug cover. The readings of the on-board-diagnostic system may otherwise be inaccurate. Some of these readings are required by law and must be accurate at all times.

Engine oil

General notes

Depending on your driving style, the vehicle consumes up to 0.9 US qt (0.8 liters) of oil per 600 miles (1,000 km). The oil consumption may be higher than this when the vehicle is new or if you frequently drive at high engine speeds.

Depending on the engine, the oil dipstick may be in a different location.

When checking the oil level:

- park the vehicle on a level surface.
- the engine should be switched off for approximately five minutes if the engine is at normal operating temperature.
- if the engine is not at normal operating temperature, e.g. if the engine was only started briefly, wait about 30 minutes before carrying out the measurement.

Checking the oil level using the oil dipstick

WARNING

Certain components in the engine compartment, such as the engine, radiator and parts of the exhaust system, can become very hot. Working in the engine compartment poses a risk of injury.

Where possible, let the engine cool down and touch only the components described in the following.



Example: vehicles with a gasoline engine

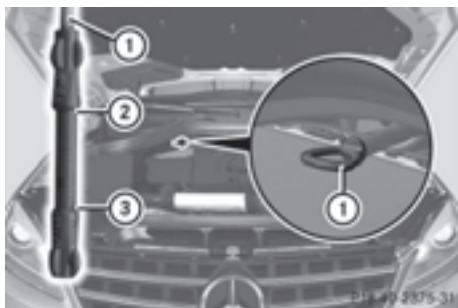

Example: vehicles with a diesel engine

- ▶ Pull oil dipstick ① out of the dipstick guide tube.
- ▶ Wipe off oil dipstick ①.
- ▶ Slowly slide oil dipstick ① into the guide tube to the stop, and take it out again. If the level is between MIN mark ③ and MAX mark ②, the oil level is correct.
- ▶ If the oil level has dropped to MIN mark ③ or below, add 1.1 US qt (1.0 liter) engine oil.

Adding engine oil

WARNING

Certain components in the engine compartment, such as the engine, radiator and parts of the exhaust system, can become very hot. Working in the engine compartment poses a risk of injury.

Where possible, let the engine cool down and touch only the components described in the following.

WARNING

If engine oil comes into contact with hot components in the engine compartment, it may ignite. There is a risk of fire and injury.

Make sure that engine oil is not spilled next to the filler neck. Let the engine cool down and thoroughly clean the engine oil off the components before starting the engine.

Environmental note

When adding oil, take care not to spill any. If oil enters the soil or waterways, it is harmful to the environment.

- ❗ Only use engine oils and oil filters that have been approved for vehicles with a service system. You can obtain a list of the engine oils and oil filters tested and approved in accordance with the Mercedes-Benz Specifications for Service Products at any Mercedes-Benz Service center.

Damage to the engine or exhaust system is caused by the following:

- using engine oils and oil filters that have not been specifically approved for the service system
- replacing engine oil and oil filters after the interval for replacement specified by the service system has been exceeded
- using engine oil additives.

- ❗ Do not add too much oil. adding too much engine oil can result in damage to the engine or to the catalytic converter. Have excess engine oil siphoned off.



Example: engine oil cap

- ▶ Turn cap ① counter-clockwise and remove it.
- ▶ Add engine oil.
If the oil level is at or below the MIN mark on the oil dipstick, add 1.1 US qt (1.0 l) of engine oil.
- ▶ Replace cap ① on the filler neck and turn clockwise.
Ensure that the cap locks into place securely.
- ▶ Check the oil level again with the oil dipstick (▷ page 367).

Further information on engine oil (▷ page 452).

Additional service products

Checking coolant level

WARNING

Certain components in the engine compartment, such as the engine, radiator and parts of the exhaust system, can become very hot. Working in the engine compartment poses a risk of injury.

Where possible, let the engine cool down and touch only the components described in the following.

WARNING

The engine cooling system is pressurized, particularly when the engine is warm. When opening the cap, you could be scalded by hot coolant spraying out. There is a risk of injury.

Let the engine cool down before opening the cap. Wear eye and hand protection when opening the cap. Open the cap slowly half a turn to allow pressure to escape.

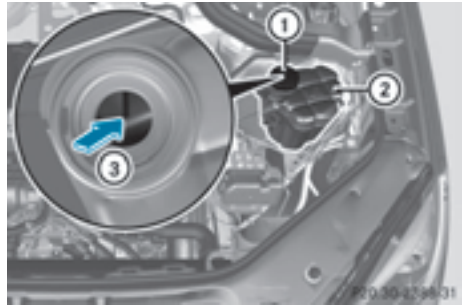

- ▶ Park the vehicle on a level surface.
Only check the coolant level when the vehicle is on a level surface and the engine has cooled down.
- ▶ Turn the SmartKey to position **2** in the ignition lock (▷ page 157).
On vehicles with KEYLESS-GO, press the Start/Stop button twice (▷ page 158).
- ▶ Check the coolant temperature gauge in the multifunction display.
The coolant temperature must be below 158 °F (70 °C).
- ▶ Turn the SmartKey to position **0** (▷ page 157) in the ignition lock.
- ▶ Slowly turn cap ① half a turn counter-clockwise to allow excess pressure to escape.
- ▶ Turn cap ① further counter-clockwise and remove it.
If the coolant is at the level of marker bar ③ in the filler neck when cold, there is enough coolant in coolant expansion tank ②.
If the coolant level is approximately 0.6 in (1.5 cm) above marker bar ③ in the filler neck when warm, there is enough coolant in expansion tank ②.
- ▶ If necessary, add coolant that has been tested and approved by Mercedes-Benz.
- ▶ Replace cap ① and turn it clockwise as far as it will go.

For further information on coolant, see (▷ page 453).

Adding washer fluid to the windshield washer system

WARNING

Certain components in the engine compartment, such as the engine, radiator and parts of the exhaust system, can become very hot. Working in the engine compartment poses a risk of injury.

Where possible, let the engine cool down and touch only the components described in the following.

WARNING

Windshield washer concentrate is highly flammable. If it comes into contact with hot engine components or the exhaust system it could ignite. There is a risk of fire and injury.

Make sure that no windshield washer concentrate is spilled next to the filler neck.



Example: washer fluid reservoir



Example: washer fluid reservoir in AMG vehicles

- ▶ **To open:** pull cap ① upwards by the tab.
- ▶ Add the premixed washer fluid.
- ▶ **To close:** press cap ① onto the filler neck until it engages.

If the washer fluid level drops below the recommended minimum of 1 liter, a message appears in the multifunction display prompting you to add washer fluid (▷ page 316).

Further information on windshield washer fluid/antifreeze (▷ page 454).

ASSYST PLUS

Service message

The ASSYST PLUS service interval display informs you of the next service due date. Information on the type of service and service intervals (see the separate Maintenance Booklet).

You can obtain further information from an authorized Mercedes-Benz Center or at <http://www.mbusa.com> (USA only).

-  The ASSYST PLUS service interval display does not show any information on the engine oil level. Observe the notes on the engine oil level (▷ page 367).

The multifunction display shows a service message for several seconds, e.g.:

- Service A in .. Days
- Service A Due
- Service A Exceeded by .. Days

Depending on the operating conditions of the vehicle, the remaining time or distance until the next service due date is displayed.

The letter **A** or **B**, possibly in connection with a number or another letter, shows the type of service. **A** stands for a minor service and **B** for a major service.

You can obtain further information from an authorized Mercedes-Benz Center.

The ASSYST PLUS service interval display does not take into account any periods of

time during which the battery is disconnected.

Maintaining the time-dependent service schedule:

- ▶ Note down the service due date displayed in the multifunction display before disconnecting the battery.





or

- ▶ After reconnecting the battery, subtract the battery disconnection periods from the service date shown on the display.

Hiding a service message

- ▶ Press the  or  button on the steering wheel.

Displaying service messages

- ▶ Switch on the ignition.
- ▶ Press the  or  button on the steering wheel to select the **Serv.** menu.
- ▶ Press the  or  button to select the **ASSYST PLUS** submenu and confirm by pressing the  button. The service due date appears in the multifunction display.

Information about Service

Resetting the ASSYST PLUS service interval display

- ! If the ASSYST PLUS service interval display has been inadvertently reset, this setting can be corrected at a qualified specialist workshop.

Have service work carried out as described in the Maintenance Booklet. This may otherwise lead to increased wear and damage to the major assemblies or the vehicle.

A qualified specialist workshop, e.g. an authorized Mercedes-Benz Center, will reset the ASSYST PLUS service interval display

after the service work has been carried out. You can also obtain further information on maintenance work, for example.

Special service requirements

The specified maintenance interval takes only the normal operation of the vehicle into account. Under arduous operating conditions or increased load on the vehicle, maintenance work must be carried out more frequently, for example:

- regular city driving with frequent intermediate stops
- if the vehicle is primarily used to travel short distances
- use in mountainous terrain or on poor road surfaces
- if the engine is often left idling for long periods

Under these or similar conditions, have, for example, the air filter, engine oil and oil filter replaced or changed more frequently. Under arduous operating conditions, the tires must be checked more often. Further information can be obtained at a qualified specialist workshop, e.g. an authorized Mercedes-Benz Center.

Driving abroad

An extensive Mercedes-Benz Service network is also available in other countries. You can obtain further information from any authorized Mercedes-Benz Center.

Care

General notes

Environmental note

Dispose of empty packaging and cleaning cloths in an environmentally responsible manner.

A qualified specialist workshop, e.g. an authorized Mercedes-Benz Center, will reset the ASSYST PLUS service interval display

! For cleaning your vehicle, do not use any of the following:

- dry, rough or hard cloths
- abrasive cleaning agents
- solvents
- cleaning agents containing solvents

Do not scrub.

Do not touch the surfaces or protective films with hard objects, e.g. a ring or ice scraper. You could otherwise scratch or damage the surfaces and protective film.

! Do not park the vehicle for an extended period straight after cleaning it, particularly after having cleaned the wheels with wheel cleaner. Wheel cleaners could cause increased corrosion of the brake discs and brake pads/linings. For this reason, you should drive for a few minutes after cleaning. Braking heats the brake discs and the brake pads/linings, thus drying them. The vehicle can then be parked.

Regular care of your vehicle is a condition for retaining the quality in the long term.

Use care products and cleaning agents recommended and approved by Mercedes-Benz.

Washing the vehicle and cleaning the paintwork

Automatic car wash

WARNING

Braking efficiency is reduced after washing the vehicle. There is a risk of an accident.

After the vehicle has been washed, brake carefully while paying attention to the traffic conditions until full braking power is restored.

! If DISTRONIC PLUS or the HOLD function is activated, the vehicle brakes automatically in certain situations. To prevent damage to the vehicle, deactivate DISTRONIC PLUS and the HOLD function in the following or other similar situations:

- when towing the vehicle
- in the car wash

! Never clean your vehicle in a Touchless Automatic Car Wash as these use special cleaning agents. These cleaning agents can damage the paintwork or plastic parts.

! Make sure that:

- the side windows and the sliding sunroof are fully closed.
- the ventilation/heating is switched off (the OFF button has been pressed).
- the windshield wiper switch is in position **0**.

Otherwise, the vehicle might be damaged.

! In car washes with a towing mechanism, make sure that the automatic transmission is in transmission position **N**, otherwise the vehicle could be damaged.

- Vehicles with a SmartKey:

Do not remove the SmartKey from the ignition lock. Do not open the driver's door or front-passenger door when the engine is switched off. Otherwise, the automatic transmission selects park position **P** automatically and locks the wheels. You can prevent this by shifting the automatic transmission to **N** beforehand.

- Vehicles with KEYLESS-GO:

Do not open the driver's door or front-passenger door when the engine is switched off. Otherwise, the automatic transmission selects park position **P** automatically and locks the wheels.

Observe the following to make sure that the automatic transmission stays in position **N**:

- ▶ Make sure the vehicle is stationary and the ignition is switched off.
- ▶ Turn the SmartKey to position **2** (▷ page 157) in the ignition lock. Use the SmartKey instead of the Start/ Stop button on vehicles with KEYLESS-GO.
- ▶ Depress and hold the brake pedal.
- ▶ Shift the automatic transmission to position **N**.
- ▶ Release the brake pedal.
- ▶ Release the electric parking brake.
- ▶ Switch off the ignition and leave the SmartKey in the ignition lock.

You can wash the vehicle in an automatic car wash from the very start.

If the vehicle is very dirty, pre-wash it before cleaning it in an automatic car wash.

After using an automatic car wash, wipe off wax from the windshield and the wiper blades. This will prevent smears and reduce wiping noises caused by residue on the windshield.

Washing by hand

In some countries, washing by hand is only allowed at specially equipped washing bays. Observe the legal requirements in all countries concerned.

- ▶ Do not use hot water and do not wash the vehicle in direct sunlight.
- ▶ Use a soft sponge to clean.
- ▶ Use a mild cleaning agent, such as a car shampoo approved by Mercedes-Benz.
- ▶ Thoroughly hose down the vehicle with a gentle jet of water.
- ▶ Do not point the water jet directly towards the air inlets.
- ▶ Use plenty of water and rinse out the sponge frequently.
- ▶ Rinse the vehicle with clean water and dry thoroughly with a chamois.
- ▶ Do not let the cleaning agent dry on the paintwork.

When using the vehicle in winter, remove all traces of road salt deposits carefully and as soon as possible.

Power washers

WARNING

The water jet from a circular jet nozzle (dirt blasters) can cause invisible exterior damage to the tires or chassis components. Components damaged in this way may fail unexpectedly. There is a risk of an accident.

Do not use power washers with circular jet nozzles to clean the vehicle. Have damaged tires or chassis components replaced immediately.

- ! Always maintain a distance of at least 11.8 in (30 cm) between the vehicle and the power washer nozzle. Information about the correct distance is available from the equipment manufacturer.

Move the power washer nozzle around when cleaning your vehicle.

Do not aim directly at any of the following:

- tires
- door gaps, roof gaps, joints, etc.
- electrical components
- battery
- connectors
- lights
- seals
- trim
- ventilation slots

Damaged seals or electrical components can lead to leaks or failures.

Cleaning the paintwork

- ! Do not affix:
 - stickers
 - films
 - magnetic plates or similar items
 to painted surfaces. You could otherwise damage the paintwork.

Scratches, corrosive deposits, areas affected by corrosion and damage caused by inadequate care cannot always be completely repaired. In such cases, visit a qualified specialist workshop.

- ▶ Remove dirt immediately, where possible, while avoiding rubbing too hard.
- ▶ Soak insect remains with insect remover and rinse off the treated areas afterwards.
- ▶ Soak bird droppings with water and rinse off the treated areas afterwards.
- ▶ Remove coolant, brake fluid, tree resin, oils, fuels and greases by rubbing gently with a cloth soaked in petroleum ether or lighter fluid.
- ▶ Use tar remover to remove tar stains.
- ▶ Use silicone remover to remove wax.

If water no longer forms "beads" on the paint surface, use the paint care products recommended and approved by Mercedes-Benz. This is the case approximately every three to five months, depending on the climate conditions and the care product used.

If dirt has penetrated the paint surface or if the paint has become dull, the paint cleaner recommended and approved by Mercedes-Benz should be used.

Do not use these care products in the sun or on the hood while the hood is hot.

- ▶ Use a suitable touch-up stick, e.g. MB Touch-Up Stick, to repair slight damage to the paintwork quickly and provisionally.

Matte finish care

! Never polish the vehicle or the light alloy wheels. Polishing causes the finish to shine.

! The following may cause the paint to become shiny and thus reduce the matte effect:

- Vigorous rubbing with unsuitable materials.
- Frequent use of car washes.
- Washing the vehicle in direct sunlight.

! Never use paint cleaner, buffing or polishing products, or gloss preserver, e.g. wax. These products are only suitable for high-gloss surfaces. Their use on vehicles with matte finish leads to considerable surface damage (shiny, spotted areas).

Always have paintwork repairs carried out at a qualified specialist workshop.

! Do not use wash programs with a hot wax treatment under any circumstances.

Observe these notes if your vehicle has a clear matte finish. This will help you to avoid damage to the paintwork due to incorrect treatment.

These notes also apply to light alloy wheels with a clear matte finish.

i The vehicle should preferably be washed by hand using a soft sponge, car shampoo and plenty of water.

i Use only insect remover and car shampoo from the range of recommended and approved Mercedes-Benz care products.

Cleaning the vehicle parts

Cleaning the wheels

! Do not use acidic wheel cleaning products to remove brake dust. This could damage wheel bolts and brake components.

! Do not park the vehicle for an extended period straight after cleaning it, particularly after having cleaned the wheels with wheel cleaner. Wheel cleaners could cause increased corrosion of the brake discs and brake pads/linings. For this reason, you

should drive for a few minutes after cleaning. Braking heats the brake discs and the brake pads/linings, thus drying them. The vehicle can then be parked.

Cleaning the windows

WARNING

You could become trapped by the windshield wipers if they start moving while cleaning the windshield or wiper blades. There is a risk of injury.

Always switch off the windshield wipers and the ignition before cleaning the windshield or wiper blades.

- ❗ Do not use dry cloths, abrasive products, solvents or cleaning agents containing solvents to clean the inside of the windows. Do not touch the insides of the windows with hard objects, e.g. an ice scraper or ring. There is otherwise a risk of damaging the windows.
- ❗ Clean the water drainage channels of the windshield and the rear window at regular intervals. Deposits such as leaves, petals and pollen may under certain circumstances prevent water from draining away. This can lead to corrosion damage and damage to electronic components.
- ▶ Clean the inside and outside of the windows with a damp cloth and a cleaning product that is recommended and approved by Mercedes-Benz.

Cleaning wiper blades

WARNING

You could become trapped by the windshield wipers if they start moving while cleaning the windshield or wiper blades. There is a risk of injury.

Always switch off the windshield wipers and the ignition before cleaning the windshield or wiper blades.

❗ Do not pull the wiper blade. Otherwise, the wiper blade could be damaged.

❗ Do not clean wiper blades too often and do not rub them too hard. Otherwise, the graphite coating could be damaged. This could cause wiper noise.

❗ Hold the wiper arm securely when folding back. The windshield could be damaged if the wiper arm smacks against it suddenly.

- ▶ Fold the windshield wiper arms away from the windshield.
- ▶ Carefully clean the wiper blades with a damp cloth.
- ▶ Fold the windshield wiper arms back again before switching on the ignition.

Cleaning the exterior lighting

❗ Only use cleaning agents or cleaning cloths which are suitable for plastic light lenses. Unsuitable cleaning agents or cleaning cloths could scratch or damage the plastic light lenses.

- ▶ Clean the plastic lenses of the exterior lighting using a wet sponge and a mild cleaning agent, e.g. Mercedes-Benz car shampoo or cleaning cloths.

Mirror turn signals

❗ Only use cleaning agents or cleaning cloths that are suitable for plastic lenses. Unsuitable cleaning agents or cleaning cloths could scratch or damage the plastic lenses of the mirror turn signals.

- ▶ Clean the plastic lenses of the mirror turn signals in the exterior mirror housing using a wet sponge and mild cleaning agent, e.g. Mercedes-Benz car shampoo or cleaning cloths.

Cleaning the sensors

❗ If you clean the sensors with a power washer, make sure that you keep a distance of at least 11.8 in (30 cm) between

the vehicle and the power washer nozzle. Information about the correct distance is available from the equipment manufacturer.

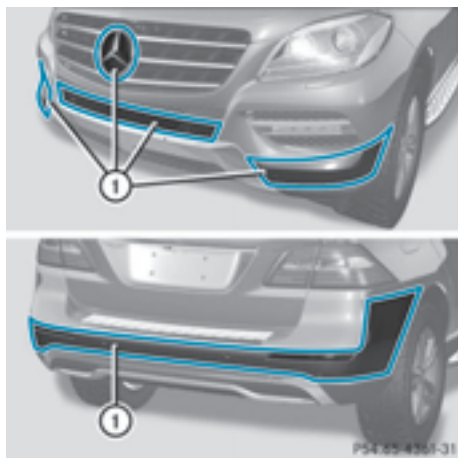

- ▶ Clean sensors ① of the driving systems with water, car shampoo and a soft cloth.

Cleaning the rear view camera

- ❗ Do not clean the camera lens and the area around the rear view camera with a power washer.



- ▶ Use clear water and a soft cloth to clean camera lens ①.

Cleaning the 360° camera

- ❗ Do not clean the camera lens and the area around the 360° camera with a power washer. 360



- ▶ Use clear water and a soft cloth to clean camera lens ①.

Cleaning the exhaust pipe

⚠ WARNING

The exhaust tail pipe and tail pipe trim can become very hot. If you come into contact with these parts of the vehicle, you could burn yourself. There is a risk of injury.

Always be particularly careful around the exhaust tail pipe and the tail pipe trim. Allow these components to cool down before touching them.

- ❗ Do not clean the exhaust pipe with acid-based cleaning agents such as sanitary cleansers or wheel cleaners.

Impurities combined with the effects of road grit and corrosive environmental factors may cause flash rust to form on the surface. You can restore the original shine of the exhaust pipe by cleaning it regularly, especially in winter and after washing.

- ▶ Clean the exhaust pipe with a chrome care product tested and approved by Mercedes-Benz.

Cleaning the trailer tow hitch

Ⓢ Environmental note

Dispose of rags soaked in oil and grease in an environmentally responsible manner.

- ❗ Do not clean the ball coupling with a power washer. Do not use solvents.

- !** Please note the care instructions in the trailer coupling manufacturer's operating instructions.



The ball coupling must be cleaned if it becomes dirty or corroded.

- ▶ Remove rust on the ball of the ball coupling, e.g. with a wire brush.
- ▶ Remove dirt with a clean, lint-free cloth or a brush.
- ▶ After cleaning, lightly oil or grease ball coupling ①.
- ▶ Check that the vehicle's trailer tow hitch is working properly.

- i** You can also have the maintenance work on the ball coupling and the trailer tow hitch carried out by a qualified specialist workshop.

Interior care

Cleaning the display

- !** For cleaning, do not use any of the following:
- alcohol-based thinner or gasoline
 - abrasive cleaning agents
 - commercially-available household cleaning agents

These may damage the display surface. Do not put pressure on the display surface when cleaning. This could lead to irreparable damage to the display.

- ▶ Before cleaning the display, make sure that it is switched off and has cooled down.
- ▶ Clean the display surface using a commercially available microfiber cloth and TFT/LCD display cleaner.
- ▶ Dry the display surface using a dry microfiber cloth.

Cleaning Night View Assist Plus

- !** Never clean the camera lens. When cleaning the field of vision of the driving systems, make sure that you do not spray glass cleaner on the camera lens. If the camera lens is dirty, visit a qualified specialist workshop.



- ▶ Fold down the camera cover by recess ①.

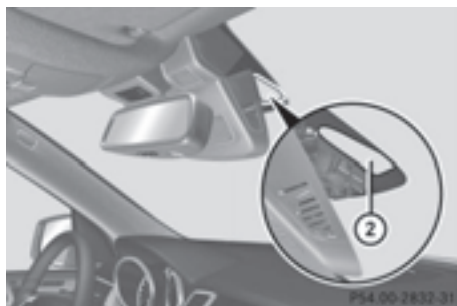

- ▶ Use a soft cloth to clean the windshield in front of camera ②.

Cleaning the plastic trim

WARNING

Care products and cleaning agents containing solvents cause surfaces in the cockpit to become porous. As a result, plastic parts may come loose in the event of air bag deployment. There is a risk of injury.

Do not use any care products and cleaning agents to clean the cockpit.

! Do not affix the following to plastic surfaces:

- stickers
- films
- scented oil bottles or similar items

You can otherwise damage the plastic.

! Do not allow cosmetics, insect repellent or sunscreen to come into contact with the plastic trim. This maintains the high-quality look of the surfaces.

► Wipe the plastic trim with a damp, lint-free cloth, e.g. a microfiber cloth.

► **Heavy soiling:** use care and cleaning products recommended and approved by Mercedes-Benz.

The surface may change color temporarily. Wait until the surface is dry again.

Cleaning the steering wheel and gear or selector lever

► Thoroughly wipe with a damp cloth or use leather care agents that have been recommended and approved by Mercedes-Benz.

Cleaning genuine wood and trim elements

! Do not use solvent-based cleaning agents such as tar remover, wheel cleaners, polishes or waxes. There is otherwise a risk of damaging the surface.

! Do not use chrome polish on trim pieces. The trim pieces have a chrome look but are mostly made of anodized aluminum and

can lose their shine if chrome polish is used. Use a damp, lint-free cloth instead when cleaning the trim pieces.

If the chrome-plated trim pieces are very dirty, you can use a chrome polish. If you are unsure as to whether the trim pieces are chrome-plated or not, consult an authorized Mercedes-Benz Center.

► Wipe the wooden trim and trim pieces with a damp, lint-free cloth, e.g. a microfiber cloth.

► **Heavy soiling:** use car care and cleaning products recommended and approved by Mercedes-Benz.

Cleaning the seat covers

General notes

! Do not use microfiber cloths to clean genuine leather, artificial leather or DINAMICA covers. If used often, these can damage the cover.

i Note that regular care is essential to ensure that the appearance and comfort of the covers is retained over time.

Genuine leather seat covers

! To retain the natural appearance of the leather, observe the following cleaning instructions:

- Clean genuine leather covers carefully with a damp cloth and then wipe the covers down with a dry cloth.
- Make sure that the leather does not become soaked. It may otherwise become rough and cracked.
- Only use leather care agents that have been tested and approved by Mercedes-Benz. You can obtain these from a qualified specialist workshop.

Leather is a natural product.

It exhibits natural surface characteristics, for example:

- differences in the texture
- marks caused by growth and injury
- slight nuances of color

These are characteristics of leather and not material defects.

Seat covers of other materials

- !** Observe the following when cleaning:
- Clean artificial leather covers with a cloth moistened with a solution containing 1% detergent (e.g. dish washing liquid).
 - Clean cloth covers with a microfiber cloth moistened with a solution containing 1% detergent (e.g. dish washing liquid). Rub carefully and always wipe entire seat sections to avoid leaving visible lines. Leave the seat to dry afterwards. Cleaning results depend on the type of dirt and how long it has been there.
 - Clean Alcantara® covers with a damp cloth. Make sure that you wipe entire seat sections to avoid leaving visible lines.

Cleaning the seat belts

WARNING

Seat belts can become severely weakened if bleached or dyed. This could cause the seat belts to tear or fail, for instance, in the event of an accident. This poses an increased risk of injury or fatal injury.

Never bleach or dye the seat belts.

- !** Do not clean the seat belts using chemical cleaning agents. Do not dry the seat belts by heating at temperatures above 176 °F (80 °C) or in direct sunlight.
- Use clean, lukewarm water and soap solution.

Cleaning the headliner and carpets

- **Headliner:** if it is very dirty, use a soft brush or dry shampoo.
- **Carpets:** use the carpet and textile cleaning agents recommended and approved by Mercedes-Benz.

Useful information	382
Where will I find...?	382
Flat tire	383
Battery (vehicle)	387
Jump-starting	391
Towing and tow-starting	393
Fuses	396

Useful information

i This Operator's Manual describes all models and all standard and optional equipment of your vehicle available at the time of publication of the Operator's Manual. Country-specific differences are possible. Please note that your vehicle may not be equipped with all features described. This also applies to safety-related systems and functions.

i Read the information on qualified specialist workshops (▷ page 29).

Where will I find...?

Vehicle tool kit

General notes

The vehicle tool kit can be found in the stowage well under the cargo compartment floor.

i Apart from certain country-specific variations, the vehicles are not equipped with a tire-change tool kit. Some tools for changing a wheel are specific to the vehicle. For more information on which tools are required to perform a wheel change on your vehicle, consult a qualified specialist workshop.

Tools required for changing a wheel may include, for example:

- Jack
- Wheel chock
- Lug wrench
- Ratchet wrench
- Alignment bolt

Vehicles with a TIREFIT kit

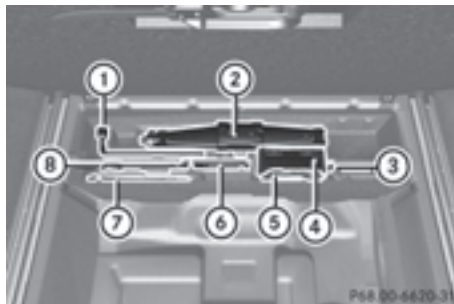

Vehicle tool kit (example)

- ① Lug wrench
- ② Jack
- ③ Alignment bolt
- ④ Tire inflation compressor
- ⑤ Tire sealant filler bottle
- ⑥ Folding wheel chock
- ⑦ Towing eye
- ⑧ Ratchet wrench

Use the TIREFIT kit (▷ page 384).

Vehicles with a "Minispare" emergency spare wheel

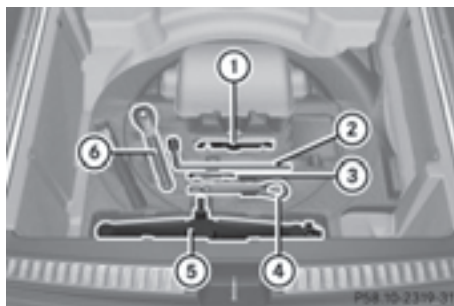

Example: vehicles with AIRMATIC and trailer tow hitch

- ① Folding wheel chock
- ② Lug wrench
- ③ Alignment bolt
- ④ Towing eye
- ⑤ Jack
- ⑥ Ratchet wrench

- ▶ Lift the cargo compartment floor up (▷ page 344).
- ▶ Remove "Minispare" emergency spare wheel (▷ page 441).

Flat tire

Preparing the vehicle

Your vehicle may be equipped with:

- MOExtended tires (tires with run-flat properties) (▷ page 383)
Vehicle preparation is not necessary on vehicles with MOExtended tires.
- a TIREFIT kit (▷ page 382)
- an emergency spare wheel (only for certain countries) (▷ page 440)

Information on changing/mounting a wheel (▷ page 423).

- ▶ Stop the vehicle on solid, non-slippery and level ground, as far away as possible from traffic.
- ▶ Switch on the hazard warning lamps.
- ▶ Secure the vehicle against rolling away (▷ page 182).
- ▶ If possible, bring the front wheels into the straight-ahead position.
- ▶ **Vehicles with the AIRMATIC package:** make sure that highway level is selected (▷ page 211).
- ▶ Switch off the engine.
- ▶ **Vehicles without KEYLESS-GO:** remove the SmartKey from the ignition lock.
- ▶ **Vehicles with KEYLESS-GO:** open the driver's door.
The on-board electronics now have status **0**. This is the same as the SmartKey having been removed.
- ▶ **Vehicles with KEYLESS-GO:** remove the Start/Stop button from the ignition lock (▷ page 158).
- ▶ All occupants must get out of the vehicle. Make sure that they are not endangered as they do so.

- ▶ Make sure that no one is near the danger area while a wheel is being changed. Anyone who is not directly assisting in the wheel change should, for example, stand behind the barrier.
- ▶ Get out of the vehicle. Pay attention to traffic conditions when doing so.
- ▶ Close the driver's door.
- ▶ Unload heavy luggage.

- ▶ **i** Only operate the tire inflation compressor using a 12 V socket, even if the ignition is turned off (▷ page 349).

An emergency cut-out ensures that the on-board voltage does not drop too low. If the on-board voltage is too low, the power to the sockets is automatically cut. This ensures that there is sufficient power to start the engine.

MOExtended tires (tires with run-flat properties)

General notes

With MOExtended tires (tires with run flat characteristics), you can continue to drive your vehicle even if there is a total loss of pressure in one or more tires. The affected tire must not show any clearly visible damage. You can recognize MOExtended tires by the MOExtended marking which appears on the sidewall of the tire. You will find this marking next to the tire size designation, the load-bearing capacity and the speed index (▷ page 417).

MOExtended tires may only be used in conjunction with an active tire pressure loss warning system or with an active tire pressure monitor.

If the pressure loss warning message appears in the multifunction display:

- Observe the instructions in the display messages (▷ page 312).
- Check the tire for damage.
- If driving on, observe the following notes.

The maximum driving distance is approximately 50 miles (80 km) when the vehicle is partially laden and approximately 18 miles (30 km) when the vehicle is fully laden.

In addition to the vehicle load, the driving distance possible depends upon:

- Speed
- Road condition
- Outside temperature

The driving distance possible in run-flat mode may be reduced by extreme driving conditions/maneuvers, or it can be increased through a moderate style of driving.

The maximum permissible distance which can be driven in run-flat mode is counted from the moment the tire pressure loss warning appears in the multifunction display.

You must not exceed a maximum speed of 50 mph (80 km/h).

i When replacing one or all tires, make sure that you use only tires:

- of the size specified for the vehicle and
- marked "MOExtended"

If a tire has gone flat and cannot be replaced with a MOExtended tire, a standard tire may be used as a temporary measure. Make sure that you use the proper size and type (summer or winter tire).

i Vehicles equipped with MOExtended tires are not equipped with a TIREFIT kit at the factory. It is therefore recommended that you additionally equip your vehicle with a TIREFIT kit if you mount tires that do not feature run-flat properties, e.g. winter tires. A TIREFIT kit may be obtained from a qualified specialist workshop.

Important safety notes

WARNING

When driving in emergency mode, the driving characteristics deteriorate, e.g. when cornering, accelerating quickly and when braking. There is a risk of an accident.

Do not exceed the stated maximum speed. Avoid abrupt steering and driving maneuvers, and driving over obstacles (curbs, potholes, off-road). This applies in particular to a laden vehicle.

Stop driving in emergency mode if:

- you hear banging noises.
- the vehicle starts to shake.
- you see smoke and smell rubber.
- ESP® is intervening constantly.
- there are tears in the sidewalls of the tire.

After driving in emergency mode, have the wheel rims checked at a qualified specialist workshop with regard to their further use. The defective tire must be replaced in every case.

TIREFIT kit

Important safety notes

TIREFIT is a tire sealant.

You can use TIREFIT to seal punctures of up to 0.16 in (4 mm), particularly those in the tire tread. You can use TIREFIT at outside temperatures down to -4 °F (-20 °C).

WARNING

In the following situations, the tire sealant is unable to provide sufficient breakdown assistance, as it is unable to seal the tire properly:

- there are cuts or punctures in the tire larger than those mentioned above.
- the wheel rim is damaged.
- you have driven at very low tire pressures or on a flat tire.

There is a risk of an accident.

Do not drive the vehicle. Contact a qualified specialist workshop.

WARNING

The tire sealant is harmful and causes irritation. It must not come into contact with your skin, eyes or clothing or be swallowed. Do not

inhale TIREFIT fumes. Keep tire sealant away from children. There is a risk of injury.

If you come into contact with the tire sealant, observe the following:

- Rinse off the tire sealant from your skin immediately with water.
- If the tire sealant comes into contact with your eyes, immediately rinse them thoroughly with clean water.
- If tire sealant is swallowed, immediately rinse your mouth out thoroughly and drink plenty of water. Do not induce vomiting, and seek medical attention immediately.
- Immediately change out of clothing which has come into contact with tire sealant.
- If an allergic reaction occurs, seek medical attention immediately.

! Do not operate the tire inflation compressor for longer than eight minutes at a time without a break. It may otherwise overheat. The tire inflation compressor can be operated again once it has cooled down.

Comply with the manufacturer's safety instructions on the sticker on the tire inflation compressor.

Using the TIREFIT kit

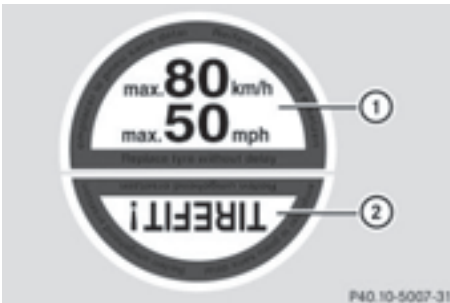

TIREFIT sticker, 2-part

- ▶ Do not remove any foreign objects which have penetrated the tire, e.g. screws or nails.
- ▶ Remove the tire sealant bottle, the accompanying TIREFIT sticker and the tire infla-

tion compressor from the stowage well underneath the cargo compartment floor (▷ page 382).

- ▶ Affix part ① of the TIREFIT sticker within the driver's field of vision.
- ▶ Affix part ② of the TIREFIT sticker near the valve on the wheel with the defective tire.

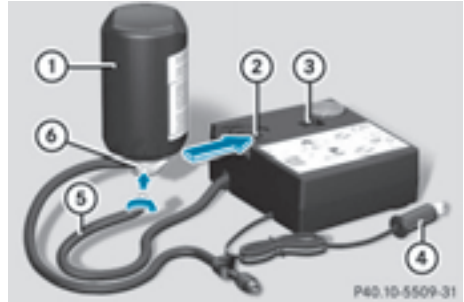

- ▶ Pull plug ④ with the cable and hose ⑤ out of the housing.
- ▶ Screw hose ⑤ onto flange ⑥ of tire sealant bottle ①.
- ▶ Place tire sealant bottle ① head downwards into recess ② of the tire inflation compressor.

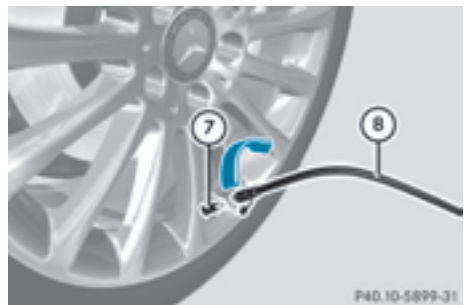

- ▶ Remove the cap from valve ⑦ on the faulty tire.
- ▶ Screw filler hose ⑧ onto valve ⑦.
- ▶ Insert connector ④ into a 12 V socket in your vehicle. Observe the notes on sockets (▷ page 349).
- ▶ Turn the SmartKey to position 1 in the ignition lock (▷ page 157).

- ▶ Press on/off switch ③ on the tire inflation compressor to I.
The tire inflation compressor is switched on. The tire is inflated.

i First, tire sealant is pumped into the tire. The pressure can briefly rise to approximately 500 kPa (5 bar/73 psi).

Do not switch off the tire inflation compressor during this phase.

- ▶ Allow the tire inflation compressor to run for five minutes. The tire should then have attained a pressure of at least 180 kPa (1.8 bar/26 psi).

If a tire pressure of 180 kPa (1.8 bar/26 psi) has been attained after five minutes:
(▷ page 386).

If a tire pressure of 180 kPa (1.8 bar/26 psi) has not been attained after five minutes:
(▷ page 386).

- i** If tire sealant leaks out, allow it to dry. It can then be removed like a layer of film.
If your clothes are soiled with tire sealant, have them cleaned with perchloroethylene at a dry cleaner as soon as possible.

Tire pressure not reached

If a pressure of 180 kPa (1.8 bar/26 psi) has not been attained after five minutes:

- ▶ Switch off the tire inflation compressor.
- ▶ Unscrew the filler hose from the valve of the faulty tire.
- ▶ Very slowly drive forwards or reverse approximately 30 ft (10 m).
- ▶ Pump up the tire again.
After a maximum of five minutes the tire pressure must be at least 180 kPa (1.8 bar/26 psi).

WARNING

If the required tire pressure is not reached after the specified time, the tire is too badly damaged. The tire sealant cannot repair the tire in this instance. Damaged tires and a tire pressure that is too low can significantly

impair the vehicle's braking and driving characteristics. There is a risk of accident.

Do not continue driving. Contact a qualified specialist workshop.

Tire pressure reached

WARNING

A tire temporarily sealed with tire sealant impairs the driving characteristics and is not suitable for higher speeds. There is a risk of accident.

You should therefore adapt your driving style accordingly and drive carefully. Do not exceed the specified maximum speed with a tire that has been repaired using tire sealant.

- !** Residue from the tire sealant may come out of the filler hose after use. This could cause stains.

Therefore, place the filler hose in the plastic bag which contained the TIREFIT kit.

Environmental note

Have the used tire sealant bottle disposed of professionally, e.g. at a qualified specialist workshop.

If a tire pressure of 180 kPa (1.8 bar/26 psi) has been attained after five minutes:

- ▶ Switch off the tire inflation compressor.
- ▶ Unscrew the filler hose from the valve of the faulty tire.
- ▶ Stow the tire sealant bottle and the tire inflation compressor.
- ▶ **Pull away immediately.**

The maximum speed for a tire sealed with tire sealant is 50 mph (80 km/h). The upper part of the TIREFIT sticker must be affixed to the instrument cluster in the driver's field of vision.

- ▶ Stop after driving for approximately ten minutes and check the tire pressure with the tire inflation compressor.
The tire pressure must now be at least 130 kPa (1.3 bar/19 psi).

⚠ WARNING

If the required tire pressure is not reached after driving for a short period, the tire is too badly damaged. The tire sealant cannot repair the tire in this instance. Damaged tires and a tire pressure that is too low can significantly impair the vehicle's braking and driving characteristics. There is a risk of accident. Do not continue driving. Contact a qualified specialist workshop.

- i** In cases such as the one mentioned above, contact an authorized Mercedes-Benz Center. Or call 1-800-FOR-MERCEDES (in the USA) or 1-800-387-0100 (in Canada).
- ▶ Correct the tire pressure if it is still at least 130 kPa (1.3 bar/19 psi). See the Tire and Loading Information placard on the driver's side B-pillar or the tire pressure table in the fuel filler flap for values.
- ▶ **To increase the tire pressure:** switch on the tire inflation compressor.

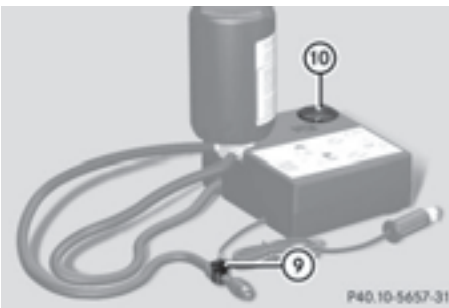

- ⑨ Pressure release button
- ⑩ Pressure gauge

- ▶ **To reduce the tire pressure:** press pressure release button ⑨ on the filler hose.
- ▶ Stow the tire sealant bottle and the tire inflation compressor.
- ▶ Drive to the nearest qualified specialist workshop and have the tire changed there.

- ▶ Have the tire sealant bottle replaced as soon as possible at a qualified specialist workshop.
- ▶ Have the tire sealant bottle replaced every four years at a qualified specialist workshop.

Battery (vehicle)

Important safety notes

Special tools and expert knowledge are required when working on the battery, e.g. removal and installing. You should therefore have all work involving the battery carried out at a qualified specialist workshop.

⚠ WARNING

Work carried out incorrectly on the battery can lead, for example, to a short circuit and thus damage the vehicle electronics. This can lead to function restrictions applying to safety-relevant systems, e.g. the lighting system, ABS (anti-lock braking system) or ESP® (Electronic Stability Program). The operating safety of your vehicle may be restricted. You could lose control of the vehicle, for example:

- braking
- in the event of abrupt steering maneuver and/or when the vehicle's speed is not adapted to the road conditions

There is a risk of an accident.

In the event of a short circuit or a similar incident, contact a qualified specialist workshop immediately. Do not drive any further. You should have all work involving the battery carried out at a qualified specialist workshop.

- i** For further information about ABS and ESP®, see (▶ page 68) and (▶ page 72).

⚠ WARNING

Electrostatic build-up can lead to the creation of sparks, which could ignite the highly explosive gases of a battery. There is a risk of an explosion.

Before handling the battery, touch the vehicle body to remove any existing electrostatic build-up.

The highly flammable gas mixture forms when charging the battery as well as when jump-starting.

Always make sure that neither you nor the battery is electrostatically charged. A build-up of electrostatic charge can be caused, for example:

- by wearing clothing made from synthetic fibers
- due to friction between clothing and seats
- if you push or pull the battery across the carpet or other synthetic materials
- if you wipe the battery with a cloth

WARNING

During the charging process, a battery produces hydrogen gas. If a short circuit occurs or sparks are created, the hydrogen gas can ignite. There is a risk of an explosion.

- Make sure that the positive terminal of a connected battery does not come into contact with vehicle parts.
- Never place metal objects or tools on a battery.
- It is important that you observe the described order of the battery terminals when connecting and disconnecting a battery.
- When jump-starting, make sure that the battery poles with identical polarity are connected.
- It is particularly important to observe the described order when connecting and disconnecting the jumper cables.
- Never connect or disconnect the battery terminals while the engine is running.

WARNING

Battery acid is caustic. There is a risk of injury. Avoid contact with the skin, eyes or clothing. Do not inhale any battery gases. Do not lean over the battery. Keep children away from

batteries. Wash battery acid immediately with water and seek medical attention.

Environmental note



Batteries contain dangerous substances. It is against the law to dispose of them with the household rubbish. They must be collected separately and recycled to protect the environment.



Dispose of batteries in an environmentally friendly manner. Take discharged batteries to a qualified specialist workshop or a special collection point for used batteries.

-  Have the battery checked regularly at a qualified specialist workshop.

Observe the service intervals in the Maintenance Booklet or contact a qualified specialist workshop for more information.

-  You should have all work involving the battery carried out at a qualified specialist workshop. In the exceptional case that it is necessary for you to disconnect the battery yourself, make sure that:

- you switch off the engine and remove the SmartKey. On vehicles with KEYLESS-GO, ensure that the ignition is switched off. Check that all the indicator lamps in the instrument cluster are off. Otherwise, electronic components, such as the alternator, may be damaged.
- you first remove the negative terminal clamp and then the positive terminal clamp. Never swap the terminal clamps. Otherwise, the vehicle's electronic system may be damaged.
- the transmission is locked in position **P** after disconnecting the battery. The vehicle is secured against rolling away. You can then no longer move the vehicle.

The battery and the cover of the positive terminal clamp must be installed securely during operation.

Comply with safety precautions and take protective measures when handling batteries.



Risk of explosion.



Fire, open flames and smoking are prohibited when handling the battery. Avoid creating sparks.



Battery acid is caustic. Avoid contact with skin, eyes or clothing.

Wear suitable protective clothing, especially gloves, apron and face-guard.

Rinse any acid spills immediately with clear water. Contact a physician if necessary.



Wear eye protection.



Keep children away.



Observe this Operator's Manual.

For safety reasons, Mercedes-Benz recommends that you only use batteries which have been tested and approved for your vehicle by Mercedes-Benz. These batteries provide increased impact protection to prevent vehicle occupants from suffering acid burns should the battery be damaged in the event of an accident.

In order for the battery to achieve the maximum possible service life, it must always be sufficiently charged.

The vehicle battery, like other batteries, can discharge over time if you do not use the vehicle. In this case, have the battery disconnected at a qualified specialist workshop. You

can also charge the battery with a charger recommended by Mercedes-Benz. Contact a qualified specialist workshop for further information.

Have the battery condition of charge checked more frequently if you use the vehicle mainly for short trips or if you leave it standing idle for a lengthy period. Consult a qualified specialist workshop if you wish to leave your vehicle parked for a long period of time.

- i** Remove the SmartKey if you park the vehicle and do not require any electrical consumers. The vehicle will then use very little energy, thus conserving battery power.

Charging the battery

WARNING

During charging and jump-starting, explosive gases can escape from the battery. There is a risk of an explosion.

Particularly avoid fire, open flames, creating sparks and smoking. Ensure there is sufficient ventilation while charging and jump-starting. Do not lean over a battery.

WARNING

Battery acid is caustic. There is a risk of injury. Avoid contact with the skin, eyes or clothing. Do not inhale any battery gases. Do not lean over the battery. Keep children away from batteries. Wash battery acid immediately with water and seek medical attention.

WARNING

A discharged battery can freeze at temperatures below freezing point. When jump-starting the vehicle or charging the battery, gases can escape from the battery. There is a risk of an explosion.

Allow the frozen battery to thaw out before charging it or jump-starting.

! Only use battery chargers with a maximum charging voltage of 14.8 V.

! Only charge the battery using the jump-starting connection point.

If, at low temperatures, the indicator lamps/warning lamps in the instrument cluster do not light up, it is highly likely that the discharged battery has frozen. In this case you may neither jump-start the vehicle nor charge the battery. The service life of a thawed-out battery may be shorter. The starting characteristics can be impaired, particularly at low temperatures. Have the thawed-out battery checked at a qualified specialist workshop.

Never charge a battery still installed in the vehicle unless a battery charger unit approved by Mercedes-Benz is being used. An accessory battery charge unit specially adapted for Mercedes-Benz vehicles and tested and approved by Mercedes-Benz is available. It permits the charging of the battery in its installed position. Contact an authorized Mercedes-Benz Center for further information and availability. Charge the battery in accordance with the separate instructions for the battery charger.

The jump-starting connection point is in the engine compartment (▷ page 391).

Read the battery charger's operating instructions before charging the battery.

- ▶ Open the hood.
- ▶ Connect the battery charger to the positive terminal and ground point in the same order as when connecting the donor battery in the jump-starting procedure (▷ page 391).

Jump-starting

For the jump-starting procedure, use only the jump-starting connection point, consisting of a positive terminal and a ground point, in the engine compartment.

WARNING

Battery acid is caustic. There is a risk of injury.

Avoid contact with the skin, eyes or clothing. Do not inhale any battery gases. Do not lean over the battery. Keep children away from batteries. Wash battery acid immediately with water and seek medical attention.

WARNING

During charging and jump-starting, explosive gases can escape from the battery. There is a risk of an explosion.

Particularly avoid fire, open flames, creating sparks and smoking. Ensure there is sufficient ventilation while charging and jump-starting. Do not lean over a battery.

WARNING

During the charging process, a battery produces hydrogen gas. If a short circuit occurs or sparks are created, the hydrogen gas can ignite. There is a risk of an explosion.

- Make sure that the positive terminal of a connected battery does not come into contact with vehicle parts.
- Never place metal objects or tools on a battery.
- It is important that you observe the described order of the battery terminals when connecting and disconnecting a battery.
- When jump-starting, make sure that the battery poles with identical polarity are connected.
- It is particularly important to observe the described order when connecting and disconnecting the jumper cables.
- Never connect or disconnect the battery terminals while the engine is running.

WARNING

A discharged battery can freeze at temperatures below freezing point. When jump-starting the vehicle or charging the battery, gases can escape from the battery. There is a risk of an explosion. Allow the frozen battery to thaw out before charging it or jump-starting.

! **Vehicles with a gasoline engine:** avoid repeated and lengthy starting attempts. Otherwise, the catalytic converter could be damaged by non-combusted fuel.

If, at low temperatures, the indicator lamps/warning lamps in the instrument cluster do not light up, it is highly likely that the discharged battery has frozen. In this case you may neither jump-start the vehicle nor charge the battery. The service life of a thawed-out battery may be shorter. The starting characteristics can be impaired, particularly at low temperatures. Have the thawed-out battery checked at a qualified specialist workshop.

Do not start the vehicle using a rapid charging device. If your vehicle's battery is discharged, the engine can be jump-started from another vehicle or from a second battery using jumper cables. Observe the following points:

- The battery is not accessible in all vehicles. If the other vehicle's battery is not accessible, jump-start the vehicle using a second battery or a jump-starting device.
- **Vehicles with a gasoline engine:** only jump-start the vehicle when the engine and exhaust system are cold.
- Do not start the engine if the battery is frozen. Let the battery thaw first.
- Only jump-start from batteries with a 12 V voltage rating.
- Only use jumper cables which have a sufficient cross-section and insulated terminal clamps.
- If the battery is fully discharged, leave the battery that is being used to jump-start connected for a few minutes before attempting to start. This charges the battery slightly.
- Make sure that the two vehicles do not touch.

Make sure that:

- the jumper cables are not damaged.
- when the jumper cables are connected to the battery, uninsulated sections of the terminal clamp do not come into contact with other metal sections.
- the jumper cables cannot come into contact with parts which can move when the engine is running, such as the V-belt pulley or the fan.
- ▶ Secure the vehicle by applying the electric parking brake.
- ▶ Shift the transmission to position **P**.
- ▶ Turn the SmartKey to position **0** in the ignition lock and remove it (▷ page 157). On vehicles with KEYLESS-GO, make sure the ignition is switched off (▷ page 158). All indicator lamps in the instrument cluster must be off.
- ▶ Switch off all electrical consumers, e.g. rear window defroster, lighting, etc.
- ▶ Open the hood.

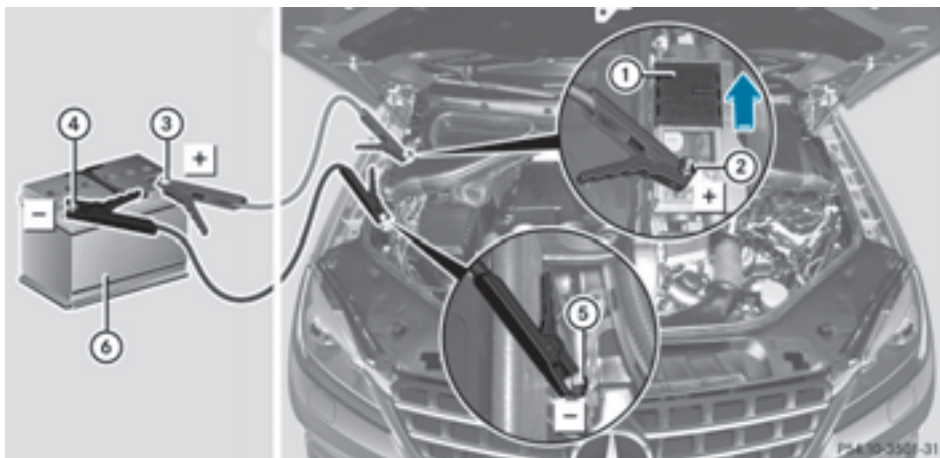

(Example)

Position number ⑥ identifies the charged battery of the other vehicle or an equivalent jump-starting device.

- ▶ Slide cover ① of positive terminal ② in the direction of the arrow.
- ▶ Connect positive terminal ② on your vehicle to positive terminal ③ of donor battery ⑥ using the jumper cable, always begin with positive terminal ② on your own vehicle first.
- ▶ Start the engine of the donor vehicle and run it at idling speed.
- ▶ Connect negative terminal ④ of donor battery ⑥ to ground point ⑤ of your vehicle using the jumper cable, connecting the jumper cable to battery of other vehicle ⑥ first.
- ▶ Start the engine.
- ▶ Before disconnecting the jumper cables, let the engine run for several minutes.
- ▶ First, remove the jumper cables from ground point ⑤ and negative terminal ④, then from positive clamp ② and positive terminal ③. Begin each time at the contacts on your own vehicle first.
- ▶ Close cover ① of positive terminal ② after removing the jumper cables.
- ▶ Have the battery checked at a qualified specialist workshop.

i Jump-starting is not considered to be a normal operating condition.

i Jumper cables and further information regarding jump-starting can be obtained at any qualified specialist workshop.

Towing and tow-starting

Important safety notes

WARNING

Functions relevant to safety are restricted or no longer available if:

- the engine is not running.
- the brake system or the power steering is malfunctioning.
- there is a malfunction in the voltage supply or the vehicle's electrical system.

If your vehicle is being towed, much more force may be necessary to steer or brake. There is a risk of an accident.

In such cases, use a tow bar. Before towing, make sure that the steering moves freely.

WARNING

If the weight of the vehicle to be towed or tow-started is greater than the permissible gross weight of your vehicle:

- the towing eye could detach itself
- the vehicle/trailer combination could roll-over.

There is a risk of an accident.

When towing or tow-starting another vehicle, its weight should not be greater than the permissible gross weight of your vehicle.

! If DISTRONIC PLUS or the HOLD function is activated, the vehicle brakes automatically in certain situations. To prevent damage to the vehicle, deactivate DISTRONIC PLUS and the HOLD function in the following or other similar situations:

- when towing the vehicle
- in the car wash

! Make sure that the electric parking brake is released. If the electric parking brake is faulty, visit a qualified specialist workshop.

! Only secure the tow rope or tow bar at the towing eyes. Otherwise, the vehicle could be damaged.

! Do not use the trailer tow hitch for recovery or towing. Do not use the towing eye for recovery. This could damage the vehicle. If in doubt, have the vehicle recovered using a crane.

! When towing, pull away slowly and smoothly. Pull the towed vehicle as straight as possible and not at an acute angle. Excessive tractive power could damage the vehicles.

i When towing, it is preferable to use a rigid towing bar as opposed to a tow rope. A rigid towing bar helps to keep the tractive power low.

! When towing vehicles with KEYLESS-GO, use the key instead of the Start/Stop button. Otherwise, the automatic transmission may shift to position **P** when the driver's or front-passenger door are opened, which could lead to damage to the transmission.

! Do not tow with sling-type equipment. This could damage the vehicle.

! Vehicles with differential locks: make sure the differential locks are in automatic mode. When towing, the differential locks must not be switched on. The transmission may otherwise be damaged.

! The vehicle can be towed a maximum of 30 miles (50km). The towing speed of 30 mph (50 km/h) must not be exceeded. If the vehicle has to be towed more than 30 miles (50km), the entire vehicle must be raised and transported.

! If you tow or tow-start another vehicle, its weight must not exceed the maximum permissible gross vehicle weight of your vehicle.

i Information on your vehicle's gross vehicle weight rating can be found on the vehicle identification plate (> page 446).

It is better to have the vehicle transported than to have it towed.

If the vehicle has suffered transmission damage, have it transported on a transporter or trailer.

The automatic transmission must be in position **N** when the vehicle is being towed.

The battery must be connected and charged. Otherwise, you:

- cannot turn the SmartKey to position **2** in the ignition lock
- cannot release the electric parking brake
- cannot shift the automatic transmission to position **N**

i Disarm the automatic locking feature before the vehicle is towed (> page 279). You could otherwise be locked out when pushing or towing the vehicle.

Installing/removing the towing eye

Installing the towing eye

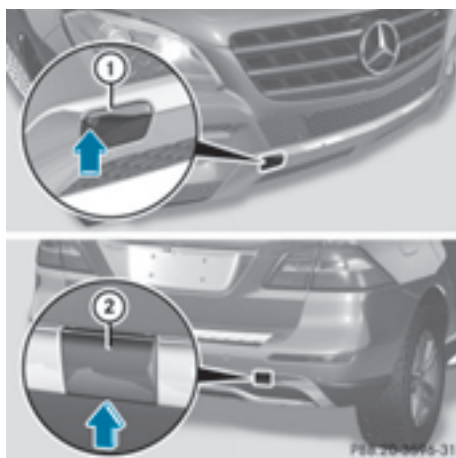

Example: towing eye mounting covers

- ① Front cover
- ② Back cover

The brackets for the screw-in towing eyes are located in the bumpers. They are at the front and at the rear, behind the covers.

- ▶ Remove the towing eye from the vehicle tool kit (▷ page 382).
- ▶ **To open the cover at the front:** press the mark on cover ① inwards in the direction of the arrow.
- ▶ **To open the cover at the rear:** insert a flat, blunt object into the cutout and lever cover ② out of the bumper.
- ▶ Take cover ① or ② off the opening.
- ▶ Screw in and tighten the towing eye clockwise to the stop.

Removing the towing eye

- ▶ Unscrew and remove the towing eye.
- ▶ Attach cover ① or ② to the bumper and press until it engages.
- ▶ Place the towing eye in the vehicle tool kit.

Towing the vehicle with the rear axle raised

- ❗ The ignition must be switched off if you are towing the vehicle with the rear axle raised. Intervention by ESP® could otherwise damage the brake system.

Only possible for vehicles without 4MATIC.

- ▶ Switch on the hazard warning lamps (▷ page 124).
- ▶ Bring the front wheels into the straight-ahead position.
- ▶ Turn the SmartKey to position **0** in the ignition lock and remove the SmartKey from the ignition lock.
- ▶ When leaving the vehicle, take the SmartKey or the KEYLESS-GO key with you.

When towing your vehicle with the rear axle raised, it is important that you observe the safety instructions (▷ page 393).

Towing a vehicle with both axles on the ground

It is important that you observe the safety instructions when towing away your vehicle (▷ page 393).

The automatic transmission automatically shifts to position **P** when you open the driver's or front-passenger door or when you remove the SmartKey from the ignition lock.

In order to ensure that the automatic transmission stays in position **N** when towing the vehicle, you must observe the following points:

- ▶ Make sure that the vehicle is stationary and the SmartKey in the ignition lock is in position **0**.
- ▶ Turn the SmartKey to position **2** in the ignition lock.
On vehicles with KEYLESS-GO, use the SmartKey instead of the Start/Stop button (▷ page 158).
- ▶ Depress and hold the brake pedal.
- ▶ Shift the automatic transmission to position **N**.
- ▶ Release the brake pedal.
- ▶ Release the electric parking brake.
- ▶ Leave the SmartKey in position **2** in the ignition lock.
- ▶ Switch on the hazard warning lamps (▷ page 124).

- ❗ In order to signal a change of direction when towing the vehicle with the hazard warning lamps switched on, use the combination switch as usual. In this case, only the indicator lamps for the direction of travel flash. After resetting the combination switch, the hazard warning lamp starts flashing again.

Transporting the vehicle

- ❗ You may only secure the vehicle by the wheels, not by parts of the vehicle such as

axle or steering components. Otherwise, the vehicle could be damaged.

The towing eye can be used to pull the vehicle onto a trailer or transporter for transporting purposes.

- ▶ Turn the SmartKey to position **2** in the ignition lock.
- ▶ Shift the automatic transmission to position **N**.

As soon as the vehicle has been loaded:

- ▶ Prevent the vehicle from rolling away by applying the electric parking brake.
- ▶ Shift the automatic transmission to position **P**.
- ▶ Turn the SmartKey to position **0** in the ignition lock and remove it.
- ▶ Secure the vehicle.

Information on 4MATIC vehicles

❗ Vehicles with 4MATIC must not be towed with either the front or the rear axle raised, as doing so will damage the transmission.

If the vehicle has transmission damage or damage to the front or rear axle, have it transported on a transporter or trailer.

In the event of damage to the electrical system

If the battery is defective, the automatic transmission will be locked in position **P**. To shift the automatic transmission to position **N**, you must provide power to the vehicle's electrical system in the same way as when jump-starting (▷ page 391).

Have the vehicle transported on a transporter or trailer.

Tow-starting (emergency engine starting)

❗ Vehicles with automatic transmission must not be tow-started. You could otherwise damage the automatic transmission.

i You can find information on "Jump-starting" under (▷ page 391).

Fuses

Important safety notes

⚠ WARNING

If you manipulate or bridge a faulty fuse or if you replace it with a fuse with a higher amperage, the electric cables could be overloaded. This could result in a fire. There is a risk of an accident and injury.

Always replace faulty fuses with the specified new fuses having the correct amperage.

❗ For the fuse boxes in the engine compartment and under the rear bench seat, only use fuses with the suffix "S". Otherwise, components or systems could be damaged.

The fuses in your vehicle serve to close down faulty circuits. If a fuse blows, all the components on the circuit and their functions stop operating.

Blown fuses must be replaced with fuses of the same rating, which you can recognize by the color and value. The fuse ratings are listed in the fuse allocation chart.

If a newly inserted fuse also blows, have the cause traced and rectified at a qualified specialist workshop, e.g. an authorized Mercedes-Benz Center.

Before changing a fuse

Observe the important safety notes (▷ page 396)

- ▶ Secure the vehicle against rolling away (▷ page 182).
- ▶ Switch off all electrical consumers.
- ▶ Turn the SmartKey to position **0** in the ignition lock and remove it (▷ page 157). On

vehicles with KEYLESS-GO, make sure the ignition is switched off (▷ page 158). All indicator lamps in the instrument cluster must be off.

The fuses are located in various fuse boxes:

- Fuse box on the front-passenger side of the dashboard
- Fuse box in the engine compartment on the right-hand side of the vehicle, when viewed in the direction of travel
- Fuse box under the rear bench seat

The fuse allocation chart is located in the fuse box under the rear bench seat (▷ page 398).

Dashboard fuse box

Observe the important safety notes (▷ page 396)

- ❗ Do not use a pointed object such as a screwdriver to open the cover in the dashboard. You could damage the dashboard or the cover.
- ❗ Make sure that no moisture can enter the fuse box when the cover is open.
- ❗ When closing the cover, make sure that it is lying correctly on the fuse box. Moisture seeping in or dirt could otherwise impair the operation of the fuses.

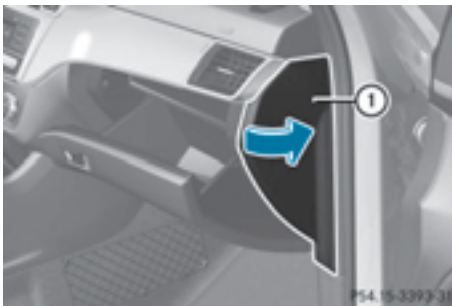

- ▶ Open the front-passenger door.
- ▶ **To open:** pull cover ① outwards in the direction of the arrow and remove it.

- ▶ **To close:** clip in cover ① on the front of the dashboard.
- ▶ Fold cover ① inwards until it engages.

Fuse box in the engine compartment

Pay attention to the important safety notes (▷ page 396).

⚠ WARNING

When the hood is open and the windshield wipers are set in motion, you can be injured by the wiper linkage. There is a risk of injury. Always switch off the windshield wipers and the ignition before opening the hood.

- ❗ Make sure that no moisture can enter the fuse box when the cover is open.
- ❗ When closing the cover, make sure that it is lying correctly on the fuse box. Moisture seeping in or dirt could otherwise impair the operation of the fuses.

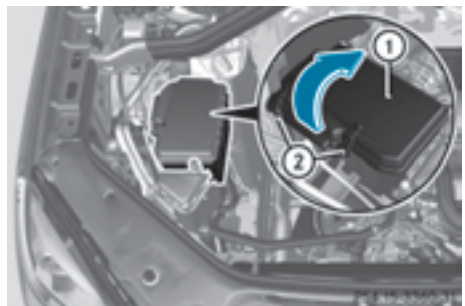

- ▶ Open the hood.
- ▶ Use a dry cloth to remove any moisture from the fuse box.
- ▶ **To open:** open clamps ②.
- ▶ Fold up cover ① in the direction of the arrow and remove it.
- ▶ **To close:** check whether the seal is seated correctly in cover ①.
- ▶ Insert cover ① at the side of the fuse box into the retainers.

- ▶ Fold down cover ① and close clamps ②.
- ▶ Close the hood.

Fuse box under the rear bench seat

Pay attention to the important safety notes (▷ page 396).

! Make sure that no moisture can enter the fuse box when the cover is open.

! When closing the cover, make sure that it is lying correctly on the fuse box. Moisture seeping in or dirt could otherwise impair the operation of the fuses or the cover could be damaged by the rear bench seat.



- ▶ Fold the right-hand rear bench seat forward (▷ page 337).
- ▶ **To open:** lift and fold out carpet ① in the direction of the arrow.

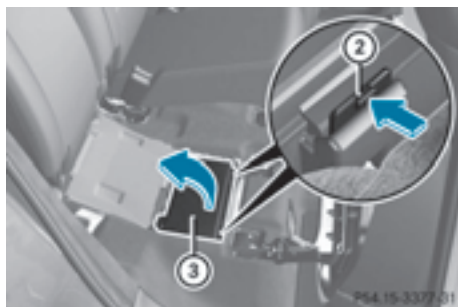

- ▶ Release clamps ② by pressing them in the direction of the arrow.
- ▶ Fold cover ③ up in the direction of the arrow and remove it.

i The fuse allocation chart is located under cover ③.

- ▶ **To close:** insert cover ③ into the retainers on the side of the fuse box.
- ▶ Fold down cover ③ until clamps ② engage audibly.
- ▶ Fold the right-hand rear bench seat back (▷ page 337).

Useful information	400
Important safety notes	400
Operation	400
Winter operation	402
Tire pressure	404
Loading the vehicle	412
All about wheels and tires	415
Changing a wheel	423
Wheel and tire combinations	428
Emergency spare wheel	440

Useful information

- i** This Operator's Manual describes all models and all standard and optional equipment of your vehicle available at the time of publication of the Operator's Manual. Country-specific differences are possible. Please note that your vehicle may not be equipped with all features described. This also applies to safety-related systems and functions.
- i** Read the information on qualified specialist workshops (▷ page 29).

Important safety notes

WARNING

If wheels and tires of the wrong size are used, the wheel brakes or suspension components may be damaged. There is a risk of an accident.

Always replace wheels and tires with those that fulfill the specifications of the original part.

When replacing wheels, make sure to use the correct:

- designation
- model

When replacing tires, make sure to use the correct:

- designation
- manufacturer
- model

WARNING

A flat tire severely impairs the driving, steering and braking characteristics of the vehicle. There is a risk of accident.

Tires without run-flat characteristics:

- do not drive with a flat tire.
- immediately replace the flat tire with your emergency spare wheel or spare wheel, or consult a qualified specialist workshop.

Tires with run-flat characteristics:

- pay attention to the information and warning notices on MOExtended tires (tires with run-flat characteristics).

Accessories that are not approved for your vehicle by Mercedes-Benz or that are not being used correctly can impair operating safety.

Before purchasing and using non-approved accessories, visit a qualified specialist workshop and inquire about:

- suitability
- legal stipulations
- factory recommendations

Information on the dimensions and types of wheels and tires for your vehicle can be found in the "Wheel/tire combinations" section (▷ page 428).

Information on air pressure for the tires on your vehicle can be found:

- on the vehicle's Tire and Loading Information placard on the B-pillar (▷ page 412)
- on the tire pressure label on the fuel filler flap (▷ page 179)
- in the "Tire pressure" section

Operation

Information on driving

If the vehicle is heavily loaded, check the tire pressures and correct them if necessary.

While driving, pay attention to vibrations, noises and unusual handling characteristics, e.g. pulling to one side. This may indicate that the wheels or tires are damaged. If you suspect that a tire is defective, reduce your speed immediately. Stop the vehicle as soon as possible to check the wheels and tires for damage. Hidden tire damage could also be causing the unusual handling characteristics. If you find no signs of damage, have the tires and wheels checked at a qualified specialist workshop.

When parking your vehicle, make sure that the tires do not get deformed by the curb or other obstacles. If it is necessary to drive over curbs, speed humps or similar elevations, try to do so slowly and at an obtuse angle. Otherwise, the tires, particularly the sidewalls, may be damaged.

Regular checking of wheels and tires

⚠ WARNING

Damaged tires can cause tire inflation pressure loss. As a result, you could lose control of your vehicle. There is a risk of accident.

Check the tires regularly for signs of damage and replace any damaged tires immediately.

Regularly check the wheels and tires of your vehicle for damage at least once a month, as well as after driving off-road or on rough roads. Damaged wheels can cause a loss of tire pressure. Pay particular attention to damage such as:

- cuts in the tires
- punctures
- tears in the tires
- bulges on tires
- deformation or severe corrosion on wheels

Regularly check the tire tread depth and the condition of the tread across the whole width of the tire (▷ page 401). If necessary, turn the front wheels to full lock in order to inspect the inner side of the tire surface.

All wheels must have a valve cap to protect the valve against dirt and moisture. Do not mount anything onto the valve other than the standard valve cap or other valve caps approved by Mercedes-Benz for your vehicle. Do not use any other valve caps or systems, e.g. tire pressure monitoring systems.

Regularly check the pressure of all the tires particularly prior to long trips. Adjust the tire pressure as necessary (▷ page 404).

Observe the notes on the emergency spare wheel (▷ page 440).

The service life of tires depends on the following factors amongst other things:

- Driving style
- Tire pressure
- Distance covered

Important safety notes on the tire tread

⚠ WARNING

Insufficient tire tread will reduce tire traction. The tire is no longer able to dissipate water. This means that on wet road surfaces, the risk of hydroplaning increases, in particular where speed is not adapted to suit the driving conditions. There is a risk of accident.

If the tire pressure is too high or too low, tires may exhibit different levels of wear at different locations on the tire tread. Thus, you should regularly check the tread depth and the condition of the tread across the entire width of all tires.

Minimum tire tread depth for:

- Summer tires: 1/8 in (3 mm)
- M+S tires: 1/4 in (4 mm)

For safety reasons, replace the tires before the legally prescribed limit for the minimum tire tread depth is reached.

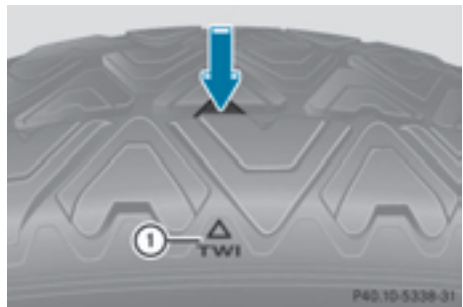

Bar indicator ① for tread wear is integrated into the tire tread.

Treadwear indicators (TWI) are required by law. Six indicators are positioned on the tire tread. They are visible once the tread depth is

approximately $\frac{1}{16}$ in (1.6 mm). If this is the case, the tire is so worn that it must be replaced.

Selecting, mounting and replacing tires

- Only mount tires and wheels of the same type and make.
Exception: it is permissible to install a different type or make in the event of a flat tire. Observe the "MOExtended tires (tires with run-flat characteristics)" section (▷ page 383).
- Only mount tires of the correct size onto the wheels.
- Break in new tires at moderate speeds for the first 60 miles (100 km). They only reach their full performance after this distance.
- Do not drive with tires which have too little tread depth, as this significantly reduces the traction on wet roads (hydroplaning).
- Replace the tires after six years at the latest, regardless of wear.

Observe the notes on the emergency spare wheel (▷ page 440).

MOExtended tires (tires with run-flat properties)

With MOExtended tires (tires with run flat characteristics), you can continue to drive your vehicle even if there is a total loss of pressure in one or more tires.

MOExtended tires may only be used in conjunction with an active tire pressure loss warning system or with an active tire pressure monitor and on wheels specifically tested by Mercedes-Benz.

Notes on driving with MOExtended tires with a flat tire (▷ page 383).

- ❗ Vehicles equipped with MOExtended tires are not equipped with a TIREFIT kit at the factory. It is therefore recommended that you additionally equip your vehicle with a

TIREFIT kit if you mount tires that do not feature run-flat properties, e.g. winter tires. A TIREFIT kit can be obtained from a qualified specialist workshop.

Winter operation

General notes

Have your vehicle winter-proofed at a qualified specialist workshop at the onset of winter.

Observe the notes in the "Changing a wheel" section (▷ page 423).

Driving with summer tires

At temperatures below 45 °F (+7 °C), summer tires lose elasticity and therefore traction and braking power. Change the tires on your vehicle to M+S tires. Using summer tires at very cold temperatures could cause cracks to form, thereby damaging the tires permanently. Mercedes-Benz cannot accept responsibility for this type of damage.

WARNING

Damaged tires can cause tire inflation pressure loss. As a result, you could lose control of your vehicle. There is a risk of accident.

Check the tires regularly for signs of damage and replace any damaged tires immediately.

M+S tires

WARNING

M+S tires with a tire tread depth of less than $\frac{1}{8}$ in (4 mm) are not suitable for use in winter and do not provide sufficient traction. There is a risk of an accident.

M+S tires with a tread depth of less than $\frac{1}{8}$ in (4 mm) must be replaced immediately.

At temperatures below 45 °F (+7 °C), use winter tires or all-season tires. Both types of tire are identified by the M+S marking.

Only winter tires bearing the  snowflake symbol in addition to the M+S marking provide the best possible grip in wintry road conditions.

Only these tires will allow driving safety systems such as ABS and ESP® to function optimally in winter. These tires have been developed specifically for driving in snow.

Use M+S tires of the same make and tread on all wheels to maintain safe handling characteristics.

Always observe the maximum permissible speed specified for the M+S tires you have mounted.

Once the winter tires are mounted:

- ▶ Check the tire pressures (▷ page 407).
- ▶ Restart the tire pressure monitor (▷ page 408).
- ▶ **Vehicles for Canada:** restart the tire pressure loss warning system (▷ page 408).

For more information on driving with the emergency spare wheel, see (▷ page 440).

Snow chains

WARNING

If snow chains are installed to the front wheels, they may drag against the vehicle body or chassis components. This could cause damage to the vehicle or the tires. There is a risk of an accident.

To avoid hazardous situations:

- never install snow chains to the front wheels
- always install snow chains in pairs to the rear wheels.

! You must drive at raised vehicle level (height 1) if snow chains have been installed. The vehicle may otherwise be damaged.

! **Vehicles with Adaptive Damping System (ADS):** do not use the sports mode if

you have installed snow chains. The vehicle may otherwise be damaged.

! On some tire sizes there is not enough space for snow chains. To avoid damage to the vehicle or tires, observe the "Wheel and tire combinations" section under "Tires and wheels".

For safety reasons, Mercedes-Benz recommends that you only use snow chains that have been specially approved for your vehicle by Mercedes-Benz, or are of a corresponding standard of quality.

If you intend to mount snow chains, please bear the following points in mind:

- Only use snow chains when driving on roads completely covered by snow. Remove the snow chains as soon as possible when you come to a road that is not snow-covered.
- Do not exceed the maximum permissible speed of 30 mph (50 km/h).
- Local regulations may restrict the use of snow chains. Observe the appropriate regulations if you wish to mount snow chains.
- Snow chains may not be mounted on all wheel/tire combinations. Permissible wheel-tire combinations (▷ page 428).
- i** You may wish to deactivate ESP® when pulling away with snow chains installed (▷ page 73). You can thereby allow the wheels to spin in a controlled manner, achieving an increased driving force (cutting action).

For more information on driving with the emergency spare wheel, see (▷ page 440).

Tire pressure

Tire pressure specifications

Important safety notes

WARNING

Underinflated or overinflated tires pose the following risks:

- the tires may burst, especially as the load and vehicle speed increase.
- the tires may wear excessively and/or unevenly, which may greatly impair tire traction.
- the driving characteristics, as well as steering and braking, may be greatly impaired.

There is a risk of an accident.

Follow recommended tire inflation pressures and check the pressure of all the tires including the spare wheel:

- monthly, at least
- if the load changes
- before beginning a long journey
- under different operating conditions, e.g. off-road driving

If necessary, correct the tire pressure.

 The specifications on the sample Tire and Loading Information placard and tire pressure tables are examples. Tire pressure specifications are vehicle-specific and may deviate from the data shown here. The tire pressure specifications that are valid for your vehicle can be found on the Tire and Loading Information placard and tire pressure table on the vehicle.

General notes

The recommended tire pressures for the tires mounted at the factory can be found on the labels described here.

Operation with the emergency spare wheel (> page 440).

Operation with a trailer: the applicable value for the rear tires is the maximum tire

pressure value stated in the table inside the fuel filler flap.

Further information on tire pressures can be obtained at a qualified specialist workshop.

Tire and Loading Information placard

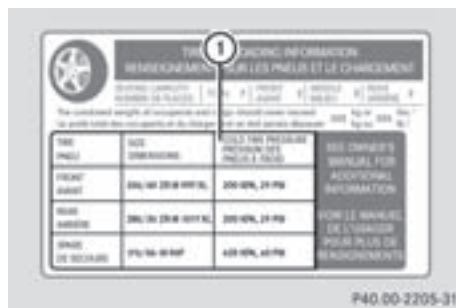

① Recommended tire pressures

The Tire and Loading Information placard is on the B-pillar on the driver's side (> page 412).

The Tire and Loading Information placard contains the recommended tire pressures for cold tires. The recommended tire pressures are valid for the maximum permissible load and up to the maximum permissible vehicle speed.

Tire pressure table

The tire pressure table is on the inside of the fuel filler flap.

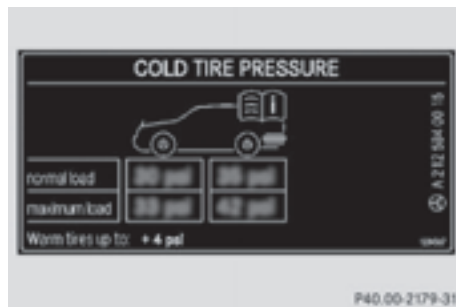

Example: tire pressure table for all tires permitted for this vehicle by the factory

The tire pressure table contains the recommended pressures for cold tires for various

operating conditions, i.e. differing load and speed conditions.

LUFTDRUCK PRESSURE PRESSION PRESSION
für kalte Reifen für cold tires des pneus froids de inflato

100 kPa = 1 bar

Reifen Tire size	1-2 Personen 1-2 occupants		3-4 Personen 3-4 occupants		5-7 Personen 5-7 occupants	
	teilw. partly laden	vollw. fully laden	teilw. partly laden	vollw. fully laden	teilw. partly laden	vollw. fully laden
195/55 R16	2.0	2.2	2.2	2.4	2.4	2.6
215/45 R17	2.2	2.4	2.4	2.6	2.6	2.8
215/40 R18	2.2	2.4	2.4	2.6	2.6	2.8

Spare-Reifen
Spare tire (up to): + 30 kPa + 4 psi

Reifen-Schraube
Spare tire
Reifen-Schraube
Spare tire

P40 00-2184-31

Example: tire pressure table with tire dimensions

If a tire size precedes a tire pressure, the tire pressure information following is only valid for that tire size. The load conditions "partially laden" and "fully laden" are defined in the table for different numbers of occupants and amounts of luggage. The actual number of seats may differ.

Luftdruck für kalte Reifen
The pressure for cold tires
Pression des pneus froids
Presión de inflato

100 kPa = 1 bar

Reifen Tire size	1-2 Personen 1-2 occupants		3-4 Personen 3-4 occupants		5-7 Personen 5-7 occupants	
	teilw. partly laden	vollw. fully laden	teilw. partly laden	vollw. fully laden	teilw. partly laden	vollw. fully laden
R 16	2.0	2.2	2.2	2.4	2.4	2.6
R 17	2.2	2.4	2.4	2.6	2.6	2.8
R 18	2.2	2.4	2.4	2.6	2.6	2.8

Spare-Reifen
Spare tire (up to): + 30 kPa + 4 psi

Reifen-Schraube
Spare tire
Reifen-Schraube
Spare tire

P40 00-2184-31

Some tire pressure tables show only the rim diameters instead of the full tire size, e.g. **R18**. The rim diameter is part of the tire size and can be found on the tire sidewall (▷ page 417).

If the tire pressures have been set to the lower values for lighter loads and/or lower road speeds, the pressures should be reset to the higher values:

- if you want to drive with an increased load and/or
 - if you want to drive at higher road speeds
- i** The tire pressures for increased loads and/or higher road speeds, shown in the

tire pressure table, may have a negative effect on driving comfort.

If the tire pressure is not set correctly, this can lead to an excessive build up of heat and a sudden loss of pressure.

For more information, contact a qualified specialist workshop.

Important notes on tire pressure

⚠ WARNING

If the tire pressure drops repeatedly, the wheel, valve or tire may be damaged. Tire pressure that is too low may result in a tire blow-out. There is a risk of an accident.

- Check the tire for foreign objects.
- Check whether the wheel is losing air or the valve is leaking.

If you are unable to rectify the damage, contact a qualified specialist workshop.

⚠ WARNING

If you fit unsuitable accessories onto tire valves, the tire valves may be overloaded and malfunction, which can cause tire pressure loss. Due to their design, retrofitted tire pressure monitors keep the tire valve open. This can also result in tire pressure loss. There is a risk of an accident.

Only screw the standard valve cap or other valve caps approved by Mercedes-Benz for your vehicle onto the tire valve.

Use a suitable pressure gauge to check the tire pressure. The outer appearance of a tire does not permit any reliable conclusion about the tire pressure. On vehicles equipped with the electronic tire pressure monitoring system, the tire pressure can be checked using the on-board computer.

The tire temperature and pressure increase when the vehicle is in motion. This is dependent on the driving speed and the load.

Therefore, you should only correct tire pressures when the tires are cold.

The tires are cold:

- if the vehicle has been parked without direct sunlight on the tires for at least three hours and
- if the vehicle has not been driven further than 1 mile (1.6 km)

The tire temperature changes depending on the outside temperature, the vehicle speed and the tire load. If the tire temperature changes by 18 °F (10 °C), the tire pressure changes by approximately 10 kPa (0.1 bar/ 1.5 psi). Take this into account when checking the pressure of warm tires. Only correct the tire pressure if it is too low for the current operating conditions. If you check the tire pressure when the tires are warm, the resulting value will be higher than if the tires were cold. This is normal. Do not reduce the tire pressure to the value specified for cold tires. The tire pressure would otherwise be too low.

Observe the recommended tire pressures for cold tires:

- on the Tire and Loading Information placard on the B-pillar on the driver's side
- in the tire pressure table on the inside of the fuel filler flap
- printed in yellow on the rim of the emergency/collapsible spare wheel (depending on vehicle equipment)

Underinflated or overinflated tires

Underinflation

WARNING

Tires with pressure that is too low can overheat and burst as a consequence. In addition, they also suffer from excessive and/or irregular wear, which can severely impair the braking properties and the driving characteristics. There is a risk of an accident.

Avoid tire pressures that are too low in all the tires, including the spare wheel.

Underinflated tires may:

- overheat, leading to tire defects
- have an adverse effect on handling characteristics
- wear quickly and unevenly
- have an adverse effect on fuel consumption

Overinflation

WARNING

Tires with excessively high pressure can burst because they are damaged more easily by road debris, potholes etc. In addition, they also suffer from irregular wear, which can severely impair the braking properties and the driving characteristics. There is a risk of an accident.

Avoid tire pressures that are too high in all the tires, including the spare wheel.

Overinflated tires may:

- increase the braking distance
- have an adverse effect on handling characteristics
- wear quickly and unevenly
- have an adverse effect on ride comfort
- be more susceptible to damage

Maximum tire pressures



- ① Example: maximum permissible tire pressure

Never exceed the maximum permissible tire inflation pressure. Always observe the recommended tire pressure for your vehicle

when adjusting the tire pressure (▷ page 404).

- i** The actual values for tires are vehicle-specific and may deviate from the values in the illustration.

Checking the tire pressures

Important safety notes

Observe the notes on tire pressure (▷ page 404).

Information on air pressure for the tires on your vehicle can be found:

- on the vehicle's Tire and Loading Information placard on the B-pillar (▷ page 412)
- on the tire pressure label on the fuel filler flap (▷ page 179)
- in the "Tire pressure" section
- under "Tire pressure" (▷ page 404)

Checking tire pressures manually

To determine and set the correct tire pressure, proceed as follows:

- ▶ Remove the valve cap of the tire that is to be checked.
- ▶ Press the tire pressure gauge securely onto the valve.
- ▶ Read the tire pressure and compare it with the recommended value on the Tire and Loading Information placard (▷ page 404).
- ▶ If the tire pressure is too low, increase it to the recommended value.
- ▶ If the tire pressure is too high, release air by pressing down the metal pin in the valve. Use the tip of a pen, for example. Then, check the tire pressure again using the tire pressure gauge.
- ▶ Screw the valve cap onto the valve.
- ▶ Repeat these steps for the other tires.

Tire pressure loss warning system

General notes

While the vehicle is in motion, the tire pressure loss warning system monitors the set tire pressure using the rotational speed of the wheels. This enables the system to detect significant pressure loss in a tire. If the speed of rotation of a wheel changes as a result of a loss of pressure, a corresponding warning message will appear in the multifunction display.

You can recognize the tire pressure loss warning by the **Run Flat Indicator Active Press 'OK' to Restart** message which appears in the **Service** menu of the multifunction display. Information on the message display can be found in the "Restarting the tire pressure loss warning system" section (▷ page 408).

Important safety notes

The tire pressure warning system does not warn you of an incorrectly set tire pressure. Observe the notes on the recommended tire pressure (▷ page 404).

The tire pressure loss warning does not replace the need to regularly check the tire pressure. An even loss of pressure on several tires at the same time cannot be detected by the tire pressure loss warning system.

The tire pressure monitor is not able to warn you of a sudden loss of pressure, e.g. if the tire is penetrated by a foreign object. In the event of a sudden loss of pressure, bring the vehicle to a halt by braking carefully. Avoid abrupt steering maneuvers.

The function of the tire pressure loss warning system is limited or delayed if:

- snow chains are mounted on your vehicle's tires.
- road conditions are wintry.
- you are driving on sand or gravel.





- you adopt a very sporty driving style (cornering at high speeds or driving with high rates of acceleration).
- you are towing a very heavy or large trailer.
- you are driving with a heavy load (in the vehicle or on the roof).

Restarting the tire pressure loss warning system





Restart the tire pressure loss warning system if you have:

- changed the tire pressure
 - changed the wheels or tires
 - mounted new wheels or tires
- ▶ Before restarting, make sure that the tire pressures are set properly on all four tires for the respective operating conditions. The recommended tire pressures can be found on the Tire and Loading Information placard on the B-pillar on the driver's side or the tire pressure table on the fuel filler flap.





The tire pressure loss warning system can only give reliable warnings if you have set the correct tire pressure. If an incorrect tire pressure is set, these incorrect values will be monitored.

- ▶ Also observe the notes in the section on tire pressures (▷ page 404).
- ▶ Make sure that the SmartKey is in position 2 in the ignition lock (▷ page 157).
- ▶ Press the  or  button on the steering wheel to select the **Service** menu.
- ▶ Press the  or  button to select **Tire Pressure**.
- ▶ Press the  button.
The **Run Flat Indicator Active Press 'OK' to Restart** message appears in the multifunction display.

If you wish to confirm the restart:

- ▶ Press the  button.
The **Tire Pressure Now OK?** message appears in the multifunction display.
- ▶ Press the  or  button to select **Yes**.
- ▶ Press the  button.
The **Run Flat Indicator Restarted** message appears in the multifunction display.
After a teach-in period, the tire pressure loss warning system will monitor the set tire pressures of all four tires.

If you wish to cancel the restart:

- ▶ Press the  button.
or
- ▶ If the **Tire Pressure Now OK?** message appears, use the  or  button to select **Cancel**.
- ▶ Press the  button.
The tire pressure values stored at the last restart will continue to be monitored.

Tire pressure monitor

General notes

If a tire pressure monitor is installed, the vehicle's wheels have sensors that monitor the tire pressures in all four tires. The tire pressure monitor warns you if the pressure drops in one or more of the tires. The tire pressure monitor only functions if the correct sensors are installed on all wheels.

Information on tire pressures is displayed in the multifunction display. After a few minutes of driving, the current tire pressure of each tire is shown in the **Service** menu of the multifunction display.

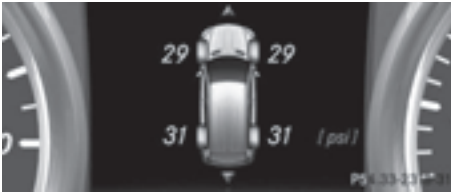

Example: current tire pressure display

For information on the message display, refer to the "Checking the tire pressure electronically" section (▷ page 410).

Important safety notes

WARNING

Each tire, including the spare (if provided), should be checked at least once a month when cold and inflated to the pressure recommended by the vehicle manufacturer on the Tire and Loading Information placard on the driver's door B-pillar or the tire pressure label on the inside of the fuel filler flap. If your vehicle has tires of a different size than the size indicated on the Tire and Loading Information placard or the tire pressure label, you should determine the proper tire pressure for those tires.

As an added safety feature, your vehicle has been equipped with a tire pressure monitoring system (TPMS) that illuminates a low tire pressure telltale when one or more of your tires are significantly underinflated. Accordingly, when the low tire pressure telltale illuminates, you should stop and check your tires as soon as possible, and inflate them to the proper pressure. Driving on a significantly underinflated tire causes the tire to overheat and can lead to tire failure. Underinflation also reduces fuel efficiency and tire tread life, and may affect the vehicle's handling and stopping ability.

Please note that the TPMS is not a substitute for proper tire maintenance, and it is the driver's responsibility to maintain correct tire pressure, even if underinflation has not reached the level to trigger illumination of the TPMS low tire pressure telltale.

USA only:

Your vehicle has also been equipped with a TPMS malfunction indicator to indicate if the system is not operating properly. The TPMS malfunction indicator is combined with the low tire pressure telltale. When the system detects a malfunction, the warning lamp will flash for approximately a minute and then remain continuously illuminated. This sequence will be repeated every time the vehicle is started as long as the malfunction exists.

When the malfunction indicator is illuminated, the system may not be able to detect or signal low tire pressure as intended. TPMS malfunctions may occur for a variety of reasons, including the mounting of incompatible replacement or alternate tires or wheels on the vehicle that prevent the TPMS from functioning properly. Always check the TPMS malfunction telltale after replacing one or more tires or wheels on your vehicle to ensure that the replacement or alternate tires and wheels allow the TPMS to continue to function properly.

It is the driver's responsibility to set the tire pressure to that recommended for cold tires which is suitable for the operating situation (▷ page 404). Note that the correct tire pressure for the current operating situation must first be taught-in to the tire pressure monitor. If there is a substantial loss of pressure, the warning threshold for the warning message is aligned to the reference values taught-in. Restart the tire pressure monitor after adjusting the pressure of the cold tires (▷ page 411). The current pressures are saved as new reference values. As a result, a warning message will appear if the tire pressure drops significantly.

The tire pressure monitor does not warn you of an incorrectly set tire pressure. Observe the notes on the recommended tire pressure (▷ page 404).

The tire pressure monitor is not able to warn you of a sudden loss of pressure, e.g. if the

tire is penetrated by a foreign object. In the event of a sudden loss of pressure, bring the vehicle to a halt by braking carefully. Avoid abrupt steering maneuvers.

The tire pressure monitor has a yellow warning lamp in the instrument cluster for indicating a pressure loss or malfunction. Whether the warning lamp flashes or lights up indicates whether a tire pressure is too low or the tire pressure monitor is malfunctioning:

- if the warning lamp is lit continuously, the tire pressure on one or more tires is significantly too low. The tire pressure monitor is not malfunctioning.
- if the warning lamp flashes for around a minute and then remains lit constantly, the tire pressure monitor is malfunctioning.





i In addition to the warning lamp, a message appears in the multifunction display.

Further information can be found on (> page 312).

If the tire pressure monitor is malfunctioning, it may take more than ten minutes for the tire pressure warning lamp to inform you of the malfunction by flashing for approximately one minute and then remaining lit. When the malfunction has been rectified, the tire pressure warning lamp goes out after a few minutes of driving.

The tire pressure values indicated by the on-board computer may differ from those measured at a gas station with a pressure gauge. The tire pressures shown by the on-board computer refer to those measured at sea level. At high altitudes, the tire pressure values indicated by a pressure gauge are higher than those shown by the on-board computer. In this case, do not reduce the tire pressures. The operation of the tire pressure monitor can be affected by interference from radio transmitting equipment (e.g. radio headphones, two-way radios) that may be being operated in or near the vehicle.

Checking the tire pressure electronically

- ▶ Make sure that the SmartKey is in position **2** (> page 157) in the ignition lock.
- ▶ Press the  or  button on the steering wheel to select the **Service** menu.
- ▶ Press the  or  button to select **Tire Pressure**.
- ▶ Press the  button.

The current tire pressure of each tire is shown in the multifunction display.

If the vehicle has been parked for longer than 20 minutes, the **Tire pressure will be displayed after driving a few minutes** message appears.

After a teach-in process, the tire pressure monitor automatically detects new wheels or new sensors. As long as a clear allocation of the tire pressure value to the individual wheels is not possible, the **Tire Pressure Monitor Active** display message is shown instead of the tire pressure display. The tire pressures are already being monitored.

i If an emergency spare wheel is mounted, the system may continue to show the tire pressure of the wheel that has been removed for a few minutes. If this occurs, note that the value displayed for the position where the spare wheel is mounted is not the same as the current tire pressure of the emergency spare wheel.

Tire pressure monitor warning messages

If the tire pressure monitor detects a pressure loss in one or more tires, a warning message is shown in the multifunction display and the yellow tire pressure monitor warning lamp comes on.



- If the **Please Correct Tire Pressure** message appears in the multifunction display, the tire pressure in at least one tire is





too low and must be corrected at the next opportunity.

- If the **Check Tires** message appears in the multifunction display, the tire pressure in one or more tires has dropped significantly and the tires must be checked.
 - If the **Warning Tire Malfunction** appears in the multifunction display, the tire pressure in one or more tires has dropped suddenly and the tires must be checked.
- i** If the wheel positions on the vehicle are rotated, the tire pressures may be displayed for the wrong positions for a short time. This is rectified after a few minutes of driving, and the tire pressures are displayed for the correct positions.

Restarting the tire pressure monitor

When you restart the tire pressure monitor, all existing warning messages are deleted and the warning lamps go out. The monitor uses the currently set tire pressures as the reference values for monitoring. In most cases, the tire pressure monitor will automatically detect the new reference values after you have changed the tire pressure. However, you can also define reference values manually as described here. The tire pressure monitor then monitors the new tire pressure values.

- ▶ Set the tire pressure to the value recommended for the corresponding driving situation on the Tire and Loading Information placard on the driver's side B-pillar (▷ page 404).
Additional tire pressure values for different loads can also be found on the tire pressure table on the inside of the fuel filler flap (▷ page 404).
- ▶ Make sure that the tire pressure is correct on all four wheels.
- ▶ Make sure that the SmartKey is in position **2** in the ignition lock.
- ▶ Press the  or  button on the steering wheel to select the **Service** menu.

- ▶ Press the  or  button to select **Tire Pressure**.
- ▶ Press the  button.
The multifunction display shows the current tire pressure for the individual tires or the **Tire pressure will be displayed after driving a few minutes** message.
- ▶ Press the  button.
The **Use Current Pressures as New Reference Values** message appears in the multifunction display.

If you wish to confirm the restart:

- ▶ Press the  button.
The **Tire Press. Monitor Restarted** message appears in the multifunction display.
After driving for a few minutes, the system checks whether the current tire pressures are within the specified range. The new tire pressures are then accepted as reference values and monitored.

If you wish to cancel the restart:

- ▶ Press the  button.
The tire pressure values stored at the last restart will continue to be monitored.

Radio type approval for the tire pressure monitor

Country	Radio type approval number
USA	FCC ID: MRXMW2433A FCC ID: MRXGG4 FCC ID: MRXMC34MA4
Canada	IC: 2546A-MW2433A IC: 2546A-GG4 IC: 2546A-MC34MA4

Loading the vehicle

Instruction labels for tires and loads

WARNING

Overloaded tires can overheat, causing a blowout. Overloaded tires can also impair the steering and driving characteristics and lead to brake failure. There is a risk of accident.

Observe the load rating of the tires. The load rating must be at least half of the GAWR of your vehicle. Never overload the tires by exceeding the maximum load.

Two instruction labels on your vehicle show the maximum possible load.

- (1) The Tire and Loading Information placard is on the B-pillar on the driver's side. The Tire and Loading Information placard shows the maximum permissible number of occupants and the maximum permissible vehicle load. It also contains details of the tire sizes and corresponding pressures for tires mounted at the factory.
- (2) The vehicle identification plate is on the B-pillar on the driver's side. The vehicle identification plate informs you of the gross vehicle weight rating. It is made up of the vehicle weight, all vehicle occupants, the fuel and the cargo. You can also find information about the maximum gross axle weight rating on the front and rear axle.

The maximum gross axle weight rating is the maximum weight that can be carried by one axle (front or rear axle). Never exceed the maximum load or the maximum gross axle weight rating for the front or rear axle.



① B-pillar, driver's side

Maximum permissible gross vehicle weight rating

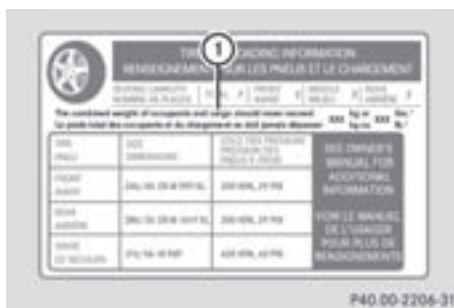

- Specification for maximum gross vehicle weight ① is listed in the Tire and Loading Information placard: "The combined weight of occupants and cargo should never exceed XXX kilograms or XXX lbs."

The gross weight of all vehicle occupants, load and luggage must not exceed the specified value.

- i** The specifications shown on the Tire and Loading Information placard in the illustration are examples. The maximum permissible gross vehicle weight rating is vehicle-specific and may differ from that in the illustration. You can find the valid maximum

permissible gross vehicle weight rating for your vehicle on the Tire and Loading Information placard.

Number of seats

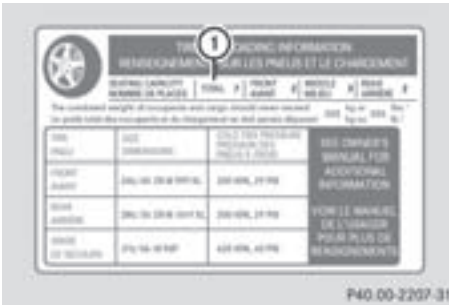

Maximum number of seats ① indicates the maximum number of occupants allowed to travel in the vehicle. This information can be found on the Tire and Loading Information placard.

i The specifications shown on the Tire and Loading Information placard in the illustration are examples. The number of seats is vehicle-specific and can differ from the details shown. The number of seats in your vehicle can be found on the Tire and Loading Information placard.

Determining the correct load limit

Step-by-step instructions

The following steps have been developed as required of all manufacturers under Title 49, Code of U.S. Federal Regulations, Part 575 pursuant to the "National Traffic and Motor Vehicle Safety Act of 1966".

► **Step 1:** Locate the statement "The combined weight of occupants and cargo should never exceed XXX kg or XXX lbs." on

your vehicle's Tire and Loading Information placard.

► **Step 2:** Determine the combined weight of the driver and passengers that will be riding in your vehicle.

► **Step 3:** Subtract the combined weight of the driver and passengers from XXX kilograms or XXX lbs.

► **Step 4:** The resulting figure equals the available amount of cargo and luggage load capacity. For example, if the "XXX" amount equals 1,400 lbs and there will be five 150 lbs passengers in your vehicle, the amount of available cargo and luggage load capacity is 650 lbs (1,400 - 750 (5 x 150) = 650 lbs).

► **Step 5:** Determine the combined weight of luggage and cargo being loaded on the vehicle. That weight may not safely exceed the available cargo and luggage load capacity calculated in step 4.

Example: steps 1 to 3

The following table shows examples on how to calculate total and cargo load capacities with varying seating configurations and number and size of occupants. The following examples use a maximum load of 1,500 lbs (680 kg). **This is for illustration purposes only.** Make sure you are using the actual load limit for your vehicle stated on your vehicle's Tire and Loading Information placard (▷ page 412).

The greater the combined weight of the occupants, the lower the maximum luggage load.

Additional information when towing a trailer (▷ page 257).

Step 1

	Example 1	Example 2	Example 3
Combined maximum weight of occupants and cargo (data from the Tire and Loading Information placard)	1500 lbs (680 kg)	1500 lbs (680 kg)	1500 lbs (680 kg)

Step 2

	Example 1	Example 2	Example 3
Number of people in the vehicle (driver and occupants)	5	3	1
Distribution of the occupants	Front: 2 Rear: 3	Front: 1 Rear: 2	Front: 1
Weight of the occupants	Occupant 1: 150 lbs (68 kg) Occupant 2: 180 lbs (82 kg) Occupant 3: 160 lbs (73 kg) Occupant 4: 140 lbs (63 kg) Occupant 5: 120 lbs (54 kg)	Occupant 1: 200 lbs (91 kg) Occupant 2: 190 lbs (86 kg) Occupant 3: 150 lbs (68 kg)	Occupant 1: 150 lbs (68 kg)
Gross weight of all occupants	750 lbs (340 kg)	540 lbs (245 kg)	150 lbs (68 kg)

Step 3

	Example 1	Example 2	Example 3
Permissible load (maximum gross vehicle weight rating from the Tire and Loading Information placard minus the gross weight of all occupants)	1500 lbs (680 kg) -750 lbs (340 kg) = 750 lbs (340 kg)	1500 lbs (680 kg) -540 lbs (245 kg) =960 lbs (435 kg)	1500 lbs (680 kg) -150 lbs (68 kg) = 1350 lbs (612 kg)

Vehicle identification plate

Even if you have calculated the total cargo carefully, you should still make sure that the gross vehicle weight rating and the gross axle weight rating are not exceeded. Details can be found on the vehicle identification plate on the B-pillar on the driver's side of the vehicle (▷ page 412).

Permissible gross vehicle weight: the gross weight of the vehicle, all passengers, load and trailer load/noseweight (if applicable) must not exceed the permissible gross vehicle weight.

Gross axle weight rating: the maximum permissible weight that can be carried by one axle (front or rear axle).

To ensure that your vehicle does not exceed the maximum permissible values (gross vehicle weight and maximum gross axle weight rating), have your loaded vehicle (including driver, occupants, cargo, and full trailer load if applicable) weighed on a suitable vehicle weighbridge.

Trailer load/noseweight

The trailer load/noseweight affects the gross weight of the vehicle. If a trailer is attached, the trailer load/noseweight is included in the load along with occupants and luggage. The trailer load/noseweight is usually approximately 8% of the gross weight of the trailer and its cargo.

All about wheels and tires

Uniform Tire Quality Grading Standards

Overview of Tire Quality Grading Standards

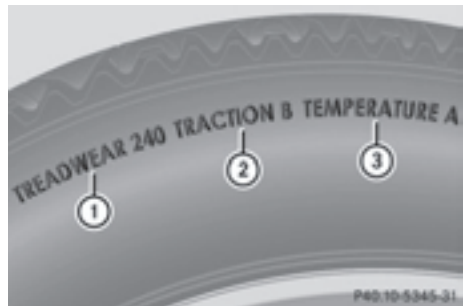

Uniform Tire Quality Grading Standards are U.S. government specifications. Their purpose is to provide drivers with uniform reliable information on tire performance data. Tire manufacturers have to grade tires using three performance factors: ① tread wear grade, ② traction grade and ③ temperature grade. These regulations do not apply to Canada. Nevertheless, all tires sold in North America are provided with the corresponding quality grading markings on the sidewall of the tire. Where applicable, the tire grading information can be found on the tire sidewall between the tread shoulder and maximum tire width.

Example:

- **Treadwear grade:** 200
- **Traction grade:** AA
- **Temperature grade:** A

All passenger car tires must conform to the statutory safety requirements in addition to these grades.

- i** The actual values for tires are vehicle-specific and may deviate from the values in the illustration.

Treadwear

The treadwear grade is a comparative rating based on the wear rate of the tire when tested under controlled conditions on a specified U.S. government course. For example, a tire graded 150 would wear one and one-half times as well on the government test track as a tire graded 100.

The relative performance of tires depends upon the actual conditions of their use, however, and may depart significantly from the norm, due to variations in driving habits, service practices and differences in road characteristics and climate conditions.

Traction

WARNING

The traction grade assigned to this tire is based on straight-ahead braking traction tests, and does not include acceleration, cornering, hydroplaning, or peak traction characteristics.

- !** Avoid wheelspin. This can lead to damage to the drive train.

The traction grades, from highest to lowest, are AA, A, B, and C. Those grades represent the tire's ability to stop on a wet surface as measured under controlled conditions on specified government test surfaces of asphalt and concrete. A tire marked C may have poor traction performance.

The safe speed on a wet, snow covered or icy road is always lower than on dry road surfaces.

You should pay special attention to road conditions when temperatures are around freezing point.

Mercedes-Benz recommends a minimum tread depth of $\frac{1}{8}$ in (4 mm) on all four winter tires. Observe the legally required minimum tire tread depth (> page 401). Winter tires can reduce the braking distance on snow-covered surfaces in comparison with summer tires. The braking distance is still much further than on surfaces that are not icy or covered with snow. Take appropriate care when driving. Further information on winter tires (M+S tires) (> page 402).

Temperature

WARNING

The temperature grade for this tire is established for a tire that is properly inflated and not overloaded. Excessive speed, underinflation, or excessive loading, either separately or in combination, can cause excessive heat build-up and possible tire failure.

The temperature grades are A (the highest), B, and C. These represent the tire's resistance to the generation of heat and its ability to dissipate heat when tested under controlled conditions on a specified indoor laboratory test wheel. Sustained high temperature can cause the material of the tire to degenerate and reduce tire life, and excessive temperature can lead to sudden tire failure. The grade C corresponds to a level of performance which all passenger car tires must meet under the Federal Motor Vehicle Safety Standard No. 109. Grades B and A represent higher levels of performance on the laboratory test wheel than the minimum required by law.

Tire labeling

Overview

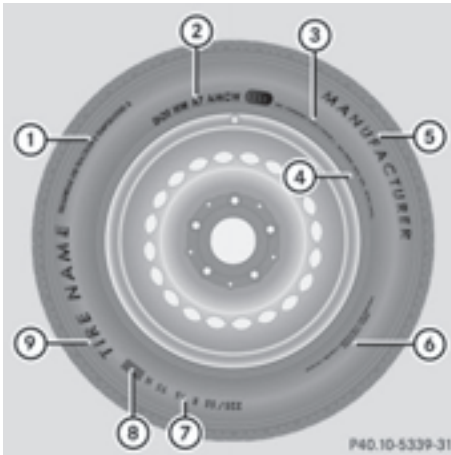

- ① Uniform Tire Quality Grading Standard (▷ page 421)
- ② DOT, Tire Identification Number (▷ page 420)
- ③ Maximum tire load (▷ page 419)
- ④ Maximum tire pressure (▷ page 406)
- ⑤ Manufacturer
- ⑥ Tire material (▷ page 420)
- ⑦ Tire size designation, load-bearing capacity and speed index (▷ page 417)
- ⑧ Load index (▷ page 419)
- ⑨ Tire name

The markings described above are on the tire in addition to the tire name (sales designation) and the manufacturer's name.

- ⓘ Tire data is vehicle-specific and may deviate from the data in the example.

Tire size designation, load-bearing capacity and speed rating

⚠ WARNING

Exceeding the stated tire load-bearing capacity and the approved maximum speed could lead to tire damage or the tire bursting. There is a risk of accident.

Therefore, only use tire types and sizes approved for your vehicle model. Observe the tire load rating and speed rating required for your vehicle.



- ① Tire width
- ② Nominal aspect ratio in %
- ③ Tire code
- ④ Rim diameter
- ⑤ Load bearing index
- ⑥ Speed rating

General: depending on the manufacturer's standards, the size imprinted in the tire wall may not contain any letters or may contain one letter that precedes the size description. If there is no letter preceding the size description (as shown above): these are passenger vehicle tires according to European manufacturing standards.

If "P" precedes the size description: these are passenger vehicle tires according to U.S. manufacturing standards.

If "LT" precedes the size description: these are light truck tires according to U.S. manufacturing standards.

If "T" precedes the size description: these are compact emergency spare wheels at high tire pressure, to be used only temporarily in an emergency.

Tire width: tire width ① shows the nominal tire width in millimeters.

Height-width ratio: aspect ratio ② is the size ratio between the tire height and tire width and is shown in percent. The aspect

ratio is calculated by dividing the tire width by the tire height.

Tire code: tire code ③ specifies the tire type. "R" represents radial tires; "D" represents diagonal tires; "B" represents diagonal radial tires.

Optionally, tires with a maximum speed of over 149 mph (240 km/h) may have "ZR" in the size description, depending on the manufacturer (e.g. 245/40 ZR 18).

Rim diameter: rim diameter ④ is the diameter of the bead seat, not the diameter of the rim flange. The rim diameter is specified in inches (in).

Load-bearing index: load-bearing index ⑤ is a numerical code that specifies the maximum load-bearing capacity of a tire.

Do not overload the tires by exceeding the specified load limit. The maximum permissible load can be found on the vehicle's Tire and Loading Information placard on the B-pillar on the driver's side (▷ page 412).

Example:

Load-bearing index 91 indicates a maximum load of 1,356 lb (615 kg) that the tires can bear. For further information on the maximum tire load in kilograms and lbs, see (▷ page 419).

For further information on the load bearing index, see "Load index" (▷ page 419).

Speed rating: speed rating ⑥ specifies the approved maximum speed of the tire.

i Tire data is vehicle-specific and may deviate from the data in the example.

Regardless of the speed rating, always observe the speed limits. Drive carefully and adapt your driving style to the traffic conditions.

Summer tires

Index	Speed rating
Q	up to 100 mph (160 km/h)
R	up to 106 mph (170 km/h)

Index	Speed rating
S	up to 112 mph (180 km/h)
T	up to 118 mph (190 km/h)
H	up to 130 mph (210 km/h)
V	up to 149 mph (240 km/h)
W	up to 168 mph (270 km/h)
Y	up to 186 mph (300 km/h)
ZR...Y	up to 186 mph (300 km/h)
ZR...(Y)	over 186 mph (300 km/h)
ZR	over 149 mph (240 km/h)

- Optionally, tires with a maximum speed of over 149 mph (240 km/h) may have "ZR" in the size description, depending on the manufacturer (e.g. 245/40 ZR18).

The service specification is made up of load-bearing index ⑤ and speed rating ⑥.

- If the size description of your tire includes "ZR" and there are no service specifications, ask the tire manufacturer in order to find out the maximum speed.

If a service specification is available, the maximum speed is limited according to the speed rating in the service specification. Example: 245/40 ZR18 97 Y. In this example, "97 Y" is the service specification. The letter "Y" represents the speed rating. The maximum speed of the tire is limited to 186 mph (300 km/h).

- The size description for all tires with maximum speeds of over 186 mph (300 km/h) must include "ZR", **and** the service specification must be given in parentheses. Example: 275/40 ZR 18 (99 Y). Speed rating "(Y)" indicates that the maximum speed of the tire is over 186 mph (300 km/h). Ask the tire manufacturer about the maximum speed.

All-weather tires and winter tires

Index	Speed rating
Q M+S ²	up to 100 mph (160 km/h)
T M+S ²	up to 118 mph (190 km/h)
H M+S ²	up to 130 mph (210 km/h)
V M+S ²	up to 149 mph (240 km/h)

i Not all tires with the M+S marking provide the driving characteristics of winter tires. In addition to the M+S marking, winter tires also have the  snowflake symbol on the tire wall. Tires with this marking fulfill the requirements of the Rubber Manufacturers Association (RMA) and the Rubber Association of Canada (RAC) regarding the tire traction on snow. They have been especially developed for driving on snow.

An electronic speed limiter prevents your vehicle from exceeding the following speeds:

- all vehicles (except AMG vehicles): 130 mph (210 km/h)
- AMG vehicles: 155 mph (250 km/h)
- AMG vehicles with increased top speed: 174 mph (280 km/h)

The speed rating of tires mounted at the factory may be higher than the maximum speed that the electronic speed limiter permits.

Make sure that your tires have the required speed rating, e.g. when buying new tires. The required speed rating for your vehicle can be found in the "Tires" section (▷ page 428).

Further information about reading tire data can be obtained from any qualified specialist workshop.

Load index



In addition to the load bearing index, load index **1** may be imprinted after the letters that identify the speed index **6** on the sidewall of the tire (▷ page 417).

- If no specification is given: no text (as in the example above), represents a standard load (SL) tire
- XL or Extra Load: represents a reinforced tire
- Light Load: represents a light load tire
- C, D, E: represents a load range that depends on the maximum load that the tire can carry at a certain pressure

i Tire data is vehicle-specific and may deviate from the data in the example.

Maximum load rating

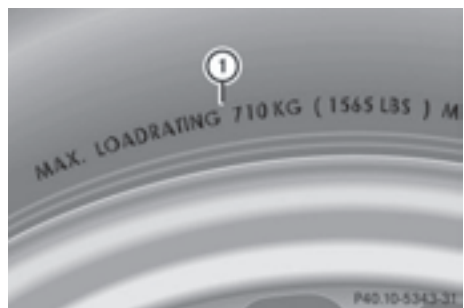

Maximum tire load **1** is the maximum permissible weight for which the tire is approved. Do not overload the tires by exceeding the specified load limit. The maximum permissi-

² Or M+S  for winter tires.

ble load can be found on the vehicle's Tire and Loading Information placard on the B-pillar on the driver's side (▷ page 412).

- i** The actual values for tires are vehicle-specific and may deviate from the values in the illustration.

DOT, Tire Identification Number (TIN)

U.S. tire regulations prescribe that every tire manufacturer or retreader must imprint a TIN in or on the sidewall of every tire produced.



The TIN is a unique identification number. The TIN enables the tire manufacturers or retreaders to inform purchasers of recalls and other safety-relevant matters. It makes it possible for the purchaser to easily identify the affected tires.

The TIN is made up of manufacturer identification code (2), tire size (3), tire type code (4) and manufacturing date (5).

DOT (Department of Transportation): tire symbol (1) indicates that the tire complies with the requirements of the U.S. Department of Transportation.

Manufacturer identification code: manufacturer identification code (2) provides details on the tire manufacturer. New tires have a code with two symbols. Retreaded tires have a code with four symbols.

For further information about retreaded tires, see (▷ page 428).

Tire size: identifier (3) describes the tire size.

Tire type code: tire type code (4) can be used by the manufacturer as a code to describe specific characteristics of the tire.

Date of manufacture: date of manufacture (5) provides information about the age of a tire. The first and second positions represent the week of manufacture, starting with "01" for the first calendar week. Positions three and four represent the year of manufacture. For example, a tire that is marked with "3208", was manufactured in week 32 in 2008.

- i** Tire data is vehicle-specific and may deviate from the data in the example.

Tire characteristics



This information describes the type of tire cord and the number of layers in sidewall (1) and under tire tread (2).

- i** Tire data is vehicle-specific and may deviate from the data in the example.

Definition of terms for tires and loading

Tire ply composition and material used

Describes the number of plies or the number of layers of rubber-coated fabric in the tire tread and sidewall. These are made of steel, nylon, polyester and other materials.

Bar

Metric unit for tire pressure. 14.5038 pounds per square inch (psi) and 100 kilopascals (kPa) are the equivalent of 1 bar.

DOT (Department of Transportation)

DOT marked tires fulfill the requirements of the United States Department of Transportation.

Normal occupant weight

The number of occupants which the vehicle is designed for, multiplied by 68 kilograms (150 lb).

Uniform Tire Quality Grading Standards

A uniform standard to grade the quality of tires with regards to tread quality, tire traction and temperature characteristics. Ratings are determined by tire manufacturers using U.S. government testing procedures. The ratings are molded into the sidewall of the tire.

Recommended tire pressure

The recommended tire pressure applies to the tires mounted at the factory.

The Tire and Loading Information placard contains the recommended tire pressures for cold tires on a fully loaded vehicle and for the maximum permissible vehicle speed.

The tire pressure table contains the recommended pressures for cold tires for various operating conditions, i.e. differing load and speed conditions.

Increased vehicle weight due to optional equipment

This is the combined weight of all standard and optional equipment available for the vehicle, regardless of whether it is actually installed on the vehicle or not.

Rim

This is the part of the wheel on which the tire is mounted.

GAWR (Gross Axle Weight Rating)

The GAWR is the maximum gross axle weight rating. The actual load on an axle must never exceed the gross axle weight rating. The gross axle weight rating can be found on the vehicle identification plate on the B-pillar on the driver's side.

Speed rating

The speed rating is part of the tire identification. It specifies the speed range for which the tire is approved.

GTW (Gross Trailer Weight)

The GTW is the weight of a trailer including the weight of the load, luggage, accessories etc. on the trailer.

GVW (Gross Vehicle Weight)

The gross vehicle weight includes the weight of the vehicle including fuel, tools, the spare wheel, accessories installed, occupants, luggage and the drawbar noseweight, if applicable. The gross vehicle weight must not exceed the gross vehicle weight rating GVWR as specified on the vehicle identification plate on the B-pillar on the driver's side.

GVWR (Gross Vehicle Weight Rating)

The GVWR is the maximum permissible gross weight of a fully loaded vehicle (the weight of the vehicle including all accessories, occupants, fuel, luggage and the drawbar noseweight, if applicable). The gross vehicle weight rating is specified on the vehicle identification plate on the B-pillar on the driver's side.

Maximum loaded vehicle weight

The maximum weight is the sum of:

- the curb weight of the vehicle
- the weight of the accessories
- the load limit
- the weight of the factory installed optional equipment

Kilopascal (kPa)

Metric unit for tire pressure. 6.9 kPa corresponds to 1 psi. Another unit for tire pressure is bar. There are 100 kilopascals (kPa) to 1 bar.

Load index

In addition to the load-bearing index, the load index may also be imprinted on the sidewall of

the tire. This specifies the load-bearing capacity more precisely.

Curb weight

The weight of a vehicle with standard equipment including the maximum capacity of fuel, oil and coolant. It also includes the air-conditioning system and optional equipment if these are installed in the vehicle, but does not include passengers or luggage.

Maximum load rating

The maximum tire load is the maximum permissible weight in kilograms or lbs for which a tire is approved.

Maximum permissible tire pressure

Maximum permissible tire pressure for one tire.

Maximum load on one tire

Maximum load on one tire. This is calculated by dividing the maximum axle load of one axle by two.

PSI (pounds per square inch)

A standard unit of measure for tire pressure.

Aspect ratio

Relationship between tire height and tire width in percent.

Tire pressure

This is pressure inside the tire applying an outward force to each square inch of the tire's surface. The tire pressure is specified in pounds per square inch (psi), in kilopascal (kPa) or in bar. The tire pressure should only be corrected when the tires are cold.

Cold tire pressure

The tires are cold:

- if the vehicle has been parked without direct sunlight on the tires for at least three hours and
- if the vehicle has been driven for less than 1 mile (1.6 km).

Tread

The part of the tire that comes into contact with the road.

Bead

The tire bead ensures that the tire sits securely on the wheel. There are several steel wires in the bead to prevent the tire from coming loose from the wheel rim.

Sidewall

The part of the tire between the tread and the bead.

Weight of optional extras

The combined weight of those optional extras that weigh more than the replaced standard parts and more than 2.3 kilograms (5 lbs). These optional extras, such as high-performance brakes, level control, a roof rack or a high-performance battery, are not included in the curb weight and the weight of the accessories.

TIN (Tire Identification Number)

This is a unique identifier which can be used by a tire manufacturer to identify tires, for example for a product recall, and thus identify the purchasers. The TIN is made up of the manufacturer's identity code, tire size, tire type code and the manufacturing date.

Load bearing index

The load bearing index (also load index) is a code that contains the maximum load bearing capacity of a tire.

Traction

Traction is the result of friction between the tires and the road surface.

TWR (Tongue Weight Rating)

The TWR specifies the maximum permissible weight that the ball coupling of the trailer tow hitch can support.

Treadwear indicators

Narrow bars (tread wear bars) that are distributed over the tire tread. If the tire tread is level with the bars, the wear limit of $\frac{1}{16}$ in (1.6 mm) has been reached.

Occupant distribution

The distribution of occupants in a vehicle at their designated seating positions.

Total load limit

Rated cargo and luggage load plus 68 kilograms (150 lb) multiplied by the number of seats in the vehicle.

Changing a wheel

Flat tire

You can find information on what to do in the event of a flat tire in the "Breakdown assistance" section (▷ page 383). Information on driving with MOExtended tires in the event of a flat tire can be found under "MOExtended tires (tires with run-flat characteristics)" (▷ page 383).

The "Breakdown assistance" section (▷ page 383) contains information and notes on how to deal with a flat tire. Information on driving with MOExtended tires in the event of a flat tire can be found under "MOExtended tires (tires with run-flat characteristics)" (▷ page 383).

Vehicles with an emergency spare wheel: in the event of a flat tire, mount the emergency spare wheel according to the description under "Mounting a wheel" (▷ page 424).

Rotating the wheels

WARNING

Interchanging the front and rear wheels may severely impair the driving characteristics if the wheels or tires have different dimensions. The wheel brakes or suspension components

may also be damaged. There is a risk of accident.

Rotate front and rear wheels only if the wheels and tires are of the same dimensions.

! On vehicles equipped with a tire pressure monitor, electronic components are located in the wheel.

Tire-mounting tools should not be used near the valve. This could damage the electronic components.

Only have tires changed at a qualified specialist workshop.

Always observe the instructions and safety notes in the "Mounting a wheel" section (▷ page 424).

The wear patterns on the front and rear tires differ, depending on the operating conditions. Rotate the wheels before a clear wear pattern has formed on the tires. Front tires typically wear more on the shoulders and the rear tires in the center.

If your vehicle's tire configuration allows, you can rotate the wheels according to the intervals in the tire manufacturer's warranty book in your vehicle documents. If no warranty book is available, the tires should be rotated every 3,000 to 6,000 miles (5,000 to 10,000 km), or earlier if tire wear requires. Do not change the direction of wheel rotation.

Clean the contact surfaces of the wheel and the brake disc thoroughly every time a wheel is rotated. Check the tire pressure and, if necessary, restart the tire pressure loss warning system or the tire pressure monitor.

Direction of rotation

Tires with a specified direction of rotation have additional benefits, e.g. if there is a risk of hydroplaning. You will only gain these benefits if the correct direction of rotation is observed.

An arrow on the sidewall of the tire indicates its correct direction of rotation.

Storing wheels

Store wheels that are not being used in a cool, dry and preferably dark place. Protect the tires from oil, grease, gasoline and diesel.

Cleaning the wheels

WARNING

The water jet from a circular jet nozzle (dirt blasters) can cause invisible exterior damage to the tires or chassis components. Components damaged in this way may fail unexpectedly. There is a risk of an accident.

Do not use power washers with circular jet nozzles to clean the vehicle. Have damaged tires or chassis components replaced immediately.

Mounting a wheel

Preparing the vehicle

- ▶ **Vehicle with emergency spare wheel:** when mounting the emergency spare wheel in the event of a flat tire, follow the additional notes on vehicle preparation under "Flat tire" (▷ page 383).
- ▶ Stop the vehicle on solid, non-slippery and level ground.
- ▶ Unload heavy luggage.
- ▶ Apply the electric parking brake manually.
- ▶ Bring the front wheels into the straight-ahead position.
- ▶ Shift the transmission to position **P**.
- ▶ **Vehicles with the AIRMATIC package:** make sure that highway level is selected (▷ page 211).
- ▶ Switch off the engine.
- ▶ **Vehicles without KEYLESS-GO:** remove the SmartKey from the ignition lock.

- ▶ **Vehicles with KEYLESS-GO:** open the driver's door.
The on-board electronics now have status **0**. This is the same as the SmartKey having been removed.

- ▶ **Vehicles with KEYLESS-GO:** remove the Start/Stop button from the ignition lock (▷ page 158).

- ▶ If included in the vehicle equipment, remove the tire-change tool kit from the vehicle.
- ▶ Secure the vehicle to prevent it from rolling away.

i Apart from certain country-specific variations, vehicles are not equipped with a tire-change tool kit. For information on which tools are required to perform a wheel change on your vehicle, consult an authorized Mercedes-Benz Center.

Necessary wheel-changing tools can include, for example:

- Jack
- Wheel chock
- Lug wrench

Securing the vehicle to prevent it from rolling away

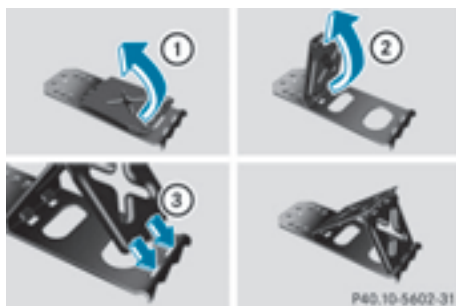

If your vehicle is equipped with a wheel chock, it can be found in the tire-change tool kit (▷ page 382).

The folding wheel chock is an additional securing measure to prevent the vehicle from rolling away, for example when changing a wheel.

- ▶ Fold both plates upwards ①.
- ▶ Fold out lower plate ②.
- ▶ Guide the lugs on the lower plate fully into the openings in base plate ③.



Securing the vehicle on level ground

- ▶ **On level ground:** place chocks or other suitable items under the front and rear of the wheel that is diagonally opposite the wheel you wish to change.



Securing the vehicle on slight downhill gradients

- ▶ **On light downhill gradients:** place chocks or other suitable items in front of the wheels of the front and rear axle.

Raising the vehicle

WARNING

If you do not position the jack correctly at the appropriate jacking point of the vehicle, the jack could tip over with the vehicle raised. There is a risk of injury.

Only position the jack at the appropriate jacking point of the vehicle. The base of the jack

must be positioned vertically, directly under the jacking point of the vehicle.

- ▶ **AMG vehicles with "Minispare" emergency spare wheel:** use the "Minispare" emergency spare wheel **only on the rear axle**. If you mount the "Minispare" emergency spare wheel on the front axle, this could result in damage to the brake system.

If a tire on the front axle is defective, an intact wheel from the rear axle must first be replaced with the "Minispare" emergency spare wheel. The faulty wheel on the front axle may only then be replaced by the undamaged wheel from the rear axle.

Make sure to note the placard on the "Minispare" emergency spare wheel.

- ▶ **The jack is designed exclusively for jacking up the vehicle at the jacking points.** Otherwise, your vehicle could be damaged.

Observe the following when raising the vehicle:

- To raise the vehicle, only use the vehicle-specific jack that has been tested and approved by Mercedes-Benz. If used incorrectly, the jack could tip over with the vehicle raised.
- The jack is designed only to raise and hold the vehicle for a short time while a wheel is being changed. It is not suited for performing maintenance work under the vehicle.
- Avoid changing the wheel on uphill and downhill slopes.
- Before raising the vehicle, secure it from rolling away by applying the parking brake and inserting wheel chocks. Do not disengage the parking brake while the vehicle is raised.
- The jack must be placed on a firm, flat and non-slip surface. On a loose surface, a large, flat, load-bearing underlay must be used. On a slippery surface, a non-slip underlay must be used, e.g. rubber mats.

- Do not use wooden blocks or similar objects as a jack underlay. Otherwise, the jack will not be able to achieve its load-bearing capacity due to the restricted height.
- Make sure that the distance between the underside of the tires and the ground does not exceed 1.2 in (3 cm).
- Do not place your hands or feet under the raised vehicle.
- Do not lie under the vehicle.
- Do not start the engine when the vehicle is raised.
- Never open or close a door or the tailgate when the vehicle is raised.
- Make sure that no persons are present in the vehicle when the vehicle is raised.



- ▶ Using lug wrench (1), loosen the bolts on the wheel you wish to change by about one full turn. Do not unscrew the bolts completely.

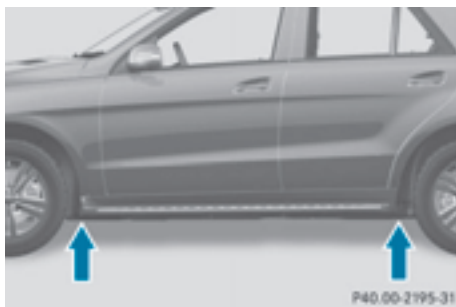

The jacking points are located just behind the front wheel housings and just in front of the rear wheel housings (arrows).

- ▶ Take the ratchet wrench out of the vehicle tool kit and place it on the hexagon nut of the jack so that the letters **AUF** are visible.

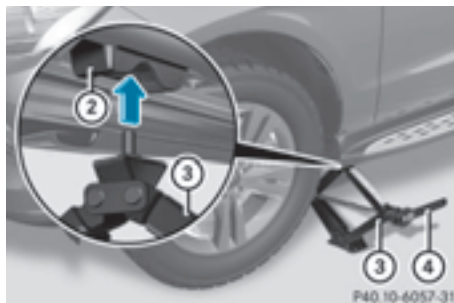

- ② Jacking point
- ③ Jack
- ④ Crank

- ▶ Position jack (3) at jacking point (2). The alignment bolt on the jack must be inserted into the intended opening on the jacking point.

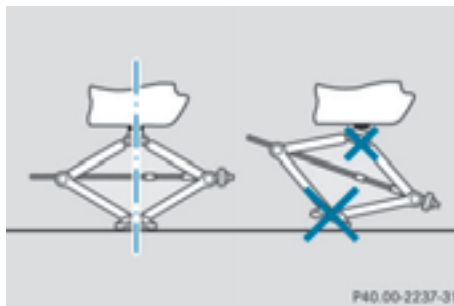

Example

- ▶ Make sure the foot of the jack is directly beneath the jacking point.
- ▶ Turn ratchet wrench (4) until jack (3) sits completely on jacking point (2) and the base of the jack lies evenly on the ground.
- ▶ Turn ratchet wrench (4) until the tire is raised a maximum of 1.2 in (3 cm) from the ground.

Removing a wheel

! Do not place wheel bolts in sand or on a dirty surface. The bolt and wheel hub threads could otherwise be damaged when you screw them in.



- ▶ Unscrew the uppermost wheel bolt completely.
- ▶ Screw alignment bolt ① into the thread instead of the wheel bolt.
- ▶ Unscrew the remaining wheel bolts fully.
- ▶ Remove the wheel.

Mounting a new wheel

WARNING

Oiled or greased wheel bolts or damaged wheel bolts/hub threads can cause the wheel bolts to come loose. As a result, you could lose a wheel while driving. There is a risk of accident.

Never oil or grease wheel bolts. In the event of damage to the threads, contact a qualified specialist workshop immediately. Have the damaged wheel bolts or hub threads replaced/renewed. Do not continue driving.

WARNING

If you tighten the wheel bolts or wheel nuts when the vehicle is raised, the jack could tip over. There is a risk of injury.

Only tighten the wheel bolts or wheel nuts when the vehicle is on the ground.

! To prevent damage to the paintwork, hold the wheel securely against the wheel hub while screwing in the first wheel bolt.

Always pay attention to the instructions and safety notes in the "Changing a wheel" section (▷ page 423).

Only use wheel bolts that have been designed for the wheel and the vehicle. For safety reasons, Mercedes-Benz recommends that you only use wheel bolts which have been approved for Mercedes-Benz vehicles and the respective wheel.

! Always use wheel bolts ② to mount the "Minispare" emergency spare wheel. Using other wheel bolts to mount the "Minispare" emergency spare wheel could damage the brake system.

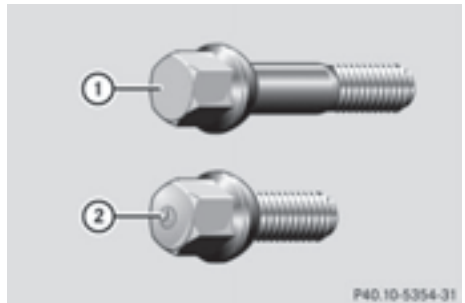

- ① Wheel bolts for all wheels supplied by the factory
- ② Wheel bolts for the collapsible spare wheel



- ▶ Clean the wheel and wheel hub contact surfaces.
- ▶ Slide the wheel to be mounted onto the alignment bolt and push it on.
- ▶ Tighten the wheel bolts until they are finger-tight.
- ▶ Unscrew the alignment bolt.
- ▶ Tighten the last wheel bolt until it is finger-tight.

Lowering the vehicle

WARNING

The wheels could work loose if the wheel nuts and bolts are not tightened to the specified tightening torque. There is a risk of accident. Have the tightening torque immediately checked at a qualified specialist workshop after a wheel is changed.

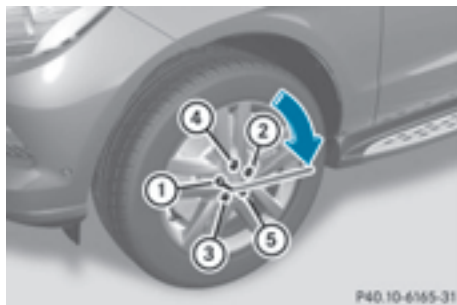

- ▶ Place the ratchet wrench onto the hexagon nut of the jack so that the letters **AB** are visible.
- ▶ Turn the ratchet wrench until the vehicle is once again standing firmly on the ground.
- ▶ Place the jack to one side.
- ▶ Tighten the wheel bolts evenly in a cross-wise pattern in the sequence indicated (① to ⑤). The tightening torque must be **110 lb-ft (150 Nm)**.
- ▶ Turn the jack back to its initial position.

- ▶ Stow the jack and the rest of the tire-change tool kit in the stowage well under the cargo compartment floor again.
- ▶ Check the tire pressure of the newly mounted wheel and adjust it if necessary. Observe the recommended tire pressure (▷ page 404).

i Vehicles with tire pressure monitor: all wheels mounted must be equipped with functioning sensors.

Wheel and tire combinations

General notes

- !** For safety reasons, Mercedes-Benz recommends that you only use tires and wheels which have been approved by Mercedes-Benz specifically for your vehicle.

These tires have been specially adapted for use with the control systems, such as ABS or ESP®, and are marked as follows:

- MO = Mercedes-Benz Original
- MOE = Mercedes-Benz Original Extended (tires featuring run-flat characteristics)
- MO1 = Mercedes-Benz Original (only certain AMG tires)

Mercedes-Benz Original Extended tires may only be used on wheels that have been specifically approved by Mercedes-Benz.

Only use tires, wheels or accessories tested and approved by Mercedes-Benz. Certain characteristics, e.g. handling, vehicle noise emissions or fuel consumption, may otherwise be adversely affected. In addition, when driving with a load, tire dimension variations could cause the tires to come into contact with the bodywork and axle components. This could result in damage to the tires or the vehicle.

Mercedes-Benz accepts no liability for damage resulting from the use of tires, wheels or accessories other than those tested and approved.

Information on tires, wheels and approved combinations can be obtained from any qualified specialist workshop.

! Retreaded tires are neither tested nor recommended by Mercedes-Benz, since previous damage cannot always be detected on retreaded tires. As a result, Mercedes-Benz cannot guarantee vehicle safety if retreaded tires are mounted. Do not mount used tires if you have no information about their previous usage.

Overview of abbreviations used in the following tire tables:

- BA: both axles
- FA: front axle
- RA: rear axle

The recommended pressures for various operating conditions can be found:

- on the Tire and Loading Information placard with the recommended tire pressures on the B-pillar on the driver's side
- in the tire pressure table on the inside of the fuel filler flap

Observe the notes on recommended tire pressures under various operating conditions (▷ page 404).

Check tire pressures regularly, and only when the tires are cold. Comply with the maintenance recommendations of the tire manufacturer in the vehicle document wallet.

Notes on the vehicle equipment – always equip the vehicle with:

- tires of the same size on a given axle (left/right)
- the same type of tires at a given time (summer tires, winter tires, MOExtended tires)

Vehicles with MOExtended tires are not equipped with a TIREFIT kit at the factory. It is therefore recommended that you additionally equip your vehicle with a TIREFIT kit if you mount tires that do not feature run-flat properties, e.g. winter tires. A TIREFIT kit may be obtained from a qualified specialist workshop.

i Not all wheel and tire combinations are available at the factory for all countries.

i On the following pages, you can find information on approved wheel rims and tire sizes for equipping your vehicle with winter tires. Winter tires are not available at the factory as standard equipment or optional extras.

If you would like to equip your vehicle with approved winter tires, you may also, in certain circumstances, require rims of the appropriate size. The size of the approved winter tires may deviate from that of the standard tires. This is dependent on the model and the equipment installed at the factory.

The tires and wheel rims, as well as further information, can be obtained at a qualified specialist workshop.

Tires

ML 250 BlueTEC 4MATIC

Summer tires

R 18

Tires	Alloy wheels
BA: 255/55 R 18 105 V	BA: 8.0 J x 18 H2 Wheel offset: 2.20 in (56 mm)
BA: 255/55 R 18 105 V	BA: 8.0 J x 18 H2 Wheel offset: 2.22 in (56.5 mm)

R 19

Tires	Alloy wheels
BA: 225/50 R 19 103 W ³	BA: 8.0 J x 19 H2 Wheel offset: 2.20 in (56 mm)
BA: 255/50 R 19 103 W ^{3, 4}	BA: 8.5 J x 19 H2 Wheel offset: 2.32 in (59 mm)
BA: 255/50 R 19 103 W ^{3, 4}	BA: 8.5 J x 19 H2 Wheel offset: 2.44 in (62 mm)

R 20

Tires	Alloy wheels
BA: 265/45 R 20 104 Y ^{3, 4}	BA: 9.0 J x 20 H2 Wheel offset: 2.24 in (57 mm)

R 21

Tires	Alloy wheels
BA: 265/40 R 21 105 Y XL ^{4, 5, 6}	BA: 9.0 J x 21 H2 Wheel offset: 2.09 in (53 mm)

³ Available as MOExtended tires.

⁴ Use of snow chains is not permitted. Observe the notes under "Snow chains".

⁵ Observe the notes on "Large wheels" under "General notes" in the "Wheel/tire combinations" section.

⁶ Only for vehicles with air suspension.

All-weather tires**R 18**

Tires	Alloy wheels
BA: 255/55 R 18 105 H M+S	BA: 8.0 J x 18 H2 Wheel offset: 2.20 in (56 mm)

R 19

Tires	Alloy wheels
BA: 225/50 R 19 103 W ³	BA: 8.5 J x 19 H2 Wheel offset: 2.44 in (62 mm)
BA: 255/50 R 19 107 H XL M+S ³	BA: 8.0 J x 19 H2 Wheel offset: 2.20 in (56 mm)
BA: 255/50 R 19 107 H XL M+S ^{3,7}	BA: 8.5 J x 19 H2 Wheel offset: 2.32 in (59 mm)
BA: 255/50 R 19 107 H XL M+S ^{3,8}	BA: 8.5 J x 19 H2 Wheel offset: 2.44 in (62 mm)

R 20

Tires	Alloy wheels
BA: 265/45 R 20 108 H XL M+S ^{3,8}	BA: 9.0 J x 20 H2 Wheel offset: 2.24 in (57 mm)

Winter tires**R 17**

Tires	Alloy wheels
BA: 235/65 R 17 104 H M+S 	BA: 7.5 J x 17 H2 Wheel offset: 2.09 in (53 mm)

R 18

Tires	Alloy wheels
BA: 255/55 R 18 105 H M+S 	BA: 8.0 J x 18 H2 Wheel offset: 2.20 in (56 mm)

³ Available as MOExtended tires.

⁷ Snow chains not permitted. Observe the notes under "Snow chains".

⁸ Snow chains not permitted. Observe the notes under "Snow chains".

R 19

Tires	Alloy wheels
BA: 225/50 R 19 103 W ³	BA: 8.5 J x 19 H2 Wheel offset: 2.44 in (62 mm)
BA: 255/50 R 19 107 H XL M+S  ³	BA: 8.0 J x 19 H2 Wheel offset: 2.20 in (56 mm)
BA: 255/50 R 19 107 H XL M+S  ^{3, 4}	BA: 8.5 J x 19 H2 Wheel offset: 2.32 in (59 mm)

R 20

Tires	Alloy wheels
BA: 265/45 R 20 108 V XL M+S  ⁴	BA: 9.0 J x 20 H2 Wheel offset: 2.05 in (52 mm)

ML 350

All-weather tires

R 18

Tires	Alloy wheels
BA: 255/55 R 18 105 H M+S	BA: 8.0 J x 18 H2 Wheel offset: 2.20 in (56 mm)

R 19

Tires	Alloy wheels
BA: 225/50 R 19 103 W ³	BA: 8.5 J x 19 H2 Wheel offset: 2.44 in (62 mm)
BA: 255/50 R 19 107 H XL M+S ³	BA: 8.0 J x 19 H2 Wheel offset: 2.20 in (56 mm)
BA: 255/50 R 19 107 H XL M+S ^{3, 8}	BA: 8.5 J x 19 H2 Wheel offset: 2.32 in (59 mm)
BA: 255/50 R 19 107 H XL M+S ^{3, 8}	BA: 8.5 J x 19 H2 Wheel offset: 2.44 in (62 mm)

³ Available as MOExtended tires.

⁴ Use of snow chains is not permitted. Observe the notes under "Snow chains".

⁸ Snow chains not permitted. Observe the notes under "Snow chains".

R 20

Tires	Alloy wheels
BA: 265/45 R 20 108 H XL M+S ^{3, 8}	BA: 9.0 J x 20 H2 Wheel offset: 2.24 in (57 mm)

Winter tires

R 18

Tires	Alloy wheels
BA: 255/55 R 18 105 H M+S 	BA: 8.0 J x 18 H2 Wheel offset: 2.20 in (56 mm)

R 19

Tires	Alloy wheels
BA: 225/50 R 19 103 W ³	BA: 8.5 J x 19 H2 Wheel offset: 2.44 in (62 mm)
BA: 255/50 R 19 107 H XL M+S  ³	BA: 8.0 J x 19 H2 Wheel offset: 2.20 in (56 mm)
BA: 255/50 R 19 107 H XL M+S  ^{3, 8}	BA: 8.5 J x 19 H2 Wheel offset: 2.32 in (59 mm)

R 20

Tires	Alloy wheels
BA: 265/45 R 20 108 V XL M+S  ⁴	BA: 9.0 J x 20 H2 Wheel offset: 2.05 in (52 mm)

³ Available as MOExtended tires.

⁸ Snow chains not permitted. Observe the notes under "Snow chains".

⁴ Use of snow chains is not permitted. Observe the notes under "Snow chains".

ML 350 4MATIC

All-weather tires

R 19

Tires	Alloy wheels
BA: 225/50 R 19 103 W ³	BA: 8.5 J x 19 H2 Wheel offset: 2.44 in (62 mm)
BA: 255/50 R 19 107 H XL M+S ³	BA: 8.0 J x 19 H2 Wheel offset: 2.20 in (56 mm)
BA: 255/50 R 19 107 H XL M+S ^{3, 8}	BA: 8.5 J x 19 H2 Wheel offset: 2.32 in (59 mm)
BA: 255/50 R 19 107 H XL M+S ^{3, 8}	BA: 8.5 J x 19 H2 Wheel offset: 2.44 in (62 mm)

R 20

Tires	Alloy wheels
BA: 265/45 R 20 108 H XL M+S ^{3, 8}	BA: 9.0 J x 20 H2 Wheel offset: 2.24 in (57 mm)

Winter tires

R 18

Tires	Alloy wheels
BA: 255/55 R 18 105 H M+S 	BA: 8.0 J x 18 H2 Wheel offset: 2.20 in (56 mm)

R 19

Tires	Alloy wheels
BA: 225/50 R 19 103 W ³	BA: 8.5 J x 19 H2 Wheel offset: 2.44 in (62 mm)
BA: 255/50 R 19 107 H XL M+S  ³	BA: 8.0 J x 19 H2 Wheel offset: 2.20 in (56 mm)
BA: 255/50 R 19 107 H XL M+S  ^{3, 8}	BA: 8.5 J x 19 H2 Wheel offset: 2.32 in (59 mm)

³ Available as MOExtended tires.⁸ Snow chains not permitted. Observe the notes under "Snow chains".

R 20

Tires	Alloy wheels
BA: 265/45 R 20 108 V XL M+S  4	BA: 9.0 J x 20 H2 Wheel offset: 2.05 in (52 mm)

ML 350 BlueTEC 4MATIC

All-weather tires

R 19

Tires	Alloy wheels
BA: 225/50 R 19 103 W ³	BA: 8.5 J x 19 H2 Wheel offset: 2.44 in (62 mm)
BA: 255/50 R 19 107 H XL M+S ³	BA: 8.0 J x 19 H2 Wheel offset: 2.20 in (56 mm)
BA: 255/50 R 19 107 H XL M+S ^{3, 8}	BA: 8.5 J x 19 H2 Wheel offset: 2.32 in (59 mm)
BA: 255/50 R 19 107 H XL M+S ^{3, 8}	BA: 8.5 J x 19 H2 Wheel offset: 2.44 in (62 mm)

R 20

Tires	Alloy wheels
BA: 265/45 R 20 108 H XL M+S ^{3, 8}	BA: 9.0 J x 20 H2 Wheel offset: 2.24 in (57 mm)

Winter tires

R 18



Tires	Alloy wheels
BA: 255/55 R 18 105 H M+S 	BA: 8.0 J x 18 H2 Wheel offset: 2.20 in (56 mm)

4 Use of snow chains is not permitted. Observe the notes under "Snow chains".

3 Available as MOExtended tires.

8 Snow chains not permitted. Observe the notes under "Snow chains".

R 19

Tires	Alloy wheels
BA: 225/50 R 19 103 W ³	BA: 8.5 J x 19 H2 Wheel offset: 2.44 in (62 mm)
BA: 255/50 R 19 107 H XL M+S  ³	BA: 8.0 J x 19 H2 Wheel offset: 2.20 in (56 mm)
BA: 255/50 R 19 107 H XL M+S  ^{3, 8}	BA: 8.5 J x 19 H2 Wheel offset: 2.32 in (59 mm)

R 20

Tires	Alloy wheels
BA: 265/45 R 20 108 V XL M+S  ⁴	BA: 9.0 J x 20 H2 Wheel offset: 2.05 in (52 mm)

ML 400

All-weather tires

R 19

Tires	Alloy wheels
BA: 225/50 R 19 103 W ³	BA: 8.5 J x 19 H2 Wheel offset: 2.44 in (62 mm)
BA: 255/50 R 19 107 H XL M+S ³	BA: 8.0 J x 19 H2 Wheel offset: 2.20 in (56 mm)
BA: 255/50 R 19 107 H XL M+S ^{3, 8}	BA: 8.5 J x 19 H2 Wheel offset: 2.32 in (59 mm)
BA: 255/50 R 19 107 H XL M+S ^{3, 8}	BA: 8.5 J x 19 H2 Wheel offset: 2.44 in (62 mm)

R 20

Tires	Alloy wheels
BA: 265/45 R 20 108 H XL M+S ^{3, 8}	BA: 9.0 J x 20 H2 Wheel offset: 2.24 in (57 mm)

³ Available as MOExtended tires.

⁸ Snow chains not permitted. Observe the notes under "Snow chains".

⁴ Use of snow chains is not permitted. Observe the notes under "Snow chains".

Winter tires

R 18

Tires	Alloy wheels
BA: 255/55 R 18 105 H M+S 	BA: 8.0 J x 18 H2 Wheel offset: 2.20 in (56 mm)

R 19

Tires	Alloy wheels
BA: 225/50 R 19 103 W ³	BA: 8.5 J x 19 H2 Wheel offset: 2.44 in (62 mm)
BA: 255/50 R 19 107 H XL M+S  ³	BA: 8.0 J x 19 H2 Wheel offset: 2.20 in (56 mm)
BA: 255/50 R 19 107 H XL M+S  ^{3, 8}	BA: 8.5 J x 19 H2 Wheel offset: 2.32 in (59 mm)

R 20

Tires	Alloy wheels
BA: 265/45 R 20 108 V XL M+S  ⁴	BA: 9.0 J x 20 H2 Wheel offset: 2.05 in (52 mm)

ML 400 4MATIC

All-weather tires

R 19

Tires	Alloy wheels
BA: 225/50 R 19 103 W ³	BA: 8.5 J x 19 H2 Wheel offset: 2.44 in (62 mm)
BA: 255/50 R 19 107 H XL M+S ³	BA: 8.0 J x 19 H2 Wheel offset: 2.20 in (56 mm)
BA: 255/50 R 19 107 H XL M+S ^{3, 8}	BA: 8.5 J x 19 H2 Wheel offset: 2.32 in (59 mm)
BA: 255/50 R 19 107 H XL M+S ^{3, 8}	BA: 8.5 J x 19 H2 Wheel offset: 2.44 in (62 mm)

³ Available as MOExtended tires.

⁸ Snow chains not permitted. Observe the notes under "Snow chains".

⁴ Use of snow chains is not permitted. Observe the notes under "Snow chains".

R 20

Tires	Alloy wheels
BA: 265/45 R 20 108 H XL M+S ^{3, 8}	BA: 9.0 J x 20 H2 Wheel offset: 2.24 in (57 mm)

Winter tires

R 18

Tires	Alloy wheels
BA: 255/55 R 18 105 H M+S 	BA: 8.0 J x 18 H2 Wheel offset: 2.20 in (56 mm)

R 19

Tires	Alloy wheels
BA: 225/50 R 19 103 W ³	BA: 8.5 J x 19 H2 Wheel offset: 2.44 in (62 mm)
BA: 255/50 R 19 107 H XL M+S  ³	BA: 8.0 J x 19 H2 Wheel offset: 2.20 in (56 mm)
BA: 255/50 R 19 107 H XL M+S  ^{3, 8}	BA: 8.5 J x 19 H2 Wheel offset: 2.32 in (59 mm)

R 20

Tires	Alloy wheels
BA: 265/45 R 20 108 V XL M+S  ⁴	BA: 9.0 J x 20 H2 Wheel offset: 2.05 in (52 mm)

³ Available as MOExtended tires.

⁸ Snow chains not permitted. Observe the notes under "Snow chains".

⁴ Use of snow chains is not permitted. Observe the notes under "Snow chains".

ML 550 4MATIC**All-weather tires****R 19**

Tires	Alloy wheels
BA: 225/50 R 19 103 W ³	BA: 8.5 J x 19 H2 Wheel offset: 2.44 in (62 mm)
BA: 255/50 R 19 107 H XL M+S ^{3, 8}	BA: 8.5 J x 19 H2 Wheel offset: 2.32 in (59 mm)
BA: 255/50 R 19 107 H XL M+S ^{3, 8}	BA: 8.5 J x 19 H2 Wheel offset: 2.44 in (62 mm)

R 20

Tires	Alloy wheels
BA: 265/45 R 20 108 H XL M+S ^{3, 8}	BA: 9.0 J x 20 H2 Wheel offset: 2.24 in (57 mm)

Winter tires**R 19**

Tires	Alloy wheels
BA: 225/50 R 19 103 W ³	BA: 8.5 J x 19 H2 Wheel offset: 2.44 in (62 mm)
BA: 255/50 R 19 107 H XL M+S  ³	BA: 8.0 J x 19 H2 Wheel offset: 2.20 in (56 mm)
BA: 255/50 R 19 107 H XL M+S  ^{3, 8}	BA: 8.5 J x 19 H2 Wheel offset: 2.32 in (59 mm)

R 20

Tires	Alloy wheels
BA: 265/45 R 20 108 V XL M+S  ⁴	BA: 9.0 J x 20 H2 Wheel offset: 2.05 in (52 mm)

³ Available as MOExtended tires.⁸ Snow chains not permitted. Observe the notes under "Snow chains".⁴ Use of snow chains is not permitted. Observe the notes under "Snow chains".

ML 63 AMG 4MATIC

Summer tires

R 20

Tires	Alloy wheels
BA: 265/45 ZR 20 108 Y XL ⁸	BA: 9.0 J x 20 H2 Wheel offset: 1.61 in (41 mm)

R 21

Tires	Alloy wheels
BA: 295/35 ZR 21 107 Y XL ⁸	BA: 10.0 J x 21 H2 Wheel offset: 2.20 in (56 mm)

Winter tires

R 20

Tires	Alloy wheels
BA: 255/45 R 20 105 V XL M+S 	BA: 9.0 J x 20 H2 Wheel offset: 1.61 in (41 mm)

R 21

Tires	Alloy wheels
BA: 295/35 R 21 107 V XL M+S  ⁸	BA: 10.0 J x 21 H2 Wheel offset: 2.20 in (56 mm)

Emergency spare wheel

Important safety notes

 **WARNING**

The wheel or tire size as well as the tire type of the spare wheel or emergency spare wheel and the wheel to be replaced may differ. Mounting an emergency spare wheel may severely impair the driving characteristics. There is a risk of an accident.

To avoid hazardous situations:

- adapt your driving style accordingly and drive carefully.
- never mount more than one spare wheel or emergency spare wheel that differs in size.
- only use a spare wheel or emergency spare wheel of a different size briefly.
- do not switch ESP[®] off.
- have a spare wheel or emergency spare wheel of a different size replaced at the nearest qualified specialist workshop. Observe that the wheel and tire dimensions as well as the tire type must be correct.

⁸ Snow chains not permitted. Observe the notes under "Snow chains".

! **AMG vehicles with "Minispare" emergency spare wheel:** use the "Minispare" emergency spare wheel **only on the rear axle**. If you mount the "Minispare" emergency spare wheel on the front axle, this could result in damage to the brake system. If a tire on the front axle is defective, an intact wheel from the rear axle must first be replaced with the "Minispare" emergency spare wheel. The defective wheel on the front axle can then be replaced with the intact wheel from the rear axle.

Make sure to note the placard on the "Minispare" emergency spare wheel.

When using an emergency spare wheel or spare wheel of a different size, you must not exceed the maximum speed of 50 mph (80 km/h).

Snow chains must not be mounted on emergency spare wheels.

General notes

Mounting the emergency spare wheel is described under "Mounting a wheel" (▷ page 424).

You should regularly check the pressure of the emergency spare wheel, particularly prior to long trips, and correct the pressure as necessary (▷ page 404). The value on the wheel or as given in the "Wheels and tires" section is valid (▷ page 443).

An emergency spare wheel may also be mounted against the direction of rotation. Observe the time restriction on use as well as the speed limitation specified on the emergency spare wheel.

Replace the tires after six years at the latest, regardless of wear. This also applies to the emergency spare wheel.

i When you are driving with the collapsible spare wheel mounted, the tire pressure loss warning system or the tire pressure monitor cannot function reliably. Only restart the tire pressure loss warning sys-

tem/the tire pressure monitor when the damaged wheel has been replaced with a new wheel.

Vehicles with tire pressure monitor: after mounting an emergency spare wheel, the system may still display the tire pressure of the removed wheel for a few minutes. The value displayed for the mounted emergency spare wheel is not the same as the current tire pressure of the emergency spare wheel.

Removing the emergency spare wheel

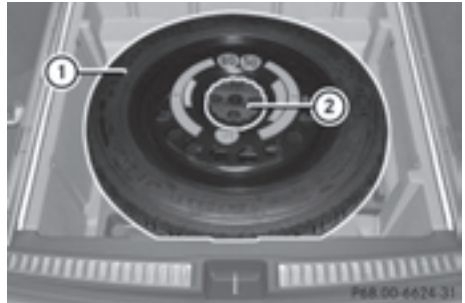

Emergency spare wheel (example: vehicle without lockable cargo compartment floor)

The "Minispare" emergency spare wheel can be found in the stowage well under the cargo compartment floor.

- ▶ Lift the cargo compartment floor up (▷ page 344).
- ▶ **Vehicles with trailer tow hitch:** remove the ball coupling stowage tray (▷ page 258).
- ▶ **Vehicles without a lockable cargo compartment floor:** turn emergency spare wheel retainer ② counter-clockwise and remove it.
- ▶ Remove "Minispare" emergency spare wheel ①.

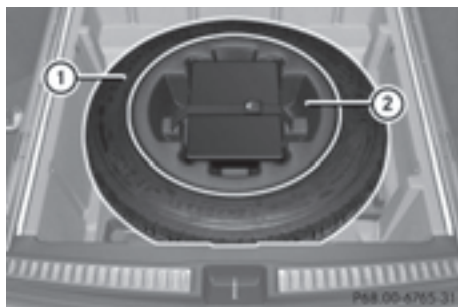

Vehicles with a lockable cargo compartment floor

- ▶ **Vehicles with a lockable cargo compartment floor:** remove the contents of stowage tray (2).
- ▶ Turn the central retaining screw of stowage tray (2) and "Minispare" emergency spare wheel (1) counter-clockwise and remove it.
- ▶ Remove stowage well (2).
- ▶ Remove "Minispare" emergency spare wheel (1).

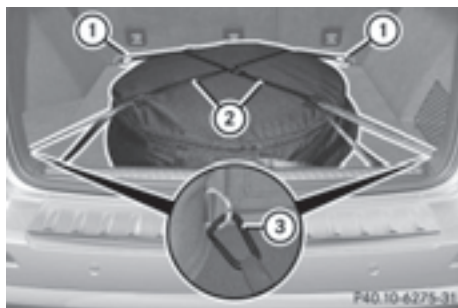

On vehicles with a Bang & Olufsen sound system, the "Minispare" emergency spare wheel is packed in the emergency spare wheel bag. The emergency spare wheel bag is secured to the cargo tie down rings in the cargo compartment.

- ▶ **To remove the emergency spare wheel:** open the tailgate.
- ▶ Detach fastening straps (2).
- ▶ Unhook retaining spring hooks (1) and (3) of fastening straps (2) from the lasing eyelets.

- ▶ Remove the emergency spare wheel bag with the "Minispare" emergency spare wheel.
- ▶ Open the emergency spare wheel bag and remove the "Minispare" emergency spare wheel.
- ▶ **To stow the emergency spare wheel:** place the "Minispare" emergency spare wheel into the emergency spare wheel bag and close the emergency spare wheel bag.
- ▶ Place the emergency spare wheel bag with the "Minispare" emergency spare wheel into the cargo compartment with the carrying strap at the back.
- ▶ Hook retaining spring hooks (1) and (3) of fastening straps (2) into the lasing eyelets.
- ▶ Tighten fastening straps (2).

Always observe the instructions and safety notes in the "Mounting a wheel" section (▷ page 424).

Technical data**All models (except the ML 550 4MATIC and ML 63 AMG 4MATIC)****"Minispare" emergency spare wheel**

Tires	Alloy wheels
T 155/90 R18 113 M Tire pressure: 420 kPa (4.2 bar/61 psi)	4.0 B x 18 H2 Wheel offset: 1.58 in (40 mm)
T 155/80 R19 114 M ⁹ Tire pressure: 420 kPa (4.2 bar/61 psi)	4.5 B x 19 H2 Wheel offset: 1.58 in (40 mm)

ML 550 4MATIC**"Minispare" emergency spare wheel**

Tires	Alloy wheels
T 155/80 R19 114 M Tire pressure: 420 kPa (4.2 bar/61 psi)	4.5 B x 19 H2 Wheel offset: 1.58 in (40 mm)

ML 63 AMG 4MATIC**"Minispare" emergency spare wheel**

Tires	Alloy wheels
T 155/80 R19 114 M Tire pressure: 420 kPa (4.2 bar/61 psi)	4.5 B x 19 H2 Wheel offset: 1.58 in (40 mm)

⁹ Only for vehicles with air suspension.

Useful information	446
Information regarding technical data	446
Identification plates	446
Service products and filling capacities	447
Vehicle data	456
Vehicle data for off-road driving	457
Trailer tow hitch	459

Useful information

- i** This Operator's Manual describes all models and all standard and optional equipment of your vehicle available at the time of publication of the Operator's Manual. Country-specific differences are possible. Please note that your vehicle may not be equipped with all features described. This also applies to safety-related systems and functions.
- i** Read the information on qualified specialist workshops (▷ page 29).

Information regarding technical data

- i** The data stated here specifically refers to a vehicle with standard equipment. Consult an authorized Mercedes-Benz Center for the data for all vehicle variants and trim levels.

Identification plates

Vehicle identification plate with vehicle identification number (VIN)



- Open the driver's door. You will see vehicle identification plate ①.

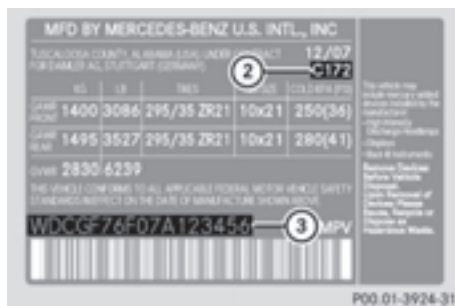

Example: vehicle identification plate (USA only)

- ② Vehicle model
- ③ VIN



Example: vehicle identification plate (Canada only)

- ② Vehicle model
- ③ VIN

- i** The data shown on the vehicle identification plate is used only as an example. This data is different for every vehicle and can deviate from the data shown here. You can find the data applicable to your vehicle on the vehicle identification plate.

VIN



- ▶ Open the front right-hand door.
- ▶ Open cover ① in the direction of the arrow and remove it.
You will see the VIN.

The VIN can also be found in the following locations:

- on the lower edge of the windshield
(▷ page 447)
- on the vehicle identification plate
(▷ page 446)

Engine number



- ① Emission control information plate, including the certification of both federal and Californian emissions standards
- ② Engine number (stamped into the crankcase)
- ③ VIN (on the lower edge of the windshield)

Service products and filling capacities

Important safety notes

⚠ WARNING

Service products may be poisonous and hazardous to health. There is a risk of injury.

Comply with instructions on the use, storage and disposal of service products on the labels of the respective original containers. Always store service products sealed in their original containers. Always keep service products out of the reach of children.

♻ Environmental note

Dispose of service products in an environmentally responsible manner.

Service products include the following:

- Fuels
- Exhaust gas aftertreatment additives, e.g. DEF
- Lubricants (e.g. engine oil, transmission oil)
- Coolant
- Brake fluid
- Windshield washer fluid
- Climate control system refrigerant

Comply with all valid regulations with respect to handling, storing, and disposing of service fluids.

Components and service products must be matched. You should therefore only use products that have been tested and approved by Mercedes-Benz.

Information on tested and approved products can be obtained at an authorized Mercedes-Benz Center or on the Internet at <http://bevo.mercedes-benz.com>.

You can recognize service products approved by Mercedes-Benz by the following inscription on the containers:

- MB-Freigabe (e.g. MB-Freigabe 229.51)
- MB Approval (e.g. MB Approval 229.51)

Other designations or recommendations indicate a level of quality or a specification in accordance with an MB Sheet Number (e.g. MB 229.5). They have not necessarily been approved by Mercedes-Benz.

Fuel

Important safety notes

WARNING

Fuel is highly flammable. If you handle fuel incorrectly, there is a risk of fire and explosion.

You must avoid fire, open flames, creating sparks and smoking. Switch off the engine and, if applicable, the auxiliary heating before refueling.

WARNING

Fuel is poisonous and hazardous to health. There is a risk of injury.

You must make sure that fuel does not come into contact with your skin, eyes or clothing and that it is not swallowed. Do not inhale fuel vapors. Keep fuel away from children.

If you or others come into contact with fuel, observe the following:

- Wash away fuel from skin immediately using soap and water.
- If fuel comes into contact with your eyes, immediately rinse them thoroughly with clean water. Seek medical assistance without delay.
- If fuel is swallowed, seek medical assistance without delay. Do not induce vomiting.
- Immediately change out of clothing which has come into contact with fuel.

Tank capacity

Model	Total capacity
All models	24.6 US gal (93.0 l)

Model	Of which reserve
AMG vehicles	Approx. 3.7 US gal (14.0 l)
All other models	Approx. 3.2 US gal (12.0 l)

Gasoline

Fuel grade

 Do not use diesel to refuel vehicles with a gasoline engine. Do not switch on the ignition if you accidentally refuel with the wrong fuel. Otherwise, the fuel will enter the fuel system. Even small amounts of the wrong fuel could result in damage to the fuel system and the engine. Notify a qualified specialist workshop and have the fuel tank and fuel lines drained completely.

 Only refuel using unleaded premium grade gasoline with at least 91 AKI/95 RON.

 Only use the fuel recommended. Operating the vehicle with other fuels can lead to engine failure.

 Do not use the following:

- E85 (gasoline with 85% ethanol)
- E100 (100% ethanol)
- M15 (gasoline with 15% methanol)
- M30 (gasoline with 30% methanol)
- M85 (gasoline with 85% methanol)
- M100 (100% methanol)

- Gasoline with metalliferous additives
- Diesel

Do not mix such fuels with the fuel recommended for your vehicle. Do not use additives. This can otherwise lead to engine damage. This does not include cleaning additives for the removal and prevention of residue build-up. Gasoline may only be mixed with cleaning additives recommended by Mercedes-Benz; see "Additives". You can obtain further information from any authorized Mercedes-Benz Center.

! To ensure the longevity and full performance of the engine, only premium-grade unleaded gasoline must be used.

If standard unleaded gasoline is unavailable and you have to refuel with unleaded gasoline of a lower grade, observe the following precautions:

- Only fill the fuel tank to half full with regular unleaded gasoline and fill the rest with premium-grade unleaded gasoline as soon as possible.
- Do not drive at the maximum speed.
- Avoid sudden acceleration and engine speeds over 3,000 rpm.

Using mixtures of methanol and ethanol is not permitted. E10 fuel or E15 fuel (unleaded gasoline with 10% or 15% ethanol) can be used. You will usually find information about the fuel grade on the pump. If you cannot find the label on the pump, ask the staff for assistance.

i For further information, consult a qualified specialist workshop or visit <http://www.mbusa.com> (USA only).

All other models: as a temporary measure, if the recommended fuel is not available, you may also use regular unleaded gasoline with an octane rating of 87 RON/91 MON. This may reduce engine performance and increase fuel consumption. Avoid driving at full throttle and sudden acceleration. Never refuel using fuel with a lower AKI.

Information on refueling (▷ page 178).

Additives

! Operating the engine with fuel additives added later can lead to engine failure. Do not mix fuel additives with fuel. This does not include additives for the removal and prevention of residue buildup. Gasoline must only be mixed with additives recommended by Mercedes-Benz. Comply with the instructions for use on the product label. More information about recommended additives can be obtained from any authorized Mercedes-Benz Center.

Mercedes-Benz recommends that you use branded fuels that have additives.

The quality of the fuel available in some countries may not be sufficient. Residue could build up in the injection system as a result. In such cases, and in consultation with an authorized Mercedes-Benz Center, the gasoline may be mixed with the cleaning additive recommended by Mercedes-Benz. You must observe the notes and mixing ratios specified on the container.

Diesel

Fuel grade

WARNING

If you mix diesel fuel with gasoline, the flash point is lower than that of pure diesel fuel. When the engine is running, exhaust system components could overheat without being noticed. There is a risk of fire.

Never refuel with gasoline. Never mix gasoline with diesel fuel.

! Refuel only using diesel fuel that conforms to European standard EN 590 or an equivalent specification. Fuel that does not conform to EN 590 can lead to increased wear and damage the engine and exhaust system.

! Do not use the following:

- marine diesel
- heating oil
- bio-diesel
- vegetable oil
- gasoline
- paraffin
- kerosene

Do not mix such fuels with diesel fuel and do not use any special additives. This can otherwise lead to engine damage.

! **Vehicles with diesel particle filters:** in countries outside the EU, only use low sulfur Euro diesel with a sulfur content of under 50 ppm. Otherwise, the emission control system could be damaged.

! **Vehicles without a diesel particle filter:** in countries where only diesel fuel with a high sulfur content is available, you will need to carry out your vehicle's oil change at shorter intervals. Further information on oil change intervals can be obtained at a qualified specialist workshop.

You will usually find information about the fuel grade on the pump. If you cannot find the label on the pump, ask the staff for assistance.

Information on refueling (▷ page 178).

Bio-diesel – FAME (fatty acid methyl ester)

Mercedes-Benz USA approves the use of bio-diesel B5 for all BlueTEC diesel engines. The concentration of bio-diesel in the ULSD may not exceed 5% by volume.

Pure bio-diesel and diesel fuel with a higher percentage of bio-diesel, such as B20, can damage the engine and the fuel system. For this reason, they are not approved.

For more information, consult the gas station staff. The bio-diesel B5 label on the gasoline pump must clearly state that the standard for ULSD has been fulfilled. If the label is not clear, do not refuel the vehicle.

Do not refuel your vehicle with fuels unless they have been approved by Mercedes-Benz. Information on refueling (▷ page 178).

Low outside temperatures

i Diesel fuel with improved cold flow properties is available during the winter months. Further information about fuel properties can be obtained from oil companies, e.g. at gas stations.

Flexible Fuel vehicles

Important safety notes

⚠ WARNING

Fuel is highly flammable. If you handle fuel incorrectly, there is a risk of fire and explosion.

You must avoid fire, open flames, creating sparks and smoking. Switch off the engine and, if applicable, the auxiliary heating before refueling.

⚠ WARNING

Fuel is poisonous and hazardous to health. There is a risk of injury.

You must make sure that fuel does not come into contact with your skin, eyes or clothing and that it is not swallowed. Do not inhale fuel vapors. Keep fuel away from children.

If you or others come into contact with fuel, observe the following:

- Wash away fuel from skin immediately using soap and water.
- If fuel comes into contact with your eyes, immediately rinse them thoroughly with clean water. Seek medical assistance without delay.
- If fuel is swallowed, seek medical assistance without delay. Do not induce vomiting.
- Immediately change out of clothing which has come into contact with fuel.

Flexible Fuel vehicles can be refueled with the following fuel types:

- premium-grade unleaded gasoline
- E85 fuel
- a mixture of E85 fuel and premium-grade unleaded gasoline

i Flexible Fuel vehicles can be recognized by the **Ethanol up to E85** sticker on the inside of the fuel filler flap.

Fuel consumption

The energy content of E85 fuel is less than that of the same amount of premium-grade gasoline. The amount of fuel consumed when operating the vehicle with E85 fuel is therefore higher than with premium-grade gasoline.

Maintenance

Inform your authorized Mercedes-Benz Center that you are operating or have operated the vehicle with E85 fuel.

Low outside temperatures

If the outside temperature is below 32 °F (0 °C), the starting procedure can take noticeably longer when operating with E85 fuel. E85 fuel is not suitable for use at outside temperatures under -4 °F (-20 °C).

DEF

Important safety notes

Comply with the important safety notes for service products when handling DEF (> page 447).

DEF is a water-soluble fluid for the exhaust gas aftertreatment of diesel engines. It is:

- not poisonous
- colorless and odorless
- not flammable

When you open the DEF container, small amounts of ammonia vapor may be released.

Ammonia vapors have a pungent odor and are particularly irritating to the skin, to mucous membranes and to the eyes. You may experience a burning sensation in your eyes, nose and throat. Coughing and watering of the eyes are possible.

Do not inhale ammonia vapors. Fill the DEF tank only in well-ventilated areas.

Low outside temperatures

DEF freezes at a temperature of approximately 12 °F (-11 °C). The vehicle is delivered from the factory equipped with a DEF pre-heating system. Winter operation can thus be guaranteed even at temperatures below 12 °F (-11 °C).

Additives

! Only use DEF in accordance with ISO 22241. Do not use additives with DEF and do not dilute DEF with water. This may destroy the BlueTEC exhaust gas aftertreatment system.

Purity

! Impurities in DEF (e.g. due to other service products, cleaning agents or dust) lead to:

- increased emission values
- damage to the catalytic converter
- engine damage
- malfunctions in the BlueTEC exhaust gas aftertreatment system

Assuring the purity of DEF is particularly important with respect to avoiding malfunctions in the BlueTEC exhaust gas aftertreatment system.

If DEF is pumped out of the DEF tank, e.g. during repair work, it must not be returned to the tank. The purity of the fluid can no longer be guaranteed.

Filling capacities

Model	Total capacity
ML 250 BlueTEC 4MATIC	7.3 US gal (27.5 l)
ML 350 Blue-TEC 4MATIC	

Engine oil

General notes

! Never use engine oil or an oil filter of a specification other than is necessary to fulfill the prescribed service intervals. Do not change the engine oil or oil filter in order to achieve longer replacement intervals than those prescribed. You could otherwise cause engine damage or damage to the exhaust gas aftertreatment.

Follow the instructions in the service interval display regarding the oil change. Otherwise, you may damage the engine and the exhaust gas aftertreatment.

When handling engine oil, observe the important safety notes on service products (▷ page 447).

The engine oils are matched to the performance of Mercedes-Benz engines and service intervals. You should therefore only use engine oils and oil filters that are approved for vehicles with maintenance systems.

For a list of approved engine oils and oil filters, consult an authorized Mercedes-Benz Center. Or visit the website <http://bevo.mercedes-benz.com>.

The table shows which engine oils have been approved for your vehicle.

Missing values were not available at time of going to print.

Model	Engine model	MB Approval
ML 350	276	229.5
ML 350 4MATIC	276	229.5
ML 400	276	229.5
ML 400 4MATIC	276	229.5
ML 550 4MATIC	278	229.5
ML 250 BlueTEC 4MATIC	651	228.51, 229.31, 229.51, 229.52
ML 350 Blue-TEC 4MATIC	642	228.51, 229.31, 229.51, 229.52
AMG vehicles	157	229.5

i MB approval is indicated on the oil containers.

Filling capacities

The following values refer to an oil change including the oil filter.

Model	Capacity
ML 350 ML 350 4MATIC ML 400 ML 400 4MATIC	7.4 US qt (7.0 l)
ML 550 4MATIC	9.0 US qt (8.5 l)
ML 250 BlueTEC 4MATIC	6.9 US qt (6.5 l)

Model	Capacity
ML 350 Blue-TEC 4MATIC	8.5 US qt (8.0 l)
AMG vehicles	Without external oil cooler: 9.0 US qt (8.5 l)

Additives

! Do not use any additives in the engine oil. This could damage the engine.

Engine oil viscosity

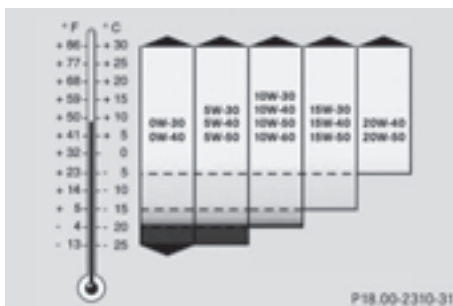

Viscosity describes the flow characteristics of a fluid. If an engine oil has a high viscosity, this means that it is thick; a low viscosity means that it is thin.

Select an engine oil with an SAE classification (viscosity) suitable for the prevailing outside temperatures. The table shows you which SAE classifications are to be used. The low-temperature characteristics of engine oils can deteriorate significantly, e.g. as a result of aging, soot and fuel deposits. It is therefore strongly recommended that you carry out regular oil changes using an approved engine oil with the appropriate SAE classification.

Brake fluid

! WARNING

The brake fluid constantly absorbs moisture from the air. This lowers the boiling point of the brake fluid. If the boiling point of the brake

fluid is too low, vapor pockets may form in the brake system when the brakes are applied hard. This would impair braking efficiency. There is a risk of an accident.

You should have the brake fluid renewed at the specified intervals.

Comply with the important safety notes for service products when handling brake fluid (▷ page 447).

The brake fluid change intervals can be found in the Maintenance Booklet.

Only use brake fluid approved by Mercedes-Benz according to MB Approval 331.0.

Information about approved brake fluid can be obtained at any qualified specialist workshop or on the Internet at <http://bevo.mercedes-benz.com>.

i Have the brake fluid regularly replaced at a qualified specialist workshop and the replacement confirmed in the Maintenance Booklet.

Coolant

Important safety notes

! WARNING

If antifreeze comes into contact with hot components in the engine compartment, it may ignite. There is a risk of fire and injury.

Let the engine cool down before you add antifreeze. Make sure that antifreeze is not spilled next to the filler neck. Thoroughly clean the antifreeze from components before starting the engine.

! Only add coolant that has been premixed with the desired antifreeze protection. You could otherwise damage the engine.

Further information on coolants can be found in the Mercedes-Benz Specifications for Service Products, MB BeVo 310.1, e.g. on the Internet at <http://bevo.mercedes-benz.com>. Or contact a qualified specialist workshop.

! Always use a suitable coolant mixture, even in countries where high temperatures prevail.

Otherwise, the engine cooling system is not sufficiently protected from corrosion and overheating.

i Have the coolant regularly replaced at a qualified specialist workshop and the replacement confirmed in the Maintenance Booklet.

Comply with the important safety precautions for service products when handling coolant (> page 447).

The coolant is a mixture of water and antifreeze/corrosion inhibitor. It performs the following tasks:

- corrosion protection
- antifreeze protection
- raising the boiling point

If the coolant has antifreeze protection down to -35 °F (-37 °C), the boiling point of the coolant during operation is approximately 266 °F (130 °C).

The antifreeze/corrosion inhibitor concentration in the engine cooling system should:

- be at least 50%. This will protect the engine cooling system against freezing down to approximately -35 °F (-37 °C).
- not exceed 55% (antifreeze protection down to -49 °F [-45 °C]). Otherwise, heat will not be dissipated as effectively.

Mercedes-Benz recommends an antifreeze/corrosion inhibitor concentrate in accordance with MB Specifications for Service Products 310.1.

i When the vehicle is first delivered, it is filled with a coolant mixture that ensures adequate antifreeze and corrosion protection.

i The coolant is checked with every maintenance interval at a qualified specialist workshop.

Filling capacities

Model	Capacity
ML 350 ML 350 4MATIC	Approx. 11.1 US qt (10.5 l)
ML 400 ML 400 4MATIC	Approx. 10.9 US qt (10.3 l)
ML 550 4MATIC	Approx. 12.0 US qt (11.4 l)
ML 250 BlueTEC 4MATIC	Approx. 10.7 US qt (10.1 l)
ML 350 Blue-TEC 4MATIC	Approx. 12.2 US qt (11.5 l)
AMG vehicles	Approx. 13.1 US qt (12.4 l)

i Use MB 325.0 or MB 326.0 antifreeze/corrosion inhibitor.

Windshield washer system

Important safety notes

WARNING

Windshield washer concentrate could ignite if it comes into contact with hot engine components or the exhaust system. There is a risk of fire and injury.

Make sure that no windshield washer concentrate is spilled next to the filler neck.

! Do not add distilled or de-ionized water to the washer fluid container. Otherwise, the level sensor may be damaged.

! Only MB SummerFit and MB WinterFit washer fluid should be mixed together. The spray nozzles may otherwise become blocked.

When handling washer fluid, observe the important safety notes on service products (> page 447).

At temperatures above freezing:

- ▶ Fill the washer fluid reservoir with a mixture of water and windshield washer fluid, e.g. MB SummerFit.

Add 1 part MB SummerFit to 100 parts water.

At temperatures below freezing:

- ▶ Fill the washer fluid reservoir with a mixture of water and washer fluid, e.g. MB WinterFit.

Adapt the mixing ratio to the outside temperature.

- Down to 14 °F (-10 °C): mix 1 part MB WinterFit to 2 parts water.
- Down to -4 °F (-20 °C): mix 1 part MB WinterFit to 1 part water.
- Down to -20.2 °F (-29 °C): mix 2 parts MB WinterFit to 1 part water.

- ❗ Add windshield washer fluid, e.g. MB SummerFit or MB WinterFit, to the washer fluid all year round.

Climate control system refrigerant

Important safety notes

The climate control system of your vehicle is filled with refrigerant R-134a.

The instruction label regarding the refrigerant type used can be found on the radiator cross member.

- ❗ Only the refrigerant R-134a and the PAG oil approved by Mercedes-Benz may be used. The approved PAG oil may not be mixed with any other PAG oil that is not approved for R-134a refrigerant. Otherwise, the climate control system may be damaged.

Service work, such as topping up refrigerant or replacing components, may only be carried out by a qualified specialist workshop. All applicable regulations must be adhered to, SAE standard J639 included.

Always have work on the climate control system carried out at a qualified specialist workshop.

Refrigerant instruction label



Example: refrigerant instruction label

- ① Warning symbol
- ② Refrigerant filling capacity
- ③ Applicable standards
- ④ PAG oil part number
- ⑤ Type of refrigerant

Warning symbol ① advises you about:

- possible dangers
- having service work carried out at a qualified specialist workshop

Filling capacities

Missing values were not available at time of going to print.

AMG vehicles	Capacity
Refrigerant	
PAG oil	
All other models	Capacity
Refrigerant	37.0 ± 0.4 oz (1050 ± 10 g)
PAG oil	4.9 ± 0.4 oz (140 ± 10 g)

Vehicle data

General notes

Please note that for the specified vehicle data:

- the heights specified may vary as a result of:
 - tires
 - load
 - condition of the suspension
 - optional equipment
- optional equipment reduces the maximum payload.

Observe the information relating to level control:

- AIRMATIC package (▷ page 213)
- ON&OFFROAD package (▷ page 206)

Dimensions and weights



	① Opening height	② Max. headroom
AMG vehicles	84.6 in - 87.0 in (2148 mm - 2211 mm)	79.0 in (2006 mm)

All other models with:	① Opening height	② Max. headroom
Steel suspension	86.4 in (2195 mm)	78.2 in (1987 mm)
AIRMATIC package	84.3 in - 87.2 in (2140 mm - 2215 mm)	76.0 in - 79.0 in (1931 mm - 2006 mm)
ON&OFF-ROAD package	84.3 in - 88.4 in (2140 mm - 2245 mm)	76.0 in - 80.2 in (1931 mm - 2036 mm)

AMG vehicles

Vehicle length	189.6 in (4817 mm)
Vehicle width including exterior mirrors	84.3 in (2141 mm)
Maximum vehicle height	71.4 in (1815 mm)
Minimum vehicle height	69.0 in (1752 mm)
Wheelbase	114.8 in (2915 mm)
Maximum ground clearance	9.2 in (233 mm)
Minimum ground clearance	6.8 in (172 mm)
Turning radius	38.7 ft (11.80 m)
Maximum roof load	220 lb (100 kg)

All other models	
Vehicle width including exterior mirrors	84.3 in (2141 mm)
Maximum vehicle height (steel suspension)	70.7 in (1796 mm)
Maximum vehicle height (AIRMATIC package)	71.6 in (1818 mm)
Maximum vehicle height (ON&OFFROAD package)	72.8 in (1848 mm)
Minimum vehicle height (highway driving level)	69.2 in (1758 mm)
Wheelbase	114.8 in (2915 mm)
Minimum ground clearance (steel suspension)	8.0 in (202 mm)
Maximum ground clearance (AIRMATIC package)	10.0 in (255 mm)
Maximum ground clearance (ON&OFFROAD package)	11.2 in (285 mm)
Minimum ground clearance (AIRMATIC package) (ON&OFFROAD package)	7.1 in (180 mm)
Turning radius	38.7 ft (11.80 m)
Maximum roof load	220 lb (100 kg)

Model	Vehicle length
ML 550 4MATIC	190.5 in (4839 mm)
All other models	189.1 in (4804 mm)

Vehicle data for off-road driving

Fording depth



① Fording depth

	Fording depth
Steel-sprung vehicles	20 in (50 cm)
Vehicles with the AIR-MATIC package	
Raised level	20 in (50 cm)
Vehicles with the ON&OFF-ROAD package	
Off-road level 1	20 in (50 cm)
Off-road level 2	20 in (50 cm)
Off-road level 3	23.6 in (60 cm)
AMG vehicles	
Raised level	20 in (50 cm)

For more information about off-road fording, see (▷ page 190).

Approach/departure angle



All vehicles (except vehicles with AMG bodystyling)

	①	②
Steel-sprung vehicles	26°	25°
Vehicles with the AIRMATIC package		
Highway level	23°	23°
Raised level	30°	28°
Vehicles with the ON&OFFROAD package		
Highway level	23°	23°
Off-road level 1	26°	25°
Off-road level 2	30°	28°
Off-road level 3	31°	29°
AMG vehicles		
Highway level (in sports mode with the AMG adaptive suspension system activated)	19°	21°
Raised level	23°	24°

Vehicles with AMG bodystyling

	①	②
Steel-sprung vehicles	25°	25°
Vehicles with the AIRMATIC package		
Highway level	22°	22°
Raised level	28°	27°
Vehicles with the ON&OFFROAD package		
Highway level	22°	22°
Off-road level 1	25°	24°
Off-road level 2	28°	27°
Off-road level 3	29°	29°

For further information about approach/departure angles, see (▷ page 194).

Maximum gradient-climbing capability

Note that the vehicle's gradient-climbing capability depends on the off-road conditions and the road surface conditions.

Vehicles with the ON&OFFROAD package: the maximum gradient climbing ability is 100% when the LOW RANGE off-road gear is selected.

Vehicles without the ON&OFFROAD package: the maximum gradient climbing ability is 80%.

Accelerate carefully and make sure that the wheels do not spin when driving on steep terrain.

- ① If the load on the front axle is reduced when pulling away on a steep uphill slope, the front wheels have a tendency to spin. 4ETS recognizes this and brakes the

wheels accordingly. The rear wheel torque is increased, making it easier to drive off.

For further information about the maximum gradient climbing ability, see (▷ page 195).

Trailer tow hitch

Mounting dimensions

! If you have a trailer tow hitch retrofitted, changes to the cooling system and drive train may be necessary, depending on the vehicle type.

If you have a trailer tow hitch retrofitted, observe the anchorage points on the chassis frame.

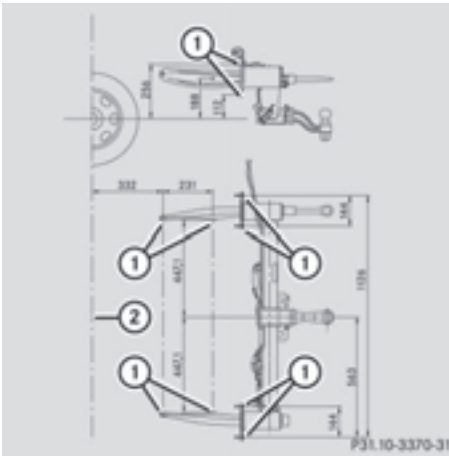

Anchorage points for the trailer tow hitch (example)

- ① Anchorage points
- ② Rear axle center line

Trailer loads

Trailer loads, trailer drawbar noseweights and axle loads

Missing values were not available at time of going to print.

	ML 250 BlueTEC 4MATIC
Permissible trailer load, unbraked	
Permissible trailer load, braked (at a minimum gradient-climbing capability of 12% from a standstill)	6613 lbs (3000 kg)
Maximum drawbar noseweight (the drawbar noseweight is not included in the trailer load)	529 lbs (240 kg)
Permissible rear axle load when towing a trailer	3637 lbs (1650 kg)

	ML 350 and ML 400
Permissible trailer load, unbraked	
Permissible trailer load, braked (at a minimum gradient-climbing capability of 12% from a standstill)	6613 lbs (3000 kg)
Maximum drawbar noseweight (the drawbar noseweight is not included in the trailer load)	529 lbs (240 kg)
Permissible rear axle load when towing a trailer	3527 lbs (1600 kg)

	ML 350 4MATIC, ML 400 4MATIC and ML 550 4MATIC
Permissible trailer load, unbraked	
Permissible trailer load, braked (at a minimum gradient-climbing capability of 12% from a standstill)	7198 lbs (3265 kg)
Maximum drawbar noseweight (the drawbar noseweight is not included in the trailer load)	575 lbs (261 kg)
Permissible rear axle load when towing a trailer	3527 lbs (1600 kg)

	ML 63 AMG 4MATIC
Permissible trailer load, unbraked	
Permissible trailer load, braked (at a minimum gradient-climbing capability of 12% from a standstill)	6724 lbs (3050 kg)
Maximum drawbar noseweight (the drawbar noseweight is not included in the trailer load)	309 lbs (140 kg)
Permissible rear axle load when towing a trailer	3858 lbs (1750 kg)

	ML 350 BlueTEC 4MATIC
Permissible trailer load, unbraked	
Permissible trailer load, braked (at a minimum gradient-climbing capability of 12% from a standstill)	7198 lbs (3265 kg)
Maximum drawbar noseweight (the drawbar noseweight is not included in the trailer load)	575 lbs (261 kg)
Permissible rear axle load when towing a trailer	3637 lbs (1650 kg)

The actual noseweight may not be higher than the value which is given. The value can be found on the trailer tow hitch or trailer identification plates. The lowest weight applies.

The maximum permissible trailer drawbar noseweight is the maximum weight with which the trailer drawbar can be loaded. Limit for Mercedes-Benz-approved trailer couplings.

Ball position

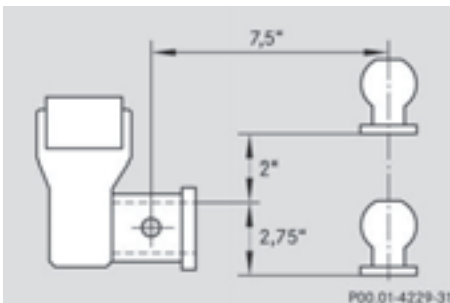

When choosing a ball coupling, the dimensions stated in the illustration must not be exceeded.

Ball position of the ball coupling

