



Operator's Manual  
GL-Class



Mercedes-Benz



1 6 4 5 8 4 7 4 8 1

Order No. 6515 4276 13 Part No. 164 584 74 81 Edition A 2008

GL-Class

GL 320 CDI

GL 450

GL 550

Our company and staff congratulate you on the purchase of your new Mercedes-Benz.

Your selection of our product is a demonstration of your trust in our company name. Furthermore, it exemplifies your desire to own an automobile that will be as easy as possible to operate and provide years of service.

Your Mercedes-Benz represents the efforts of many skilled engineers and craftsmen. To help assure your driving pleasure, and also the safety of you and your passengers, we ask you to make a small investment of time:

- Please read this manual carefully, then return it to your vehicle where it will be handy for your reference.
- Please follow the recommendations contained in this manual. They are designed to acquaint you with the operation of your Mercedes-Benz.
- Please pay attention to the warnings and cautions contained in this manual. They are designed to help improve the safety of the vehicle operator and occupants.

We extend our best wishes for many miles of safe, pleasurable driving.

Mercedes-Benz USA, LLC  
A DaimlerChrysler Company

<b>Introduction</b> .....	9
Product information .....	9
Operator's Manual .....	10
Service and warranty information ..	10
Important notice for California retail buyers and lessees of Mercedes-Benz automobiles .....	11
Maintenance .....	12
Roadside Assistance .....	12
Change of address or ownership....	13
Operating your vehicle outside the USA or Canada .....	13
Where to find it .....	15
Symbols .....	16
Operating safety .....	17
Proper use of the vehicle .....	17
Problems with your vehicle .....	18
Reporting safety defects .....	19
Reporting safety defects .....	19
Vehicle data recording .....	20
Information regarding electronic recording devices .....	20

<b>At a glance</b> .....	21
Exterior view .....	22
Cockpit .....	24
Instrument cluster .....	26
Instrument cluster .....	28
Multifunction steering wheel .....	30
Center console .....	31
Upper part (Vehicles without enhanced off-road package*) .....	31
Upper part (Vehicles with enhanced off-road package*) .....	32
Lower part .....	33
Overhead control panel .....	34
Door control panel .....	35
Storage compartments .....	36

<b>Getting started</b> .....	39
Unlocking .....	40
Unlocking with the SmartKey .....	40
Unlocking with KEYLESS-GO* .....	41
Starter switch positions .....	41
Adjusting .....	45
Seats .....	45
Steering wheel .....	48
Mirrors .....	51
Driving .....	53
Fastening the seat belts .....	53
Starting the engine .....	56
Parking brake .....	59
Driving off .....	60
Switching on headlamps .....	61
Turn signals .....	62
Windshield wipers .....	62
Rear window wiper/washer .....	64
Problems while driving .....	65
Parking and locking .....	67
Parking brake .....	67
Switching off headlamps .....	68
Turning off the engine .....	68
Releasing seat belts .....	70
Locking .....	70



<b>Safety and Security</b> .....	73	<b>Controls in detail</b> .....	111	Memory function* .....	141
Occupant safety .....	74	Locking and unlocking .....	112	Storing positions into memory .....	142
Air bags .....	76	SmartKey .....	112	Recalling positions from memory .....	142
Occupant Classification System .....	81	SmartKey with KEYLESS-GO* .....	115	Lighting .....	143
Seat belts .....	86	Checking the batteries in the		Exterior lamp switch .....	143
Active head restraint .....	90	SmartKey or SmartKey with		Combination switch .....	147
Rear head restraints .....	91	KEYLESS-GO* .....	120	Corner-illuminating	
Children in the vehicle .....	91	Loss of the SmartKey or		front fog lamps* .....	147
Blocking of rear door		SmartKey with KEYLESS-GO* .....	120	Hazard warning flasher .....	149
window operation .....	98	Opening the doors		Interior lighting .....	149
Panic alarm .....	100	from the inside .....	120	Door entry lamps .....	151
Activating .....	100	Tailgate/Power tailgate* .....	121	Cargo compartment lamp .....	151
Deactivating .....	100	Automatic central locking .....	128	Instrument cluster .....	152
Driving safety systems .....	101	Locking and unlocking		Adjusting instrument	
ABS .....	101	from the inside .....	128	cluster illumination .....	153
BAS .....	103	Seats .....	130	Resetting trip odometer .....	153
ESP® .....	103	Easy-entry/exit feature for		Tachometer .....	153
EBP .....	107	third-row seats .....	130	Outside temperature indicator .....	153
4-ETS .....	107	Front seat active head restraints .	133		
Anti-theft systems .....	109	Rear seats .....	133		
Immobilizer .....	109	Lumbar support .....	137		
Anti-theft alarm system .....	109	Multicontour seat* .....	138		
		Seat heating* .....	138		
		Seat ventilation* .....	140		

Control system .....	155	Transfer case.....	201	Air conditioning .....	224
Multifunction display.....	155	LOW RANGE mode* .....	201	Residual heat and ventilation.....	225
Multifunction steering wheel.....	156	Differential locks* .....	204	Rear climate control* .....	226
Menus .....	158	A few words about differentials		3-zone automatic climate control* .....	228
Standard display menu .....	162	and differential locks* .....	204	Deactivating the automatic	
AUDIO menu .....	164	Switching differential locks* .....	205	climate control system .....	232
NAV* menu .....	166	Good visibility .....	208	Operating the automatic	
Off-road menu.....	166	Headlamp cleaning system* .....	208	climate control system	
DISTRONIC* menu		Rear view mirrors.....	208	in automatic mode.....	233
(Canada only).....	167	Power folding exterior		Setting the temperature .....	234
Vehicle status message		rear view mirrors* .....	209	Adjusting air distribution .....	234
memory menu.....	167	Sun visors .....	210	Adjusting air volume .....	235
Settings menu.....	168	Rear panorama roof sunshade.....	212	Front defroster .....	235
Vehicle configuration .....	182	Rear window defroster.....	212	Maximum cooling MAXCOOL.....	237
Trip computer menu.....	184	Climate control.....	214	Air recirculation mode .....	237
TEL* menu .....	186	Deactivating the		Air conditioning .....	239
Automatic transmission.....	189	climate control system .....	218	Using driver-side settings	
Gear selector lever.....	189	Operating the climate control		for all temperature zones.....	240
Shifting procedure .....	192	system in automatic mode.....	218	Residual heat and ventilation.....	241
Transmission positions.....	192	Setting the temperature.....	219	Rear automatic climate control.....	241
Driving tips.....	195	Adjusting air distribution.....	219	Power windows .....	246
Gear ranges .....	197	Adjusting air volume .....	220	Door windows.....	247
Steering wheel gearshift control ..	198	Air vents in the roof liner		Hinged quarter windows* .....	248
Emergency operation		over the second-row seats* .....	220	Synchronizing the door windows ..	249
(Limp-Home Mode) .....	200	Front defroster.....	221	Summer opening feature .....	249
		Air recirculation mode .....	222	Convenience closing feature.....	250

# Contents

Power tilt/sliding sunroof* .....	251	Loading.....	295	<b>Operation</b> .....	345
Opening and closing.....	251	Carriers* .....	295	The first 1000 miles (1500 km) .....	346
Synchronizing.....	253	Loading instructions.....	301	Driving instructions .....	347
Driving systems .....	255	Cargo tie-down rings.....	302	Drive sensibly – save fuel.....	347
Cruise control.....	255	Hooks.....	304	Drinking and driving.....	347
Distronic* (Canada only) .....	260	Expanding cargo compartment ....	304	Pedals .....	347
Distance warning function* (Canada only) .....	272	Cargo compartment cover blind...	310	Power assistance .....	348
Downhill Speed Regulation (DSR).....	273	Cargo net* .....	312	Brakes.....	348
Off-road driving program (Vehicles without enhanced off-road package*).....	277	Useful features .....	315	Driving off .....	350
Air suspension program .....	278	Storage compartments .....	315	Parking.....	350
Adaptive Damping System (ADS)* .....	278	Parcel nets .....	319	Tires.....	351
Vehicle level control.....	279	Cup holders.....	320	Hydroplaning.....	352
Parktronic system* .....	288	Ashtrays.....	321	Tire traction .....	352
Rear view camera* .....	293	Cigarette lighter .....	323	Tire speed rating.....	353
		Power outlets.....	324	Winter driving instructions.....	353
		Floor mats.....	325	Standing water.....	355
		Seat cover under third-row seats ..	326	Off-road driving .....	355
		Heated steering wheel* .....	327	Trailer towing.....	364
		Telephone* .....	328	Passenger compartment.....	370
		Tele Aid .....	331	Driving abroad .....	370
		Garage door opener .....	338	Control and operation of radio transmitters .....	370
		Compass.....	344	Catalytic converter (gasoline engine).....	371
		Infrared reflecting windshield* .....	344		

Oxidation catalyst (diesel engine).....	371	DOT, Tire Identification Number (TIN) .....	410	<b>Practical hints</b> .....	435
Emission control .....	372	Maximum tire load .....	412	What to do if .....	436
Coolant temperature .....	372	Maximum tire inflation pressure ...	412	Lamps in instrument cluster .....	436
At the gas station .....	374	Uniform Tire Quality Grading		Lamp in center console .....	447
Refueling .....	374	Standards (U.S. vehicles).....	413	Vehicle status messages in the multifunction display .....	449
Check regularly and before a long trip.....	376	Tire ply material .....	415	Where will I find ...? .....	490
Engine compartment .....	378	Tire and loading terminology.....	415	First aid kit.....	490
Hood .....	378	Rotating tires .....	418	Vehicle tool kit.....	490
Engine oil .....	380	Winter driving .....	420	Spare wheel.....	494
Transmission fluid level.....	381	Winter tires .....	420	Unlocking/locking in an emergency ..	496
Coolant level .....	381	Snow chains.....	421	Unlocking the vehicle .....	496
Windshield/rear window washer system and headlamp cleaning system* .....	383	Maintenance.....	422	Locking the vehicle .....	497
Tires and wheels.....	384	Maintenance service indicator message .....	422	Fuel filler flap .....	497
Important guidelines .....	384	Calling up the maintenance service indicator display .....	424	Resetting activated head restraints....	499
Tire care and maintenance.....	385	Resetting the maintenance service indicator .....	424	Vehicles without Rear seat entertainment system* .....	499
Direction of rotation .....	387	Vehicle care.....	425	Vehicles with Rear seat entertainment system* .....	500
Loading the vehicle .....	387	Cleaning and care of the vehicle ...	425	Replacing SmartKey batteries .....	502
Recommended tire inflation pressure .....	393			Replacing bulbs.....	504
Checking tire inflation pressure ...	395			Bulbs.....	504
Tire labeling.....	406			Replacing bulbs for front lamps ....	507
Load identification .....	410			Replacing bulbs for rear lamps .....	511
				Adjusting headlamp aim .....	514

Replacing wiper blades .....	516
Front wiper blades .....	516
Rear wiper blade .....	517
Flat tire .....	519
Preparing the vehicle.....	519
Mounting the spare wheel.....	520
Bleeding the fuel system (diesel engine only).....	527
Battery.....	528
Disconnecting, removing, reinstalling and reconnecting the battery.....	530
Charging the battery .....	535
Jump starting .....	536
Towing the vehicle .....	538
Installing towing eye bolt.....	540
Stranded vehicle .....	542
Fuses .....	543
Fuse box in engine compartment .	544
Fuse box in cargo compartment...	544
Fuse box in passenger compartment .....	545
Emergency engine shut-down .....	545

<b>Technical data</b> .....	547
Parts service .....	548
Warranty coverage.....	549
Loss of Service and Warranty Information Booklet .....	549
Identification labels .....	550
Layout of poly-V-belt drive.....	552
GL 320 CDI .....	552
GL 450, GL 550.....	552
Engine.....	553
Rims and tires.....	555
Same size tires.....	556
Minispare wheel.....	558
Electrical system .....	559
Main Dimensions .....	560
Weights.....	561

Fuels, coolants, lubricants.....	562
Capacities .....	562
Engine oils .....	564
Engine oil additives .....	564
Air conditioning refrigerant .....	564
Brake fluid.....	564
Premium unleaded gasoline (gasoline engine).....	565
Fuel requirements.....	565
Gasoline additives (gasoline engine).....	566
Coolants .....	567
Windshield washer system and headlamp cleaning system* .....	569

<b>Index</b> .....	571
--------------------	-----

## ▼ Product information

Please observe the following in your own best interest:

We recommend using Genuine Mercedes-Benz Parts as well as conversion parts and accessories explicitly approved by us for your vehicle model.

We have tested these parts to determine their reliability, safety and special suitability for Mercedes-Benz vehicles.

We are unable to make an assessment for other products and therefore cannot be held responsible for them, even if in individual cases an official approval or authorization by governmental or other agencies should exist. Use of such parts and accessories could adversely affect the safety, performance or reliability of your vehicle. Please do not use them.

Genuine Mercedes-Benz Parts as well as conversion parts and accessories approved by us are available at any authorized Mercedes-Benz Light Truck Center where you will receive comprehensive information, also on permissible technical modifications, and where proper installation will be performed.

This Operator's Manual contains a great deal of useful information. We urge you to read it carefully and familiarize yourself with the vehicle before driving.

For your own safety and longer service life of the vehicle, we urge you to follow the instructions and warnings contained in this manual. Ignoring them could result in damage to the vehicle or personal injury to you or others. Vehicle damage caused by failure to follow instructions is not covered by the Mercedes-Benz Limited Warranty.

Your vehicle may have some or all of the equipment described in this manual. Therefore, you may find explanations for optional equipment not installed in your vehicle. If you have any questions about the operation of any equipment, any authorized Mercedes-Benz Light Truck Center will be glad to demonstrate the proper procedures.

We continuously strive to improve our product, and ask for your understanding that we reserve the right to make changes in design and equipment. Therefore, information, illustrations and descriptions in this Operator's Manual might differ from your vehicle.

Optional equipment is also described in this manual, including operating instructions wherever necessary. Since they are special-order items, the descriptions and illustrations herein may vary slightly from the actual equipment of your vehicle.

If there are any equipment details that are not shown or described in this Operator's Manual, any authorized Mercedes-Benz Light Truck Center will be glad to inform you of correct care and operating procedures.

The Operator's Manual and Maintenance Booklet are important documents and should be kept with the vehicle.

### Service and warranty information

The Service and Warranty Information Booklet contains detailed information about the warranties covering your Mercedes-Benz, including:

- New Light Truck Limited Warranty
- Emission System Warranty
- Emission Performance Warranty
- California, Maine, Massachusetts, and Vermont Emission Control System Warranty (California, Maine, Massachusetts, and Vermont only)
- State Warranty Enforcement Laws (Lemon Laws)

### **Important notice for California retail buyers and lessees of Mercedes-Benz automobiles**

Under California law you may be entitled to a replacement of your vehicle or a refund of the purchase price or lease price, if Mercedes-Benz USA, LLC and/or its authorized repair or service facilities fail to fix one or more substantial defects or malfunctions in the vehicle that are covered by its express warranty after a reasonable number of repair attempts. During the period of 18 months from original delivery of the vehicle or the accumulation of 18 000 miles (approximately 29 000 km) on the odometer of the vehicle, whichever occurs first, a reasonable number of repair attempts is presumed for a retail buyer or lessee if one or more of the following occurs:

- (1) the same substantial defect or malfunction results in a condition that is likely to cause death or serious bodily injury if the vehicle is driven, that defect or malfunction has been subject to repair two or more times, and you have directly notified Mercedes-Benz USA, LLC in writing of the need for its repair,
- (2) the same substantial defect or malfunction of a less serious nature than category (1) has been subject to repair four or more times and you have directly notified us in writing of the need for its repair, or
- (3) the vehicle is out of service by reason of repair of the same or different substantial defects or malfunctions for a cumulative total of more than 30 calendar days.

Written notification should not be sent to a dealer, it should be addressed to Mercedes-Benz USA, LLC Customer Assistance Center One Mercedes Drive Montvale, NJ 07645-0350



#### Maintenance

---

The Maintenance Booklet describes all the necessary maintenance work which should be performed at regular intervals.

Always have the Maintenance Booklet with you when you take the vehicle to an authorized Mercedes-Benz Light Truck Center for service. The service advisor will record each service in the booklet for you.

#### Roadside Assistance

---

The Mercedes-Benz Roadside Assistance Program provides factory-trained technical help in the event of a breakdown. Calls to the toll-free Roadside Assistance number

**1-800-FOR-MERCEdes (in the USA)**

**1-800-387-0100 (in Canada)**

will be answered by Mercedes-Benz Customer Assistance Representatives 24 hours a day, 365 days a year.

Roadside Assistance will be provided in accordance with standard program guidelines which include providing service to the vehicle up to a reasonable distance from a paved roadway. We will make every effort to assist in a breakdown situation, however, the accessibility of your vehicle will be determined by our authorized Mercedes-Benz Light Truck Center technician or the tow service provider on a case-by-case basis and may be a factor in our ability to respond.

Additional charges may be applicable for a breakdown location determined not to be a reasonably accessible roadside location as determined by our authorized technician and tow service provider.

For additional information refer to the Mercedes-Benz Roadside Assistance Program brochure in your vehicle literature portfolio.

### Change of address or ownership

---

If you change your address, be sure to send in the “Change of Address Notice” found in the Service and Warranty Information Booklet, or simply call the Mercedes-Benz Customer Assistance Center (in the USA) at 1-800-FOR-MERCEdes, or Customer Service (in Canada) at 1-800-387-0100. It is in your own interest that we can contact you should the need arise.

If you sell your Mercedes, please leave all literature with the vehicle to make it available to the next operator.

If you bought this vehicle used, be sure to send in the “Notice of Purchase of Used Truck” found in the Service and Warranty Information Booklet, or call the Mercedes-Benz Customer Assistance Center (in the USA) at 1-800-FOR-MERCEdes, or Customer Service (in Canada) at 1-800-387-0100.

### Operating your vehicle outside the USA or Canada

---

If you plan to operate your vehicle in foreign countries, please be aware that:

- service facilities or replacement parts may not be readily available,
- unleaded gasoline for vehicles with catalytic converters may not be available; the use of leaded fuels will damage the catalyts,
- gasoline may have a considerably lower octane rating, and improper fuel can cause engine damage.

#### Warning!



This Sport Utility Vehicle is designed for both on-road and off-road use. It can go places and perform tasks for which conventional 2-wheel drive passenger cars are not intended. This vehicle will handle and maneuver differently from conventional passenger cars in driving conditions which may occur on streets, highways and off-road use.

This vehicle has a higher ground clearance and a higher center of gravity than many passenger cars. As with other vehicles of this type, if you make sharp turns at excessive speeds or abrupt maneuvers, the vehicle may roll over or may go out of control and crash. Utility vehicles have a significantly higher rollover rate than other types of vehicles. Failure to operate this vehicle safely may result in an accident, rollover of the vehicle, and severe or fatal injury.

Before you start to drive this vehicle, read the Operator's Manual. Take time to become familiar with the driving characteristics of this vehicle. Be sure you are familiar with all vehicle controls. Learn how your vehicle handles on different road surfaces. Do not attempt sharp turns at excessive speeds or abrupt maneuvers or other unsafe driving actions that can cause loss of vehicle control. When driving off-road or working the vehicle hard, do not overload it. And, always wear your seat belts at all times. In a rollover crash, an unbelted person is significantly more likely to die than a person wearing a seat belt.

## ▼ Where to find it

This Operator's Manual is designed to provide comprehensive support information for you, the vehicle operator. Each section has its own reference color.

### At a glance

Here you will find an overview of all the controls that can be operated from the driver's seat.

### Getting started

Here you will find all the information you need for your first drive. You should read this section first if this is your first Mercedes-Benz vehicle or if you are renting or borrowing this vehicle.

### Safety and Security

Here you will find descriptions of the safety and security features of your vehicle.

### Controls in detail

Here you will find detailed information about the equipment installed on your vehicle. This section expands on the "Getting started" section and also describes technical innovations. If you are already familiar with the basic functions of your vehicle, this section will be of particular interest to you.

### Operation

Here you will find all the information you need for the proper operation of your vehicle.

### Practical hints

This section provides fast assistance for dealing with problems you may encounter.

### Technical data

All important technical data for your vehicle can be found in this section.

### Indexes

The table of contents and the index are designed to help you find information quickly and easily.

The following publications are part of your vehicle documentation:

- this Operator's Manual
- the Maintenance Booklet

Separate operating instructions will be provided as required depending on the equipment options installed in your vehicle.

## Symbols

Trademarks:

- ESP® is a registered trademark of DaimlerChrysler.
- HomeLink® is a registered trademark of Prince, a Johnson Controls Company.

The following symbols are found in this Operator's Manual:

- \* Optional equipment is identified with an asterisk. Since standard equipment varies between models, the descriptions and illustrations in this manual may differ slightly from the actual equipment of your vehicle.

### Warning!



Warning notices draw your attention to hazards that may endanger your health or life, or the health or life of others.

 *Highlights hazards that may result in damage to your vehicle.*

 *Helpful hints or further information you may find useful.*

- ▶ This symbol points to instructions for you to follow.
- ▶ A number of these symbols appearing in succession indicates a multiple-step procedure.

▷ page This symbol tells you where to look for further information on a topic.

▷▷ This continuation symbol marks a warning which is continued on the next page.

▷▷ This continuation symbol marks a procedure which is continued on the next page.

-> This symbol is used to indicate cross-references to term definitions.

Display Words appearing in the multi-function display are printed in the type shown here.

## ▼ Operating safety

### Warning!



Work improperly carried out on electronic components and associated software could cause them to cease functioning. Because the vehicle's electronic components are interconnected, any modifications made may produce an undesired effect on other systems. Electronic malfunctions could seriously impair the operating safety of your vehicle.

See an authorized Mercedes-Benz Light Truck Center for repairs or modifications to electronic components.

Other improper work or modifications on the vehicle could also have a negative impact on the operating safety of the vehicle.

Some safety systems only function while the engine is running. You should therefore never turn off the engine while driving.

### Warning!



Heavy blows against the vehicle underbody or tires/wheels, for example when running over an obstacle, road debris or a pothole, may cause serious damage and impair the operating safety of your vehicle. If you feel a sudden significant vibration or ride disturbance, or you suspect that damage to your vehicle has occurred, you should turn on your hazard warning flashers, carefully slow down, and drive with caution to an area which is a safe distance from the road.

Inspect the vehicle underbody and tires/wheels for possible damage. If the vehicle appears unsafe, have it towed to the nearest authorized Mercedes-Benz Light Truck Center or other qualified maintenance or repair facility for further inspection or repairs.

## Proper use of the vehicle

Proper use of the vehicle requires that you are familiar with the following information and rules:

- the safety precautions in this manual
- the “Technical data” section in this manual
- traffic rules and regulations
- motor vehicle laws and safety standards

### Warning!



Various warning labels are attached to your vehicle. These warning labels are intended to make you and others aware of various risks. You should not remove any of these warning labels unless explicitly instructed to do so by information on the label itself. Removal of any of these labels may cause you and others to be unaware of certain risks which may result in an accident and/or personal injury.

### Problems with your vehicle

If you should experience a problem with your vehicle, particularly one that you believe may affect its safe operation, we urge you to immediately contact an authorized Mercedes-Benz Light Truck Center to have the problem diagnosed and corrected if required. If the matter is not handled to your satisfaction, please discuss the problem with the Mercedes-Benz Light Truck Center management, or if necessary contact us at one of the following addresses:

In the USA:

Customer Assistance Center  
Mercedes-Benz USA, LLC  
One Mercedes Drive  
Montvale, NJ 07645-0350

In Canada:

Customer Relations Department  
Mercedes-Benz Canada, Inc.  
98 Vanderhoof Avenue  
Toronto, Ontario, M4G 4C9

## ▼ Reporting safety defects

For the USA only:

The following text is published as required of manufacturers under Title 49, Code of U.S. Federal Regulations, Part 575 pursuant to the “National Traffic and Motor Vehicle Safety Act of 1966”.

### **Reporting safety defects**

---

If you believe that your vehicle has a defect which could cause a crash or could cause injury or death, you should immediately inform the National Highway Traffic Safety Administration (NHTSA) in addition to notifying Mercedes-Benz USA, LLC.

If NHTSA receives similar complaints, it may open an investigation, and if it finds that a safety defect exists in a group of vehicles, it may order a recall and remedy campaign. However, NHTSA cannot become involved in individual problems between you, your dealer, or Mercedes-Benz USA, LLC.

To contact NHTSA, you may call the Vehicle Safety Hotline toll-free at 1-888-327-4236 (TTY: 1-800-424-9153); go to <http://www.safercar.gov>; or write to: Administrator, NHTSA, 400 Seventh Street, SW., Washington, D.C. 20590. You can also obtain other information about motor vehicle safety from <http://www.safercar.gov>.



### Vehicle data recording

#### Information regarding electronic recording devices

---

(Including notice pursuant to California Code § 9951)

Please note that your vehicle is equipped with devices that can record vehicle systems data and, if equipped with the Tele Aid system, may transmit some data in certain accidents.

This information helps, for example, to diagnose vehicle systems after a collision and to continuously improve vehicle safety. DaimlerChrysler may access the information and share it with others

- for safety research or vehicle diagnosis purposes
- with the consent of the vehicle owner or lessee
- in response to an official request by law enforcement or other government agency
- for use in dispute resolution involving DaimlerChrysler, its affiliates or sales/service organization and/or
- as otherwise required or permitted by law.

Please check the Tele Aid subscription service agreement for details regarding the information that may be recorded or transmitted via that system.



**Exterior view**

**Cockpit**

**Instrument cluster**

**Multifunction steering wheel**

**Center console**

**Overhead control panel**

**Door control panel**

**Storage compartments**



P00.00-4066-31

Item	Page
① Tailgate	122
Power tailgate*	123
Cargo compartment	
• Loading instructions	301
• Cargo tie-down rings	302
• Hooks	304
• Expanding	304
• Cover blind	310
• Cargo net*	312
Vehicle tool kit	490
Spare wheel	494
② Rear window defroster	212
③ Rear lamps	505
④ Fuel filler flap	374
Refueling	374
Fuel	375, 565

Item	Page
⑤ Exterior rear view mirrors	
Adjusting	51
Auto-dimming rear view mirrors*	208
Power folding*	209
⑥ Towing eye bolt	
Installing towing eye bolt	540
⑦ Tires and wheels	384, 555
Checking tire inflation pressure	395
General information	384
Flat tire	519
Spare wheel	494
⑧ Hood	378
Opening	378
Engine oil	380
Coolant	381

Item	Page
⑨ Windshield wipers	62
Wiper blades, replacing	516
Wiper blades, cleaning	431
⑩ Windshield	
Cleaning with wiper fluid	64
Cleaning	431
⑪ Roof rails	295
Carriers*	296
⑫ Power tilt/sliding sunroof*	251
⑬ Doors	
Locking and unlocking	112
Opening	120
Unlocking/locking in an emergency	496
⑭ Front lamps	505
⑮ Headlamp cleaning system*	208

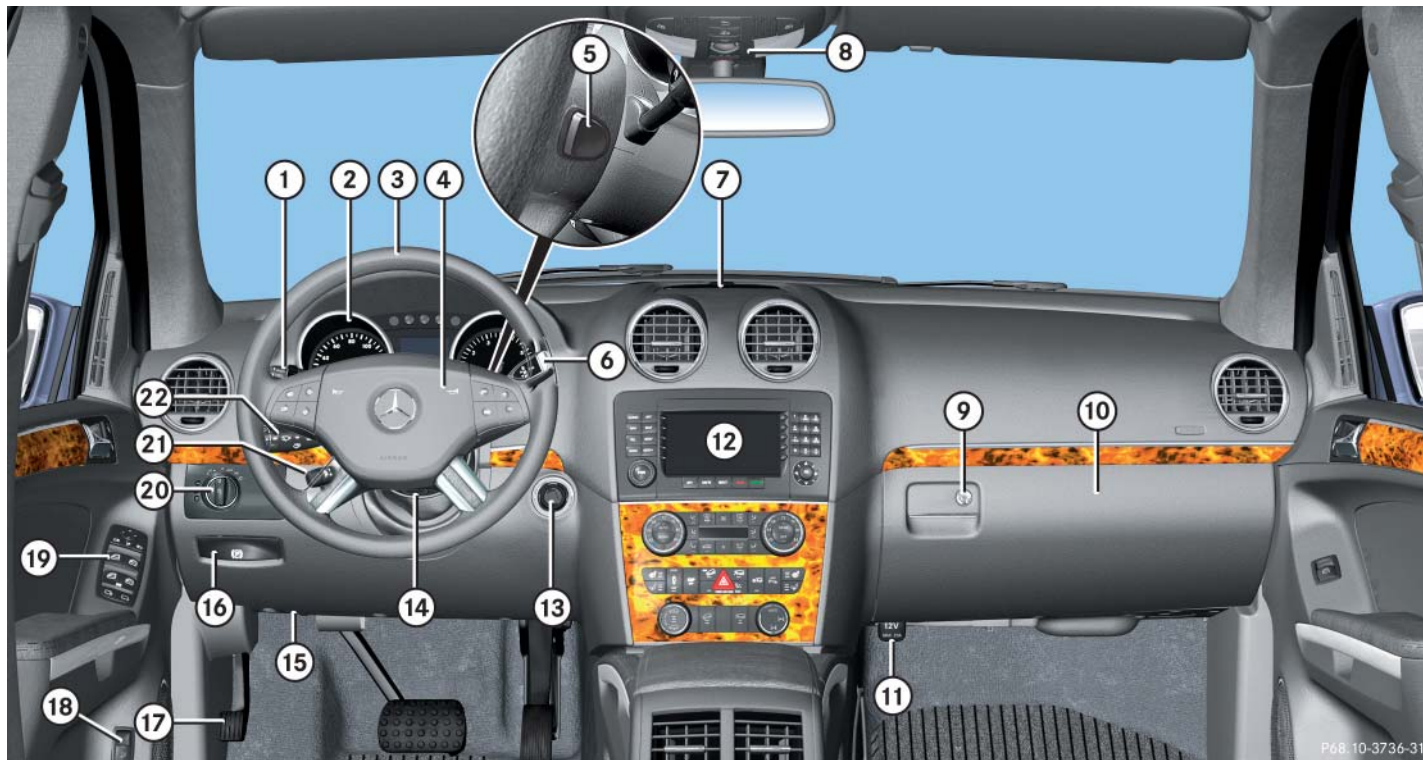

Item	Page
① Cruise control lever	256
② Instrument cluster	26
③ Multifunction steering wheel	30
④ Horn	
⑤ Steering wheel gearshift buttons	198
⑥ Gear selector lever for automatic transmission	56
⑦ Front Parktronic* warning indicators	290
⑧ Overhead control panel	34
⑨ Glove box release	315
Glove box lock	316



Item	Page
⑩ Glove box	315
CD changer	315
AUX-socket	315
⑪ Power outlet	324
⑫ Center console	31
⑬ Starter switch	42
⑭ Steering wheel adjustment, manual	49
⑮ Hood lock release	378
⑯ Parking brake release	59
⑰ Parking brake pedal	67
⑱ Power tailgate switch*	124

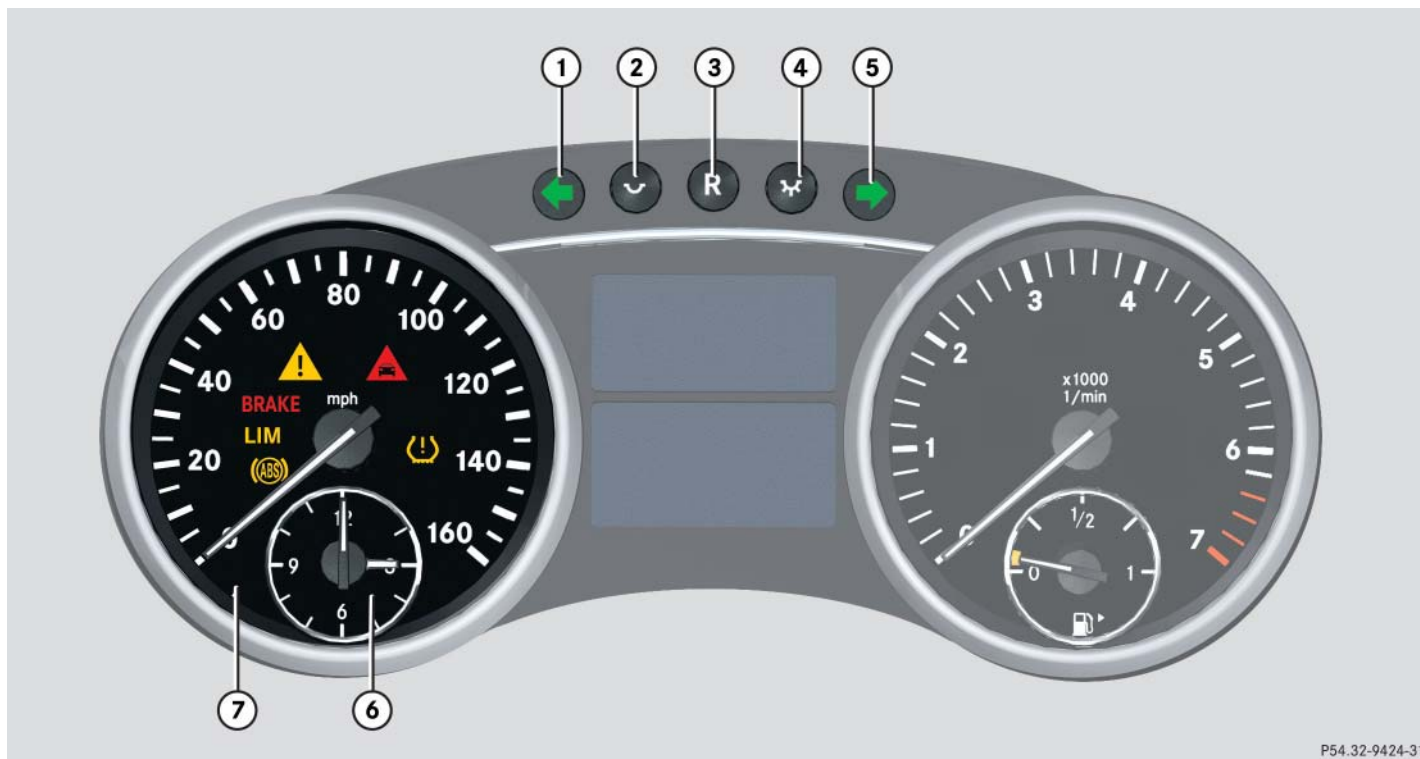

Item	Page
⑲ Door control panel	35
⑳ Exterior lamp switch	61
	143
㉑ Steering wheel adjustment, electrical*	50
Heated steering wheel*	327
㉒ Combination switch	147
• High beam	61
• Turn signals	62
• Windshield wipers	62
• Rear window wiper	64

Instrument cluster







P54.32-9424-31

Item	Page
①  Left turn signal indicator lamp	
② To dim instrument cluster illumination	153
③ <b>Reset button for:</b>	
• Resetting trip odometer	153
• Resetting all settings	169
④ To brighten instrument cluster illumination	153
⑤  Right turn signal indicator lamp	
⑥ <b>Clock</b>	174

Item	Page
⑦ <b>Speedometer with:</b>	
 Antilock Brake System (ABS) indicator lamp	436
 Variable speed limiter indicator lamp <sup>1</sup>	
 Distance warning lamp <sup>2</sup>	263, 440

<sup>1</sup> Lamp without function. It illuminates when the ignition is on. It should go out when the engine is running.





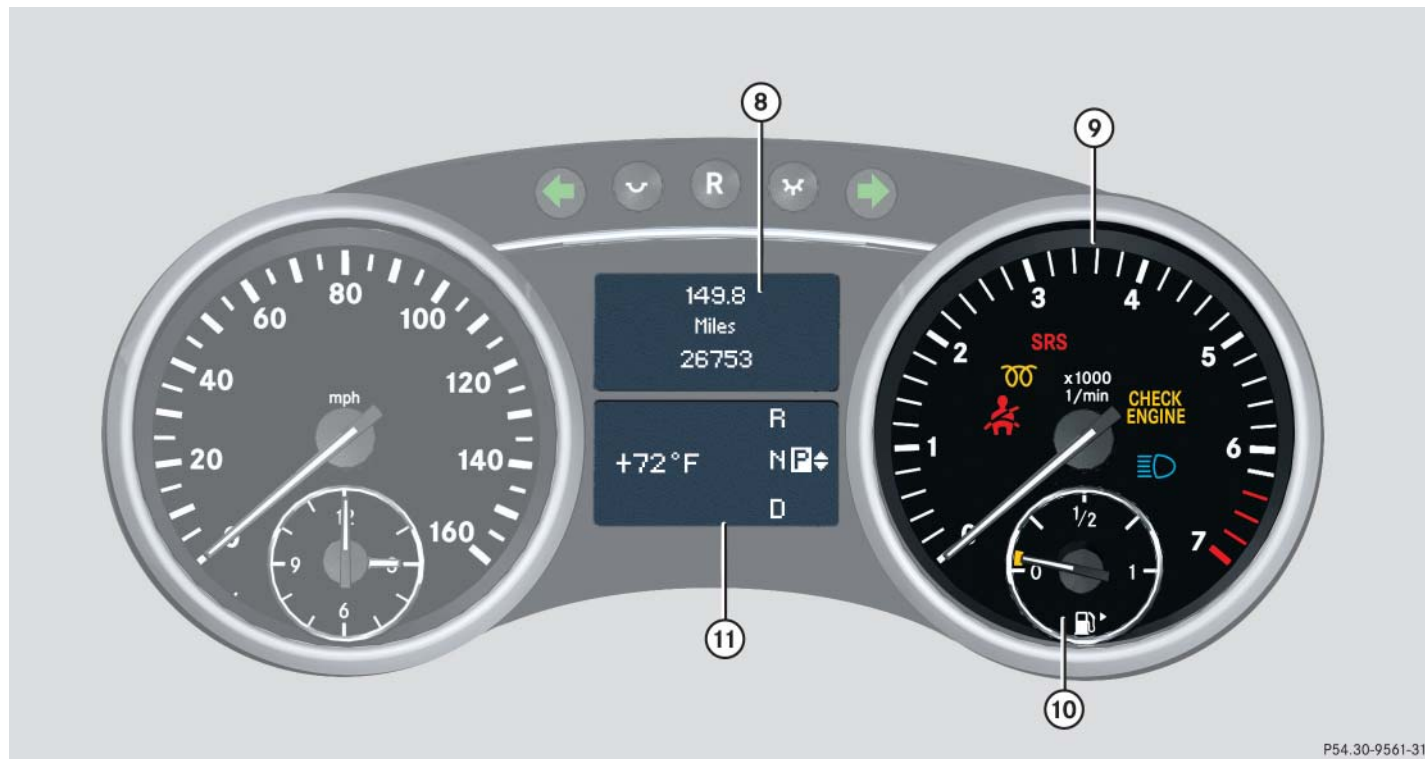

<sup>2</sup> Vehicles without Distronic\*: Warning lamp without function. It illuminates when the ignition is on. It should go out when the engine is running.

Item	Page
 Brake warning lamp, USA only	437
 Brake warning lamp, Canada only	437
 Electronic Stability Program (ESP®) warning lamp	441
 Combination low tire pressure/TPMS malfunction telltale, USA only	444
Low tire pressure telltale*, Canada only	444





P54.30-9561-31

Item	Page
⑧ <b>Multifunction display with:</b>	
• Trip odometer	153
• Main odometer	155
⑨ <b>Tachometer with:</b>	
 Seat belt telltale	89, 442
 Preglow indicator lamp <sup>1</sup>	57
 Supplemental Restraint System (SRS) indicator lamp	74, 446
 Engine malfunction indicator lamp, USA only	439
 Engine malfunction indicator lamp, Canada only	439
 High beam headlamp indicator	61, 147





Item	Page
⑩ <b>Fuel gauge with:</b>	
Fuel tank reserve warning lamp	446
 Fuel filler flap indicator: The fuel filler flap is located on the rear right-hand side.	374
⑪ <b>Multifunction display with:</b>	
• Outside temperature indicator or digital speedometer (depending on selected setting in the control system)	155, 173
• Transmission position indicator	192
• Gear range indicator	197







Item	Page
• Distance warning function* indicator (Canada only)	183
• LOW RANGE mode* indicator	202
• Downhill Speed Regulation (DSR) indicator	275
• Off-road driving program indicator	278
• Rear window wiper indicator	64
• Set speed for	
• Cruise control	257
• Distronic* (Canada only)	266

<sup>1</sup> Vehicles with Diesel engine only.

## Multifunction steering wheel



	Item	Page
①	Multifunction display	155
	<b>Operating the control system</b>	156
②	Telephone*: Press button	
	 to take a call to dial to redial	
	 to end a call to reject an incoming call	
③	Selecting the submenu or setting the volume: Press button	
	 up/to increase	
	 down/to decrease	

	Item	Page
④	 Voice Control System* on <sup>1</sup> , see separate operating instructions	
⑤	Moving within a menu: Press button	
	 for next display	
	 for previous display	
⑥	 Voice Control System* off <sup>1</sup> , see separate operating instructions	
⑦	Menu systems: Press button	
	 for next menu	
	 for previous menu	

<sup>1</sup> Vehicles without Voice Control System\*: Button without function.

## ▼ Center console

Upper part (Vehicles without enhanced off-road package\*)



Item	Page	Item	Page
① COMAND system, see separate operating instructions		⑧ Storage compartment	317
② Climate control	214	⑨ Alarm system indicator lamp	110
3-zone automatic climate control*	228	⑩ Electronic Stability Program (ESP®) switch	105
Rear window defroster	212	⑪ Adaptive damping system (ADS)* switch (USA only)	278
③ Seat heating*, front passenger side	138	⑫ Seat ventilation*, driver's side	140
④ Seat ventilation*, front passenger side	140	⑬ Seat heating*, driver's side	138
⑤ Parktronic system* deactivation switch	291	⑭ Switch for Downhill Speed Regulation (DSR)	274
⑥ Vehicle level control switch	281	⑮ Hazard warning flasher	149
⑦ Front passenger front air bag off indicator lamp	85, 447, 448	⑯ Switch for Off-road driving program	278

## Center console

### Upper part (Vehicles with enhanced off-road package\*)



Item	Page	Item	Page
① COMAND system, see separate operating instructions		⑨ Alarm system indicator lamp	110
② Climate control	214	⑩ Seat ventilation*, driver's side	140
3-zone automatic climate control*	228	⑪ Seat heating*, driver's side	138
Rear window defroster	212	⑫ Adaptive damping system (ADS)* switch	278
③ Seat heating*, front passenger side	138	⑬ Electronic Stability Program (ESP®) switch	105
④ Seat ventilation*, front passenger side	140	⑭ Parktronic system* deactivation switch	291
⑤ Rotary switch for differential locks*	205	⑮ Hazard warning flasher	149
⑥ Switch for LOW RANGE mode*	202	⑯ Front passenger front air bag off indicator lamp	85, 447, 448
⑦ Switch for Downhill Speed Regulation (DSR)	274		
⑧ Rotary switch for vehicle level control	283		

## Lower part



P68\_20-3709-31

	Item	Page
①	Storage compartment with <ul style="list-style-type: none"> <li>• Power outlet<sup>1</sup></li> </ul> or <ul style="list-style-type: none"> <li>• Ashtray with cigarette lighter<sup>1</sup></li> </ul>	317 324 321
②	Cup holder	320
③	Armrest storage/telephone* compartment release	317
④	Card, ticket holder (removable)	320

<sup>1</sup> Depending on vehicle configuration.

## Overhead control panel

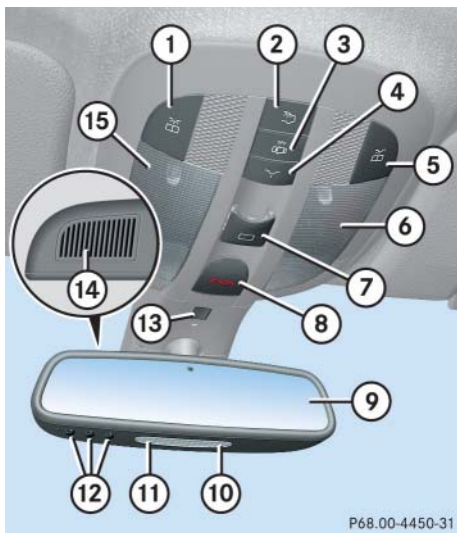

	Item	Page
①	Left reading lamp switch	149
②	Rear interior lighting switch	149
③	Automatic interior lighting switch	149
④	Front interior lighting switch	149
⑤	Right reading lamp switch	149
⑥	Front right interior lamp	149
⑦	Power tilt/sliding sunroof* switch	251
⑧	Tele Aid (emergency call system) button	334
⑨	Interior rear view mirror	208
⑩	Front right reading lamp	149

	Item	Page
⑪	Front left reading lamp	149
⑫	Garage door opener	339
⑬	Vehicles without telephone* installed: Hands-free microphone for Tele Aid (emergency call system)	331
⑭	Vehicles with telephone* installed: Hands-free microphone for Tele Aid (emergency call system) and telephone*	331
⑮	Front left interior lamp	149

## ▼ Door control panel



Item	Page
① Inside door handle	120
② Central unlocking switch	129
Central locking switch	129
③ Exterior rear view mirror adjustment	51
④ Selection buttons for exterior rear view mirror adjustment	51
Power-folding exterior rear view mirrors*	209
⑤ Switches for opening/closing front and rear door windows	246
⑥ Rear door window override switch	98
⑦ Hinged quarter window switch*	248
⑧ Remote tailgate release switch, power tailgate*	124
	123



Storage compartments

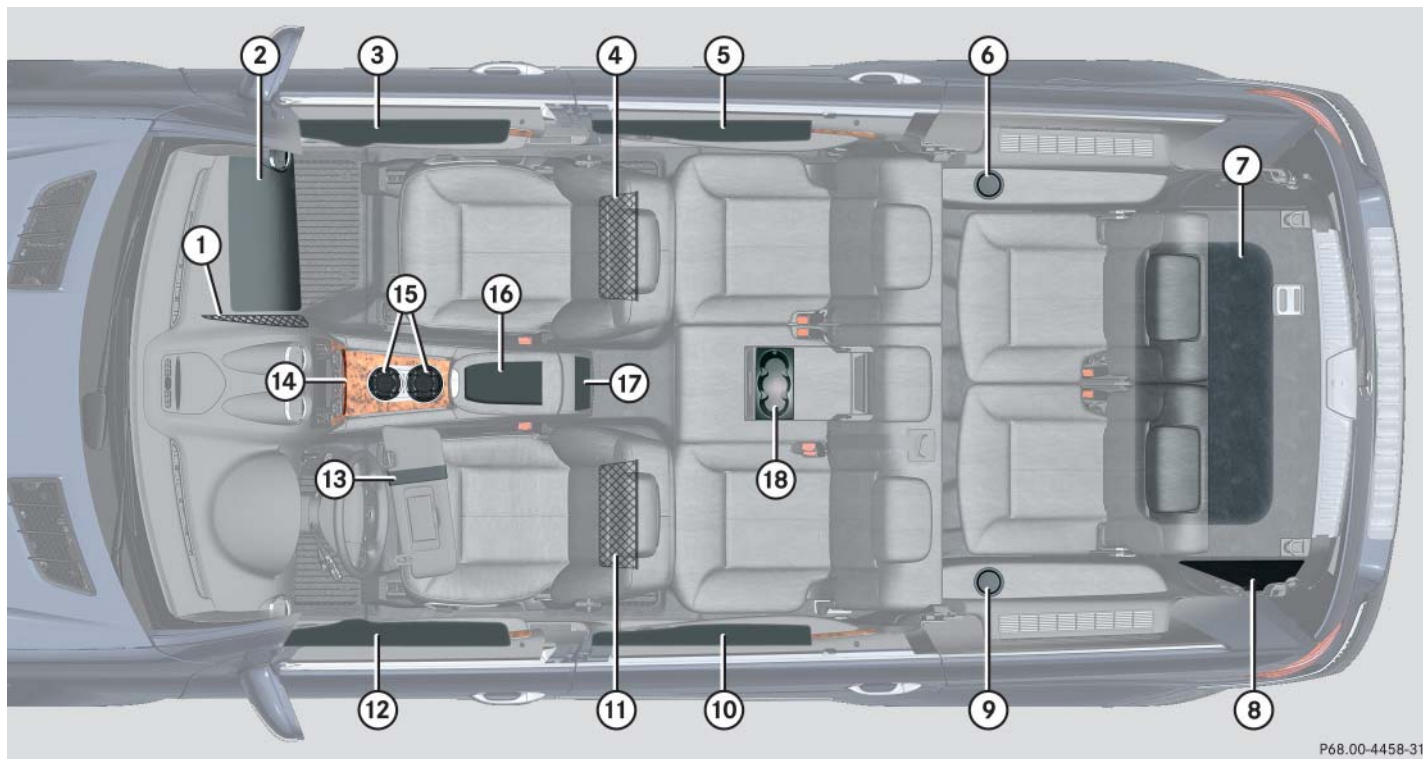

Item	Page
① Parcel net in front passenger footwell	319
② Glove box/CD changer	315
③ Door pocket	
④ Parcel net on front passenger seat backrest	319
⑤ Door pocket	
⑥ Cup holder	321
⑦ Vehicle tool kit, spare wheel	490
⑧ First aid kit	490
⑨ Cup holder	321
⑩ Door pocket	
⑪ Parcel net on driver's seat backrest	319

Item	Page
⑫ Door pocket	
⑬ Holder for gas cards	211
⑭ Depending on vehicle configuration:	
Storage compartment	317
Ashtray	321
⑮ Cup holders	320
⑯ Storage/telephone* compartment with coin holder	317
⑰ Rear storage compartment	318
⑱ Cup holder in rear armrest	320



Unlocking

Adjusting

Driving

Parking and locking



### Unlocking





The “Getting started” section provides an overview of the vehicle’s most basic functions. First-time Mercedes-Benz owners should pay special attention to the information given here.

If you are already familiar with the basic functions described here, the “Controls in detail” section will provide you with further information. The corresponding page references are located at the end of each segment.

#### Unlocking with the SmartKey



#### SmartKey

- ①  Lock button
- ②  Unlock button\* for tailgate
- ③  Unlock button
- ④  Panic button (▷ page 100)

#### Warning!



When leaving the vehicle, always remove the SmartKey from the starter switch, take it with you, and lock the vehicle. Do not leave children unattended in the vehicle, or with access to an unlocked vehicle. A child’s unsupervised access to a vehicle could result in an accident and/or serious personal injury.

- ▶ Press unlock button  on the SmartKey.

All turn signal lamps flash once. The vehicle unlocks. The locking knobs in the doors move up. The anti-theft alarm system is disarmed. The locator lighting comes on if the feature is enabled in the control system (▷ page 176).

- ▶ Enter the vehicle and insert the SmartKey in the starter switch.

For more information, see “Locking and unlocking” (▷ page 112).

## Unlocking with KEYLESS-GO\*

With the KEYLESS-GO function, you can lock or unlock the vehicle without using the remote control buttons on the SmartKey and start the engine without inserting the SmartKey into the starter switch.

 *To unlock the vehicle, the SmartKey with KEYLESS-GO must be outside the vehicle, no further than approximately 3 feet (1 meter) away from the respective door.*

### Warning!



When leaving the vehicle, always take the SmartKey with KEYLESS-GO\* with you, and lock the vehicle. Do not leave children unattended in the vehicle, or with access to an unlocked vehicle. A child's unsupervised access to a vehicle could result in an accident and/or serious personal injury.

- ▶ Grasp an outside door handle.

All turn signal lamps flash once. The vehicle unlocks. The locking knobs in the doors move up. The anti-theft alarm system is disarmed. The locator lighting comes on if the feature is enabled in the control system (▷ page 176).

-  *If the vehicle has been parked for more than 72 hours, you must pull an outside door handle in order to activate the KEYLESS-GO function.*

- ▶ Enter the vehicle.

For more information, see “SmartKey with KEYLESS-GO\*” (▷ page 115).

## Starter switch positions

### Warning!



When leaving the vehicle, always remove the SmartKey or SmartKey with KEYLESS-GO\* from the starter switch, take it with you and lock the vehicle. Do not leave children unattended in the vehicle, or with access to an unlocked vehicle. A child's unsupervised access to a vehicle could result in an accident and/or serious personal injury.

## Unlocking

### SmartKey



### Starter switch

- 0 For removing SmartKey
- 1 Power supply for some electrical consumers, such as seat adjustment
- 2 Ignition (power supply for all electrical consumers) and driving position

All lamps (except high beam headlamp indicator lamp and turn signal indicator lamps unless activated) in the instrument cluster come on. If a lamp in the instrument cluster fails to come on when the ignition is switched on, have it checked and replaced if necessary. If a lamp in the instrument cluster re-

mains on after starting the engine or comes on while driving, refer to “Lamps in instrument cluster” (▷ page 436).

### 3 Starting position

**i** When you switch on the ignition, the indicator and warning lamps (except high beam headlamp indicator lamp and turn signal indicator lamps unless activated) in the instrument cluster come on. The indicator and warning lamps (except high beam headlamp indicator lamp and turn signal indicator lamps if activated) will go out when the engine is running. This indicates that the respective systems are operational.

**i** If the SmartKey does not belong to the vehicle, the SmartKey can be turned in the starter switch. However, the ignition does not switch on and the engine does not start.

**i** When the SmartKey is removed from the starter switch and the automatic transmission is in a position other than **P**, the automatic transmission automatically shifts to **P**.

**!** If the SmartKey cannot be turned in the starter switch, the battery may not be sufficiently charged.

- Check the battery and charge it if necessary (▷ page 528).
- Get a jump start (▷ page 536).

To prevent accelerated battery discharge or a completely discharged battery, always remove the SmartKey from the starter switch when the engine is not in operation.

### SmartKey with KEYLESS-GO\*

Vehicles equipped with the KEYLESS-GO feature are supplied with a SmartKey with integrated KEYLESS-GO function and a removable KEYLESS-GO start/stop button.

With the KEYLESS-GO start/stop button inserted and the SmartKey with KEYLESS-GO present in the vehicle, pressing the KEYLESS-GO start/stop button

- without the brake pedal depressed corresponds to the various starter switch positions (▷ page 44)
- with the brake pedal firmly depressed will start the engine (▷ page 56)

If you wish or should there be a need to insert the SmartKey with KEYLESS-GO in the starter switch, the KEYLESS-GO start/stop button can be easily removed by pulling it out of the starter switch.

**i** The KEYLESS-GO start/stop button does not need to be removed from the starter switch when you leave the vehicle. However, always take the SmartKey with KEYLESS-GO with you when you leave the vehicle. As long as the SmartKey with KEYLESS-GO is in the vehicle, the vehicle's electrical systems can be switched on or the engine can be started using the KEYLESS-GO start/stop button.

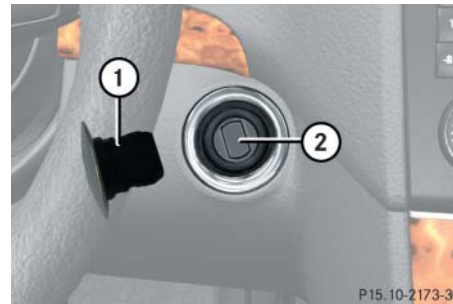

- ① KEYLESS-GO start/stop button
- ② Starter switch



### KEYLESS-GO start/stop button

- ③ USA only
- ④ Canada only

The SmartKey with KEYLESS-GO must be located in the vehicle.

- ▶ Insert KEYLESS-GO start/stop button ① into starter switch ② (if not inserted already).
- ▶ Make sure the automatic transmission is set to **P** (▷ page 191).
- ▶ Do not depress the brake pedal.



### Unlocking

#### Position 0

Before you press the KEYLESS-GO start/stop button, the vehicle's on-board electronics have status **0** (as with SmartKey removed).

#### Position 1

- ▶ Press the KEYLESS-GO start/stop button once.

This supplies power for some electrical consumers, such as seat adjustment.

**i** If you now press the KEYLESS-GO start/stop button

- once more, the ignition (position **2**) is switched on
- twice more, the power supply is again switched off

#### Ignition (or Position 2)

- ▶ Press the KEYLESS-GO start/stop button twice.

This supplies power for all electrical consumers.

All lamps (except high beam headlamp indicator lamp and turn signal indicator lamps unless activated) in the instrument cluster come on. If a lamp in the instrument cluster fails to come on when the ignition is switched on, have it checked and replaced if necessary. If a lamp in the instrument cluster remains on after starting the engine or comes on while driving, refer to "Lamps in instrument cluster" (▷ page 436).

**i** If you now press the KEYLESS-GO start/stop button once more, the power supply is again switched off.

**i** When you switch on the ignition, the indicator and warning lamps (except high beam headlamp indicator lamp and turn signal indicator lamps unless activated) in the instrument cluster come on. The indicator and warning lamps (except high beam headlamp indicator lamp and turn signal indicator lamps if activated) should go out when the engine is running. This indicates that the respective systems are operational.

For information on starting the engine using the KEYLESS-GO start/stop button, see "Starting with KEYLESS-GO\*" (▷ page 57).

For more information on KEYLESS-GO, see "SmartKey with KEYLESS-GO\*" (▷ page 115).

## ▼ Adjusting

### Warning!



All seat, head restraint, steering wheel, and rear view mirror adjustments, as well as fastening of seat belts, must be done before the vehicle is put into motion.

## Seats

### Warning!



Do not adjust the driver's seat while driving. Adjusting the seat while driving could cause the driver to lose control of the vehicle.

Never ride in a moving vehicle with the seat backrest in an excessively reclined position as this can be dangerous. You could slide under the seat belt in a collision. If you slide under it, the belt would apply force at the abdomen or neck. That could cause serious or fatal injuries. The seat backrest and seat belts provide the best restraint when the

wearer is in a position that is as upright as possible and belts are properly positioned on the body.

### Warning!



Your seat must be adjusted so that you can correctly fasten your seat belt (▷ page 53).

Observe the following points:

- Adjust the backrest until your arms are slightly angled when holding the steering wheel
- Adjust the seat to a comfortable seating position that still allows you to reach the accelerator/brake pedal safely. The position should be as far back as possible with the driver still able to operate the controls properly.
- Adjust the head restraint so that it is as close to the head as possible and the center of the head restraint supports the back of the head at eye level.

- Never place hands under the seat or near any moving parts while a seat is being adjusted.

Failure to do so could result in an accident and/or serious personal injury.

### Warning!



When leaving the vehicle, always remove the SmartKey or SmartKey with KEYLESS-GO\* from the starter switch, take it with you, and lock the vehicle.

Even with the SmartKey or the SmartKey with KEYLESS-GO\* removed from the starter switch or the SmartKey with KEYLESS-GO\* removed from the vehicle, the power seats can be operated.

Therefore, do not leave children unattended in the vehicle, or with access to an unlocked vehicle. A child's unsupervised access to a vehicle could result in an accident and/or serious personal injury.

## Adjusting

### Warning!



According to accident statistics, children are safer when properly restrained in the rear seating positions than in the front seating position. Thus, we strongly recommend that children be placed in the rear seats whenever possible. Regardless of seating position, children 12 years old and under must be seated and properly secured in an appropriately sized infant restraint, toddler restraint, or booster seat recommended for the size and weight of the child. For additional information, see “Children in the vehicle” (▷ page 91).

A child’s risk of serious or fatal injuries is significantly increased if the child restraints are not properly secured in the vehicle and/or the child is not properly secured in the child restraint.

### Seat adjustment

The seat adjustment switch is located on the entry side of each front seat base.

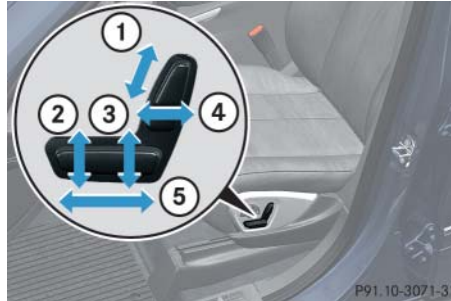

- ① Head restraint height (vehicles with memory function)\*
- ② Seat cushion tilt
- ③ Seat height
- ④ Backrest tilt
- ⑤ Seat fore and aft adjustment

**!** When moving the seats, make sure there are no items in the footwell or behind the seats; otherwise you could damage the seats.

**!** When the second-row seats are folded forward, e.g. for cargo compartment expansion (▷ page 304), the front seats may not be moved to the rearmost position. Otherwise you could damage the front and second-row seats.

**!** When adjusting the seat backrest tilt and head restraint height, make sure the sun visor is folded up (▷ page 210). If the head restraint is in the uppermost position, it could hit and damage the sun visor.

**i** Vehicles without memory function\*: The seats can be adjusted within 5 minutes after either front door has been opened. The counter resets each time

- you open or close a front door
- you insert the SmartKey into the starter switch
- you remove the SmartKey from the starter switch
- you switch the ignition on or off

**i** The memory function\* (▷ page 141) lets you store the settings for the seat positions together with the settings for the steering wheel and the exterior rear view mirrors.

### Seat fore and aft adjustment

- ▶ Press the switch forward or backward in direction of arrow ⑤.

### Seat height

- ▶ Press the switch up or down in direction of arrow ③.

### Seat cushion tilt

- ▶ Press the switch up or down in direction of arrow ② until your upper legs are lightly supported.

### Seat backrest tilt

- ▶ Press the switch forward or backward in direction of arrow ④.

### Head restraint height

#### Warning!



Do not drive the vehicle without the seat head restraints. Head restraints are intended to help reduce injuries during an accident.

With a rear seat occupied, make sure to move the respective head restraint up from the lowest non-use position and have the occupant adjust the head restraint properly.

For your protection, drive only with properly positioned and engaged head restraints.

Adjust the head restraint so that it is as close to the head as possible and the center of the head restraint supports the back of the head at eye level. This will reduce the potential for injury to the head and neck in the event of an accident or similar situation.

**!** Do not attempt to remove front seat head restraints. They can only be removed by qualified technicians. We recommend that you have this work carried out by an authorized Mercedes-Benz Light Truck Center.

Vehicles with memory function\*:

- ▶ Press switch ① (▷ page 46) up or down in direction of arrow.

Vehicles without memory function\*:



- ① Head restraint
- ② Release button

### Adjusting

Raising:

- ▶ Manually adjust the height of head restraint ① by pulling it upward.

If head restraint ① is fully retracted, push release button ② in direction of arrow and pull head restraint ① upward.

Lowering:

- ▶ To lower head restraint ①, push release button ② in direction of arrow and press down on head restraint ①.

#### Head restraint fore and aft adjustment



Manually adjust the angle of the head restraint.

- ▶ While seated, reach behind you with both hands and find lower edge of the head restraint.
- ▶ Adjust the head restraint to the desired position by pushing or pulling on the lower edge of the head restraint cushion.

For more information, see “Seats”  
(▷ page 130).

#### Steering wheel

##### Easy-entry/exit feature\*

This feature allows for easier entry into and exit from the vehicle. When entering and exiting the vehicle, the steering wheel is in its uppermost position.

The easy-entry/exit feature can be activated or deactivated in the *Comfort* submenu of the control system (▷ page 181).

##### Warning!



You must make sure no one can become trapped or injured by the moving steering wheel when the easy-entry/exit feature is activated.

To stop steering wheel movement, do one of the following:

- Move steering wheel adjustment stalk\* (▷ page 51).

- Press one of the stored position buttons\* or memory button **M**\* (▷ page 141).

Do not leave children unattended in the vehicle, or with access to an unlocked vehicle. Children could open the driver's door and unintentionally activate the easy-entry/exit feature, which could result in an accident and/or serious personal injury.

With the easy-entry/exit feature activated, the steering wheel will return to its last set position when you

- close the driver's door with the ignition switched on
- or
- insert the SmartKey into the starter switch or press the KEYLESS-GO\* start/stop button (▷ page 43) once with the driver's door closed

**i** *The last set steering wheel position is stored when*

- *the ignition is switched off (▷ page 41)*
- *the position is stored in memory (▷ page 141)*

With the easy-entry/exit feature activated, the steering wheel tilts upwards when you

- remove the SmartKey from the starter switch
- or
- open the driver's door with the SmartKey in starter switch position **0** or **1** (▷ page 41) or the KEYLESS-GO\* start/stop button in position **1** (▷ page 43)

**i** *If the current position for the steering wheel is in the uppermost tilt position, the steering wheel will no longer be able to move upward when the easy-entry/exit feature is activated.*

*The adjustment procedure is briefly interrupted, when the engine is started.*

### Warning!



Let the system complete the adjustment procedure before setting the vehicle in motion. All steering wheel adjustment must be completed before setting the vehicle in motion. Driving off with the steering wheel still adjusting could cause the driver to lose control of the vehicle.

### Steering wheel adjustment, manual

### Warning!



Only adjust the steering wheel with the vehicle at a standstill and make sure the steering wheel is securely locked in place before driving off.



### Adjusting

- ▷▷ Driving without the steering wheel adjustment locked may cause an unexpected steering wheel movement which could cause the driver to lose control of the vehicle. Make sure the steering wheel is securely locked by trying to move it up and down, and in and out before driving off.

Make sure that

- you can reach the steering wheel with your arms slightly bent at the elbows
- you can move your legs freely
- all displays (including malfunction and indicator lamps) on the instrument cluster are clearly visible

The steering wheel adjustment release handle is located on the lower left of the steering column.

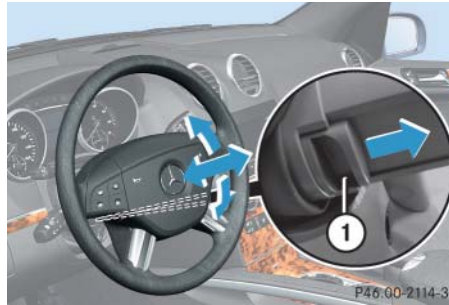

- ① Release handle
    - ▶ To unlock the steering column, pull release handle ① out to its stop limit.
    - ▶ Move steering wheel to the desired position.
    - ▶ Push release handle ① back to its original position to relock the steering column.
- The steering column is locked into position again.
- ▶ Make sure the steering column is securely locked by trying to move the steering wheel up and down as well as in and out before driving off.

### Steering wheel adjustment, electrical\*

#### Warning!



Do not adjust the steering wheel while driving. Adjusting the steering wheel while driving could cause the driver to lose control of the vehicle.

When leaving the vehicle, always remove the SmartKey or SmartKey with KEYLESS-GO\* from the starter switch, take it with you, and lock the vehicle.

Even with the SmartKey or SmartKey with KEYLESS-GO\* removed from the starter switch or the SmartKey with KEYLESS-GO\* removed from the vehicle, the steering wheel adjustment feature can be operated.

Therefore, do not leave children unattended in the vehicle, or with access to an unlocked vehicle. A child's unsupervised access to a vehicle could result in an accident and/or serious personal injury.

**i** The memory function\* (▷ page 141) lets you store the settings for the steering wheel together with the settings for seat positions and the exterior rear view mirrors.

Make sure that

- you can reach the steering wheel with your arms slightly bent at the elbows
- you can move your legs freely
- all displays (including malfunction and indicator lamps) on the instrument cluster are clearly visible

The steering wheel adjustment stalk is located on the lower left of the steering column.

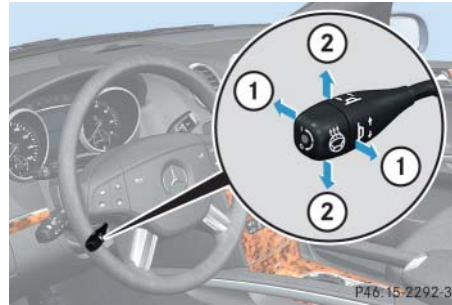

- ① Adjusting steering wheel, in or out  
 ② Adjusting steering wheel, up or down

### **Adjusting steering column in or out**

- Move stalk forward or back in direction of arrow ①.

### **Adjusting steering column up or down**

- Move stalk up or down in direction of arrow ②.

## **Mirrors**

Adjust the interior and exterior rear view mirrors before driving so that you have a good view of the road and traffic conditions.

### **Interior rear view mirror**

- Manually adjust the interior rear view mirror.

For more information, see “Rear view mirrors” (▷ page 208).

### **Exterior rear view mirrors**

#### **Warning!**



Exercise care when using the passenger-side exterior rear view mirror. The mirror surface is convex (outwardly curved surface for a wider field of view). Objects in mirror are closer than they appear. Check your interior rear view mirror or glance over your shoulder before changing lanes.



### Adjusting

The buttons are located on the driver's door.



- ① Driver's side exterior rear view mirror button
  - ② Adjustment button
  - ③ Passenger-side exterior rear view mirror button
- ▶ Switch on the ignition (▷ page 42).
  - ▶ Press button ① for the driver's side exterior rear view mirror or button ③ for the passenger-side exterior rear view mirror.

The indicator lamp on the respective button comes on for approximately 15 seconds.

**i** If you do not make adjustments to the selected exterior rear view mirror within 15 seconds, the indicator lamp goes out. You will then have to select the desired exterior rear view mirror again before any adjustments can be made. Adjustments can only be made with the indicator lamp for the respective exterior rear view mirror illuminated.

- ▶ Push adjustment button ② up, down, left, or right according to the desired setting.

**!** If an exterior rear view mirror was forcibly pushed forward (hit from the rear) or forcibly pushed rearward (hit from the front), reposition it by applying firm pressure until it snaps into place. The mirror housing is then properly positioned and you can adjust the mirror in the usual manner.

**!** Vehicle with power folding exterior rear view mirrors\*:

If an exterior rear view mirror housing is forcibly pushed forward (hit from the rear) or forcibly pushed rearward (hit from the front), press fold button ① (▷ page 210) to fold mirrors in, then press fold button ① (▷ page 210) again to fold mirrors out. Do not force mirrors by hand as this may damage the adjustment mechanism.

The mirror housing is then properly positioned and you can adjust the mirror in the usual manner.

**i** The memory function\* (▷ page 141) lets you store the settings for the exterior rear view mirrors together with the setting for the steering wheel and the seat positions.

**i** At low ambient temperatures, the exterior rear view mirrors will be heated automatically.

For more information, see "Rear view mirrors" (▷ page 208).

## ▼ Driving

### Warning!



Make sure that absolutely no objects are obstructing the pedal's range of movement. Keep the driver's footwell clear of all obstacles. If there are any floor mats or carpets in the footwell, make sure that the pedals still have sufficient clearance.

During sudden driving or braking maneuvers, the objects could get caught between the pedals. You could then no longer brake or accelerate. This could lead to accidents and injury.

### Fastening the seat belts

### Warning!



Always fasten your seat belt before driving off. Always make sure your passengers are properly restrained.

Failure to wear and properly fasten and position your seat belt greatly increases your risk of injuries and their likely severity in an accident. You and your passengers should always wear seat belts.

If you are ever in an accident, your injuries can be considerably more severe without your seat belt properly buckled. Without your seat belt buckled, you are much more likely to hit the interior of the vehicle or be ejected from it. You can be seriously injured or killed.

In the same crash, the possibility of injury or death is lessened if you are wearing your seat belt. The air bags can only provide the protection they were designed to afford if the occupants are using their seat belts (> page 86).

### Warning!



According to accident statistics, children are safer when properly restrained in the rear seating positions than in the front seating position. Thus, we strongly recommend that children be placed in the rear seats. Regardless of seating position, children 12 years old and under must be seated and properly secured in an appropriately sized infant restraint, toddler restraint, or booster seat recommended for the size and weight of the child. For additional information, see "Children in the vehicle" (> page 91).

A child's risk of serious or fatal injuries is significantly increased if the child restraints are not properly secured in the vehicle and/or the child is not properly secured in the child restraint.

#### Warning!



Never ride in a moving vehicle with the seat backrest in an excessively reclined position as this can be dangerous. You could slide under the seat belt in a collision. If you slide under it, the belt would apply force at the abdomen or neck. That could cause serious or even fatal injuries. The seat backrest and seat belt provide the best restraint when the wearer is in a position that is as upright as possible and the belt is properly positioned on the body.

#### Warning!



Never let more people ride in the vehicle than there are seat belts available. Make sure everyone riding in the vehicle is correctly restrained with a separate seat belt. Never use a seat belt for more than one person at a time.

#### Warning!



Read and observe the additional warning notices printed in the “Safety and Security” section (> page 78) and (> page 86).



- ① Seat belt outlet
- ② Latch plate
- ③ Buckle
- ④ Release button

- ▶ With a smooth motion, pull the belt out of seat belt outlet ①.
- ▶ Place the shoulder portion of the belt across the top of your shoulder and the lap portion across your hips.
- ▶ Push latch plate ② into buckle ③ (▷ page 54) until it clicks.
- ▶ If necessary, tighten the lap portion to a snug fit by pulling shoulder portion up.

### Proper use of seat belts

- ▶ Press release button ① and move the seat belt height adjuster upward or downward.
- Do not twist the belt when fastening.
  - Adjust seat belt so that the shoulder portion is located as close as possible to the middle of the shoulder (it should not touch the neck). Never pass the shoulder portion of the belt under your arm. For this purpose, you can adjust the height of the belt outlet (▷ page 55).
  - Position the lap belt as low as possible on your hips (over hip joint) and not across the abdomen.
  - Place the seat backrest in a position that is as upright as possible.
- Never use a seat belt for more than one person at a time.
  - Do not fasten a seat belt around a person and another object at the same time. When using a seat belt to secure infant or toddler restraints or children in booster seats, always follow the child seat manufacturer's instructions.
  - Check your seat belt periodically during travel to make sure that it is properly positioned.
  - Make sure the seat belt is always fitted snugly. Take special care of this when wearing loose clothing.

### Seat belt height adjustment



① Release button

### Warning!



Do not pass belts over sharp edges. They could tear.

Do not allow the belt to get caught in the door or in the seat adjustment mechanism. This could damage the belt.

Never attempt to make modifications to seat belts. This could impair the effectiveness of the belts.

Do not bleach or dye seat belts as this may severely weaken them. In a crash, they may not be able to provide adequate protection.

Damaged seat belts or belts that were highly stressed in an accident must be replaced. Contact an authorized Mercedes-Benz Light Truck Center.

### Starting the engine

### Warning!



Inhalation of exhaust gas is hazardous to your health. All exhaust gas contains carbon monoxide (CO), and inhaling it can cause unconsciousness and possible death.

Do not run the engine in confined areas (such as a garage) which are not properly ventilated. If you think that exhaust gas fumes are entering the vehicle while driving, have the cause determined and corrected immediately. If you must drive under these conditions, drive only with at least one window fully open.

### Automatic transmission



### Gearshift pattern for automatic transmission

- P** Park position
- R** Reverse gear
- N** Neutral
- D** Drive position

For more information on how to operate the gear selector lever, see “Automatic transmission” (▷ page 189).

## Starting with the SmartKey

For information on turning off the engine with the SmartKey, see “Turning off the engine” (▷ page 68).

### Gasoline engine

- ▶ Make sure the automatic transmission is set to **P**.

The transmission position indicator in the multifunction display should be on **P** (▷ page 155).

- ▶ Do not depress the accelerator.
- ▶ Turn the SmartKey in the starter switch to position **3** (▷ page 41) and hold until the engine starts.

**i** You can also use the “touch-start” function. Turn the SmartKey to position **3** and release it again immediately. The engine then starts automatically.

### Diesel engine

- ▶ Make sure the automatic transmission is set to **P**.

The transmission position indicator in the multifunction display should be on **P** (▷ page 155).

- ▶ Do not depress the accelerator.
- ▶ Turn the SmartKey in the starter switch to position **2** (▷ page 42).

Preglow indicator lamp  in the instrument cluster comes on.

- ▶ As soon as preglow indicator lamp  goes out, turn the SmartKey in the starter switch to position **3** (▷ page 42) and release it.

The engine starts automatically.

**i** If the engine is at operating temperature, preglow indicator lamp  may not stay on and you can start the engine without preglowing.

## Starting with KEYLESS-GO\*

### Warning!



As long as the SmartKey with KEYLESS-GO is in your vehicle, the vehicle can be started. Therefore, never leave children unattended in the vehicle, as they could otherwise accidentally start the engine.

When leaving the vehicle, always take the SmartKey with KEYLESS-GO with you and lock the vehicle. Do not leave children unattended in the vehicle, or with access to an unlocked vehicle.

You can start your vehicle without the SmartKey in the starter switch using the KEYLESS-GO start/stop button in the starter switch.

The SmartKey with KEYLESS-GO must be located in the vehicle.

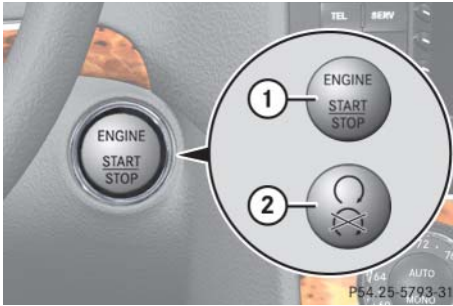

### KEYLESS-GO start/stop button

- ① USA only
- ② Canada only

- ▶ Make sure KEYLESS-GO start/stop button ① is inserted in the starter switch (▷ page 43).

**i** If you wish to start the engine using the SmartKey instead of the KEYLESS-GO feature, remove the KEYLESS-GO start/stop button from the starter switch (▷ page 43).

For information on turning off the engine with KEYLESS-GO, see “Turning off with KEYLESS-GO\*” (▷ page 69).

### Gasoline engine

- ▶ Make sure the automatic transmission is set to **P**.

The transmission position indicator in the multifunction display should be on **P** (▷ page 155).

- ▶ Depress the brake pedal during the starting procedure.
- ▶ Do not depress the accelerator.
- ▶ Press KEYLESS-GO start/stop button ① once.

The engine starts if the SmartKey with KEYLESS-GO is in the vehicle.

### Diesel engine

- ▶ Make sure the automatic transmission is set to **P**.

The transmission position indicator in the multifunction display should be on **P**.

- ▶ Depress the brake pedal during the starting procedure.
- ▶ Do not depress the accelerator.
- ▶ Press KEYLESS-GO start/stop button ① once.

The engine preglows and starts if the SmartKey with KEYLESS-GO is in the vehicle.

**i** If the engine is at operating temperature, the time the engine needs to preglow is reduced.

## Starting difficulties

If the engine does not start as described, carry out the following steps:

- ▶ If you are starting the engine with the SmartKey, turn SmartKey in starter switch to position **0** and repeat starting procedure.
- ▶ If you are starting the engine with KEYLESS-GO\*: Close any doors that may be open to allow for better detection of the SmartKey with KEYLESS-GO\*.

Or:

- ▶ Remove KEYLESS-GO\* start/stop button from starter switch (▷ page 43).
- ▶ Start the engine with the SmartKey as radio signals from another source may be interfering with the SmartKey with KEYLESS-GO\*.
- ▶ Repeat the starting procedure (▷ page 56). Remember that extended starting attempts can drain the battery.

- ▶ Get a jump start (▷ page 536).

If the engine does not start after several starting attempts, there could be a malfunction in the engine electronics or in the fuel supply system.

- ▶ Contact an authorized Mercedes-Benz Light Truck Center or call Roadside Assistance.

## Parking brake

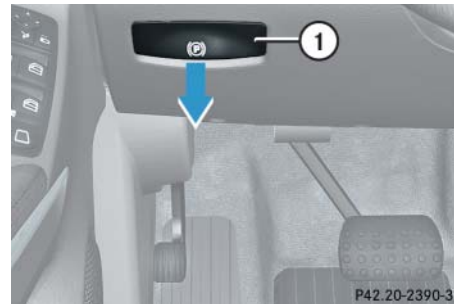

- ① Release handle

## Warning!



When leaving the vehicle, always remove the SmartKey or SmartKey with KEYLESS-GO\* from the starter switch, take it with you and lock the vehicle. Do not leave children unattended in the vehicle, or with access to an unlocked vehicle. Children could release the parking brake, which could result in an accident and/or serious personal injury.

- ▶ Release the parking brake by pulling on release handle ①.

The warning lamp **BRAKE** (USA only) or **①** (Canada only) in the instrument cluster goes out.



## Driving

### Driving off

- ▶ Depress the brake pedal.

The gear selector lever can now be used.

- ▶ Shift automatic transmission to **D** or **R** (▷ page 191).

**i** Wait for the gear selection process to complete before setting the vehicle in motion.

**i** Shifting from gear position **P** to position **R**, **N**, or **D** is only possible with the brake pedal depressed. Without the brake pedal depressed, the gear selector lever can be moved, but the parking pawl remains engaged, not allowing shifting to occur.

- ▶ Release the brake pedal.
- ▶ Carefully depress the accelerator pedal.

**!** If you hear a warning signal and the message **Release Parking Brake** appears in the multifunction display when driving off, you have forgotten to release the parking brake.

Release the parking brake (▷ page 59).

**i** Once the vehicle is in motion, the automatic central locking system engages and the locking knobs drop down.

The automatic door lock feature can be deactivated (▷ page 180).

You can open a locked door from the inside. Open door only when conditions are safe to do so.

After a cold start, the automatic transmission shifts at a higher engine revolution. This allows the catalytic converter (gasoline engine) or the oxidation catalyst (diesel engine) to reach its operating temperature earlier.

### Warning!



On slippery road surfaces, never downshift in order to obtain braking action. This could result in drive wheel slip and reduced vehicle control. Your vehicle's ABS will not prevent this type of loss of control.

### Warning!



It is dangerous to shift the automatic transmission out of **P** or **N** if the engine speed is higher than idle speed. If your foot is not firmly on the brake pedal, the vehicle could accelerate quickly forward or in reverse. You could lose control of the vehicle and hit someone or something. Only shift into gear when the engine is idling normally and when your right foot is firmly on the brake pedal.

**!** Shift the automatic transmission to position **P** or **R** only when the vehicle is stopped in order to avoid damaging the transmission.

**!** Do not run cold engine at high engine speeds. Running a cold engine at high engine speeds may shorten the service life of the engine.

**!** Simultaneously depressing the accelerator pedal and applying the brakes reduces engine performance and causes premature brake and drivetrain wear.

For more information, see “Driving instructions” (▷ page 347).

For information on off-road driving, see “Off-road driving” (▷ page 355).

## Switching on headlamps

### Low beam headlamps

The exterior lamp switch is located on the dashboard to the left of the steering wheel.



### Exterior lamp switch

- 1 Off
  - 2 Low beam headlamps on
- ▶ Switch on the ignition (▷ page 41).
  - ▶ Turn the exterior lamp switch to position .

The low beam headlamps come on.

### High beam

The combination switch is located on the left of the steering column.



### Combination switch

- ① High beam
- ② High beam flasher

- ▶ Push the combination switch in direction of arrow ①.

The high beam headlamp indicator lamp  in the instrument cluster comes on (▷ page 26).

For more information on headlamps, see “Lighting” (▷ page 143).

## Driving

### Turn signals

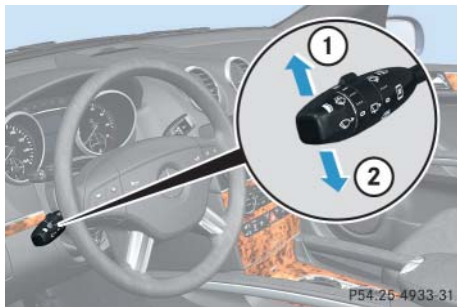

The combination switch is located on the left of the steering column.



#### Combination switch

- ① Turn signals, right
- ② Turn signals, left

- ▶ Press the combination switch in direction of arrow ① or ②.

The corresponding turn signal indicator lamp  or  in the instrument cluster flashes (▷ page 26).

The combination switch resets automatically after major steering wheel movement.

**i** To signal minor directional changes such as changing lanes, press combination switch only to point of resistance and release. The corresponding turn signal will flash three times.

### Windshield wipers

The combination switch is located on the left of the steering column.

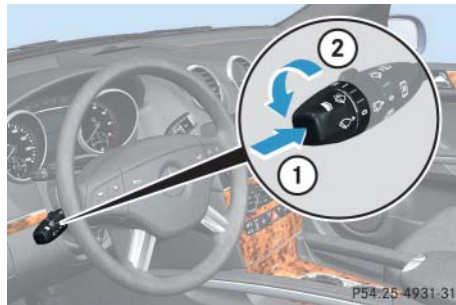

#### Combination switch



- ① Single wipe  
Wiping with windshield washer fluid
- ② Switching on windshield wipers

- ▶ Switch on the ignition (▷ page 42).

**!** Do not operate the windshield wipers when the windshield is dry. Dust that accumulates on a windshield might scratch the glass and/or damage the wiper blades when wiping occurs on a dry windshield. If it is necessary to operate the windshield wipers in dry weather conditions, always operate the windshield wipers with windshield washer fluid (▷ page 64).

**!** If anything blocks the windshield wipers (leaves, snow, etc.), switch them off immediately.





- For safety reasons, stop the vehicle in a safe location and
  - remove SmartKey from starter switchor
  - turn off the engine by pressing the KEYLESS-GO\* start/stop button and open the driver's door (with the driver's door open, starter switch is in position 0, same as with SmartKey removed from starter switch)before attempting to remove any blockage.
- Remove blockage.
- Turn the windshield wipers on again.

If windshield wipers fail to function at all in the combination switch position  or ,

- set the combination switch to the next higher wiper speed
- have the windshield wipers checked at the nearest authorized Mercedes-Benz Light Truck Center

### Switching on windshield wipers

- ▶ Turn the combination switch to the desired position depending on the intensity of the rain.

-  Windshield wipers off
-  Slow intermittent wiping  
Rain sensor operation with low sensitivity.
-  Fast intermittent wiping  
Rain sensor operation with high sensitivity.
-  Slow continuous wiping
-  Fast continuous wiping



### Intermittent wiping

Only switch on intermittent wiping under wet weather conditions or in the presence of precipitation.

When you select intermittent wiping, the rain sensor is activated. The rain sensor automatically sets a suitable wiping interval depending on the wetness of the sensor surface.

 Do not leave windshield wipers on an intermittent setting when the vehicle is taken to an automatic car wash or during windshield cleaning. Wipers will operate in the presence of water sprayed on the windshield, and windshield wipers may be damaged as a result.

 If you have set intermittent wiping, dirt on the surface of the rain sensor or optical effects may cause the windshield wipers to wipe in an undesired fashion. This could then damage the windshield wiper blades or scratch the windows. You should therefore switch off the windshield wipers when weather conditions are dry.

- ▶ Turn the combination switch to position  or .

After the initial wipe, pauses between wipes are automatically controlled by the rain sensor.

 Intermittent wiping is interrupted when the vehicle is at a standstill and a front door is opened. This protects persons getting into or out of the vehicle from being sprayed.

Intermittent wiping will be continued when all doors are closed and

- the automatic transmission is set to position **D** or **R**  
or
- the wiper setting is changed using the combination switch

### Single wipe

- ▶ Press the combination switch briefly in direction of arrow  to the resistance point.

The windshield wipers wipe one time without washer fluid.

## Driving

### Wiping with windshield washer fluid

- ▶ Press the combination switch in direction of arrow ① past the resistance point.

The windshield wipers operate with washer fluid.

**i** To prevent smears on the windshield or noisy/chattering wiper blades, wipe with windshield washer fluid every now and then even when it is raining.

For information on cleaning the headlamps with washer fluid, see “Headlamp cleaning system\*” (▷ page 208).

For information on filling up the washer reservoir, see “Windshield/rear window washer system and headlamp cleaning system\*” (▷ page 383).

### Rear window wiper/washer

The combination switch is located on the left of the steering column.

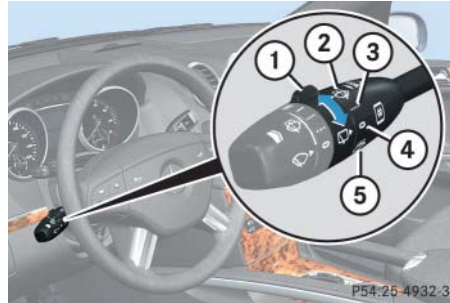

#### Combination switch

- ① Rear window wiper switch
- ② Wiping rear window with washer fluid
- ③ Intermittent wiping
- ④ Rear window wiper off
- ⑤ Wiping rear window with washer fluid

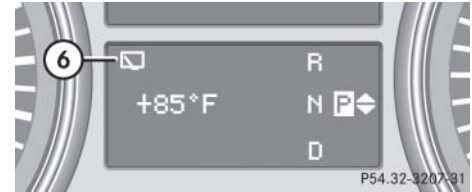

⑥ Rear window wiper indicator

- ▶ Switch on the ignition (▷ page 42).

**i** The rear window wiper engages automatically when the automatic transmission is shifted to position **R** with the windshield wipers switched on.

#### Activating intermittent wipe

- ▶ Turn rear window wiper switch ① to position ③ (▷ page 64).

In the lower multifunction display you will see indicator ⑥, indicating that the rear window wiper is activated.

### Deactivating intermittent wipe

- ▶ Turn rear window wiper switch ① to position ④ (▷ page 64).

Indicator ⑥ (▷ page 64) for the rear window wiper is cleared from the lower multifunction display, indicating that the rear window wiper is deactivated.

### Wiping with windshield washer fluid

- ▶ Turn and hold rear window wiper switch ① in position ② or ⑤ (▷ page 64) until the rear window is clean.

The rear window wiper operates with washer fluid.

For information on filling up the washer reservoir, see “Windshield/rear window washer system and headlamp cleaning system\*” (▷ page 383).

### Problems while driving

#### The engine runs erratically and misfires

- An ignition cable may be damaged (gasoline engine only).
  - The engine electronics may not be operating properly.
  - Unburned gasoline may have entered the catalytic converter and damaged it (gasoline engine only).
- ▶ Give very little gas.
  - ▶ Have the problem repaired by an authorized Mercedes-Benz Light Truck Center as soon as possible.

#### The coolant temperature is above 248°F (120°C)

The coolant is too hot and is no longer cooling the engine.

- ▶ Stop the vehicle in a safe location as soon as possible and turn off the engine. Allow engine and coolant to cool off.
- ▶ Check the coolant level and add coolant if necessary (▷ page 381).

### Driving

#### In case of accident

If the vehicle is leaking fuel:

- ▶ Do not start the engine under any circumstances.
- ▶ Notify local fire and/or police authorities.

If the extent of the damage cannot be determined:

- ▶ Contact an authorized Mercedes-Benz Light Truck Center or call Roadside Assistance.

If no damage can be determined on the

- major assemblies
  - fuel system
  - engine mount:
- ▶ Start the engine in the usual manner.

## ▼ Parking and locking

You have now completed your first drive. You have properly stopped and parked your vehicle. End your drive as follows.

### Warning!



With the engine not running, there is no power assistance for the brake and the steering system. In this case, it is important to keep in mind that a considerably higher degree of effort is necessary to brake and steer the vehicle.

### Warning!



Do not park this vehicle in areas where combustible materials such as grass, hay or leaves can come into contact with the hot exhaust system, as these materials could be ignited and cause a vehicle fire.

To reduce the risk of personal injury, or damage to the vehicle drivetrain, as a result of vehicle movement, before turning off the engine and leaving the vehicle always:

- Keep right foot on brake pedal.
- Firmly depress parking brake pedal.
- Shift the automatic transmission to position **P**.
- Slowly release brake pedal.
- When parked on an incline, turn front wheel towards the road curb.
- Turn the SmartKey in the starter switch to position **0** and remove the SmartKey from the starter switch, or press the start/stop button (vehicles with KEYLESS-GO\*).
- Take the SmartKey or the SmartKey with KEYLESS-GO\* with you and lock vehicle when leaving.

## Parking brake

### Warning!



Engaging the parking brake while the vehicle is in motion can cause the rear wheels to lock up. You could lose control of the vehicle and cause an accident. In addition, the vehicle's brake lights do not light up when the parking brake is engaged.

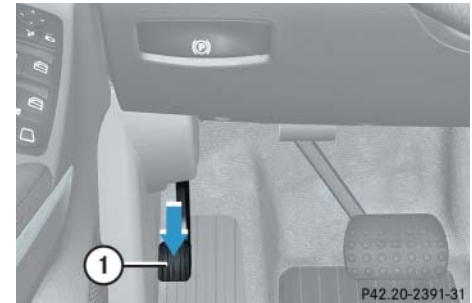

① Parking brake pedal



### Parking and locking

- ▶ Step firmly on parking brake pedal ①.

When the engine is running, the warning lamp **BRAKE** (USA only) or **(P)** (Canada only) in the instrument cluster comes on.

#### Warning!



When leaving the vehicle, always remove the SmartKey or SmartKey with KEYLESS-GO\* from the starter switch, take it with you and lock the vehicle. Do not leave children unattended in the vehicle, or with access to an unlocked vehicle. Children could release the parking brake and/or shift the automatic transmission out of position **P**, either of which could result in an accident and/or serious personal injury.

#### Warning!



Getting out of your vehicle with the automatic transmission not fully engaged in position **P** is dangerous. Also, when parked on an incline, position **P** alone may not prevent your vehicle from moving, possibly hitting people or objects.

Always set the parking brake in addition to shifting to position **P** (▷ page 191).

When parked on an incline, also turn front wheel towards the road curb.

#### Switching off headlamps

- ▶ Turn the exterior lamp switch to **0** (▷ page 61).

For more information, see “Lighting” (▷ page 143).

#### Turning off the engine

**i** If the engine cannot be turned off as described, see “Emergency engine shut-down” (▷ page 545).

- ▶ Shift the automatic transmission to position **P** (▷ page 191).

#### Warning!



Do not turn off the engine before the vehicle has come to a complete stop. With the engine not running, there is no power assistance for the brake and steering systems. In this case, it is important to keep in mind that a considerably higher degree of effort is necessary to brake and steer the vehicle.

- ▶ Apply the parking brake (▷ page 67).

**i** Always set the parking brake in addition to shifting the automatic transmission to position **P** (▷ page 191).

When parked on an incline, also turn front wheel towards the road curb.

**!** Observe instructions when taking the vehicle through an automatic conveyor type car wash (▷ page 428).

### Turning off with the SmartKey

- ▶ Turn the SmartKey in the starter switch to position **0** (▷ page 41).
- ▶ Remove the SmartKey from the starter switch.

The immobilizer is activated.

**!** If you turn off the engine using the SmartKey and

- remove the SmartKey from the starter switch  
or
- open a front door

the automatic transmission will shift to park position **P** automatically.

Keep in mind that turning off the engine with the SmartKey alone only will automatically shift the automatic transmission to neutral position **N**.

### Turning off with KEYLESS-GO\*

- ▶ Press the KEYLESS-GO start/stop button (▷ page 43) to turn off the engine.

With the driver's door closed, the starter switch is now in position **1**. With the driver's door opened, the starter switch is set to position **0**, same as SmartKey removed from starter switch (▷ page 41).

**i** In an emergency you can turn off the engine while driving by pressing and holding the KEYLESS-GO start/stop button for approximately 3 seconds.

**!** If you turn off the engine using the KEYLESS-GO start/stop button and open a front door, the automatic transmission will shift to park position **P** automatically.

Keep in mind that turning off the engine using the KEYLESS-GO start/stop button alone only will automatically shift the automatic transmission to neutral position **N**.

If you have started the engine with the KEYLESS-GO start/stop button and cannot turn it off as described above:

- ▶ Remove the KEYLESS-GO start/stop button from the starter switch.
- ▶ Insert the SmartKey with KEYLESS-GO into the starter switch.

The engine turns off. The starter switch is in position **0** (▷ page 41).

### Parking and locking

#### Releasing seat belts

- ▶ Press the seat belt release button (▷ page 54).

Allow the retractor to completely rewind the seat belt by guiding the latch plate.

**!** *Make sure the seat belt retracts fully so that the seat belt and/or latch plate cannot get caught or pinched in the door or in the seat mechanism. This can damage the seat belt and impair the effectiveness of the seat belt, and/or cause damage to the door and/or door trim panel. Such damage is not covered by the Mercedes-Benz Limited Warranty.*

*Damaged seat belts must be replaced. Contact an authorized Mercedes-Benz Light Truck Center.*

#### Locking

##### Warning!



To prevent possible personal injury, always keep hands and fingers away from the door openings when closing the doors. Be especially careful when small children are around.

Before closing doors, make sure there is no possibility of someone getting caught in a door during closing.

##### Warning!



When leaving the vehicle, always remove the SmartKey from the starter switch, take the SmartKey with KEYLESS-GO\* with you, and lock your vehicle. Do not leave children unattended in the vehicle, or with access to an unlocked vehicle. A child's unsupervised access to a vehicle could result in an accident and/or serious personal injury.

**i** *The exterior lamps switch off automatically when you remove the SmartKey from the starter switch or open the driver's door.*

*When the parking lamps or the rear fog lamp are switched on and you remove the SmartKey from the starter switch and open the driver's door, an acoustic signal sounds.*

*In addition the message Switch Off Lights appears in the multifunction display.*

*Switch off the parking lamps or the rear fog lamp.*

**!** *Failure to switch off the parking lamps or the rear fog lamp when leaving the vehicle may result in a discharged battery.*

- ▶ Exit the vehicle and close all doors and the tailgate.

### Locking with the SmartKey

- ▶ Press lock button  on the SmartKey (▷ page 40).

With the tailgate and all doors closed, the turn signal lamps flash three times. The locking knobs on the doors move down. The anti-theft alarm system is armed.

For more information, see “Locking and unlocking” (▷ page 112).

### Locking with KEYLESS-GO\*

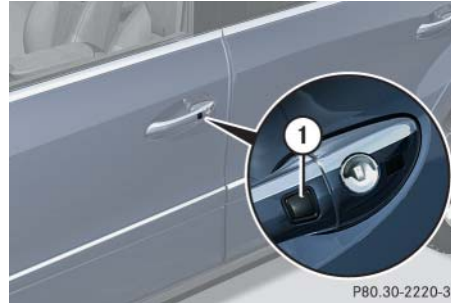

- ① Lock button on the outside door handle
- ▶ Press lock button ① on an outside door handle.

With the tailgate and all doors closed, the turn signal lamps flash three times. The locking knobs on the doors move down. The anti-theft alarm system is armed.

For more information, see “Locking and unlocking” (▷ page 112).



**Occupant safety**

**Panic alarm**

**Driving safety systems**

**Anti-theft systems**



## Occupant safety

In this section you will learn the most important facts about the restraint systems of the vehicle.

The restraint systems are

- Seat belts (▷ page 86)
- Child restraints (▷ page 96)
- Lower Anchors and Tethers for Children (LATCH) (▷ page 95)

Additional protection potential provide

- Supplemental Restraint System (SRS) with
  - Air bags (▷ page 76)
  - Air bag control unit (with crash sensors)
  - Emergency Tensioning Device (ETD) for seat belts (▷ page 89)
  - Seat belt force limiter (▷ page 89)
- Active head restraints (▷ page 90)

Air bag system components with

- Front passenger front air bag off indicator lamp (▷ page 85)
- Front passenger seat with Occupant Classification System (OCS) (▷ page 81)

Although independent systems, their protective functions work in conjunction with each other.

**i** For information on infants and children traveling with you in the vehicle and restraint systems for infants and children, see “Children in the vehicle” (▷ page 91).

The SRS system conducts a self-test when the ignition is switched on and in regular intervals while the engine is running. This facilitates early detection of malfunctions. The **SRS** indicator lamp in the instrument cluster (▷ page 28) comes on when the ignition is switched on and goes out no later than a few seconds after the engine was started.

The SRS components are in operational readiness if the **SRS** indicator lamp is not lit when the engine is running.

A malfunction in the system has been detected if the **SRS** indicator lamp:

- fails to go out not later than approximately 4 seconds after the engine was started
- does not come on at all
- comes on after the engine was started or while driving

**Warning!**

Modifications to or work improperly conducted on restraint systems (such as seat belts and anchors, emergency tensioning devices, seat belt force limiters or air bags) or their wiring, as well as tampering with interconnected electronic systems, can lead to the restraint systems no longer functioning as intended.

Air bags or emergency tensioning devices, for example, could deploy inadvertently or fail to deploy in accidents although the deceleration threshold for air bag deployment is exceeded. Therefore, never modify the restraint systems. Do not tamper with electronic components or their software.

**Warning!**

In the event that the **SRS** indicator lamp comes on during driving or does not come on at all, the SRS self-check has detected a malfunction. For your safety, we strongly recommend that you visit an authorized Mercedes-Benz Light Truck Center immediately to have the system checked; otherwise the SRS may not deploy when needed in an accident, which could result in serious or fatal injury, or it might deploy unexpectedly and unnecessarily which could also result in injury.

In addition, improper work on the SRS creates a risk of rendering the SRS inoperative or causing unintended air bag deployment. Work on the SRS must therefore only be performed by qualified technicians. Contact an authorized Mercedes-Benz Light Truck Center.

If it is necessary to modify an air bag system to accommodate a person with disabilities, contact a local authorized Mercedes-Benz Light Truck Center or call our Customer Assistance Center at 1-800-FOR-MERCEdes (1-800-367-6372) for details.



## Occupant safety

### Air bags

#### Warning!



Air bags are designed to reduce the potential of injury and fatality in certain frontal impacts (front air bags), side impacts (side impact air bags and window curtain air bags) or rollovers (window curtain air bags). However, no system available today can completely eliminate injuries and fatalities.

The deployment of the air bags temporarily releases a small amount of dust from the air bags. This dust, however, is neither injurious to your health, nor does it indicate a fire in the vehicle. The dust might cause some temporary breathing difficulty for people with asthma or other breathing trouble. To avoid this, you may wish to get out of the vehicle as soon as it is safe to do so. If you have any breathing difficulty but cannot get out of the vehicle after the air bag inflates, then get fresh air by opening a window or door.

#### Warning!



To reduce the risk of injury when the front air bags inflate, it is very important for the driver and front passenger to always be in a properly seated position and to wear their respective seat belt.

For maximum protection in the event of a collision always be in normal seated position with your back against the seat backrest. Fasten your seat belt and make sure it is properly positioned on your body (▷ page 53).

Since the air bag inflates with considerable speed and force, a proper seating and hands on steering wheel position will help to keep you at a safe distance from the air bag. Occupants who are unbelted, out of position or too close to the air bag can be seriously injured or killed by an air bag as it inflates with great force in the blink of an eye:

- Sit properly belted in a position that is as upright as possible with your back against the seat backrest.

- Adjust the driver's seat as far as possible rearward, still permitting proper operation of vehicle controls. The distance from the center of the driver's breastbone to the center of the air bag cover on the steering wheel must be at least 10 inches (25 cm) or more. You should be able to accomplish this by a combination of adjustments to the seat and steering wheel. If you have any problems, please see an authorized Mercedes-Benz Light Truck Center.
- Do not lean your head or chest close to the steering wheel or dashboard.
- Keep hands on the outside of steering wheel rim. Placing hands and arms inside the rim can increase the risk and potential severity of hand/arm injury when driver's front air bag inflates.
- Adjust the front passenger seat as far as possible rearward from the dashboard when the seat is occupied.

- Always sit as upright as possible, properly use the seat belts and use an appropriately sized infant restraint, toddler restraint, or booster seat recommended for the size and weight of the child.

Failure to follow these instructions can result in severe injuries to you or other occupants.

If you sell your vehicle, it is important that you make the buyer aware of this safety information. Be sure to give the buyer this Operator's Manual.

### Warning!



Accident research shows that the safest place for children in an automobile is in the rear seat.

It should be noted that with respect to both, front side impact air bags or the rear side impact air bags\*, there is a possibility for a side impact air bag related injury if occupants, especially children, are not properly seated or restrained when next to a side impact air bag which needs to deploy rapidly in a side impact in order to do its job.

To help avoid the possibility of injury, please follow these guidelines:

- (1) Always sit as upright as possible, properly use the seat belts, and for all children 12 years old and under, use an appropriately sized infant restraint, toddler restraint, or booster seat recommended for the size and weight of the child.
- (2) Always wear seat belts properly.

**i** Air bags are designed to deploy only in certain frontal impacts (front air bags), and in side impacts (side impact and window curtain air bags) which exceed preset thresholds, and in certain rollovers (window curtain air bags). Only during these events will they provide their supplemental protection.

*The driver and passengers should always wear their seat belts. Otherwise it is not possible for air bags to provide their supplemental protection.*

*In case of other types of impacts and impacts below air bag deployment thresholds, air bags will not deploy. The driver and passenger will then be protected to the extent possible by a properly fastened seat belt. A properly fastened seat belt is also needed to provide the best possible protection in a rollover.*

*We caution you not to rely on the presence of the air bags in order to avoid wearing your seat belt.*

*It is important to your safety and that of your passengers that you replace deployed air bags and repair any malfunctioning air bags to make sure the vehicle will continue to provide supplemental crash protection for occupants.*

## Occupant safety

### Safety guidelines for the seat belt, emergency tensioning device and air bag

#### Warning!



- Damaged seat belts or belts that were highly stressed in an accident must be replaced and their anchoring points must also be checked. Only use belts installed or supplied by an authorized Mercedes-Benz Light Truck Center.
- Air bags and pyrotechnic Emergency Tensioning Devices (ETDs) are designed to function on a one-time-only basis. An air bag or ETD that is deployed must be replaced.
- Do not pass belts over sharp edges. They could tear.
- Do not make any modification that could change the effectiveness of the belts.
- Do not bleach or dye seat belts as this may severely weaken them. In a crash they may not be able to provide adequate protection.

- No modifications of any kind may be made to any components or wiring of the SRS. This includes changing or removing any component or part of the SRS, the installation of additional trim material, badges, etc. over the steering wheel hub, front passenger front air bag cover, outboard sides of the seat backrests, door trim panels, or door frame trims, and installation of additional electrical/electronic equipment on or near SRS components and wiring. Keep area between air bags and occupants free from objects (e.g. packages, purses, umbrellas, etc.).
- Do not hang items such as coat hangers from the coat hooks or handles over the door. These items may turn into projectiles and cause head and other injuries when the window curtain air bag is deployed.
- Air bag system components will be hot after an air bag has inflated. Do not touch.

- Never place your feet on the instrument panel, dashboard, or on the seat. Always keep both feet on the floor in front of the seat.
- In addition, improper repair work on the SRS creates a risk of rendering the SRS inoperative or causing unintended air bag deployment. Work on the SRS must therefore only be performed by qualified technicians. Contact an authorized Mercedes-Benz Light Truck Center.
- For your protection and the protection of others, when scrapping the air bag unit or emergency tensioning device, our safety instructions must be followed. These instructions are available from any authorized Mercedes-Benz Light Truck Center.
- Given the considerable deployment speed, required inflation volume, and the textile structure of the air bags, there is the possibility of abrasions or other potentially more serious injuries resulting from air bag deployment.

**Warning!**

Only use seat covers which have been tested and approved by Mercedes-Benz for your vehicle model. Using other seat covers may interfere with or prevent the deployment of the front side impact air bags or the rear side impact air bags\*. Contact an authorized Mercedes-Benz Light Truck Center for availability.

When you sell your vehicle we strongly urge you to give notice to the subsequent owner that it is equipped with an SRS by alerting them to the applicable section in the Operator's Manual.

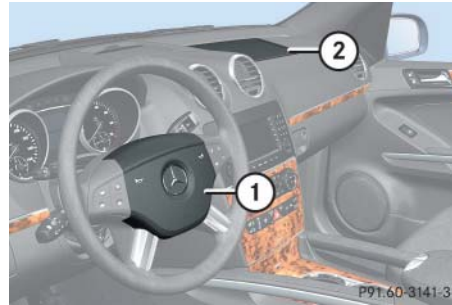
**Front air bags**

- ① Driver air bag
- ② Passenger air bag

Driver and front passenger front air bags are deployed:

- in the event of certain frontal impacts
- if impact exceeds a preset deployment threshold
- independently of the side impact air bags

**i** The front air bags in this vehicle have been designed to inflate in two stages. This allows the air bag to have different rates of inflation that are based on the rate of relevant vehicle deceleration as assessed by the air bag control unit.

On the front passenger-side, the front air bag deployment is additionally influenced by the passenger's weight category as identified by the Occupant Classification System (OCS) (▷ page 81).

The lighter the front passenger side occupant, the higher the vehicle deceleration rate required for the second stage inflation of the air bag.

## Occupant safety

The air bags will not deploy in impacts which do not exceed the system's deployment thresholds. You will then be protected by the fastened seat belts.

The front passenger front air bag will only be deployed if:

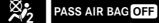
- the system senses that the front passenger seat is occupied
- the  indicator lamp in the center console is not lit (▷ page 85)
- the impact exceeds a preset deployment threshold

### Side impact air bags, window curtain air bags

#### Warning!



The pressure sensors for side impact air bag control are located in the doors. Do not modify any components of the doors or door trim panels including, for example, the addition of door speakers.

Improper repair work on the doors or the modification or addition of components to the doors create a risk of rendering the side impact air bags inoperative or causing unintended air bag deployment. Work on the doors must therefore only be performed by qualified technicians. Contact an authorized Mercedes-Benz Light Truck Center.

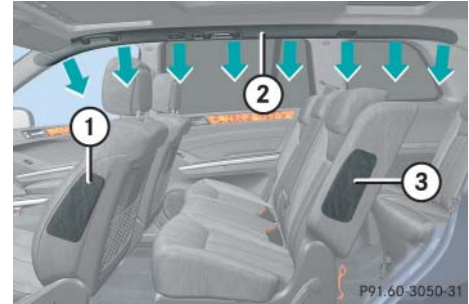

- ① Front side impact air bag
- ② Window curtain air bag
- ③ Rear side impact air bag\*

The side impact air bags and window curtain air bags are deployed:

- on the impacted side of the vehicle
- in impacts exceeding a preset deployment threshold
- independently of the front air bags

In addition, the window curtain air bags ② are deployed in certain vehicle rollovers.

The side impact air bags and window curtain air bags are not deployed in impacts which do not exceed the system's deployment threshold.

The front passenger side impact air bag will not deploy if the OCS senses that the front passenger seat is empty and the front passenger seat belt is not fastened (latch plate is not inserted into the buckle). With an empty front passenger seat and the seat belt fastened (latch plate properly inserted into buckle) the front passenger side impact air bag will deploy independently of the empty seat.

### Warning!



Only use seat covers which have been tested and approved by Mercedes-Benz for your vehicle model. Using other seat covers may interfere with or prevent the deployment of the front side impact air bags or the rear side impact air bags\*. Contact your authorized Mercedes-Benz Light Truck Center for availability.

## Occupant Classification System

The Occupant Classification System (OCS) automatically turns the front passenger front air bag on or off based on the classified occupant weight category determined by weight sensor readings from the front passenger seat.

**i** *The system does not deactivate the front passenger side impact air bag, the window curtain air bag, and the emergency tensioning device.*

Occupants must sit properly belted in a position that is as upright as possible with their back against the seat backrest and feet on the floor to be correctly classified. If the occupant's weight is transferred to another object in the vehicle (e.g. by leaning on armrests), the OCS may not be able to properly approximate the occupant's weight category.

Furthermore, the occupant weight may appear to increase or decrease due to objects hanging on the seat, other passengers pushing on the seat, objects lodged underneath the seat or stuffed between seat and middle console or between seat and door or due to objects applying pressure on the back of the seat. Always make sure that the seat has clearance in all directions at all times.

**i** *If your seat, including your trim cover and cushion needs to be serviced in any way, take the vehicle to an authorized Mercedes-Benz Light Truck Center.*

*Only seat accessories approved by Mercedes-Benz may be used.*

Both, driver and the front passenger should always use the





indicator lamp as an indication of whether or not the front passenger is properly positioned.

## Occupant safety

### Warning!







If the  **PASS AIR BAG OFF** indicator lamp illuminates when an adult or someone larger than a small individual is in the front passenger seat, have the front passenger re-position himself or herself in the seat until the  **PASS AIR BAG OFF** indicator lamp goes out, or check whether objects are caught under or around the seat.

More information about air bag display messages (▷ page 460).

In the event of a collision, the air bag control unit will not allow front passenger front air bag deployment when the OCS classified the front passenger seat occupant as being up to or less than the weight of a typical 12-month-old child in a standard child restraint or if the front passenger seat is sensed as being empty.

When the OCS senses that the front passenger seat occupant is classified as being up to or less than the weight of a typical 12-month-old child in a standard child restraint, the  **PASS AIR BAG OFF** indicator lamp will illuminate when the engine is started and remain illuminated, indicating that the front passenger front air bag is deactivated.

When the OCS senses that the front passenger seat is classified as being empty, the  **PASS AIR BAG OFF** indicator lamp will illuminate when the engine is started and remain illuminated, indicating that the front passenger front air bag is deactivated.

When the OCS senses that the front passenger seat occupant is classified as being heavier than the weight of a typical 12-month-old child seated in a standard child restraint or as being a small individual (such as a young teenager or a small adult), the  **PASS AIR BAG OFF** indicator lamp will illuminate for approximately 6 seconds when the engine is started and then, depending on occupant weight sensor readings from the seat, remain illuminated or go out. With the  **PASS AIR BAG OFF** indicator lamp illuminated, the front passenger front air bag is deactivated. With the  **PASS AIR BAG OFF** indicator lamp out, the front passenger front air bag is activated.

When the OCS senses that the front passenger seat occupant is classified as an adult or someone larger than a small individual, the  **PASS AIR BAG OFF** indicator lamp will illuminate for approximately 6 seconds when the engine is started and then go out, indicating that the front passenger front air bag is activated.

If the  **PASS AIR BAG OFF** indicator lamp is illuminated, the front passenger front air bag is deactivated and will not be deployed.

If the  **PASS AIR BAG OFF** indicator lamp is not illuminated, the front passenger front air bag is activated and will be deployed:

- in the event of certain frontal impacts
- if impact exceeds a preset deployment threshold
- independently of the side impact air bags.

If the front passenger front air bag is deployed, the rate of inflation will be influenced by:

- the rate of vehicle deceleration as assessed by the air bag control unit
- the front passenger's weight category as identified by the Occupant Classification System (OCS)

### Warning!



According to accident statistics, children are safer when properly restrained in the rear seating positions than in the front seating position. Thus, we strongly recommend that children be placed in the rear seats whenever possible. Regardless of seating position, children 12 years old and under must be seated and properly secured in an appropriate infant or child restraint recommended for the size and weight of the child.

The infant or child restraint must be properly secured with the vehicle's seat belt, the seat belt and top tether strap, or lower anchors and top tether strap, fully in accordance with the child seat manufacturer's instructions.

Children can be killed or seriously injured by an inflating air bag. Note the following important information when circumstances require you to place a child in the front passenger seat:





- Your vehicle is equipped with air bag technology designed to turn off the front passenger front air bag in your vehicle when the system senses the weight of a typical 12-month-old child or less along with the weight of a standard appropriate child restraint on the front passenger seat.
- A child in a rear-facing child restraint on the front passenger seat will be seriously injured or even killed if the front passenger front air bag inflates in a collision which could occur under some circumstances, even with the air bag technology installed in your vehicle. The only means to completely eliminate this risk is to never place a child in a rear-facing child restraint in the front seat. We therefore strongly recommend that you always place a child in a rear-facing child restraint in the back seat.





## Occupant safety



- If you must install a rear-facing child restraint on the front passenger seat because circumstances require you to do so, make sure that the  indicator lamp is illuminated, indicating that the front passenger front air bag is deactivated. Should the  indicator lamp not illuminate or go out while the restraint is installed, please check installation. Periodically check the  indicator lamp while driving to make sure the  indicator lamp is illuminated. If the  indicator lamp goes out or remains out, do not transport a child on the front passenger seat until the system has been repaired. A child in a rear-facing child restraint on the front passenger seat will be seriously injured or even killed if the front passenger front air bag inflates.

- If you have to place a child in a forward-facing child restraint on the front passenger seat, move the seat as far back as possible, use the proper child restraint recommended for the age, size and weight of the child, and secure child restraint with the vehicle's seat belt according to the child seat manufacturer's instructions. For children larger than the typical 12-month-old child, the front passenger front air bag may or may not be activated (▷ page 82).

 *Deployment of the driver front air bag does not mean that the front passenger front air bag also should have deployed.*

*The Occupant Classification System (▷ page 81) may have determined:*

- *that the seat was empty or occupied by the weight up to or less than that of a typical 12-month-old child seated in a standard child restraint – both instances where the system suppresses deployment of the front passenger front air bag even though the impact met the criteria and was of sufficient severity to deploy the driver front air bag.*
- *that the seat was occupied by a small individual (such as a young teenager or a small adult) or a child weighing more than the weight of a typical 12-month-old child in a standard child restraint – instances where the system may suppress deployment of the front passenger front air bag even though the impact met the criteria and was of sufficient severity to deploy the driver front air bag.*

The  **PASS AIR BAG OFF** indicator lamp is located in the center console.



①  **PASS AIR BAG OFF** indicator lamp

The  **PASS AIR BAG OFF** indicator lamp ① will be illuminated, except with the SmartKey removed from the starter switch or with the starter switch in position **0** (▷ page 41).

### Warning!



If the **SRS** indicator lamp and the  **PASS AIR BAG OFF** indicator lamp are lit at the same time, there is a malfunction in the Occupant Classification System. The front passenger front air bag will be deactivated in this case.

Have the system checked as soon as possible by qualified technicians. Contact an authorized Mercedes-Benz Light Truck Center.

Only have the seat repaired or replaced by an authorized Mercedes-Benz Light Truck Center.



In order to ensure proper operation of the air bag system and OCS:

- Do not place more than 4.4 lb (2 kg) into the parcel net on the back of the front passenger seat. Otherwise, the OCS may not be able to properly approximate the occupant weight category.
- Do not place objects under and/or around the front passenger seat.

- Do not hang anything from or attach any items to the seats.
- Do not stuff objects such as books between the middle console and the front passenger seat.
- Do not move the front passenger seat backwards against stiff objects.
- Sit properly belted in a position that is as upright as possible with your back against the seat backrest.
- While seated, an occupant should not position him/herself in such a way as to cause the occupant's weight to be lifted from the seat bottom as this may result in the OCS being unable to correctly approximate the occupant's weight category.
- Read and observe all warnings in this chapter.

## Occupant safety

### Self-test Occupant Classification System

After turning the SmartKey in the starter switch to position **1** or **2** or pressing the KEYLESS-GO\* start/stop button once or twice, the  **PASS AIR BAG OFF** indicator lamp (▷ page 85) located in the center console illuminates. If an adult occupant is properly sitting on the front passenger seat and the system senses the occupant as being an adult, the  **PASS AIR BAG OFF** indicator lamp will illuminate and go out after approximately 6 seconds.

If the seat is not occupied and the system senses the front passenger seat as being empty, the  **PASS AIR BAG OFF** indicator lamp will illuminate and not go out.

#### Warning!



If the  **PASS AIR BAG OFF** indicator lamp should not illuminate, the system is not functioning. You must see an authorized Mercedes-Benz Light Truck Center before seating any child on the front passenger seat.

For more information, see the “Practical hints” section (▷ page 447).

#### Warning!



Never place anything between seat cushion and child seat (e.g. pillow), since it reduces the effectiveness of the Occupant Classification System. The bottom of the child seat must make full contact with the passenger seat cushion. An incorrectly mounted child seat could cause injuries to the child in case of an accident, instead of increasing protection for the child.

Follow the manufacturer’s instructions for installation of child seats.

### Seat belts

The use of seat belts and infant and child restraint system is required by law in all 50 states, the District of Columbia, the U.S. territories and all Canadian provinces.

Even where this is not the case, all vehicle occupants should have their seat belts fastened whenever the vehicle is in motion.

For more information, see “Fastening the seat belts” (▷ page 53).

**i** For information on infants and children traveling with you in the vehicle and restraint systems for infants and children, see “Children in the vehicle” (▷ page 91).

**Warning!**

Always fasten your seat belt before driving off. Always make sure your passengers are properly restrained.

Failure to wear and properly fasten and position your seat belt greatly increases your risk of injuries and their likely severity in an accident. You and your passengers should always wear seat belts.

If you are ever in an accident, your injuries can be considerably more severe without your seat belt properly buckled. Without your seat belt buckled, you are much more likely to hit the interior of the vehicle or be ejected from it. You can be seriously injured or killed.

In the same crash, the possibility of injury or death is lessened if you are properly wearing your seat belt. Air bags can only protect as they are designed if the occupants are properly wearing their seat belts.

**Warning!**

Never ride in a moving vehicle with the seat backrest in an excessively reclined position as this can be dangerous. You could slide under the seat belt in a collision. If you slide under it, the belt would apply force at the abdomen or neck. That could cause serious or even fatal injuries. The seat backrest and seat belt provide the best restraint when the wearer is in a position that is as upright as possible and the belt is properly positioned on the body.

**Warning!**

Never let more people ride in the vehicle than there are seat belts available. Make sure everyone riding in the vehicle is correctly restrained with a separate seat belt. Never use a seat belt for more than one person at a time.

**Warning!**

Damaged seat belts or belts that were highly stressed in an accident must be replaced and their anchoring points must also be checked.

Only use seat belts which have been approved by Mercedes-Benz.

Do not make any modifications to the seat belts. This can lead to unintended activation of the ETDs or to failure.

Do not bleach or dye seat belts as this may severely weaken them. In a crash they may not be able to provide adequate protection.

Have all work carried out only by qualified technicians. Contact an authorized Mercedes-Benz Light Truck Center.

## Occupant safety

### Warning!



#### USE SEAT BELTS PROPERLY

- Seat belts can only work when used properly. Never wear seat belts in any other way than as described in this section, as that could result in serious injuries in case of an accident.
- Each occupant should wear their seat belt at all times, because seat belts help reduce the likelihood of and potential severity of injuries in accidents, including rollovers. The integrated restraint system includes SRS (driver air bag, passenger front air bag, side impact air bags, window curtain air bags for side windows), ETD (seat belt emergency tensioning device), and front seat knee bolsters. The system is designed to enhance the protection offered to properly belted occupants in certain frontal (front air bags and ETD) and side (side impact, window curtain air bags and ETD) impacts which exceed preset deployment thresholds and in certain rollovers (window curtain air bags and ETD).

- Never wear the shoulder belt under your arm, against your neck or off your shoulder. In a frontal crash, your body would move too far forward. That would increase the chance of head and neck injuries. The belt would also apply too much force to the ribs or abdomen, which could severely injure internal organs such as your liver or spleen.
- Never wear belts over rigid or breakable objects in or on your clothing, such as eyeglasses, pens, SmartKeys, etc., as these might cause injuries.
- Position the lap belt as low as possible on your hips and not across the abdomen. If the belt is positioned across your abdomen, it could cause serious injuries in a crash.
- Never use a seat belt for more than one person at time. Do not fasten a seat belt around a person and another person or other objects.

- Belts should not be worn twisted. In a crash, you would not have the full width of the belt to distribute impact forces. The twisted belt against your body could cause injuries.
- Pregnant women should also always use a lap-shoulder belt. The lap belt portion should be positioned as low as possible on the hips to avoid any possible pressure on the abdomen.
- Never place your feet on the instrument panel, dashboard or on the seat. Always keep both feet on the floor in front of the seat.
- When using a seat belt to secure infant or toddler restraints or children in booster seats, always follow the child seat manufacturer's instructions.

### Enhanced seat belt reminder system

When the engine is started, the seat belt telltale  will always illuminate for 6 seconds to remind you and your passengers to fasten your seat belts.

If the driver's seat belt is not fastened when the engine is started, an additional warning chime will also sound for a maximum of 6 seconds or until the driver's seat belt is fastened.

If after these 6 seconds the driver's or the front passenger's seat belt (with the front passenger seat occupied) is not fastened with front doors closed,

- the seat belt telltale  remains illuminated for as long as either the driver's or front passenger's seat belt is not fastened

- and if the vehicle speed once exceeds 15 mph (25 km/h), the seat belt telltale  starts flashing and a warning chime sounds with increasing intensity for a maximum of 60 seconds or until the driver's and the front passenger's seat belt are fastened

If the driver's or the front passenger's seat belt remains unfastened after 60 seconds, the warning chime stops sounding, the seat belt telltale  stops flashing but continues to be illuminated.

The seat belt telltale  will only go out if both the driver's and the front passenger's seat belt (with the front passenger seat occupied) are fastened, or the vehicle is standing still and a front door is opened.

For more information, see "Practical hints" (▷ page 442).

### Emergency Tensioning Device (ETD), seat belt force limiter

The seat belts for the front seats and second-row outer seats are equipped with emergency tensioning devices and seat belt force limiters. The seat belts for the third-row seats are equipped with emergency tensioning devices.

The ETD is designed to activate in the following cases:

- in frontal or rear-end impacts exceeding the system deployment threshold
- in certain vehicle rollovers
- if the restraint systems are operational and functioning correctly, see  indicator lamp (▷ page 446)

 *The ETDs for the front seats will only activate if the respective front seat belt is fastened (latch plate properly inserted into buckle).*

*The ETDs for the rear outer seats (second-row seats) or rear seats (third-row seats) will activate with or without the respective seat belt fastened.*

### Occupant safety

In an impact, emergency tensioning devices remove slack from the belts in such a way that the seat belts fit more snugly against the body. Belt force limiters, when activated, are employed to help reduce the peak force exerted by the seat belts on occupants during a crash.

#### Warning!



A pyrotechnic Emergency Tensioning Device (ETD) that was activated must be replaced.

When disposing of the pyrotechnic emergency tensioning device, our safety instructions must be followed. These are available at any authorized Mercedes-Benz Light Truck Center.

### Active head restraint

The active head restraints are intended to offer the driver and front passenger increased protection from whiplash type injuries. In the event of a rear-end collision, the active head restraints on the driver's and front passenger's seats are designed to move forward in the direction of travel, providing the head with increased support earlier on in the collision sequence. The active head restraints move forward whether the seat is occupied or not.

#### Warning!



Only use seat or head restraint covers which have been tested and approved by Mercedes-Benz for your vehicle model. Using other seat or head restraint covers may interfere with or prevent the activation of the active head restraint. Contact an authorized Mercedes-Benz Light Truck Center for availability.

Do not attach any objects (e.g. hangers) to the head restraints posts. Otherwise, the active head restraints may not be able to function properly or offer the intended degree of protection in the event of an accident.

#### Warning!



For your protection, drive only with properly positioned head restraints.

Adjust head restraint so that it is as close to the head as possible and the center of the head restraint supports the back of the head at eye level. This will reduce the potential for injury to the head and neck in the event of an accident or similar situation.

You cannot remove the active head restraint on the driver's and front passenger's seats.

For removal of the active head restraints we recommend that you contact an authorized Mercedes-Benz Light Truck Center.

For information on head restraint adjustment, see "Seats" (▷ page 45).

For information on resetting the activated active head restraints, see "Resetting activated head restraints" (▷ page 499).

### Rear head restraints

#### Warning!



Do not drive the vehicle without the seat head restraints installed when the rear seats are occupied. Head restraints are intended to help reduce injuries during an accident.

With a rear seat occupied, make sure to move the respective head restraint up from the lowest non-use position and have the occupant adjust the head restraint properly.

For your protection, drive only with properly positioned head restraints.

Adjust the head restraint in such a way that it is as close to the head as possible and the head restraint supports the back of the head at eye level. This will reduce the potential for injury to the head and neck in the event of an accident or similar situation.

### Children in the vehicle

If an infant or child is traveling with you in the vehicle:

- ▶ Secure the child using an infant or child restraint appropriate to the age and size of the child.
- ▶ Make sure the infant or child is properly secured at all times while the vehicle is in motion.

#### Warning!



Do not leave children unattended in the vehicle, even if they are secured in a child restraint system. The children could

- injure themselves on parts of the vehicle
- be seriously or fatally injured through excessive exposure to extreme heat or cold





### Occupant safety



Do not expose the child restraint system to direct sunlight. The child restraint system's metal parts, for example, could become very hot, and the child could be burned on these parts.

If children open a door, they could

- injure other persons
- get out of the car and injure themselves or be injured by following traffic

Do not carry heavy or hard objects in the passenger or cargo compartment unless they are firmly secured in place. For more information, see “Loading” (▷ page 295) and “Useful features” (▷ page 315).

Unsecured or improperly positioned cargo increases a child's risk of injury in the event of

- strong braking maneuvers
- sudden changes of direction
- an accident

### Infant and child restraint systems

We recommend all infants and children be properly restrained at all times while the vehicle is in motion.

All lap-shoulder belts except the driver's seat belt have special seat belt retractors for secure fastening of child restraints.

To fasten a child restraint, follow child restraint instructions for mounting. Then pull the shoulder belt out completely and let it retract. During seat belt retraction, a ratcheting sound can be heard to indicate that the special seat belt retractor is activated. The belt is now locked. Push down on child restraint to take up any slack.

To deactivate, release seat belt buckle and let seat belt retract completely. To deactivate the special seat belt retractor for the front passenger seat, the front passenger seat must be in the most backward position. The seat belt can again be used in the usual manner.

### Warning!



Never release the seat belt buckle while the vehicle is in motion, since the special seat belt retractor will be deactivated.

**i** For information on child seats with mounting fittings for tether anchorages, see “Installation of infant and child restraint system” (▷ page 96).

For information on LATCH-type child seat mounts, see “Child seat anchors – LATCH type” (▷ page 95).

The use of infant or child restraints is required by law in all 50 states, the District of Columbia, the U.S. territories and all Canadian provinces.

Infants and small children should be seated in an appropriate infant or child restraint system properly secured in accordance with the manufacturer's instructions for the child restraint, that complies with U.S. Federal Motor Vehicle Safety Standards 213 and 225 and Canadian Motor Vehicle Safety Standards 213 and 210.2.

A statement by the child restraint manufacturer of compliance with these standards can be found on the instruction label on the restraint and in the instruction manual provided with the restraint.

When using any infant or child restraint system, make sure to carefully read and follow all manufacturer's instructions for installation and use.

Please read and observe warning labels affixed to the inside of the vehicle and to infant or child restraints.

**Warning!**

According to accident statistics, children are safer when properly restrained in the rear seating positions than in the front seating position. Thus, we strongly recommend that children be placed in the rear seats whenever possible. Regardless of seating position, children 12 years old and under must be seated and properly secured in an appropriate infant or child restraint recommended for the size and weight of the child.

The infant or child restraint must be properly secured with the vehicle's seat belt, the seat belt and top tether strap, or lower anchors and top tether strap, fully in accordance with the child seat manufacturer's instructions.

Always sit as upright as possible, properly use the seat belts and use an appropriately sized infant restraint, toddler restraint, or booster seat recommended for the size and weight of the child.

Children can be killed or seriously injured by an inflating air bag. Note the following important information when circumstances require you to place a child in the front passenger seat:





- Your vehicle is equipped with air bag technology designed to turn off the front passenger front air bag in your vehicle when the OCS senses the weight of a typical 12-month-old child or less along with the weight of a standard appropriate child restraint on the front passenger seat.



### Occupant safety



- A child in a rear-facing child restraint on the front passenger seat will be seriously injured or even killed if the front passenger front air bag inflates in a collision which could occur under some circumstances, even with the air bag technology installed in your vehicle. The only means to completely eliminate this risk is to never place a child in a rear-facing child restraint in the front seat. We therefore strongly recommend that you always place a child in a rear-facing child restraint in the back seat.

- If you must install a rear-facing child restraint on the front passenger seat because circumstances require you to do so, make sure that the  **PASS AIR BAG OFF** indicator lamp is illuminated, indicating that the front passenger front air bag is deactivated. Should the  **PASS AIR BAG OFF** indicator lamp not illuminate or go out while the restraint is installed, please check installation. Periodically check the  **PASS AIR BAG OFF** indicator lamp while driving to make sure the lamp is illuminated. If the  **PASS AIR BAG OFF** indicator lamp goes out or remains out, do not transport a child on the front passenger seat until the system has been repaired. A child in a rear-facing child restraint on the front passenger seat will be seriously injured or even killed if the front passenger front air bag inflates.

- If you have to place a child in a forward-facing child restraint on the front passenger seat, move the seat as far back as possible, use the proper child restraint recommended for the age, size and weight of the child, and secure child restraint with the vehicle's seat belt according to the child seat manufacturer's instructions. For children larger than the typical 12-month-old child, the front passenger front air bag may or may not be activated (▷ page 82).

#### Warning!



Infants and small children should never share a seat belt with another occupant. During an accident, they could be crushed between the occupant and seat belt.

A child's risk of serious or fatal injuries is significantly increased if the child restraints are not properly secured in the vehicle and/or the child is not properly secured in the child restraint.

Children too big for a toddler restraint must ride in seats using regular seat belts. Position shoulder belt across chest and shoulder, not face or neck. A booster seat may be necessary to achieve proper belt positioning for children from 41 lb until they reach a height where a lap/shoulder belt fits properly without a booster.

When the child restraint is not in use, remove it from the vehicle or secure it with the seat belt to prevent the child restraint from becoming a projectile in the event of an accident.

Do not leave children unattended in the vehicle, even if the children are secured in a child restraint system.

A child's unsupervised access to a vehicle could result in an accident and/or serious personal injury.

### Child seat anchors – LATCH type

This vehicle is equipped with two LATCH (Lower Anchors and Tethers for Children) type anchors (at each of the outer rear seats) for the installation of a LATCH child seat with matching mounting fittings.

#### Warning!



Children too big for a toddler restraint must ride in seats using regular seat belts. Position shoulder belt across chest and shoulder, not face or neck.

A booster seat may be necessary to achieve proper belt positioning for children over 41 lb until they reach a height where a lap/shoulder belt fits properly without a booster.

Install child seat according to manufacturer's instructions.

The child seat must be firmly attached to the right and left side anchors ② (▷ page 96).

An incorrectly mounted child seat may come loose during an accident which could result in serious injury or death to the child.

Damaged or impact damaged child seats or child seat mounting fittings must be replaced.

Do not leave children unattended in the vehicle, even if the children are secured in a child restraint system.

## Occupant safety

The LATCH anchors are blended with covers.



### Example, second-row seats

- ① Anchorage ring covers
- ▶ Remove anchorage ring cover ① from the seat on which a child seat is to be installed.



### Example, second-row seats

- ② Anchors
- ▶ Install a LATCH type child seat according to the manufacturer's instructions.
- ❗ *Make sure the seat belt for the center seat can operate freely with a child seat installed.*
- i *Only the rear outer seats can be used for installing a LATCH type child seat.*
- For installing a Non-LATCH type child seat use the vehicle's seat belt system. Install child seat according to the manufacturer's instructions.*

## Installation of infant and child restraint system

This vehicle is equipped with tether anchorages for a top tether strap at the second-row seat backrest. For installing an infant and child restraint system at the third-row seats, use the cargo tie-down rings in the cargo compartment (▷ page 303).

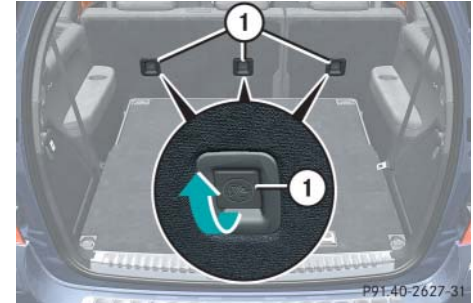

- ① Anchorage ring cover
- ▶ Remove anchorage ring cover ① from seat backrest of the seat on which a child seat is to be installed.

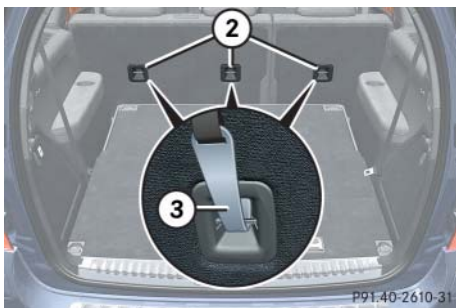

- ② Anchorage ring
- ③ Hook

**i** For safety, make sure hook ③ has attached to anchorage ring ② beyond the safety catch, as illustrated.

- ▶ Move the respective head restraint to its uppermost position (▷ page 135).

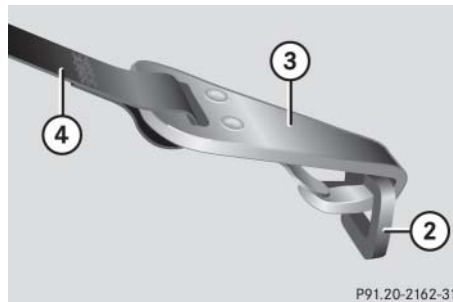

- ② Anchorage ring
  - ③ Hook
  - ④ Top tether strap
- ▶ Guide top tether strap ④ between head restraint and top of seat backrest.

- ▶ Securely fasten hook ③, which is part of the tether strap ④, to anchorage ring ②.

Make sure

- the top tether strap is not twisted
- the head restraint is installed and positioned such that the top tether strap can pass freely between the head restraint and top of seat backrest
- top tether strap is positioned between the seat backrest and the cargo compartment cover blind (if installed)
- the top tether strap is positioned between the seat backrest and the cargo net\* (if installed)



### Occupant safety



#### Warning!



After installing top tether straps, make sure that the seat backrests are in an upright position and are properly locked. Check for secure locking by pushing and pulling on the seat backrests. If a seat backrest is not properly locked, the seat backrest could fold. The child seat would no longer be properly supported or positioned to provide its intended benefit.

- ▶ Lower the head restraint if necessary (▷ page 135).

Make sure the top tether strap can pass freely between the head restraint and top of seat backrest.

- ▶ Install the child restraint system and tighten the top tether strap according to the child restraint manufacturer's instructions.

### Blocking of rear door window operation

With the override switch you can disable the rear side window switches in the rear door panels.

#### Warning!



Activate the override switch when children are riding in the back seats of the vehicle. The children could otherwise injure themselves, e.g. by becoming trapped in the window opening.

When leaving the vehicle, always remove the SmartKey or SmartKey with KEYLESS-GO\* from the starter switch, take it with you, and lock the vehicle. Do not leave children unattended in the vehicle, or with access to an unlocked vehicle. A child's unsupervised access to a vehicle could result in an accident and/or serious personal injury.

The override switch is located on the driver's door control panel.

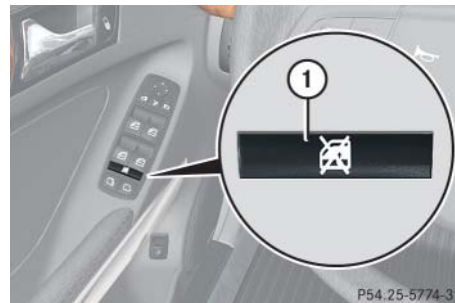

① Override switch

For more information on power windows, see "Power windows" (▷ page 246).

## Disabling

- ▶ Press override switch ① until it engages.

The switch engages in the recessed position.

The rear door windows can no longer be operated using the switches located in the rear doors.

**i** *Operating the rear door windows using the switches located on the door control panel of the driver's door is still possible.*

## Enabling

- ▶ Press override switch ① once more.

The switch disengages from its recessed position back to its original position.

The rear door windows can again be operated using the switches located in the rear doors.



## Panic alarm



① **PANIC** button

**i** USA only:

*This device complies with Part 15 of the FCC Rules. Operation is subject to the following two conditions:*

- (1) This device may not cause harmful interference, and*
- (2) this device must accept any interference received, including interference that may cause undesired operation.*

*Any unauthorized modification to this device could void the user's authority to operate the equipment.*

**i** Canada only:

*This device complies with RSS-210 of Industry Canada. Operation is subject to the following two conditions:*

- (1) This device may not cause interference, and*
- (2) this device must accept any interference received, including interference that may cause undesired operation of the device.*

*Any unauthorized modification to this device could void the user's authority to operate the equipment.*

### Activating

- ▶ Press and hold button ① for at least 1 second.

An audible alarm and flashing exterior lamps will operate briefly.

### Deactivating

- ▶ Press button ① again.

or

- ▶ Insert the SmartKey or the SmartKey with KEYLESS-GO\* in the starter switch.

or

- ▶ Press the KEYLESS-GO\* start/stop button (▷ page 43).

The SmartKey with KEYLESS-GO\* must be in the vehicle.

## ▼ Driving safety systems

In this section you will find information on the following driving safety systems:

- ABS (Antilock Brake System)
- BAS (Brake Assist System)
- ESP® (Electronic Stability Program)
- EBP (Electronic Brake Proportioning)
- 4-ETS (Electronic Traction System)

### Warning!



The following factors increase the risk of accidents:

- Excessive speed, especially in turns
- Wet and slippery road surfaces
- Following another vehicle too closely

The driving safety systems described in this section cannot reduce these risks or prevent the natural laws of physics from acting on the vehicle.

Always adapt your driving style to the prevailing road and weather conditions and keep a safe distance to other road users and objects in the street.

**i** *In winter operation, the maximum effectiveness of the ABS, the BAS, the ESP®, the EBP, and the 4-ETS is only achieved with winter tires (▷ page 420) or snow chains as required.*

## ABS

### Warning!



Do not pump the brake pedal. Use firm, steady brake pedal pressure instead. Pumping the brake pedal defeats the purpose of the ABS and significantly reduces braking effectiveness.

The Antilock Brake System (ABS) regulates the brake pressure so that the wheels do not lock during braking. This allows you to maintain the ability to steer your vehicle.

The ABS is functional above a speed of approximately 5 mph (8 km/h) independent of road surface conditions.

On slippery road surfaces, the ABS will respond even to light brake pressure.

The  indicator lamp in the instrument cluster (▷ page 26) comes on when you switch on the ignition. It goes out when the engine is running.

## Driving safety systems

### Braking

At the instant one of the wheels is about to lock up, a slight pulsation can be felt in the brake pedal, indicating that the ABS is in the regulating mode.

- ▶ Keep firm and steady pressure on the brake pedal while experiencing the pulsation.

Continuous, steady brake pedal pressure yields the advantages provided by the ABS, namely braking power and ability to steer the vehicle.

The pulsating brake pedal can be an indication of hazardous road conditions and functions as a reminder to take extra care while driving.

### Emergency brake maneuver

- ▶ Keep continuous full pressure on the brake pedal.

#### Warning!



When the ABS is malfunctioning, the BAS, the ESP<sup>®</sup>, and the 4-ETS are also switched off. The basic driving and braking functions are still available.

When the ABS is malfunctioning, the wheels may lock during hard braking, reducing steering capability and extending the braking distance.

#### Warning!



The ABS cannot prevent the natural laws of physics from acting on the vehicle, nor can it increase braking or steering efficiency beyond that afforded by the condition of the vehicle brakes and tires or the traction afforded. The ABS cannot prevent accidents, including those resulting from

excessive speed in turns, following another vehicle too closely, or hydroplaning. Only a safe, attentive, and skillful driver can prevent accidents. The capabilities of an ABS equipped vehicle must never be exploited in a reckless or dangerous manner which could jeopardize the user's safety or the safety of others.

### Off-road – ABS

With the off-road driving program switched on (▷ page 277), or with the transmission in LOW RANGE\* mode (▷ page 201), the ABS designed for off-road use is automatically activated.

When applying the brakes at speeds below approximately 18 mph (30 km/h), the front wheels are locked cyclically to shorten the braking distance (dig-in effect). This affects steering the vehicle.

For more information, see “Practical hints” (▷ page 435).

## BAS

The Brake Assist System (BAS) operates in emergency situations. If you apply the brakes very quickly, the BAS automatically provides full brake boost, thereby potentially reducing braking distance.

- ▶ Apply continuous full braking pressure until the emergency braking situation is over.

The ABS will prevent the wheels from locking.

When you release the brake pedal, the brakes function again as normal. The BAS is then deactivated.

### Warning!



If the BAS is malfunctioning, the brake system is still functioning, but without the additional brake boost available that BAS would normally provide in an emergency braking maneuver. Therefore, the braking distance may increase.

### Warning!





The BAS cannot prevent the natural laws of physics from acting on the vehicle, nor can it increase braking efficiency beyond that afforded by the condition of the vehicle brakes and tires or the traction afforded. The BAS cannot prevent accidents, including those resulting from excessive speed in turns, following another vehicle too closely, or hydroplaning. Only a safe, attentive, and skillful driver can prevent accidents. The capabilities of a BAS equipped vehicle must never be exploited in a reckless or dangerous manner which could jeopardize the user's safety or the safety of others.

## ESP®

The Electronic Stability Program (ESP®) is operational as soon as the engine is running. It monitors the vehicle's traction (force of adhesive friction between the tires and the road surface) and handling.

The ESP® recognizes when a wheel is spinning or if the vehicle starts to skid. By applying brakes to the appropriate wheel and by limiting engine output, the ESP® works to stabilize the vehicle. The ESP® is especially useful while driving off and on wet or slippery road surfaces. The ESP® also helps stabilize the vehicle during braking and steering maneuvers.

The ESP® warning lamp  in the instrument cluster (▷ page 26) flashes when the ESP® is engaged.

The ESP® warning lamp  in the instrument cluster comes on when you switch on the ignition. It goes out when the engine is running.

## Driving safety systems

### Warning!



Never switch off the ESP<sup>®</sup> when you see the ESP<sup>®</sup> warning lamp  flashing in the instrument cluster. In this case, proceed as follows:

- While driving off, apply as little throttle as possible.
- While driving, ease up on the accelerator.
- Adapt your speed and driving style to the prevailing road conditions.

Failure to observe these guidelines could cause the vehicle to skid.

The ESP<sup>®</sup> cannot prevent accidents resulting from excessive speed.

### Warning!



The ESP<sup>®</sup> cannot prevent the natural laws of physics from acting on the vehicle, nor can it increase the traction afforded. The ESP<sup>®</sup> cannot prevent accidents, including those resulting from excessive speed in turns, following another vehicle too closely, or hydroplaning. Only a safe, attentive, and skillful driver can prevent accidents. The capabilities of an ESP<sup>®</sup> equipped vehicle must never be exploited in a reckless or dangerous manner which could jeopardize the user's safety or the safety of others.

**!** *Operational or performance test must only be conducted on a two-axle dynamometer. If such tests are necessary, contact an authorized Mercedes-Benz Light Truck Center. You could otherwise seriously damage the brake system or the transfer case which is not covered by the Mercedes-Benz Limited Warranty.*

**!** *Because the ESP<sup>®</sup> operates automatically, the engine and ignition must be shut off (SmartKey in starter switch position **0** or **1** or KEYLESS-GO\* start/stop button in position **0** or **1**) when testing the parking brake on a brake test dynamometer and such testing should be no longer than 10 seconds.*

*Active braking action through the ESP<sup>®</sup> may otherwise seriously damage the brake system which is not covered by the Mercedes-Benz Limited Warranty.*

**i** *The ESP<sup>®</sup> will only function properly if you use wheels of the recommended tire size (▷ page 555).*

For more information, see the “Practical hints” section (▷ page 441) and (▷ page 457).

### Switching off the ESP®

#### Warning!



The ESP® should not be switched off during normal driving other than in the circumstances described below. Disabling of the system will reduce vehicle stability in standard driving maneuvers.

Do not switch off the ESP® when a spare wheel is mounted.

To improve the vehicle's traction, switch off the ESP® in driving situations where it would be advantageous to have the drive wheels spin and thus cut into surfaces for better grip such as:

- when driving with snow chains
- in deep snow
- in sand or gravel

#### Warning!



Switch on the ESP® immediately if the aforementioned circumstances do not apply anymore. Otherwise the ESP® will not stabilize the vehicle when it is starting to skid or a wheel is spinning.

#### When you switch off the ESP®

- the ESP® does not stabilize the vehicle
- the engine output is not limited, which allows the drive wheels to spin and thus cut into surfaces for better grip
- the 4-ETS will still apply the brake to a spinning wheel
- the ESP® continues to operate when you are braking
- you cannot activate the cruise control or the DISTRONIC\* system
- the cruise control or the DISTRONIC\* system switch off if currently activated

**i** When the ESP® is switched off and one or more drive wheels are spinning, the ESP® warning lamp  in the instrument cluster flashes. However, the ESP® will then not stabilize the vehicle.

The ESP® switch is located on the upper part of the center console.



#### ① ESP® switch

- ▶ With the engine running, press ESP® switch ①.

The ESP® warning lamp  in the instrument cluster comes on.

The ESP® is deactivated.

## Driving safety systems

### Warning!



When the ESP® warning lamp  is illuminated continuously, the ESP® is switched off or is not operational due to a malfunction.

Adapt your speed and driving to the prevailing road conditions and to the non-operating status of the ESP®.

**!** *Avoid spinning of a drive wheel for an extended period of time with the ESP® switched off. This may cause serious damage to the drivetrain which is not covered by the Mercedes-Benz Limited Warranty.*

### Switching on the ESP®

- ▶ Press ESP® switch .

The ESP® warning lamp  in the instrument cluster goes out.

You are now again in normal driving mode.

For more information, see “Practical hints” (▷ page 435).

### Off-road – ESP®

With the off-road driving program switched on (▷ page 277), or with the transmission in LOW RANGE\* mode (▷ page 201), the ESP® designed for off-road use is automatically activated. At speeds below 27 mph (45 km/h), the ESP® assists in over-/understeering, thus improving vehicle traction.

### ESP® Trailer Stabilization

If the trailer you are towing should begin to sway, the rig can only be stabilized by immediately applying the brakes hard. Steering during this maneuver will not help to stabilize the rig.

ESP® will assist you in such situations. ESP® recognizes when the trailer starts swaying and will apply the brakes to reduce the vehicle speed to a non-critical speed that allows the vehicle-trailer combination to stabilize.

The ESP® Trailer Stabilization is functional at vehicle speeds above approximately 40 mph (65 km/h) when the ESP® is switched on.

### Warning



The system will not be able to assist when the trailer jackknifes

- on wet or icy roads
- on roads with slippery surface
- in sand or gravel

Trailers with a high center of gravity may tip over before the system recognizes swaying of the trailer.

**i** *If the ESP® has switched off due to a malfunction, ESP® cannot stabilize the rig.*

## EBP

The EBP enhances braking effectiveness by allowing the rear brakes to supply a greater proportion of the braking effort without a loss of vehicle stability.

### Warning!





If the EBP is malfunctioning, the brake system is still functioning. However, the rear wheels may lock during hard braking, causing you to lose control over the vehicle and possibly causing an accident. Adjust your driving style to the non-operating status of the EBP.

For more information, see the “Practical hints” section (▷ page 438) and (▷ page 468).

## 4-ETS

The 4-Electronic Traction System (4-ETS) improves the vehicle’s ability to utilize available traction, especially under slippery road conditions. The brakes are applied to the spinning wheel and power is transferred to the wheel(s) with traction.

The ESP® warning lamp  in the instrument cluster, starts to flash at any vehicle speed, as soon as a tire loses traction and the wheel begins to spin.

 *If conditions require, switch on off-road driving program (▷ page 277) or LOW RANGE\* mode (▷ page 201).*

### Warning!



When you see ESP® warning lamp  flashing in the instrument cluster, then proceed as follows:

- While driving off, apply as little throttle as possible.
- While driving, ease up on the accelerator.
- Adapt your speed and driving style to the prevailing road conditions.

Failure to observe these guidelines could cause the vehicle to skid.

The 4-ETS cannot prevent accidents resulting from excessive speed.



### Driving safety systems

**!** *Operational or performance test must only be conducted on a two-axle dynamometer. If such tests are necessary, contact an authorized Mercedes-Benz Light Truck Center. You could otherwise seriously damage the brake system or the transfer case which is not covered by the Mercedes-Benz Limited Warranty.*

**!** *Because the ESP<sup>®</sup> operates automatically, the engine and ignition must be shut off (SmartKey in starter switch position **0** or **1** or KEYLESS-GO\* start/stop button in position **0** or **1**) when testing the parking brake on a brake test dynamometer and such testing should be no longer than 10 seconds.*

*Active braking action through the ESP<sup>®</sup> may otherwise seriously damage the brake system which is not covered by the Mercedes-Benz Limited Warranty.*

**i** *If the yellow ESP<sup>®</sup> warning lamp  comes on while driving, the 4-ETS is being switched off temporarily to prevent overheating of the drive wheel brakes. In addition, the message ESP Unavailable See Operator's Manual appears in the multifunction display.*

For more information, see the “Practical hints” section (▷ page 436) and (▷ page 449).

#### Off-road - 4-ETS

With the off-road driving program switched on (▷ page 277), or with the transmission in LOW RANGE\* mode (▷ page 201), the 4-ETS designed for off-road use is automatically activated.

## ▼ Anti-theft systems

### Immobilizer

---

The immobilizer prevents unauthorized persons from starting your vehicle.

### Activating

#### *With the SmartKey*

- ▶ Remove the SmartKey from the starter switch.

#### *With KEYLESS-GO\**

- ▶ Press the KEYLESS-GO start/stop button (▷ page 43) on the starter switch once.

The engine is turned off.

- ▶ Open the driver's door.

### Deactivating

#### *With the SmartKey*

- ▶ Turn the SmartKey in the starter switch to position **2** (▷ page 41).

#### *With KEYLESS-GO\**

- ▶ Switch on the ignition (▷ page 42).

**i** *Starting the engine will also deactivate the immobilizer.*

*In case the engine cannot be started (yet the vehicle's battery is charged), the system is not operational. Contact an authorized Mercedes-Benz Light Truck Center or call 1-800-FOR-MERCedes (in the USA), or 1-800-387-0100 (in Canada).*

### Anti-theft alarm system

---

Once the alarm system has been armed, a visual and audible alarm is triggered when someone opens

- a door
- the tailgate
- the hood

The alarm will stay on, even if the activating element (a door, for example) is immediately closed.

The alarm system will also be triggered when

- the vehicle is opened with the mechanical key, see "Unlocking the vehicle" (▷ page 496)
- a door is opened from the inside, see "Opening the doors from the inside" (▷ page 120)

**i** *If the alarm stays on for more than 30 seconds, a call to the Response Center is initiated automatically by the Tele Aid system (▷ page 331) provided that the Tele Aid service was subscribed to and properly activated, and that necessary cellular service and GPS coverage are available.*

## Anti-theft systems

### Arming the alarm system

The alarm system indicator lamp is located to the lower left of the hazard warning flasher.



① Alarm system indicator lamp

- ▶ Lock the vehicle with the SmartKey or with KEYLESS-GO\* (▷ page 70).

The turn signal lamps flash three times to indicate that the vehicle is locked.

The alarm system is armed within approximately 10 seconds. Alarm system indicator lamp ① flashes.

**i** If the turn signal lamps do not flash three times, one of the following elements may not be properly closed:

- a door
- the tailgate

Close the respective element and lock the vehicle again.

### Disarming the alarm system

- ▶ Unlock the vehicle with the SmartKey or with KEYLESS-GO\* (▷ page 40).

The turn signal lamps flash once to indicate that the alarm system is disarmed. Indicator lamp ① goes out.

**i** The alarm system will rearm automatically again after approximately 40 seconds if neither a door nor the tailgate is opened.



### Canceling the alarm

To cancel the alarm:

#### With the SmartKey

- ▶ Insert the SmartKey in the starter switch.

or

- ▶ Press the  or  button on the SmartKey.

#### With KEYLESS-GO\*

- ▶ Grasp an outside door handle.

The SmartKey with KEYLESS-GO must be within 3 ft (1 m) of the vehicle.

or

- ▶ Press the KEYLESS-GO start/stop button (▷ page 43).

The SmartKey with KEYLESS-GO must be inside the vehicle.

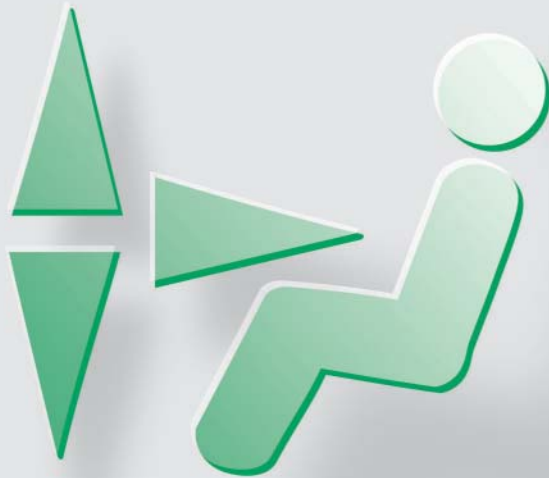

**Locking and unlocking**

**Seats**

**Memory function\***

**Lighting**

**Instrument cluster**

**Control system**

**Automatic transmission**

**Transfer case**

**Differential locks\***

**Good visibility**

**Climate control**

**3-zone automatic climate control\***

**Power windows**

**Power tilt/sliding sunroof\***

**Driving systems**

**Loading**

**Useful features**

### Locking and unlocking

In the “Controls in detail” section you will find detailed information on how to operate the equipment installed in your vehicle. If you are already familiar with the basic functions of your vehicle, this section will be of particular interest to you.

To quickly familiarize yourself with the basic functions of the vehicle, refer to the “Getting started” section of this manual. The corresponding page numbers are given at the beginning of each segment.

For more information on locking and unlocking, see the “Getting started” section (▷ page 40) and (▷ page 70).

#### SmartKey

Your vehicle comes supplied with two SmartKeys, each with remote control and a removable mechanical key.







The SmartKey provides an extended operating range. To prevent theft, however, it is advisable to only unlock the vehicle when you are in close proximity to it.

The SmartKey centrally locks and unlocks:

- the doors
- the tailgate
- the fuel filler flap



#### SmartKey with remote control

- ①  Lock button
- ②  Unlock button\* for tailgate
- ③  Locking tab for mechanical key
- ④  Unlock button
- ⑤  Battery check lamp
- ⑥  PANIC Panic button (▷ page 100)

**Warning!**

When leaving the vehicle, always remove the SmartKey from the starter switch, take it with you and lock the vehicle. Do not leave children unattended in the vehicle, or with access to an unlocked vehicle. It is possible for children to open a locked door from the inside, which could result in an accident and/or serious personal injury.

**!** To prevent possible malfunction, avoid exposing the SmartKey to high levels of electromagnetic radiation.

**i** USA only:  
This device complies with Part 15 of the FCC Rules. Operation is subject to the following two conditions:

- (1) This device may not cause harmful interference, and
- (2) this device must accept any interference received, including interference that may cause undesired operation.

Any unauthorized modification to this device could void the user's authority to operate the equipment.

**i** Canada only:  
This device complies with RSS-210 of Industry Canada. Operation is subject to the following two conditions:

- (1) This device may not cause interference, and
- (2) this device must accept any interference received, including interference that may cause undesired operation of the device.

Any unauthorized modification to this device could void the user's authority to operate the equipment.

**i** You can also open and close

- the door windows
- the hinged quarter windows\*
- the tilt/sliding sunroof\*

using the SmartKey, see "Summer opening feature" (▷ page 249) and see "Convenience closing feature" (▷ page 250).

**!** If you cannot lock or unlock the vehicle with the SmartKey, the batteries in the SmartKey are discharged, the SmartKey is malfunctioning, or the vehicle battery is drained.

- Check the batteries in the SmartKey and replace them if necessary (▷ page 502).
- Use the mechanical key to unlock the driver's door (▷ page 496).
- Lock the vehicle as described in the "Practical hints" section (▷ page 497).
- Have the vehicle battery and the vehicle battery connections checked (▷ page 528).

If the SmartKey is malfunctioning, contact Roadside Assistance or an authorized Mercedes-Benz Light Truck Center.

### Locking and unlocking

#### Factory setting

#### *Global unlocking*

- ▶ Press button .

All turn signal lamps flash once. The locking knobs in the doors move up. The anti-theft alarm system is disarmed.

The vehicle will lock again automatically and rearm the anti-theft alarm system within approximately 40 seconds of unlocking if

- neither door nor tailgate is opened
- the SmartKey is not inserted in the starter switch
- the central locking switch is not activated





#### *Global locking*

- ▶ Press button .

With the tailgate and all doors closed, the turn signal lamps flash three times. The locking knobs in the doors move down. The anti-theft alarm system is armed.

#### **Selective setting**

If you frequently travel alone, you may wish to reprogram the SmartKey so that pressing button  only unlocks the driver's door and the fuel filler flap.

- ▶ Press and hold buttons  and  simultaneously for about 5 seconds until battery check lamp  ( page 112) flashes twice.

The SmartKey will then function as follows:

#### *Unlocking driver's door and fuel filler flap*

- ▶ Press button  once.

All turn signal lamps flash once. The locking knob in the driver's door moves up. The anti-theft alarm system is disarmed.

#### *Global unlocking*

- ▶ Press button  twice.



All turn signal lamps flash once. The locking knobs in the doors move up. The anti-theft alarm system is disarmed.

### Global locking

- ▶ Press button .

With the tailgate and all doors closed, the turn signal lamps flash three times. The locking knobs in the doors move down. The anti-theft alarm system is armed.

### Restoring to factory setting

- ▶ Press and hold buttons  and  simultaneously for about 5 seconds until battery check lamp  (▷ page 112) flashes twice.

### SmartKey with KEYLESS-GO\*

Vehicles equipped with KEYLESS-GO come with two SmartKeys with KEYLESS-GO, each with remote control and a removable mechanical key.

The KEYLESS-GO function is integrated into the SmartKey. On these vehicles, the validity of the SmartKey with KEYLESS-GO is checked when you grasp an outside door handle.





If the SmartKey with KEYLESS-GO is valid, your vehicle unlocks

- the doors
- the tailgate
- the fuel filler flap



P80.35-2285-31

### SmartKey with KEYLESS-GO\*

- ①  Lock button
- ②  Unlock button\* for tailgate
- ③ Locking tab for mechanical key
- ④  Unlock button
- ⑤ Battery check lamp
- ⑥  PANIC button (▷ page 100)



### Locking and unlocking

#### Warning!



When leaving the vehicle, always take the SmartKey with KEYLESS-GO\* with you and lock the vehicle. Do not leave children unattended in the vehicle, or with access to an unlocked vehicle. A child's unsupervised access to a vehicle could result in an accident and/or serious personal injury.

**!** To prevent possible malfunction, avoid exposing the SmartKey with KEYLESS-GO to high levels of electromagnetic radiation.

**i** USA only:  
This device complies with Part 15 of the FCC Rules. Operation is subject to the following two conditions:

- (1) This device may not cause harmful interference, and
- (2) this device must accept any interference received, including interference that may cause undesired operation.

Any unauthorized modification to this device could void the user's authority to operate the equipment.

**i** Canada only:  
This device complies with RSS-210 of Industry Canada. Operation is subject to the following two conditions:

- (1) This device may not cause interference, and
- (2) this device must accept any interference received, including interference that may cause undesired operation of the device.

Any unauthorized modification to this device could void the user's authority to operate the equipment.

- i** You can also open and close
- the door windows
  - the hinged quarter windows\*
  - the tilt/sliding sunroof\*

using the SmartKey with KEYLESS-GO, see "Summer opening feature" (▷ page 249) and see "Convenience closing feature" (▷ page 250).

**!** If you cannot lock or unlock the vehicle with the SmartKey with KEYLESS-GO, the batteries in the SmartKey with KEYLESS-GO are discharged, the SmartKey with KEYLESS-GO is malfunctioning or the vehicle battery is drained.

- Check the batteries in the SmartKey with KEYLESS-GO (▷ page 120) and replace them if necessary (▷ page 502).
- Use the mechanical key to unlock the driver's door (▷ page 496).
- Lock the vehicle as described in the "Practical hints" section (▷ page 497).
- Have the vehicle battery and the vehicle battery connections checked (▷ page 528).

If the SmartKey with KEYLESS-GO is malfunctioning, contact Roadside Assistance or an authorized Mercedes-Benz Light Truck Center.

**Important notes on using KEYLESS-GO\***

- You can also use the SmartKey with KEYLESS-GO like a normal SmartKey (▷ page 112).

The starter switch is located under the KEYLESS-GO button. Pull the KEYLESS-GO button out in order to access the starter switch (▷ page 43).

- You can combine KEYLESS-GO functions with normal SmartKey functions (e.g. unlocking with KEYLESS-GO and locking with the  button).
- Always carry the SmartKey with KEYLESS-GO with you.
- Never store the SmartKey with KEYLESS-GO together with:
  - electronic items such as a cellular phone or another SmartKey with KEYLESS-GO
  - metallic objects such as coins or metal foil

Doing so could impair the function of the KEYLESS-GO system.

- To lock or unlock the vehicle, the SmartKey with KEYLESS-GO must be located outside the vehicle within approximately 3 ft (1 m) of the respective door or the tailgate.
- If the vehicle has been parked for more than 72 hours, you must pull an outside door handle in order to activate the KEYLESS-GO function.
- In order to start the engine with the SmartKey with KEYLESS-GO:
  - The SmartKey with KEYLESS-GO must be located in the vehicle.
  - The KEYLESS-GO start/stop button must be inserted in the starter switch (▷ page 43).
  - The brake pedal must be firmly depressed. Do not depress the accelerator.
- If the SmartKey with KEYLESS-GO is positioned farther away from the vehicle, the system may no longer recognize the SmartKey with KEYLESS-GO. The vehicle then cannot be locked or the engine started via the KEYLESS-GO system.
- If you have started the engine with the KEYLESS-GO start/stop button (▷ page 57), you can turn it off again by
  - pressing the KEYLESS-GO start/stop button (▷ page 69)
  - inserting the SmartKey into the starter switch when the vehicle is at a standstill and the automatic transmission is in position **P** (▷ page 69)

### Locking and unlocking

- If the SmartKey with KEYLESS-GO is removed from the vehicle (e.g. if a passenger exits the vehicle with the SmartKey with KEYLESS-GO)
  - when pressing the KEYLESS-GO start/stop button or trying to lock the vehicle with the lock button on an outside door handle the message `Key Not Detected` appears in the multifunction display
  - with the engine running, the message `Key Not Detected` appears in the multifunction display while driving off.
- Remember that the engine can be started by anyone with a SmartKey with KEYLESS-GO that is left inside the vehicle.
  - Possibility 1 (One SmartKey with KEYLESS-GO in the vehicle, one SmartKey with KEYLESS-GO outside the vehicle):  
If you leave the SmartKey with KEYLESS-GO behind when exiting and locking the vehicle, no message appears in the multifunction display.
  - Possibility 2 (One SmartKey with KEYLESS-GO in the vehicle, no SmartKey with KEYLESS-GO outside the vehicle):  
When exiting and trying to lock the vehicle, the message `Key Detected In Vehicle` will appear in the multifunction display. The vehicle will not be locked.

Find the SmartKey with KEYLESS-GO or change its present location immediately (e.g. place it on the front passenger seat or insert it in shirt pocket).

### Factory setting

#### **Global unlocking**

- ▶ Grasp an outside door handle.

All turn signal lamps flash once. The locking knobs in the doors move up. The anti-theft alarm system is disarmed.

The vehicle will lock again automatically and rearm the anti-theft alarm system within approximately 40 seconds of unlocking if

- neither a door nor the tailgate is opened
- the central locking switch is not activated

**i** *The vehicle could be inadvertently unlocked if the SmartKey with KEYLESS-GO is within 3 ft (1 m) of the vehicle and*

- *an outside door handle is splashed with water*  
*or*
- *you attempt to clean an outside door handle*



**Global locking**

- ▶ Press the lock button on an outside door handle (▷ page 71).

With the tailgate and all doors closed, the turn signal lamps flash three times. The locking knobs in the doors move down. The anti-theft alarm system is armed.

**Selective setting**

If you frequently travel alone, you may wish to reprogram the SmartKey with KEYLESS-GO so when you grasp the driver's door handle only the driver's door and the fuel filler flap unlocks.

- ▶ Press and hold buttons  and  simultaneously for about 5 seconds until battery check lamp  (▷ page 115) flashes twice.

The SmartKey with KEYLESS-GO will then function as follows:

**Unlocking driver's door and fuel filler flap**

- ▶ Grasp the driver's outside door handle.

All turn signal lamps flash once. The locking knob in the driver's door moves up. The anti-theft alarm system is disarmed.

**Global unlocking**

- ▶ Grasp any outside door handle other than the driver's outside door handle.



All turn signal lamps flash once. The locking knobs in the doors move up. The anti-theft alarm system is disarmed.

**Global locking**

- ▶ Press the lock button on an outside door handle (▷ page 71).



All turn signal lamps flash three times. The locking knobs in the doors move down. The anti-theft alarm system is armed.

**Restoring to factory setting**

- ▶ Press and hold buttons  and  simultaneously for about 5 seconds until battery check lamp  (▷ page 115) flashes twice.

### Locking and unlocking

#### Checking the batteries in the SmartKey or SmartKey with KEYLESS-GO\*



- ▶ Press button  or .

The battery check lamp (▷ page 112) or (▷ page 115) comes on briefly to indicate that the SmartKey or SmartKey with KEYLESS-GO batteries are in order.

**i** If the battery check lamp does not come on briefly during check, the SmartKey or SmartKey with KEYLESS-GO batteries are discharged.

Replace the batteries (▷ page 502).

You can obtain the required batteries at any authorized Mercedes-Benz Light Truck Center.

**i** If the batteries are checked within signal range of the vehicle, pressing the button  or  will lock or unlock the vehicle accordingly.

#### Loss of the SmartKey or SmartKey with KEYLESS-GO\*

If you lose your SmartKey, SmartKey with KEYLESS-GO or mechanical key, you should do the following:

- ▶ Have the SmartKey or SmartKey with KEYLESS-GO deactivated by an authorized Mercedes-Benz Light Truck Center.
- ▶ Report the loss of the SmartKey, SmartKey with KEYLESS-GO or the mechanical key immediately to your car insurance company.
- ▶ Have the mechanical lock replaced if necessary.

Any authorized Mercedes-Benz Light Truck Center will be glad to supply you with a replacement.

#### Opening the doors from the inside

You can open a locked door from the inside. Open door only when conditions are safe to do so.

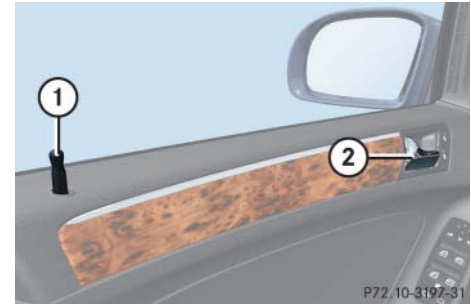



- ① Locking knob
- ② Inside door handle

**i** If the vehicle has previously been locked from the outside with the SmartKey or with KEYLESS-GO\*, opening a door from the inside will trigger the anti-theft alarm system.

To cancel the alarm, do one of the following:

With the SmartKey

- Insert the SmartKey in the starter switch.
- Press the  or  button on the SmartKey.

With KEYLESS-GO\*

- Grasp an outside door handle.
- Press the KEYLESS-GO\* start/stop button (▷ page 43).

The SmartKey with KEYLESS-GO\* must be inside the vehicle.

### Front doors

- ▶ Pull on inside door handle ② on the respective front door to open door.

If the door was locked, locking knob ① will move up.

### Rear doors

- ▶ Pull up locking knob ① on the respective rear door to unlock door.
- ▶ Pull on inside door handle ② on the respective rear door to open door.

### Tailgate/Power tailgate\*

#### Warning!



Make sure the tailgate is closed when the engine is running and while driving. Among other dangers deadly carbon monoxide (CO) gases may enter vehicle interior resulting in unconsciousness and death.

A minimum height clearance of 7.4 ft (2.25 m) is required to open the tailgate.

**!** The tailgate swings open upwards automatically. Always make sure there is sufficient overhead clearance.

### Locking and unlocking

#### Tailgate

##### Opening the tailgate from the outside

**i** Vehicles without KEYLESS-GO\*:  
The vehicle must be unlocked (▷ page 40).

The handle is located above the rear license plate recess.



- ▶ Pull on the handle.  
The tailgate opens slightly.
- ▶ Pull tailgate upwards to open.

##### Opening the tailgate from the inside

You can unlock the tailgate from the third-row seats and then open it manually.

The handle is located on the right of the tailgate's window trim.

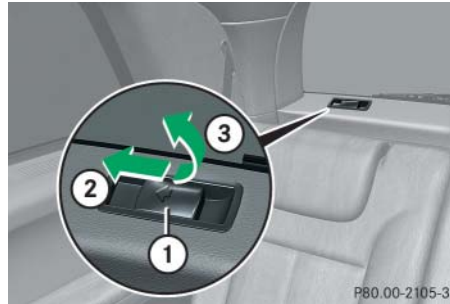

- ① Handle
- ② Push
- ③ Lift

- ▶ Push handle ① in direction of arrow ② and hold it there.

- ▶ Lift handle ① in direction of arrow ③.  
The tailgate is released and can be opened manually.

**i** If you do not open the tailgate within a few seconds, the tailgate lock will automatically engage again. Additionally, the tailgate will relock automatically, if the vehicle was locked when the tailgate was released from the inside.

If the tailgate lock does not engage automatically and, if applicable, the tailgate does not relock after a few seconds, you have to close the tailgate manually (▷ page 123).

### Closing the tailgate from the outside

#### Warning!



To prevent possible personal injury, always keep hands and fingers away from the cargo compartment opening when closing the tailgate. Be especially careful when small children are around.

When leaving the vehicle, always remove the SmartKey or SmartKey with KEYLESS-GO\* from the starter switch, take it with you, and lock the vehicle. Do not leave children unattended in the vehicle, or with access to an unlocked vehicle. A child's unsupervised access to a vehicle could result in an accident and/or serious personal injury.

**i** To prevent an inadvertent lockout, do not place the SmartKey in the cargo compartment.

Vehicles with KEYLESS-GO\*: To prevent a possible inadvertent lockout, the tailgate will open automatically if a SmartKey with KEYLESS-GO is recognized inside the vehicle.

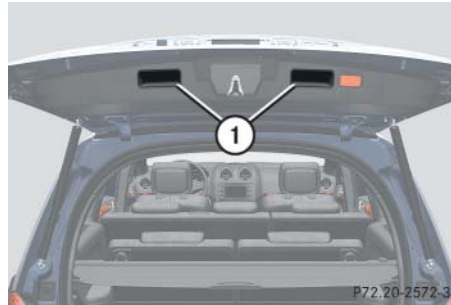

#### ① Handle

- ▶ Lower tailgate by pulling firmly on handle ①.
- ▶ Close tailgate with hands placed flat on it.

Once the tailgate touches the latch, the tailgate will pull itself shut automatically.

**i** If the vehicle was previously centrally locked with the SmartKey or KEYLESS-GO\*, the tailgate will lock automatically after closing it. The turn signals flash three times to confirm locking.

### Power tailgate\*

In vehicles with power tailgate, you can

- open and close the tailgate from the inside and the outside electrically
- limit the opening height of the tailgate
- interrupt the opening/closing procedure at any time by
  - pressing or pulling the door-mounted remote tailgate switch (▷ page 124)
  - pressing the  button on the SmartKey (▷ page 112) or SmartKey with KEYLESS-GO\* (▷ page 115)
  - pressing the tailgate closing switch (▷ page 126)
  - pressing the tailgate closing/locking switch (vehicles with KEYLESS-GO\*) (▷ page 126)

**!** The tailgate swings open upwards automatically. Always make sure there is sufficient overhead clearance.



### Locking and unlocking

#### *Opening the tailgate from the outside*

You can unlock and open the tailgate simultaneously from the outside when the vehicle is at a standstill.

- ▶ Press and hold button  on the SmartKey or SmartKey with KEYLESS-GO\* until the tailgate unlocks and opens.

While the tailgate is opening, an acoustic signal sounds.

or

- ▶ Vehicles with KEYLESS-GO\*: Pull on the handle (▷ page 122).

The tailgate is unlocked and opens. While the tailgate is opening, an acoustic signal sounds.

#### *Opening the tailgate from the inside*

You can unlock and open the tailgate simultaneously from the driver's seat when the vehicle is at a standstill.

#### Warning!



Maintain sight of the area around the rear of the vehicle while operating the tailgate with the door-mounted remote tailgate switch or with the  button on the SmartKey or SmartKey with KEYLESS-GO\*. Monitor the opening procedure carefully to make sure no one is in danger of being injured.

To interrupt the opening procedure, press or pull the door-mounted remote tailgate switch or press the  button on the SmartKey or SmartKey with KEYLESS-GO\*.

The switch is located in the driver's door.



#### ① Remote tailgate switch

- ▶ Pull remote tailgate switch ① until tailgate begins to open.

The tailgate opens. While the tailgate is opening, an acoustic signal sounds.

**Limiting opening height of tailgate \***

In vehicles with power tailgate\*, the tailgate opening height can be limited when transporting goods on a roof rack\* (e.g. presence of an MB roof cargo container\*). When activated, the tailgate opens to approximately 6.6 ft (2.00 m).

- ▶ Activate the limiting opening height of tailgate using the control system (▷ page 181).

**Closing the tailgate from the inside**

You can close the tailgate from the inside using the remote tailgate switch.

If the tailgate comes into contact with an object while closing (e.g. luggage that has been piled too high) the closing procedure is stopped and the tailgate reopens.

**Warning!**

Maintain sight of the area around the rear of the vehicle while operating the tailgate with the door-mounted switch. Monitor the closing procedure carefully to make sure no one is in danger of being injured.

To interrupt the closing procedure, press or pull the door-mounted remote tailgate switch or press the  button on the SmartKey or SmartKey with KEYLESS-GO\*.

Even with the SmartKey or the SmartKey with KEYLESS-GO\* removed from the starter switch or the SmartKey with KEYLESS-GO\* removed from the vehicle, the remote tailgate switch can be operated. Therefore, do not leave children unattended in the vehicle, or with access to an unlocked vehicle. A child's unsupervised access to a vehicle could result in an accident and/or serious personal injury.

- ▶ Press remote tailgate switch ① (▷ page 124) until tailgate begins to close.

The tailgate closes. While the tailgate is closing an acoustic signal sounds.

To interrupt the closing procedure:

- ▶ Press or pull remote tailgate switch ① (▷ page 124).

### Locking and unlocking

#### ***Closing the tailgate from the outside***

You can close the tailgate from the outside using the tailgate closing switch or the  button on the SmartKey or SmartKey with KEYLESS-GO\*. In vehicles with KEYLESS-GO\*, you can also simultaneously lock the vehicle.

If the tailgate comes into contact with an object while closing (e.g. luggage that has been piled too high) the closing procedure is stopped and the tailgate reopens.

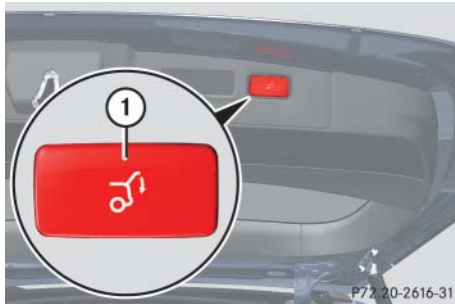

#### **Vehicles without KEYLESS-GO\***

- ① Tailgate closing switch

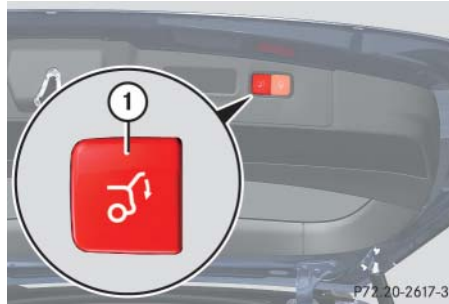

#### **Vehicles with KEYLESS-GO\***

- ① Tailgate closing switch
- ▶ Press tailgate closing switch ① or the  button on the SmartKey or SmartKey with KEYLESS-GO\* briefly.

The tailgate closes and an acoustic warning sounds.

#### **Warning!**



Monitor the closing procedure carefully to make sure no one is in danger of being injured. To prevent possible personal injury,

always keep hands and fingers away from the cargo compartment opening when closing the tailgate. Be especially careful when small children are around. To stop the closing procedure, do one of the following:

- Press tailgate closing switch ① (▷ page 126).
- Press KEYLESS-GO\* locking/closing switch\* ① (vehicles with KEYLESS-GO\*) (▷ page 127).
- Press the  button on the SmartKey (▷ page 112) or SmartKey with KEYLESS-GO\* (▷ page 115).
- Press or pull the remote tailgate switch on the driver's door (▷ page 124).

Even with the SmartKey removed from the starter switch or the SmartKey with KEYLESS-GO\* removed from the vehicle, the tailgate closing switch can be operated. Therefore, do not leave children unattended in the vehicle, or with access to an unlocked vehicle. A child's unsupervised access to a vehicle could result in an accident and/or serious personal injury.

**i** Do not place the SmartKey or SmartKey with KEYLESS-GO\* in the open cargo compartment. You may lock yourself out.

**i** If the vehicle was previously centrally locked, the tailgate will lock automatically after closing it. The turn signals will flash three times to confirm locking.

### **Closing the tailgate and locking the vehicle from the outside (vehicles with KEYLESS-GO\*)**

In vehicles with power tailgate and KEYLESS-GO\*, you can close the tailgate and lock the vehicle simultaneously from the outside using the KEYLESS-GO\* locking/closing switch.

If the tailgate comes into contact with an object while closing (e.g. luggage that has been piled too high), the closing procedure is stopped and the tailgate reopens.

- ▶ Make sure you have the SmartKey with KEYLESS-GO\* with you.

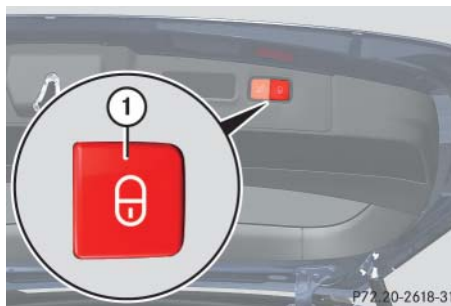

① KEYLESS-GO\* locking/closing switch

- ▶ Press KEYLESS-GO\* locking/closing switch ① briefly.

The tailgate closes automatically. Once the tailgate is closed, the vehicle locks if doors are closed. The turn signals flash three times to confirm locking. The locking knobs in the doors move down. The anti-theft alarm system is armed.

### **Warning!**



Monitor the closing procedure carefully to make sure no one is in danger of being injured. To prevent possible personal injury, always keep hands and fingers away from the cargo compartment opening when closing the tailgate. Be especially careful when small children are around. To stop the closing procedure, do one of the following:

- Press tailgate closing switch ① (▷ page 126).
- Press KEYLESS-GO\* locking/closing switch\* ① (▷ page 127).
- Press the  button on the SmartKey with KEYLESS-GO\* (▷ page 115).
- Press or pull the remote tailgate switch on the driver's door (▷ page 124).



### Locking and unlocking

▷▷ Even with the SmartKey with KEYLESS-GO\* removed from the vehicle, the tailgate closing switch can be operated. Therefore, do not leave children unattended in the vehicle, or with access to an unlocked vehicle. A child's unsupervised access to a vehicle could result in an accident and/or serious personal injury.

**i** To prevent a possible inadvertent lockout, the tailgate will open automatically if a SmartKey with KEYLESS-GO\* is recognized inside the vehicle.

#### Automatic central locking

The doors and the tailgate lock automatically when the ignition is switched on and the wheels are turning at vehicle speeds of approximately 9 mph (15 km/h) or more.

**i** You can open a locked door from the inside. Open door only when conditions are safe to do so.

**i** The doors unlock automatically after an accident if the force of the impact exceeds a preset threshold.

The vehicle automatically locks when the ignition is switched on and the wheels are turning at vehicle speeds of approximately 9 mph (15 km/h) or more. You could therefore lock yourself out when the vehicle

- is pushed or towed
- is on a test stand

For information on towing the vehicle, see "Towing the vehicle" (▷ page 538).

You can deactivate the automatic central locking mode using the control system (▷ page 180).

#### Locking and unlocking from the inside

You can lock or unlock the doors and the tailgate from inside using the central locking or unlocking switch. This can be useful, for example, if you want to lock the vehicle before starting to drive.

The fuel filler flap cannot be locked or unlocked with the central locking or unlocking switch.

#### Warning!



When leaving the vehicle, always remove the SmartKey or SmartKey with KEYLESS-GO\* from the starter switch, take it with you, and lock the vehicle. Do not leave children unattended in the vehicle, or with access to an unlocked vehicle. A child's unsupervised access to a vehicle could result in an accident and/or serious personal injury.

The switches are located in the drivers door.

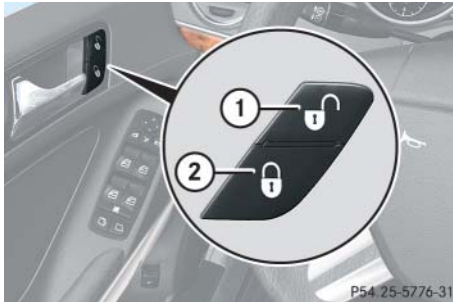

- ① Central unlocking switch
- ② Central locking switch

### Locking

- ▶ Press central locking switch ②.

If all doors and the tailgate are closed, the vehicle locks.

### Unlocking

- ▶ Press central unlocking switch ①.

The vehicle unlocks.

**i** You can open a locked door from inside at any time. Open door only when conditions are safe to do so.

*If the vehicle was previously centrally locked with the SmartKey or with KEYLESS-GO\*, it will not unlock using the central unlocking switch.*

*If the vehicle was previously locked with the central locking switch:*

- *and the SmartKey or SmartKey with KEYLESS-GO\* is set to factory settings, the complete vehicle is unlocked when a front door is opened from the inside*
- *and the SmartKey or SmartKey with KEYLESS-GO\* is set to selective settings, only the front door opened from the inside is unlocked*

**i** *With the passenger-side door opened, you cannot lock the vehicle with the central locking switch.*

### Seats

For information on seat adjustment, see the “Getting started” section (▷ page 45).

For more information on seats, see “Loading” (▷ page 295).

#### Easy-entry/exit feature for third-row seats

This feature allows for easier access to and exit from the vehicle’s third-row seats.

#### Warning!



To help avoid personal injury, the second-row seat backrests must be properly locked either in the upright position or, when using the expanded cargo compartment, in the fully folded position while the vehicle is in motion.

#### Easy-entry feature for third-row seats

The lever for the easy-entry feature is located on the rear of the seat base of the passenger side second-row seat.



#### ① Easy-entry lever

**!** Make sure that the head restraint is pushed all the way down (▷ page 135).

- ▶ Pull and hold easy-entry lever ① in direction of arrow at resistance point.

The seat backrest folds forward.



#### ① Easy-entry lever

- ▶ Pull and hold easy-entry lever ① once again in direction of arrow at resistance point.
- ▶ Lift up the right second-row seat until it folds forward.

You should now have sufficient space to access the vehicle’s third-row seat.

**i** Vehicles with memory function\*: The front passenger seat moved slightly forward.



### Easy-entry/exit position

While the easy-entry feature is activated, you will see, for example, the following message in the multifunction display:

2nd Row Of Seats - Right  
Not Locked

- ▶ Return seat into its original position (▷ page 132).

The message in the multifunction display disappears.

For setting the front passenger seat back into the stored position, see “Recalling positions from memory” (▷ page 142).

For information on how to fold down the second-row seats completely, see “Folding second-row seats” (▷ page 306).

### Easy-exit feature for third-row seats

The easy-exit strap is located on the right rear of the second-row seat base.

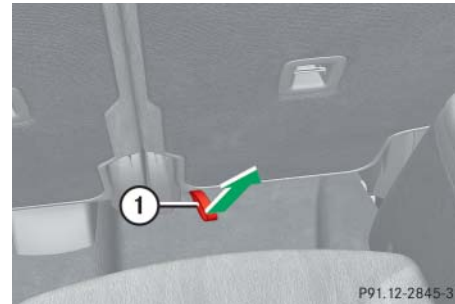

① Easy-exit strap

- ▶ To exit the vehicle when seated on a third-row seat, pull up and hold easy-exit strap ①.

The right second-row seat backrest folds forward.

- ▶ Pull and hold once easy-entry strap ①.
- ▶ Lift up the right second-row seat until it folds forward.

You should now have sufficient space to exit the vehicle’s third-row seat.

**i** *Vehicles with memory function\*:*  
*The front passenger seat moved slightly forward.*

While the easy-entry feature is activated, you will see, for example, the following message in the multifunction display:

2nd Row Of Seats - Right  
Not Locked





### Seats

- ▷▷ Return seat into its original position (▷ page 132).

The message in the multifunction display disappears.

For setting the front passenger seat back into the stored position, see “Recalling positions from memory” (▷ page 142).

For information on how to fold down the second-row seats completely, see “Folding second-row seats” (▷ page 306).

#### Returning second-row seats to their original position

##### Warning!



When occupants have entered or exited the vehicle using the easy-entry/exit feature, before driving off make sure

- the seats are properly locked
- the seat backrests are in an upright position and are properly locked

If a seat and seat backrest are not properly locked, the seat could move forward and the seat backrest could fold. You could slide under the seat belt during braking, vehicle maneuvers, or in an accident. If you slide under it, the belt would apply force at the abdomen or neck. That could cause serious or even fatal injuries.

- ▶ Fold seat (▷ page 131) back until it audibly engages.
- ▶ Fold seat backrest (▷ page 130) back into original position until it engages.

To make sure the seat backrest has engaged, lean firmly against the backrest.

#### Emergency exit for third-row seats

**i** If, due to an accident or other situation, it is not possible for you to exit the vehicle on the side of the easy-entry seat (▷ page 130), you can fold the left side of the seat backrest in the second row of seats down in order to open the left rear door.

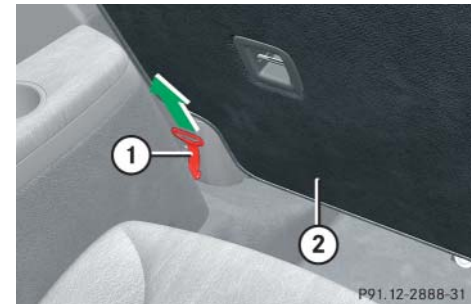

- ① Emergency release
- ② Seat backrest

**!** Make sure that the head restraint is pushed all the way down (▷ page 135).

- ▶ Pull emergency release ① in the direction of arrow.
- ▶ Push seat backrest ② forwards.

**Warning!**

To help avoid personal injury when folding the seat backrest forward, make sure that you move both feet and legs all the way back and out of the way to avoid them contacting the seat as it pivots forward.

In order to prevent an accident or any other potentially dangerous situations when opening the rear door and exiting the vehicle, make sure that you are aware of the traffic situation at all times.

- ▶ Open the left door.
- ▶ Exit the vehicle.

**Front seat active head restraints****Warning!**

For your protection, drive only with properly positioned head restraints.

Adjust the head restraint so that it is close to the head as possible and the center of the head restraint supports the back of the head at eye level. This will reduce the potential for injury to the head and neck in the event of an accident or similar situation.

You cannot remove the active head restraints on the driver's and front passenger's seat.

For removal of the active head restraints we recommend that you contact an authorized Mercedes-Benz Light Truck Center.

For information on head restraint adjustment, see "Seats" (▷ page 45).

For information on active head restraints, see "Active head restraint" (▷ page 90).

**Rear seats****Warning!**

According to accident statistics, children are safer when properly restrained in the rear seating positions than in the front seating position. Thus, we strongly recommend that children be placed in the rear seats. Regardless of seating position, children 12 years old and under must be seated and properly secured in an appropriately sized infant restraint, toddler restraint, or booster seat recommended for the size and weight of the child. For additional information, see "Children in the vehicle" (▷ page 91).

A child's risk of serious or fatal injuries is significantly increased if the child restraints are not properly secured in the vehicle and/or the child is not properly secured in the child restraint.

### Rear seat adjustment

#### Warning!



Never ride in a moving vehicle with the seat backrest in an excessively reclined position as this can be dangerous. You could slide under the seat belt in a collision. If you slide under it, the belt would apply force at the abdomen or neck. That could cause serious or fatal injuries. The seat backrest and seat belts provide the best restraint when the wearer is in a nearly upright position and belts are properly positioned on the body.

Your seat must be adjusted so that you can correctly fasten your seat belt (▷ page 53).

Never place hands under the seat or near any moving parts while a seat is being adjusted.

After adjusting rear seats, make sure

- the seats are properly locked
- the seat backrests are in an upright position and are properly locked

Check for secure locking by pushing and pulling on the seat backrests. If a seat and seat backrest are not properly locked, the seat could move forward and the seat backrest could fold. The child seat would no longer be properly supported or positioned to provide its intended benefit.

### Seat backrest tilt (second-row seats)

#### Warning!



The seat belt only offers its intended protection when the seat backrest is in a nearly vertical position and the occupant is sitting upright. Avoid sitting in positions that prevent the seat belt from being properly positioned against the body (▷ page 53). You should therefore adjust the backrest to a position as upright as possible.

The seat backrest tilt can be set to five different positions.

The handles for adjusting the seats are located on the rear of each seat base.



#### ① Adjustment handle

- ▶ While seated, pull handle ① in direction of arrow to resistance point and hold it there.
- ▶ To move seat backrest back, lean lightly against backrest.

- ▶ To move seat backrest forward, lean forward with handle ① pulled and held at resistance point.

The seat backrest will move forward against your back.

- ▶ Release handle ① when the seat backrest has reached the desired position.

To make sure the seat backrest has engaged, lean firmly against the backrest.

### Head restraint height

#### Warning!



With a rear seat occupied, make sure to move the respective head restraint up from the lowest non-use position and have the occupant adjust the head restraint properly.

For your protection, drive only with properly positioned head restraints.

Adjust the head restraint in such a way that it is as close to the head as possible and the center of the head restraint supports the back of the head at eye level. This will reduce the potential for injury to the head and neck in the event of an accident or similar situation.

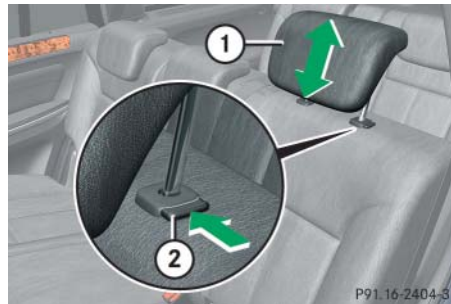

#### Second-row seat head restraint

- ① Head restraint
- ② Release button

Raising:

- ▶ Manually adjust the height of head restraint ① by pulling it upward to the desired position.

Lowering:

- ▶ To lower head restraint ①, push release button ② and press down on head restraint ①.

**i** The third-row seat head restraints are adjusted in the same manner.

### Head restraint fore and aft adjustment



The angle of the head restraint for the outer second-row seats or the third-row seats can be adjusted manually.

- ▶ While seated, reach behind you with both hands and find lower edge of the head restraint.
- ▶ Adjust the head restraint to the desired position by pushing or pulling on the lower edge of the head restraint cushion.

### Head restraints

#### Warning!



Do not drive the vehicle without the seat head restraints installed when the rear seats are occupied. Head restraints are intended to help reduce injuries during an accident.

With a rear seat occupied, make sure to move the respective head restraint up from the lowest non-use position and have the occupant adjust the head restraint properly.

For your protection, drive only with properly positioned head restraints.

Adjust the head restraint in such a way that it is as close to the head as possible and the center of the head restraint supports the back of the head at eye level. This will reduce the potential for injury to the head and neck in the event of an accident or similar situation.

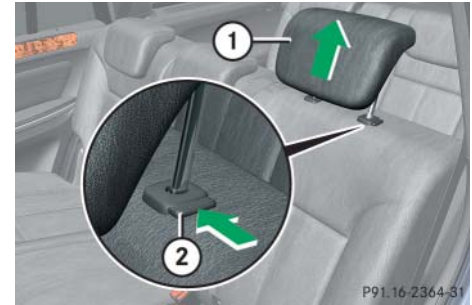

### Second-row seat head restraint

- ① Head restraint
- ② Release button

### Removing

- ▶ Second-row seat:  
Fold the seat backrest forward (▷ page 134).
- ▶ Third-row seat:  
Fold the seat backrest forward (▷ page 305).
- ▶ Pull head restraint ① to its uppermost position.

- ▶ Push release button ② and pull out head restraint.
- ▶ Second-row seat:  
Fold the seat backrest rearward until it engages.
- ▶ Third-row seat:  
Fold the seat backrest rearward (▷ page 305).

### **Installing**

- ▶ Second-row seat:  
Fold the seat backrest forward (▷ page 134).
- ▶ Third-row seat:  
Fold the seat backrest forward (▷ page 305).
- ▶ Insert head restraint ① into openings on the seat backrest.
- ▶ Push head restraint ① down until it audibly engages.
- ▶ Push release button ② and adjust head restraint ① to the desired position (▷ page 135).

- ▶ Second-row seat:  
Fold the seat backrest rearward until it engages.
- ▶ Third-row seat:  
Fold the seat backrest rearward (▷ page 305).

For more information on seats, see the “Getting started” section (▷ page 45).

### **Lumbar support**

The curvature of the driver’s seat can be adjusted to help enhance lower back support and seating comfort.

The lever for lumbar support adjustment is located on the right hand side of the driver’s seat backrest.

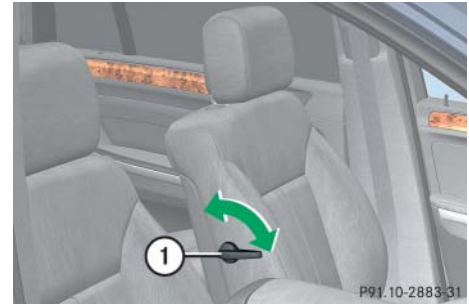

① Adjustment lever

- ▶ Move adjustment lever ① in direction of arrows until you have reached a comfortable seating position.

### Seats

#### Multicontour seat\*

The multicontour seat has an extendable seat cushion and inflatable air chambers built into the backrest to provide additional lumbar and side support.

The seat cushion depth, seat backrest cushion-height and curvature can be continuously varied with switches on the inside of each front seat base after the ignition is switched on (▷ page 41).

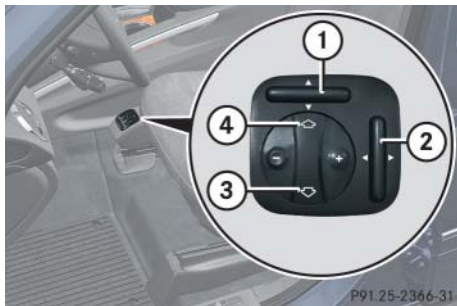

- ① Seat cushion depth
- ② Backrest side bolsters
- ③ Backrest center
- ④ Backrest bottom

- ▶ Switch on the ignition (▷ page 42).

#### Seat cushion depth

- ▶ Adjust the seat cushion depth to the length of your upper leg with switch ①.

#### Backrest contour

- ▶ Adjust the contour of the seat backrest to the desired position with switch **+** or **-**.
- ▶ Move the backrest support to the bottom with button ④ or to the center with button ③.

#### Backrest side bolsters

- ▶ Adjust the side bolsters so that they provide good lateral support using switch ②.

#### Seat heating\*

The switches for front-seat heating are located in the center console.



- ① Seat heating switch, front seats
- ② Indicator lamps

The switches for second-row seat heating\* are located in the rear center console.



- ① Seat heating switch\*, second-row seats
- ② Indicator lamps

The red indicator lamps in the switch come on to show which heating level you have selected.

Level	
<b>3</b>	Three indicator lamps on (highest level)  The seat heating automatically switches to level 2 after approximately 5 minutes.
<b>2</b>	Two indicator lamps on  The seat heating automatically switches to level 1 after approximately 10 minutes.
<b>1</b>	One indicator lamp on (lowest level)  The seat heating automatically switches off after approximately 20 minutes.
<b>off</b>	No indicator lamp on

- ▶ Switch on the ignition (▷ page 42).

### Switching on

- ▶ Press switch ①.  
  
Three red indicator lamps ② in the switch come on.
- ▶ Continue pressing switch ① until desired seat heating level is reached.

### Switching off

- ▶ Press switch ① repeatedly until all indicator lamps ② go out.

**i** If one or more of the indicator lamps ② on seat heating switch ① (▷ page 138) are flashing, there is insufficient voltage available since too many electrical consumers are switched on. The seat heating switches off automatically.

The seat heating will switch back on again automatically as soon as sufficient voltage is available.



## Seats

### Seat ventilation\*

The switches for the seat ventilation are located in the center console.



- ① Seat ventilation switch, front seats
- ② Indicator lamps

The blue indicator lamps in the switch come on to show which ventilation level you have selected.

Level	
3	Three indicator lamps on (highest level)
2	Two indicator lamps on
1	One indicator lamp on (lowest level)
off	No indicator lamp on

- ▶ Switch on the ignition (▷ page 42).

### Switching on

- ▶ Press button ① repeatedly until the desired ventilation level is set.

**i** *The seat ventilation for the driver's seat is automatically set to the highest level if activated via summer opening feature (▷ page 249).*

### Switching off

- ▶ Press button ① repeatedly until all indicator lamps ② go out.

## ▼ Memory function\*

Prior to operating the vehicle, the driver should check and adjust the seat height, seat position fore and aft, and seat back-rest angle if necessary, to ensure adequate control, reach and comfort. The head restraint should also be adjusted for proper height. See also the section on air bags (▷ page 76) for proper seat positioning.

In addition, adjust the steering wheel to ensure adequate control, reach, operation and comfort. Both the interior and exterior rear view mirrors should be adjusted for adequate rear vision.

Fasten seat belts. Infants and small children should be seated in a properly secured restraint system that complies with U.S. Federal Motor Vehicle Safety Standards 213 and 225 and Canadian Motor Vehicle Safety Standards 213 and 210.2.

With the memory function you can store up to three different configurations.

Each stored position on the driver's side includes the following settings:

- Seat position
- Multicontour seat\*: previously saved setting
- Steering wheel position
- Exterior rear view mirrors' position

Each stored position on the passenger side includes the following settings:

- Seat position
- Multicontour seat\*: previously saved setting

The memory button and stored position buttons are located on the entry side of each front seat base.



**M** Memory button

**1, 2, 3** Stored position buttons

### Warning!



Do not activate the memory function while driving. Activating the memory function while driving could cause the driver to lose control of the vehicle.

### Memory function\*

#### Storing positions into memory

- ▶ Adjust the seats (▷ page 45).
- ▶ On the driver's side, additionally adjust the steering wheel (▷ page 50) and exterior rear view mirrors (▷ page 51) to the desired positions.
- ▶ Press memory button **M**.
- ▶ Release memory button **M** and press stored position button **1**, **2** or **3** within 3 seconds.

All settings are stored to the selected position.

#### Recalling positions from memory

**!** *Do not operate the power seats using memory button **M** if the seat backrest is in an excessively reclined position. Doing so could cause damage to front or rear seats.*

*Move seat backrest to an upright position first.*

- ▶ Press and hold stored position button **1**, **2** or **3** until the seat, steering wheel and exterior rear view mirrors have fully moved to the stored positions.

**i** *Releasing the stored position button stops movement to the stored positions immediately.*

▼ Lighting

For information on how to switch on the headlamps and use the turn signals, see “Switching on headlamps” (▷ page 61) and “Turn signals” (▷ page 62).

**i** If you drive in countries where vehicles drive on the other side of the road than the country in which the vehicle is registered, you must have the headlamps modified for symmetrical low beams. Relevant information can be obtained at any authorized Mercedes-Benz Light Truck Center.

**i** Vehicles equipped with active Bi-Xenon\* headlamps:  
The active Bi-Xenon\* headlamps monitor the vehicles steering angle and vehicle speed, then automatically shift their beams to either side to better follow the curvature of the road ahead, increasing usable illumination over conventional headlamps.

Exterior lamp switch

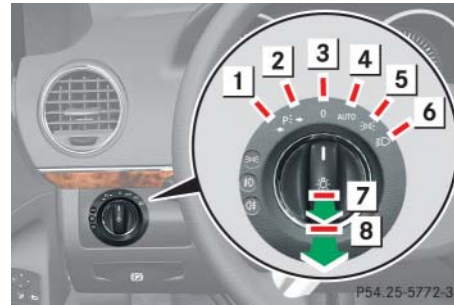

- 1 **↔P↔** Standing lamps, left (turn left two stops)
- 2 **P↔→** Standing lamps, right (turn left one stop)
- 3 **0** Off  
Daytime running lamp mode (▷ page 145)
- 4 **AUTO** Automatic headlamp mode  
Daytime running lamp mode (▷ page 145)

- 5 **☰☰☰** Parking lamps (also side marker lamps, tail lamps, license plate lamps, instrument panel lamps)
- 6 **☰☰** Low beam headlamps or high beam headlamps
- 7 **☰☰** Front fog lamps
- 8 **☰☰** Rear fog lamp

**i** The exterior lamps switch off automatically when you remove the SmartKey from the starter switch or open the driver’s door with the ignition switched off.

When the parking lamps or the rear fog lamp are switched on and you remove the SmartKey from the starter switch or open the driver’s door, an acoustic signal sounds.

In addition the message Switch Off Lights appears in the multifunction display.

Switch off the parking lamps or the rear fog lamp manually.

**!** Failure to switch off the parking lamps when leaving the vehicle may result in a discharged battery.

### Lighting

#### Low beam headlamps

- ▶ Turn the exterior lamp switch to position .

With the SmartKey in starter switch position **1** or the KEYLESS-GO\* start/stop button pressed once, the following lamps will switch on:

- Tail and parking lamps
- License plate lamps
- Side marker lamps

With the SmartKey in starter switch position **2** or the KEYLESS-GO\* start/stop button pressed twice, the following lamps will switch on additionally:

- Low beam headlamps
- High beam headlamps (when the combination switch is pushed forward)

#### Automatic headlamp mode

The following lamps switch on and off automatically depending on the brightness of the ambient light:



- Low beam headlamps
- Tail and parking lamps
- License plate lamps
- Side marker lamps

#### Warning!



If the exterior lamp switch is set to **AUTO**, the headlamps will not be automatically switched on under foggy conditions.

To minimize risk to you and to others, activate headlamps by turning exterior lamp switch to  when driving or when traffic and/or ambient lighting conditions require you to do so.

In low ambient lighting conditions, only switch from position **AUTO** to  with the vehicle at a standstill in a safe location. Switching from **AUTO** to  will briefly switch off the headlamps. Doing so while driving in low ambient lighting conditions may result in an accident.

The automatic headlamp feature is only an aid to the driver. The driver is responsible for the operation of the vehicle's lights at all times.

- ▶ Turn the exterior lamp switch to position **AUTO**.

With the SmartKey in starter switch position **1** or the KEYLESS-GO\* start/stop button pressed once, only the parking lamps and the side marker lamps will switch on and off depending on the brightness of the ambient light.

When the engine is running, the low beam headlamps, the tail and parking lamps, the license plate lamps, and the side marker lamps will switch on and off depending on the brightness of the ambient light.

**i** *Canada only:*

*High beam headlamps are only available with the exterior lamp switch in position .*

### Daytime running lamp mode

In Canada the daytime running lamp mode is mandatory and therefore in a constant mode.

In the USA the daytime running lamp mode is deactivated by default. Activate the daytime running lamp mode using the control system, see “Setting daytime running lamp mode (USA only)” (▷ page 175).

- ▶ Turn the exterior lamp switch to position **0** or **AUTO**.

When the engine is running, the low beam headlamps are switched on.

In low ambient light conditions, the following lamps will switch on additionally:

- Tail and parking lamps
- License plate lamps
- Side marker lamps

**i** *With the daytime running lamp mode activated and the engine running, you cannot switch off the low beam headlamps manually.*

### Canada only



**i** *With the exterior lamp switch in position **0** or **AUTO**, you cannot switch on the high beam headlamps.*

*The high beam flasher is available at all times.*

*For nighttime driving turn the exterior lamp switch to position  to permit activation of the high beam headlamps.*

When the engine is running, and you shift from a driving position to position **N** or **P** with the vehicle at a standstill, the low beam headlamps will switch off with a three-minute delay.

When the engine is running, and you

- turn the exterior lamp switch to position , the low beam headlamps, the tail and parking lamps, the side marker lamps and the license plate lamps switch on
- turn the exterior lamp switch to position , the manual headlamp mode has priority over the daytime running lamp mode



### USA only

**i** *With the exterior lamp switch in position **0**, you cannot switch on the high beam headlamps.*

*The high beam flasher is available at all times.*

*For nighttime driving turn the exterior lamp switch to position  or **AUTO** to permit activation of the high beam headlamps.*

### Lighting

When the engine is running, and you turn the exterior lamp switch to position  or , the manual headlamp mode has priority over the daytime running lamp mode.

The corresponding exterior lamps switch on (▷ page 61).



#### Locator lighting and night security illumination

The locator lighting and the night security illumination are described in the “Control system” section, see “Setting locator lighting” (▷ page 176) and “Setting night security illumination” (▷ page 176).

#### Fog lamps

##### Warning!







In low ambient lighting or foggy conditions, only switch from position **AUTO** to  with the vehicle at a standstill in a safe location. Switching from **AUTO** to  will briefly switch off the headlamps. Doing so while driving in low ambient lighting conditions may result in an accident.



**i** *Fog lamps will operate with the parking lamps and/or the low beam headlamps on. Fog lamps should only be used in conjunction with low beam headlamps. Consult your State or Province Motor Vehicle Regulations regarding permissible lamp operation.*

**i** *Fog lamps cannot be switched on with the exterior lamp switch in position **AUTO**. To switch on the fog lamps, turn the exterior lamp switch to position  first.*

#### Front fog lamps

- ▶ Turn the exterior lamp switch to position  or  (▷ page 144).
- ▶ Pull out the exterior lamp switch to first stop.  
The front fog lamps switch on.  
The green indicator lamp  in the exterior lamp switch comes on.
- ▶ Push in the exterior lamp switch.  
The front fog lamps switch off.  
The green indicator lamp  in the exterior lamp switch goes out.

#### Rear fog lamp (driver's side only)

- ▶ Turn the exterior lamp switch to position  (▷ page 144).
- ▶ Pull out the exterior lamp switch to second stop.  
The rear fog lamp switches on.  
The yellow indicator lamp  in the exterior lamp switch comes on.

- ▶ Push in the exterior lamp switch to first stop.

The rear fog lamp switches off.

The yellow indicator lamp  in the exterior lamp switch goes out.

The front fog lamps remain lit.

### Combination switch

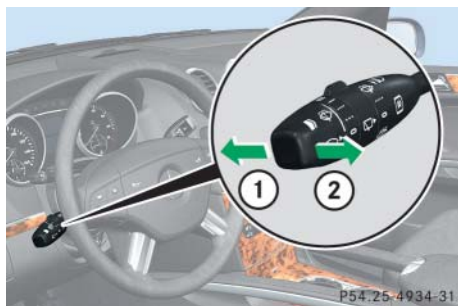

- ① High beam
- ② High beam flasher

### High beam

- ▶ Turn the exterior lamp switch to position  (▷ page 143).
- ▶ Push the combination switch in direction of arrow ① to switch on the high beam.

The high beam headlamp indicator lamp  in the instrument cluster comes on (▷ page 26).

- ▶ Pull the combination switch in direction of arrow ② to its original position to switch off the high beam.

The high beam headlamp indicator lamp  in the instrument cluster goes out.

### High beam flasher

- ▶ Pull the combination switch briefly in direction of arrow ②.

### Corner-illuminating front fog lamps\*

The corner-illuminating front fog lamps improve illumination of the area in the direction into which you are turning.

The corner-illuminating front fog lamps will operate with the engine running and with

- the exterior lamp switch in position  (▷ page 143)
- or
- the exterior lamp switch in position **AUTO** (▷ page 143)
- or
- the daytime running lamp mode activated (▷ page 145)

 *The corner-illuminating front fog lamps will only come on in low ambient lighting conditions.*

 *If you are driving faster than 25 mph (40 km/h) or have the front fog lamps switched on, the corner-illuminating function is not available.*



### Lighting

#### Driving forward

##### **Switching on corner-illuminating front fog lamps**

- ▶ Switch on the left or right turn signal (▷ page 62), depending on whether you are turning left or right.

The respective front fog lamp comes on and illuminates the area in the direction into which you are turning.

or

- ▶ Turn steering wheel in desired direction.

The front fog lamp on the side of your steering direction comes on.

**i** *The corner-illuminating front fog lamps temporarily come on on both sides of the vehicle if you turn the steering wheel in one direction and then again in the other direction shortly thereafter.*

**i** *The corner-illuminating front fog lamps will come on automatically depending on the steering angle and vehicle speed, even if you did not switch on either turn signal. If the corner-illuminating front fog lamps came on automatically, they will also go out automatically depending on the steering angle and vehicle speed.*

##### **Switching off corner-illuminating front fog lamps**

The combination switch for the turn signal resets automatically after major steering wheel movements. This will switch off the corner-illuminating front fog lamps if they were activated by switching on the left or right turn signal.

If the turn signal should stay on after making the turn, the turn signal and the corner-illuminating front fog lamps can be switched off by returning the combination switch to its original position.

**i** *There may be a brief delay before the corner-illuminating front fog lamps switch off.*

#### Driving in reverse

##### **Switching on corner-illuminating front fog lamps**

- ▶ Shift the automatic transmission to reverse gear **R** (▷ page 191).

The front fog lamp opposite to your steering direction comes on.

##### **Switching off corner-illuminating front fog lamps**

- ▶ Shift the automatic transmission to a gear other than reverse gear **R** (▷ page 191).

The respective corner-illuminating front fog lamp goes out.

### Hazard warning flasher

The hazard warning flasher can be switched on at all times, even with the SmartKey removed from the starter switch or with the SmartKey with KEYLESS-GO\* removed from the vehicle.

The hazard warning flasher switches on automatically when an air bag deploys.

The hazard warning flasher switch is located on the center console.



① Hazard warning flasher switch

### Switching on hazard warning flasher

► Press hazard warning flasher switch ①.

All turn signals are flashing.

**i** With the hazard warning flasher activated and the combination switch set for either left or right turn, only the respective turn signals will operate when the ignition is switched on.

### Switching off hazard warning flasher

► Press hazard warning flasher switch ① again.

**i** If the hazard warning flasher has been activated automatically, press hazard warning flasher switch ① once to switch it off.

### Interior lighting

The controls for interior lighting are located in the overhead control panel.



- ① Front left reading lamp switch
- ② Rear interior lighting switch
- ③ Automatic control switch
- ④ Front interior lighting switch
- ⑤ Front right reading lamp switch
- ⑥ Front right interior lamp
- ⑦ Front right reading lamp
- ⑧ Front left reading lamp
- ⑨ Front left interior lamp

### Lighting

**!** *An interior lamp switched on manually does not go out automatically.*

*Leaving an interior lamp switch in the ON position for extended periods of time with the engine turned off could result in a discharged battery.*

#### Automatic control

**i** *The interior lighting is factory-set to automatic mode.*

#### Deactivating

- ▶ Press switch ③.  
The switch engages in the recessed position.

The interior lighting and the locator lighting (▷ page 176) remain switched off even when you

- unlock the vehicle
- open a door
- open the tailgate
- remove the SmartKey from the starter switch

#### Activating

- ▶ Press switch ③.  
The switch disengages from its recessed position back to its original position.

The interior lighting and the locator lighting (▷ page 176) come on when you

- unlock the vehicle
- open a door
- open the tailgate
- remove the SmartKey from the starter switch

The interior lamps go out following an adjustable time delay (▷ page 177).

**i** *If a door remains open, the interior lamps switch off automatically after approximately 5 minutes when the SmartKey is removed or in starter switch position 0.*

#### Manual control

**i** *An interior lamp switched on manually does not go out automatically.*

#### Switching front/rear interior lighting on and off

- ▶ Press front/rear interior lighting switch ④ or ② to switch on the respective interior light.
- ▶ Press front/rear interior lighting switch ④ or ② again to switch off the respective interior light.

#### Switching front reading lamps on and off

- ▶ Press front reading lamp switch ① or ⑤ to switch on the respective front reading lamp.
- ▶ Press front reading lamp switch ① or ⑤ again to switch off the respective front reading lamp.

### Switching second-row reading lamps on and off

The second-row reading lamps are located above the side windows.



#### Passenger side reading lamp

- ① Second-row reading lamp
- ▶ Press on reading lamp ① where indicated by arrow.  
The reading lamp comes on.
- ▶ Press on reading lamp ① once more.  
The reading lamp goes out.

### Door entry lamps

For better orientation in the dark, the corresponding door entry lamps come on when you open a door and the automatic control is activated.

The door entry lamps will switch off when the corresponding door is closed.

**i** If you turn the SmartKey in the starter switch to position **0** or remove the SmartKey from the starter switch, the door entry lamps will remain lit for approximately 5 minutes.

### Cargo compartment lamp

The cargo compartment lamp comes on when the tailgate is opened.

If you leave the tailgate open for an extended period of time, the cargo compartment lamp will switch off automatically after approximately 5 minutes.

### Instrument cluster

For a full view illustration of the instrument cluster, see “Instrument cluster” (▷ page 26).



- ① To dim instrument cluster illumination
- ② Reset button
- ③ To brighten instrument cluster illumination

The instrument cluster is activated when you

- open a door
- switch on the ignition (▷ page 42)
- press reset button ②
- switch on the exterior lamps (▷ page 143)

**i** *Opening a front door or pressing the reset button without switching on the ignition or the exterior lighting activates the multifunction display illumination only for 30 seconds.*

For information on changing the instrument cluster settings, e.g. the language, see “Instrument cluster submenu” (▷ page 172).

### Warning!



No messages will be displayed if either the instrument cluster or the multifunction display is inoperative.

As a result, you will not be able to see information about your driving conditions, such as speed or outside temperature, warning/indicator lamps, malfunction/warning messages or the failure of any systems. Driving characteristics may be impaired.

If you must continue to drive, do so with added caution. Contact an authorized Mercedes-Benz Light Truck Center as soon as possible.

## Adjusting instrument cluster illumination

Use button ① or ③ to adjust the illumination brightness for the instrument cluster.

**i** *The instrument cluster illumination is dimmed or brightened automatically to suit ambient light conditions.*

*The instrument cluster illumination will also be adjusted automatically when you switch on the vehicle's exterior lamps.*

**i** *With the exterior lighting switched on, the brightness of the switches in the center console will also be adjusted when using button ① or ③.*

## To brighten illumination



- ▶ Press and hold button ③ until the desired level of illumination is reached.

## To dim illumination

- ▶ Press and hold button ① until the desired level of illumination is reached.

## Resetting trip odometer

Make sure you are viewing the trip odometer display (▷ page 155).

- ▶ If it is not displayed, press button  or  on the multifunction steering wheel (▷ page 156) repeatedly until the trip odometer appears in the multifunction display.
- ▶ Press and hold reset button ② in the instrument cluster (▷ page 152) until the trip odometer is reset.

## Tachometer

The red marking on the tachometer (▷ page 26) denotes excessive engine speed.

**!** *Avoid driving at excessive engine speeds, as it may result in serious engine damage that is not covered by the Mercedes-Benz Limited Warranty.*

To help protect the engine, the fuel supply is interrupted if the engine is operated within the red marking.

## Outside temperature indicator

### Warning!



The outside temperature indicator is not designed to serve as an ice-warning device and is therefore unsuitable for that purpose.

Indicated temperatures just above the freezing point do not guarantee that the road surface is free of ice. The road may still be icy, especially in wooded areas or on bridges.

The outside temperature is displayed in the multifunction display (▷ page 155).

The temperature sensor is located in the front bumper area. Due to its location, the sensor can be affected by road or engine heat during idling or slow driving. This means that the accuracy of the displayed temperature can only be verified by comparison to a thermometer placed next to the sensor, not by comparison to external displays (e.g. bank signs etc.).

When moving the vehicle into colder ambient temperatures (e.g. when leaving your garage), you will notice a delay before the lower temperature is displayed.

A delay also occurs when ambient temperatures rise. This prevents inaccurate temperature indications caused by heat radiated from the engine during idling or slow driving.

## ▼ Control system

The control system is activated as soon as the SmartKey in the starter switch is turned to position **1** (▷ page 42) or as soon as the KEYLESS-GO start/stop button\* is in position **1** (▷ page 44). The control system enables you to

- call up information about your vehicle
- change vehicle settings

For example, you can use the control system to find out when your vehicle is next due for maintenance service, to set the language for messages in the instrument cluster display, and much more.

### Warning!



A driver's attention to the road and traffic conditions must always be his/her primary focus when driving.

For your safety and the safety of others, selecting features through the multifunction steering wheel should only be done by the driver when traffic and road conditions permit it to be done safely.

Bear in mind that at a speed of just 30 mph (approximately 50 km/h), your vehicle is covering a distance of 44 feet (approximately 14 m) every second.

The control system relays information to the multifunction display.

## Multifunction display

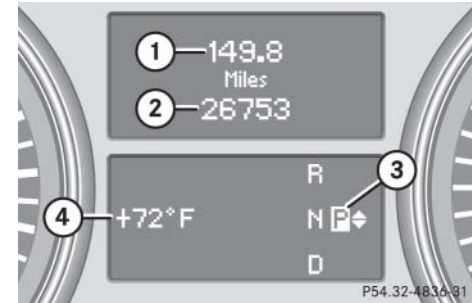

- ① Trip odometer
- ② Main odometer
- ③ Transmission position indicator
- ④ Status indicator (outside temperature or digital speedometer)

For more information on menus displayed in the multifunction display, see “Menus” (▷ page 158).













## Control system

### Multifunction steering wheel

The displays in the multifunction display and the settings in the control system are controlled by the buttons on the multifunction steering wheel.



- ① Multifunction display
- Operating the control system**
- ② Telephone\*:  
Press button
  -  to take a call
  - to dial
  - to redial
  -  to end a call
  - to reject an incoming call
- ③ Selecting the submenu or setting the volume:  
Press button
  -  up/to increase
  -  down/to decrease
- ④  Voice Control System\* on<sup>1</sup>, see separate operating instructions
- ⑤ Moving within a menu:  
Press button
  -  for next display
  -  for previous display

- ⑥  Voice Control System\* off<sup>1</sup>, see separate operating instructions
- ⑦ Menu systems:  
Press button
  -  for next menu
  -  for previous menu





Depending on the selected menu (▷ page 158), pressing the buttons on the multifunction steering wheel will alter what is shown in the multifunction display.

The information available in the multifunction display is arranged in menus, each containing a number of functions or sub-menus.

The individual functions are then found within the relevant menu (radio or CD operations under AUDIO, for example). These functions serve to call up relevant information or to customize the settings for your vehicle.

<sup>1</sup> Vehicles without Voice Control System\*: Button without function.

It is helpful to think of the menus, and the functions within each menu, as being arranged in a circular pattern.

- If you press button  or  repeatedly, you will pass through each menu one after the other.
- If you press button  or  repeatedly, you will pass through each function display, one after the other, in the current menu.

In the *Settings* menu, instead of functions, you will find a number of submenus for calling up and changing settings. For instructions on using these submenus, see “Settings menu” (▷ page 168).

The number of menus available in the system depends on which optional equipment is installed in your vehicle.

The menus are described on the following pages.

### Menus

This is what you will see when you scroll through the menus ① to ⑤.

The table on the next page provides an overview of the individual menus.

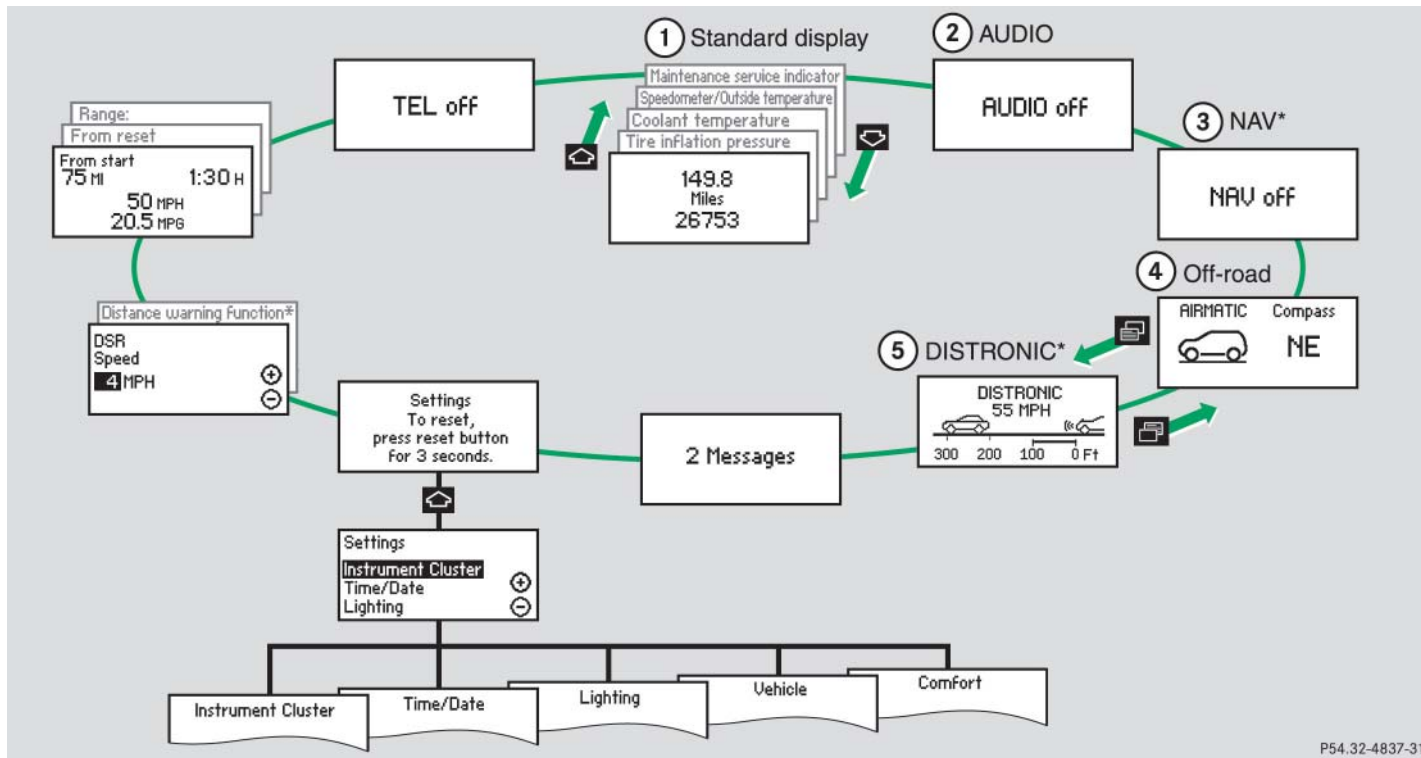

P54.32-4837-31

Menus, submenus and functions

	Menu ①	Menu ②	Menu ③	Menu ④	Menu ⑤
	<b>Standard display</b>	<b>AUDIO</b>	<b>NAV*</b>	<b>Off-road</b>	<b>DISTRONIC* (Canada only)</b>
	(▷ page 162)	(▷ page 164)	(▷ page 166)	(▷ page 166)	(▷ page 167)
<b>Commands/submenus</b>	Trip- and main odometer	Selecting radio station	Route guidance instructions, current direction traveled	Compass	Calling up settings
	Checking tire inflation pressure	Selecting satellite radio station*		Vehicle level	
	Checking coolant temperature	Operating CD player	Differential locks*		
	Calling up digital speedometer or outside temperature				
	Calling up maintenance service indicator				

**i** The headings used in the menus table are designed to facilitate navigation within the system and are not necessarily identical to those shown in the control system displays.

The first function displayed in each menu will automatically show you which part of the system you are in.

## Control system

This is what you will see when you scroll through the menus ④ to ⑩.

The table on the next page provides an overview of the individual menus.

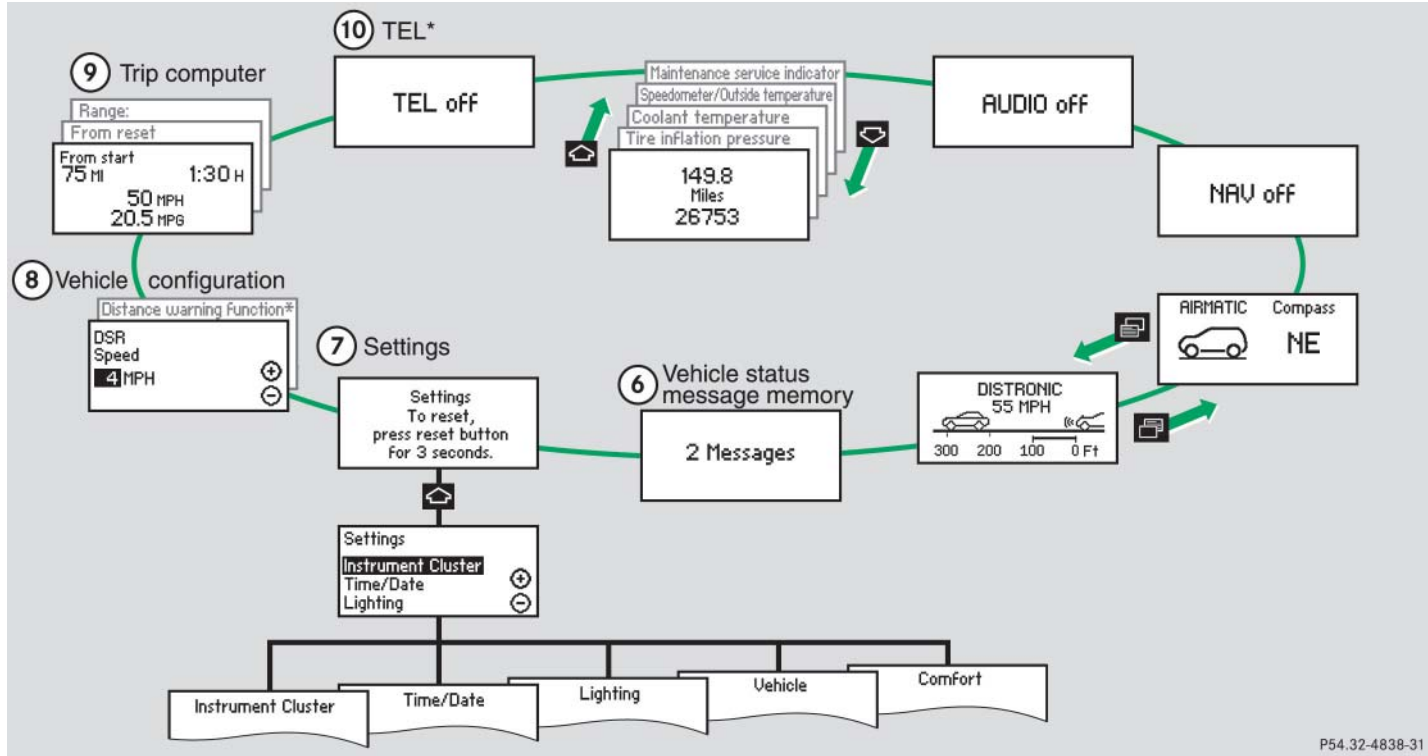

P54.32-4838-31

Menus, submenus and functions

	Menu ⑥	Menu ⑦	Menu ⑧	Menu ⑨	Menu ⑩
	<b>Vehicle status message memory<sup>1</sup></b>	<b>Settings</b>	<b>Vehicle configuration</b>	<b>Trip computer</b>	<b>TEL*</b>
	(▷ page 167)	(▷ page 168)	(▷ page 182)	(▷ page 184)	(▷ page 186)
Commands/submenus	Calling up malfunction messages, warning messages, and system status messages stored in memory	Resetting to factory settings	Distance warning function*on/off	Fuel consumption statistics since start	Loading phone book
		Instrument cluster submenu	DSR (Downhill Speed Regulation) programmed default speed	Fuel consumption statistics since the last reset	Searching for name in phone book
		Time/Date submenu		Resetting fuel consumption statistics	
		Lighting submenu	Distance to empty		
		Vehicle submenu			
	Comfort submenu*				

<sup>1</sup> The vehicle status message memory menu is only displayed if there is a message stored.

**i** The headings used in the menus table are designed to facilitate navigation within the system and are not necessarily identical to those

shown in the control system displays. The first function displayed in each menu will automatically show you which part of the system you are in.



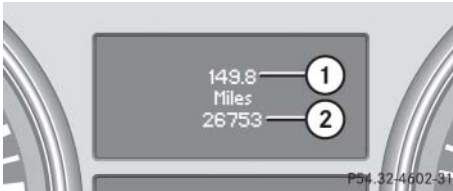

## Control system

### Standard display menu

In the standard display, the main odometer and the trip odometer appear in the multi-function display.



- ① Trip odometer
- ② Main odometer

- ▶ If you see another display, press button  or  repeatedly until the standard display appears.
- ▶ Press button  or  to select the functions in the standard display menu.

The following functions are available:

Function	Page
Checking tire inflation pressure	395
Checking coolant temperature	162
Calling up digital speedometer or outside temperature	163
Calling up maintenance service indicator	424



### Checking coolant temperature

#### Warning!



- Driving when your engine is overheated can cause some fluids which may have leaked into the engine compartment to catch fire. You could be seriously burned.
- Steam from an overheated engine can cause serious burns which can occur just by opening the hood. Stay away from the engine if you see or hear steam coming from it.

Stop the vehicle in a safe location away from other traffic. Turn off the engine, get out of the vehicle and do not stand near the vehicle until the engine has cooled down.

- ▶ Press button  or  repeatedly until the coolant temperature appears in the multifunction display.

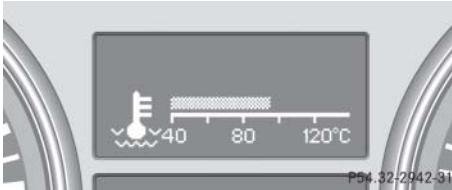



**!** Excessive coolant temperature triggers a warning message in the multifunction display (▷ page 470).

The engine should not be operated with the coolant temperature above 248°F (120°C). Doing so may cause serious engine damage which is not covered by the Mercedes-Benz Limited Warranty.

**i** During severe operating conditions, e.g. stop-and-go traffic, the coolant temperature may rise close to 248°F (120°C).

### Calling up digital speedometer or outside temperature

- ▶ Press button  or  repeatedly until the digital speedometer or the outside temperature appears in the multifunction display.



### Digital speedometer



### Outside temperature

**i** You can select whether the digital speedometer or the outside temperature is shown in the multifunction display.

You can change the setting in the submenu Instrument Cluster via the function Status Line Display, see "Selecting display (digital speedometer or outside temperature) for status indicator" (▷ page 173).



## Control system

### AUDIO menu



The functions in the AUDIO menu operate the audio equipment which you currently have turned on.

If no audio equipment is currently turned on, the message **AUDIO Off** appears in the multifunction display.

The following functions are available:

Function	Page
Selecting radio station	164
Selecting satellite radio station*	164
Operating CD player	165



### Selecting radio station

- ▶ Turn on the COMAND system and select radio. Refer to separate COMAND system operating instructions.
- ▶ Press button  or  repeatedly until the currently tuned station appears in the multifunction display.



- ① Waveband setting
- ② Station frequency

- ▶ Press button  or  repeatedly until the desired station is found.

The station search depends on the selected setting in the **Vehicle** submenu of the control system (▷ page 180). Pressing button  or  will either start a frequency scan or select the next stored radio station.

**i** You can only store new stations using the corresponding feature on the radio. Refer to separate COMAND system operating instructions.

You can also operate the radio in the usual manner.



### Selecting satellite radio station\*

The satellite radio is treated as a radio application.

- ▶ Select satellite radio with the corresponding soft key on the COMAND system.



- ① SAT mode
- ② Channel name or number



- ▶ Press button  or  repeatedly until the desired channel is found.

**i** Additional optional satellite radio equipment and a subscription to satellite radio service provider are required for satellite radio operation. Contact an authorized Mercedes-Benz Light Truck Center for details and availability for your vehicle.

For more information, refer to separate COMAND system operating instructions.

### Operating CD player

#### Selecting CD track

- ▶ Turn on the COMAND system and select CD. Refer to separate COMAND system operating instructions.
- ▶ Press button  or  repeatedly until the settings for the CD currently being played appear in the multifunction display.





- ① Current CD (for CD changer)
- ② Current track

- ▶ Press button  or  repeatedly until the desired track is selected.

**i** To select a CD from the CD changer magazine, press a number on the COMAND system key pad located in the center console.

#### Selecting MP3-CD track

- ▶ Turn on the COMAND system and select MP3. Refer to separate COMAND system operating instructions.
- ▶ Press button  or  repeatedly until the settings for the MP3-CD currently being played appear in the multifunction display.





- ① MP3 mode
- ② Current track

- ▶ Press button  or  repeatedly until the desired track is selected.

## Control system

### NAV\* menu

The NAV menu contains the functions needed to operate your navigation system.

- ▶ Press button  or  repeatedly until the message NAV appears in the multifunction display.

The message shown in the multifunction display depends on the status of the navigation system:



- With the COMAND system switched off, the message NAV Off appears in the multifunction display.
- With the COMAND system switched on but route guidance not activated, the direction of travel and, if applicable, the name of the street currently traveled on appear in the multifunction display.

- With the COMAND system switched on and route guidance activated, the direction of travel and maneuver instructions appear in the multifunction display.

Please refer to the COMAND system manual for instructions on how to activate the route guidance system.

### Off-road menu

The Off-road menu displays the messages for air suspension, differential locks\* and the direction into which you are currently driving.

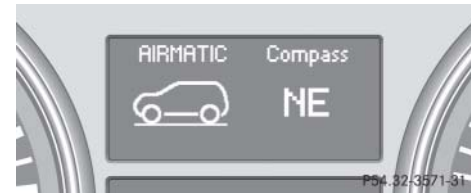

- ▶ Press button  or  repeatedly until one of the following messages appears in the multifunction display.

Vehicles with air suspension:



Vehicles with air suspension and differential locks\*:



- ▶ Press button  or  repeatedly until the desired setting is found.

For information on air suspension, see “Air suspension program” (▶ page 278).



For information on differential locks\*, see “Differential locks\*” (▶ page 204).

For information on the compass, see “Vehicle submenu” (▶ page 178) and “Compass” (▶ page 344).

### **DISTRONIC\* menu (Canada only)**

Use the DISTRONIC menu (▷ page 264) to display the current settings for your Distronic system. The information shown in the multifunction display depends on whether the Distronic system is activated or deactivated.

Please refer to the “Driving systems” section of this manual (▷ page 260) for instructions on how to activate Distronic.

- ▶ Press button  or  repeatedly to select the Distronic menu in the multifunction display.

### **Vehicle status message memory menu**



Use the vehicle status message memory menu to scan malfunction and warning messages that may be stored in the system. Such messages appear in the multifunction display and are based on conditions or system status the vehicle's system has recorded.

The vehicle status message memory menu only appears, if messages have been stored.

#### **Warning!**



Malfunction and warning messages are only indicated for certain systems and are intentionally not very detailed. The malfunction and warning messages are simply a reminder with respect to the operation of certain systems and do not replace the owner's and/or driver's responsibility to maintain the vehicle's operating safety by having all required maintenance and safety checks performed on the vehicle and by bringing the vehicle to an authorized Mercedes-Benz Light Truck Center to address the malfunction and warning messages (▷ page 449).



- ▶ Press button  or  repeatedly until the vehicle status message memory appears in the multifunction display.

If the vehicle status message memory menu does not appear, no messages have been stored.

### Control system

If conditions have occurred causing status messages to be recorded, the number of messages appears in the multifunction display:



- ▶ Press button  or .

The stored messages will now be displayed in the order in which they have occurred. For malfunctions and warning messages, see “Vehicle status messages in the multifunction display” (▷ page 449).

**i** After you have scrolled through all recorded status messages, the first recorded message appears again.



Should the vehicle’s system record any conditions while driving, the number of messages will reappear in the multifunction display

- when the SmartKey in the starter switch is turned to position **0** or removed from the starter switch.
- or
- when you turn off the engine by pressing the KEYLESS-GO\* start/stop button (▷ page 69) in the starter switch once and open the driver’s door (this puts the starter switch in position **0**, same as with the SmartKey removed from the starter switch)

**i** The vehicle status message memory will be cleared when you turn the SmartKey in the starter switch to position **1** or **2**, or when you press the KEYLESS-GO\* start/stop button once or twice without depressing the brake pedal. You will then only see high priority messages in the multifunction display (▷ page 449).

### Settings menu

In the Settings menu there are two functions:

- The function **Reset to factory settings?**, with which you can reset all the settings to the original factory settings.
  - A collection of submenus with which you can make individual settings for your vehicle.
- ▶ Press button  or  repeatedly until the **Settings** menu appears in the multifunction display.



The following settings and submenus are available in the Settings menu:

Function	Page
Resetting all settings	169
Submenus in the settings menu	170
Instrument cluster submenu	172
Time/Date submenu	174
Lighting submenu	175
Vehicle submenu	178
Comfort submenu*	181

### Resetting all settings

You can reset the functions of all submenus to the factory settings.

- ▶ Press the reset button in the instrument cluster (▷ page 152) for approximately 3 seconds.

The request to press the reset button once more to confirm appears in the multifunction display.



- ▶ Press the reset button once more.

The functions of all the submenus will reset to factory settings.

**i** The settings you have changed will not be reset unless you confirm the action by pressing the reset button a second time.

After approximately 5 seconds, the Settings menu reappears in the multifunction display (▷ page 168).

**i** For safety reasons, the function Lamp Circuit Headlamp in the Lighting submenu cannot be reset while driving.

The following message appears in the multifunction display:

Settings  
Cannot be  
completely reset  
to factory settings  
while driving.

### Control system

#### Submenus in the Settings menu



- ▶ Press button .



The collection of the submenus appears in the multifunction display.





- ▶ Press button .

The selection marker moves to the next submenu.

The submenus are arranged by hierarchy. Scroll down with button , scroll up with the button .

With the selection marker on the desired submenu, use the  button to access the individual functions within that submenu. Once within that submenu, you can use the  button to move to the next function or the  button to move to the previous function within that submenu.

The settings themselves are made with button  or .

The table below shows what settings can be changed within the various menus. Detailed instructions on making individual settings can be found on the following pages.

<b>Instrument cluster</b> (▷ page 172)	<b>Time/Date</b> (▷ page 174)	<b>Lighting</b> (▷ page 175)	<b>Vehicle</b> (▷ page 178)	<b>Comfort*</b> (▷ page 181)
Selecting speedometer display mode	Setting the time	Setting daytime running lamp mode (USA only)	Compass adjustment	Activating easy-entry/exit feature*
Selecting language	Setting the date	Setting locator lighting	Compass calibration	Setting fold-in function* for exterior rear view mirrors
Selecting display (digital speedometer or outside temperature) for status indicator		Setting night security illumination	Audio search function	
		Setting interior lighting delayed shut-off	Setting automatic central locking Limiting opening height of tailgate*	



## Control system

### Instrument cluster submenu

Access the Instrument Cluster submenu via the Settings menu. Use the Instrument Cluster submenu to change the instrument cluster display settings.

The following functions are available:

Function	Page
Selecting speedometer display mode	172
Selecting language	172
Selecting display (digital speedometer or outside temperature) for status indicator	173

### Selecting speedometer display mode

- ▶ Move the selection marker with button **+** or **-** to the Instrument Cluster submenu.
- ▶ Press button **▲** or **▼** repeatedly until the message Display Unit Digital Speedometer appears in the multifunction display.

The selection marker is on the current setting.



- ▶ Press button **+** or **-** to set speedometer unit to Km or Miles.

### Selecting language

- ▶ Move the selection marker with button **+** or **-** to the Instrument Cluster submenu.
- ▶ Press button **▲** or **▼** repeatedly until the message Language appears in the multifunction display.

The selection marker is on the current setting.

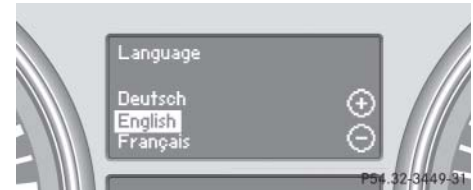

- ▶ Press button **+** or **-** to select the language to be used for the multifunction display messages.

**i** If you select a language that is not available in the COMAND system, the messages for the audio systems, such as radio or CD player, will appear in English, regardless of the language selected. For more information see separate COMAND operating instructions.

Available languages:

- German
- English
- French
- Italian
- Spanish
- Dutch
- Swedish
- Danish
- Turkish
- Portuguese
- Russian (Canada only)

**Selecting display (digital speedometer or outside temperature) for status indicator**

- ▶ Move the selection marker with button **+** or **-** to the Instrument Cluster submenu.
- ▶ Press button **↶** or **↷** repeatedly until the message Status Line Display appears in the multifunction display.

The selection marker is on the current setting.

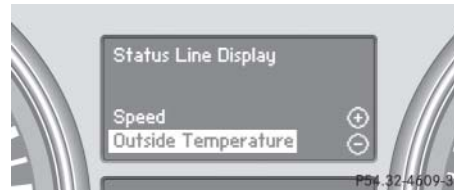

- ▶ Press button **+** or **-** to select the desired setting.

The selected display is then shown continuously in the status indicator (lower display).

The other display now appears in the menu of the standard display (> page 162):

- Digital speedometer  
or
- Outside temperature

## Control system

### Time/Date submenu

Access the Time/Date submenu via the Settings menu. Use the Time/Date submenu to change the time and date settings.

The following functions are available:

Function	Page
Setting the time	174
Setting the date	174

**i** If your vehicle is equipped with the COMAND system and navigation module\*, see separate COMAND system operating instructions for information on how to set the date and time.

### Setting the time

This function is not available if your vehicle is equipped with the COMAND system and navigation module\*.

- ▶ Move the selection marker with button **+** or **-** to the Time/Date submenu.
- ▶ Press button **▲** or **▼** repeatedly until the message **Clock Set Hour**, or **Clock Set Minute(s)** appears in the multifunction display.

The selection marker is on the hour setting.

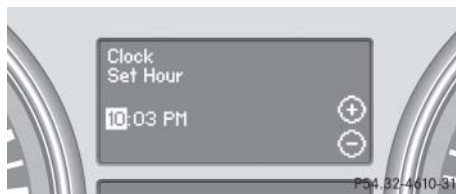

#### Example illustration for setting the hour

- ▶ Press button **+** or **-** to set the hour.

### Setting the date

This function is not available if your vehicle is equipped with the COMAND system and navigation module\*.

- ▶ Move the selection marker with button **+** or **-** to the Time/Date submenu.
- ▶ Press button **▲** or **▼** repeatedly until the message **Date Set Month**, **Date Set Day**, or **Date Set Year** appears in the multifunction display.

The selection marker is on the month setting.

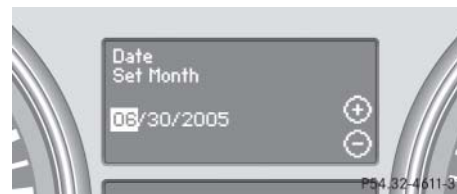

#### Example illustration for setting the month

- ▶ Press button **+** or **-** to set the month.

## Lighting submenu

Access the Lighting submenu via the Settings menu. Use the Lighting submenu to change the lamp and lighting settings on your vehicle.

The following functions are available:

Function	Page
Setting daytime running lamp mode (USA only)	175
Setting locator lighting	176
Setting night security illumination	176
Setting interior lighting delayed shut-off	177

### Setting daytime running lamp mode (USA only)

**i** This function is not available in countries where the daytime running lamp mode is mandatory and therefore in a constant mode.

- ▶ Move the selection marker with button **+** or **-** to the Lighting submenu.
- ▶ Press button **↶** or **↷** repeatedly until the message Lamp Circuit Headlamp appears in the multifunction display.

The selection marker is on the current setting.



- ▶ Press button **+** or **-** to select manual operation (Manual) or daytime running lamp mode (Constant).

With daytime running lamp mode activated and the exterior lamp switch in position **0** or **AUTO**, the low beam headlamps are switched on when the engine is running.

In low ambient light conditions the following lamps will switch on additionally:

- Parking lamps
- Tail lamps
- License plate lamps
- Side marker lamps

For more information on the daytime running lamp mode, see “Lighting” (▷ page 143).

**i** For safety reasons, changing the setting for the daytime running lamp mode is not possible while the vehicle is in motion. The following message appears in the multifunction display:

Settings  
can only be made  
at a standstill.

For safety reasons, resetting to factory settings (▷ page 169) while driving will not deactivate the daytime running lamp mode.

### Control system





#### Setting locator lighting

With the locator lighting feature activated, the exterior lamp switch in position **AUTO** (▷ page 143) and the interior lighting in automatic mode (▷ page 150), the following lamps will switch on during darkness when the vehicle is unlocked using button  on the SmartKey or SmartKey with KEYLESS-GO:

- Parking lamps
- Tail lamps
- License plate lamps
- Side marker lamps
- Front fog lamps



The locator lighting switches off when the driver's door is opened.

If you do not open a door after unlocking the vehicle with the SmartKey, the lamps will switch off automatically after approximately 40 seconds.

- ▶ Move the selection marker with button  or  to the Lighting submenu.
- ▶ Press button  or  repeatedly until the message Surround Lighting Function appears in the multifunction display.

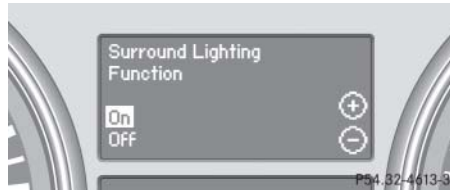
The selection marker is on the current setting.



- ▶ Press button  or  to switch the locator lighting function On or Off.
- ▶ Turn the exterior lamp switch to position **AUTO** when exiting the vehicle. The locator lighting feature is activated.

#### Setting night security illumination (Headlamps delayed shut-off)

Use this function to set whether you would like the exterior lamps to remain on for 15 seconds during darkness after exiting the vehicle and closing all doors.

With the headlamps delayed shut-off feature activated and the exterior lamp switch in position **AUTO** before the engine is turned off, the following lamps will switch on when the engine is turned off:

- Parking lamps
- Tail lamps
- License plate lamps
- Side marker lamps
- Front fog lamps

If after turning off the engine you do not open a door or do not close an opened door, the lamps will automatically switch off after 60 seconds.

- ▶ Move the selection marker with button **+** or **-** to the Lighting submenu.
- ▶ Press button **▲** or **▼** repeatedly until the message Headlamp Delayed Shut-off appears in the multifunction display.

The selection marker is on the current setting.



- ▶ Press button **+** or **-** to switch the headlamps delayed shut-off feature On or Off.

- ▶ Turn the exterior lamp switch to position **AUTO** before turning off the engine.

The headlamps delayed shut-off feature is activated.

You can temporarily deactivate the headlamps delayed shut-off feature:

- ▶ Before exiting the vehicle, turn the SmartKey in the starter switch to position **0**.
- ▶ Then turn it to position **2** and back to **0**.

The headlamps delayed shut-off feature is deactivated. It will reactivate as soon as you reinsert the SmartKey in the starter switch.

Vehicles with KEYLESS-GO\*:

- ▶ Press KEYLESS-GO start/stop button in the starter switch (▷ page 43).

### **Setting interior lighting delayed shut-off**

Use this function to set whether you would like the interior lighting to remain on for 10 seconds during darkness after you have removed the SmartKey from the starter switch.

- ▶ Move the selection marker with button **+** or **-** to the Lighting submenu.
- ▶ Press button **▲** or **▼** repeatedly until the message Interior Lighting Delayed Shut-off appears in the multifunction display.

The selection marker is on the current setting.



- ▶ Press button **+** or **-** to switch the interior lighting delayed shut-off feature On or Off.

## Control system

### Vehicle submenu

Access the **Vehicle** submenu via the **Settings** menu. Use the **Vehicle** submenu to make general vehicle settings.

The following functions are available:

Function	Page
Compass adjustment	178
Compass calibration	179
Audio search function	180
Setting automatic central locking	180
Limiting opening height of tailgate*	181

### Compass adjustment

This function is not available if your vehicle is equipped with the COMAND system and navigation module\*.

Determine your location on the basis of the following zone maps.

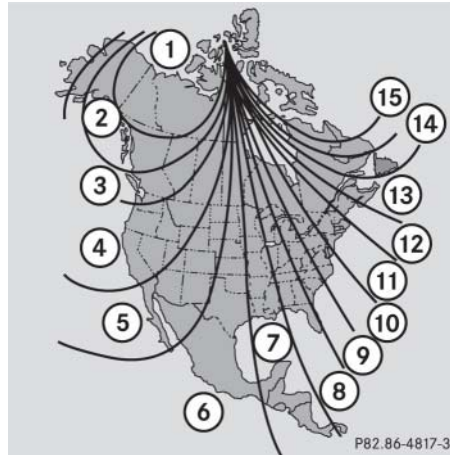

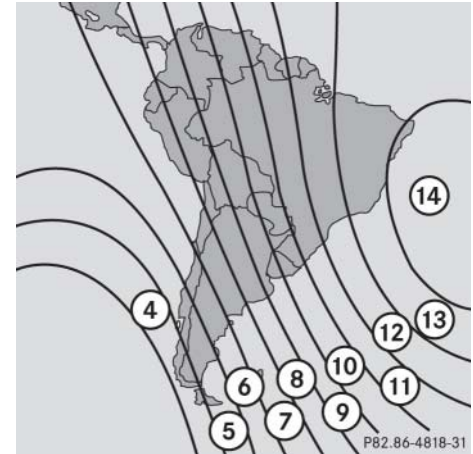

Zone map North America



Zone map South America

- ▶ Press button **+** or **-** to move the selection marker to the **Vehicle** submenu.

- ▶ Press button  or  repeatedly until the message **Compass Setting Zone** appears in the multifunction display.

The selection marker is on the current setting.

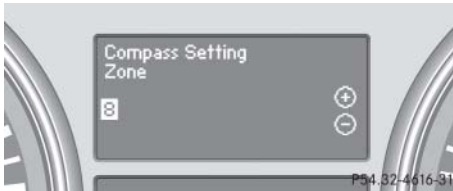

- ▶ Press button  or  to set the respective compass zone.



For information on how to call up the compass, see “Compass” (▷ page 344).



### Compass calibration

 *Make sure you are in area where you can drive a full circle with your vehicle without disturbing traffic in order to calibrate the compass.*

This function is not available if your vehicle is equipped with the COMAND system and navigation module\*.

In order to calibrate the compass properly, mind the following:

- Calibrate the compass in open terrain. Nearby buildings, bridges, power lines and large antenna masts, for example, could impair compass calibration.
- Switch off electrical consumers (e.g. climate control, windshield wipers, or rear window defroster).
- Close all doors and the tailgate.
- ▶ Start the engine (▷ page 56).
- ▶ Press button  or  to move the selection marker to the **Vehicle** submenu.

- ▶ Press button  or  repeatedly until the message **Compass Calibration** appears in the multifunction display.

The selection marker is on setting switched Off.

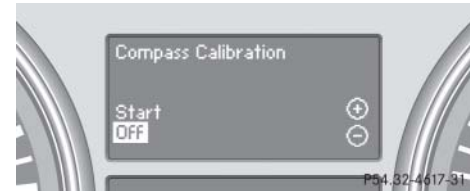

- ▶ Press button  to set the selection marker to **Start**.

The following message appears in the multifunction display:

Compass Calibration Active  
Please drive in a full circle. ▷▷



### Control system

- ▷▷ Drive a full circle at a vehicle speed of between 3 mph and 6 mph (5 km/h and 10 km/h).

When calibration was successful, the following message appears in the multifunction display:

Compass Calibration  
Completed Successfully

**i** If the message *Compass Calibration Completed Successfully* does not appear in the multifunction display, drive another full circle.

If calibration does not succeed within 3 minutes, the message *Compass Calibration* appears in the multifunction display again. Calibrating the compass has failed due to outside influences.

Repeat compass calibration in a different location.

### Audio search function

Use of the Audio search function to select a radio station will enable you to start a frequency scan (Frequency) (▷ page 164) or select a radio station stored in memory (Memory).

- ▶ Move the selection marker with button **+** or **-** to the Vehicle submenu.
- ▶ Press button **▲** or **▼** repeatedly until the message *Audio Search Function* appears in the multifunction display.

The selection marker is on the current setting.

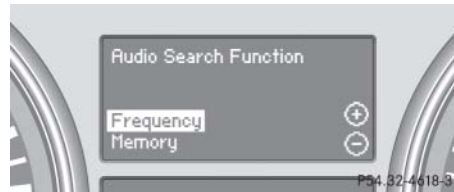

- ▶ Press button **+** or **-** to select Frequency or Memory.

### Setting automatic central locking

Use this function to activate or deactivate the automatic central locking. With the automatic central locking system activated, the vehicle is centrally locked at vehicle speeds of approximately 9 mph (15 km/h).

- ▶ Move the selection marker with button **+** or **-** to the Vehicle submenu.
- ▶ Press button **▲** or **▼** repeatedly until the message *Automatic Door Locking* appears in the multifunction display.

The selection marker is on the current setting.



- ▶ Press button **+** or **-** to switch the automatic central locking On or Off.

**Limiting opening height of tailgate \***

Use this function to activate or deactivate the limiting opening height of the tailgate.

- ▶ Move the selection marker with button **+** or **-** to the Vehicle submenu.
- ▶ Press button **↶** or **↷** repeatedly until the message **Opening Limiter Tailgate** appears in the multifunction display.

The selection marker is on the current setting.

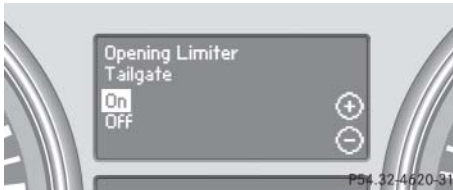

- ▶ Press button **+** or **-** to switch the limiting opening height of the tailgate **On** or **Off**.

**Comfort submenu \***

Access the **Comfort** submenu via the **Settings** menu. Use the **Comfort** submenu to change the settings for a number of convenience features.

The following functions are available:

Function	Page
Activating easy-entry/exit feature*	181
Setting fold-in function* for exterior rear view mirrors	182

**Activating easy-entry/exit feature \***

Use this function to activate and deactivate the easy-entry/exit feature (▷ page 48).

**Warning!**



You must make sure no one can become trapped or injured by the moving steering wheel when the easy-entry/exit feature is activated.

To stop steering wheel movement, do one of the following:

- Move steering wheel adjustment stalk\* (▷ page 50).
- Press one of the stored position buttons\* or the memory button **M**\* (▷ page 141).

Do not leave children unattended in the vehicle, or with access to an unlocked vehicle. Children could open the driver's door and unintentionally activate the easy-entry/exit feature, which could result in an accident and/or serious personal injury.

### Control system

- ▶ Move the selection marker with button **+** or **-** to the Comfort submenu.
- ▶ Press button **▲** or **▼** repeatedly until the message Easy-entry Function appears in the multifunction display.

The selection marker is on the current setting.

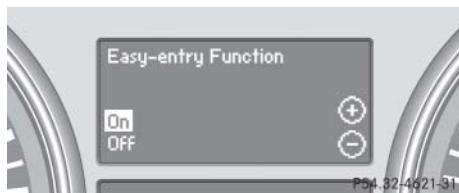

- ▶ Press button **+** or **-** to switch the easy-entry/exit feature On or Off.

### Setting fold-in function\* for exterior rear view mirrors

Using this function, you can set the exterior rear view mirrors to be automatically folded in when you lock your vehicle.

**i** With this function set to On and the exterior rear view mirrors folded in using the button on the door control panel (▷ page 209), the exterior rear view mirrors will not fold out when you switch on the ignition. You will then have to fold out the exterior rear view mirrors using the button on the door control panel (▷ page 209).

Make sure both exterior rear view mirrors are folded out completely before driving off.

- ▶ Move the selection marker with button **+** or **-** to the Comfort submenu.
- ▶ Press button **▲** or **▼** repeatedly until the message Fold In Mirrors When Locking appears in the multifunction display.

The selection marker is on the current setting.



- ▶ Press button **+** or **-** to switch function On or Off.



### Vehicle configuration

The following functions are available:

Function	Page
Distance warning function* on/off	183
DSR set speed	183



### Distance warning function\* (Canada only)

In vehicles equipped with Distronic\*, you can determine whether the distance warning function is to be enabled or disabled. With this function set to On, the system will alert you when recognizing a stationary obstacle or a slower vehicle moving in your vehicle's path and the danger of a collision exists, even when the Distronic\* is switched off.

- ▶ Press button  or  repeatedly until the message Distance Warning appears in the multifunction display.



The selection marker is on the current setting.

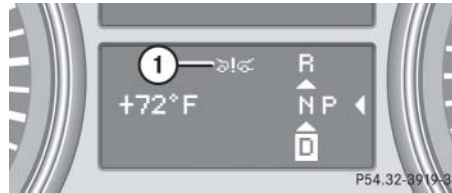

- ▶ Press button  or  to switch the distance warning function On or Off.





- ① Symbol for activated distance warning function

If the distance warning function is activated you will see the  symbol in the Standard display. When the distance warning function is deactivated the  symbol will not appear.

### DSR (Downhill Speed Regulation) programmed default speed

In the DSR menu, you can program the default speed the DSR is set to when it is activated.

You can program the default speed between 4-10 mph (Canada: 6-18 km/h). The set value is increased in 1 mph (Canada: 2 km/h) increments.

- ▶ Press button  or  repeatedly until the message DSR Speed appears in the multifunction display.

The selection marker is on the current setting.

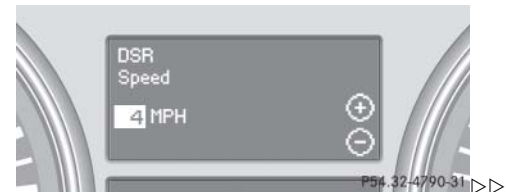

### Control system

- ▷▷ Press button **+** or **-** repeatedly until the desired speed is shown in the multifunction display.

When DSR is switched on, DSR will use the programmed default speed to regulate the vehicle's speed.

**i** Once DSR is switched on, you can adjust the set speed using the cruise control lever (▷ page 276).

### Trip computer menu

Use the trip computer menu to call up statistical data on your vehicle.

The following information is available:

Function	Page
Fuel consumption statistics since start	184
Fuel consumption statistics since last reset	185
Resetting fuel consumption statistics	185
Distance to empty	185

**i** When you enter the trip computer menu, you will always see the fuel consumption statistics since start first.

### Fuel consumption statistics since start

- ▶ Press button **☰** or **☷** repeatedly until the message **From Start** appears in the multifunction display.

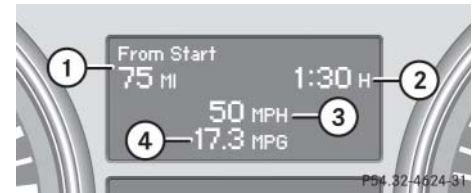





- ① Distance driven since start
- ② Time elapsed since start
- ③ Average speed since start
- ④ Average fuel consumption since start

**i** All statistics stored since the last engine start will be reset approximately 4 hours after the SmartKey in the starter switch is turned to position **0** or removed from the starter switch.

Resetting will not occur if you turn the SmartKey back to position **1** or **2** within this time period.



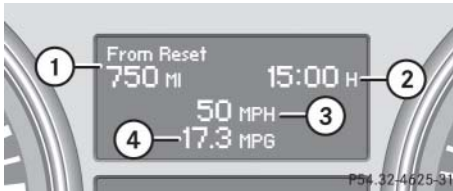

### Fuel consumption statistics since last reset

- ▶ Press button  or  repeatedly until the message From Start appears in the multifunction display.
- ▶ Press button  or  repeatedly until the message From Reset appears in the multifunction display.



- ① Distance driven since last reset
- ② Time elapsed since last reset
- ③ Average speed since last reset
- ④ Average fuel consumption since last reset





### Resetting fuel consumption statistics

- ▶ Press button  or  repeatedly until the message From Start appears in the multifunction display.
- ▶ Press button  or  repeatedly until the fuel consumption statistics which you want to reset appear in the multifunction display.
- ▶ Press and hold the reset button in the instrument cluster (▶ page 152) until the respective values are reset to 0.

**i** The fuel consumption statistics reset automatically to 0 when either of the following values is exceeded:

- distance covered: 100 000 miles
- time elapsed: 10 000 hours

### Distance to empty

- ▶ Press button  or  repeatedly until the message From Start appears in the multifunction display.
- ▶ Press button  or  repeatedly until the message Range: appears in the multifunction display.

The calculated remaining driving range based on the current fuel tank level appears in the multifunction display.

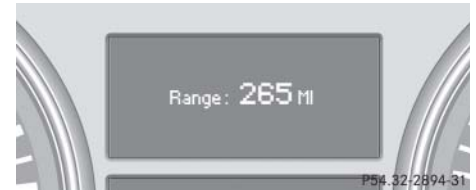

**i** If only very little fuel is left in the tank, a vehicle at the fuel pump is shown instead of the range.

## Control system

### TEL\* menu

#### Warning!





A driver's attention to the road must always be his/her primary focus when driving. For your safety and the safety of others, we recommend that you pull over to a safe location and stop before placing or taking a telephone call. If you choose to use the telephone while driving, please use the hands-free device and only use the telephone when weather, road and traffic conditions permit.

Some jurisdictions prohibit the driver from using a cellular telephone while driving a vehicle.

Bear in mind that at a speed of just 30 mph (approximately 50 km/h), your vehicle is covering a distance of 44 feet (approximately 14 m) every second.

Never operate radio transmitters equipped with a built-in or attached antenna (i.e. without being connected to an external antenna) from inside the vehicle while the engine is running. Doing so could lead to a malfunction of the vehicle's electronic system, possibly resulting in an accident and/or personal injury.

You can use the functions in the TEL menu to operate your telephone, provided it is connected to a hands-free system and switched on.

- ▶ Switch on the telephone and COMAND system.
- ▶ Press button  or  on the multifunction steering wheel repeatedly until the message TEL appears in the multifunction display.

Which messages will appear in the multifunction display depends on whether your telephone is switched on or off:

- If the telephone is off, the message TEL Off appears in the multifunction display.
- If the telephone is on:  
The telephone will then search for a network. During this time the multifunction display is empty.  
As soon as the telephone has found a network, the message Ready appears in the multifunction display.

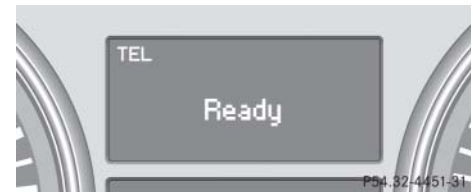

This standby message indicates that your telephone is ready for use and you can operate it using the control system.

### Answering a call

When your telephone is ready to receive calls, you can answer a call at any time. In the multifunction display you will then see the message, or if available, the caller ID (name and number):

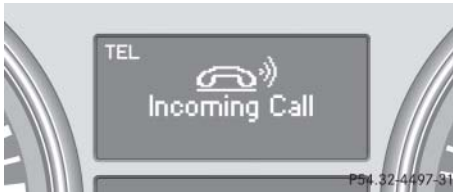

- ▶ Press button .





You have answered the call. The duration of the call appears in the multifunction display.

### Ending a call or rejecting an incoming call

- ▶ Press button .



### Dialing a number from the phone book

If your telephone is ready to receive calls, you may select and dial a number from the phone book at any time.

- ▶ Press button  or  repeatedly until the message TEL appears in the multifunction display.
- ▶ Press button  or .

The control system reads the phone book which is stored in the telephone. This may take several minutes. The message *Please Wait* appears in the multifunction display.



When the message *Please Wait* disappears, the phone book has been loaded.

- ▶ Press button  or  repeatedly until the desired name appears in the multifunction display.

The stored names are displayed in ascending or descending alphabetical order.



- ① Name from the phone book

**i** If you press and hold button  or  for longer than 1 second, the system scrolls rapidly through the list of names until you release the button again.

Cancel the quick search mode by pressing button .





### Control system

- ▷▷▶ Press button .

The system dials the selected phone number.

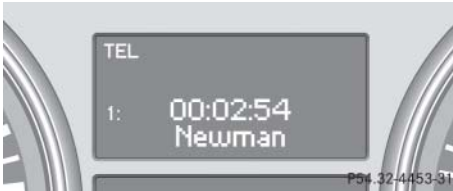

- If the connection is successful and this feature is supported by your network provider, the name of the party (if stored in your phone book) you are calling and the duration of the call will appear in the multifunction display.





- If no connection is made, the control system stores the dialed number in the redial memory.

### Redialing

The control system stores the most recently dialed phone numbers. This eliminates the need to search through your entire phone book.

- ▶ Press button  or  repeatedly until the message TEL appears in the multifunction display.
- ▶ Press button .

The first number in the redial memory appears in the multifunction display.

- ▶ Press button  or  repeatedly until the desired name appears in the multifunction display.
- ▶ Press button .

The control system dials the selected phone number.

## ▼ Automatic transmission

For more information on driving with an automatic transmission, see “Automatic transmission” (▷ page 56).

Your vehicle’s transmission adapts its gear shifting process to your individual driving style by continually adjusting the shift points up or down. These shift point adjustments are performed based on current operating and driving conditions.

If the operating conditions change, the automatic transmission reacts by adjusting its shift program.

**i** During the brief warm-up, transmission upshifting is delayed. This allows the catalytic converter (gasoline engine) or the oxidation catalyst (diesel engine) to heat up more quickly to operating temperature.

### Warning!



Make sure that absolutely no objects are obstructing the pedal’s range of movement. Keep the driver’s footwell clear of all obstacles. If there are any floor mats or carpets in the footwell, make sure that the pedals still have sufficient clearance.

During sudden driving or braking maneuvers the objects could get caught between the pedals. You could then no longer brake or accelerate. This could lead to accidents and injury.

### Gear selector lever

The gear selector lever is located on the right of the steering column.



### Gearshift pattern for automatic transmission

- P** Park position
- R** Reverse gear
- N** Neutral
- D** Drive position

### Automatic transmission

**i** The current transmission position **P**, **R**, **N**, or **D** appears in the multifunction display (▷ page 192).

#### Warning!



It is dangerous to shift the automatic transmission out of park position **P** or neutral position **N** if the engine speed is higher than idle speed. If your foot is not firmly on the brake pedal, the vehicle could accelerate quickly forward or reverse. You could lose control of the vehicle and hit someone or something. Only shift into gear when the engine is idling normally and when your right foot is firmly on the brake pedal.

#### Shifting from P to N

Moving the gear selector lever up or down shifts the automatic transmission out of park position **P**:

- ▶ With the vehicle at a standstill, depress the brake pedal and keep it pressed.
- ▶ Move gear selector lever up or down to resistance point to select neutral position **N**.

**i** The gear selector lever returns to its original position.

#### Shifting from N to R or from N to D

- ▶ With the vehicle at a standstill, depress the brake pedal and keep it pressed.
  - ▶ Move gear selector lever up past the resistance point to select reverse gear **R**.
- or
- ▶ Move gear selector lever down past the resistance point to select drive position **D**.

**i** The gear selector lever returns to its original position.

- ▶ Release the parking brake (▷ page 59).
- ▶ Release the brake pedal.
- ▶ Carefully depress the accelerator pedal to drive off when it is safe to do so.

### Shifting from P to R

- ▶ With the vehicle at a standstill, depress the brake pedal and keep it pressed.
- ▶ Move gear selector lever up past the resistance point to select reverse gear **R**.

**i** *The gear selector lever returns to its original position.*

- ▶ Release the parking brake (▷ page 59).
- ▶ Release the brake pedal.
- ▶ Carefully depress the accelerator pedal to drive off when it is safe to do so.

### Shifting from P to D

- ▶ With the vehicle at a standstill, depress the brake pedal and keep it pressed.
- ▶ Move gear selector lever down past the resistance point to select drive position **D**.

**i** *The gear selector lever returns to its original position.*

- ▶ Release the parking brake (▷ page 59).
- ▶ Release the brake pedal.
- ▶ Carefully depress the accelerator pedal to drive off when it is safe to do so.

### Shifting from D, R, or N to P

If you want to select park position **P** with the transmission being in drive position **D**, reverse gear **R** or neutral position **N**:

- ▶ With the vehicle at a standstill, depress the brake pedal and keep it pressed.
- ▶ Step firmly on parking brake pedal (▷ page 67).
- ▶ Press button on gear selector lever in direction of arrow (▷ page 189) to select park position **P**.
- ▶ Release the brake pedal.

**!** *Shift the automatic transmission directly from drive position **D** to reverse gear **R**, from reverse gear **R** to drive position **D** or directly to park position **P** only when the vehicle is stopped. Otherwise the automatic transmission could be damaged.*

*When trying to free a vehicle stuck in mud or snow, see “Rocking the vehicle” (▷ page 196).*

### Automatic transmission

#### Shifting from D or R to N

If you want to select neutral position **N** with the transmission being in drive position **D** or reverse gear **R**:

- ▶ With the vehicle at a standstill, depress the brake pedal and keep it pressed.
- ▶ Step firmly on parking brake pedal (▷ page 67).

**i** When the vehicle needs to be moved with the engine switched off and the transmission set to neutral position **N** (▷ page 192), do not depress the parking brake pedal.

- ▶ Move gear selector lever up to resistance point when in drive position **D** or down to resistance point when in reverse gear **R** to select neutral position **N**.
- ▶ Release the brake pedal.

#### Shifting procedure

The automatic transmission selects individual gears automatically, depending on:

- drive position **D** (▷ page 192) with gear ranges (▷ page 197)
- the position of the accelerator pedal (▷ page 195)
- the vehicle speed

**!** Allow engine to warm up under low load use. Do not place full load on the engine until the operating temperature has been reached.

Shift into reverse gear **R** or park position **P** only when the vehicle is stopped.

Avoid spinning of a drive wheel for an extended period when driving off on slippery road surfaces. This may cause serious damage to the drivetrain which is not covered by the Mercedes-Benz Limited Warranty.

With drive position **D** selected, you can use the steering wheel gearshift control buttons (▷ page 198) to influence transmission shifting by:

- limiting the gear range
- changing gears manually

#### Transmission positions

The current transmission position appears in the multifunction display.

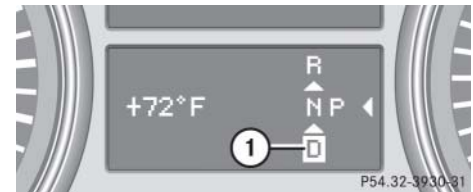

① Current transmission position

**!** If the current transmission position does not appear in the multifunction display due to a malfunction, for example, make sure that the automatic transmission is in the desired position by carefully driving off with the transmission in drive position **D**.

Do not limit the gear range.

	Effect
<b>P</b>	<p><b>Park position</b></p> <p>Shift into park position <b>P</b> only when vehicle is stopped. The park position is not intended to serve as a brake when the vehicle is parked. Rather, the driver should always set the parking brake in addition to shifting into park position <b>P</b> to secure the vehicle.</p> <p>If the vehicle's electrical system is malfunctioning, the automatic transmission could remain locked in park position <b>P</b>.</p> <ul style="list-style-type: none"> <li>▶ Have the vehicle checked as soon as possible by an authorized Mercedes-Benz Light Truck Center.</li> </ul>

**!** SmartKey:

*If you turn off the engine using the SmartKey and*

- *remove the SmartKey from the starter switch*
- or*
- *open a front door*

*the transmission will shift to park position **P** automatically.*

*Keep in mind that turning off the engine with the SmartKey alone only will automatically shift the transmission to neutral position **N**.*

**!** KEYLESS-GO\*:

*If you turn off the engine using the KEYLESS-GO start/stop button and open a front door, the transmission will shift to park position **P** automatically.*

*Keep in mind that turning off the engine using the KEYLESS-GO start/stop button alone only will automatically shift the transmission to neutral position **N**.*

**i** *Make it a practice to always shift into park position **P** before turning off the engine and*

- *remove the SmartKey from the starter switch*
- or*
- *open a front door*

*or when using KEYLESS-GO\*, before turning off the engine with the start/stop button and opening a front door.*

## Automatic transmission

	Effect
<b>R</b>	<b>Reverse gear</b> Shift into reverse gear <b>R</b> only when the vehicle is stopped.
<b>N</b>	<b>Neutral</b> No power is transmitted from the engine to the drive axle. When the brakes are released, the vehicle can be moved freely (pushed or towed). To avoid damage to the transmission, never shift into neutral position <b>N</b> while driving. If the ESP <sup>®</sup> is deactivated or malfunctioning: Shift into neutral position <b>N</b> only if the vehicle is in danger of skidding, e.g. on icy roads.

**!** *If you turn off the engine using the SmartKey or the KEYLESS-GO\* start/stop button, the transmission will shift to neutral position **N** automatically.*

If you want the gear position to remain in neutral position **N**, e.g. when taking the vehicle through an automatic conveyor type car wash, observe the following instructions.

### Warning!



When leaving the SmartKey or SmartKey with KEYLESS-GO\* in the starter switch, do not leave children unattended in the vehicle. It is possible for children to switch on the ignition which could result in unsupervised use of vehicle equipment.  
A child's unsupervised access to a vehicle could result in an accident and/or serious personal injury.

Vehicles with SmartKey:

- ▶ With the vehicle at a standstill and the ignition switched on shift the automatic transmission to neutral position **N**.
- ▶ If engaged, release the parking brake (▷ page 59).
- ▶ Switch off the ignition and leave the SmartKey in the starter switch.

Vehicles with KEYLESS-GO\*:

- ▶ With the vehicle at a standstill, depress the brake pedal and keep it pressed.
- ▶ With the ignition switched on shift the automatic transmission to park position **P**.
- ▶ Release the brake pedal.
- ▶ Remove the KEYLESS-GO\* start/stop button from the starter switch (▷ page 43).

- ▶ Insert the SmartKey with KEYLESS-GO\* into the starter switch.
- ▶ Switch on the ignition.
- ▶ Depress the brake pedal.
- ▶ Shift the automatic transmission to neutral position **N**.
- ▶ Release the brake pedal.
- ▶ If engaged, release the parking brake (▷ page 59).
- ▶ Switch off the ignition and leave the SmartKey with KEYLESS-GO\* in the starter switch.

**!** *Observe instructions*

- *when taking the vehicle through an automatic conveyor type car wash (▷ page 428)*
- *when towing the vehicle (▷ page 538)*

**!** *Coasting the vehicle, or driving for any other reason in neutral position **N** can result in transmission damage that is not covered by the Mercedes-Benz Limited Warranty.*

### Effect

#### **D** Drive

The transmission shifts automatically. All forward gears are available.

### Warning!



Getting out of your vehicle without shifting into park position **P** is dangerous. Also, park position **P** alone is not intended to or capable of preventing your vehicle from moving, possibly hitting people or objects.

Always set the parking brake in addition to shifting to position **P** (▷ page 67).

When parked on an incline, turn the front wheels towards the road curb.

Do not park this vehicle in areas where combustible materials such as grass, hay or leaves can come into contact with the hot exhaust system, as these materials could be ignited and cause a vehicle fire.

### Warning!



When leaving the vehicle, always remove the SmartKey or SmartKey with KEYLESS-GO\* from the starter switch, take it with you, and lock the vehicle. Do not leave children unattended in the vehicle, or with access to an unlocked vehicle. Children could shift the automatic transmission out of park position **P**, which could result in an accident and/or serious personal injury.

### Driving tips

#### Accelerator position

Your driving style influences the transmission's shifting behavior:

Less throttle	Earlier upshifting
More throttle	Later upshifting



### Automatic transmission

#### Kickdown

Use kickdown when you want maximum acceleration.

- ▶ Press the accelerator past the point of resistance.

Depending on the engine speed the transmission shifts into a lower gear.

- ▶ Ease on the accelerator when you have reached the desired speed.

The transmission shifts up again.

#### Stopping

When you stop briefly, e.g. at traffic lights:

- ▶ Leave the transmission in gear.
- ▶ Hold the vehicle with the brake.

When you stop for a longer period of time with the engine idling and/or on a hill:

- ▶ Set the parking brake.
- ▶ Shift into park position **P**.

#### Maneuvering

When you maneuver in tight areas, e.g. when pulling into a parking space:

- ▶ Control the vehicle speed by gradually releasing the brakes.
- ▶ Accelerate gently.
- ▶ Never abruptly step on the accelerator.

#### Rocking the vehicle

Rocking the vehicle by shifting between drive position **D** and reverse gear **R** can help free a vehicle stuck in mud or snow. The engine control system of this vehicle electronically limits shifting between drive position **D** and reverse gear **R** to very low speeds, i.e. approximately 5 mph (9 km/h). To shift between drive position **D** and reverse gear **R**, move the gear selector lever past the resistance point up or down.

#### Working on the vehicle

##### Warning!



When working on the vehicle, set the parking brake and shift to park position **P**. Otherwise the vehicle could roll away.

#### Hill start assist system

##### Warning!



The hill start assist system is not designed to function as a parking brake and does not prevent the vehicle from moving when parked on an incline.

Always set the parking brake in addition to shifting to park position **P**.

On uphill grades with a gradient angle of more than 5°, the hill start assist system maintains the pressure in the brake system for approximately 1 second after you have released the brake pedal. Therefore, you can start off smoothly without the vehicle moving immediately after releasing the brake pedal.

The hill start assist system is inactive

- when starting off on a level road or downhill grades
- with the transmission in neutral position **N**
- with the parking brake set
- if the ESP® has switched off due to a malfunction

### Towing a trailer

If you tow a trailer, note the following points:

- Manually shift to a lower gear range (▷ page 197) if the transmission hunts between gears on inclines.

A lower gear range and reduction of speed reduces the chance to overload or overheat the engine.

For more information on trailer towing, see the “Operation” section (▷ page 364).

### Gear ranges

With the automatic transmission in drive position **D**, you can select a gear range for the automatic transmission to operate within.

You can limit the gear range by pressing the left gearshift button on the steering wheel gearshift control, and reverse the gear range limit by pressing the right gearshift button on the steering wheel gearshift control (▷ page 198).

The selected gear range appears in the multifunction display.



① Current gear range

	Effect
<b>6</b>	The transmission shifts through sixth gear only.
<b>5</b>	The transmission shifts through fifth gear only.
<b>4</b>	The transmission shifts through fourth gear only.
<b>3</b>	The transmission shifts through third gear only.  With this selection you can use the braking effect of the engine.

## Automatic transmission

	Effect
<b>2</b>	<p>The transmission shifts through second gear only.</p> <p>Allows the use of engine's braking power when driving:</p> <ul style="list-style-type: none"><li>• on steep downgrades</li><li>• in mountainous regions</li><li>• under extreme operating conditions</li></ul>
<b>1</b>	<p>The transmission operates in first gear only.</p> <p>For maximum use of engine's braking effect on very steep or lengthy downgrades.</p>

### Steering wheel gearshift control

With drive position **D** selected, you can limit or extend the gear range.

**!** Allow engine to warm up under low load use. Do not place full load on the engine until the operating temperature has been reached.

Shift into reverse gear **R** or park position **P** only when the vehicle is stopped.

Avoid spinning of a drive wheel for an extended period when driving off on slippery road surfaces. This may cause serious damage to the drivetrain which is not covered by the Mercedes-Benz Limited Warranty.



- ① Left button: limiting gear range or downshift
- ② Right button: extending gear range or upshift

**i** You cannot shift with the steering wheel gearshift buttons when the transmission is in position **P**, **N** or **R**.

## Downshifting

### Warning!



On slippery road surfaces, never downshift in order to obtain braking action. This could result in drive wheel slip and reduced vehicle control. Your vehicle's ABS will not prevent this type of loss of control.

- ▶ Briefly press left shift button ①.

The transmission will shift to the next lower gear as permitted by the shift program. This action simultaneously limits the gear range of the automatic transmission (▷ page 197).

**i** To avoid overrevving the engine when downshifting, the transmission will not shift to a lower gear if the engine's max. speed would be exceeded.

## Upshifting

- ▶ Briefly press right shift button ②.

The transmission will shift to the next higher gear as permitted by the shift program. This action simultaneously extends the gear range of the automatic transmission (▷ page 197).

**i** If you press on the accelerator when the engine has reached its rpm limit, the transmission will upshift beyond any gear range limit selected.

## Canceling gear range limit

- ▶ Press and hold right shift button ② until the cipher for the current gear range disappears from the multifunction display (▷ page 197).

The transmission will shift from the current gear range directly to gear range **D**.

## Shifting into optimal gear range

- ▶ Press and hold left shift button ①.

The transmission will automatically select the gear range suited for optimal acceleration and deceleration. This will involve shifting down one or more gears.

### Automatic transmission

#### Emergency operation (Limp-Home Mode)

---

If vehicle acceleration becomes less responsive or sluggish or the transmission no longer shifts, the transmission is most likely operating in limp-home (emergency operation) mode. In this mode only second gear and reverse gear can be activated.

- ▶ Stop the vehicle in a safe location.
- ▶ Shift to park position **P**.
- ▶ Turn off the engine.
- ▶ Wait at least 10 seconds before restarting.
- ▶ Restart the engine.
- ▶ Shift to drive position **D** (for second gear) or reverse gear **R**.
- ▶ Have the transmission checked at an authorized Mercedes-Benz Light Truck Center as soon as possible.

▼ **Transfer case**

**!** *Operational or performance test must only be conducted on a two-axle dynamometer. If such tests are necessary, contact an authorized Mercedes-Benz Light Truck Center. You could otherwise seriously damage the brake system or the transfer case which is not covered by the Mercedes-Benz Limited Warranty.*

**!** *Because the ESP® operates automatically, the engine and ignition must be shut off (SmartKey in starter switch position **0** or **1** or KEYLESS-GO\* start/stop button in position **0** or **1**) when testing the parking brake on a brake test dynamometer and such testing should be no longer than 10 seconds.*

*Active braking action through the ESP® may otherwise seriously damage the brake system which is not covered by the Mercedes-Benz Limited Warranty.*

**i** *The vehicle is equipped with permanent four-wheel drive. Both the front and rear axles are powered at all times when the vehicle is being operated.*

**LOW RANGE mode\***

The LOW RANGE mode is available on vehicles with enhanced off-road package\*.

In the following situations you should switch to LOW RANGE mode:

- during off-road driving (▷ page 355)
- when crossing water (▷ page 360)
- when towing up or down on steep gradients

With the LOW RANGE selected, the engine’s power delivery and the shifting behavior of the automatic transmission are adjusted. Furthermore, the ABS, ESP® and 4-ETS functions especially adapted to off-road travel are activated.

For information on driving safety systems during LOW RANGE mode, see “Driving safety systems” (▷ page 101).

For more information on Off-road driving, see “Off-road driving” (▷ page 355).

**Gear Ranges**

There are two possible settings.

<b>HIGH RANGE</b>	Road position for all normal driving situations. (LOW RANGE mode off)
<b>LOW RANGE</b>	Off-road position for traveling on rough terrain. (LOW RANGE mode on)  Also use the off-road position when driving on-road on steep gradients, especially when towing a trailer.  LOW RANGE acts by raising the engine’s gear ratio. The vehicle travels at roughly third the speed compared to when in the HIGH RANGE position, leading to an increase in the engine’s drive power.

## Transfer case

### Warning!



Always wait until the procedure of shifting from HIGH RANGE to LOW RANGE – and from LOW RANGE to HIGH RANGE – has been entirely completed. During this procedure do not:

- switch off the engine
- shift the automatic transmission into another gear

If you do not wait until the shifting procedure has been entirely completed then it might not be correctly performed. The transfer case might be in neutral, thus interrupting the transfer of power between the engine and the drive axle.

The vehicle is then freely movable, even if a gear has been selected, and could unintentionally be set into motion – particularly on up – or downhill grades. This could lead to an accident and cause injury to yourself and others.

Please observe related messages appearing in the multifunction display (▷ page 488).

### Switching LOW RANGE mode

The switch is located on the upper part of the center console.



- ① LOW RANGE switch
- ② Indicator lamp

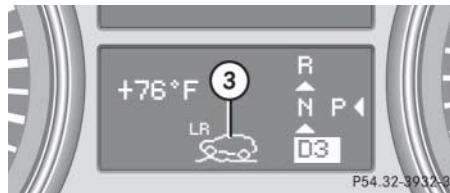

- ③ LOW RANGE display

### Switching LOW RANGE mode on (switching from HIGH RANGE to LOW RANGE)

**!** The shift procedure can only be performed when the following conditions are met:

- The engine is running (▷ page 41).
- The automatic transmission is in position **N** (▷ page 190).
- The vehicle speed does not exceed 25 mph (40 km/h).

**i** There is no reset to HIGH after the ignition has been switched off.

▶ Press LOW RANGE switch ①.

Indicator lamp ② flashes.

If the system senses that all conditions are met, it will switch to LOW RANGE mode. A chime sounds and the LOW RANGE display ③ appears in the multifunction display.

The indicator lamp ② on the LOW RANGE switch comes on continuously, indicating that the LOW RANGE mode has been activated.

**i** You can cancel the procedure by pressing the LOW RANGE switch again while the indicator lamp is flashing.

### **Switching LOW RANGE mode off (switching from LOW RANGE to HIGH RANGE)**

**!** The shift procedure can only be performed when the following conditions are met:

- The engine is running (▷ page 41).
- The automatic transmission is in position **N** (▷ page 190).
- The vehicle speed does not exceed 43 mph (70 km/h).

**i** There is no reset to LOW after the ignition has been switched off.

- ▶ Press LOW RANGE switch ① (▷ page 202).

Indicator lamp ② flashes.

If the system senses that all conditions are met, it will switch to back to HIGH RANGE mode. A chime sounds and the LOW RANGE display ③ appears in the multifunction display.

The indicator lamp ② on the LOW RANGE switch goes out, indicating that the LOW RANGE mode has been deactivated.

**i** You can cancel the procedure by pressing the LOW RANGE switch again while the indicator lamp is flashing.

For messages in the multifunction display, see “Practical hints” section (▷ page 488).



### Differential locks\*

For more information on Off-road driving, see “Off-road driving” (▷ page 355).

Vehicles with enhanced off-road package\* are equipped with automatic locks for the center and rear axle differential to improve vehicle traction.

- The center differential compensates for differences in wheel rotation between the front and rear axle.
- The rear axle differential compensates differences between the rear wheels.

**i** *At the front axles, the 4-ETS system (▷ page 107) compensates for any traction problems.*

### A few words about differentials and differential locks\*

When a vehicle negotiates a turn, wheels on the outside of the curve must travel farther and rotate faster than the inside wheels. The differential, the operation of a set of gears that allows the powered wheels in a vehicle to turn at different speeds, makes this essential function possible.

The drawback is that the differential also sends most of the engine’s power to the wheel with the least load or strain on it. For example, if one of a vehicle’s powered wheels sits on a patch of snow and spins because there is no traction, all of the engine’s power will go to that wheel because the power will take the path of least resistance. Meanwhile, the opposite wheel, sitting on dry pavement where it could get enough grip to start the vehicle moving, sits idle because it receives no power.

The Electronic Traction System (ETS) addresses this problem and provides for good control and steering ability by automatically slowing the slipping wheel and thus increasing the power to the other non-slipping drive wheels to get the vehicle moving. The ESP® and ETS in this vehicle feature such intelligent limited-slip differential technology, ideally suited for on-road and light off-road driving. Transfer case position LOW (▷ page 201) also enhances off-road driving capabilities (▷ page 355).

More extreme off-road conditions may call for another solution, engaging a differential lock or preventing the differential from operating altogether. This vehicle comes with two differential locks: transfer case (center) and rear. Each can be engaged simply by operating a rotary switch located on the center console (▷ page 205). When the transfer case (center) differential is locked, the combined (or average) speed of the front wheels is identical to the combined rear wheel speed. When the rear differential is locked, both rear wheels turn

at the same speed, independent of the individual torque. Please be aware that engaging the differential locks will significantly reduce the steering ability of the vehicle.

For your safety and the safety of others and to prevent damage to the vehicle, the differential locks must not be engaged when driving on paved roads. It is important to understand that during on-road/paved driving, differentials are absolutely necessary for providing the essential control and steering ability of the vehicle. The differential locks, therefore, must not be engaged when driving on paved roads and should only be used to the extent necessary to negotiate off-road conditions which cannot be handled by the systems (automatic 4-ETS, the ESP®, manual switch position “LOW” of transfer case) this vehicle comes equipped with.

### Switching differential locks\*

**!** *If the differential locks are engaged, accelerate gently when setting the vehicle in motion.*

*To avoid damage to the transmission, the vehicle may only be operated on a dynamometer (single axle dynamometer) if*

- *the axle not being driven is jacked up*
- or
- *the associated propeller shaft is disconnected.*

The rotary switch for the differential locks is located on the upper part of the center console.

You can select between three locking modes.



- ① Rotatable outer adjustment ring with indicator lamp
- ② AUTO mode: center differential is automatically locked
- ③ Center differential is completely locked
- ④ Center and rear axle differential are completely locked

### Differential locks\*

#### AUTO mode

The AUTO mode is adequate for most driving situations since the center differential is locked and released as required.

**i** At speeds up to 19 mph (30 km/h), it is possible to manually lock the differential locks for driving on rough terrain.

- ▶ Start the engine (▷ page 42).

The center differential locks is in AUTO mode. The indicator lamp on the adjustment ring ① above symbol **AUTO** ② is on.

#### Center and rear axle differential locks

##### Warning!



Never drive on a paved surface with the center and rear axle differential locks manually engaged. Ability to steer the vehicle is greatly reduced when the differential locks are manually engaged, increasing the risk of an accident.

For safety reasons, the locks are automatically released at a vehicle speed above 31 mph (50 km/h). Nevertheless, you should only manually lock the differential if absolutely necessary because engaged locks will restrict the vehicle drive train while cornering and cause the vehicle to chatter. This could cause you to lose control of the vehicle and cause an accident.

**!** The differential locks must not be engaged manually when towing the vehicle or spinning the wheels.

The differential locks should only be engaged manually if traction is insufficient in AUTO mode.

The differential locks can be engaged in the sequence ③, ④ (▷ page 205) up to a speed of 19 mph (30 km/h).

Engaging differential locks:

- for off-road driving
- for driving through water
- when driving on deep snow and icy or fouled surfaces

- ▶ Start the engine (▷ page 42).
- ▶ To select the required locking mode, rotate adjustment ring ② to the desired position ③ or ④ (▷ page 205).

The indicator lamp on the adjustment ring ① at the respective symbol comes on.



#### Example illustration

- ⑤ Center differential is completely locked

**!** *If the differential locks have been manually engaged, the tires will scuff on the road surface when cornering because the differences between the individual wheel rotation speeds will not be compensated for.*

**i** *The differential locks are reset to AUTO mode after the ignition has been switched off for longer than 10 seconds.*

### Good visibility

For information on windshield wipers, see “Windshield wipers” (▷ page 62).

#### Headlamp cleaning system\*

The headlamps will automatically be cleaned with a high-pressure water jet when you have

- switched on the headlamps and
- operated the windshield wipers with windshield washer fluid five times

When you switch off the headlamps, the counter resets.

For information on filling up the washer reservoir, see “Windshield/rear window washer system and headlamp cleaning system\*” (▷ page 383).

#### Rear view mirrors

For more information on setting the rear view mirrors, see “Mirrors” (▷ page 51).

#### Interior rear view mirror, antiglare position



① Lever

- ▶ Tilt the mirror to the antiglare position by moving lever ① towards the windshield.

The interior rear view mirror is dimmed.

#### Auto-dimming rear view mirrors\*

The reflection brightness of the exterior rear view mirror on the driver's side and the interior rear view mirror will respond automatically to glare when

- the ignition is switched on and
- incoming light from headlamps falls on the sensor in the interior rear view mirror

The rear view mirror will not react if

- the automatic transmission is set to position **R**
- the interior lighting is turned on

**Warning!**

The auto-dimming function does not react if incoming light is not aimed directly at sensors in the interior rear view mirror.

The interior rear view mirror and the exterior rear view mirror on the driver's side do not react, for example, when transporting cargo which covers the rear window.

Light hitting the mirror(s) at certain angles (incident light) could blind you. As a result, you may not be able to observe traffic conditions and could cause an accident.

**Warning!**

Exercise care when using the passenger-side exterior rear view mirror. The mirror surface is convex (outwardly curved surface for a wider field of view). Objects in mirror are closer than they appear. Check your interior rear view mirror or glance over your shoulder before changing lanes.

**Power folding exterior rear view mirrors\***

**!** *Before you drive the vehicle through an automatic car wash, fold the exterior rear view mirrors in. Otherwise they may get damaged.*

**Folding the exterior rear view mirrors in and out automatically**

When the corresponding function in the control system is activated (▷ page 182):

- The exterior rear view mirrors automatically fold in as soon as the vehicle is locked from the outside.
- The exterior rear view mirrors automatically fold out as soon as the vehicle is unlocked and the driver's or front passenger door are subsequently opened.

**Synchronizing exterior rear view mirrors**

The power folding rear view mirrors may have to be synchronized after the vehicle battery has been disconnected or discharged. If the exterior rear view mirrors do not fold properly upon locking or unlocking the vehicle although the corresponding function in the control system is activated (▷ page 182), do the following:

- ▶ Fold each exterior rear view mirror in completely (▷ page 210).
- ▶ Fold each exterior rear view mirror out completely (▷ page 210).

When the exterior rear view mirrors fold properly upon locking the vehicle, the exterior mirrors are synchronized. Otherwise repeat the above steps.

### Good visibility

#### Folding the exterior rear view mirrors in and out manually

**i** The exterior rear view mirrors can vibrate if they are not folded out completely.

The button is located on the door control panel.

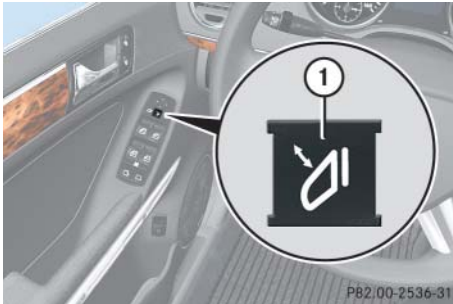

- ① Button for folding exterior rear view mirrors in and out
- ▶ Switch on the ignition (▷ page 42).

#### Folding in

- ▶ Briefly press button ①.

Both exterior rear view mirrors fold in.

**i** If you are driving at more than approximately 30 mph (47 km/h), you will not be able to fold the exterior mirrors in.

#### Folding out

- ▶ Briefly press button ① again.

Both exterior rear view mirrors fold out.

**!** If an exterior rear view mirror housing is forcibly pushed forward (hit from the rear) or forcibly pushed rearward (hit from the front) press button ① to fold mirrors in, then press button ① again to fold mirrors out. Do not force mirrors by hand as this may damage the adjustment mechanism.

*The mirror housing is then properly positioned and you can adjust the mirror in the usual manner.*

*Please make sure both rear view mirrors are folded out before driving off.*

#### Sun visors

The sun visors protect you from sun glare while driving.

#### Warning!



Do not use the vanity mirror while driving.

Keep the mirrors in the sun visors closed while vehicle is in motion. Reflected glare can endanger you and others.

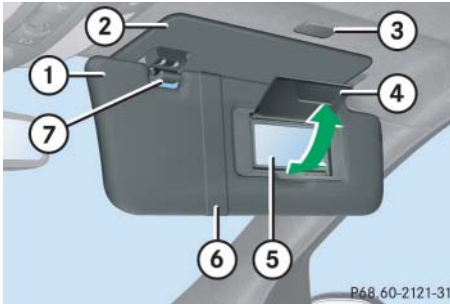

- ① Sun visor
- ② Additional sun visor\*
- ③ Mirror lamp
- ④ Vanity mirror cover
- ⑤ Vanity mirror
- ⑥ Holder for gas cards
- ⑦ Mounting

### Glare through the windshield

- ▶ Swing sun visor ① down.
- ▶ Make sure sun visor ① is properly engaged in mounting ⑦.
- ▶ When you do not experience glare anymore, swing sun visor ① up.

### Vanity mirror

- ▶ Swing sun visor ① down.
- ▶ Flip up cover ④ to access vanity mirror ⑤.  
Vanity mirror lamp ③ comes on.
- ▶ After using vanity mirror ⑤, flip down cover ④.
- ▶ Swing sun visor ① up.

### Glare through a side window

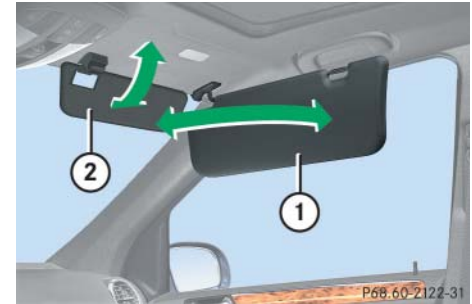

- ① Sun visor
- ② Additional sun visor\*
- ▶ Swing sun visor ① down.
- ▶ Disengage sun visor ① from mounting ⑦ (▷ page 211).
- ▶ Pivot sun visor ① to the side.





### Good visibility

▷▷ **!** To avoid damage to vanity mirror cover ④ (▷ page 211), make sure it is closed before pivoting sun visor ① to the side.

- ▶ Adjust sun visor ① by pushing or pulling in the direction of arrows.
- ▶ Swing down additional sun visor\* ② when you experience additional glare through the windshield.

### Rear panorama roof sunshade

The rear panorama roof sunshade over the third-row seats prevents the sun from shining directly into the vehicle.

You can open and close the sunshade by hand.

**!** Always guide the sunshade. Do not let it snap back abruptly, as it could be damaged.

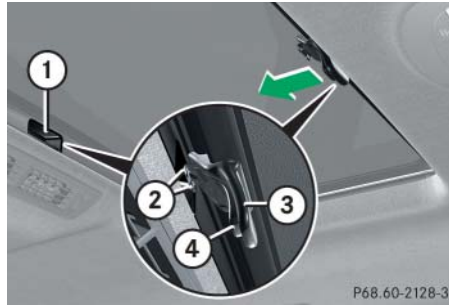

- ① Mounting
- ② Clip
- ③ Handle
- ④ Button

### Closing

- ▶ Grasp on handle ③ and insert clips ② into mounting ①.

The third-row sunshade engages.

### Opening

- ▶ Press on button ④ to disengage the third-row sunshade from mounting ①.

### Rear window defroster

The rear window defroster uses a large amount of power. To keep battery drain to a minimum, switch off the defroster as soon as the rear window is clear. The defroster is automatically deactivated after approximately 6 to 17 minutes of operation depending on the outside temperature.

### Warning!



Any accumulation of snow and ice should be removed from the rear window before driving. Visibility could otherwise be impaired, endangering you and others.

- ▶ Switch on the ignition (▷ page 42).

## Activating

- ▶ Press button  on the climate control panel (▷ page 216) or the automatic climate control\* panel (▷ page 230).

The indicator lamp on the button comes on.

## Deactivating

- ▶ Press button  once more.

The indicator lamp on the button goes out.

**!** *If the rear window defroster switches off too soon and the indicator lamp starts flashing, too many electrical consumers are operating simultaneously and there is insufficient voltage in the battery. The system responds automatically by switching the rear window defroster off.*

*As soon as the battery has sufficient voltage, the rear window defroster switches back on automatically.*





- ① Driver's door air vent, fixed
- ② Left side air vent, adjustable
- ③ Thumbwheel for air volume control for left side and door air vent
- ④ Windshield air vents
- ⑤ Thumbwheel for air volume control for left center air vent
- ⑥ Left center air vent, adjustable
- ⑦ Right center air vent, adjustable
- ⑧ Thumbwheel for air volume control for right center air vent
- ⑨ Thumbwheel for air volume control for right side and door air vent
- ⑩ Right side air vent, adjustable
- ⑪ Front passenger door air vent, fixed
- ⑫ Climate control panel
- ⑬ Footwell air vents

**i** For draft-free ventilation, move the sliders for center air vents and side air vents to the middle position.

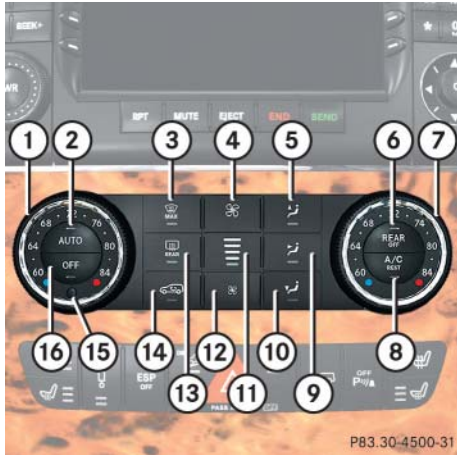
## Climate control



- |   |   |   |  |
|---|---|---|--|
| ① | Temperature control, left   | ⑧ | AC cooling on/off<br>Residual heat/ventilation                             |
| ② | Air distribution and air volume<br>(automatic, manual)  | ⑨ | Air distribution (directs air through<br>center and side air vents)        |
| ③ | Front defroster   | ⑩ | Air distribution (directs air through<br>the footwells and side air vents) |
| ④ | Increasing air volume   | ⑪ | Air volume display   |
| ⑤ | Air distribution (directs air through<br>the windshield and side air vents)                   | ⑫ | Decreasing air volume  |
| ⑥ | Rear climate control* on/off<br>Air supply for rear passenger<br>compartment on/off           | ⑬ | Rear window defroster  |
|   |  USA only    | ⑭ | Air recirculation  |
|   |  Canada only | ⑮ | Interior temperature sensor  |
| ⑦ | Temperature control, right  | ⑯ | Climate control on/off   |

The climate control is operational whenever the engine is running. You can operate the climate control system in either the automatic or manual mode. The system cools or heats the interior depending on the selected interior temperature and the current outside temperature.

**Warning!**

When operating the climate control, the air that enters the passenger compartment through the air vents can be very hot or very cold (depending on the set temperature). This may cause burns or frostbite to unprotected skin in the immediate area of the air vents.

Always keep sufficient distance between unprotected parts of the body and the air vents. If necessary, use the air distribution controls (▷ page 216) to direct the air to air vents in the vehicle interior that are not in the immediate area of unprotected skin.

Nearly all dust particles, pollutants and odors are filtered out before outside air enters the passenger compartment through the air distribution system.

**Warning!**

Severe conditions (e.g. strong air pollution) may require replacement of the filter before its scheduled interval. A clogged filter will reduce the air volume to the interior and the windows could fog up, impairing visibility and endangering you and others. Have a clogged filter replaced as soon as possible at an authorized Mercedes-Benz Light Truck Center.

The air conditioning will not engage (no cooling) if the **A/C** mode is deactivated (▷ page 224).

**Warning!**

Follow the recommended settings for heating and cooling given on the following pages. Otherwise the windows could fog up, impairing visibility and endangering you and others.

**i** *If the vehicle interior is hot, ventilate the interior before driving off, see “Summer opening feature” (▷ page 249). The climate control will then adjust the interior temperature to the set value much faster.*

*Keep the air intake grille in front of the windshield free of snow and debris.*

### Climate control

#### Deactivating the climate control system

##### Warning!



When the climate control system is switched off, the outside air supply and circulation are also switched off. Only choose this settings for a short time. Otherwise the windows could fog up, impairing visibility and endangering you and others.

#### Deactivating

- ▶ Press button **OFF** (▷ page 216).

The indicator lamp on the button comes on.

#### Reactivating

- ▶ Press button **AUTO** (▷ page 216).

**i** You can also press button **OFF** (▷ page 216) on the climate control panel.

If you press button  (▷ page 216) to reactivate the climate control system, the defrosting mode is activated.

#### Operating the climate control system in automatic mode

**i** When operating the climate control system in automatic mode, you will only rarely need to adjust the temperature, air volume and air distribution.

In automatic mode, cooling with dehumidify is switched on. This function can be switched off if necessary (▷ page 225).

#### Activating

- ▶ Press button **AUTO** (▷ page 216) while the engine is running.



The indicator lamp on the button comes on. The air volume and air distribution are adjusted automatically.

- ▶ Use temperature controls ① and ⑦ (▷ page 216) to separately adjust the air temperature on each side of the passenger compartment.

The interior air temperature is adjusted automatically.

**i** The settings for the passenger side are also used for the rear passenger compartment.

#### Deactivating

- ▶ Press button  or  (▷ page 216).

The indicator lamp on button **AUTO** goes out. The automatic operation of air volume switches off. The selected blower speed is shown in the air volume display ⑪ (▷ page 216).

or

- ▶ Press air distribution button ⑤, ⑨, or ⑩ (▷ page 216).

The indicator lamp on button **AUTO** goes out. The automatic operation of air distribution switches off.

### Setting the temperature

Use temperature controls ① and ⑦ (▷ page 216) to separately adjust the air temperature on each side of the passenger compartment. You should raise or lower the temperature setting in small increments, preferably starting at 72°F (22°C). The climate control will adjust to the set temperature as fast as possible.

### Increasing

- ▶ Turn temperature control ① and/or ⑦ (▷ page 216) slightly clockwise.

The climate control system will correspondingly adjust the interior air temperature.

### Decreasing



- ▶ Turn temperature control ① and/or ⑦ (▷ page 216) slightly counterclockwise.

The climate control system will correspondingly adjust the interior air temperature.

### Adjusting air distribution

Press air distribution button ⑤, ⑨, or ⑩ (▷ page 216) to adjust the air distribution.

The following symbols are found on the controls:

Symbol	Function
	Directs air through the center and side air vents
	Directs air to the windshield and side air vents
	Directs air to the footwells and side air vents

- ▶ Press the desired air distribution button ⑤, ⑨, or ⑩ (▷ page 216).



The indicator lamp on button **AUTO** goes out.



### Climate control

#### Adjusting air volume



Five blower speeds are available.

- ▶ Press button  to decrease or button  to increase air volume (▷ page 216) to the desired level.

The indicator lamp on button **AUTO** (▷ page 216) goes out. The automatic operation of air volume switches off. The selected blower speed is shown in the air volume display  (▷ page 216).



#### Adjusting air volume for the center and side air vents

##### Opening the center air vents

- ▶ Turn thumbwheels  and  (▷ page 214) to the right.



The corresponding center air vents on the left and right are open.

##### Closing the center air vents

- ▶ Turn thumbwheels  and  (▷ page 214) to the left.



The corresponding center air vents on the left and right are closed.

##### Opening the side air vents

- ▶ Turn thumbwheels  and  (▷ page 214) to the right.

The corresponding side air vents on the left and right are open.



##### Closing the side air vents

- ▶ Turn thumbwheels  and  (▷ page 214) to the left.

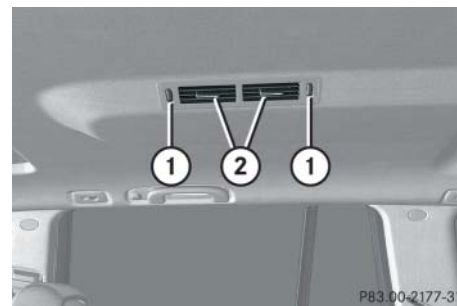

The corresponding side air vents on the left and right are closed.

#### Air vents in the roof liner over the second-row seats\*



-  Thumbwheel for air volume control
-  Air vent, adjustable

#### Adjusting air volume

- ▶ Turn thumbwheel  down to decrease the air volume.
- or
- ▶ Turn thumbwheel  up to increase the air volume.

## Adjusting air distribution

- ▶ Move air vent slider  to the left, right, up, or down to direct the air in the desired direction.

## Front defroster

You can use this setting to defrost the windshield, for example if it is iced up. You can also use it to defog the windshield and door windows.

 *Keep this setting selected only until the windshield or the door windows are clear again.*

## Activating



- ▶ Press button  (▷ page 216).  
The indicator lamp on the button comes on.

The climate control switches to the following functions automatically:



- most efficient blower speed and heating power, depending on outside temperature
- air flows onto the windshield and the door windows (side air vents must be open)
- the air conditioning compressor switches on at outside temperatures above approximately 41°F (5°C) for air-drying

## Adjustments



You can adjust the air volume and the temperature when the front defroster is switched on. The air flow will remain on the windshield and door windows.

- ▶ Press button  to decrease or button  to increase air volume (▷ page 216) to the desired level.



The air volume decreases/increases to the next lower/higher blower speed and heating switches to the temperature that was set before the front defroster was switched on.



The indicator lamp on button  goes out. The indicator lamp on button  comes on.

or

- ▶ Turn temperature control  and/or  (▷ page 216) slightly in any direction.

Heating switches to the temperature that was set before the front defroster was switched on.

The indicator lamp on button  goes out. The indicator lamp on button  comes on.

 *The air conditioning compressor remains on even if the indicator lamp in button  goes out. This helps to prevent the windshield from fogging.*

### Climate control

#### Deactivating

- ▶ Press button  (▷ page 216) once more.

The indicator lamp on the button goes out. Defrosting is turned off.

The previous settings are in effect again. The air conditioning compressor remains switched on.

**i** To switch off, you can also press button **OFF** or **AUTO** (▷ page 216).

#### Windshield fogged on the outside

**i** Keep this setting selected only until the windshield is clear again.

- ▶ Switch the windshield wipers on (▷ page 63).
- ▶ Press button  (▷ page 216).

The indicator lamp on the button comes on.

The climate control switches automatically to the following functions:

- most efficient blower speed and heating power, depending on outside temperature
- air flows onto the windshield and the door windows (side air vents must be open)
- the air conditioning compressor switches on at outside temperatures above approximately 41°F (5°C) for air-drying

If the automatic air distribution is switched off:

- ▶ Press air distribution button ⑨ or ⑩ (▷ page 216).

#### Air recirculation mode

Switch to air recirculation mode to prevent unpleasant odors from entering the vehicle from the outside (e.g. before driving through a tunnel). This setting cuts off the intake of outside air and recirculates the air in the passenger compartment.

#### Warning!



Fogged windows impair visibility, endangering you and others. If the windows begin to fog on the inside, switching off the air recirculation mode immediately should clear interior window fogging. If interior window fogging persists, make sure the air conditioning (▷ page 216) is activated, or press button .

## Activating

▶ Press button  (> page 216).

The indicator lamp on the button comes on.

**i** *The air recirculation mode is activated automatically at high outside temperatures.*

*The indicator lamp on button  is not lit when the air recirculation mode is switched on automatically.*

*A quantity outside air is added after approximately 30 minutes.*

*If you have turned off the air conditioning (> page 224) or the outside temperature is below 41 °F (5 °C), the air recirculation mode will not switch on automatically.*

**i** *To cool the interior as fast as possible, the climate control automatically switches to air recirculation. The indicator lamp on button  is not lit when the air recirculation mode has been switched on automatically.*

## Deactivating

▶ Press button .

The indicator lamp on the button goes out.

**i** *The air recirculation mode is deactivated automatically*

- *after 5 minutes if the outside temperature is below approximately 41 °F (5 °C)*
- *after 5 minutes if the air conditioning and air-drying is turned off*
- *after 30 minutes if the outside temperature is above approximately 41 °F (5 °C)*

## Air recirculation mode with convenience closing and opening feature

### Warning!



Never operate the windows and tilt/sliding sunroof\* if there is the possibility of anyone being harmed by the opening or closing procedure.

When using the air recirculation mode with convenience closing feature, should the upward movement of a window be blocked by some obstruction including but not limited to arms, hands, fingers, etc., the automatic reversal feature will not operate.

In case the procedure causes potential danger:

Vehicles with or without tilt/sliding sunroof\*: The closing of the windows can be immediately halted by pressing or pulling the respective window switch. The closing of the tilt/sliding sunroof\* can be immediately halted by moving the switch for the tilt/sliding sunroof\* in any direction.



### Climate control

- ▷▷ The closing of the windows and the tilt/sliding sunroof\* can be reversed by again pressing and holding the  button.

#### Convenience closing



- ▶ Press button  for approximately 2 seconds.

The windows and/or tilt/sliding sunroof\* will close. You can release button  once the closing procedure has begun. The windows and tilt/sliding sunroof\* continue closing until they are fully closed. The indicator lamp on the button comes on. The air recirculation mode is activated.

#### Convenience opening

- ▶ Press button  for approximately 2 seconds.

The windows and/or tilt/sliding sunroof\* will return to their previous positions. You can release button  once the opening procedure has begun. The windows and tilt/sliding sunroof\* continue opening until they have reached their previous positions. The indicator lamp on the button goes out. The air recirculation mode is deactivated.

 *A window or the tilt/sliding sunroof\* will only return to its previous position if it has not been moved to another position using the respective window switch or tilt/sliding sunroof\* switch after it was closed with button .*

#### Air conditioning

The air conditioning is operational while the engine is running and cools the interior air to the temperature set by the operator. In addition, the air conditioning dehumidifies the interior air at outside temperatures above 41°F (5° C) and helps prevent window fogging.

 *Condensation may drip out from underneath the vehicle. This is normal and not an indication of a malfunction.*

#### Warning!



If you turn off the cooling function, the interior air is not dried. The windows can fog up more quickly. Window fogging may impair visibility and endanger you and others.

## Deactivating

It is possible to deactivate the air conditioning (cooling) function of the climate control system. The air in the vehicle will then no longer be cooled or dehumidified.

- ▶ Press button  (▷ page 216).

The indicator lamp on the button goes out.

## Activating

Moist air can fog up the windows. You can dehumidify the air with the air conditioning.

- ▶ Press button  (▷ page 216) again.

The indicator lamp on the button comes on.

The air conditioning uses the refrigerant R134a. This refrigerant is free of CFCs which are harmful to the ozone layer.

**!** *If the air conditioning cannot be turned on again, this indicates that the air conditioning is losing refrigerant. The compressor has turned off.*

*Have the air conditioning checked at the nearest authorized Mercedes-Benz Light Truck Center.*

## Residual heat and ventilation

With the engine switched off, it is possible to continue to heat or ventilate the interior for up to 30 minutes. This feature makes use of the residual heat produced by the engine.

**i** *How long the system will provide heating depends on*

- *the coolant temperature*
- *the battery voltage*

*Regardless of the temperature and air volume set on the climate control panel, the interior temperature is set to 72°F (22°C) and the blower runs on low speed to protect the vehicle battery.*

## Activating

- ▶ Switch off the ignition (▷ page 42).
- ▶ Press button  (▷ page 216).

The indicator lamp on the button comes on.

## Deactivating

- ▶ Press button  (▷ page 216).

The indicator lamp on the button goes out.

**i** *The residual heat is automatically turned off:*

- *when the ignition is switched on*
- *after about 30 minutes*
- *if the coolant temperature is too low*
- *if the battery voltage drops*

## Climate control

### Rear climate control\*

**i** The rear climate control panel is only available if your vehicle is equipped with seat heating\* for the rear seats or Rear Audio feature\* (see separate COMAND System operating instructions).

The control panel is located on the rear of the front center console.

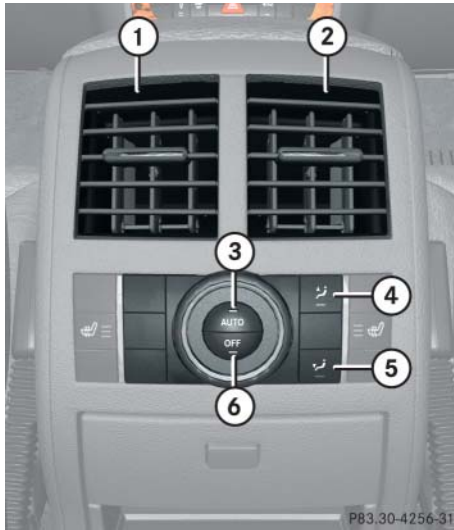

- ① Left rear center air vent, adjustable
- ② Right rear center air vent, adjustable
- ③ Rear climate control on (automatic mode)
- ④ Air distribution (directs air through the center air vents)
- ⑤ Air distribution (directs air through the footwells and side air vents)
- ⑥ Rear air conditioning off

### Activating rear climate control

**i** The climate control must be switched on (▷ page 227).

- ▶ Press button **AUTO**.

The indicator lamp on the button comes on. The air volume and air distribution are adjusted automatically.

**i** The temperature is adjusted according to the settings for the front passenger side made on the front climate control panel (▷ page 219).

### Deactivating rear climate control

- ▶ Press button **OFF**.

The indicator lamp on the button comes on.

The cooling function switches off after a short delay.

**i** Switch off the rear climate control for improved cooling or heating output in the front passenger compartment.

You can also switch off the rear climate control from the front passenger compartment (▷ page 227).

## Operating from the front

### Deactivating

- ▶ Press button **REAR OFF** on the front climate control panel (▷ page 216).

The indicator lamp on the button comes on.

### Reactivating



- ▶ Press button **REAR OFF** on the front climate control panel (▷ page 216).

The indicator lamp on the button goes out. The rear climate control is adjusted automatically.

## Adjusting air distribution

Use the air distribution controls ④ or ⑤ to adjust the air distribution for the rear passenger compartment.

The following symbols are found on the controls:

Symbol	Function
	Directs air to the center air vents
	Directs air to the footwells and the side air vents

### Adjusting manually

- ▶ Press the desired air distribution control ④ or ⑤.

The indicator lamp in the **AUTO** button goes out.

### Adjusting automatically

- ▶ Press button **AUTO** (▷ page 226).

The indicator lamp on the button comes on. The air distribution is adjusted automatically.

### Adjusting air volume

The air volume for the rear zone corresponds to the air volume settings for the front passenger side. You can switch off the air supply for the rear zone.

You can switch off the supplied amount of air volume.

- ▶ Press button **OFF** (▷ page 226).

The indicator lamp on the button comes on.



### 3-zone automatic climate control\*



## 3-zone automatic climate control\*

- ① Driver's door air vent, fixed
- ② Left side air vent, adjustable
- ③ Thumbwheel for air volume control for left side and door air vent
- ④ Windshield air vents
- ⑤ Thumbwheel for air volume control for left center air vent
- ⑥ Left center air vent, adjustable
- ⑦ Right center air vent, adjustable
- ⑧ Thumbwheel for air volume control for right center air vent
- ⑨ Thumbwheel for air volume control for right side and door air vent
- ⑩ Right side air vent, adjustable
- ⑪ Front passenger door air vent, fixed
- ⑫ Automatic climate control panel
- ⑬ Footwell air vents

**i** For draft-free ventilation, move the sliders for center air vents and side air vents to the middle position.

## 3-zone automatic climate control\*

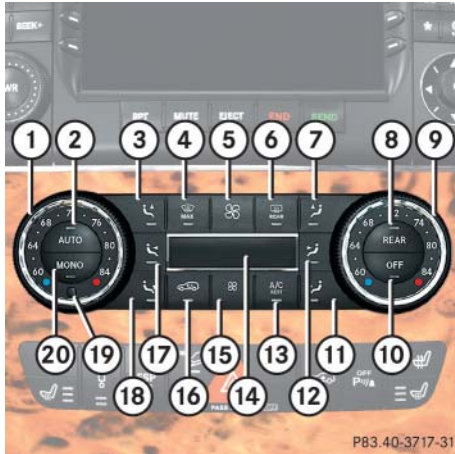

P83.40-3717-31

- |   |   |   |  |
|---|---|---|--|
| ① | Temperature control, left                           | ⑩ | Automatic climate control on/off               |
| ② | Air distribution and air volume (automatic, manual) | ⑪ | Air distribution, passenger side               |
| ③ | Air distribution, driver's side                     | ⑫ | Air distribution, passenger side               |
| ④ | Front defroster                                     | ⑬ | AC cooling on/off<br>Residual heat/ventilation |
| ⑤ | Increasing air volume                               | ⑭ | Display  |
| ⑥ | Rear window defroster                               | ⑮ | Decreasing air volume                          |
| ⑦ | Air distribution, passenger side                    | ⑯ | Air recirculation                              |
| ⑧ | Rear automatic climate control on/off               | ⑰ | Air distribution, driver's side                |
|   | <b>REAR</b> USA only                                | ⑱ | Air distribution, driver's side                |
|   | <b>II</b> Canada only                               | ⑲ | Interior temperature sensor                    |
| ⑨ | Temperature control, right                          | ⑳ | Adopting driver's side settings for all zones  |

**3-zone automatic climate control\*****Warning!**

When operating the automatic climate control, the air that enters the passenger compartment through the air vents can be very hot or very cold (depending on the set temperature). This may cause burns or frostbite to unprotected skin in the immediate area of the air vents.

Always keep sufficient distance between unprotected parts of the body and the air vents. If necessary, use the air distribution controls (▷ page 230) to direct the air to air vents in the vehicle interior that are not in the immediate area of unprotected skin.

The automatic climate control is a 3-zone intelligent automatic climate control system. Your vehicle interior is divided into 3 zones.



P83.00-2175-31

With the help of a sun sensor, the automatic climate control determines the relation of the sun to the vehicle and automatically adjusts the inside temperature for every individual zone.

The automatic climate control is operational whenever the engine is running. It cools the vehicle's interior according to the angle and intensity of the sun's rays, the outside temperature and the selected temperature. You can operate the automatic climate control in either the automatic or manual mode.

### 3-zone automatic climate control\*

Nearly all dust particles, pollutants and odors are filtered out before outside air enters the passenger compartment through the air distribution system.

#### Warning!



Severe conditions (e.g. strong air pollution) may require replacement of the filter before its scheduled interval. A clogged filter will reduce the air volume to the interior and the windows could fog up, impairing visibility and endangering you and others. Have a clogged filter replaced as soon as possible at an authorized Mercedes-Benz Light Truck Center.

The air conditioning will not engage (no cooling) if the **A/C** mode is deactivated (▷ page 230).

#### Warning!



Follow the recommended settings for heating and cooling given on the following pages. Otherwise the windows could fog up, impairing visibility and endangering you and others.

**i** *If the vehicle interior is hot, ventilate the interior before driving off, see “Summer opening feature” (▷ page 249). The automatic climate control will then adjust the interior temperature to the set value much faster.*

*Keep the air intake grille in front of the windshield free of snow and debris.*

### Deactivating the automatic climate control system

#### Warning!



When the automatic climate control system is switched off, the outside air supply and circulation are also switched off. Only choose this settings for a short time. Otherwise the windows could fog up, impairing visibility and endangering you and others.

### Deactivating

- ▶ Press button **OFF** (▷ page 230) until the display **14** (▷ page 230) is cleared.  
The indicator lamp on the button comes on.

## 3-zone automatic climate control\*

**Reactivating**

- ▶ Press button **AUTO** (▷ page 230).

**i** You can also press button **OFF** (▷ page 230) on the automatic climate control panel.

If you press button **MAX** (▷ page 230) to reactivate the automatic climate control system, the defrosting mode is activated.

**Operating the automatic climate control system in automatic mode**

You can switch the automatic climate control system on and off separately for each zone as needed.

**i** When operating the automatic climate control system in automatic mode, you will only rarely need to adjust the temperature, air volume and air distribution.

*In automatic mode, cooling with dehumidify is switched on. This function can be switched off if necessary.*

**Activating**

- ▶ Press button **AUTO** (▷ page 230) while the engine is running.

The indicator lamp on the button comes on. Air volume and air distribution are controlled separately for each zone.

- ▶ Use temperature controls ① and ② (▷ page 230) to separately adjust the air temperature on each side of the passenger compartment.

The temperature of the interior is adjusted automatically.

**Deactivating**

- ▶ Press one button of the air distribution (▷ page 230) or press button **OFF** or **OFF** (▷ page 230).

The indicator lamp on button **AUTO** goes out.

Depending on which button you press – the air distribution button or the air volume button **OFF** or **OFF** – automatic control of either the air distribution or air volume is switched off.

### 3-zone automatic climate control\*

#### Setting the temperature

Use temperature control ① and ⑨ (▷ page 230) to separately adjust the air temperature on each side of the passenger compartment. You should raise or lower the temperature setting in small increments, preferably starting at 72°F (22°C). The automatic climate control will adjust to the set temperature as fast as possible.

#### Increasing

- ▶ Turn temperature control ① and/or ⑨ slightly clockwise.

The automatic climate control system will correspondingly adjust the interior air temperature.

#### Decreasing

- ▶ Turn the temperature control ① and/or ⑨ slightly counterclockwise.

The automatic climate control system will correspondingly adjust the interior air temperature.

#### Adjusting air distribution

Use the air distribution controls ③, ⑱, or ⑲ for the driver's side, or ⑦, ⑪, or ⑫ (▷ page 230) for the passenger side to separately adjust the air distribution on each side of the passenger compartment.

The following symbols are found on the buttons:

Symbol		Function
Driver's side	Passenger side	
		Directs air to the windshield and side air vents
		Directs air through the center, side and rear passenger compartment air vents
		Directs air to the footwells and side air vents

- ▶ Press the desired air distribution button (▷ page 230).

The indicator lamp on the desired button goes out.

#### Adjusting the air distribution for the center and side air vents

##### Opening the center air vents

- ▶ Turn thumbwheels ⑤ and ⑧ (▷ page 228) to the right.

The corresponding center air vents on the left and right are open.

##### Closing the center air vents

- ▶ Turn thumbwheels ⑤ and ⑧ (▷ page 228) to the left.

The corresponding center air vents on the left and right are closed.

### Opening the side air vents

- ▶ Turn thumbwheels ③ and ⑪ (▷ page 228) to the right.

The corresponding side air vents on the left and right are open.



### Closing the side air vents

- ▶ Turn thumbwheels ③ and ⑪ (▷ page 228) to the left.

The corresponding side air vents on the left and right are closed.

### Adjusting air volume

Five blower speeds are available.

- ▶ Press button  to decrease or button  to increase air volume (▷ page 230) to the desired level.

The indicator lamp on button  goes out.

The automatic mode is switched off.  
The selected blower speed appears in the display ⑭ (▷ page 230).

### Front defroster

You can use this setting to defrost the windshield, such as when it is iced up. You can also use it to defog the windshield and door windows.

 *Keep this setting selected only until the windshield or the side windows are clear again.*

### Activating

- ▶ Press button  (▷ page 230).

The indicator lamp on the button comes on.





### 3-zone automatic climate control\*

The automatic climate control switches to the following functions automatically:



- most efficient blower speed and heating power, depending on outside temperature
- air flows onto the windshield and the front door windows (side air vents must be open)
- the air conditioning compressor switches on at outside temperatures above approximately 41°F (5°C) for air-drying

#### Adjustments



You can adjust the air volume and the temperature when the front defroster is switched on. The air flow will remain on the windshield and front door windows.

- ▶ Press button  to decrease or button  to increase air volume (▷ page 230) to the desired level.



The air volume decreases/increases to the next lower/higher blower speed and heating switches to the temperature that was set before the front defroster was switched on.



The indicator lamp on button  goes out. The indicator lamp on button  comes on.

or

- ▶ Turn temperature control  and/or  (▷ page 230) slightly in any direction.

Heating switches to the temperature that was set before the front defroster was switched on.

The indicator lamp on button  goes out. The indicator lamp on button  comes on.

 *The air conditioning compressor remains on even if the indicator lamp in button  goes out. This helps to prevent the windshield from fogging.*

#### Deactivating

- ▶ Press button  (▷ page 230).

The indicator lamp on the button goes out. Defrosting is turned off.

The previous settings are once again in effect.

 *To switch off, you can also press button **OFF** or **AUTO** (▷ page 230).*

## 3-zone automatic climate control\*



**Windshield fogged on the outside**

 *Keep this setting selected only until the windshield is clear again.*

- ▶ Switch the windshield wipers on (▷ page 63).
- ▶ Press button **AUTO** (▷ page 230).

The indicator lamp on button **AUTO** goes out. Air volume and air distribution are controlled separately for each zone.

If the automatic air distribution and air volume are switched off:

- ▶ Press buttons  and  (▷ page 230).

**Maximum cooling MAXCOOL**

If the air distribution control as well as the airflow volume control are set to **AUTO** and there is a high need for cooling, the MAXCOOL function is activated.

“MAXCOOL” appears in the front and rear display.

This provides the fastest possible cooling of the vehicle interior (when windows and tilt/sliding sunroof\* are closed).

**Air recirculation mode**

Switch to air recirculation mode to prevent unpleasant odors from entering the vehicle from the outside (e.g. before driving through a tunnel). This setting cuts off the intake of outside air and recirculates the air in the passenger compartment.

**Warning!**

Fogged windows impair visibility, endangering you and others. If the windows begin to fog on the inside, switching off the air recirculation mode immediately should clear interior window fogging. If interior window fogging persists, make sure the air conditioning (▷ page 239) is activated, or press button .

### 3-zone automatic climate control\*

#### Activating

- ▶ Press button  (▷ page 230).

The indicator lamp on the button comes on.

**i** *The air recirculation mode is activated automatically at high outside temperatures.*

*The indicator lamp on button  is not lit when the air recirculation mode is automatically switched on.*

*A quantity of outside air is added after approximately 30 minutes.*

*If you have turned off the air conditioning (▷ page 239) or the outside temperature is below 41 °F (5 °C), the air recirculation mode will not switch on automatically.*

**i** *To cool the interior as fast as possible, the automatic climate control automatically switches to air recirculation. The indicator lamp on button  is not lit when the system switches to air recirculation automatically.*

#### Deactivating

- ▶ Press button  (▷ page 230).

The indicator lamp on the button comes on.

**i** *The air recirculation mode is deactivated automatically*

- *after 5 minutes if the outside temperature is below approximately 41 °F (5 °C)*
- *after 5 minutes if the air conditioning and air-drying is turned off*
- *after 30 minutes if the outside temperature is above approximately 41 °F (5 °C)*

At outside temperatures above 79 °F (26 °C) the system will not automatically switch back to outside air. A quantity of outside air is added after approximately 30 minutes.

#### Air recirculation mode with convenience closing and opening feature

##### Warning!



Never operate the side windows and tilt/sliding sunroof\* if there is the possibility of anyone being harmed by the opening or closing procedure.

When using the air recirculation mode with convenience closing feature, should the upward movement of a window be blocked by some obstruction including but not limited to arms, hands, fingers, etc., the automatic reversal feature will not operate.

In case the procedure causes potential danger:

Vehicles with or without tilt/sliding sunroof\*: The closing of the windows can be immediately halted by pressing or pulling the respective window switch. The closing of the tilt/sliding sunroof\* can be immediately halted by moving the switch for the tilt/sliding sunroof\* in any direction.

## 3-zone automatic climate control\*

The closing of the side windows and the tilt/sliding sunroof\* can be reversed by again pressing and holding the  button.

**Convenience closing**



- ▶ Press button  for approximately 2 seconds.

The windows and/or tilt/sliding sunroof\* will close. You can release button  once the closing procedure has begun. The windows and tilt/sliding sunroof\* continue closing until they are fully closed. The indicator lamp on the button comes on. The air recirculation mode is activated.

**Convenience opening**

- ▶ Press button  for approximately 2 seconds.

The windows and/or tilt/sliding sunroof\* will return to their previous positions. You can release button  once the opening procedure has begun. The windows and tilt/sliding sunroof\* continue opening until they have reached their previous positions. The indicator lamp on the button goes out. The air recirculation mode is deactivated.

 *A window or the tilt/sliding sunroof\* will only return to its previous position if it has not been moved to another position using the respective window switch or tilt/sliding sunroof\* switch after it was closed with button .*

**Air conditioning**

The cooling function, only operational when the engine is running, cools the vehicle down to the selected interior temperature. The cooling function also dehumidifies the air in the vehicle interior, thereby preventing the windows from fogging up.

 *Condensation may drip out from underneath the vehicle. This is normal and not an indication of a malfunction.*

**Warning!**

If you turn off the cooling function, the interior air is not dried. The windows can fog up more quickly. Window fogging may impair visibility and endanger you and others.

### 3-zone automatic climate control\*

#### Deactivating

It is possible to deactivate the air conditioning (cooling) function of the automatic climate control system. The air in the vehicle will then no longer be cooled or dehumidified.

- ▶ Press button  (▷ page 230).

The indicator lamp on the button goes out. The cooling function switches off after a short delay.

#### Activating

Moist air can fog up the windows. You can dehumidify the air with the air conditioning.

- ▶ Press button  again.

The indicator lamp on the button comes on.

The air conditioning uses the refrigerant R-134a. This refrigerant is free of CFCs which are harmful to the ozone layer.

**!** *If the air conditioning cannot be turned on again, this indicates that the air conditioning is losing refrigerant. The compressor has turned off.*

*Have the air conditioning checked at the nearest authorized Mercedes-Benz Light Truck Center.*

#### Using driver-side settings for all temperature zones

You can use the settings of the driver's side, such as temperature, air volume and air distribution, for all temperature zones. These settings only need to be made once and the automatic climate control system will automatically regulate the settings for all temperature zones quickly and comfortably.

#### Activating

- ▶ Adjust the temperature, air volume and air distribution (▷ page 230).
- ▶ Press button  (▷ page 230).

The indicator lamp on the button comes on.

The driver-side settings are used for all temperature zones.

#### Deactivating

- ▶ Press button  (▷ page 230) again.

The indicator lamp on the button goes out.

**i** *If you manually set the temperature, air volume or air distribution for the passenger side or the rear passenger compartment when the **MONO** setting is active, the **MONO** setting will be switched off.*

## 3-zone automatic climate control\*

### Residual heat and ventilation

With the engine switched off, it is possible to continue to heat or ventilate the interior for up to 30 minutes. This feature makes use of the residual heat produced by the engine.

**i** How long the system will provide heating depends on

- the coolant temperature
- the battery voltage

Regardless of the temperature and air volume set on the automatic climate control panel, an interior temperature is aimed at by 72°F (22°C) and the blower runs on low speed to protect the vehicle battery.

### Activating

- ▶ Switch off the ignition (▷ page 41).
- ▶ Press button **A/C REST** (▷ page 230).

The indicator lamp on the button comes on.

### Deactivating

- ▶ Press button **A/C REST**.

The indicator lamp on the button goes out.

**i** The residual heat is automatically turned off:

- when the ignition is switched on
- after about 30 minutes
- if the coolant temperature is too low
- if the battery voltage drops

### Rear automatic climate control

The control panel is located at the rear of the front center console.

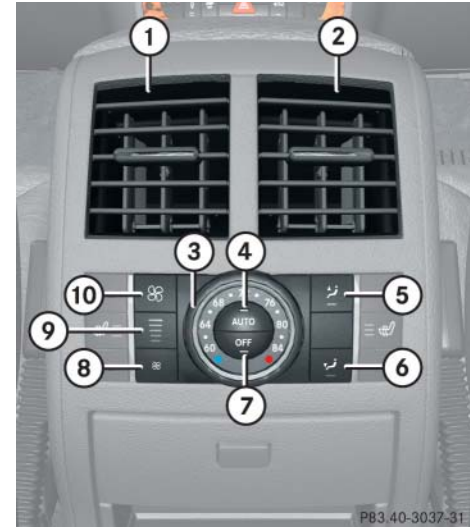

### 3-zone automatic climate control\*

①	Left rear center air vent, adjustable
②	Right rear center air vent, adjustable
③	Temperature control
④	Air distribution and air volume (automatic, manual)
⑤	Air distribution (directs air through the center air vents)
⑥	Air distribution (directs air through the footwells and side air vents)
⑦	Rear automatic climate control on/off
⑧	Decreasing air volume
⑨	Indicator lamps for air volume settings
⑩	Increasing air volume

**i** The stored values for the rear automatic climate control are erased from memory after the ignition has been switched off for more than 30 minutes. Once the front automatic climate control is switched on again, the rear automatic climate control operates in automatic mode at a preset temperature of 72°F (22°C).

#### Activating rear automatic climate control

**i** The automatic climate control must be switched on (▷ page 233).

- ▶ Press button **AUTO**.

The indicator lamp on the button comes on. The temperature, air volume, and air distribution are adjusted automatically.

#### Deactivating rear automatic climate control

- ▶ Press button **OFF**.

The indicator lamp on the button goes out.

The cooling function switches off after a short delay.

**i** Switch off the rear automatic climate control for improved cooling or heating output in the front passenger compartment.

You can also switch off the rear automatic climate control from the front passenger compartment (▷ page 230).

#### Operating from the front

##### Deactivating

- ▶ Press button **REAR** (▷ page 230).

The indicator lamp on the button goes out.

In display ⑭ (▷ page 230), you will see the **REAR** symbol followed by MODE for approximately 3 seconds.

- ▶ Press button **OFF** (▷ page 230).

In display ⑭ (▷ page 230), you will see the **REAR** symbol followed by OFF.

The rear automatic climate control is switched off.

3-zone automatic climate control\*

**Reactivating**

- ▶ Press button **REAR** (▷ page 230).

The indicator lamp on the button comes on.

In display ⑭ (▷ page 230), you will see the **REAR** symbol followed by ON and MODE. The MODE display is cleared and the indicator lamp on button **REAR** goes out after approximately 3 seconds.

The rear automatic climate control switches on.

**Setting the temperature**

- ▶ Press button **REAR** (▷ page 230).

The indicator lamp on the button comes on.

In display ⑭ (▷ page 230), you will see the **REAR** symbol followed by MODE.

- ▶ Set the desired temperature for the rear passenger compartment using temperature control ③ (▷ page 242).



After approximately 3 seconds after the last adjustment, the display switches back to its standard display and the indicator lamp on button **REAR** goes out.

**i** You can also press the **REAR** button once more to switch back to the standard display.

**Adjusting air distribution**

Use the air distribution controls ⑤ or ⑥ to adjust the air distribution for the rear passenger compartment.

The symbols on the controls represent the following functions:

Symbol	Function
	Directs air to the center air vents
	Directs air to the footwells and the side air vents

**Adjusting manually**

- ▶ Press the desired air distribution control.

The indicator lamp on button **AUTO** goes out.



### 3-zone automatic climate control\*

#### *Adjusting automatically*

- ▶ Press button **AUTO** while the engine is running.

The indicator lamp on the button comes on. The air distribution is adjusted automatically.

#### **Setting the temperature**

Use temperature control ③ (▷ page 242) to separately adjust the air temperature of the rear passenger compartment.

You should raise or lower the temperature setting in small increments, preferably starting at 72°F (22°C). The automatic climate control will adjust to the set temperature as fast as possible.

**i** *The rear automatic climate control will not cool the air when the air conditioning is switched off (▷ page 240).*

#### *Increasing the temperature*

- ▶ Turn temperature control ③ (▷ page 242) slightly clockwise.

The rear automatic climate control will correspondingly adjust the interior air temperature for the rear passenger compartment.

#### *Decreasing the temperature*



- ▶ Turn temperature control ③ (▷ page 242) slightly counterclockwise.

The rear automatic climate control will correspondingly adjust the interior air temperature for the rear passenger compartment.

#### **Adjusting air volume**

#### *Adjusting manually*

Five blower speeds are available.

- ▶ Press button  to decrease or button  to increase air volume to the desired level.

The indicator lamp on the button **AUTO** goes out. The selected blower speed is shown by the indicator lamps for air volume settings ⑨ (▷ page 242).

#### *Adjusting automatically*

- ▶ Press button **AUTO**.

The indicator lamp on the button comes on. The air volume is adjusted automatically.

## 3-zone automatic climate control\*

### Air vents in the roof liner over the second-row seats\*

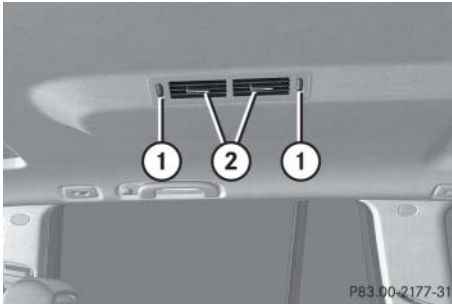

- ① Thumbwheel for air volume control
- ② Air vent, adjustable

### Adjusting air volume

- ▶ Turn thumbwheel ① down to decrease the air volume.

or

- ▶ Turn thumbwheel ① up to increase the air volume.

### Adjusting air distribution

- ▶ Move air vent slider ② to the left, right, up, or down to direct the air in the desired direction.

### Air vents in the roof liner over the third-row seats\*

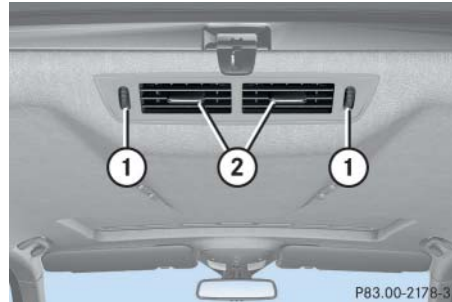

- ① Thumbwheel for air volume control
- ② Air vent, adjustable

### Adjusting air volume

- ▶ Turn thumbwheel ① down to decrease the air volume.

or

- ▶ Turn thumbwheel ① up to increase the air volume.

### Adjusting air distribution

- ▶ Move air vent slider ② to the left, right, up, or down to direct the air in the desired direction.

### Power windows

The door windows and the hinged quarter windows\* are opened and closed electrically. The switches for all door windows and the hinged quarter windows\* are located on the driver's door control panel. The switches for the respective door windows are located on the front passenger door and the rear doors. The hinged quarter windows\* can be operated from the driver's seat only.

#### Warning!



When closing the windows, make sure that there is no danger of anyone being harmed by the closing procedure.

Activate the override switch (▷ page 98) when children are riding in the back seats of the vehicle. The children could otherwise injure themselves, e.g. by becoming trapped in the window opening.

The closing of a door window can be immediately halted by releasing the switch or, if switch was pulled past the resistance point and released, by either pressing or pulling the respective switch.

If a door window encounters an obstruction that blocks its path in a circumstance where you pulled the switch past the resistance point and released it to close the door window, the automatic reversal function will stop the window and open it slightly.

If a door window encounters an obstruction that blocks its path in a circumstance where you are closing a door window by pulling and holding the switch, or by pressing and holding button  on the SmartKey, by pressing and holding the lock button (vehicles with KEYLESS-GO\*) on a door handle, the automatic reversal function will not operate.

When leaving the vehicle, always remove the SmartKey or SmartKey with KEYLESS-GO\* from the starter switch, take it with you, and lock the vehicle. Do not leave children

unattended in the vehicle, or with access to an unlocked vehicle. A child's unsupervised access to a vehicle could result in an accident and/or serious personal injury.

**i** You can also open or close the windows using the SmartKey, see "Summer opening feature" (▷ page 249) and see "Convenience closing feature" (▷ page 250).

Depending on the current position, the power windows may also open or close when the air recirculation button  on the control panel of the climate control (▷ page 216) or automatic climate control\* (▷ page 230) is pressed and held.

**i** After switching off the ignition (▷ page 41) or removing the SmartKey from the starter switch, the windows can be operated

- until you open the driver's or front passenger door
  - for at least 5 minutes if nor door was opened
- Switch on the ignition (▷ page 42).

## Door windows



- ① Left front door window
- ② Right front door window
- ③ Right rear door window
- ④ Left rear door window

## Opening the door windows

- ▶ Press switch ①, ②, ③, or ④ (▷ page 247) to the resistance point.  
The corresponding door window moves downwards until you release the switch.

## Closing the door windows

- ▶ Pull switch ①, ②, ③, or ④ (▷ page 247) to the resistance point.  
The corresponding door window moves upwards until you release the switch.

**Warning!**

If you pull and hold the switch up when closing the door window, and upward movement of the door window is blocked by some obstruction including but not limited to arms, hands, fingers, etc., the automatic reversal will not operate.

Fully opening the door windows  
(Express-open)

- ▶ Press switch ①, ②, ③, or ④ (▷ page 247) past the resistance point and release.  
The corresponding door window opens completely.

Fully closing the door windows  
(Express-close)

- ▶ Pull switch ①, ②, ③, or ④ (▷ page 247) past the resistance point and release.  
The corresponding door window closes completely.

**Warning!**

Driver's door only:  
If within 5 seconds switch is again pulled past the resistance point and released, the automatic reversal will not function.

### Power windows

**i** If the upward movement of a door window is blocked during the closing procedure, the door window will stop and open slightly.

- ▶ Remove the obstruction.
- ▶ Pull the respective door window switch past the resistance point again and release.

**i** If the door window still does not close when there is no obstruction, pull and hold the respective power window switch. The door window will then close without the obstruction sensor function.

#### Stopping door windows during Express-operation

- ▶ Press or pull the respective door window switch again.

#### Hinged quarter windows\*

The switches for opening and closing the hinged quarter windows are located on the door control panel of the driver's door (▷ page 35).

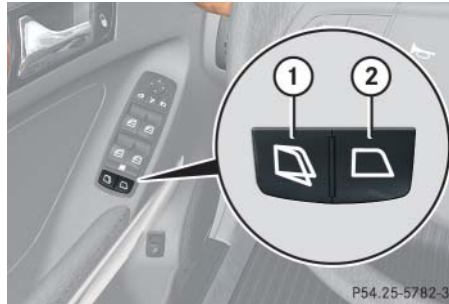

- ① Hinged quarter windows: opening
- ② Hinged quarter windows: closing

#### Opening

- ▶ Press and release switch ①.

To stop the hinged quarter window:

- ▶ Press and release switch ① once more.

#### Closing

- ▶ Press and release switch ②.

To stop the hinged quarter window:

- ▶ Press and release switch ② once more.

**i** When the obstruction sensor detects the hinged quarter window is blocked during the closing process, it will stop and open slightly.

### Synchronizing the door windows

The door windows must be resynchronized

- after the battery was disconnected
- if the door windows cannot be fully opened (Express-open) or closed (Express-close)

**i** Each door window must be resynchronized separately.

- ▶ Close all doors.
- ▶ Switch on the ignition (▷ page 42).
- ▶ Pull and hold switch ①, ②, ③, or ⑥ (▷ page 247).

Once a door window is closed completely, hold the respective switch for approximately 3 seconds.

The door window is synchronized.

### Summer opening feature

If the weather is warm, you can ventilate the vehicle before driving off by simultaneously:

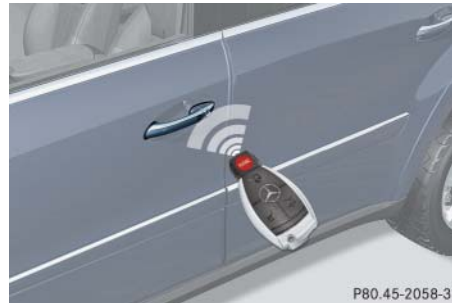

- opening the door windows
- opening the hinged quarter windows\*
- opening the tilt/sliding sunroof\*
- switching on the seat ventilation\* for the driver's seat



P80.45-2058-31

- ▶ Aim transmitter eye of the SmartKey or SmartKey with KEYLESS-GO\* at the driver's outside door handle.

The SmartKey or SmartKey with KEYLESS-GO\* must be in close proximity to the driver's outside door handle.

- ▶ Press and hold button  on the SmartKey or SmartKey with KEYLESS-GO\* until the windows and the tilt/sliding sunroof\* have reached the desired position.
- ▶ Release button  on the SmartKey or SmartKey with KEYLESS-GO\* to interrupt the opening procedure.

### Power windows

#### Convenience closing feature

When locking the vehicle, you can simultaneously close



- the door windows
- the hinged quarter windows\*
- the tilt/sliding sunroof\*

#### Warning!



When closing the windows and the tilt/sliding sunroof\*, make sure that there is no danger of anyone being harmed by the closing procedure.

If potential danger exists, proceed as follows:



- Release button  to stop the closing procedure. To open, press and hold button . To continue the closing procedure after making sure that there is no danger of anyone being harmed by the closing procedure, press and hold button .

Vehicles with KEYLESS-GO\*:

- Release the lock button (▷ page 71) on the driver's outside door handle to stop the closing procedure.
- Immediately pull on the same outside door handle and hold firmly. The windows and the tilt/sliding sunroof\* will open for as long as the door handle is held but the door is not opened.

- ▶ Aim transmitter eye of the SmartKey or SmartKey with KEYLESS-GO\* at the driver's outside door handle (▷ page 249).

The SmartKey or SmartKey with KEYLESS-GO\* must be in close proximity to the driver's outside door handle.

- ▶ Press and hold button  on the SmartKey or SmartKey with KEYLESS-GO\* until the windows and the tilt/sliding sunroof\* are completely closed.
- ▶ Release button  on the SmartKey or SmartKey with KEYLESS-GO\* to interrupt the closing procedure.

Vehicles with KEYLESS-GO\*:

- ▶ Press and hold the lock button on an outside door handle (▷ page 71) until the windows and the tilt/sliding sunroof\* are completely closed.
- ▶ Release the lock button on the outside door handle to interrupt the closing procedure.

## Power tilt/sliding sunroof\*

## ▼ Power tilt/sliding sunroof\*

## Opening and closing

**Warning!**

When closing the tilt/sliding sunroof, make sure that there is no danger of anyone being harmed by the closing procedure.

If the tilt/sliding sunroof encounters an obstruction that blocks its path in a circumstance where you are closing the tilt/sliding sunroof by moving the tilt/sliding sunroof switch past the resistance point, or by pressing and holding button  on the SmartKey, by pressing and holding the lock button (vehicles with KEYLESS-GO\*) on the door handle, the automatic reversal function will not operate.

The opening/closing procedure of the tilt/sliding sunroof can be immediately halted by releasing the switch or, if the switch was moved past the resistance point and released, by moving the switch in any direction.

The tilt/sliding sunroof is made out of glass. In the event of an accident, the glass may shatter. This may result in an opening in the roof.

In a vehicle rollover, occupants not wearing their seat belts or not wearing them properly may be thrown out of the opening. Such an opening also presents a potential for injury for occupants wearing their seat belts properly as entire body parts or portions of them may protrude from the passenger compartment.

When leaving the vehicle, always remove the SmartKey or SmartKey with KEYLESS-GO\* from the starter switch, take it with you, and lock your vehicle. Do not leave children unattended in the vehicle, or with access to an unlocked vehicle. A child's unsupervised access to a vehicle could result in an accident and/or serious personal injury.

**!** *To avoid damaging the seals, do not transport any objects with sharp edges which can stick out of the tilt/sliding sunroof.*

*Do not open the tilt/sliding sunroof if there is snow or ice on the roof, as this could result in malfunctions.*

**!** *Please keep in mind that weather conditions can sometimes change rapidly. Make sure to close the tilt/sliding sunroof when leaving the vehicle. If water enters the vehicle interior, vehicle electronics could be damaged which is not covered by the Mercedes-Benz Limited Warranty.*

**i** *When the tilt/sliding sunroof is open, resonance noises may result in addition to the usual wind noises. They are caused by minimal pressure changes in the passenger compartment. To reduce or eliminate these noises, change the position of the tilt/sliding sunroof or open a side window slightly.*

**i** *You can also open or close the tilt/sliding sunroof using the SmartKey or the KEYLESS-GO\* function, see "Summer opening feature" (▷ page 249) and see "Convenience closing feature" (▷ page 250).*



### Power tilt/sliding sunroof\*

**i** Depending on the current position, the tilt/sliding sunroof may also open or close when the air recirculation button  on the control panel of the climate control (▷ page 216) or automatic climate control\* (▷ page 230) is pressed and held.

The tilt/sliding sunroof is opened and closed electrically. The switch for the tilt/sliding sunroof is located on the overhead control panel.

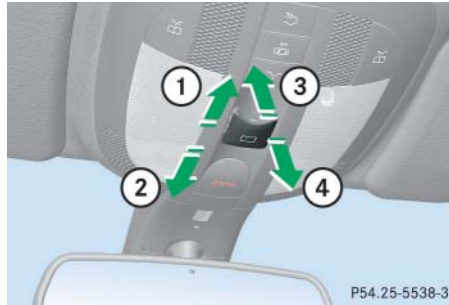

#### Sunroof switch

- ① Push back to slide sunroof open
- ② Push forward to slide sunroof closed
- ③ Push up to raise sunroof at rear
- ④ Pull down to lower sunroof at rear

With the sunroof closed or tilted open, a screen can be slid into the roof opening to guard against sun rays. When sliding the sunroof open, the screen will also retract.



- ▶ Switch on the ignition (▷ page 42).

#### Opening and closing

- ▶ To open, close, raise, or lower the tilt/sliding sunroof, move the sunroof switch to the resistance point in the required direction of arrows ① to ④ (▷ page 252).
- ▶ Release the sunroof switch when the tilt/sliding sunroof has reached the desired position.

### Fully opening (Express-open) and closing (Express-close)

- ▶ To fully open or close the tilt/sliding sunroof, move the sunroof switch past the resistance point in the required direction of arrows ① to ② (▷ page 252) and release.

The tilt/sliding sunroof opens or closes completely.

### Stopping the power tilt/sliding sunroof during Express-open

- ▶ Move the sunroof switch in any direction.

The movement of the tilt/sliding sunroof stops.

**i** *If the movement of the tilt/sliding sunroof is blocked during the closing procedure, the tilt/sliding sunroof will stop and reopen slightly.*

### Warning!



If the tilt/sliding sunroof encounters an obstruction that blocks its path in a circumstance where you are closing the tilt/sliding sunroof by moving the tilt/sliding sunroof switch past the resistance point, or by pressing and holding button **Ⓜ** on the SmartKey, by pressing and holding the lock button (vehicles with KEYLESS-GO\*) on the door handle, the automatic reversal function will not operate.

The opening/closing procedure of the tilt/sliding sunroof can be immediately halted by releasing the switch or, if the switch was moved past the resistance point and released, by moving the switch in any direction.

### Synchronizing

The tilt/sliding sunroof must be synchronized

- after the battery has been disconnected or discharged
- after a malfunction
- if the tilt/sliding sunroof does not open smoothly

**!** *If the tilt/sliding sunroof cannot be closed or synchronized, contact an authorized Mercedes-Benz Light Truck Center or call Roadside Assistance (▷ page 335).*

### Power tilt/sliding sunroof\*

- ▶ Switch off the ignition (▷ page 42).
- ▶ Remove the SmartKey from the starter switch.

Vehicles with KEYLESS-GO\*:

- ▶ Switch off the ignition (▷ page 43).
- ▶ Open the driver's door (this puts the starter switch in position **0**, same as with the SmartKey removed from the starter switch). The driver's door then can be closed again.
- ▶ Remove the fuse for the tilt/sliding sunroof from the fuse box (▷ page 543).

**i** For information on which fuse box contains the fuse for the power tilt/sliding sunroof, see the fuse chart provided with the vehicle tool kit (▷ page 490).

- ▶ Reinsert the fuse in the main box.
- ▶ Switch on the ignition (▷ page 42).
- ▶ Press and hold the sunroof switch in the direction of arrow ③ (▷ page 252) until the tilt/sliding sunroof is fully raised at the rear.
- ▶ Hold the sunroof switch in the direction of arrow ③ for approximately 1 second.
- ▶ Open the tilt/sliding sunroof using the Express-open feature (▷ page 253).

If the tilt/sliding sunroof opens completely, it is synchronized.

If the tilt/sliding sunroof does not open completely:

- ▶ Repeat the above steps.

## ▼ Driving systems

The driving systems of your vehicle are described on the following pages:

- Cruise control (▷ page 255) and Distronic\* (▷ page 260), with which the vehicle can maintain a preset speed.
- Distance warning function\* (▷ page 272) is only available with Distronic\*, which warns of stationary obstacle or slower moving vehicles that you are closing in on too quickly.
- Downhill Speed Regulation (DSR) (▷ page 273), which supports you when you are driving downhill.
- Off-road driving program (▷ page 277) (vehicles without enhanced off-road package\*), which supports you when you are driving off-road.

- Air suspension program  
There are two components available.
  - Vehicle level control (▷ page 279), which controls the vehicle level.
  - Adaptive Damping System (ADS)\* (▷ page 278), which adjusts the vehicle suspension characteristics.
- Parktronic\* (▷ page 288) and rear view camera\* (▷ page 293), which serve as a parking aid.

For information on the ABS, BAS, EBP, ESP®, and 4-ETS, see “Driving safety systems” (▷ page 101).

## Cruise control

The cruise control automatically maintains the speed you set for your vehicle.

The use of cruise control is recommended for driving at a constant speed for extended periods of time. You can set or resume cruise control at any speed above 20 mph (30 km/h).

The cruise control function is operated by means of the cruise control lever.

The cruise control lever is the uppermost lever on the left-hand side of the steering column (▷ page 24).

 *The cruise control should not be activated during off-road driving.*

### Driving systems

#### Warning!



The cruise control is a convenience system designed to assist the driver during vehicle operation. The driver is and must always remain responsible for the vehicle's speed and for safe brake operation.

Only use the cruise control if the road, traffic and weather conditions make it advisable to travel at a constant speed.

- The use of the cruise control can be dangerous on winding roads or in heavy traffic because conditions do not allow safe driving at a constant speed.
- The use of the cruise control can be dangerous on slippery roads. Rapid changes in tire traction can result in wheel spin and loss of control.
- Deactivate the cruise control when driving in fog.

The "Resume" function should only be operated if the driver is fully aware of the previously set speed and wishes to resume this particular preset speed.

#### Warning!



The cruise control brakes automatically so that the set speed is not exceeded. The brake pedal depresses when the cruise control engages the brakes.

Keep driver's foot area clear at all times, including the area under the brake pedal. Objects stored in this area may impair pedal movement which could interfere with the braking ability of the cruise control system.

Do not place your foot under the brake pedal – your foot could become caught.

Keep in mind that the cruise control is a convenience system designed to assist the driver during vehicle operation. The driver is and must always remain responsible for the vehicle's speed and for safe brake operation.

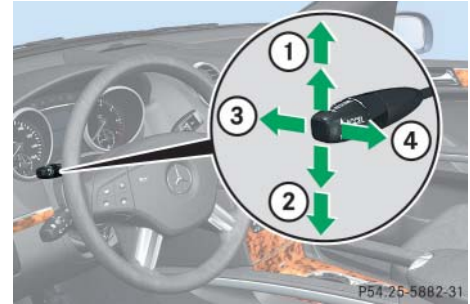

- ① Setting current or higher speed  
Adjustment in 1 mph increments (to the resistance point) or 5 mph increments (past the resistance point) (Canada: 1 km/h or 10 km/h)
- ② Setting current or lower speed  
Adjustment in 1 mph increments (to the resistance point) or 5 mph increments (past the resistance point) (Canada: 1 km/h or 10 km/h)
- ③ Canceling cruise control
- ④ Resume to last set speed

### Activating cruise control

You can activate the cruise control when the vehicle speed is above 20 mph (30 km/h).

In the following cases you cannot activate the cruise control:

- when you brake
- when you have set the parking brake
- when the automatic transmission is set to position **P**, **R**, or **N**
- if the ESP® is switched off
- if the ESP® has switched off due to a malfunction

 *The vehicle speed displayed in the speedometer can briefly vary from the speed setting for the cruise control system.*

### Setting current speed

- ▶ Accelerate or decelerate to the desired speed.
- ▶ Briefly lift the cruise control lever in direction of arrow ① or depress in direction of arrow ②.

The current speed is set.

- ▶ Remove your foot from the accelerator pedal.

The cruise control is activated.

The currently set speed appears in the status indicator of the multifunction display:

- USA only:  
Cruise XXX Miles
- Canada only:  
 XXX km/h

 *On uphill grades, the cruise control may not be able to maintain the set speed. Once the grade eases, the set speed will be resumed.*

*On downhill grades, the cruise control maintains the set speed by braking with the vehicle's braking system. In addition, on longer downhill grades the automatic transmission will downshift automatically.*

### Canceling cruise control

There are several ways to cancel the cruise control:

- ▶ Step on the brake pedal.

The cruise control is canceled. The last speed set is stored for later use.

or

- ▶ Briefly push the cruise control lever in direction of arrow ③ (▷ page 256).

The cruise control is canceled. The last speed set is stored for later use.

 *The last stored set speed is deleted when the engine is turned off.*

### Driving systems

**i** The cruise control switches off automatically when

- you step on the brake pedal
- you depress the parking brake pedal

The cruise control switches off automatically and an acoustic warning will sound when

- the vehicle speed is below 20 mph (30 km/h)
- the ESP<sup>®</sup> is in operation
- the ESP<sup>®</sup> is switched off with the ESP<sup>®</sup> switch (▷ page 105)
- the ESP<sup>®</sup> has switched off due to a malfunction (▷ page 441)
- you set the automatic transmission to **N** while driving

Observe additional messages in the multifunction display that may appear.

**!** Setting the automatic transmission to **N** while driving cancels the cruise control. However, the automatic transmission should not be set to **N** while driving except to coast when the vehicle is in danger of skidding (e.g. on icy roads).

**i** Depressing the accelerator pedal does not deactivate the cruise control. After a brief acceleration (e.g. for passing), the cruise control will resume the last set speed.

### Setting a higher speed

#### Warning!



If you increase the set vehicle speed, keep in mind that it may take a brief moment until the vehicle has reached the set speed.

Increase the set vehicle speed to a value that the prevailing road conditions and legal speed limits permit. Otherwise, sudden and unexpected acceleration of the vehicle could cause an accident and/or serious injury to you and others.

You can increase the speed in two ways.

### Adjustment in 1 mph (Canada: 1 km/h) increments

**i** The set value is increased in 1 mph (Canada: 1 km/h) increments each time you lift the cruise control lever up to the resistance point.

- ▶ Briefly lift the cruise control lever up to the resistance point in direction of arrow ① (▷ page 256).
- ▶ Release the cruise control lever.

The vehicle speed increases in increments of 1 mph (Canada: 1km/h).

### Adjustment in 5 mph (Canada: 10 km/h) increments

**i** The set value is increased in 5 mph (Canada: 10 km/h) increments each time you lift the cruise control lever past the resistance point.

- ▶ Briefly lift the cruise control lever up past the resistance point in direction of arrow ① (▷ page 256).
- ▶ Release the cruise control lever.

The vehicle speed increases in increments of 5 mph (Canada: 10 km/h).

**i** *The new speed is set and the vehicle will accelerate. Keep in mind that it may take a brief moment until the vehicle has reached the set speed.*

### Setting a lower speed

#### Warning!



If you decrease the set vehicle speed, keep in mind that it may take a brief moment until the vehicle has reached the set speed.

Decelerate the set vehicle speed to a value that the prevailing road conditions and legal speed limits permit. Otherwise, sudden and unexpected deceleration of the vehicle could cause an accident and/or serious injury to you and others.

You can reduce the speed in two ways.

**i** *When you use the cruise control lever to decelerate, the brake system will automatically brake the vehicle if the engine's braking power does not brake the vehicle sufficiently.*

### Adjustment in 1 mph (Canada: 1 km/h) increments

**i** *The set value is decreased in 1 mph (Canada: 1 km/h) increments each time you press the cruise control lever down to the resistance point.*

- ▶ Briefly press the cruise control lever down to the resistance point in direction of arrow ② (▷ page 256).
- ▶ Release the cruise control lever.

The vehicle speed decreases in increments of 1 mph (Canada: 1 km/h).

### Adjustment in 5 mph (Canada: 10 km/h) increments

**i** *The set value is decreased in 5 mph (Canada: 10 km/h) increments each time you press the cruise control lever down past the resistance point.*

- ▶ Briefly press the cruise control lever down past the resistance point in direction of arrow ② (▷ page 256).
- ▶ Release the cruise control lever.

The vehicle speed decreases in increments of 5 mph (Canada: 10 km/h).

**i** *The new speed is set and the vehicle will decelerate. Keep in mind that it may take a brief moment until the vehicle has reached the set speed.*



### Driving systems

#### Setting to last stored speed ("Resume" function)

##### Warning!



The set speed stored in memory should only be set again if prevailing road conditions permit. Possible acceleration or deceleration differences arising from returning to the preset speed could cause an accident and/or serious injury to you and others.

- ▶ Briefly pull the cruise control lever in direction of arrow ④ (▷ page 256).  
The cruise control resumes to the last set speed, or if no speed is stored, it will set and store the current speed.
- ▶ Remove your foot from the accelerator pedal.

The last set speed appears in the multi-function display for approximately 5 seconds.

#### Distronic\* (Canada only)

When activated, the Distronic adaptive cruise control system increases the driving convenience afforded by the cruise control while traveling on expressways and other major roadways.

- If the Distronic distance sensor detects a slower moving vehicle directly ahead, your vehicle speed will be reduced so that you follow that vehicle at your preset following distance.
- If there is no vehicle directly ahead of you, Distronic will function in the same way as standard cruise control (▷ page 255).

##### Warning!



Distronic is a convenience system. Its speed adjustment reduction capability is intended to make cruise control more effective and usable when traffic speeds vary. It is not however, intended to, nor does it, replace the need for extreme care. The responsibility for the vehicle's speed, distance to the preceding vehicle and, most importantly, brake operation to ensure a safe stopping distance, always remains with the driver.

Distronic cannot take road and traffic conditions into account.

Complex driving situations are not always fully recognized by Distronic. This could result in wrong or missing distance warnings.

**Warning!**

Distronic adaptive cruise control is no substitute for active driving involvement. It does not react to pedestrians or on stationary objects, nor does it recognize or predict the lane curvature or the movement of preceding vehicles.

Distronic can only apply a maximum of 20% of the vehicle's braking power.

It is the driver's responsibility at all times to be attentive to the road, weather and traffic conditions. Additionally, the driver must provide the steering, braking and other driving inputs necessary to remain in control of the vehicle.

High-frequency sources such as toll stations, speed measuring systems etc. can cause the DISTRONIC system to malfunction.

**Warning!**

Distronic requires familiarity with its operational characteristics. We strongly recommend that you review the following information carefully before operating the system.

**Warning!**

Distronic cannot take road and traffic conditions into account. Only use DISTRONIC if the road, weather and traffic conditions make it advisable to travel at a constant speed.

**Warning!**

Use of DISTRONIC can be dangerous on slippery roads. Rapid changes in tire traction can result in wheel spin and loss of control.

Distronic does not act upon adverse sight and distance conditions. Do not use DISTRONIC during conditions of fog, heavy rain, snow or sleet.

**Warning!**

Distronic cannot take weather conditions into account. Switch off DISTRONIC or do not switch it on if:

- roads are slippery or covered with snow or ice. The wheels could lose traction while braking or accelerating, and the vehicle could skid.
- the sensor is dirty or visibility is diminished due to snow, rain or fog, for example. The distance control system functionality could be impaired.

Always pay attention to surrounding traffic conditions even while DISTRONIC is switched on. Otherwise, you may not be able to recognize dangerous situations until it is too late. This could cause an accident in which you and others could be injured.

### Driving systems

#### Warning!



The “Resume” function should only be operated if the driver is fully aware of the previously set speed and wishes to resume this particular preset speed.

#### Warning!



Close attention to road and traffic conditions is imperative at all times, regardless of whether or not Distronic is activated.

Use of Distronic can be dangerous on winding roads or in heavy traffic because conditions do not allow safe driving at a continuous speed.

Distronic will not react to stationary objects in the roadway (e.g. a stopped vehicle in a traffic jam or a disabled vehicle). Distronic will also not respond to oncoming vehicles.

Switch off Distronic:

- when changing from the left to the right lane if vehicles are moving more slowly in the left lane
- when entering a turn lane or highway off ramp
- in complex driving situations, such as in highway construction zones

In these situations, Distronic will continue to maintain the set speed unless deactivated.

Distronic is designed and intended only to maintain a set speed and keep a set distance from moving objects in front of it.

**i** *USA only: This device has been approved by the FCC as a “Vehicular Radar System”. The radar sensor is intended for use in an automotive radar system only. Removal, tampering, or altering of the device will void any warranties, and is not permitted by the FCC. Do not tamper with, alter, or use in any non-approved way.*

*Any unauthorized modification to this device could void the user’s authority to operate the equipment.*

**i** *Canada only:*

*This device complies with RSS-210 of Industry Canada. Operation is subject to the following two conditions:*

- (1) This device may not cause interference, and*
- (2) this device must accept any interference received, including interference that may cause undesired operation of the device.*

*Removal, tampering, or altering of the device will void any warranties, and is not permitted. Do not tamper with, alter, or use in any non-approved way.*

*Any unauthorized modification to this device could void the user’s authority to operate the equipment.*

### Distronic displays in the speedometer dial



#### ① Set speed

If DISTRONIC is activated, one or two cruise control speed segments come on around the set speed.

**i** The vehicle speed displayed on the speedometer can briefly vary from the speed setting on the DISTRONIC system.



#### ① Set speed

#### ② Cruise control speed segments

#### ③ Speed of the vehicle ahead

If DISTRONIC detects a vehicle directly ahead, the cruise control speed segments ②, which represents the difference from the speed of the preceding vehicle ③ to the driver's selected set speed ①, appear in the speedometer.

If DISTRONIC calculates that there is a danger of collision:

- The distance warning lamp  in the instrument cluster comes on (▷ page 27).
- An intermittent warning sounds.
- ▶ Immediately apply the brake to avoid a collision.

Under no circumstances should the driver await the intermittent warning sound before braking. See the following warning note.

The intermittent warning sound ceases and the distance warning lamp  goes out when the necessary distance to the vehicle ahead is again established.

#### Warning!



An intermittent warning sounds and the distance warning lamp  in the instrument cluster is illuminated if the Distronic system calculates that the distance to the vehicle ahead and your vehicle's current speed indicate that Distronic will not be capable of slowing the vehicle sufficiently to maintain the preset following distance, which creates a danger of a collision.

Immediately brake the vehicle to increase your distance to the preceding vehicle. The warning sound is intended as a final caution in which you should intercede with your own braking inputs to avoid a potentially dangerous situation. Do not wait for the operation of the warning signal to intercede with your own braking. This will result in potentially dangerous emergency braking which will not always result in an impact being avoided.

Tailgating increases the risk of an accident.

#### Warning!



Distronic brakes your vehicle with a maximum deceleration of 6.5 ft/s<sup>2</sup> (2 m/s<sup>2</sup>). This corresponds to about 20% of the maximum deceleration of your vehicle.

Distronic brakes the vehicle in an effort to restore the preset distance or to maintain the set speed.

Keep driver's foot area clear at all times, including the area under the brake pedal. Objects stored in this area may impair pedal movement which could interfere with the braking ability of the Distronic system.



Do not place your foot under the brake pedal – your foot could become caught.

#### DISTRONIC menu in the control system

Use the DISTRONIC menu to display the current settings for your Distronic system. The information shown in the multifunction display depends on whether the Distronic system is activated or deactivated.

 For activating or deactivating the Distronic system, see “Activating Distronic” (▷ page 266) or, see “Deactivating Distronic” (▷ page 268).

For activating or deactivating the Distance warning function, see “Distance warning function\* (Canada only)” (▷ page 183).

- ▶ Press button  or  repeatedly until one of the following two displays appears in the multifunction display.

### ***Distronic activated***

When you turn DISTRONIC on, you will see the set speed in the multifunction display for about 5 seconds. When DISTRONIC is activated, the following display appears in the multifunction display.



- ① DISTRONIC activated
- ② Set vehicle speed

### ***Distronic deactivated***

When DISTRONIC is deactivated, you will see the standard DISTRONIC display in the multifunction display.

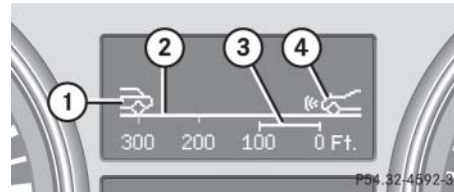

- ① Preceding vehicle, if detected
- ② Actual distance to the preceding vehicle
- ③ Preset distance threshold to the preceding vehicle
- ④ Your vehicle

### **Cruise control lever**

The DISTRONIC system is operated by means of the cruise control lever.

The cruise control lever is the uppermost lever on the left-hand side of the steering column.

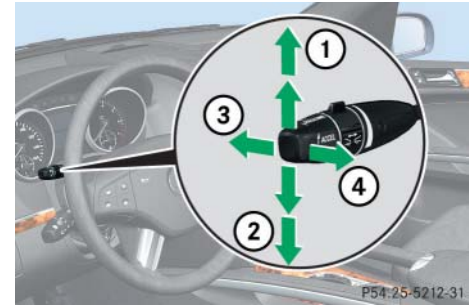

- ① Setting current or higher speed  
Adjustment in 1 mph increments (to the resistance point) or 5 mph increments (past the resistance point) (Canada: 1 km/h or 10 km/h)
- ② Setting current or lower speed  
Adjustment in 1 mph increments (to the resistance point) or 5 mph increments (past the resistance point) (Canada: 1 km/h or 10 km/h)
- ③ Deactivating DISTRONIC
- ④ Activating DISTRONIC or resuming to last set speed

### Driving systems

#### Activating Distronic

You can activate Distronic when the vehicle speed is between 20 mph (30 km/h) and 110 mph (180 km/h).

When Distronic is activated the standard display in the multifunction display will show a message such as **DISTRONIC 55 MPH**.

If Distronic has not been activated after pressing the cruise control lever, you will see the message **DISTRONIC Off** in the multifunction display.

In the following cases you cannot activate Distronic:

- up to 2 minutes after starting the engine
- when you brake
- when you have set the parking brake
- when the automatic transmission is set to position **P**, **R**, or **N**
- if the ESP® is switched off

- if the ESP® has switched off due to a malfunction

#### Setting the current speed

- ▶ Accelerate or decelerate to the desired speed.
- ▶ Briefly lift the cruise control lever in direction of arrow ① or depress in direction of arrow ② (▷ page 265).

Distronic is activated and the current speed is set.

The currently set speed appears in the status indicator of the multifunction display:

- USA only:  
DTR XXX Miles
- Canada only:  
DTR XXX km/h
- ▶ Remove your foot from the accelerator pedal.

**i** If you do not take your foot off of the accelerator pedal and continue to accelerate past the set speed, the following message will appear in the multifunction display:

DISTRONIC Override

*The distance to a slower moving vehicle in front of you will not be set. Your vehicle speed will then be determined only by the accelerator pedal position.*

#### Setting a higher speed

##### Warning!



If you increase the set vehicle speed, keep in mind that it may take a brief moment until the vehicle has reached the set speed.

Increase the set vehicle speed to a value that the prevailing road conditions and legal speed limits permit. Otherwise, sudden and unexpected acceleration of the vehicle could cause an accident and/or serious injury to you and others.

You can increase the set speed in two ways.

### **Adjustment in 1 mph (Canada: 1 km/h) increments**

**i** The set value is increased in 1 mph (Canada: 1 km/h) increments each time you lift the cruise control lever up to the resistance point.

- ▶ Briefly lift the cruise control lever up to the resistance point in direction of arrow ① (▷ page 265).
- ▶ Release the cruise control lever.

The vehicle speed increases in increments of 1 mph (Canada: 1 km/h).

### **Adjustment in 5 mph (Canada: 10 km/h) increments**

**i** The set value is increased in 5 mph (Canada: 10 km/h) increments each time you lift the cruise control lever up past the resistance point.

- ▶ Briefly lift the cruise control lever up past the resistance point in direction of arrow ① (▷ page 265).
- ▶ Release the cruise control lever.

The vehicle speed increases in increments of 5 mph (Canada: 10 km/h).

**i** The new speed is set and the vehicle will accelerate. Keep in mind that it may take a brief moment until the vehicle has reached the set speed.

### **Setting a lower speed**

#### **Warning!**



If you decrease the set vehicle speed, keep in mind that it may take a brief moment until the vehicle has reached the set speed.

Decelerate the set vehicle speed to a value that the prevailing road conditions and legal speed limits permit. Otherwise, sudden and unexpected deceleration of the vehicle could cause an accident and/or serious injury to you and others.

You can reduce the set speed in two ways.

**i** When you use the cruise control lever to decelerate, the brake system will automatically brake the vehicle if the engine's braking power does not brake the vehicle sufficiently.

### **Adjustment in 1 mph (Canada: 1 km/h) increments**

**i** The set value is decreased in 1 mph (Canada: 1 km/h) increments each time you press the cruise control lever down to the resistance point.

- ▶ Briefly press the cruise control lever down to the resistance point in direction of arrow ② (▷ page 265).
- ▶ Release the cruise control lever.

The vehicle speed decreases in increments of 1 mph (Canada: 1 km/h).



### Driving systems

#### Adjustment in 5 mph (Canada: 10 km/h) increments

**i** The set speed value is decreased in 5 mph (Canada: 10 km/h) increments each time you press the cruise control lever down past the resistance point.

- ▶ Briefly press the cruise control lever down past the resistance point in direction of arrow ② (▷ page 265).
- ▶ Release the cruise control lever.

The vehicle set speed decreases in increments of 5 mph (Canada: 10 km/h).

**i** The new speed is set and the vehicle will decelerate. Keep in mind that it may take a brief moment until the vehicle has reached the set speed.

#### Setting to last stored speed ("Resume" function)

##### Warning!



The set speed stored in memory should only be set again if prevailing road conditions permit. Possible acceleration or deceleration differences arising from returning to the preset speed could cause an accident and/or serious injury to you and others.

- ▶ Briefly pull the cruise control lever in direction of arrow ④ (▷ page 265).  
The Distronic resumes to the last set speed.
- ▶ Remove your foot from the accelerator pedal.

The last set speed or, if no speed is stored, the current set speed appears in the multifunction display for approximately 5 seconds.

#### Deactivating Distronic

There are several ways to deactivate the Distronic system:

- ▶ Step on the brake pedal.

or

- ▶ Briefly tip the cruise control lever in direction of arrow ③ (▷ page 265).

Distronic will be deactivated. The last set speed will be stored in memory.

**i** The following message appears in the multifunction display for approximately 5 seconds: **DISTRONIC Off**.

*The last stored set speed is deleted when the engine is turned off.*

**i** The Distronic switches off automatically when

- you step on the brake pedal
- you depress the parking brake pedal

In this case, the Distronic speed segments in the speedometer (▷ page 263) will go out.

- the vehicle speed falls below 20 mph (30 km/h)
- the ESP® is in operation
- the ESP® is switched off with the ESP® switch (▷ page 105)
- the ESP® has switched off due to a malfunction (▷ page 441)
- you set the automatic transmission to **N** while driving

The Distronic speed segments in the speedometer (▷ page 263) will go out and an acoustic warning will sound.

### Warning!



Distronic switches off and releases the brakes when the vehicle decelerates below the minimum speed of 20 mph (30 km/h) by operation of the system. At that time the driver must apply the brakes in order to reduce vehicle speed further or bring it to a stop.

**!** Setting the automatic transmission to **N** while driving cancels the Distronic. However, the automatic transmission should not be set to **N** while driving except to coast when the vehicle is in danger of skidding (e.g. on icy roads).

**i** Depressing the accelerator pedal does not deactivate the Distronic. After a brief acceleration (e.g. for passing), the Distronic will resume the last set speed.

### Setting the following distance in Distronic

You can set the specified following distance for Distronic by varying the time setting between 1.0 and 2.0 seconds. Using this time setting and the current speed of your vehicle, Distronic calculates and sets the required following distance to the preceding vehicle. The set distance will be shown in the multifunction display (▷ page 265).

The distance setting switch for the time setting is located on the cruise control lever on the left-hand side of the steering column.

### Warning!



It is up to the driver to exercise discretion to select the appropriate setting given road conditions, traffic, driver's preferred driving style and applicable laws and driving recommendations for safe following distance.

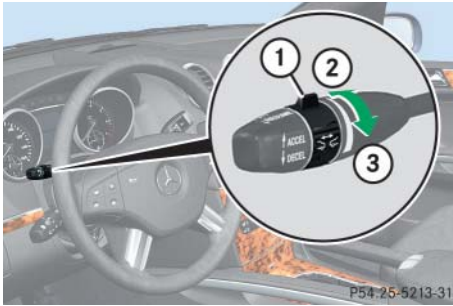

- ① Distance setting switch
- ② To decrease distance
- ③ To increase distance

### Increasing distance

Increasing the distance setting tells Distronic to maintain a greater following distance to the preceding vehicle.

- ▶ Turn distance setting switch ① in direction of arrow ③.

### Decreasing distance

Decreasing the distance setting tells Distronic to maintain a smaller following distance to the preceding vehicle.

- ▶ Turn distance setting switch ① in direction of arrow ②.

### Driving with Distronic

This section describes a number of driving situations where special precaution is required on the part of the driver. Be prepared to brake in such situations. Braking will deactivate the Distronic system.

#### Warning!



Distronic works to maintain the speed selected by the driver unless a moving obstacle proceeding directly ahead of it in the same travel direction is detected (e.g. following another vehicle ahead of you at your set distance).

This means that:

- Your vehicle can pass another vehicle after you have changed lanes.
- While in a sharp turn or if the preceding vehicle is in a sharp turn, Distronic could lose sight of the preceding vehicle. Your vehicle could then accelerate to the previously selected speed.

Distronic regulates only the distance between your vehicle and those directly ahead of it, but does not register stationary objects in the road, e.g.:

- a stopped vehicle in a traffic jam
- a disabled vehicle
- an oncoming vehicle

The driver must always be alert, observe all traffic and intercede as required by means of steering or braking the vehicle.

#### Warning!



Distronic should not be used in snowy or icy road conditions.

The most likely cause for a malfunctioning system is a dirty sensor (located behind the hood grille), especially at times of snow and ice or heavy rain. In such a case, Distronic will switch off, and the message **DISTRONIC Currently Unavailable - See Operator's Manual** appears in the multi-function display.

For cleaning and care of the Distronic sensor, see "Cleaning the Distronic\* system sensor cover" (▷ page 430).

**i** *If the message **DISTRONIC Available Again** appears during driving the dirt (e.g. slush) has dissolved; Distronic works again, if you reactivate it (▷ page 266).*

### Turns and bends

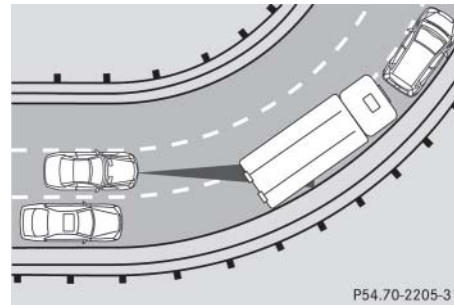

In turns or bends, Distronic may not detect a moving vehicle in front, or it may detect one too soon. This may cause your vehicle to brake late or unexpectedly.

### Offset driving

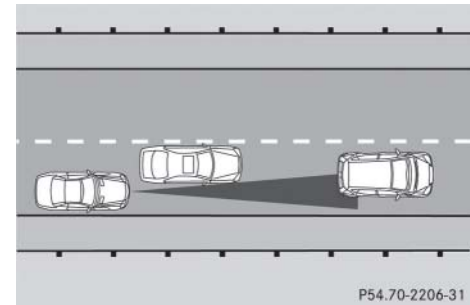

A vehicle traveling in your lane but offset from your direct line of travel may not be detected by Distronic. There will be insufficient distance to the vehicle ahead.

### Driving systems

#### Lane changing

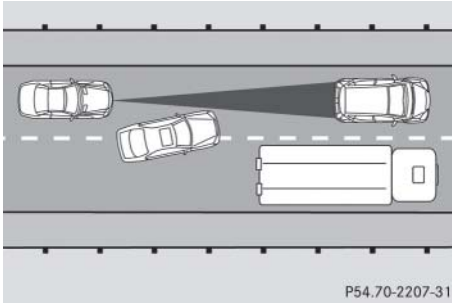

Distronic has not yet detected the vehicle changing lanes. There will be insufficient distance to the lane-changing vehicle.

#### Narrow vehicles

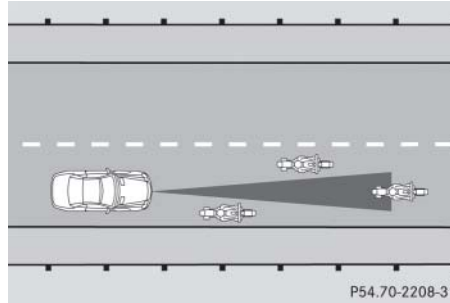

Because of their narrow profile, the vehicles traveling near the outer edges of the lane have not yet been detected by Distronic. There will be insufficient distance to the vehicles ahead.

#### Distance warning function\* (Canada only)

When Distronic\* is deactivated, this function will continue to warn you when recognizing a stationary obstacle or a slower vehicle moving in your vehicle's path and the danger of a collision exists:

- The distance warning lamp  in the instrument cluster comes on.
- An intermittent warning will sound if necessary.

If these warnings are issued, you must brake manually to maintain a safe distance and avoid a collision with the preceding vehicle.

When pressing the brake pedal, the warning sound ceases. The warning sound will also cease when the distance to the preceding vehicle is sufficient again without applying the brakes. In this case, the distance warning lamp will also go out.

**Warning!**

If the distance warning lamp  in the instrument cluster comes on while driving and/or an intermittent warning sounds, immediate attention on the part of the driver is required. As required by the traffic situation, apply the brakes and navigate around a possible obstacle. However, do not drive by relying on the distance warning function, as this will result in an emergency braking application. This will not always enable you to avoid a collision, especially when traveling on varying road surface conditions and with varying driver reaction.

Complex driving situations are not always fully recognized by the distance warning function. This could result in wrong or missed distance warnings.

- Switch on the distance warning function in the control system (▷ page 183).

**Downhill Speed Regulation (DSR)****Warning!**

Downhill Speed Regulation is a convenience system designed to assist the driver during vehicle operation. The system must be set to be appropriate for the topographical and weather conditions encountered which can change quickly. The driver is and must remain at all times responsible for the vehicle speed and for safe brake operation.

Depending on the programmed speed (▷ page 183), actual vehicle speed and gradient, switching on the DSR while driving can cause the vehicle to slow down rapidly and you may hear a sound which is caused by the activation of the vehicle's brake system through the DSR. Sudden and unexpected deceleration can result in loss of vehicle control, causing an accident and/or serious personal injury to you and others. Do not switch on the DSR in a circumstance where rapid deceleration could result in a loss of vehicle control.

For more information, see “Off-road driving” (▷ page 355).

The DSR is an aid for driving downhill. DSR regulates your vehicle's speed when driving downhill to the value set in the control system (▷ page 183). The steeper the downhill gradient is, the greater the brake application. On flat road surfaces, DSR brakes only slightly or not at all.

DSR regulates the vehicle's speed in automatic transmission positions **D**, or **R**.

 *In addition, make use of the engine's braking effect by shifting the automatic transmission into a lower gear.*

You can drive slower or faster than the set speed at any time by braking the vehicle or depressing the accelerator pedal.

### Driving systems

**i** Whenever DSR is switched on, DSR will use the programmed default speed to regulate the vehicle's speed. The default speed programmed at the factory is 4 mph (Canada: 6 km/h). The default speed can be reprogrammed using the control system (▷ page 183). The next time DSR is switched on, DSR will use the newly programmed default speed to regulate the vehicle's speed.

Once DSR is switched on, you can adjust the set speed using the cruise control lever (▷ page 265). Keep in mind that adjusting the set speed using the cruise control lever with DSR switched on will not change the programmed default speed. If DSR is switched off and then switched on again, DSR will use the programmed default speed.

Depending on the road surface and level of downhill grade, the DSR may not be able to maintain the set speed. To maintain the set speed, apply the brakes if necessary.

#### Switching the Downhill Speed Regulation on/off

The switch is located on the upper part of the center console.



#### Vehicles without enhanced off-road package\*

- ① DSR on/off
- ② Indicator lamp



#### Vehicles with enhanced off-road package\*

- ① DSR on/off
- ② Indicator lamp

**Warning!**

If the accelerator pedal is depressed while the Downhill Speed Regulation is activated, the vehicle can drive faster than the programmed set speed. You should therefore drive downhill with particular caution as it could otherwise lead to an accident and/or serious injury to you or others. Keep in mind that as soon as you remove the foot from the accelerator pedal with the DSR switched on, the DSR will start regulating the vehicle's speed including use of brakes if required. Depending on the programmed set speed, actual vehicle speed and gradient, the DSR can cause the vehicle to slow down rapidly. Sudden and unexpected deceleration can result in loss of vehicle control, causing an accident and/or serious personal injury to you and others.

**Switching Downhill Speed Regulation on**

**i** The DSR can only be switched on if the vehicle speed is below 18 mph (Canada: 30 km/h).

- ▶ Press DSR switch ① (▷ page 274).  
The indicator lamp ② comes on.

The message DSR and the set speed appear in the multifunction display.



**i** If the DSR is switched on at a speed above 18 mph (Canada: 30 km/h), the message DSR Max. Speed 18 mph (Canada: 30 km/h) appears in the multifunction display.

For information on how to program the set speed while driving, see “Adjusting Downhill Speed Regulation speed with DSR switched on” (▷ page 276).

**Switching Downhill Speed Regulation off**

- ▶ Press DSR switch ① (▷ page 274).

The indicator lamp ② goes out.

The message DSR Off appears in the multifunction display.

**i** At a speed above approximately 21 mph (Canada approximately: 35 km/h), the DSR is automatically switched off. The message DSR Off appears in the multifunction display and an acoustic signal sounds. For information on how to switch DSR on again, see “Switching Downhill Speed Regulation on” (▷ page 275).



### Driving systems

#### Adjusting Downhill Speed Regulation speed with DSR switched on

With the DSR switched on (▷ page 274), the speed setting can be changed using the cruise control lever.

The cruise control lever is the uppermost lever on the left-hand side of the steering column.

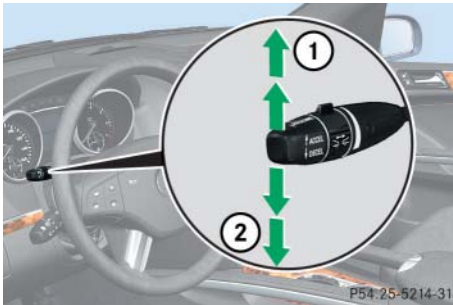

#### Cruise control lever

- ① Increase set speed
- ② Reduce set speed

You can change the set speed between 3-10 mph (Canada: 4-18 km/h).

You can increase or reduce the set speed in two ways.

#### Adjustment in 1 mph (Canada: 1 km/h) increments

**i** The set value is increased or decreased in 1 mph (Canada: 1 km/h) increments each time you lift or depress the cruise control lever to the resistance point.

Increase set speed:

- ▶ Briefly lift the cruise control lever up to the resistance point in direction of arrow ① (▷ page 276).
- ▶ Release the cruise control lever.

The vehicle speed increases in increments of 1 mph (Canada: 1 km/h).

Reduce set speed:

- ▶ Briefly press the cruise control lever down to the resistance point in direction of arrow ② (▷ page 276).
- ▶ Release the cruise control lever.

The vehicle speed decreases in increments of 1 mph (Canada: 1 km/h).

Each time the set speed is changed, DSR will appear in the multifunction display and the changed set speed is shown.

**i** The set speed is canceled when DSR is switched off. If DSR is switched on again, DSR will use the programmed default speed (▷ page 183).

### Adjustment in 5 mph (Canada: 10 km/h) increments

**i** The set value is increased or decreased in 5 mph (Canada: 10 km/h) increments each time you lift or depress the cruise control lever past the resistance point.

Increase set speed:

- ▶ Briefly lift the cruise control lever up past the resistance point in direction of arrow ① (▷ page 276).
- ▶ Release the cruise control lever.  
The vehicle speed increases in increments of 5 mph (Canada: 10 km/h).

Reduce set speed:

- ▶ Briefly press the cruise control lever down past the resistance point in direction of arrow ② (▷ page 276).

- ▶ Release the cruise control lever.

The vehicle speed decreases in increments of 5 mph (Canada: 10 km/h).

Each time the set speed is changed, DSR will appear in the multifunction display and the newly set speed is shown.

**i** The new speed is set and the vehicle will accelerate or decelerate. Keep in mind that it may take a brief moment until the vehicle has reached the new set speed.

**i** The set speed is canceled when DSR is switched off. If DSR is switched on again, DSR will use the programmed default speed (▷ page 183).

### Off-road driving program (Vehicles without enhanced off-road package\*)

The off-road driving program is designed to assist the driver when driving off-road in terrain and crossing water. The off-road driving program adjusts the engine power and shifting of the automatic transmission to be more suitable for the off-road use of the vehicle. In addition, the ABS, ESP®, and 4-ETS designed for off-road use are automatically activated.

In the following situations you should switch to the off-road driving program:

- during off-road driving
- when crossing water (▷ page 360)
- when towing up or down on steep gradients

### Driving systems

The switch is located on the upper part of the center console.



- ① Switch for off-road driving program
- ② Indicator lamp

#### Switching Off-road driving program on

- ▶ Press switch ① (▷ page 278).

Indicator lamp ② comes on. The symbol  appears in the lower multifunction display.



#### Switching Off-road driving program off

- ▶ Press switch ① again.

Indicator lamp ② goes out. The symbol  disappears.

#### Air suspension program

Your vehicle is factory equipped with vehicle level control which regulates the ride height of the vehicle. The Adaptive Damping System (ADS)\* optimizes your vehicle's suspension tuning.

- Suspension tuning: Adaptive Damping System (ADS)\* (▷ page 278)
- Vehicle level control (▷ page 279)

#### Adaptive Damping System (ADS)\*

The fine tuning of the damping and suspension is dependent on:

- your driving style
- road surface conditions
- your personal ADS settings
- your personal vehicle level settings

The ADS switch is located on the upper part of the center console.



Vehicles without enhanced off-road package\*



Vehicles with enhanced off-road package\*

- ① ADS switch
- ② Indicator lamp for SPORT setting
- ③ Indicator lamp for COMF setting

The following settings are available:

- **AUTO** (for normal driving situations)  
Indicator lamps ② and ③ are off.
  - **SPORT** (for sporty driving)  
Indicator lamp ② comes on.  
With the ADS SPORT setting, the vehicle is lowered approximately 0.6 in (15 mm).
  - **COMF** (for comfort driving)  
Indicator lamp ③ comes on.
- ▶ Start the engine (▷ page 41).
- ▶ Press ADS switch ① repeatedly until the desired suspension tuning is reached.

**i** The setting is stored when you turn off the engine.

### Vehicle level control

The vehicle level control automatically regulates the ride height to

- reduce fuel consumption
- improve driving stability by lowering the center of gravity

The vehicle automatically regulates its ride height based on the set vehicle height and the current speed:

- As your driving speed increases, the vehicle is lowered by increments until it reaches high-speed level.

Vehicles with ADS\*:

- If you are driving with the ADS setting COMF or AUTO, the vehicle is raised back to highway level as your driving speed decreases.
- You can select the high-speed level via the ADS setting SPORT. In ADS Sport, the vehicle is lowered directly to high-speed level as your driving speed increases.

### Driving systems

The parked vehicle begins adjusting to the set vehicle level as soon the doors and tailgate are

- unlocked
- or
- opened or closed with the vehicle unlocked

In order to operate the vehicle level control switch (▷ page 281), however, the engine must be running.

#### Warning!



Make sure that no one is near the wheel housing or under the vehicle when you lower the vehicle while it is standing still. Limbs could become wedged into or under the vehicle.

For safety reasons, the vehicle can only be lowered with all doors and the tailgate closed. Lowering is interrupted if a door or the tailgate is opened and will continue after the door is closed again.

#### Warning!



Please be aware that by raising the vehicle level, the center of gravity also rises. Therefore, always ensure that the vehicle level is as low as possible. With higher ride height the ESP® may activate earlier in certain situations.

Adapt your speed and driving to possible changed driving behavior of the vehicle after changing the vehicle level. The ESP® cannot prevent accidents, including those resulting from excessive speed. The ESP® cannot prevent the natural laws of physics from acting on the vehicle.

**!** *Keep in mind that in rough or uneven terrain, adjusting the vehicle to a lower level may cause the vehicle underbody to come in contact with the ground and result in damage to the vehicle underbody. Always make sure the vehicle has sufficient ground clearance before adjusting it to a lower level.*

**!** *Before jacking up the vehicle with equipment that lifts one or more of the wheels completely off of the ground, remove the SmartKey from the starter switch.*

**!** *Please also note the information in the section on towing (▷ page 538).*

For information on off-road driving, see “Off-road driving” (▷ page 355).

### Vehicles without enhanced Off-road Package\*

The switch is located on the upper part of the center console.



- ① Vehicle level switch
- ② Indicator lamp

### Basic settings

The following vehicle chassis ride heights can be selected using the vehicle level switch in the center console:

Level	Driving situation
Raised	For off-road driving or driving in rough terrain. The indicator lamp is on.
Highway	For driving on paved roads in fair or better condition. The indicator lamp is off.

**i** The third available level is the high-speed level that is set automatically.

The following is the approximate change in ride height for each of the level settings:

Level	Ride height
Raised	+ 3.1 in (80 mm)
Highway	+/- 0 in (0 mm)
High-speed	- 0.6 in (-15 mm)

**i** Vehicles with ADS\*: Depending on the ADS setting (▷ page 278), the vehicle will be lowered to the high-speed level when traveling at higher speeds. At speeds below 40 mph (64 km/h) at the latest, it will be returned to the highway level.

**i** The high-speed level is not available if towing a trailer. For more information on towing a trailer, see “Trailer towing” (▷ page 364).

### Driving systems

#### **Raised level**

Only select the raised level if appropriate for the driving situation encountered.

Otherwise:

- fuel consumption may increase
- handling characteristics of the vehicle may be unfavorable

**i** You can select the raised level at speeds up to 40 mph (64 km/h). At higher speeds, the message  Level Selection Not Permitted appears in the multifunction display.

- ▶ Start the engine (▷ page 41).





If indicator lamp ② (▷ page 281) is off.

- ▶ Press switch ① (▷ page 281).

Indicator lamp ② flashes. The vehicle adjusts to the raised level.

The following message appears in the multifunction display while the level is being set:



**i** The message can be cleared by pressing the    or button  on the multifunction steering wheel.

When the raised level is reached, indicator lamp ② (▷ page 281) comes on continuously and the following message appears in the multifunction display for 5 seconds:



#### **Highway level**

**!** Keep in mind that in rough or uneven roads, adjusting the vehicle to a lower level may cause the vehicle underbody to come in contact with the road and result in damage to the vehicle underbody. Always make sure the vehicle has sufficient ground clearance before adjusting it to a lower level.

- ▶ Start the engine (▷ page 41).

If indicator lamp ② (▷ page 281) is on.

- ▶ Press switch ① (▷ page 281).

Indicator lamp ② flashes. The vehicle adjusts to the highway level.

The following message appears in the multifunction display while the level is being set:

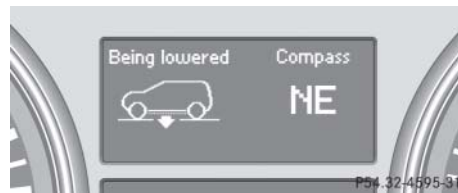

**i** The message can be cleared by pressing the or button on the multifunction steering wheel.

When the highway level is reached, indicator lamp ② (> page 281) goes out. The following message appears in the multifunction display for 5 seconds:

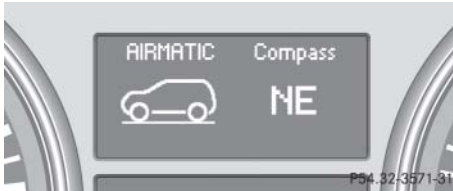

**i** The vehicle is lowered automatically to the highway level if:

- the vehicle speed is above 55 mph (88 km/h)
- the speed stays between 40 mph (64 km/h) and 55 mph (88 km/h) for approximately 20 seconds

### Vehicles with enhanced Off-road Package\*

The switch is located on the upper part of the center console.



- ① Rotatable outer adjustment ring
- ② Set higher vehicle level
- ③ Indicator lamps
- ④ Set lower vehicle level

### Basic settings

The following vehicle chassis ride heights can be selected using the vehicle level switch in the center console:

Level	Driving situation
Off-road 3	For slow driving on rough terrain. Lower, middle and upper indicator lamps are on.
Off-road 2	Off-road driving. Lower and middle indicator lamps are on.
Off-road 1	For driving on easy terrain. Lower indicator lamp is on.
Highway	For normal driving. Indicator lamps are off.

**i** Another available level is the high-speed level that is set automatically.



### Driving systems

The following is the approximate change in ride height for each of the level settings:

Level	Ride height
Off-road 3	+ 4.3 in (110 mm)
Off-road 2	+ 3.1 in (80 mm)
Off-road 1	+ 1.2 in (30 mm)
Highway	+/- 0 in (0 mm)
High-speed	- 0.6 in (-15 mm)

**i** *Vehicles with ADS\*:*

Depending on the ADS setting (▷ page 278), the vehicle will be lowered to the high-speed level when traveling at higher speeds. At speeds below 40 mph (64 km/h) at the latest, it will be returned to the highway level.

**i** *The high-speed level is not available if towing a trailer. For more information on towing a trailer, see "Trailer towing" (▷ page 364).*

You can only select the off-road levels below a certain speed. At higher speeds, the message **Level Selection Not Permitted** appears in the multifunction display.

You can select

- Off-road level 1: selectable below 60 mph (96 km/h)
- Off-road level 2: selectable below 40 mph (64 km/h)
- Off-road level 3: selectable below 20 mph (30 km/h)

### Off-road levels

#### Warning!



Vehicle off-road level 3 is not intended for use on paved roads. This vehicle level is only intended for driving on rough terrain under special requirements.

- Only select off-road level 3 if you are driving on rough terrain under especially difficult conditions.
- Adapt your driving style to the modified conditions.
- Do not exceed a speed of 20 mph (30 km/h).
- Avoid extreme, quick steering movements.
- Keep in mind that the vehicle's driving characteristics are modified.

You should therefore drive in off-road level 3 with particular caution as it could otherwise lead to an accident and/or serious injury to you or others.

If you are driving too fast while using off-road level 3, you will see the following message in the multifunction display:

- Reduce speed to under 20 MPH (30 km/h)

Additional an acoustic signal sounds.

**i** This message cannot be deactivated.

For more information, see “Display message” (▷ page 487).

Only use the off-road levels when necessary.

Otherwise:

- fuel consumption may increase
  - handling characteristics of the vehicle may be unfavorable
- ▶ Start the engine (▷ page 41).

▶ Turn outer adjustment ring ① (▷ page 283) repeatedly until indicator lamp ③ (▷ page 283) of the desired level flashes.

- Off-road level 1, lower indicator lamp flashes
- Off-road level 2, lower and middle indicator lamps flashes
- Off-road level 3, lower, middle and upper indicator lamps flashes

The vehicle adjusts to the corresponding off-road level.

For example, the following message appears in the multifunction display while the level is being set:



The vehicle is raised from off-road level 1 to off-road level 2.

**i** The message can be cleared by pressing the or button on the multifunction steering wheel.

When the off-road level 2 is reached, the following message appears in the multifunction display for 5 seconds:



The lower and middle indicator lamps ③ (▷ page 283) comes on continuously.

While the vehicle is adjusting from off-road level 2 to off-road level 3, you will see, for example, the following message in the multifunction display:



### Driving systems

▷▷ Once off-road level 3 is reached, you will see, for example, the following message in the multifunction display:



**i** The message *Max. 20 MPH* reminds you of the maximum permissible driving speed with off-road level 3.

If you drive faster than 20 mph (30 km/h) for a short period while using off-road level 3, the following message appears in the multifunction display:



Off-road level 3 is canceled.

- If you continue to increase your speed, the message remains in the multifunction display.

The new level will not be shown until the vehicle has been able to adjust to a level appropriate for the speed at which you are currently driving.

- If you maintain or reduce your speed, you will see, for example, the following message in the multifunction display while the vehicle is lowering:



The vehicle is lowered to off-road level 2.

Once off-road level 2 is reached, you will see, for example, the following message in the multifunction display:



While driving, the vehicle is automatically lowered as follows:

- At speeds above 55 mph (88 km/h) or if the speed lies between 40 mph (64 km/h) and 55 mph (88 km/h) for approximately 20 seconds, the off-road level 2 setting is canceled and the vehicle is lowered to the off-road level 1.

You will see, for example, the following message in the multifunction display:



- At speeds above 60 mph (96 km/h) the off-road level 1 setting is canceled and the vehicle is lowered to the highway level.

You will see, for example, the following message in the multifunction display:

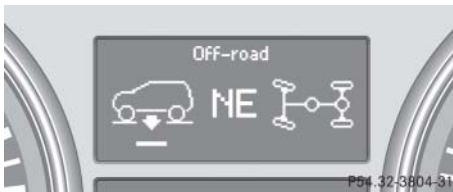

- Depending on the ADS setting (▷ page 278), the vehicle will be lowered to the high-speed level when traveling at higher speeds. At speeds below 25 mph (40 km/h) at the latest, it will be returned to the highway level.

**i** The setting is stored when you turn off the engine.

### Highway level

**!** Keep in mind that in rough or uneven roads, adjusting the vehicle to a lower level may cause the vehicle underbody to come in contact with the road and result in damage to the vehicle underbody. Always make sure the vehicle has sufficient ground clearance before adjusting it to a lower level.

- Start the engine (▷ page 41).

If one or more of the indicator lamps (▷ page 281) are on:

- Press switch ② (▷ page 283) repeatedly until all lit indicator lamps ③ flash.

The vehicle adjusts to the highway level.

The following message appears in the multifunction display while the level is being set:



**i** The message can be cleared by pressing the or button on the multifunction steering wheel.

### Driving systems

When the highway level is reached, the indicator lamps ③ (▷ page 281) goes out. The following message appears in the multifunction display for 5 seconds:



**i** The vehicle is lowered automatically to the highway level if the vehicle speed is above 60 mph (96 km/h).

### Parktronic system\*

#### Warning!



Parktronic is a supplemental system. It is not intended to, nor does it replace, the need for extreme care. The responsibility during parking and other critical maneuvers always remains with the driver.

Special attention must be paid to objects with smooth surfaces or low silhouettes (e.g. trailer couplings, painted posts, or road curbs). Such objects may not be detected by the system and can damage the vehicle.

The operational function of the Parktronic system can be affected by dirty sensors, especially at times of snow and ice. See “Cleaning the Parktronic system sensors” (▷ page 430).

Interference caused by other ultrasonic signals (e.g. working jackhammers, car wash, or the air brakes of trucks) can cause the system to send erratic indications, and should be taken into consideration.

#### Warning!



Make sure no persons or animals are in the area in which you are maneuvering. You could otherwise injure them.

The Parktronic system is an electronic parking aid and designed to assist the driver during parking maneuvers. It visually and audibly indicates the relative distance between the vehicle and an obstacle.

The Parktronic system is automatically activated when you

- switch on the ignition or start the engine

and

- release the parking brake

and

- set the automatic transmission to position **D**, **R**, or **N**

The Parktronic system deactivates at vehicle speeds exceeding approximately 11 mph (18 km/h). At lower vehicle speeds the Parktronic system turns on again.

The Parktronic system also deactivates when you set the automatic transmission to position **P** or depress the parking brake pedal.

The Parktronic system monitors the surroundings of your vehicle with six sensors in the front bumper and four sensors in the rear bumper.

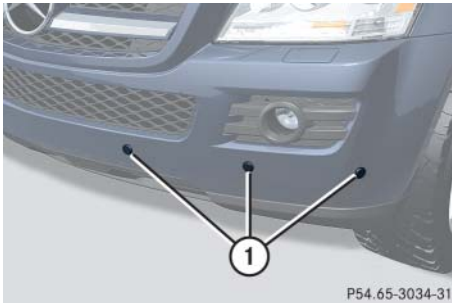

P54.65-3034-31

① Sensors in the front bumper

### Range of the sensors

To function properly, the sensors must be free of dirt, ice, snow and slush. Clean the sensors regularly, being careful not to scratch or damaging the sensors, see “Cleaning the Parktronic\* system sensors” (▷ page 430).

**!** *During parking maneuvers, pay special attention to objects located above or below the height of the sensors (e.g. planters or trailer hitches). The Parktronic system will not detect such objects at close range and damage to your vehicle or the object may result.*

*Ultrasonic signals from outside sources (e.g. working jackhammers, car wash or the air brakes of trucks) may impair the operation of the Parktronic system.*

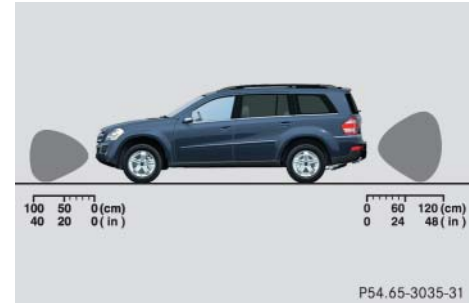

P54.65-3035-31

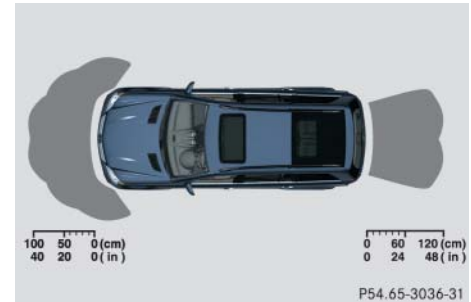

P54.65-3036-31

## Driving systems

### Front sensors

Center	<b>approx. 40 in (100 cm)</b>
Corners	<b>approx. 24 in (60 cm)</b>

### Rear sensors

Center	<b>approx. 48 in (120 cm)</b>
Corners	<b>approx. 32 in (80 cm)</b>

### Minimum distance

Center	<b>approx. 8 in (20 cm)</b>
Corners	<b>approx. 6 in (15 cm)</b>

If the system detects an obstacle in this range, all the distance warning segments illuminate and you hear a warning signal. If the obstacle is closer than the minimum distance, the actual distance may no longer be indicated by the system.

### Warning indicators

Visual signals indicate to the driver the relative distance between the sensors and an obstacle. The warning indicator for the front area is located above the center air vents in the dashboard. The warning indicator for the rear area is located in the rear passenger compartment under the roof.

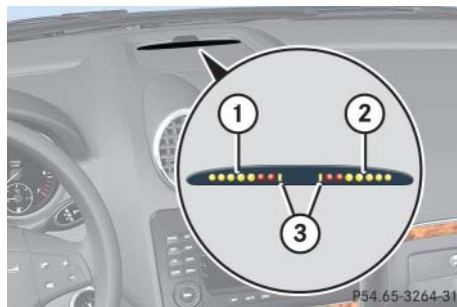

#### Front area warning indicator

- ① Left side of the vehicle
- ② Right side of the vehicle
- ③ Readiness indicators

Each warning indicator is divided into five yellow and two red distance segments for either side of the vehicle. The Parktronic system is operational when the readiness indicators ③ are illuminated.

The current transmission position determines which warning indicator will be activated.

Automatic transmission position	Warning indicator
<b>D</b>	Front area activated
<b>R or N</b>	Front and rear area activated
<b>P</b>	Neither activated

As your vehicle approaches an object, one or more distance segments will illuminate, depending on the distance. When the seventh red distance segment illuminates, you have reached the minimum distance.

- **Front area:** An intermittent acoustic warning lasting a maximum of 2 seconds will sound as the first red distance segment illuminates and a constant acoustic warning lasting a maximum of 2 seconds will sound for the second red distance segment. The signal is canceled when the automatic transmission is set to position **P**, or the parking brake is set.
- **Rear area:** An intermittent acoustic warning lasting a maximum of 2 seconds will sound as the first red distance segment illuminates and a constant acoustic warning lasting a maximum of 2 seconds will sound for the second red distance segment. The signal is canceled when the automatic transmission is set to position **D**, **P**, or the parking brake is set.

### Switching the Parktronic system\* on/off

You can switch off the Parktronic system manually.

The Parktronic switch is located on the upper part of the center console.



### Vehicles without enhanced off-road package\*

- ① Parktronic switch
- ② Indicator lamp



### Vehicles with enhanced off-road package\*

- ① Parktronic switch
- ② Indicator lamp



### Driving systems

#### Switching off

- ▶ Press Parktronic switch ①.
- Indicator lamp ② comes on.

#### Switching on

- ▶ Press Parktronic switch ① once more.
- Indicator lamp ② goes out.

**i** *The Parktronic system switches on automatically when you switch on the ignition (▷ page 42).*

*Vehicles with original equipment Mercedes-Benz Trailer Hitch Kit:  
The rear Parktronic sensor will automatically disengage when towing a trailer.*

#### Parktronic system\* malfunction

If only the red distance segments illuminate and an acoustic warning sounds, there is a malfunction in the Parktronic system. The Parktronic system will automatically switch off after 20 seconds and the indicator lamp in the Parktronic switch comes on.

- ▶ Have the Parktronic system checked by an authorized Mercedes-Benz Light Truck Center as soon as possible.

If only the red distance segments illuminate and no acoustic warning sounds, the Parktronic system sensors are dirty (e.g. slush, snow or ice) or there is an interference from other radio or ultrasonic signals (e.g. working jackhammers, car wash or the air brakes of trucks). The Parktronic system will automatically switch off after 20 seconds and the indicator lamp in the Parktronic switch comes on.

- ▶ Switch off the ignition (▷ page 42).
  - ▶ Clean the Parktronic system sensors (▷ page 430).
  - ▶ Switch on the ignition (▷ page 42).
- or
- ▶ Check the Parktronic system operation at another location to rule out interference from outside radio or ultrasonic signals.

## Rear view camera\*

**Warning!**

The rear view camera is only an aid and may display obstacles from a distorted perspective or inaccurately, or may not display obstacles at all. The rear view camera does not relieve you of the responsibility to be cautious, take care and pay careful attention.

The rear view camera may not show objects which are:

- very close to the rear bumper
- under the rear bumper
- above the tailgate handle

You are responsible for safety at all times and must continue to pay attention to the immediate surroundings when parking and maneuvering. This includes the area behind, in front of and beside the vehicle. Otherwise you could endanger yourself or others.

**Warning!**

Make sure that no persons or animals are in or near the area in which you are parking/maneuvering. Otherwise, they could be injured.

**Warning!**

The rear view camera either will not function or will not function to its full capability if:

- the tailgate is open
- it is raining very hard, snowing or foggy
- it is night or you are parking/maneuvering your vehicle in an area where it is very dark
- the camera is exposed to a very bright white light
- the immediate surroundings are illuminated with fluorescent light (the display may flicker)

- there is a sudden change in temperature, e.g. if you drive into a heated garage from the cold (lens condensation)
- the camera lens is dirty or covered
- the rear of your vehicle is damaged

In this case, have the position and setting of the camera checked by a qualified specialist workshop.

Mercedes-Benz recommends that you visit a Mercedes-Benz Light Truck Center for this purpose.

Do not use the rear view camera in these situations. Otherwise you could injure yourself or others and/or damage property including your vehicle while parking/maneuvering.

### Driving systems

The rear view camera is an optical parking aid. It shows you the area behind the vehicle in the COMAND system display when reverse gear **R** is engaged, for example during parallel parking.

The rear view camera is located near the tailgate handle.



① Rear view camera

#### Switching the rear view camera on and off

- ▶ Switch on the ignition (▷ page 42).
- ▶ Shift the automatic transmission in position **R** (▷ page 191).

The area behind the vehicle appears in the COMAND system display.

**i** The area behind the vehicle is shown in the COMAND system display as a mirror image, like in the rear view mirror.

**i** The image from the rear view camera will no longer be displayed if you select another function on the COMAND system while reverse gear **R** is engaged. To display the image again, disengage and reengage reverse gear **R**.

- ▶ Shift the automatic transmission into **P**, **N** or **D** to switch off the rear view camera.

## ▼ Loading

### Carriers\*

#### Warning!



Only use carriers\* when the crossbars have been completely mounted. The left and right roof rails are only stabilized by means of the crossbars mounted.

Follow the manufacturer's installation instructions. Otherwise, an improperly attached roof rack system or its load could become detached from the vehicle.

Do not exceed the maximum roof load of 198 lb (90 kg).

Take into consideration that when the roof is loaded, the handling characteristics are different from those when operating the vehicles without a roof loaded.

**!** Load the carriers\* in such a way that the vehicle cannot be damaged while driving.

Make sure

- the tailgate can be completely opened
- the tilt/sliding sunroof can be completely raised at the rear

**i** The following accessories are available for your Mercedes-Benz:

- Roof Cargo Container – Small, Medium, or Large
- Ski and Snowboard Carrier – Standard
- Ski and Snowboard Carrier – Deluxe (Only in connection with corresponding adapter.)

For more information on Mercedes-Benz accessories, contact your authorized Mercedes-Benz Light Truck Center.



P77.40-2087-31

#### Roof rails

#### Crossbars\*

The maximum roof load (▷ page 561) of any add-on roof equipment is reduced by the unladen weight of the crossbars (13.7 lbs/6.2 kg).

Four keys and an Allen wrench required for installing and removing are included with the crossbars.

**i** The keys and the Allen wrench are stored with the vehicle tool kit under the cargo compartment floor (▷ page 490).

### Loading

**i** Spare parts are available as Mercedes-Benz accessories. Contact your authorized Mercedes-Benz Light Truck Center.

#### Installing the crossbars

##### Warning!



Please follow these installation instructions carefully. Caution should be exercised to avoid damage to the vehicle while installing the crossbars. Also, be careful not to injure yourself or others while installing and adjusting the crossbars or loading items on them.

Each individual step of the installation instructions, the warning notices, the general safety precautions and the instructions for use must be followed exactly. If the crossbars are not mounted correctly, they and the objects attached to them could come loose from your vehicle and cause an

accident, thereby injuring you and other persons and/or causing damage to property, including damage to your vehicle.

##### Warning!



Every time the crossbars are mounted, before you set off on a journey and periodically during longer journeys, check all the screws on the bars to make sure that they are secure, and tighten them if necessary. Repeat these checks at regular intervals as road-surface conditions dictate, and at least after every 1500 miles (2500 km) of continuous use.

Otherwise, the crossbars, mounted accessories and the objects attached to them could come loose from the vehicle causing an accident, thereby injuring you and other persons and/or causing damage to property, including damage to your vehicle.

Do not use lubricant on the screws of the crossbars. The screws could work loose and the crossbars could become detached from your vehicle, together with the objects attached to them causing an accident, thereby injuring you and other persons and/or causing damage to property, including damage to your vehicle.

##### Warning!



Only install the crossbars at the exact locations designated on the roof rails. The designated locations for the front crossbars are between the markings engraved on the inside of the roof rails (▷ page 298). The designated locations for the rear crossbars are between the gaps on the roof rails (▷ page 298).

Otherwise, the crossbars (▷ page 298), mounted accessories and the objects attached to them could come loose from the vehicle causing an accident, thereby injuring you and other persons and/or causing damage to property, including damage to your vehicle.

**Warning!**

A roof load creates a greater surface area exposed to the wind and causes the vehicle to have a higher center of gravity, thereby changing the vehicle's driving characteristics. Accordingly, the additional weight on the roof of the vehicle can have a detrimental effect on braking, cornering and acceleration.

Never exceed the maximum permissible roof load or the maximum permissible vehicle weight, even when accessories for the crossbars (e.g. ski racks, bicycle racks, etc.) are being used. Overloading the vehicle could result in an accident. When calculating the weight placed on the roof please make sure to add the weight of the crossbars, accessory racks and the load carried together.

Always adapt your driving style to the road, traffic and weather conditions, and drive with added caution when the roof is loaded.

Always drive with extreme care when the roof rack is loaded. Take into consideration that when the roof rack is loaded, the handling characteristics are different from those when operating the vehicles without a roof rack loaded.

**Warning!**

Do not use accessories which have not been approved by Mercedes-Benz for use in conjunction with these crossbars. If non-approved accessories are used, these accessories and/or the objects attached to them could come loose from the vehicle, thereby injuring you and other persons and/or causing damage to property, including damage to your vehicle.

**!** *Have a second person assist you when installing the crossbars. The vehicle could otherwise be damaged.*

**!** *Objects attached to the crossbar system's accessories must not be allowed to restrict the movement of the tilt/sliding sunroof. The tilt/sliding sunroof could otherwise be damaged when it is raised.*

## Loading

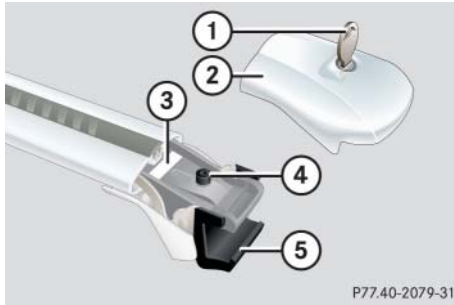

P77.40-2079-31

- ① Key
- ② Cover cap
- ③ Sticker FRONT (or REAR)
- ④ Screw for clamping claw
- ⑤ Clamping claw

The front and rear crossbars are of different lengths. Please pay close attention to stickers ③ FRONT and REAR on the crossbars.

- ▶ Unlock cover cap ② with key ①.
- ▶ Remove cover cap ②.

Sticker ③ indicating the location, FRONT or REAR, becomes visible.

- ▶ Turn screw ④ counterclockwise with the included Allen wrench until clamping claw ⑤ is wide open.

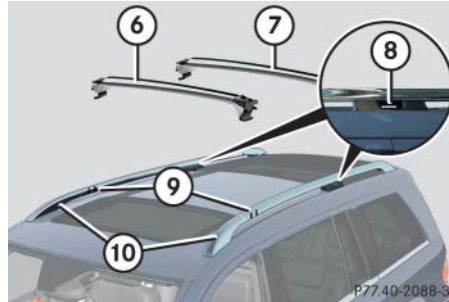

P77.40-2088-31

- ⑥ Front crossbar
- ⑦ Rear crossbar
- ⑧ Gaps
- ⑨ Markings
- ⑩ Roof rails

- ▶ Place front crossbar ⑥ between markings ⑨ on roof rails ⑩.

**i** Markings ⑨ are located on the inside of each roof rail, indicated by the white lines in the illustration.

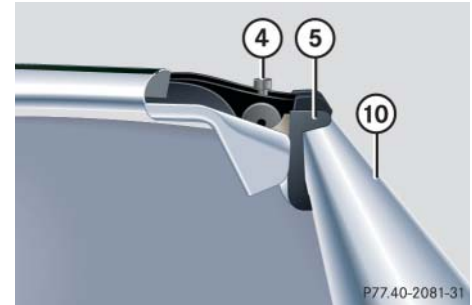

P77.40-2081-31

- ④ Screw for clamping claw
- ⑤ Clamping claw
- ⑩ Roof rail

- ▶ Make sure clamping claw ⑤ lies flush against the inside of roof rail ⑩ as shown in the illustration.

If necessary, adjust clamping width of crossbars (▶ page 299).

- ▶ Slightly tighten screw ④ on both sides by turning it clockwise.

- ▶ Place rear crossbar (7) on roof rails (10) in such a way that the clamping claws reach into gaps (8) (▷ page 298) on the roof rails.
- ▶ Make sure clamping claw (5) lies flush against the inside of roof rail (10) as shown in the illustration (▷ page 298).  
If necessary, adjust clamping width of crossbars (▷ page 299).
- ▶ Slightly tighten screw (4) on both sides by turning it clockwise.
- ▶ On the front and rear crossbars tighten screws (4). Observe a tightening torque of 4 lb-ft (6 Nm).

### Warning!



Have the tightening torque checked after mounting the crossbars. The screws could come loose if they are not tightened to a torque of 4 lb-ft (6 Nm).

- ▶ Attach cover caps (▷ page 298) and lock them.

- ▶ Store key and Allen wrench back into the storage well (▷ page 490).

### Adjusting the clamping widths of the crossbars

#### Warning!



Only install the crossbars at the exact locations designated on the roof rails. The designated locations for the front crossbars are between the markings engraved on the inside of the roof rails (▷ page 298). The designated locations for the rear crossbars are between the gaps on the roof rails (▷ page 298).

Otherwise, the crossbars (▷ page 298), mounted accessories and the objects attached to them could come loose from the vehicle causing an accident, thereby injuring you and other persons and/or causing damage to property, including damage to your vehicle.

The clamping widths of the crossbars are factory set for your vehicle. These clamping widths are solely intended for the designated positions.

Only install the crossbars at the designated locations and pay attention to the stickers (3) FRONT and REAR (▷ page 298).

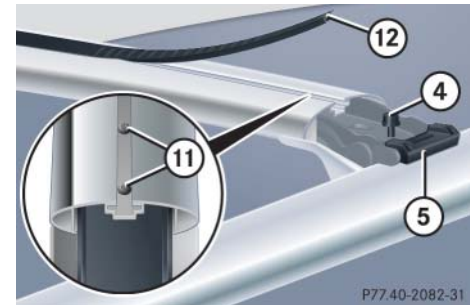

- ④ Screw for clamping claw
- ⑤ Clamping claw
- ⑪ Screws for adjusting clamping width (2 in total for each side)
- ⑫ Cover strip





### Loading

- ▶▶ Pull cover strip ⑫ out of groove until you see screws ⑪ on each end of the crossbar.
- ▶ Turn screws ⑪ on both sides counterclockwise approximately 2 rotations.
- ▶ Place the crossbar at designated locations (▷ page 298) on roof rails.
- ▶ On both sides, make sure the clamping claws ⑤ lie flush against the roof rails. If necessary pull out or push in the clamping claws ⑤.
- ▶ Tighten screws ⑪. Observe a tightening torque of 4 lb-ft (6 Nm).  
The width of the clamping claws is correctly adjusted.

#### Warning!



Have the tightening torque checked after mounting the crossbars. The screws could come loose if they are not tightened to a torque of 4 lb-ft (6 Nm).

- ▶ Press cover strip ⑫ piece by piece into groove of crossbar.
- ▶ Install the crossbars as described (▷ page 298).

### Removing the crossbars

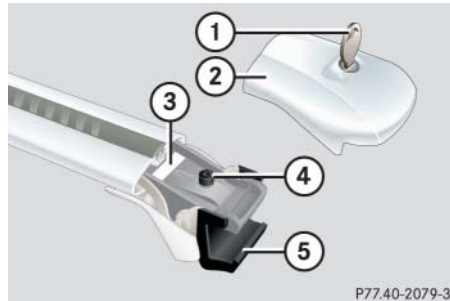

- ① Key
- ② Cover cap
- ③ Sticker FRONT (or REAR)
- ④ Screw for clamping claw
- ⑤ Clamping claw

- ▶ Unlock cover cap ② with key ①.
- ▶ Remove cover cap ②.

- ▶ Turn screws for clamping claws ⑤ counterclockwise until the crossbars can be lifted from the roof rails.

### Shortening the cover strip

The cover strips reduce the wind noise caused by the crossbars. In order to install add-on roof equipment, it may be necessary to shorten the cover strips.

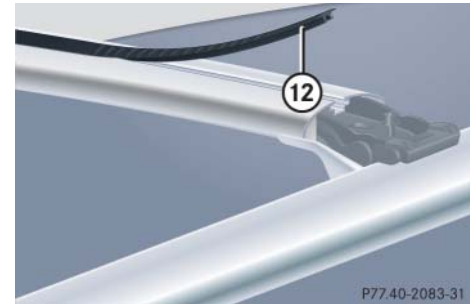

- ⑫ Cover strip

- ▶ Pull cover strip ⑫ out of groove.

- ▶ Attach add-on roof equipment to the crossbars.
- ▶ Place cover strip ⑫ flush against the add-on roof equipment, and mark the end of crossbar on cover strip.
- ▶ Cut off cover strip ⑫ at marked location.
- ▶ Press cover strip ⑫ piece by piece into groove of the crossbar.

**i** Cover strips are available as Mercedes-Benz accessories. Contact your Mercedes-Benz Light Truck Center.

### Loading instructions

#### Warning!



Always fasten items being carried as securely as possible using cargo tie-down rings and fastening materials appropriate for the weight and size of the load.

In an accident, during hard braking or sudden maneuvers, loose items will be thrown around inside the vehicle, and can cause injury to vehicle occupants unless the items are securely fastened in the vehicle.

To help avoid personal injury during a collision or sudden maneuver, always use tie down rings, and if so equipped, always use the cargo net\* when transporting cargo.

Never drive vehicle with the tailgate open. Deadly carbon monoxide (CO) gases may enter vehicle interior resulting in unconsciousness and death.

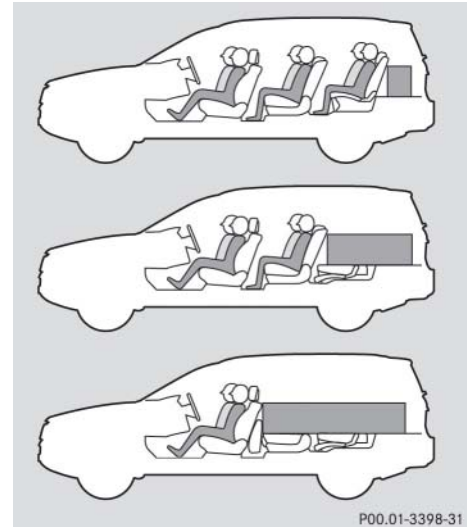

P00.01-3398-31

### Load distribution

### Loading

The gross vehicle weight which is the weight of the vehicle including fuel, tools, spare wheel, installed accessories, passengers and luggage/cargo must never exceed the load limit and Gross Vehicle Weight Rating (GVWR) for your vehicle as specified on the placard located on the driver's door B-pillar (▷ page 550). In addition, the load must be distributed in such a way so that the weight on each axle never exceeds the Gross Axle Weight Rating (GAWR) for the front and rear axle. The GVWR and GAWR for your vehicle are indicated on the certification label which can be found on the driver's door B-pillar (▷ page 550).

For more information, see "Tire and Load Information" (▷ page 388).

The handling characteristics of a fully loaded vehicle depend greatly on the load distribution. It is therefore recommended to load the vehicle according to the illustrations shown, with the heaviest items being placed towards the front of the vehicle.

Please pay attention to and comply with the following instructions when loading the vehicle and transporting cargo:

- Always place items being carried against front or rear seat backrests, and fasten them as securely as possible.
- The heaviest portion of the cargo should always be kept as low as possible against front or rear seat backrests.

For additional safety when transporting cargo while the rear seats are unoccupied, fasten the outer seat belts crosswise into the opposite side buckles.



**i** The cargo compartment is the preferred place to carry objects. The expanded cargo compartment (▷ page 304) should only be used for items which do not fit in the cargo compartment alone.

### Cargo tie-down rings

Your vehicle is equipped with eight cargo tie-down rings.

Carefully secure cargo by applying even load on all rings with rope of sufficient strength to hold down the cargo.

**i** While the cargo net\* (▷ page 312) will help protect you from smaller objects, it cannot prevent the movement of large, heavier objects into the passenger compartment in an accident, during hard braking or sudden maneuvers. Such items must be properly secured using the cargo tie-down rings in the cargo compartment floor.

**Cargo compartment**

Four cargo tie-down rings are located in the cargo compartment.



① Cargo tie-down ring

**Second seat-row**

Two cargo tie-down rings are located in the footwell behind the driver's and passenger seat.



① Cargo tie-down ring

**Third seat-row**

Two cargo tie-down rings are located behind the third-row seat backrest.

For information on how to fold the third-row seats, see "Expanding cargo compartment" (▷ page 304).



① Cargo tie-down ring

The maximum permissible weight per cargo tie-down ring is 331 lb (150 kg).

### Loading

#### Hooks

Two hooks are located on the rear compartment trim panels, one on each side.



#### ① Hook

Use the hooks to secure light weight items only. The maximum permissible weight per hook is 9 lb (4 kg).

#### Expanding cargo compartment

You can separately fold the left and right rear seat backrests to expand the cargo compartment.

#### Warning!



When expanding the cargo compartment, always fully fold the corresponding seats and, if so equipped, always use the cargo net\* (> page 312) when transporting cargo.

Unless you are transporting cargo, the backrests must remain properly locked in the upright position.

In an accident, during hard braking or sudden maneuvers, loose items will be thrown around inside the vehicle, and can cause injury to vehicle occupants unless the items are securely fastened in the vehicle.

Always use the cargo tie down rings (> page 302).

#### Warning!



Never drive the vehicle with the tailgate open. Deadly carbon monoxide (CO) gases may enter vehicle interior resulting in unconsciousness and death.

**!** *When the second-row seats are folded forward, the front seats may not be moved to the rearmost position. Otherwise you could damage the front and second-row seats.*

### Expanding cargo compartment in part

#### Folding third-row seats, electrically

**i** Use the left button, indicated by **L**, to fold down the left third-row seat.

Use the right button, indicated by **R**, to fold down the right third-row seat.

There are several ways to fold the third-row seats.

Two buttons are located on the right side trim of the third-row seats.

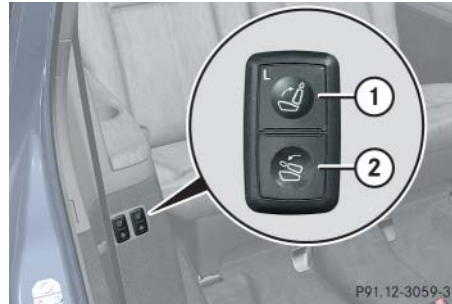

#### Example, button for the left third-row seat

- ① Button for returning third-row seats to upright position
- ② Button for folding the third-row seats

**i** It is only possible to fold the third-row seats down when the rear right door is open.

Two buttons are located on the passenger-side in the cargo compartment



#### Example, button for the right third-row seat

- ① Button for returning third-row seats to upright position
- ② Button for folding the third-row seats

**i** It is only possible to fold the third-row seats down when the tailgate is open.

- ▶ Push in the head restraints of the third-row seats all the way (▷ page 135).
- ▶ Remove cargo compartment cover blind (▷ page 311).



### Loading

- ▷▷ Press and hold button ② for each side until the third-row seats are fully folded.



If a third-row seat is not engaged properly, for example, the message **3rd Row Of Seats - Right Not Locked** appears in the multifunction display (▷ page 155).

- ▶ Press and hold button ② again, until the message disappears.

### Expanding cargo compartment fully

#### Warning!



Folded second-row seats are intended to serve as a cargo compartment expansion in conjunction with folded third-row seats only. Do not fold the second-row seats and allow third-row seat occupants to use folded second-row seats as a footrest while driving. Third-row seat occupants must, like all vehicle occupants, keep both feet on the floor in front of their seat. Otherwise, occupants could slide under their seat belt in a collision. If occupants slide under the belt, it would apply force at the abdomen or neck. That could cause serious or even fatal injuries. Do not fold the second-row seats and allow third-row seat occupants to use folded second-row seats as a table while driving.

Objects placed on folded second-row seats may come loose during braking, vehicle maneuvers, or an accident and be thrown around the vehicle interior. Objects thrown around the vehicle interior may cause an accident and/or serious personal injury.

### Folding second-row seats

**!** *When the second-row seats are folded forward, the front seats may not be moved to the rearmost position. Otherwise you could damage the front and second-row seats.*

- ▶ Push in the head restraints of the second-row seats all the way (▷ page 135).

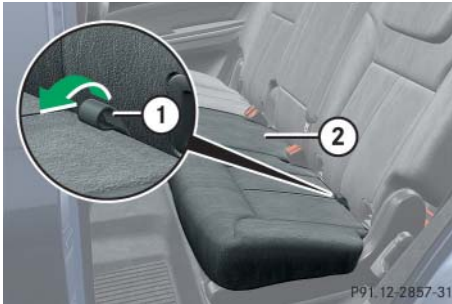

① Strap

② Seat cushion

- ▶ Pull strap ① in direction of arrow.
- ▶ Fold seat cushion ② forward.



③ Lever

- ▶ Pull and hold lever ③ in direction of arrow at resistance point.  
The seat backrest folds down.
- ▶ Check for secure locking by pushing and pulling on the seat backrest.





## Loading

### Folding third-row seats, electrically

**i** Use the left button, indicated by **L**, to fold down the left third-row seat.

Use the right button, indicated by **R**, to fold down the right third-row seat.

There are several ways to fold the third-row seats.

Two buttons are located on the right side trim of the third-row seats.

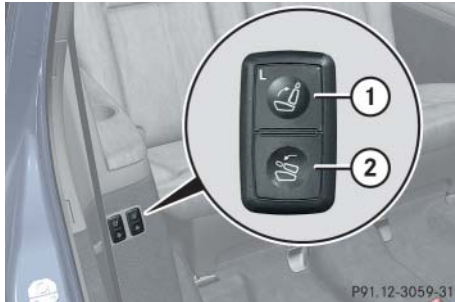

#### Example, button for the left third-row seat

- ① Button for returning third-row seats to upright position
- ② Button for folding the third-row seats

**i** It is only possible to fold the third-row seats down when the rear right door is open.

Two buttons are located on the passenger-side in the cargo compartment



#### Example, button for the right third-row seat

- ① Button for returning third-row seats to upright position
  - ② Button for folding the third-row seats
- ▶ Push in the head restraints of the third-row seats all the way (▷ page 135).

**i** It is only possible to fold the third-row seats down when the tailgate is open.

- ▶ Remove cargo compartment cover blind (▷ page 311).
- ▶ Press and hold button ② for each side until the third-row seats are fully folded.

The cargo compartment is fully extended.



If a third-row seat is not engaged properly, for example, the message **3rd Row Of Seats - Right Not Locked** appears in the multifunction display (▷ page 155).

- ▶ Press and hold button ② again, until the message disappears.

**Returning seats to their original position****Warning!**

Make sure all seats are properly locked in position before driving off. Do not drive with seats not properly locked.

Never ride in a moving vehicle with the seat not properly locked as this can be dangerous. The seat could move forward and the seat backrest could fold. You could slide under the seat belt during braking, vehicle maneuvers, or in an accident. If you slide under it, the belt would apply force at the abdomen or neck. That could cause serious or even fatal injuries.

The seat backrest and seat belt provide the best restraint when the wearer is in a nearly upright position and the belt is properly positioned on the body.

Step 1:

- ▶ Return third-row seats to its original position (▷ page 308).

Step 2:

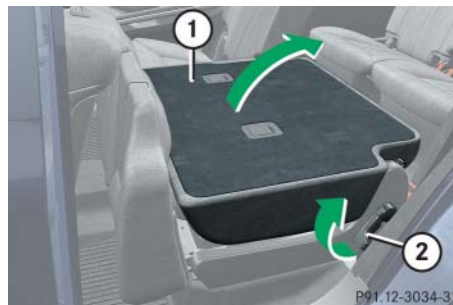

- ① Seat backrest
- ② Lever

- ▶ Pull and hold lever ② in direction of arrow at resistance point.
- ▶ Fold seat backrest ① rearward until it engages.
- ▶ Check for secure locking by pushing and pulling on seat backrest ①.

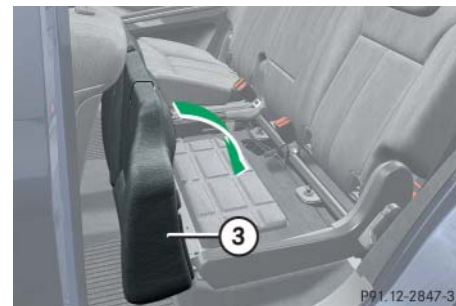

- ③ Seat cushion

- ▶ Fold seat cushion ③ rearward until it locks into position.

### Loading

#### Cargo compartment cover blind

The cargo compartment cover blind can be installed behind the third-row seats or the second-row seats.

**!** *With the cargo compartment cover blind installed, do not pile luggage higher than the lower edges of the rear side windows.*



#### Blind installed behind third-row seats

- ① Handle
- ② Mount

#### Rolling out blind

- ▶ Pull blind on handle ① across the cargo compartment.
- ▶ Guide blind into mounts ② and release.

#### Rolling up blind

- ▶ Disengage blind and guide retraction by its handle ①.

#### Installing blind

**i** *Before installing cargo compartment cover blind behind the second-row seats, fold the third-row seats forward (▷ page 305).*

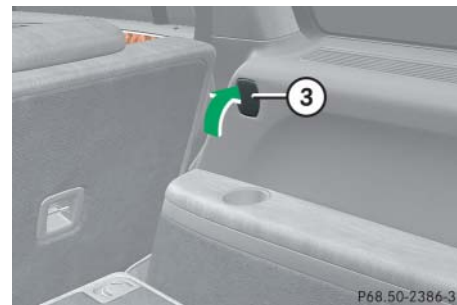

#### Cover from the mounts behind second-row seats

- ③ Cover

**i** *Before installing cargo compartment cover blind behind the third-row seats, fold the left or right third-row seat forward (▷ page 305). Afterwards, return the left or right third-row seat into its original position.*

- ▶ Press on cover ③ at its upper edge as indicated by arrow.

- ▶ Remove cover ③ by pulling its lower edge out of the side trim.

**i** To avoid loss of the mount covers, insert the mount covers into the mounts currently not in use.

- ▶ Place left side of blind ② (▷ page 311) in left mount.
- ▶ Position right side of blind ② over right mount.
- ▶ Press release button ① (▷ page 311) and guide cover ② into mount.
- ▶ Make sure the cargo compartment cover blind is securely fastened.

### Removing blind



### Blind installed behind second-row seats

- ① Release button
- ② Blind
- ▶ Roll the blind up.

**i** Before removing cargo compartment cover blind behind the third-row seats, fold the left or right third-row seat forward (▷ page 305). Afterwards, return the left or right third-row seat into its original position.

- ▶ Push release button ①.
- ▶ Pull blind ② to the left against the spring pressure until the spring in the cover audibly engages.
- ▶ Remove the blind.

## Loading

### Cargo net\*

#### Warning!



Make sure the cargo net is properly engaged top and bottom position and the tightening belts are securely fastened.

Never use a damaged cargo net.

To help avoid personal injury from smaller objects being thrown around in the occupant compartment during a collision or sudden maneuver, always use cargo net when transporting cargo.

The cargo net cannot prevent the movement of large, heavier objects into the passenger compartment in an accident. Such items must be properly secured using the cargo tie-down rings (▷ page 302) in the cargo compartment floor.

Passenger use of seats behind installed cargo net is restricted because of the footwell being taken up by the net.

Use of the cargo net is a particularly important safety factor when the vehicle is loaded higher than the top of the seat backrests with smaller objects. For your safety, always use the cargo net when transporting cargo.

The cargo net can be installed in two locations:



- ① Holder in B-pillar
- ② Holder in C-pillar

- With the cargo compartment expanded in part (▷ page 305), use holders above C-pillars ② and the cargo tie-down rings behind the third-row seat backrest (▷ page 303).
- With the cargo compartment fully expanded (▷ page 306), use holders above B-pillars ① and the cargo tie-down rings in the second-row footwell (▷ page 303).
- ▶ Open the hook and loop fasteners on the cargo net package.
- ▶ Roll out the cargo net.
- ▶ Unfold the cargo net.

The cargo net bars must audibly engage.

### Installing the cargo net

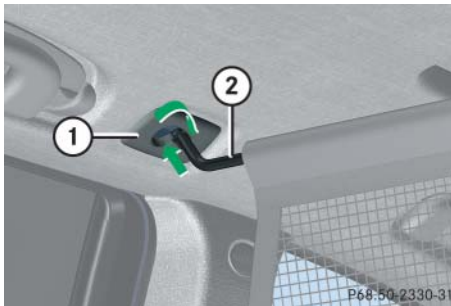

#### Cargo net bar hung up behind the B-pillar

- ① Holder
- ② Cargo net bar
- ▶ Hang cargo net bar ② on holder ① as indicated by the arrow.
- ▶ Push cargo net bar ② forward into holder ① in direction of arrow.

### Pulling the cargo net tight

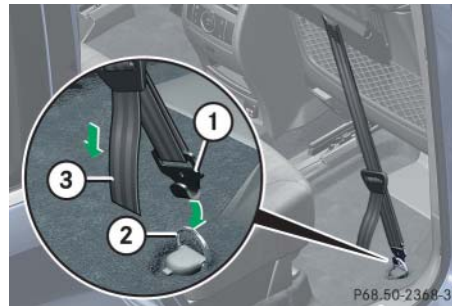

#### Belt hook attached in the second-row footwell

- ① Belt hook
- ② Cargo tie-down ring
- ③ Tightening belt
- ▶ Hook belt hook ① into cargo tie-down ring ② in direction of arrow.
- ▶ Pull tightening belt ③ by the loose end in direction of arrow until the cargo net is pulled tight.
- ▶ After driving a short distance, make sure the cargo net is still tight and, if necessary, pull it tight again.

### Loosening the cargo net

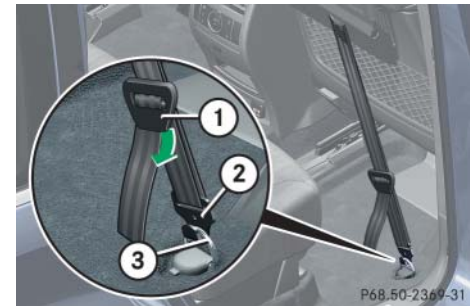

#### Belt hook attached in the second-row footwell

- ① Buckle
- ② Belt hook
- ③ Cargo tie-down ring
- ▶ Loosen the tightening belt by pulling buckle ① upward in direction of arrow.
- ▶ Remove belt hook ② from cargo tie-down ring ③.

### Loading

#### Removing and storing the cargo net

- ▶ Take cargo net bar ② out of holder ①, see “Installing the cargo net” (▷ page 313).
- ▶ Press the red button on the upper and lower cargo net bar.
- ▶ Fold the cargo net.
- ▶ Roll up the cargo net.
- ▶ Close the hook and loop fasteners on the cargo net package.

## ▼ Useful features

### Storage compartments

#### Warning!



To help avoid personal injury during a collision or sudden maneuver, exercise care when storing objects in the vehicle. Put luggage or cargo in the cargo compartment if possible. Do not pile luggage or cargo higher than the seat backs.

If so equipped, always use the cargo net\* when transporting cargo. The cargo net\* cannot secure hard or heavy objects.

Parcel nets cannot secure hard or heavy objects.

Keep compartment lids closed. This will help to prevent stored objects from being thrown about and injuring vehicle occupants during

- braking
- vehicle maneuvers
- an accident

### Glove box/CD changer

**i** Depending on vehicle equipment, an AUX-socket is located in the glove box.



- ① Glove box lid release
- ② Glove box lid

#### Opening the glove box

- ▶ Pull lid release ① in direction of arrow. Glove box lid ② opens downward.

#### Closing the glove box

- ▶ Push glove box lid ② up to close.

### Releasing CD changer

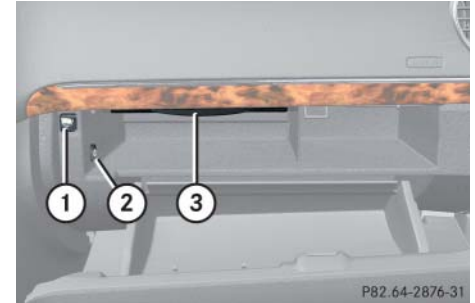

- ① Release button
- ② AUX-socket (Vehicles without Rear Seat Entertainment System\*)
- ③ CD changer

- ▶ Open the glove box (▷ page 315).

- ▶ Press release button ①.

CD changer ③ is released and swings down automatically.

For information on CD changer operation, see separate COMAND system operating instructions.



### Useful features

#### Closing CD changer

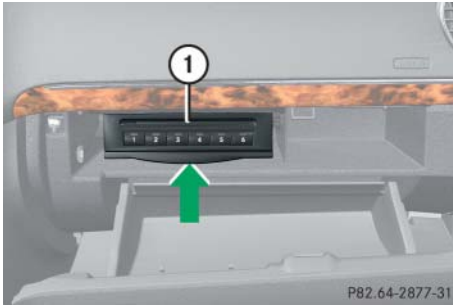

#### ① CD changer

- ▶ Gently push CD changer ① up in direction of arrow until it engages.

For information on CD changer operation, see separate COMAND system operating instructions.

#### Locking and unlocking the glove box separately

You can lock the glove box separately, e.g. when the vehicle is in the shop for service.

- ▶ Take the mechanical key out of the SmartKey or SmartKey with KEYLESS-GO\* (▷ page 496).



- 1 Unlocking glove box
- 2 Locking glove box

- ▶ Insert mechanical key into glove box lock.
- ▶ Turn mechanical key to position ② to lock the glove box.
- ▶ Turn mechanical key to position ① to unlock the glove box.

**i** The glove box can only be locked or unlocked with the mechanical key (▷ page 496).

### Storage compartment in front center console

**i** Depending on vehicle configuration, the lower storage compartment contains an ashtray (▷ page 321).



- ▶ Briefly press the front of the cover.  
The cover opens automatically.

**i** In vehicles with enhanced off-road package\*, the upper storage compartment contains a control panel (▷ page 204) or (▷ page 283).



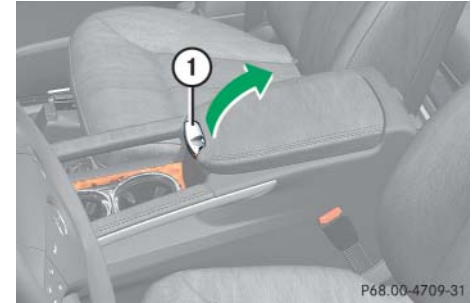

- ▶ Briefly press the front of the cover.  
The cover opens automatically.

### Storage/telephone\* compartment under front center armrest



- ① Button to open storage/telephone\* compartment

**i** The mobile phone cradle\* (▷ page 329), the Roadside Assistance button  (▷ page 335) and the Information button  (▷ page 336) are located in the storage/telephone\* compartment.

### Useful features

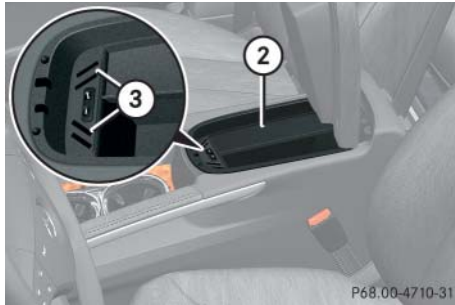

- ② Storage/telephone\* compartment
- ③ Coin holder

#### Opening the storage/telephone\* compartment

- ▶ Pull button ① and lift up armrest.

The coin holders ③ are located in front of storage/telephone\* compartment ②.

#### Rear storage compartments

Depending on the vehicle configuration, your vehicle may be equipped with three storage compartments in the front of the rear seats.



**i** Depending on vehicle equipment, the upper storage compartment may be replaced by a control panel, for example in vehicles with rear climate control\* (▷ page 226) or rear automatic climate control\* (▷ page 241).

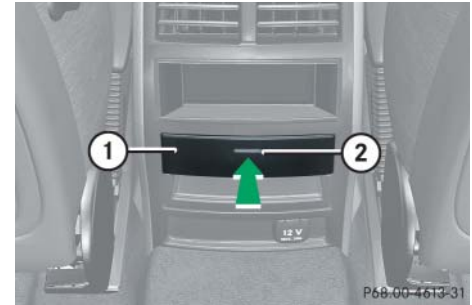

- ① Storage compartment cover
  - ② Release button
- ▶ Briefly press release button ② on storage compartment cover ①.

The storage compartment opens automatically.

**i** Depending on vehicle configuration, the middle storage compartment contains an ashtray (▷ page 322).

## Parcel nets

### Warning!



Do not place objects with a combined weight of more than 4.4 lb (2 kg) into the parcel net on the back of the front passenger seat. Otherwise, the Occupant Classification System OCS (▷ page 81) may not be able to properly approximate the occupant weight category.

Parcel nets are intended for storing light-weight items only.

Heavy objects, objects with sharp edges or fragile objects may not be transported in the parcel nets. In an accident, during hard braking, or sudden maneuvers, they could be thrown around inside the vehicle and cause injury to vehicle occupants.

Parcel nets cannot protect transported goods in the event of an accident.

## Parcel net in front passenger footwell

A small convenience parcel net is located in the front passenger footwell. It is intended for small and light items, such as road maps, mail, etc.

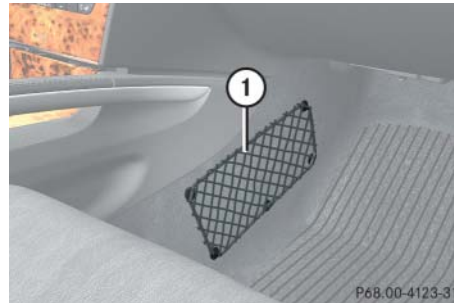

① Parcel net

## Parcel nets on front seat backrests

A small convenience parcel net is located on each of the front seat backrests. It is intended for small and light items, such as road maps, mail, etc.

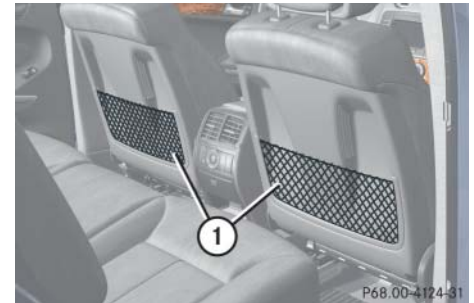

① Parcel net

## Useful features

### Cup holders

#### Warning!



In order to help prevent spilling liquids on vehicle occupants and/or vehicle equipment, only use containers that fit into the cup holder. Use lids on open containers and do not fill containers to a height where the contents, especially hot liquids, could spill during braking, vehicle maneuvers, or an accident. Liquids spilled on vehicle occupants may cause serious personal injury. Liquids spilled on vehicle equipment may cause damage not covered by the Mercedes-Benz Limited Warranty.

When not in use, keep rear cup holder closed. An open cup holder may cause injury to you or others when contacted during braking, vehicle maneuvers, or in an accident.

Keep in mind that objects placed in a cup holder may come loose during braking, vehicle maneuvers, or an accident and be thrown around in the vehicle interior.

Objects thrown around in the vehicle interior may cause an accident and/or serious personal injury.

### Cup holder in front of armrest

A cup holder and a card/ticket holder are located in the front center console.

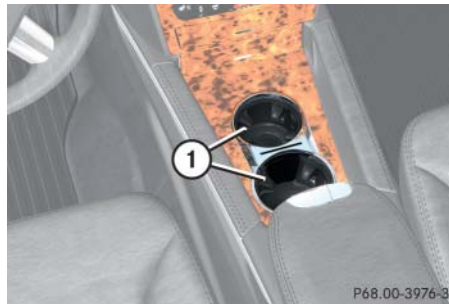

#### ① Cup holder

**i** The front cup holder can be removed for cleaning purposes (▷ page 321).

### Cup holder in rear armrest (second-row seats)



#### ① Cup holder

▶ Pull the armrest down by its top.

**!** Close the cup holder before folding the armrest upwards.

### Cup holders in third-row side trim

Cup holders are located in the side trims of the third-row seats.



① Cup holder

### Removing and reinstalling cup holder

The front cup holder can be removed for cleaning purposes.

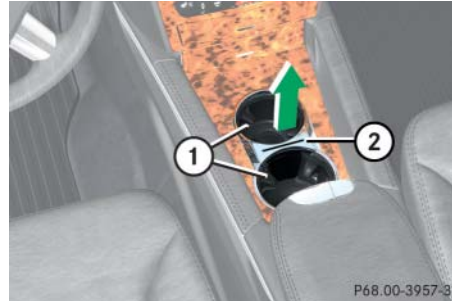

- ① Cup holder
- ② Bridge with card, ticket holder
- ▶ Hold cup holder at its bridge ② and pull out bridge in direction of arrow.
- ▶ Pull cup holder ① out in direction of arrow.
- ▶ First, insert the cup holder ① and then insert bridge ②.

### Ashtrays

Depending on vehicle configuration your vehicle is equipped with an ashtray and a cigarette lighter (▷ page 323) located in the front center console and an ashtray located in front of the second-row seats (▷ page 322).

**i** If your vehicle is not equipped with an ashtray, it has a storage compartment (▷ page 317) with a power outlet (▷ page 324) instead.

### Ashtray in the center console



- ① Ashtray insert
- ② Cover plate

### Useful features

#### Opening the ashtray

- ▶ Briefly touch cover plate ②.

The ashtray opens automatically.

#### Removing ashtray insert

##### Warning!



Remove ashtray only with vehicle standing still. Set the parking brake to secure vehicle from movement. Set automatic transmission to **P**. With the automatic transmission set to **P**, turn off the engine.

- ▶ Grip the ashtray insert ① on the sides and pull it out upwards.

#### Reinstalling ashtray insert

- ▶ Install ashtray insert ①.
- ▶ Close ashtray cover plate ②.

#### Rear center console ashtray (second-row)

**!** Close the ashtray when not in use and before folding the second-row seats

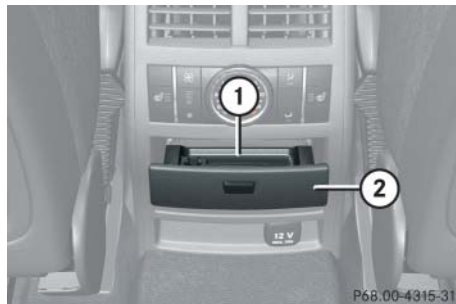

- ① Ashtray
- ② Ashtray cover

#### Opening rear ashtray

- ▶ Briefly press ashtray cover ②.

The ashtray ① opens automatically.

#### Removing rear ashtray insert

- ▶ Grip the insert on the sides and pull it out upwards.

#### Reinstalling rear ashtray insert

- ▶ Install ashtray insert.
- ▶ Close the ashtray.

#### Cigarette lighter

- ▶ Switch on the ignition (▷ page 42).
- ▶ Push in cigarette lighter.

The cigarette lighter will pop out automatically when hot.

### Cigarette lighter

Depending on vehicle configuration your vehicle is equipped with a cigarette lighter and an ashtray (▷ page 321) located in the front center console and an ashtray located in front of the second-row seats (▷ page 322).

#### Warning!



Never touch the heating element or sides of the cigarette lighter; they are extremely hot. Hold the knob only.

Make sure that any children traveling with you do not injure themselves or start a fire with the hot cigarette lighter.

When leaving the vehicle always remove the SmartKey or SmartKey with KEYLESS-GO\* from the starter switch, take it with you, and lock the vehicle. Do not leave children unattended in the vehicle, or with access to an unlocked vehicle. A child's unsupervised access to a vehicle could result in an accident and/or serious personal injury.

- ▶ Switch on the ignition (▷ page 42).



- ① Cigarette lighter
  - ▶ Open the ashtray (▷ page 322).
  - ▶ Push in cigarette lighter ①.
- The cigarette lighter will pop out automatically when hot.

**!** The lighter socket can accommodate 12V DC electrical accessories (up to a maximum of 180 W) designed for use with the standard “cigarette lighter” plug type. Keep in mind, however, that connecting accessories to the lighter socket (for example extensive connecting and disconnecting, or using plugs that do not fit properly) can damage the lighter socket. With the socket damaged, the lighter may no longer be able to be placed in the heating (pushed-in) position, or the lighter may pop out too early with the lighter not hot enough.

To help avoid damaging the cigarette lighter socket, we recommend connecting 12V DC electrical accessories designed for use with the standard “cigarette lighter” plug type to the 12V power outlets (▷ page 324) in your vehicle whenever possible.

**i** If the engine is off, and the cigarette lighter is being used extensively, the vehicle battery may become discharged.



### Useful features

#### Power outlets

**!** If you use all power outlets in the vehicle, make sure that the maximum current drawn does not exceed 55 A.

**i** The power outlets can be used to accommodate 12V DC electrical accessories (e.g. auxiliary lamps) up to a maximum of 240 W.

If the engine is off, the battery may become discharged if used for long periods of time.

**i** You can use the power outlets, except for the power outlet in the front center console, even if the ignition is switched off.

An emergency shut-off feature ensures that the vehicle's electrical voltage does not fall below a minimum level. If the voltage drops to this minimum level, the power outlets are automatically switched off. This ensures that enough power remains to start the engine.

Power outlets are located

- in the front center console (▷ page 324)
- in the front passenger footwell (▷ page 324)
- in the second-row footwell (▷ page 325)
- on the left-hand side of the cargo compartment (▷ page 325)

#### Power outlet in front center console



① Power outlet cover

- ▶ Switch on the ignition (▷ page 42).
- ▶ Open cover plate (▷ page 317).

- ▶ Pull out cover ① and insert electrical plug (cigarette lighter type).

**i** Depending on vehicle configuration, the storage compartment contains an ashtray with cigarette lighter (▷ page 323) instead.

#### Power outlet in front passenger footwell



- ▶ Switch on the ignition (▷ page 42).
- ▶ Flip up cover and insert electrical plug (cigarette lighter type).

### Power outlet in second-row footwell



- ▶ Switch on the ignition (▷ page 42).
- ▶ Flip up cover and insert electrical plug (cigarette lighter type).

### Power outlet in cargo compartment



- ▶ Switch on the ignition (▷ page 42).
- ▶ Flip up cover and insert electrical plug (cigarette lighter type).

### Floor mats

#### Warning!



Whenever you are using floor mats, make sure there is enough clearance and that the floor mats are securely fastened.

Floor mats should always be securely fastened using eyelets ② and retainer pins ① (▷ page 326).

Before driving off, check that the floor mats are securely in place and adjust them if necessary. A loose floor mat could slip and hinder proper functioning of the pedals.

Do not place several floor mats on top of each other as this may impair pedal movement.

**i** To install or remove the floor mat more easily, move the driver's seat or front passenger seat as far to the rear as possible (▷ page 46).

### Useful features

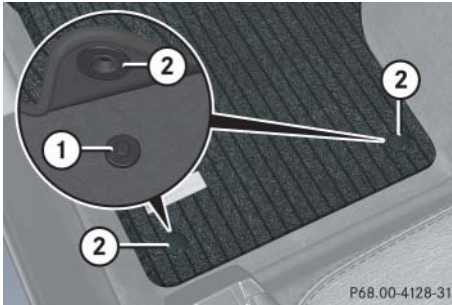

- ① Retainer pin
- ② Eyelet

#### Removing

- ▶ Pull floormat off of retainer pins ①.
- ▶ Remove the floormat.

#### Installing

- ▶ Lay down the floormat in the respective footwell.
- ▶ Press the floormat eyelets ② onto retainer pins ①.

#### Seat cover under third-row seats

If something falls under the third-row seats, you can remove the seat cover in order to reach under the seats.

#### Removing seat cover



#### Example passenger side

- ▶ Fold the respective seat halfway in or out (▷ page 305).

- ▶ Reach into the recess in the seat cover.
- ▶ Pull the seat cover in the direction of the arrow.

Remove the seat cover to reach under the seats.

#### Installing seat cover

- ▶ Fold the seat halfway in or out (▷ page 305).
- ▶ Put the seat cover back into place using the guide pins.
- ▶ Press the seat cover down until it engages.
- ▶ Make sure that the seat cover is engaged properly by folding the seat all the way in and out.

### Heated steering wheel\*

The steering wheel heating warms up the leather area of the steering wheel.

The stalk is on the lower left-hand side of the steering wheel.

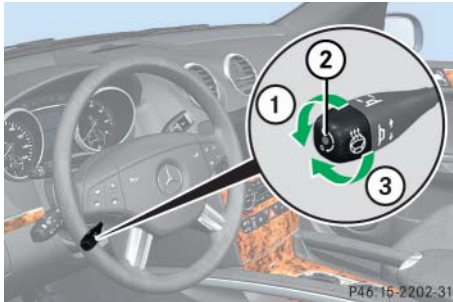

- ① Switching on
- ② Indicator lamp
- ③ Switching off

### Switching on

- ▶ Switch on the ignition (▷ page 42).
- ▶ Turn switch at the tip of stalk in the direction of arrow ①.

The steering wheel is heated. Indicator lamp ② comes on.

**i** The steering wheel heating is turned off temporarily and the indicator lamp ② remains on when

- the temperature of the vehicle interior is above 86°F (30°C)
- the temperature of the steering wheel is above 95°F (35°C)

When these conditions do not apply anymore, steering wheel heating continues.

### Switching off

- ▶ Turn switch at the tip of stalk in the direction of arrow ③.

The heated steering wheel is switched off. Indicator lamp ② goes out.

**i** Indicator lamp ② flashes or goes out

- in case of power surge or undervoltage
- in case of a steering wheel heating malfunction

**i** The steering wheel heating switches off automatically when you remove the SmartKey from the starter switch or, on vehicles with KEYLESS-GO\*, when you switch off the ignition (▷ page 41) and open the driver's door.

For information on the steering wheel, see "Multifunction steering wheel" (▷ page 30).

### Useful features

#### Telephone\*

##### Warning!



Never operate radio transmitters equipped with a built-in or attached antenna (i.e. without being connected to an external antenna) from inside the vehicle while the engine is running. Doing so could lead to a malfunction of the vehicle's electronic system, possibly resulting in an accident and/or serious personal injury.

Radio transmitters, such as a portable telephone or a citizens band unit, should only be used inside the vehicle if they are connected to an antenna that is installed on the outside of the vehicle.

The external antenna must be approved by Mercedes-Benz. Please contact an authorized Mercedes-Benz Light Truck Center for information on the installation of an approved external antenna. Refer to the radio transmitter operation instructions regarding use of an external antenna.

##### Warning!



Please do not forget that your primary responsibility is to drive the vehicle. A driver's attention to the road must always be his /her primary focus when driving. For your safety and the safety of others, we recommend that you pull over to a safe location and stop before placing or taking a telephone call.

If you choose to use the telephone<sup>1</sup> while driving, please use the hands-free device and only use the telephone when road, weather and traffic conditions permit. Some jurisdictions prohibit the driver from using a cellular telephone while driving a vehicle.

Only operate the COMAND system<sup>1</sup> if road, weather and traffic conditions permit.



Bear in mind that at a speed of just 30 mph (approximately 50 km/h), your vehicle is covering a distance of 44 feet (approximately 14 m) every second.

<sup>1</sup> Observe all legal requirements.

**i** Various mobile phone cradles can be installed in the front center armrest, see separate installation instructions for the mobile phone cradle. These mobile phone cradles can be obtained from an authorized Mercedes-Benz Light Truck Center.

*The functions and services available to you while using the mobile phone depend on your service provider and the type of mobile phone you are using. See also separate operating manual for instructions on how to use your mobile phone.*

When the mobile phone is inserted in the cradle, you can operate the telephone using the following devices:

- mobile phone keypad
- COMAND system (see separate operating instructions)
- buttons  and  on the multi-function steering wheel (▷ page 156)
- Voice Control System\* (see separate operating instructions)

Please note that these functions are only available with Mercedes-Benz approved mobile phones.

Please contact an authorized Mercedes-Benz Light Truck Center for information on features available for your mobile phone of choice.

The contact plate for the mobile phone cradle is located in the front center arm-rest.

- ▶ Open storage/telephone compartment (▷ page 317).



① Cover for contact plate

- ▶ Pull cover for contact plate ① in direction of arrow.

You can now access the contact plate.

### Inserting mobile phone in mobile phone cradle

Once the mobile phone has been inserted in the mobile phone cradle, you have to use the hands-free device to respond during phone calls.

**!** Do not try to remove the mobile phone along with the cradle. You could otherwise damage the mobile phone cradle.

- ▶ If applicable, remove the cover for the external antenna connection from the back of the mobile phone and store it in a safe place. Be sure to comply with the mobile phone's operating instructions as well.



### Example illustration

- ① Insert the mobile phone
- ② Connector contact
- ③ Mobile phone cradle

- ▶ Slide the lower end of the mobile phone into connector contact ② on cradle ③.
- ▶ Push the top of the mobile phone in direction of arrow ①, until the lug on the mobile phone release button engages.

The mobile phone is connected to the network via the external antenna. ▷▷

### Useful features

- ▷▷ The mobile phone is linked to the hands-free device and the multifunction steering wheel.

The battery is charged depending on its charge status and the position of the SmartKey in the starter switch. The charge procedure will be indicated in the mobile phone's display.

You can place or receive phone calls. You can control other functions of the mobile phone via the control system (▷ page 186), the Voice Control System\* (see separate operating instructions), or the COMAND system (see separate operating instructions).

**i** When you take the SmartKey or SmartKey with KEYLESS-GO\* out of the starter switch, the mobile phone remains switched on for approximately 10 minutes. If you place or receive a call during this time, the mobile phone switches off 10 minutes after the call has been completed.

### Removing mobile phone from mobile phone cradle



#### Example illustration

- ① Release catch for mobile phone
- ② Mobile phone cradle

**i** When using a flip-style mobile phone, open flip top before removing from the cradle while a call is connected. Otherwise, the call will be disconnected.

- ▶ Press release catch in direction of arrow ① and take mobile phone out of mobile phone cradle ②.

### Changing mobile phone cradle

If you require a different cradle for your mobile phone, remove the present cradle before installing a new one.

### Removing an existing mobile phone cradle

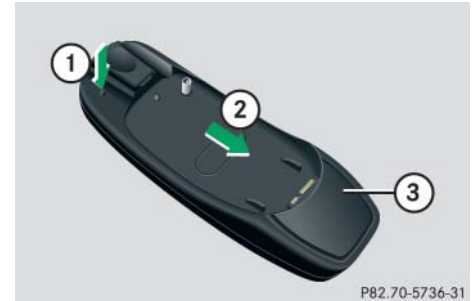

#### Example illustration

- ① To release the mobile phone cradle
  - ② To remove the mobile phone cradle
  - ③ Mobile phone cradle
- ▶ Press release button in direction of arrow ① and take mobile phone cradle ③ out in direction of arrow ②.

### Installing a different mobile phone cradle

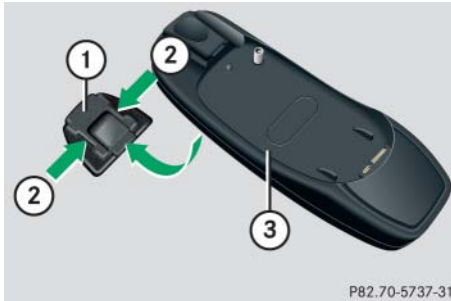

#### Example illustration

- ① Contact plate
  - ② Recesses
  - ③ Mobile phone cradle
- ▶ Insert mobile phone cradle ③ into recesses ② of contact plate ①.
  - ▶ Push mobile phone cradle ③ forward until it engages.

### Tele Aid

**!** The initial activation of the Tele Aid system may only be performed by completing the subscriber agreement and placing an acquaintance call using the button. Failure to complete either of these steps will result in a system that is not activated.

If you have any questions regarding activation, please call the Response Center at 1-800-756-9018 (in the USA) or 1-888-923-8367 (in Canada).

Shortly after the completion of your Tele Aid acquaintance call, you will receive a user ID and password. By visiting [www.mbusa.com](http://www.mbusa.com) and selecting “Tele Aid” (USA only), you will have access to account information, remote door unlock and more.

### The Tele Aid system

(Telematic Alarm Identification on Demand)

The Tele Aid system consists of three types of response:



- automatic and manual emergency
- roadside assistance
- information

The Tele Aid system is operational providing that the vehicle’s battery is charged, properly connected, not damaged and cellular and GPS coverage is available.



The speaker volume of a Tele Aid call can be adjusted by using the volume control on the COMAND system or on the multifunction steering wheel. To raise, turn the rotary volume control on COMAND system clockwise or press button on the multifunction steering wheel. To lower, turn the rotary volume control on COMAND system counterclockwise or press button on the multifunction steering wheel.



### Useful features

- ▶ To activate, press the SOS button, the Roadside Assistance button  or the Information button , depending on the type of response required.



**i** The SOS button is located in the overhead control panel (▷ page 34).

The Roadside Assistance button  (▷ page 335) and the Information button  (▷ page 336) are located below the center arm-rest cover.

**!** The Tele Aid system utilizes the cellular network for communication and the GPS (Global Positioning System) satellites for vehicle location. If either of these signals are unavailable, the Tele Aid system may not function and if this occurs, assistance must be summoned by other means.

**i** When a Tele Aid call has been initiated, the COMAND system audio is muted and the selected mode (radio, CD etc.) pauses. The optional cellular phone (if installed) inserted in cradle switches off. If you must use this phone, we recommend that you use it only with the vehicle at a standstill in a safe location. Remove the phone from the cradle and place the call. The navigation\* system (if engaged) will continue to run. The display in the instrument cluster is available for use, and spoken commands are only available by pressing the RPT button on the COMAND system. A pop-up window will appear in the COMAND system display to indicate that a Tele Aid call is in progress. After the Tele Aid call has ended, the optional cellular phone inserted in the cradle switches on again. A PIN entry might be necessary.

### System self-check

Initially, after switching on the ignition, malfunctions are detected and indicated (the indicator lamps in the SOS button, the Roadside Assistance button  and the Information button  stay on longer than 10 seconds or do not come on).

The message Tele Aid – Inoperative appears in the multifunction display.

#### Warning!



If the indicator lamps on the SOS button, on the Roadside Assistance button, and/or on the Information button remain illuminated continuously in red and/or the message Tele Aid – Inoperative is displayed in the multifunction display after the system self-check, a malfunction in the system has been detected.

If a malfunction is indicated as outlined above, the system may not operate as expected. Have the system checked at the nearest Mercedes-Benz Light Truck Center as soon as possible.

### Emergency calls

An emergency call is initiated automatically following an accident in which the emergency tensioning devices (ETDs) or air bags deploy.

An emergency call can also be initiated manually by opening the cover next to the interior rear view mirror labeled SOS, then briefly pressing the button located under the cover. See (▷ page 334) for instructions on initiating an emergency call manually.

Once the emergency call is in progress, the indicator lamp on the SOS button will begin to flash. The message **Connecting Call** appears in the multifunction display. When the connection is established, the message **Call Connected** appears in the multifunction display. All information relevant to the emergency, such as the location of the vehicle (determined by the GPS satellite location system), vehicle model, identification number and color are generated.

A voice connection between the Response Center and the occupants of the vehicle will be established automatically soon after the emergency call has been initiated. The Response Center will attempt to determine more precisely the nature of the accident provided they can speak to an occupant of the vehicle.

The Tele Aid system is available if

- it has been activated and is operational. Activation requires a subscription for monitoring services, connection and cellular air time
- vehicle battery power is available
- the relevant cellular phone network and GPS signals are available and pass the information on to the Response Center

**i** *Location of the vehicle on a map is only possible if the vehicle is able to receive signals from the GPS satellite network and pass the information on to the Response Center.*

### Useful features

#### Warning!



If the indicator lamp in the SOS button is flashing continuously and there was no voice connection to the Response Center established, then the Tele Aid system could not initiate an emergency call (e.g. the relevant cellular phone network is not available). The message *Call Failed* appears in the multifunction display for approximately 10 seconds.

Should this occur, assistance must be summoned by other means.

#### Initiating an emergency call manually

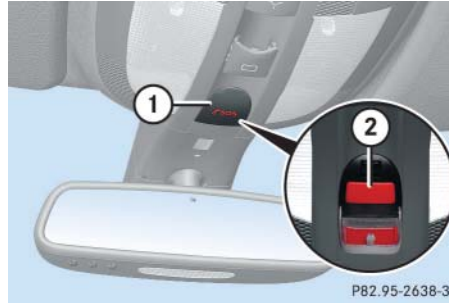

- ① Cover
- ② SOS button

- ▶ Briefly press on cover ①.

The cover opens.

- ▶ Press SOS button ② briefly.

The indicator lamp in SOS button ② will flash until the emergency call is concluded.

- ▶ Wait for a voice connection to the Response Center.
- ▶ Close cover ① after the emergency call is concluded.

#### Warning!



If you feel at any way in jeopardy when in the vehicle (e.g. smoke or fire in the vehicle, vehicle in a dangerous road location), please do not wait for voice contact after you have pressed the emergency button. Carefully leave the vehicle and move to a safe location. The Response Center will automatically contact local emergency officials with the vehicle's approximate location if they receive an automatic SOS signal and cannot make voice contact with the vehicle occupants.

### Roadside Assistance button

The Roadside Assistance button  is located below the center armrest cover.



### ① Roadside Assistance button

- ▶ Open the storage compartment (▷ page 318).
- ▶ Press and hold button ① (for longer than 2 seconds).

A call to a Mercedes-Benz Roadside Assistance dispatcher will be initiated. The button will flash while the call is in progress. The message *Connecting Call* will appear in the multifunction display.

When the connection is established, the message *Call Connected* appears in the multifunction display. The Tele Aid system will transmit data generating the vehicle identification number, model, color and location (subject to availability of cellular and GPS signals).

 *While the call is connected you can change to the navigation menu by pressing the NAV button on the COMAND system unit.*

A voice connection between the Roadside Assistance dispatcher and the occupants of the vehicle will be established.



- ▶ Describe the nature of the need for assistance.

The Mercedes-Benz Roadside Assistance dispatcher will either dispatch a qualified Mercedes-Benz technician or arrange to tow your vehicle to the nearest Mercedes-Benz Light Truck Center. For services such as labor and/or towing, charges may apply. Refer to the Roadside Assistance Manual for more information.

The following is only available in the USA:

- Sign and Drive services: Services such as jump start, a few gallons of fuel or the replacement of a flat tire with the vehicle spare tire are obtainable.

### Useful features

**i** The indicator lamp on the Roadside Assistance button  remains illuminated in red for approximately 10 seconds during the system self-check after switching on the ignition (together with the SOS button and the Information button ).

See system self-check (▷ page 332) if the indicator lamp does not come on in red or stays on longer than approximately 10 seconds.

If the indicator lamp on the Roadside Assistance button  is flashing continuously and there was no voice connection to the Response Center established, then the Tele Aid system could not initiate a Roadside Assistance call (e.g. the relevant cellular phone network was not available). The message **Call Failed** appears in the multifunction display.

Roadside Assistance calls can be terminated using the  button on the multifunction steering wheel or the **END Button** on the COMAND system.

### Information button

The Information button  is located below the center armrest cover.



### ① Information button

- ▶ Open the storage compartment (▷ page 318).
- ▶ Press and hold button ① (for longer than 2 seconds).



A call to the Customer Assistance Center will be initiated. The button will flash while the call is in progress. The message **Connecting Call** will appear in the multifunction display.

When the connection is established, the message **Call Connected** appears in the multifunction display. The Tele Aid system will transmit data generating the vehicle identification number, model, color and location (subject to availability of cellular and GPS signals).

**i** While the call is connected, you can change to the navigation menu by pressing the **NAV** button on the COMAND system.

A voice connection between the Customer Assistance Center representative and the occupants of the vehicle will be established. Information regarding the operation of your vehicle, the nearest Mercedes-Benz Light Truck Center or Mercedes-Benz USA products and services is available to you.

For more details concerning the Tele Aid system, please visit [www.mbusa.com](http://www.mbusa.com) and use your ID and password (sent to you separately) to learn more (USA only).

**i** The indicator lamp in the Information button  remains illuminated in red for approximately 10 seconds during the system self-check after switching on the ignition (together with the SOS button and the Roadside Assistance button .

See system self-check (▷ page 332) if the indicator lamp does not come on in red or stays on longer than approximately 10 seconds.

If the indicator lamp in the Information button  is flashing continuously and there was no voice connection to the Response Center established, then the Tele Aid system could not initiate an Information call (e.g. the relevant cellular phone network is not available). The message Call Failed appears in the multifunction display.

Information calls can be terminated using the  button on the multifunction steering wheel or the END button on the COMAND system.

**!** If the indicator lamps do not start flashing after pressing one of the buttons or remain illuminated (in red) at any time, the Tele Aid system has detected a malfunction or the service is not currently active, and may not initiate a call. Visit your authorized Mercedes-Benz Light Truck Center and have the system checked or contact the Response Center at 1-800-756-9018 (in the USA) or 1-888-923-8367 (in Canada) as soon as possible.

### Call priority

If other service calls such as a Roadside Assistance call or Information call are active, an Emergency call is still possible. In this case, the Emergency call will take priority and override all other active calls.

**i** The indicator lamp in the respective button flashes until the call is concluded. Emergency calls can only be terminated by a Response Center or Customer Assistance Center representative, whereas Roadside Assistance and Information calls can also be terminated by pressing button  on the multifunction steering wheel or using the END button on the COMAND system.

**!** If the indicator lamp continues to flash or the system does not reset, contact the Response Center at 1-800-756-9018 (in the USA) or 1-888-923-8367 (in Canada), or Mercedes-Benz Customer Assistance at 1-800-FOR-MERCEDES (1-800-367-6372) in the USA or Customer Service at 1-800-387-0100 in Canada.

### Remote door unlock

In case you have locked your vehicle unintentionally (e.g. SmartKey inside vehicle), and the reserve SmartKey is not handy:

- ▶ Contact the Mercedes-Benz Response Center at 1-800-756-9018 (in the USA) or 1-888-923-8367 (in Canada).

You will be asked to provide your password which you provided when you completed the subscriber agreement.

- ▶ Then return to your vehicle and pull the tailgate recessed handle for minimum of 20 seconds until the SOS button is flashing.

The message Connecting Call appears in the multifunction display.

### Useful features

As an alternative, you may unlock the vehicle via Internet using the ID and password sent to you shortly after the completion of your acquaintance call.

The Response Center will then unlock your vehicle with the remote door unlocking feature.

**i** *The remote door unlock feature is available if the relevant cellular phone network is available.*

*The SOS button will flash and the message Connecting Call will appear in the multifunction display to indicate receipt of the door unlock command.*

*Once the vehicle is unlocked, a Response Center specialist may attempt to establish voice contact with the vehicle occupants.*

*If the tailgate recessed handle was pulled for more than 20 seconds before door unlock authorization was received by the Response Center, you must wait 15 minutes before pulling the tailgate recessed handle again.*

### Stolen Vehicle Recovery services

In the event your vehicle was stolen:

- ▶ Report the incident to the police.  
The police will issue a numbered incident report.
- ▶ Pass this number on to the Mercedes-Benz Response Center along with your password issued to you when you subscribed to the service.

The Response Center will then attempt to covertly contact the vehicle's Tele Aid system. Once the vehicle is located, the Response Center will contact the local law enforcement and you. The vehicle's location will only be provided to law enforcement.

If you have any questions, please call the Response Center at 1-800-756-9018 (in the USA) or 1-888-923-8367 (in Canada).

**i** *When the anti-theft alarm stays on for more than 30 seconds, a call is initiated automatically to the Response Center. See anti-theft alarm system (▷ page 109).*

### Garage door opener

The integrated remote control is capable of operating up to three separately controlled devices. It provides a convenient way to replace up to three hand-held remote controls used to operate devices such as garage door openers, gate openers, or other devices compatible with HomeLink® or some other systems.

Before the integrated remote control can be used, it must be programmed to the garage door opener, gate operator or other device you wish to operate. See the following instructions for programming information.

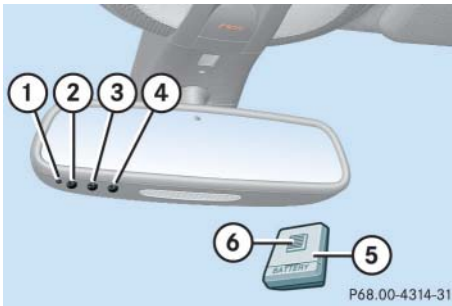

### Interior rear view mirror with integrated remote control

- ① Indicator lamp
- ② ③ ④ Signal transmitter button

Needed for programming (not part of vehicle equipment):

- ⑤ Hand-held remote control of garage door opener, gate operator or other device
- ⑥ Hand-held remote control button

### Warning!



Before programming the integrated remote control to a garage door opener or gate operator, make sure people and objects are out of the way of the device to prevent potential harm or damage. When programming a garage door opener, the door moves up or down. When programming a gate operator, the gate opens or closes.

Do not use the integrated remote control with any garage door opener that lacks safety stop and reverse features as required by U.S. federal safety standards (this includes any garage door opener model manufactured before April 1, 1982).

A garage door that cannot detect an object – signaling the door to stop and reverse – does not meet current U.S. federal safety standards.

When programming a garage door opener, park the vehicle outside the garage.

Do not run the engine while programming the integrated remote control. Inhalation of exhaust gas is hazardous to your health. All exhaust gas contains carbon monoxide (CO), and inhaling it can cause unconsciousness and possible death.

### Programming the integrated remote control

Step 1:

- ▶ Switch on the ignition (▷ page 42). ▷▷



### Useful features

#### ▷▷Step 2:

- ▶ If you have previously programmed a signal transmitter button and wish to retain its programming, proceed to step 3.

If you are programming the integrated remote control for the first time, press and hold the two outer signal transmitter buttons ② and ④ and release them only when indicator lamp ① begins to flash after approximately 20 seconds (do not hold the button for longer than 30 seconds). This procedure erases any previous settings for all three channels and initializes the memory.

If you later wish to program a second and/or third hand-held transmitter to the remaining two signal transmitter buttons, do not repeat this step and begin directly with step 3.

#### Step 3:

- ▶ Hold end of the hand-held remote control ⑤ of the device you wish to train approximately 2 to 5 in (5 to 12 cm) away from the signal transmitter button (②, ③ or ④) to be programmed, while keeping the indicator lamp ① in view.

#### Step 4:

- ▶ Using both hands, simultaneously press hand-held remote control button ⑥ and the desired signal transmitter button (②, ③ or ④). Do not release the buttons until step 5 is completed.

Indicator lamp ① will flash, first slowly and then rapidly.

**i** Indicator lamp ① flashes immediately the first time the signal transmitter button is programmed. If this button has already been programmed, the indicator lamp will only start flashing after 20 seconds.

#### Step 5:

- ▶ After indicator lamp ① changes from a slow to a rapidly flashing light, release the hand-held remote control button and the signal transmitter button.

#### Step 6:

- ▶ Press and hold the just-trained signal transmitter button (②, ③ or ④) and observe indicator lamp ①.

If indicator lamp ① stays on constantly, programming is complete and your device should activate when the respective signal transmitter button (②, ③ or ④) is pressed and released.

**i** If indicator lamp ① flashes rapidly for about 2 seconds and then turns to a constant light, continue with programming steps 8 through 12 as your garage door opener may be equipped with the "rolling code" feature.

Step 7:

- ▶ To program the remaining two signal transmitter buttons, repeat the steps above starting with step 3.

### **Rolling code programming**

To train a garage door opener (or other rolling code devices) with the rolling code feature, follow these instructions after completing the “Programming” portion (steps 1 through 6) of this text. (A second person may make the following training procedures quicker and easier.)

Step 8:

- ▶ Locate “training” button on the garage door opener motor head unit.

Exact location and color of the button may vary by garage door opener brand. Depending on manufacturer, the “training” button may also be referred to as “learn” or “smart” button. If there is difficulty locating the transmitting button, refer to the garage door opener Operator’s Manual.

Step 9:

- ▶ Press the “training” button on the garage door opener motor head unit.  
The “training light” is activated.

You have 30 seconds to initiate the following two steps.

Step 10:

- ▶ Return to the vehicle and firmly press, hold for 2 seconds and release the programmed signal transmitter button (②, ③ or ④).

Step 11:

- ▶ Press, hold for 2 seconds and release same signal transmitter button a second time to complete the training process.

**i** *Some garage door openers (or other rolling code equipped devices) may require you to press, hold for 2 seconds and release the same signal transmitter button a third time to complete the training process.*

Step 12:

- ▶ Confirm the garage door operation by pressing the programmed signal transmitter button (②, ③ or ④).

Step 13:

- ▶ To program the remaining two signal transmitter buttons, repeat the steps above starting with step 3.

### **Gate operator/Canadian programming**

Canadian radio-frequency laws require transmitter signals to “time-out” (or quit) after several seconds of transmission which may not be long enough for the integrated signal transmitter to pick up the signal during programming. Similar to this Canadian law, some U.S. gate operators are designed to “time-out” in the same manner.

If you live in Canada or if you are having difficulties programming a gate operator (regardless of where you live) by using the programming procedures, replace step 4 with the following:

### Useful features

Step 4:

- ▶ Press and hold the signal transmitter button (②, ③ or ④). Do not release this button until it has been successfully trained.
- ▶ While still holding down the signal transmitter button (②, ③ or ④), “cycle” your hand-held remote control button ⑥ as follows: Press and hold button ⑥ for 2 seconds, then release it for 2 seconds, and again press and hold it for 2 seconds. Repeat this sequence on the hand-held remote control until the frequency signal has been learned. Upon successful training, indicator lamp ① will flash slowly and then rapidly after several seconds.
- ▶ Proceed with programming step 5 and step 6 to complete.

**i** Upon completion of programming the integrated remote control, make sure you retain the hand-held remote control that came with the garage door opener, gate operator or other device. You may need it for use in other vehicles, for future programming of an integrated remote control, or simply for continued use as a hand-held remote control to operate the respective device in other situations.

#### Reprogramming a single signal transmitter button

To program a device using a signal transmitter button previously trained, follow these steps:

- ▶ Switch on the ignition (▷ page 42).
- ▶ Press and hold the desired signal transmitter button (②, ③ or ④). Do not release the button.
- ▶ Indicator lamp ① will begin to flash after 20 seconds. Without releasing the signal transmitter button, proceed with programming starting with step 3.

#### Operation of integrated remote control

- ▶ Switch on the ignition (▷ page 42).
- ▶ Select and press the appropriate integrated signal transmitter button (②, ③ or ④) to activate the remote controlled device.

The integrated remote control transmitter continues to send the signal as long as the button is pressed – up to 20 seconds.

#### Erasing the integrated remote control memory

- ▶ Switch on the ignition (▷ page 42).
- ▶ Simultaneously press and hold outer signal transmitter buttons ② and ④, for approximately 20 seconds, until indicator lamp ① flashes rapidly. Do not hold for longer than 30 seconds.

The codes of all three channels are erased.

**i** If you sell your vehicle, erase the codes of all three channels.

## Programming tips

If you are having difficulty programming the integrated remote control, here are some helpful tips:

- Check the frequency of hand-held remote control ⑤ (typically located on the reverse side of the remote). The integrated remote control is compatible with radio-frequency devices operating between 280-390 MHz.
- Put a new battery in hand-held remote control ⑤. This will increase the likelihood of the hand-held remote control sending a faster and more accurate signal to the integrated remote control.
- While performing step 3, hold hand-held remote control ⑤ at different lengths and angles from the signal transmitter button (②, ③ or ④) you are programming. Attempt varying angles at the distance of 2 to 5 in (5 to 12 cm) away or the same angle at varying distances.
- If another hand-held remote control is available for the same device, try the programming steps again using that other hand-held remote control. Make sure new batteries are in the hand-held remote control before beginning the procedure.
- Straighten the antenna wire from the garage door opener assembly. This may help improve transmitting and/or receiving signals.

**i** *Certain types of garage door openers are incompatible with the integrated remote control. If you should experience further difficulties with programming the integrated remote control, contact an authorized Mercedes-Benz Light Truck Center, or call Mercedes-Benz Customer Assistance Center (in the USA only) at 1-800-FOR-MERCedes, or Customer Service (in Canada) at 1-800-387-0100.*

**i** *USA only:  
This device complies with Part 15 of the FCC Rules. Operation is subject to the following two conditions:*

- (1) *This device may not cause harmful interference, and*
- (2) *this device must accept any interference received, including interference that may cause undesired operation.*

*Any unauthorized modification to this device could void the user's authority to operate the equipment.*

**i** *Canada only:  
This device complies with RSS-210 of Industry Canada. Operation is subject to the following two conditions:*



- (1) *This device may not cause interference, and*
- (2) *this device must accept any interference received, including interference that may cause undesired operation of the device.*

*Any unauthorized modification to this device could void the user's authority to operate the equipment.*

### Useful features

#### Compass

##### Calling up the compass

- ▶ Press button  or  repeatedly until the off-road menu appears in the multifunction display.

The compass displays the direction into which the vehicle is currently traveling: N, NE, E, SE, S, SW, W, or NW.

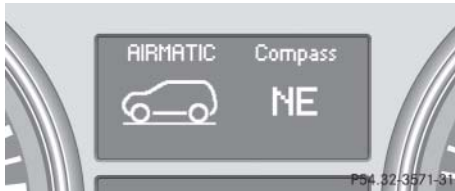

- i** *The presence of buildings, bridges, power lines and large antenna masts can influence the displayed values. Metallic or magnetic objects in or on the vehicle can influence the accuracy of the compass.*

To make sure the display is correct, the compass must be set to the proper geographic zone (▷ page 178). It may also be necessary to calibrate the compass (▷ page 179).

- i** *If the compass is not calibrated or its function is impaired by outside influences, the message Compass - - - appears in the multifunction display.*

#### Infrared reflecting windshield\*

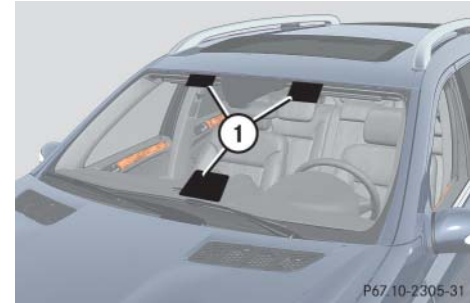

##### ① Infrared transparent areas

Infrared reflecting glass reduces the amount of radiated heat entering the vehicle interior through the windows.

The infrared reflecting glass also prevents the transmission of signals through the glass by in-vehicle electronic devices, e.g. electronic toll collection devices.

To allow the use of these devices in the vehicle, three infrared transparent areas ① are placed in the windshield.



**The first 1000 miles (1500 km)**

**Driving instructions**

**At the gas station**

**Engine compartment**

**Tires and wheels**

**Winter driving**

**Maintenance**

**Vehicle care**

### The first 1000 miles (1500 km)

In the “Operation” section you will find detailed information on operating, maintaining and caring for your vehicle.

The more cautiously you treat your vehicle during the break-in period, the more satisfied you will be with its performance later on.

- Drive your vehicle during the first 1000 miles (1500 km) at varying but moderate vehicle and engine speeds.
- During this period, avoid heavy loads (full throttle driving) and excessive engine speeds (no more than  $\frac{2}{3}$  of maximum rpm in each gear).
- Shift gears in a timely manner.
- Avoid accelerating by kick-down.
- Do not attempt to slow the vehicle down by shifting to a lower gear using the gear selector lever.
- Select gear ranges **3, 2** or **1** (▷ page 197) only when driving at moderate speeds (for hill driving).

After 1000 miles (1500 km) you may gradually increase vehicle and engine speeds to the permissible maximum.

All of the above instructions, as may apply to your vehicle type, also apply when driving the first 1000 miles (1500 km) after the engine, the transfer case, the center differential or the rear differential has been replaced.

 *Always obey applicable speed limits.*

## ▼ Driving instructions

### Drive sensibly – save fuel

Fuel consumption, to a great extent, depends on driving habits and operating conditions.

To save fuel you should:

- Keep tires at the recommended inflation pressures.
- Remove unnecessary loads.
- Remove carriers\* when not in use.
- Remove the crossbars\* when not in use.
- Allow engine to warm up under low load use.
- Avoid frequent acceleration and deceleration.
- Have all maintenance work performed at the intervals specified in the Maintenance Booklet and as required by the Maintenance System. Contact an authorized Mercedes-Benz Light Truck Center.

Fuel consumption is also increased by driving in cold weather, in stop-and-go traffic, on short trips and in hilly areas.

### Drinking and driving

#### Warning!



Drinking and driving and/or taking drugs and driving are a very dangerous combination. Even a small amount of alcohol or drugs can affect your reflexes, perceptions and judgment.

The possibility of a serious or even fatal accident are greatly increased when you drink or take drugs and drive.

Do not drink or take drugs and drive or allow anyone to drive who has been drinking or taking drugs.

### Pedals

#### Warning!



Make sure that absolutely no objects are obstructing the pedal's range of movement. Keep the driver's footwell clear of all obstacles. If there are any floor mats or carpets in the footwell, make sure that the pedals still have sufficient clearance.

During sudden driving or braking maneuvers, the objects could get caught between the pedals. You could then no longer brake or accelerate. This could lead to accidents and injury.



## Driving instructions

### Power assistance

#### Warning!



With the engine not running, there is no power assistance for the brake and steering systems. In this case, it is important to keep in mind that a considerably higher degree of effort is necessary to brake and steer the vehicle.

### Brakes

#### Warning!



After driving in heavy rain for some time without applying the brakes or through water deep enough to wet brake components, the first braking action may be somewhat reduced and increased pedal pressure may be necessary to obtain expected braking effect. Maintain a safe distance from vehicles in front.

Resting your foot on the brake pedal will cause excessive and premature wear of the brake pads.

It can also result in the brakes overheating, thereby significantly reducing their effectiveness. It may not be possible to stop the vehicle in sufficient time to avoid an accident.

**!** Operational or performance test must only be conducted on a two-axle dynamometer. If such tests are necessary, contact an authorized Mercedes-Benz Light Truck Center. You could otherwise seriously damage the brake system or the transfer case which is not covered by the Mercedes-Benz Limited Warranty.

**!** Because the ESP<sup>®</sup> operates automatically, the engine and ignition must be shut off (SmartKey in starter switch position **0** or **1** or KEYLESS-GO\* start/stop button in position **0** or **1**) when testing the parking brake on a brake test dynamometer and such testing should be no longer than 10 seconds.

Active braking action through the ESP<sup>®</sup> may otherwise seriously damage the brake system which is not covered by the Mercedes-Benz Limited Warranty.

To help prevent brake disk corrosion after driving on wet road surfaces (particularly salted roads), it is advisable to brake the vehicle with considerable force prior to parking. The heat generated serves to dry the brakes.

If your brake system is normally only subjected to moderate loads, you should occasionally test the effectiveness of the brakes by applying above-normal braking pressure at higher speeds. This will also enhance the grip of the brake pads.

**Warning!**

Make sure not to endanger any other road users when carrying out these braking maneuvers.

Refer to the description of the Brake Assist System (BAS) (▷ page 103).

Brake pad wear or a leak in the system may be the reason for low brake fluid in the reservoir.

The brake fluid level in the reservoir may be too low if the brake warning lamp in the instrument cluster comes on and an acoustic warning sounds although the parking brake is released (▷ page 437). Observe additional messages in the multi-function display that may appear (▷ page 469).

Have the brake system inspected immediately. Contact an authorized Mercedes-Benz Light Truck Center.

All checks and service work on the brake system should be carried out by qualified technicians only. Contact an authorized Mercedes-Benz Light Truck Center.

Only install brake pads and brake fluid recommended by Mercedes-Benz.

**Warning!**

If other than recommended brake pads are installed, or other than recommended brake fluid is used, the braking properties of the vehicle can be degraded to an extent that safe braking is substantially impaired. This could result in an accident.

**!** *When driving down long and steep grades, relieve the load on the brakes by shifting into a lower gear to use the engine's braking power. This helps prevent overheating of the brakes and reduces brake pad wear.*

*When using the engine's braking power, a drive wheel may not spin for an extended period of time, e.g. on slippery road surfaces. This may cause serious damage to the drivetrain which is not covered by the Mercedes-Benz Limited Warranty.*

After hard braking, it is advisable to drive on for some time, rather than immediately park, so that the air stream will cool down the brakes faster.

## Driving instructions

### Parking brake

When driving on wet roads or dirt covered surfaces, road salt and/or dirt can get into the parking brake. To prevent corrosion and a reduction in the braking power of the parking brake, observe the following:

- ▶ From time to time, lightly engage the parking brake before driving off.
- ▶ Drive a distance of approximately 110 yds (100 m) at a maximum speed of 12 mph (20 km/h).

#### Warning!



While performing this procedure, please assure that the vehicle is stopped before applying the parking brake. Otherwise the rear wheels could lock up. You could lose control of the vehicle and cause an accident. In addition, the vehicle's brake lights do not light up when the parking brake is engaged. Make sure not to endanger any other road users when you engage the parking brake.

### Driving off

Apply the brakes to test them briefly after driving off. Perform this procedure only when the road is clear of other traffic.

Warm up the engine smoothly. Do not place full load on the engine until the operating temperature has been reached.

**!** *When driving off on a slippery surface, do not allow a drive wheel to spin for an extended period with the ESP<sup>®</sup> switched off. Doing so may cause serious damage to the drivetrain which is not covered by the Mercedes-Benz Limited Warranty.*

**!** *Simultaneously depressing the accelerator pedal and applying the brake reduces engine performance and causes premature brake and drivetrain wear.*

### Parking

#### Warning!



Do not park this vehicle in areas where combustible materials such as grass, hay or leaves can come into contact with the hot exhaust system, as these materials could be ignited and cause a vehicle fire.

To reduce the risk of personal injury or damage to the vehicle drivetrain as a result of vehicle movement, before turning off the engine and leaving the vehicle always:

- Keep right foot on brake pedal.
- Firmly depress parking brake pedal.
- Set the automatic transmission to position **P**.
- Slowly release brake pedal.
- When parked on an incline, turn front wheel towards the road curb.

- Turn the SmartKey or the SmartKey with KEYLESS-GO\* to starter switch position **0** and remove, or press KEYLESS-GO\* start/stop button (vehicles with KEYLESS-GO\*).
- Take the SmartKey or the SmartKey with KEYLESS-GO\* with you and lock vehicle when leaving.

## Tires

### Warning!



If you feel a sudden significant vibration or ride disturbance, or you suspect that possible damage to your vehicle has occurred, you should turn on the hazard warning flashers, carefully slow down, and drive with caution to an area which is a safe distance from the road.

Inspect the tires and the vehicle underbody for possible damage. If the vehicle or tires appear unsafe, have the vehicle towed to the nearest Mercedes-Benz Light Truck Center or tire dealer for repairs.

Treadwear indicators (TWI) are required by law. These indicators are located in six places on the tread circumference and become visible at a tread depth of approximately  $\frac{1}{16}$  in (1.6 mm), at which point the tire is considered worn and should be replaced.

The treadwear indicator appears as a solid band across the tread.

### Warning!



Although the applicable federal motor vehicle safety laws consider a tire to be worn when the treadwear indicators (TWI) become visible at approximately  $\frac{1}{16}$  in (1.6 mm), we recommend that you do not allow your tires to wear down to that level. As tread depth approaches  $\frac{1}{8}$  in (3 mm), the adhesion properties on a wet road are sharply reduced.

Depending upon the weather and/or road surface (conditions), the tire traction varies widely.

Specified tire inflation pressures must be maintained. This applies particularly if the tires are subjected to high loads (e.g. high speeds, heavy loads, high ambient temperatures).

## Driving instructions

### Warning!



Do not drive with a flat tire. A flat tire affects the ability to steer or brake the vehicle. You may lose control of the vehicle. Continued driving with a flat tire or driving at high speed with a flat tire will cause excessive heat build-up and possibly a fire.

For more information, see “Tires and wheels” (▷ page 384).

### Hydroplaning

Depending on the depth of the water layer on the road, hydroplaning may occur, even at low speeds and with new tires. Reduce vehicle speed, avoid track grooves in the road and apply brakes cautiously in the rain.

### Tire traction

The safe speed on a wet, snow covered or icy road is always lower than on a dry road.

You should pay particular attention to the condition of the road whenever the outside temperatures are close to the freezing point.

### Warning!



If ice has formed on the road, tire traction will be substantially reduced. Under such weather conditions, drive, steer and brake with extreme caution.

Mercedes-Benz recommends winter tires (▷ page 420) with a minimum tread depth of approximately  $\frac{1}{6}$  in (4 mm) on all four wheels for the winter season to make sure normal balanced handling characteristics. On packed snow, they can reduce your stopping distance compared to summer tires.

Stopping distance, however, is still considerably greater than when the road is not covered with snow or ice. Exercise appropriate caution.

**!** *Avoid spinning of a drive wheel. This may cause serious damage to the drivetrain which is not covered by the Mercedes-Benz Limited Warranty.*

## Tire speed rating

Regardless of the tire speed rating, local speed limits should be obeyed. Use prudent driving speeds appropriate to prevailing conditions.

### Warning!



Even when permitted by law, never operate a vehicle at speeds greater than the maximum speed rating of the tires.

Exceeding the maximum speed for which tires are rated can lead to sudden tire failure, causing loss of vehicle control and possibly resulting in an accident and/or serious injury and possible death, for you and for others.

An electronic speed limiter prevents your vehicle from exceeding a speed of 130 mph (210 km/h).

The factory equipped tires on your vehicle may have a tire speed rating above the maximum speed permitted by the electronic speed limiter.

Make sure your tires have the required tire speed rating as specified for your vehicle in the “Technical data” section (▷ page 555), for example when purchasing new tires.

For information on how to identify the tire speed rating on a tire’s sidewall, see “Tire size designation, load and speed rating” (▷ page 406).

If you are uncertain about the correct reading of the information given on a tire’s sidewall, any authorized Mercedes-Benz Light Truck Center will be glad to assist you.

**i** For information on speed ratings for winter tires, see “Winter tires” (▷ page 420).

For additional general information on tire speed markings on the tire sidewall, see “Tire speed rating” (▷ page 418).

## Winter driving instructions

The most important rule for slippery or icy roads is to drive sensibly and to avoid abrupt acceleration, braking and steering maneuvers. Do not use the cruise control system under such conditions.

When the vehicle is in danger of skidding, shift the automatic transmission to position **N**. Try to keep the vehicle under control by corrective steering action.

**i** For information on driving with snow chains, see “Snow chains” (▷ page 421).

### Driving instructions

#### Warning!



On slippery road surfaces, never downshift in order to obtain braking action. This could result in drive wheel slip and reduced vehicle control. Your vehicle's ABS will not prevent this type of control loss.

Do not engage the transfer case in position **LOW** when driving on ice or packed snow. At speeds below 18 mph (30 km/h) vehicle steering is adversely affected by the Off-road – ABS (▷ page 102).

Road salts and chemicals can adversely affect braking efficiency. Increased pedal force may become necessary to produce the normal brake effect.

Depressing the brake pedal periodically when traveling at length on salt-strewn roads can bring road-salt-impaired braking efficiency back to normal.

If the vehicle is parked after being driven on salt-treated roads, the braking efficiency should be tested as soon as possible after driving is resumed.

#### Warning!



Make sure not to endanger any other road users when carrying out these braking maneuvers.

#### Warning!



If the vehicle becomes stuck in snow, make sure that snow is kept clear of the exhaust pipe and from around the vehicle with the engine running. Otherwise, deadly carbon monoxide (CO) gases may enter vehicle interior resulting in unconsciousness and death.

To assure sufficient fresh air ventilation, open a window slightly on the side of the vehicle not facing the wind.

#### Warning!



The outside temperature indicator is not designed to serve as an ice-warning device and is therefore unsuitable for that purpose. Indicated temperatures just above the freezing point do not guarantee that the road surface is free of ice.

For more information, see “Winter driving” (▷ page 420).

## Standing water

**!** Do not drive through flooded areas or water of unknown depth. Before driving through water, determine its depth. Never accelerate before driving into water. The bow wave could force water into the engine and auxiliary equipment, thus damaging them.

If you must drive through standing water, drive slowly to prevent water from entering the passenger compartment or the engine compartment.

Water in these areas could cause

- damage to electrical components
  - wiring of the engine or transmission
- or could result
- in water being ingested by the engine through the air intake, causing severe internal engine damage.

Any such damage is not covered by the Mercedes-Benz Limited Warranty.

**i** Select the raised level (▷ page 279) before driving through standing water.

For more information, see “Driving through water” (▷ page 360).

## Off-road driving

### Warning!



Do not load items on the crossbars\*. It may cause instability during some maneuvers which could result in an accident.

Drive slowly in unknown terrain. This will make it easier to recognize unexpected obstacles and avoid damage to the vehicle.

To help avoid the vehicle rolling over, never turn it around on steep inclines. If the vehicle cannot complete the attempted climb, back it down in reverse gear.

Do not drive along the side of a slope. The vehicle might otherwise rollover. If in doing so the vehicle begins to show a tendency to roll, immediately steer into a line of gravity (straight up or downhill).

Never let the vehicle roll backwards in idle. You may lose control of the vehicle if you use only the service brake. For information on driving downhill, see “Driving downhill” (▷ page 360).

### Warning!



Sand, dirt, mud and other material having friction property can cause exceptional wear and tear as well as brake failure.

Have the brakes checked for dirt build-up and cleaned. There is otherwise a risk that full braking power may not be available in an emergency.

### Warning!



Please be aware that by raising the vehicle level, the center of gravity also rises. Therefore, always ensure that the vehicle level is as low as possible. With higher ride height the ESP® may activate earlier in certain situations.



### Driving instructions

Read this chapter carefully before you begin off-road travel.

Familiarize yourself with the vehicle characteristics and gear changing before you attempt any difficult terrain off-road driving. We recommend that you start out with easy off-road travel.

#### Special driving features for off-road driving

The following driving features are available for specific kind of operation:

- Off-road – ABS (▷ page 102)
- Off-road – ESP® (▷ page 106)
- Off-road – 4-ETS (▷ page 108)
- Hill start assist system (▷ page 196)
- LOW RANGE mode\* (▷ page 201)
- Differential locks\* (▷ page 204)
- Downhill Speed Regulation (DSR) (▷ page 273)
- Off-road driving program (Vehicles without enhanced off-road package\*) (▷ page 277)
- Air suspension (▷ page 278)

#### Off-road driving rules

- Engage the off-road driving program (▷ page 277) or LOW RANGE mode\* (▷ page 201) before driving under off-road conditions.
- If necessary, activate differential locks\* (▷ page 204).
- Make sure you select a vehicle level (▷ page 279) appropriate to the topographical conditions. Always make sure the vehicle has enough ground clearance.
- Fasten items being carried as securely as possible (▷ page 295).
- Always navigate gradients with the engine on and with the transmission engaged in a gear. Switch on the DSR (▷ page 274) to help maintain a preset speed.

**!** Observe the following during off-road driving:

- Keep doors, tailgate, windows, and tilt/sliding sunroof\* closed whenever driving off-road.
- Adjust vehicle speed to condition of terrain. The more uneven, rutty and steeper the terrain, the lower the speed should be. Drive through water slowly at an even speed, avoiding a bow wave.
- Be especially careful when driving in unknown territory. It may be necessary to get out of the vehicle and scout the path you intend to take.
- Watch out for obstacles, such as rocks, holes, tree stumps and ruts.
- Before driving through water, determine its depth.
- Do not stop vehicle while immersed in water, and do not shut off the engine.

- In sandy soil, drive at a steady speed as allowed by conditions. This helps overcome the vehicle rolling resistance and reduces the likelihood of the vehicle sinking into the ground.
- Do not initiate jumps with the vehicle. It interrupts the forward momentum of the vehicle.
- Always drive onto slopes with the engine running and the vehicle in gear.
- Do not shift automatic transmission to position **N**.

### Warning!



Do not reduce the tire inflation pressure before driving through sand. However, if you do so, remember to correct the tire inflation pressure (▷ page 395) before continuing your trip. Driving with reduced tire inflation pressure increases the risk of losing control of the vehicle and rolling over.

### Checklist before off-road driving

#### Engine oil level

- Check the engine oil level with the oil dipstick (▷ page 380).

Only with a proper oil level can the vehicle obtain a trouble-free oil supply, even on steep gradients.

**!** If the engine oil level warning lamp (▷ page 473) comes on while driving, stop the vehicle in a safe location or as soon as it is safe to do so. Check the engine oil level (▷ page 380).

The engine oil level warnings should not be ignored. Extended driving with the symbol displayed could result in serious engine damage that is not covered by the Mercedes-Benz Limited Warranty.

## Driving instructions

### Tires

- Check the tread depth and maintain specified tire inflation pressure (a placard with the recommended tire inflation pressures is located on the driver's door B-pillar (▷ page 388)).
- Check tires for possible damage and remove foreign objects.
- Replace missing valve caps.

### Rims

- Dented or bent rims can cause tire inflation pressure loss and damage the tire beads. For this reason, check and, if necessary, change rims before driving off-road.

### Vehicle tool kit

- Check if the vehicle jack (▷ page 492) is functional.
- In all cases take the vehicle tool kit, a strong tow rope, a shovel and a small plank (to put under the vehicle jack on sandy soil) with you.

### Driving in steep terrain

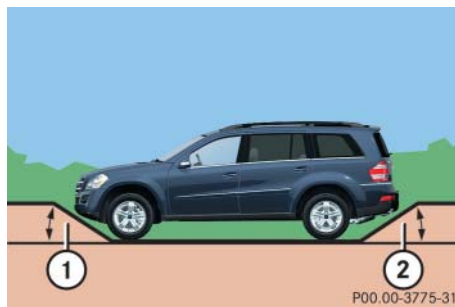

### Slope angle

- ① Overhang angle, front
- ② Overhang angle, rear

Vehicles with air suspension program	①	②
Raised level	34°	28°
Highway	29°	23°

Vehicles with enhanced off-road package*	①	②
Off-road-level 3	36°	30°
Off-road-level 2	34°	28°
Off-road-level 1	31°	25°
Highway	29°	23°

- Comply with the warnings (▷ page 355) and rules for off-road driving (▷ page 356).
- Driving on embankments, slopes and other steep inclines should only be done straight up or downhill, i.e. in the line of gravity. Maximum vehicle climbing ability is a 100% grade which is equivalent to a slope angle of 45 degrees. Keep in mind that the climbing ability of the vehicle depends on terrain conditions.

- Shift automatic transmission to position **1** (▷ page 197).
- Drive slowly.
- Avoid excessive engine speeds – drive with moderate engine speeds (max. 3000 rpm).
- Utilize the engine's braking power when descending a slope, observe the engine speed (do not overrev the engine). Apply the service brake as needed.

**i** For maximum engine speed, see “Instrument cluster” (▷ page 26) and see “Engine” (▷ page 553).

- Check the brakes after a lengthy down-grade drive.

### Warning!



Never turn the vehicle around on steep inclines. The vehicle might roll over. If the vehicle cannot complete the attempted climb, back it down in reverse gear.

**i** The hill start assist system supports you when driving uphill.

For more information, see “Hill start assist system” (▷ page 196).

### Traction in steep terrain

The maximum vehicle climbing ability is a 100% grade which is equivalent to a slope angle of 45 degrees. Keep in mind that the climbing ability of the vehicle depends on terrain conditions.

Be easy on the accelerator and watch for continuous wheel traction when driving in steep terrain.

**i** The 4-ETS helps greatly when starting out on a steep incline when the front wheels have then the tendency to slip due to the weight shifting towards the rear axle.

The 4-ETS recognizes the situation and limits the torque for the front wheels by braking them. Simultaneously the torque for the rear wheels is increased.

**i** Vehicles with enhanced off-road package\* are equipped with automatic locks for the center and rear axle differential to improve vehicle traction.

### Driving across a hilltop

Decelerate just ahead of a hilltop (do not shift automatic transmission to position **N**), to prevent the vehicle from speeding up too much after climbing a hill.

Use the momentum of the vehicle to drive across the hilltop.

After climbing a hill, driving in this manner prevents the vehicle from:

- losing ground contact when cresting hills
- losing its forward momentum
- speeding up too much after climbing the hill

## Driving instructions

### Driving downhill

- Drive slowly.
- Do not drive at an angle to the incline. Steer into the line of gravity and drive with the front wheels pointing straight downhill. Otherwise, the vehicle may slide sideways off the path and roll over.
- Shift automatic transmission to position **1** (▷ page 197).
- On steep inclines, use the Downhill Speed Regulation (▷ page 273).
- Utilize the engine's braking power to reduce vehicle speed.  
If this is insufficient, apply the brake gently. Make sure the vehicle is moving in the line of gravity.
- Check the brakes after a lengthy down-grade drive.

**i** The special Off-road – ABS (▷ page 102) setting allows for precise and brief (cyclical) blocking of the front wheels, permitting them to dig into loose ground.

*Remember that, when stopped, the front wheels slide across a surface and thus lose their ability to steer the vehicle.*

### Driving through water

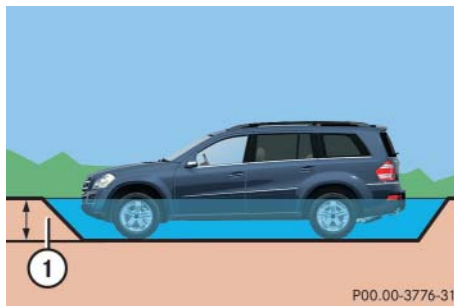

① Fording depth

Vehicles with air suspension program	①
Raised level	20.00 in (50 cm)

Vehicles with enhanced off-road package*	①
Off-road 3 level	23.60 in (60 cm)
Off-road 2 level	20.00 in (50 cm)
Off-road 1 level	20.00 in (50 cm)

- Before driving through water, determine its depth.

**!** The water depth must not exceed the respective value listed in the table. The ground under the water might not be firm which could result the water being deeper than expected when driving the vehicle through it. Please note that the water level is correspondingly lower for flowing water.

- Select the highest vehicle level possible (▷ page 279).
- Switch to off-road driving program (▷ page 277) or LOW RANGE mode\* (▷ page 201) before driving through water.
- Shift automatic transmission to position **1** or **2** (▷ page 197).
- Avoid high engine speeds.
- Enter and leave the water only at a shallow spot, driving at walking speed.

**!** *Never accelerate before driving into the water. The bow wave could force water into the engine and auxiliary equipment, thus damaging them.*

- Drive through the water slowly and at a constant speed.

- Do not stop vehicle while immersed in water, and do not shut off the engine.

**!** *Do not open any of the vehicle's doors while driving through water. Water could otherwise enter the vehicle interior and damage the vehicle's electronics, as well as the interior equipment.*

- There is a very high level of driving resistance in water. The surface is slippery and may not be firm, making pulling away in water difficult and dangerous.
- Make sure that only small bow waves are formed when driving the vehicle through water.
- Clean mud off the tire tread after driving through water.
- To dry the brakes, apply pressure to the brake pedal several times while driving after leaving the water.

### Crossing obstacles



**!** *Obstacles can damage the vehicle underbody or suspension components. If possible use the assistance of a second person outside the vehicle to scout the path you intend to take and check for adequate ground clearance when you cross obstacles with your vehicle. The person assisting you outside the vehicle should always be a safe distance away from the vehicle and positioned so that he or she cannot get hurt in case of any unexpected vehicle movement.*

*After off-road driving or crossing obstacles, inspect vehicle for any damage, especially vehicle underbody and suspension components. Failure to do so can adversely affect the vehicle's future performance, including increased chance of an accident.*

### Driving instructions

When driving over tree stumps, big rocks and other obstacles, observe the following rules:

- Make sure the off-road driving program (▷ page 277) or if equipped the LOW RANGE mode\* (▷ page 201) is switched on.
- Avoid high engine speeds.
- Shift automatic transmission to position **1** (▷ page 197).
- Check the vehicle clearance before crossing obstacles.
- Cross obstacles (e.g. tree stumps or big rocks) very slowly by aiming one of the front wheels at the center of the obstacle, and repeat same with the rear wheel.

**!** *Special attention is needed when you cross obstacles on a steep incline.*

*The vehicle could slide sideways as a result of its possible slanted position which in turn may result in the vehicle tipping or rolling over.*

### Driving on sand

#### Warning!



Do not reduce the tire inflation pressure before driving through sand. However, if you do so, remember to correct the tire inflation pressure (▷ page 395) before continuing your trip. Driving with reduced tire inflation pressure increases the risk of losing control of the vehicle and rolling over.

When driving on sand, observe the following rules:

- Set the raised level (▷ page 279).
- Avoid high engine speeds.
- Shift automatic transmission into a gear range that is appropriate for the terrain.

- In sandy soil, drive at a steady speed as conditions permit. This helps overcome the vehicle rolling resistance and reduce the likelihood of the vehicle sinking into the ground.
- Drive in tracks of other vehicles if they are not too deep and you have sufficient clearance.

### Ruts

A number of off-road tracks or other byways have deep ruts which can cause the underbody to come in contact with the ground.

- Make sure the off-road driving program (▷ page 277), or if equipped, the LOW RANGE mode\* (▷ page 201) is switched on.
- Set the raised level (▷ page 279).

**!** Check that the ruts are not too deep and your vehicle's clearance is sufficient. Otherwise:

- your vehicle may be damaged
- the underbody of the vehicle may come in contact with the ground and you may get stuck
- Avoid high engine speeds.
- Shift automatic transmission to position **1** (▷ page 197).
- Drive next to the ruts rather than through them if at all possible.
- If the ruts are too deep to drive in, drive with one side of the vehicle on the grassy center strip if the route permits.

### Returning from off-road driving

#### Warning!



If you feel a sudden significant vibration or ride disturbance, or you suspect that possible damage to your vehicle has occurred, you should turn on the hazard warning flashers, carefully slow down, and drive with caution to an area which is a safe distance from the roadway.

Inspect the tires and under the vehicle for possible damage. If the vehicle or tires appear unsafe, have it towed to the nearest Mercedes-Benz Light Truck Center or tire dealer for repairs.

Damage to the vehicle may influence driving comfort and pose the risk of accident to you and other drivers.

Off-road driving increases strain on the vehicle.

We recommend that you inspect the vehicle for possible damage after each off-road trip. Recognizing any damage and a subsequent timely repair reduces the chance of a possible breakdown or accident later on.

Proceed as follows:

- Switch off the off-road driving program (▷ page 278) or the LOW RANGE mode\* (▷ page 201).
- Switch off the DSR (▷ page 274).
- Set the differential locks\* to AUTO (▷ page 205).
- Lower the vehicle back to a level suitable for road conditions, e.g. Highway/High-speed level (▷ page 279).
- Clean all exterior lamps and check for possible damage.



### Driving instructions

- Clean the front and rear license plate.
- Remove excessive dirt from tires, wheels, wheel housings, and underbody.

For instance, after driving in mud, clean the radiator, chassis, engine, brakes, and wheels from extreme dirt using a strong jet of water.

- Check tires for possible damage.
- Inspect vehicle underbody, oil pan, brake hoses, etc., as well as vehicle underbody for possible damage.
- Check for brush or branches caught in the underbody.

**!** *Brush or branches could increase the possibility of a fire, as well as cut fuel and/or brake lines, puncture rubber bellows of the axles or drive shafts.*

- After continued operation in mud, sand, water or other dirty conditions clean the brake discs, wheels, brake pads and check and clean axle joints.
- Conduct a brake test.

### Trailer towing

#### Warning!



Failure to use proper equipment and driving technique can result in a loss of vehicle control when towing a trailer.

Improper towing or failure to follow the instructions in this manual can result in vehicle damage and/or serious personal injury. Follow the guidelines below carefully to assure safe trailer operation.

Contact an authorized Mercedes-Benz Light Truck Center should you require an explanation of information contained in this manual.

### Trailer hitch\*

- Only install a trailer hitch receiver approved for your vehicle.

For information on availability and installation, contact an authorized Mercedes-Benz Light Truck Center.

- The bumpers on your vehicle are not designed for use with clamp-type hitches.

Do not attach rental hitches or other bumper-type hitches to them.

- To reduce the possibility of damage, remove the hitch ball adaptor from the receiver when not in use.

## Electrical connections

The vehicle is prewired to accept the seven-wire harness included in the Mercedes-Benz approved trailer hitch receiver kit.

**i** A four-pole conversion plug is available from your authorized Mercedes-Benz Light Truck Center as a spare part.

For further information, contact an authorized Mercedes-Benz Light Truck Center.

## Vehicle and trailer weights and ratings

**Gross Vehicle Weight Rating (GVWR)** is the maximum permissible vehicle weight: 6944 lb (3150 kg).

**Gross Vehicle Weight (GVW):** Comprises weight of vehicle including fuel, tools, spare wheel, installed accessories, passengers, cargo and trailer tongue. It must never exceed the GVWR.

**Gross Axle Weight Rating (GAWR)** is the maximum permissible axle weight:

	<b>GL 320 CDI</b>
Front	3306 lb (1500 kg)
Rear	3968 lb (1800 kg)

	<b>GL 450, GL 550</b>
Front	3240 lb (1470 kg)
Rear	3968 lb (1800 kg)

The **Gross Trailer Weight (GTW)** is the weight of the trailer plus the weight of all cargo, equipment, luggage etc. loaded on the trailer. The maximum permissible gross trailer weight to be towed: 7500 lb (3402 kg).

**Trailer Tongue Weight Rating (TWR)** is the maximum permissible weight on the trailer tongue: 600 lb (272 kg) limit for Mercedes-Benz approved hitch receiver.

## Loading a trailer

- When loading a trailer, you should observe that neither the permissible GTW, nor the GVWR are exceeded.

Maximum permissible values are listed on the safety compliance certification labels for the vehicle and for the trailer to be towed.

The lowest value listed must be selected when determining how the vehicle and trailer are loaded.

- The tongue weight at the hitch ball must be added to the GVW to prevent exceeding your Mercedes-Benz tow vehicle's rear GAWR.

**i** We recommend loading the trailer in such a manner that it has a Tongue Weight (TW) between 8% and 15% of the Gross Trailer Weight (GTW).

**i** Maximum trailer weight ratings are calculated assuming the vehicle, plus driver. The weight of other accessories, passengers and cargo will reduce the maximum trailer weight and Tongue Weight (TW) your vehicle can tow.

## Driving instructions

### *Checking weights of vehicle and trailer*

- To assure that the tow vehicle and trailer are in compliance with the maximum permissible weight limits have the loaded rig (tow vehicle including driver, passengers and cargo, trailer fully loaded) weighed on a commercial scale.
- Check the vehicle's front and rear Gross Axle Weight (GAW), the Gross Trailer Weight (GTW) and Tongue Weight (TW).

The values as measures must not exceed the weight limits listed under "Vehicle and trailer weight and ratings" (▷ page 365).

### Attaching a trailer

#### Warning!



While you are coupling or decoupling a trailer, make sure that you do not

- lock or unlock
- open or close

a vehicle door or the tailgate.

The vehicle's level could change and you could endanger yourself and/or others as a result.

Make sure that you do not operate the ADS button\* (▷ page 279) or the vehicle level control system (▷ page 279) when coupling/decoupling the trailer.

Observe maximum permitted trailer dimensions (width and length).

Most states and all Canadian provinces require

- safety chains between your tow vehicle and the trailer.

The chains should be criss-crossed under the trailer tongue. They must be attached to the hitch receiver, and not to the vehicle's bumper or axle.

Make sure to leave enough slack in the chains to permit turning corners.

- a separate brake system at various trailer weights.
- a break-away switch on trailers with a separate brake system. Check with your local state laws for specific requirements.

The switch activates the trailer brakes in the possible event that the trailer might separate from the tow vehicle.

**!** Do not connect a trailer brake system (if trailer is so equipped) directly to the vehicle's hydraulic brake system, as your vehicle is equipped with antilock brakes. If you do, neither the vehicle's brakes nor the trailer's brakes will function properly.

**i** The provided vehicle electrical connector for trailer towing has a brake signal wire for hook-up to a brake controller.

You should consider using a trailer sway control system. For further information, contact an authorized Mercedes-Benz Light Truck Center.

- ▶ Make sure the automatic transmission is set to **P** (▷ page 191).
- ▶ Set the parking brake for the vehicle (▷ page 67).
- ▶ Start the engine (▷ page 56).
- ▶ Set the vehicle level to Highway (▷ page 279).
- ▶ Vehicle with ADS\*: Set the ADS\* to AUTO or COMFORT (▷ page 278).
- ▶ Turn off the engine (▷ page 68).

- ▶ Close all doors and the tailgate.
- ▶ Attach the trailer.
- ▶ Plug in all electrical connectors.

**i** When you are towing a trailer, the vehicle level always remains in the Highway setting.

The following applies additionally when towing a trailer:

- The vehicle is lowered to the highway level when it reaches a speed of 5 mph (8 km/h) if not set to highway level.
- The high-speed level is not available.

The restrictions that apply to towing also apply when using accessories that are connected to the trailer power socket, such as a bicycle rack.

### Towing a trailer

There are many different laws, including speed limit restrictions, having to do with trailer towing. Make sure your rig will be legal, not only for where you reside, but also for where you will be driving. A good source for this information can be the police or local authorities.

Note the following points, when driving with the trailer:

- In order to gain skill and an understanding of the vehicle's behavior, you should practice turning, stopping and backing up in an area which is free from traffic.
- Before you start driving check the
  - trailer hitch
  - break-away switch
  - safety chains
  - electrical connections
  - lighting and tires
- Adjust the mirrors (▷ page 51) to permit unobstructed view beyond rear of trailer.
- If the trailer has electric brakes, start your vehicle and trailer moving slowly, and then apply only the trailer brake controller by hand to make sure the brakes are working properly.

## Driving instructions

- Always secure items in the trailer to prevent load shifts while driving.
- When towing a trailer, check occasionally to make sure the load is secure, and that lighting and trailer brakes (if so equipped) are functioning properly.

- Take into consideration that when towing a trailer, the handling characteristics are different and less stable from those when operating the vehicle without a trailer.

It is important to avoid sudden maneuvers.

- The vehicle and trailer combination is heavier, and therefore is limited in acceleration and climbing ability, and requires longer stopping distances.

It is more prone to reacting to cross wind gusts, and requires more sensitive steering input.

- If possible, do not brake abruptly, but rather engage the brake slightly at first to permit the trailer to activate its brake. Then increase the braking force.

**!** *If the trailer should begin to sway, reduce the vehicle's speed immediately.*

*In no case attempt to straighten out the tow vehicle and trailer by increasing the speed.*

- If the transmission repeatedly shifts between gears on inclines, manually shift to a lower gear (select **4, 3, 2** or **1**) (▷ page 197).

A lower gear and reduction of speed reduces the chance of engine overloading and/or overheating.

- On very steep inclines, not manageable with automatic transmission in **1**, switch on off-road driving program (▷ page 278) or LOW RANGE mode\* (▷ page 201).
- When going down a long hill, shift into a lower gear and use the engine's braking effect.

Avoid riding the brakes, thus overheating the vehicle and trailer brakes.

- If the engine coolant rises to an extremely high temperature (coolant temperature needle approaching the red zone) when the air conditioning is on, turn off the air conditioning system.

Engine coolant heat can be additionally vented by opening the windows, switching the climate control fan speed to high and setting the temperature control to the maximum hot position.

- Extreme care must be exercised since your vehicle with a trailer will require additional passing distance ahead than when driving without a trailer.

Because your vehicle and trailer is longer than your vehicle alone, you will also need to go much farther ahead of the passed vehicle before you can return to your lane.

## Uncoupling the trailer

### Warning!



While you are coupling or decoupling a trailer, make sure that you do not

- lock or unlock
- open or close

a vehicle door or the tailgate.

The vehicle's level could change and you could endanger yourself and/or others as a result.

Make sure that you do not operate the ADS button\* (▷ page 279) or the vehicle level control system (▷ page 279) when coupling/decoupling the trailer.

- ▶ Make sure the automatic transmission is set to **P** (▷ page 191).
- ▶ Set the parking brake for the vehicle (▷ page 67).
- ▶ Start the engine (▷ page 56).
- ▶ Close all doors and the tailgate.
- ▶ Set the parking brake for the trailer.

### Warning!



As soon as you disconnect the electrical connection between the trailer and the vehicle, the vehicle will lower. To help avoid personal injury, make sure no one is near the wheel housing or underneath the vehicle before the electrical connection is disconnected.

When you uncouple the trailer, the vehicle is temporarily raised because the springs are relieved of load. Be especially careful during this process, as you could otherwise injure yourself and/or others. Make sure that any persons remaining in the vehicle do not press the switches for vehicle level control or the ADS\*.

- ▶ Disconnect all electrical plug connectors.
- ▶ Uncouple the trailer.
- ▶ Make sure that the trailer coupling is free of load.
- ▶ Turn off the engine (▷ page 68).

### Driving instructions

#### Passenger compartment

##### Warning!



Always fasten items being carried as securely as possible.

In an accident, during hard braking or sudden maneuvers, loose items will be thrown around inside the vehicle, and cause injury to vehicle occupants unless the items are securely fastened in the vehicle.

The rear cargo compartment is the preferred place to carry objects. Always use tie down rings, and if so equipped, always use the cargo net\* when transporting cargo. The cargo net\* cannot secure hard or heavy objects. Always fasten items being carried as securely as possible using the cargo tie-down rings in the cargo floor area and fastening materials.

#### Driving abroad

Abroad, there is an extensive Mercedes-Benz service network at your disposal. If you plan to drive into areas which are not listed in the index of your Mercedes-Benz Light Truck Center directory, you should request pertinent information from an authorized Mercedes-Benz Light Truck Center.

#### Control and operation of radio transmitters

#### COMAND system, radio and telephone\*

##### Warning!



Do not forget that your primary responsibility is to drive the vehicle. Only operate the COMAND system, radio or telephone<sup>1</sup> if road, weather and traffic conditions permit.

Bear in mind that at a speed of just 30 mph (approximately 50 km/h), your vehicle is covering a distance of 44 feet (approximately 14 m) every second.

<sup>1</sup> Observe all legal requirements.

## Telephones and two-way radios

### Warning!



Never operate radio transmitters equipped with a built-in or attached antenna (i.e. without being connected to an external antenna) from inside the vehicle while the engine is running. Doing so could lead to a malfunction of the vehicle's electronic system, possibly resulting in an accident and/or personal injury.

Radio transmitters, such as a portable telephone or a citizens band unit should only be used inside the vehicle if they are connected to an antenna that is installed on the outside of the vehicle.

Refer to the radio transmitter operation instructions regarding use of an external antenna.

## Catalytic converter (gasoline engine)

Your Mercedes-Benz is equipped with monolithic-type catalytic converters, an important element in conjunction with the oxygen sensors to achieve substantial control of the pollutants in the exhaust emissions. Keep your vehicle in proper operating condition by following our recommended maintenance instructions as outlined in your Maintenance Booklet.

**!** *To prevent damage to the catalytic converters, use only premium unleaded gasoline in this vehicle.*

*Any noticeable irregularities in engine operation should be repaired promptly. Otherwise, excessive unburned fuel may reach the catalytic converter, causing it to overheat and potentially start a fire.*

### Warning!



As with any vehicle, do not idle, park or operate this vehicle in areas where combustible materials such as grass, hay or leaves can come into contact with the hot exhaust system, as these materials could be ignited and cause a vehicle fire.

## Oxidation catalyst (diesel engine)

Your vehicle is equipped with an oxidation catalyst, an important element in conjunction with the oxygen sensors to achieve substantial control of the pollutants in the exhaust emissions. Keep your vehicle in proper operating condition by following our recommended maintenance instructions as outlined in your Maintenance Booklet.



### Driving instructions

#### Warning!



As with any vehicle, do not idle, park or operate this vehicle in areas where combustible materials such as grass, hay or leaves can come into contact with the hot exhaust system, as these materials could be ignited and cause a vehicle fire.

#### Emission control

Certain engine systems serve to keep the toxic components of the exhaust gases within permissible limits required by law.

These systems, of course, will function properly only when maintained strictly according to factory specifications. Any adjustments on the engine should, therefore, be carried out only by qualified Mercedes-Benz Light Truck Center authorized technicians.

Engine adjustments should not be altered in any way. Moreover, the specified service jobs must be carried out regularly according to Mercedes-Benz servicing requirements. For details refer to the Maintenance Booklet.

#### Warning!



Inhalation of exhaust gas is hazardous to your health. All exhaust gas contains carbon monoxide (CO), and inhaling it can cause unconsciousness and possible death.

Do not run the engine in confined areas (such as a garage) which are not properly ventilated. If you think that exhaust gas fumes are entering the vehicle while driving, have the cause determined and corrected immediately. If you must drive under these conditions, drive only with at least one window fully open at all times.

#### Coolant temperature

During severe operating conditions, e.g. stop-and-go traffic, the coolant temperature may rise close to approximately 248°F (120°C).

The engine should not be operated with the coolant temperature above 248°F (120°C). Doing so may cause serious engine damage which is not covered by the Mercedes-Benz Limited Warranty.

**Warning!**

- Driving when your engine is overheated can cause some fluids, which may have leaked into the engine compartment to catch fire. You could be seriously burned.
- Steam from an overheated engine can cause serious burns which can occur just by opening the engine hood. Stay away from the engine if you see or hear steam coming from it.

Turn off the engine, get out of the vehicle and do not stand near the vehicle until the engine has cooled down.

## At the gas station

### Refueling

#### Warning!



Gasoline and diesel fuels are highly flammable and poisonous. They burn violently and can cause serious personal injury.

Never allow sparks, flame or smoking materials near gasoline or diesel fuel!

Turn off the engine before refueling.

Whenever you are around gasoline or diesel fuel, avoid inhaling fumes and skin or clothing contact, extinguish all smoking materials.

Direct skin contact with gasoline or diesel fuels and the inhalation of gasoline or diesel fuel vapors are damaging to your health.

#### Warning!



Do not fill diesel tanks with gasoline. Do not mix diesel fuel with gasoline. Otherwise the fuel system and engine could be damaged. In addition, the vehicle could catch fire.

**!** *Damage resulting from mixing gasoline with diesel is not covered by the Mercedes-Benz Limited Warranty.*

**!** *Diesel engine: When filling the diesel fuel tank using fuel containers, place a filling filter, a suede cloth or a clean flannel cloth as a filter. Otherwise, particles from the fuel container could clog the fuel lines and/or the diesel injection system.*

The fuel filler flap is located on the right-hand side of the vehicle towards the rear. Locking/unlocking the vehicle with the SmartKey or the SmartKey with KEYLESS-GO\* automatically locks/unlocks the fuel filler flap.

**i** *In case the central locking system does not release the fuel filler flap, see “Fuel filler flap” (▷ page 497).*



- ① Fuel filler flap
- ② Fuel filler cap

- ▶ Turn off the engine.
- ▶ Vehicles with SmartKey: Remove the SmartKey from the starter switch.
- ▶ Vehicles with KEYLESS-GO\*: Open the driver's door (this puts the starter switch in position **0**, same as with the SmartKey removed from the starter switch). The driver's door then can be closed again.

- ▶ Briefly push on fuel filler flap ① at the position indicated by the arrow.

Fuel filler flap ① opens slightly.

- ▶ Open fuel filler flap ① completely.
- ▶ Turn fuel filler cap ② counterclockwise and hold on to it until possible pressure is released.
- ▶ Take off fuel filler cap ②.

**!** *The fuel filler cap is tethered to the fuel filler neck. Do not drop the cap. It could damage the vehicle paint finish.*

- ▶ Set fuel filler cap ② on fuel filler flap ① as shown.
- ▶ To prevent fuel vapors from escaping into open air, fully insert filler nozzle unit.
- ▶ Only fill your tank until the filler nozzle unit cuts out – **do not top off or overfill.**

**Warning!**





Overfilling of the fuel tank may create pressure in the system which could cause a gas discharge. This could cause the gas to spray back out when removing the fuel pump nozzle, which could cause personal injury.

- ▶ Replace fuel filler cap ② by turning it clockwise until it audibly engages.

**i** *Make sure to close the fuel filler flap before locking your vehicle as the flap locking pin prevents closing after you have locked the vehicle.*

- ▶ Close fuel filler flap ①.  
You should hear the latch close shut.

**i** *Leaving the engine running and the fuel cap open can cause the yellow fuel tank reserve warning lamp to flash and the  malfunction indicator lamp (USA only) or the  malfunction indicator lamp (Canada only) comes on.*

*For more information, see “Practical hints” (▷ page 439).*

**i** *Gasoline engine:  
Only use premium unleaded gasoline with a minimum Posted Octane Rating of 91 (average of 96 RON/86 MON). Information on gasoline quality can normally be found on the fuel pump. Please contact gas station personnel in case labels on the pump cannot be found.*

*For more information on gasoline, see “Premium unleaded gasoline (gasoline engine)” (▷ page 565), see “Fuel requirements” (▷ page 565), and the Factory Approved Service Products pamphlet (USA only) or contact an authorized Mercedes-Benz Light Truck Center.*

**i** *Diesel engine:  
Only use commercially available vehicular ULTRA-LOW SULFUR HIGHWAY DIESEL FUEL (15 ppm SULFUR MAXIMUM). Information on diesel quality can normally be found on the fuel pump. Please contact gas station personnel in case labels on the pump cannot be found.*

*For more information on diesel fuels, refer to the Factory Approved Service Products pamphlet (USA only) or contact an authorized Mercedes-Benz Light Truck Center.*



### At the gas station

▷▷ **i** *Diesel engine:*  
*If you have driven the vehicle until the tank is empty, the fuel system needs to be bled (▷ page 527).*

**!** *Diesel engine:*  
*The engine is more susceptible to wear and damage if you use*

- marine diesel fuel
- heating oil
- additives

*The exhaust aftertreatment device will be seriously damaged if you use*

- **LOW SULFUR HIGHWAY DIESEL FUEL**  
(500 ppm SULFUR MAXIMUM)
- any other diesel fuel with a sulfur content of above 15 ppm

*The use of such non-approved fuels and/or special additives is not covered by the Mercedes-Benz Limited Warranty.*

### Low outside temperatures (diesel engine)

To prevent malfunctions, diesel fuel with improved cold flow characteristics is offered in the winter months. Check with your fuel retailer.

**!** *Do not fill the tank with gasoline. Do not blend diesel fuel with gasoline or kerosine. The fuel system and engine will otherwise be damaged, which is not covered by the Mercedes-Benz Limited Warranty.*

### Check regularly and before a long trip

► Open the hood (▷ page 378).

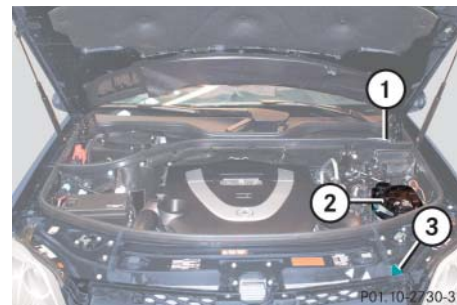

**Example illustration GL 450 (GL 320 CDI, GL 550 similar)**

- ① Brake fluid
- ② Coolant level
- ③ Windshield washer system and headlamp cleaning system\*

### Engine oil level

For more information on engine oil, see “Engine oil” (▷ page 380).

## Brake fluid

**!** *If you find that the brake fluid in the brake fluid reservoir has fallen to the minimum mark or below, have the brake system checked for brake pad thickness and leaks immediately. Notify an authorized Mercedes-Benz Light Truck Center immediately. Do not add brake fluid as this will not solve the problem. For more information, see “Brake fluid” (▷ page 564).*

## Coolant

For normal replenishing, use water (potable water quality).

For more information, see “Coolant level” (▷ page 381) and see “Fuels, coolants, lubricants” (▷ page 562).

## Windshield/rear window washer system and headlamp cleaning system\*

For more information on refilling the washer reservoir, see “Windshield/rear window washer system and headlamp cleaning system\*” (▷ page 383).

## Vehicle lighting

Check function and cleanliness. For information on replacing light bulbs, see “Replacing bulbs” (▷ page 504).

For more information, see “Exterior lamp switch” (▷ page 143).

## Tire inflation pressure

For more information, see “Checking tire inflation pressure” (▷ page 395).

## Engine compartment

### Hood

#### Warning!



Do not pull the release lever while the vehicle is in motion. Otherwise the hood could be forced open by passing air flow.

This could cause the hood to come loose and injure you and/or others.

#### Warning!



You could be injured when the hood is open – even when the engine is turned off.

Parts of the engine can become very hot. To prevent burns, let the engine cool off completely before touching any components on the vehicle. Comply with all relevant safety precautions.

#### Warning!



Vehicles with gasoline engine:

The engine is equipped with a transistorized ignition system. Because of the high voltage it is dangerous to touch any components (ignition coils, spark plug sockets, diagnostic socket) of the ignition system

- with the engine running
- while starting the engine
- if ignition is “on” and the engine is turned manually

### Opening

#### Warning!



If you see flames or smoke coming from the engine compartment, or if the coolant temperature display indicates that the engine is overheated, do not open the hood. Move away from vehicle and do not open the hood until the engine has cooled. If necessary, call the fire department.

#### Warning!



To help prevent personal injury, stay clear of moving parts when the hood is open and the engine is running.

The radiator fan may continue to run for approximately 30 seconds or may even restart after the engine has been turned off. Stay clear of fan blades.

#### Warning!



Vehicles with diesel engine:

The engine is equipped with a high-voltage electronic control unit for the injection system. Because of the high voltage it is dangerous to touch any components of the injection system (injectors, electrical wires)

Closing

**Warning!**



When closing the hood, use extreme caution not to catch hands or fingers. Be careful that you do not close the hood on anyone.

Make sure that the hood is securely engaged before driving off. Do not continue driving if the hood can no longer engage after an accident, for example. The hood could otherwise come loose while the vehicle is in motion and endanger you and others.

- ▶ Let the hood drop from a height of approximately 1 ft (30 cm).  
The hood will lock audibly.
- ▶ Check to make sure the hood is fully closed.

If you can raise the hood at a point above the headlamps, then it is not properly closed. Open it again and let it drop with somewhat greater force.

- with the engine running
- while starting the engine
- when the ignition is switched on

The hood lock release lever is located in the driver's footwell.

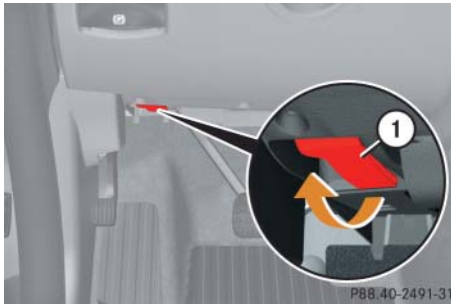

① Release lever

- ▶ Pull release lever ① downwards.

The hood is unlocked. Handle ② protrudes slightly from the radiator grille. If not, lift the hood slightly.

**!** To avoid damage to the windshield wipers or hood, never open the hood if the wiper arms are folded forward away from the windshield.



② Handle for opening the hood

- ▶ Press and hold handle ②.  
The hood is unlocked.
- ▶ Pull up on the hood in direction of arrow and then release it.

The hood will be automatically held open at shoulder height by gas-filled struts.



## Engine compartment

### Engine oil

The amount of oil your engine needs will depend on a number of factors, including driving style. Increased oil consumption can occur when

- the vehicle is new
- the vehicle is driven frequently at higher engine speeds

Engine oil consumption checks should only be made after the vehicle break-in period.

**!** Do not use any special lubricant additives, as these may damage the drive assemblies. Using special additives not approved by Mercedes-Benz may cause damage not covered by the Mercedes-Benz Limited Warranty.

More information on this subject is available at any Mercedes-Benz Light Truck Center.

### Checking engine oil level

When checking the oil level

- the vehicle must be parked on level ground
- the vehicle must have been stationary for at least 5 minutes with the engine turned off



**Example illustration GL 450 (GL 320 CDI, GL 550 similar)**

- ① Oil dipstick
- ② Upper mark
- ③ Lower mark

- ▶ Open the hood (▷ page 378).
- ▶ Pull out oil dipstick ①.
- ▶ Wipe oil dipstick ① clean.
- ▶ Fully insert oil dipstick ① into the dipstick guide tube.
- ▶ Pull out oil dipstick ① again after approximately 3 seconds to obtain accurate reading.

The oil level is correct when it is between lower mark ③ (min.) and upper mark ② (max.) of the oil dipstick.

**i** The filling quantity between the upper and lower marks on the oil dipstick is approximately 2.1 US qt. (2.0 l).

- ▶ If necessary, add engine oil (▷ page 381).

For more information on engine oil, see “Technical data” section (▷ page 562) and (▷ page 564).

## Adding engine oil

**!** Only use approved engine oils and oil filters required for vehicles with Maintenance System. For a listing of approved engine oils and oil filters, refer to the Factory Approved Service Products pamphlet (USA only) in your vehicle literature portfolio, or contact an authorized Mercedes-Benz Light Truck Center.

Using engine oils and oil filters of specification other than those expressly required for the Maintenance System, or changing of oil and oil filter at change intervals longer than those called for by the Maintenance System will result in engine or emission control system damage not covered by the Mercedes-Benz Limited Warranty.



**Example illustration GL 450 (GL 320 CDI, GL 550 similar)**

- ① Filler cap
- ▶ Unscrew filler cap ① from filler neck.
- ▶ Add engine oil as required. Never over-fill with oil.

Be careful not to spill any oil when adding. Avoid environmental damage caused by oil entering the ground or water.

**!** Excess oil must be siphoned or drained off. It could cause damage to the engine and/or catalytic converter (gasoline engine) or the oxidation catalyst (diesel engine) not covered by the Mercedes-Benz Limited Warranty.

- ▶ Screw filler cap ① back on filler neck.

For more information on engine oil, see “Technical data” section (▷ page 562) and (▷ page 564).

## Transmission fluid level

The transmission fluid level does not need to be checked. If you notice transmission fluid loss or gear shifting malfunctions, have an authorized Mercedes-Benz Light Truck Center check the automatic transmission.

## Coolant level

The engine coolant is a mixture of water and anticorrosion/antifreeze.

When checking the coolant level

- the vehicle must be parked on level ground
- the coolant temperature must be below 158°F (70°C)

## Engine compartment

### Warning!



In order to avoid potentially serious burns:

- Use extreme caution when opening the hood if there are any signs of steam or coolant leaking from the cooling system, or if the coolant temperature display indicates that the coolant is overheated.
- Do not remove pressure cap on coolant reservoir if coolant temperature is above 158°F (70°C). Allow engine to cool down before removing cap. The coolant reservoir contains hot fluid and is under pressure.
- Using a rag, slowly open the cap approximately 1/2 turn to relieve excess pressure. If opened immediately, scalding hot fluid and steam will be blown out under pressure.
- Do not spill antifreeze on hot engine parts. Antifreeze contains ethylene glycol which may burn if it comes into contact with hot engine parts.

The coolant expansion tank is located on the driver's side of the engine compartment.

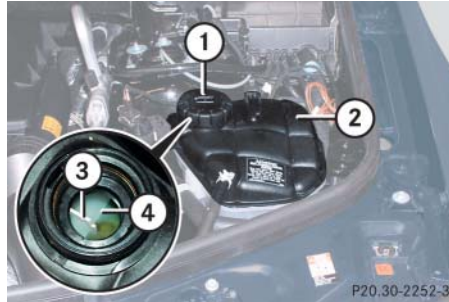

- ① Cap
- ② Coolant expansion tank
- ③ Indicator wall
- ④ Coolant level

- ▶ Using a rag, turn cap ① slowly approximately one half turn counterclockwise to release any excess pressure.
- ▶ Continue turning cap ① counterclockwise and remove it.

Coolant level ④ is correct if the level:

- for cold coolant: reaches the top of indicator wall ③ visible through the filling opening
  - for warm coolant: is approximately 0.6 in (1.5 cm) higher
- ▶ Add coolant as required.
  - ▶ Replace and tighten cap ①.

For more information on coolant, see “Coolants” (▷ page 567).

## Windshield/rear window washer system and headlamp cleaning system\*

The windshield washer reservoir is located in the engine compartment.



### ① Cap for windshield washer reservoir

Fluid for the windshield/rear window washer system and the headlamp cleaning system\* is supplied from the windshield washer reservoir. It has a capacity of 8.1 US qt (7.7 l).

During all seasons, add MB Windshield Washer Concentrate “MB SummerFit” to water. Premix the windshield washer fluid in a suitable container.

### Warning!



Washer solvent/antifreeze is highly flammable. Do not spill washer solvent/antifreeze on hot engine parts, because it may ignite and burn. You could be seriously burned.

- ▶ Use the tab to pull cap ① upwards.
- ▶ Refill the reservoir with MB Windshield Washer Concentrate “MB SummerFit” and water (or commercially available premixed windshield washer solvent/antifreeze, depending on ambient temperatures).

**!** *Always use washer solvent/antifreeze where temperatures may fall below freezing point. Failure to do so could result in damage to the washer system/reservoir.*

**!** *Only use washer fluid which is suitable for plastic lenses. Improper washer fluid can damage the plastic lenses of the headlamps.*

For more information, see “Windshield washer system and headlamp cleaning system\*” (▷ page 569).

### Tires and wheels

Contact an authorized Mercedes-Benz Light Truck Center for information on tested and recommended rims and tires for summer and winter operation. They can also offer advice concerning tire service and purchase.

#### Warning!



Replace rims or tires with the same designation, manufacturer and type as shown on the original part. Contact an authorized Mercedes-Benz Light Truck Center for further information. If incorrectly sized rims and tires are mounted:

- The wheel brakes or suspension components can be damaged.
- The operating clearance of the wheels and the tires may no longer be correct.

#### Warning!



Worn, old tires can cause accidents. If the tire tread is badly worn, or if the tires have sustained damage, replace them.

When replacing rims, only use genuine Mercedes-Benz wheel bolts specified for the particular rim type. Failure to do so can result in the bolts loosening and possibly an accident.

Retreaded tires are not tested or recommended by Mercedes-Benz, since previous damage cannot always be recognized on re-treads. The operating safety of the vehicle cannot be assured when such tires are used.

#### Important guidelines

- Only use sets of tires and rims of the same type and make.
- Tires must be of the correct size for the rim.
- Break in new tires for approximately 60 miles (100 km) at moderate speeds.
- Regularly check the tires and rims for damage. Dented or bent rims can cause tire inflation pressure loss or damage to the tire beads.
- If vehicle is heavily loaded, check tire inflation pressure and correct as required.
- Do not allow your tires to wear down too far. Adhesion properties on wet roads are sharply reduced at tread depths of less than  $\frac{1}{8}$  in (3 mm).
- When replacing individual tires, you should mount new tires on the front wheels first (on vehicles with same-sized wheels all around).

## Tire care and maintenance

### Warning!



Regularly check the tires for damage. Damaged tires can cause tire inflation pressure loss. As a result, you could lose control of your vehicle.

Worn, old tires can cause accidents. If the tire tread is badly worn, or if the tires have sustained damage, replace them.

Regularly check your tire inflation pressure at least once a month. For more information on checking tire inflation pressure, see “Recommended tire inflation pressure” (▷ page 393).

## Tire inspection

Every time you check your tire inflation pressure, you should also inspect your tires for the following:

- excessive treadwear (▷ page 386)
- cord or fabric showing through the tire’s rubber
- bumps, bulges, cuts, cracks or splits in the tread or side of the tire

Replace the tire if you find any of the above conditions.

Make sure you also inspect the spare tire periodically for condition and inflation. Spare tires will age and become worn over time even if never used, and thus should be inspected and replaced when necessary.

## Life of tire

The service life of a tire is dependent upon varying factors including but not limited to:

- Driving style
- Tire inflation pressure
- Distance driven

### Warning!



Tires and spare tire should be replaced after 6 years, regardless of the remaining tread.

### Tires and wheels

#### Tread depth

Do not allow your tires to wear down too far. Adhesion properties on wet roads are sharply reduced at tread depths of less than  $\frac{1}{8}$  in (3 mm).

Treadwear indicators (TWI) are required by law. These indicators are located in six places on the tread circumference and become visible at a tread depth of approximately  $\frac{1}{16}$  in (1.6 mm), at which point the tire is considered worn and should be replaced.

Recommended minimum tire tread depth:

- Summer tires  $\frac{1}{8}$  in (3 mm)
- Winter tires  $\frac{1}{6}$  in (4 mm)

#### Warning!



Although the applicable federal motor safety laws consider a tire to be worn when the treadwear indicators (TWI) become visible at approximately  $\frac{1}{16}$  in (1.6 mm), we recommend that you do not allow your tires

to wear down to that level. As tread depth approaches  $\frac{1}{8}$  in (3 mm), the adhesion properties on a wet road are sharply reduced.

Depending upon the weather and/or road surface (conditions), the tire traction varies widely.

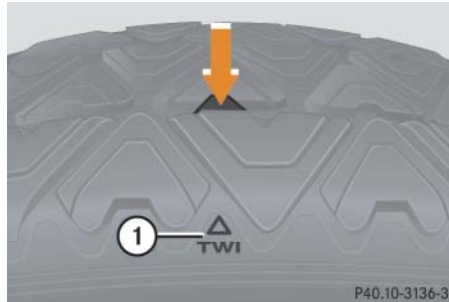

#### ① TWI (Tread Wear Indicator)

The treadwear indicator appears as a solid band across the tread.

#### Storing tires

**!** *Keep unmounted tires in a cool, dry place with as little exposure to light as possible. Protect tires from contact with oil, grease and gasoline.*

#### Cleaning tires

**!** *Never use a round nozzle to power wash tires. The intense jet of water can result in damage to the tire.*

*Always replace a damaged tire.*

### Direction of rotation

Unidirectional tires offer added advantages, such as better hydroplaning performance. To benefit, however, you must make sure the tires rotate in the direction specified.

An arrow on the sidewall indicates the intended direction of rotation (spinning) of the tire.

**i** *Spare wheels may be mounted against the direction of rotation (spinning) even with a unidirectional tire for temporary use only until the regular drive wheel has been repaired or replaced. Always observe and follow applicable temporary use restrictions and speed limitations indicated on the spare wheel.*

### Loading the vehicle

Two labels on your vehicle show how much weight it may properly carry.

- 1) The Tire and Loading Information placard can be found on the driver's door B-pillar. This placard tells you important information about the number of people that can be in the vehicle and the total weight that can be carried in the vehicle. It also contains information on the proper size and recommended tire inflation pressures for the original equipment tires on your vehicle.
- 2) The certification label, also found on the driver's door B-pillar tells you about the gross weight capacity of your vehicle, called the Gross Vehicle Weight Rating (GVWR). The GVWR includes the weight of the vehicle, all occupants, fuel and cargo. The certification label also tells you about the front and rear axle weight capacity, called the Gross Axle Weight Rating (GAWR). The GAWR is the total allowable weight that can be carried by a single axle (front or rear). Never exceed the GVWR or GAWR for either the front axle or rear axle.





### ① Driver's door B-pillar

Following is a discussion on how to work with the information contained on the Tire and Loading Information placard with regards to loading your vehicle.

### Tire and Loading Information

#### Warning!



Do not overload the tires by exceeding the specified load limit as indicated on the Tire and Loading Information placard on the driver's door B-pillar. Overloading the tires can overheat them, possibly causing a blowout. Overloading the tires can also result in handling or steering problems, or brake failure.

#### ***Tire and Loading Information placard***

**i** *Data shown on Tire and Loading Information placard example are for illustration purposes only. Load limit data are specific to each vehicle and may vary from data shown in the illustration below. Refer to Tire and Loading Information placard on vehicle for actual data specific to your vehicle.*

TIRE AND LOADING INFORMATION			
SEATING CAPACITY		TOTAL 5 FRONT 2 REAR 3	
The combined weight of occupants and cargo should never exceed XXX kg or XXX lbs.*			
TIRE	SIZE	COLD TIRE PRESSURE	SEE OWNER'S MANUAL FOR ADDITIONAL INFORMATION
FRONT	P195/70R14	200KPA, 29PSI	
REAR	P195/70R14	200KPA, 29PSI	
SPARE	T125/70D15	420KPA, 60PSI	

P40.00-2062-31

### ① Load limit information on the Tire and Loading Information placard

The Tire and Loading Information placard showing the load limit information is located on the driver's door B-pillar (▷ page 388).

- ▶ Locate the statement “The combined weight of occupants and cargo should never exceed XXX kilograms or XXX lbs.” on the Tire and Loading Information placard.

The combined weight of all occupants, cargo/luggage and trailer tongue load (if applicable) should never exceed the weight referenced in that statement.

### Seating capacity

The seating capacity gives you important information on the number of occupants that can be in the vehicle. Observe front and rear seating capacity. The Tire and Loading Information placard showing the seating capacity is located on the driver's door B-pillar (▷ page 388).

**i** Data shown on Tire and Loading Information placard example are for illustration purposes only. Seating data are specific to each vehicle and may vary from data shown in the illustration below. Refer to Tire and Loading Information placard on vehicle for actual data specific to your vehicle.

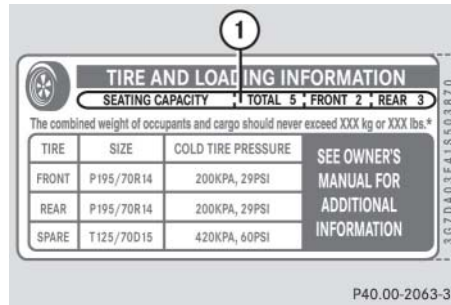

① Seating capacity information on the Tire and Loading Information placard.

### Steps for determining correct load limit

The following steps have been developed as required of all manufacturers under Title 49, Code of U.S. Federal Regulations, Part 575 pursuant to the “National Traffic and Motor Vehicle Safety Act of 1966”.

#### Step 1

▶ Locate the statement “The combined weight of occupants and cargo should never exceed XXX kg or XXX lbs.” on your vehicle’s Tire and Loading Information placard.

#### Step 2

▶ Determine the combined weight of the driver and passengers that will be riding in your vehicle.

#### Step 3

▶ Subtract the combined weight of the driver and passengers from XXX kilograms or XXX lbs.



### Tires and wheels

#### ▷▷ Step 4

- ▶ The resulting figure equals the available amount of cargo and luggage load capacity. For example, if the “XXX” amount equals 1400 lbs and there will be five 150 lbs passengers in your vehicle, the amount of available cargo and luggage load capacity is 650 lbs ( $1400 - 750 (5 \times 150) = 650$  lbs).

#### Step 5

- ▶ Determine the combined weight of luggage and cargo being loaded on the vehicle. That weight may not safely exceed the available cargo and luggage load capacity calculated in step 4.

#### Step 6 (if applicable)

- ▶ If your vehicle will be towing a trailer, load from your trailer will be transferred to your vehicle. Consult this manual to determine how this reduces the available cargo and luggage load capacity of your vehicle (▷ page 392).

The following table shows examples on how to calculate total and cargo load capacities with varying seating configurations and number and size of occupants. The following examples use a load limit of 1500 lbs. **This is for illustration purposes only.** Make sure you are using the actual load limit for your vehicle stated on the vehicle’s Tire and Loading Information placard (▷ page 388).

Example	Combined weight limit of occupants and cargo from placard	Number of occupants (driver and passengers)	Seating configuration	Occupants weight	Combined weight of all occupants	Available cargo/luggage and trailer tongue weight (total load limit from placard minus combined weight of all occupants)
1	1500 lbs	5	front: 2 rear: 3	Occupant 1: 150 lbs Occupant 2: 180 lbs Occupant 3: 160 lbs Occupant 4: 140 lbs Occupant 5: 120 lbs	750 lbs	1500 lbs - 750 lbs = 750 lbs
2	1500 lbs	3	front: 1 rear: 2	Occupant 1: 200 lbs Occupant 2: 190 lbs Occupant 3: 150 lbs	540 lbs	1500 lbs - 540 lbs = 960 lbs
3	1500 lbs	1	front:1	Occupant 1: 150 lbs	150 lbs	1500 lbs - 150 lbs = 1350 lbs

The higher the weight of all occupants, the less cargo and luggage load capacity is available.

For more information, see “Trailer tongue load” (> page 392).

### Tires and wheels

#### ***Certification label***

Even after careful determination of the combined weight of all occupants, cargo and the trailer tongue load (if applicable) (▷ page 392) as to not exceed the permissible load limit, you must make sure that your vehicle never exceeds the Gross Vehicle Weight Rating (GVWR) and the Gross Axle Weight Rating (GAWR) for either the front or rear axle. You can obtain the GVWR and GAWR from the certification label. The certification label can be found on the driver's door B-pillar, see "Technical data" (▷ page 547).

**Gross Vehicle Weight Rating (GVWR):** The total weight of the vehicle, all occupants, all cargo, and the trailer tongue load (▷ page 392) must never exceed the GVWR.

**Gross Axle Weight Rating (GAWR):** The total allowable weight that can be carried by a single axle (front or rear).

To assure that your vehicle does not exceed the maximum permissible weight limits (GVWR and GAWR for front and rear axle), have the loaded vehicle (including driver, passengers and all cargo and, if applicable, trailer fully loaded) weighed on a suitable commercial scale.

#### ***Trailer tongue load***

The tongue load of any trailer is an important weight to measure because it affects the load you can carry in your vehicle. If a trailer is towed, the tongue load must be added to the weight of all occupants riding and any cargo you are carrying in the vehicle. The tongue load typically is between 8% and 15% of the trailer weight and everything loaded in it.

For more information on trailer tongue load, see "Loading a trailer" (▷ page 365).

## Recommended tire inflation pressure

### Warning!



Follow recommended tire inflation pressures.

Do not underinflate tires. Underinflated tires wear excessively and/or unevenly, adversely affect handling and fuel economy, and are more likely to fail from being overheated.

Do not overinflate tires. Overinflated tires can adversely affect handling and ride comfort, wear unevenly, increase stopping distance, and result in sudden deflation (blowout) because they are more likely to become punctured or damaged by road debris, potholes etc.

Do not overload the tires by exceeding the specified load limit as indicated on the Tire and Loading Information placard on the driver's door B-pillar. Overloading the tires can overheat them, possibly causing a blowout. Overloading the tires can also result in handling or steering problems, or brake failure.

Your vehicle is equipped with the Tire and Loading Information placard located on the driver's door B-pillar (▷ page 388).

The tire inflation pressure should be checked regularly and should only be adjusted on cold tires. The tires can be considered cold if the vehicle has been parked for at least 3 hours or driven less than 1 mile (1.6 km).

Follow recommended cold tire inflation pressures listed on Tire and Loading Information placard on the driver's door B-pillar.

Keeping the tires properly inflated provides the best handling, tread life and riding comfort.

In addition to the Tire and Loading Information placard on the driver's door B-pillar, also consult the tire inflation pressure label (if available) on the fuel filler flap (▷ page 374) for any additional information pertaining to special driving situations. For more information, see "Important notes on tire inflation pressure" (▷ page 394).

## Tires and wheels

**i** Data shown on Tire and Loading Information placard example are for illustration purposes only. Tire data are specific to each vehicle and may vary from data shown in the illustration below. Refer to Tire and Loading Information placard on vehicle for actual data specific to your vehicle.

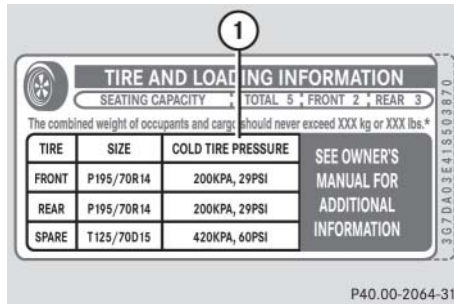

① Tire and Loading Information placard with recommended cold tire inflation pressures

The Tire and Loading Information placard lists the recommended cold tire inflation pressures for maximum loaded vehicle weight. The tire inflation pressures listed apply to the tires installed as original equipment.

### Important notes on tire inflation pressure

#### Warning!



If the tire inflation pressure drops repeatedly:

- Check the tires for punctures from foreign objects.
- Check to see whether air is leaking from the valves or from around the rim.

Tire temperature and tire inflation pressure are also increased while driving, depending on the driving speed and the tire load.

If you will be driving your vehicle at high speeds of 100 mph (160 km/h) or higher, where it is legal and conditions allow, consult the tire inflation pressure label on the inside of the fuel filler flap (if available) on how to adjust the cold tire inflation pressure. If you do not adjust the tire inflation pressure, excessive heat can build up and result in sudden tire failure.

If your vehicle is not equipped with the tire inflation pressure label on the inside of the fuel filler flap, contact an authorized Mercedes-Benz Light Truck Center for proper tire inflation pressure.

**i** Driving comfort may be reduced when the tire inflation pressure is adjusted to the value for speeds above 100 mph (160 km/h) as specified on the tire inflation pressure label located on the inside of the fuel filler flap.

Be sure to readjust the tire inflation pressure for normal driving speeds. You should wait until the tires are cold before adjusting the tire inflation pressure.

Some vehicles may have supplemental tire inflation pressure information for vehicle loads less than the maximum loaded vehicle condition. If such information is provided, it can be found on the tire inflation pressure label located on the inside of the fuel filler flap (> page 374).

Tire inflation pressure changes by approximately 1.5 psi (0.1 bar) per 18°F (10°C) of air temperature change. Keep this in mind when checking tire inflation pressure where the temperature is different from the outside temperature.

### Checking tire inflation pressure

Regularly check your tire inflation pressure at least once a month.

Check and adjust the tire inflation pressure when the tires are cold. The tires can be considered cold if the vehicle has been parked for at least 3 hours or driven less than 1 mile (1.6 km).

If you check the tire inflation pressure when the tires are warm (the vehicle has been driven for several miles or sitting less than 3 hours), the reading will be approximately 4 psi (0.3 bar) higher than the cold reading. This is normal. Do not let air out to match the specified cold tire inflation pressure. Otherwise, the tire will be underinflated.

### Warning!



Follow recommended tire inflation pressures.

Do not underinflate tires. Underinflated tires wear excessively and/or unevenly, adversely affect handling and fuel economy, and are more likely to fail from being overheated.

Do not overinflate tires. Overinflated tires can adversely affect handling and ride comfort, wear unevenly, increase stopping distance, and result in sudden deflation (blowout) because they are more likely to become punctured or damaged by road debris, potholes etc.

Do not overload the tires by exceeding the specified load limit as indicated on the Tire and Loading Information placard on the driver's door B-pillar. Overloading the tires can overheat them, possibly causing a blowout. Overloading the tires can also result in handling or steering problems, or brake failure.

### Checking tire inflation pressure manually

Follow the steps below to achieve correct tire inflation pressure:

- ▶ Remove the cap from the valve on one tire.
- ▶ Firmly press a tire gauge onto the valve.
- ▶ Read tire inflation pressure on tire gauge and check against the recommended tire inflation pressure on the Tire and Loading Information placard on the driver's door B-pillar (▷ page 388) or, if available, the inside of the fuel filler flap. If necessary, add air to achieve the recommended tire inflation pressure. ▷▷



### Tires and wheels

▷▷ **i** *If you have overfilled the tire, release tire inflation pressure by pushing the metal stem of the valve with e.g. a tip of a pen. Then recheck the tire inflation pressure with the tire gauge.*

- ▶ Install the valve cap.
- ▶ Repeat this procedure for each tire.

#### Run Flat Indicator (Canada only)

While the vehicle is being driven, the Run Flat Indicator monitors the set tire inflation pressures by evaluating each wheel's rotational speed. This allows the system to detect a significant loss of pressure in a tire. If a wheel's rotational speed changes due to falling tire inflation pressure, you will see a corresponding warning message in the multifunction display.

The Run Flat Indicator may function in a restricted manner or with a delay

- if snow chains are mounted to the vehicle
- in presence of ice and snow
- if you are driving on a loose surface (e.g. sand or gravel)
- if you are driving in a very sporty manner (involving rapid acceleration or high speeds in curves)

#### Warning!



When the multifunction display shows the message **Tire Pressure Check Tires**, one or more of your tires is significantly underinflated. You should stop and check your tires as soon as possible, and inflate them to the proper tire inflation pressure as indicated on the vehicle's Tire and Loading Information placard or, if available, on the tire inflation pressure label. Driving on a significantly under-inflated tire causes the tire to overheat and can lead to tire failure. Underinflation also reduces fuel efficiency and tire tread life, and may affect the vehicle's handling and stopping ability. Each tire, including the spare, should be checked monthly when cold and set to the recommended tire inflation pressure as specified on the Tire and Loading Information placard on the driver's door B-pillar (▷ page 388) or, if available, on the tire inflation pressure label located on the inside of the fuel filler flap (▷ page 374).

**Warning!**

The Run Flat Indicator does not provide a warning for wrongly selected tire inflation pressures. Always adjust tire inflation pressure according to the Tire and Loading Information placard on the driver's door B-pillar (▷ page 388) or, if available, on the tire inflation pressure label located on the inside of the fuel filler flap (▷ page 374).

The Run Flat Indicator does not replace regular checks of the tire inflation pressures since a gradual pressure loss in more than one tire cannot be detected by the Run Flat Indicator.

The Run Flat Indicator is not able to issue a warning due to a sudden dramatic loss of tire inflation pressure (e.g. tire blowout caused by a foreign object). In this case bring the vehicle to a halt by carefully applying the brakes and avoiding abrupt steering maneuvers.

**Restarting the Run Flat Indicator**

The Run flat indicator must be restarted in the following situations:

- If you have changed the tire inflation pressure
- If you have replaced the wheels or tires
- If you have installed new wheels or tires
- ▶ Using the Tire and Loading Information placard on the driver's door B-pillar or, if available, the tire inflation pressure label on the inside of the fuel filler flap, make sure the tire inflation pressure of all four tires is correct.



**Warning!**

The Run Flat Indicator can only warn you in a reliable manner if you have set the correct tire inflation pressures for each tire.

If an incorrect tire inflation pressure was set, the system will monitor the pressure according to the incorrect value.

- ▶ Switch on the ignition (▷ page 42).

Make sure the standard display menu appears in the multifunction display (▷ page 155).

- ▶ Press button  or  repeatedly until the following message appears in the multifunction display:



- ▶ Press the reset button on the instrument cluster (▷ page 152).

The following message will appear in the multifunction display:

```
Restart
Run Flat Indicator?
Yes
Cancel
```

### Tires and wheels

If you wish to confirm activation:

- ▶ Press button **+**.

The following message will appear in the multifunction display:

Run Flat Indicator  
Restarted

After a certain “learning phase”, the Run Flat Indicator checks the set pressure values for all four tires.

If you wish to cancel activation:

- ▶ Press button **-**.

or

- ▶ Wait until the message  
Restart  
Run Flat Indicator?  
Yes  
Cancel  
disappears.

### Checking tire pressure electronically with the Tire Pressure Monitoring System (TPMS), (USA only)

**i** The Tire Pressure Monitoring System (TPMS) is equipped with a combination low tire pressure/TPMS malfunction telltale in the instrument cluster (▷ page 27). Depending on how the telltale illuminates, it indicates a low tire pressure condition or a malfunction in the TPMS system itself:

- If the telltale illuminates continuously, one or more of your tires is significantly underinflated. There is no malfunction in the TPMS.
- If the telltale flashes for 60 seconds and then stays illuminated, the TPMS system itself is not operating properly.

**i** This device complies with Part 15 of the FCC Rules. Operation is subject to the following two conditions:

- (1) This device may not cause harmful interference, and
- (2) this device must accept any interference received, including interference that may cause undesired operation.

Any unauthorized modification to this device could void the user's authority to operate the equipment.

The TPMS only functions on wheels that are equipped with the proper electronic sensors. It monitors the tire inflation pressure, as selected by the driver, in all four tires. A warning is issued to alert you to a decrease in pressure in one or more of the tires.

**Warning!**

The TPMS does not indicate a warning for wrongly selected inflation pressures. Always adjust tire inflation pressure according to the Tire and Loading Information placard on the driver's door B-pillar or, if available, the supplemental tire inflation pressure information on the inside of the fuel filler flap.

The TPMS is not able to issue a warning due to a sudden dramatic loss of pressure (e.g. tire blowout caused by a foreign object). In this case bring the vehicle to a halt by carefully applying the brakes and avoiding abrupt steering maneuvers.

**Warning!**

Each tire, including the spare (if provided), should be checked monthly when cold and inflated to the inflation pressure recommended by the vehicle manufacturer on the Tire and Loading Information placard on the driver's door B-Pillar or, if available, the tire inflation pressure label on the fuel filler flap. If your vehicle has tires of a different size than the size indicated on the Tire and Loading Information placard or, if available, the tire inflation pressure label, you should determine the proper tire inflation pressure for those tires.

As an added safety feature, your vehicle has been equipped with a tire pressure monitoring system (TPMS) that illuminates a low tire pressure telltale when one or more of your tires is significantly underinflated. Accordingly, when the low tire pressure telltale illuminates, you should stop and check your tires as soon as possible, and inflate them to the proper pressure. Driving on a significantly underinflated tire causes the tire to

overheat and can lead to tire failure.

Underinflation also reduces fuel efficiency and tire tread life, and may affect the vehicle's handling and stopping ability. Please note that the TPMS is not a substitute for proper tire maintenance, and it is the driver's responsibility to maintain correct tire pressure, even if underinflation has not reached the level to trigger illumination of the TPMS low tire pressure telltale.

Your vehicle has also been equipped with a TPMS malfunction indicator to indicate when the system is not operating properly. The TPMS malfunction indicator is combined with the low tire pressure telltale. When the system detects a malfunction, the telltale will flash for approximately 1 minute and then remain continuously illuminated. This sequence will continue upon subsequent vehicle start-ups as long as the malfunction exists. When the malfunction indicator is illuminated, the system may not be able to detect or signal low tire pressure as intended.



### Tires and wheels

- ▷▷ TPMS malfunctions may occur for a variety of reasons, including the installation of incompatible replacement or alternate tires or wheels on the vehicle that prevent the TPMS from functioning properly. Always check the TPMS malfunction telltale after replacing one or more tires or wheels on your vehicle to ensure that the replacement or alternate tires and wheels allow the TPMS to continue to function properly.

**i** If a condition causing the TPMS to malfunction develops, it may take up to 10 minutes for the system to signal a malfunction using the TPMS telltale flashing and illumination sequence.

The telltale extinguishes after a few minutes driving if the malfunction has been corrected.

**i** Operating radio transmission equipment (e.g. wireless headsets, two-way radios) in or near the vehicle could cause the TPMS to malfunction.

#### Tire inflation pressure warnings

If the system detects a significant loss of tire inflation pressure in one or more than one tire, a message appears in the multi-function display.



#### Example illustration

In addition, a warning signal sounds.

#### Restarting the TPMS

##### Warning!







It is the driver's responsibility to calibrate the TPMS on the recommended cold inflation pressure. Underinflated tires affect the ability to steer or brake the vehicle. You might lose control over the vehicle.

The TPMS must be restarted when you have adjusted the tire inflation pressure to a new level (e.g. because of different load or driving conditions). The TPMS is then recalibrated to the current tire inflation pressures.

- ▶ Using the Tire and Loading Information placard on the driver's door B-pillar (▷ page 388) or, if available, the supplemental tire inflation pressure information on the inside of the fuel filler flap (▷ page 374), make sure the tire inflation pressure of all four tires is correct.

**i** Restart the TPMS after adjusting the tire inflation pressure to the inflation pressure recommended for the vehicle operating condition. Tire pressure should only be adjusted on cold tires. Observe the recommended tire inflation pressure on the Tire and Loading Information placard on the driver's door B-pillar (▷ page 388). Some vehicles may have supplemental tire inflation pressure information for driving at high speeds (▷ page 394) or for vehicle loads less than the maximum loaded vehicle condition (▷ page 394). If such information is provided, it can be found on the inside of the fuel filler flap.

- ▶ Switch on the ignition (▷ page 42).
- ▶ Press button  or  on the multifunction steering wheel repeatedly until the standard display menu appears in the multifunction display (▷ page 155).
- ▶ Press button  or  repeatedly until you see the following message:  
Tire Pressure Monitor  
Active  
Menu: R-Button

- ▶ Press the reset button (▷ page 152).

The following message will appear in the multifunction display:  
Restart tire  
pressure monitor?

- ▶ Press button .

The following message will appear in the multifunction display:  
Tire Pressure Monitor  
Restarted

After driving a few minutes the system verifies that the current tire inflation pressures are within the system's specified range. Afterwards the current tire inflation pressures are accepted as reference pressures and then monitored.

If you wish to cancel activation:

- ▶ Press button .

### Checking tire pressure electronically with the Advanced Tire Pressure Monitoring System (Advanced TPMS)\*, (Canada only)

**i** This device complies with RSS-210 of Industry Canada. Operation is subject to the following two conditions:

- (1) This device may not cause interference, and
- (2) this device must accept any interference received, including interference that may cause undesired operation of the device.



*Any unauthorized modification to this device could void the user's authority to operate the equipment.*

The TPMS only functions on wheels that are equipped with the proper electronic sensors. It monitors the tire inflation pressure, as selected by the driver, in all four tires. A warning is issued to alert you to a decrease in pressure in one or more of the tires.

Tire pressure inquiries are made using the multifunction display. The present inflation pressures are displayed only after a few minutes' travel time.

### Tires and wheels

**i** Possible differences between the readings of a tire pressure gauge of an air hose, e.g. gas station equipment, and the vehicle's control system can occur. Usually the readings issued by the control system are more precise.

- ▶ Switch on the ignition (▷ page 42).
- ▶ Press button  or  on the multifunction steering wheel until the current inflation pressures for each tire appear in the multifunction display.

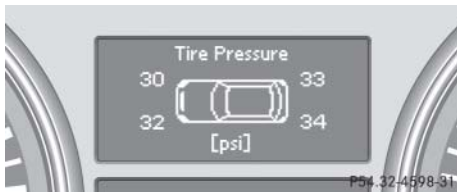

**i** When the vehicle has been parked for longer than 20 minutes, the message **Tire pressure** displayed after driving for a few minutes . appears in the multifunction display.

#### Warning!



It is the driver's responsibility to calibrate the TPMS on the recommended cold inflation pressure. Underinflated tires affect the ability to steer or brake the vehicle. You might lose control over the vehicle.

**i** With a spare wheel without wheel sensor mounted, the system may still indicate the tire inflation pressure of the removed wheel for some minutes. If this happens, keep in mind that the indicated value where the spare wheel is mounted does not reflect the actual spare tire inflation pressure.

#### Warning!



The TPMS does not indicate a warning for wrongly selected inflation pressures. Always adjust tire inflation pressure according to the Tire and Loading Information placard on the driver's door B-pillar or, if available, the supplemental tire inflation pressure information on the inside of the fuel filler flap.

The TPMS is not able to issue a warning due to a sudden dramatic loss of pressure (e.g. tire blowout caused by a foreign object). In this case bring the vehicle to a halt by carefully applying the brakes and avoiding abrupt steering maneuvers.

**Warning!**

Each tire, including the spare (if provided), should be checked monthly when cold and inflated to the inflation pressure recommended by the vehicle manufacturer on the Tire and Loading Information placard on the driver's door B-Pillar or, if available, the tire inflation pressure label on the fuel filler flap. If your vehicle has tires of a different size than the size indicated on the vehicle placard or the tire inflation pressure label, you should determine the proper tire inflation pressure for those tires.

As an added safety feature, your vehicle has been equipped with a tire pressure monitoring system (TPMS) that illuminates a low tire pressure telltale when one or more of your tires are significantly underinflated. Accordingly, when the low tire pressure telltale illuminates, you should stop and check your tires as soon as possible. Driving on a significantly underinflated tire causes the tire to overheat and can lead to tire failure.

Underinflation also reduces fuel efficiency and tire tread life, and may effect the vehicle's handling and stopping ability. Please note that the TPMS is not a substitute for proper tire maintenance, and it is the driver's responsibility to maintain correct tire pressure, even if under-inflation has not reached the level to trigger illumination of the TPMS low tire pressure telltale.

**i** *Operating radio transmission equipment (e.g. wireless headsets, two-way radios) in or near the vehicle could cause the TPMS to malfunction.*

***Tire inflation pressure warnings***

If the system detects a significant loss of tire inflation pressure in one or more than one tire, a message appears in the multi-function display.

**Example illustration**

The respective tire is indicated by a red rectangle. In addition, a warning signal sounds.



## Tires and wheels

### Restarting Advanced TPMS\*

The TPMS usually recognizes new reference values automatically, for example when you have

- adjusted the tire inflation pressure
- changed wheels or tires
- mounted new wheels or tires

### Warning!







It is the driver's responsibility to calibrate the TPMS on the recommended cold inflation pressure. Underinflated tires affect the ability to steer or brake the vehicle. You might lose control over the vehicle.

If you want to set new reference values manually:

- ▶ Using the Tire and Loading Information placard on the driver's door B-pillar (▷ page 388) or, if available, the supplemental tire inflation pressure information on the inside of the fuel filler flap (▷ page 374), make sure the tire inflation pressure of all four tires is correct.

**i** *Reactivate the TPMS after adjusting the tire inflation pressure to the inflation pressure recommended for the vehicle operating condition. Tire pressure should only be adjusted on cold tires. Observe the recommended tire inflation pressure on the Tire and Loading Information placard on the driver's door B-pillar (▷ page 388). Some vehicles may have supplemental tire inflation pressure information for driving at high speeds (▷ page 394) or for vehicle loads less than the maximum loaded vehicle condition (▷ page 394). If such information is provided, it can be found on the inside of the fuel filler flap.*

- ▶ Press button  or  on the multifunction steering wheel repeatedly until the standard display menu appears in the multifunction display (▷ page 155).
- ▶ Press button  or  repeatedly until
  - the current inflation pressures for each tire appear in the multifunction display
  - or
  - the following message appears in the multifunction display  
Tire pressure  
displayed after  
driving for  
a few minutes.
- ▶ Press the reset button (▷ page 152).  
The following message will appear in the multifunction display:  
Restart tire  
pressure monitor?

- ▶ Press button **+**.

The following message will appear in the multifunction display:

Tire Pressure Monitor  
Restarted

After a few minutes driving, the current tire inflation pressure values are accepted as reference values and then monitored.

If you wish to cancel activation:

- ▶ Press button **-**.

### Potential problems associated with underinflated and overinflated tires

#### *Underinflated tires*

Underinflated tires can:

- cause excessive and uneven tire wear
- adversely affect fuel economy
- lead to tire failure from being overheated
- adversely affect handling characteristics

#### **Warning!**



Follow recommended tire inflation pressures.

Do not underinflate tires. Underinflated tires wear excessively and/or unevenly, adversely affect handling and fuel economy, and are more likely to fail from being overheated.

#### *Overinflated tires*

Overinflated tires can:

- adversely affect handling characteristics
- cause uneven tire wear
- be more prone to damage from road hazards
- adversely affect ride comfort
- increase stopping distance

#### **Warning!**



Follow recommended tire inflation pressures.

Do not overinflate tires. Overinflated tires can adversely affect handling and ride comfort, wear unevenly, increase stopping distance, and result in sudden deflation (blowout) because they are more likely to become punctured or damaged by road debris, potholes etc.

## Tires and wheels

### Tire labeling

Besides tire name (sales designation) and manufacturer name, a number of markings can be found on a tire.

Following are some explanations for the markings on your vehicle's tires:

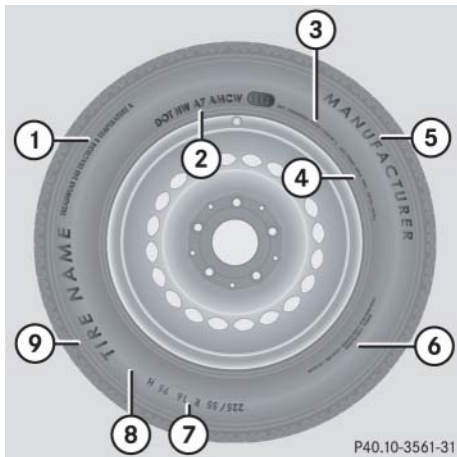

- ① Uniform Quality Grading Standards (▷ page 413)
- ② DOT, Tire Identification Number (TIN) (▷ page 410)
- ③ Maximum tire load (▷ page 412)
- ④ Maximum tire inflation pressure (▷ page 412)
- ⑤ Manufacturer
- ⑥ Tire ply material (▷ page 415)
- ⑦ Tire size designation, load and speed rating (▷ page 406)
- ⑧ Load identification (▷ page 410)
- ⑨ Tire name

**i** For illustration purposes only. Actual data on tires are specific to each vehicle and may vary from data shown in above illustration.

For more information, see “Rims and tires” (▷ page 555).

### Tire size designation, load and speed rating

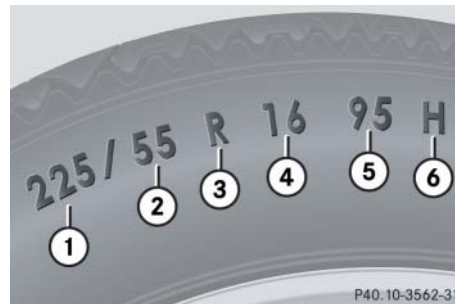

- ① Tire width
- ② Aspect ratio in %
- ③ Radial tire code
- ④ Rim diameter
- ⑤ Tire load rating
- ⑥ Tire speed rating

**i** For illustration purposes only. Actual data on tires are specific to each vehicle and may vary from data shown in above illustration.

**General:**

Depending on the design standards used, the tire size molded into the sidewall may have no letter or a letter preceding the tire size designation.

No letter preceding the size designation (as illustrated above): Passenger car tire based on European design standards.

Letter “P” preceding the size designation: Passenger car tire based on U.S. design standards.

Letter “LT” preceding the size designation: Light Truck tire based on U.S. design standards.

Letter “T” preceding the size designation: Temporary spare tires which are high pressure compact spares designed for temporary emergency use only.

***Tire width***

The tire width ① (▷ page 406) indicates the nominal tire width in mm.

***Aspect ratio***

The aspect ratio ② (▷ page 406) is the dimensional relationship between tire section height and section width and is expressed in percentage. The aspect ratio is arrived at by dividing section height by section width.

***Tire code***

The tire code ③ (▷ page 406) indicates the tire construction type. The “R” stands for radial tire type. Letter “D” means diagonal or bias ply construction; letter “B” means belted-bias ply construction.

At the tire manufacturer’s option, any tire with a speed capability above 149 mph (240 km/h) can include a “ZR” in the size designation (for example: 245/40 ZR 18). For additional information, see “Tire speed rating” (▷ page 408).

***Rim diameter***

The rim diameter ④ (▷ page 406) is the diameter of the bead seat, not the diameter of the rim edge. Rim diameter is indicated in inches (in).

***Tire load rating***

The tire load rating ⑤ (▷ page 406) is a numerical code associated with the maximum load a tire can support.

For example, a load rating of 91 corresponds to a maximum load of 1356 lbs (615 kg) the tire is designed to support. See also “Maximum tire load” (▷ page 412) where the maximum load associated with the load index is indicated in kilograms and lbs.

## Tires and wheels

### Warning!



The tire load rating must always be at least half of the GAWR (▷ page 416) of your vehicle. Otherwise, tire failure may be the result which may cause an accident and/or serious personal injury to you or others.

Always replace rims and tires with the same designation, manufacturer and type as shown on the original part.

For additional information on tire load rating, see “Load identification” (▷ page 410).

**i** Tire load rating ⑤ (▷ page 406) and Tire speed rating ⑥ (▷ page 406) are also referred to as “service description”.

### Tire speed rating

The tire speed rating ⑥ (▷ page 406) indicates the approved maximum speed for the tire.

**i** Tire load rating ⑤ (▷ page 406) and Tire speed rating ⑥ (▷ page 406) are also referred to as “service description”.

### Summer tires

Index	Speed rating
Q	up to 100 mph (160 km/h)
R	up to 106 mph (170 km/h)
S	up to 112 mph (180 km/h)
T	up to 118 mph (190 km/h)
H	up to 130 mph (210 km/h)
V	up to 149 mph (240 km/h)
W	up to 168 mph (270 km/h)
Y	up to 186 mph (300 km/h)
(Y)	above 186 mph (300 km/h)
ZR	above 149 mph (240 km/h)

### Warning!



Do not overload the tires by exceeding the specified load limit as indicated on the Tire and Loading Information placard located on the driver’s door B-pillar. Overloading the tires can overheat them, possibly causing a blowout. Overloading the tires can also result in handling or steering problems, or brake failure.

### Warning!



Even when permitted by law, never operate a vehicle at speeds greater than the maximum speed rating of the tires.

Exceeding the maximum speed for which tires are rated can lead to sudden tire failure, causing loss of vehicle control and possibly resulting in an accident and/or personal injury and possible death, for you and for others.

- At the tire manufacturer’s option, any tire with a speed capability above 149 mph (240 km/h) can include a “ZR” in the size designation (for example: 245/40 ZR18). To determine the maximum speed capability of the tire, the service description for the tire must be referred to. The service description is comprised of the tire load rating ⑤ (▷ page 406) and the tire speed rating ⑥ (▷ page 406).

If your tire includes “ZR” in the size designation and no service description ⑤ and ⑥ (▷ page 406) is given, the tire manufacturer must be consulted for the maximum speed capability.



If a service description ⑤ and ⑥ (▷ page 406) is given, the speed capability is limited by the speed symbol in the service description. Example: 245/40 ZR18 97Y. In this example, “97Y” is the service description. The letter “Y” designates the speed rating and the speed capability of the tire is limited to 186 mph (300 km/h).

- Any tire with a speed capability above 186 mph (300 km/h) must include a “ZR” in the size designation AND the service description must be placed in parenthesis. Example: 275/40 ZR 18 (99Y). The “(Y)” speed rating in parenthesis designates the maximum speed capability of the tire as being above 186 mph (300 km/h). Consult the tire manufacturer for the actual maximum permissible speed of the tire.

All-season and winter tires

Index	Speed rating
Q M+S <sup>1</sup>	up to 100 mph (160 km/h)
T M+S <sup>1</sup>	up to 118 mph (190 km/h)
H M+S <sup>1</sup>	up to 130 mph (210 km/h)
V M+S <sup>1</sup>	up to 149 mph (240 km/h)

<sup>1</sup> or M+S  for winter tires

 *Not all M+S rated tires provide special winter performance. Make sure the tires you use show M+S and the mountain/snowflake  marking on the tire sidewall. These tires meet specific snow traction performance requirements of the Rubber Manufacturers Association (RMA) and the Rubber Association of Canada (RAC) and have been designed specifically for use in snow conditions.*

## Tires and wheels

### Load identification



#### ① Load identification

**i** For illustration purposes only. Actual data on tires are specific to each vehicle and may vary from data shown in above illustration.

In addition to tire load rating, special load identification ① may be molded into the tire sidewall following the letter designating the tire speed rating (▷ page 406).

No specification given: absence of any text (like in above example) indicates a standard load (SL) tire.

XL or Extra Load: designates an extra load (or reinforced) tire.

Light Load: designates a light load tire.

C, D, E: designates load range associated with the maximum load a tire can carry at a specified pressure.

### DOT, Tire Identification Number (TIN)

U.S. tire regulations require each new tire manufacturer or tire retreader to mold a TIN into or onto a sidewall of each tire produced.

The TIN is a unique identifier which facilitates efforts by tire manufactures to notify purchasers in recall situations or other safety matters concerning tires and gives purchasers the means to easily identify such tires.

The TIN is comprised of “Manufacturer’s identification mark”, “Tire size”, “Tire type code” and “Date of manufacture”.

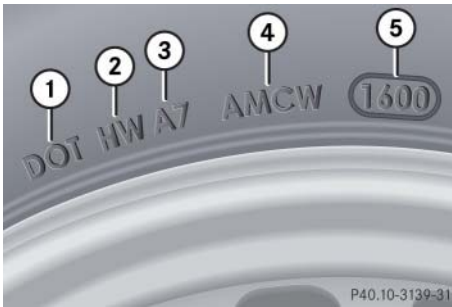

- ① DOT
- ② Manufacturer's identification mark
- ③ Tire size
- ④ Tire type code (at the option of the tire manufacturer)
- ⑤ Date of manufacture

**i** For illustration purposes only. Actual data on tires are specific to each vehicle and may vary from data shown in above illustration.

### DOT (Department of Transportation)

A tire branding symbol ① (▷ page 411) which denotes the tire meets requirements of the U.S. Department of Transportation.

### Manufacturer's identification mark

The manufacturer's identification mark ② (▷ page 411) denotes the tire manufacturer.

New tires have a mark with two symbols.

Retreaded tires have a mark with four symbols. For more information on retreaded tires, see (▷ page 384).

### Tire size

The code ③ (▷ page 411) indicates the tire size.

### Tire type code

The code ④ (▷ page 411) may, at the option of the manufacturer, be used as a descriptive code for identifying significant characteristics of the tire.

### Date of manufacture

The date of manufacture ⑤ (▷ page 411) identifies the week and year of manufacture.

The first two figures identify the week, starting with "01" to represent the first full week of the calendar year. The second two figures represent the year.

For example, "3202" represents the 32nd week of 2002.



## Tires and wheels

### Maximum tire load

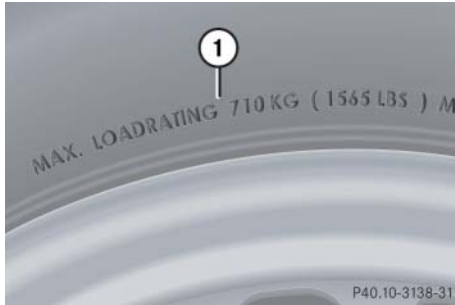

#### ① Maximum tire load rating

**i** For illustration purposes only. Actual data on tires are specific to each vehicle and may vary from data shown in above illustration.

The maximum tire load is the maximum weight the tires are designed to support.

### Warning!



Do not overload the tires by exceeding the specified load limit as indicated on the Tire and Loading Information placard located on the driver's door B-pillar. Overloading the tires can overheat them, possibly causing a blowout. Overloading the tires can also result in handling or steering problems, or brake failure.

For more information on tire load rating (▷ page 407).

For information on calculating total and cargo load capacities (▷ page 389).

### Maximum tire inflation pressure

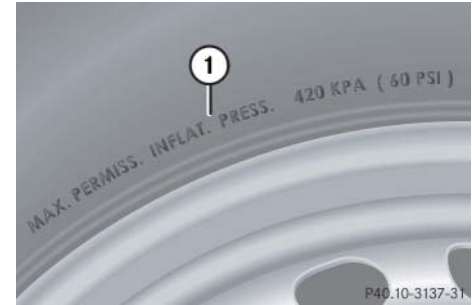

#### ① Maximum permissible tire inflation pressure

**i** For illustration purposes only. Actual data on tires are specific to each vehicle and may vary from data shown in above illustration.

This is the maximum permissible tire inflation pressure for the tire.

Always follow the recommended tire inflation pressure (▷ page 393) for proper tire inflation.

**Warning!**



Never exceed the max. tire inflation pressure. Follow recommended tire inflation pressures.

Do not underinflate tires. Underinflated tires wear excessively and/or unevenly, adversely affect handling and fuel economy, and are more likely to fail from being overheated.

Do not overinflate tires. Overinflated tires can adversely affect handling and ride comfort, wear unevenly, increase stopping distance, and result in sudden deflation (blowout) because they are more likely to become punctured or damaged by road debris, potholes etc.

**Uniform Tire Quality Grading Standards (U.S. vehicles)**

Tire manufacturers are required to grade tires based on three performance factors: treadwear, traction and temperature resistance.

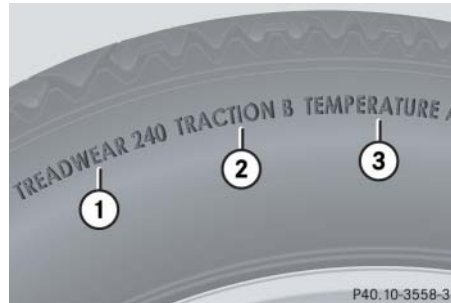

- ① Treadwear
- ② Traction
- ③ Temperature resistance

**i** For illustration purposes only. Actual data on tires are specific to each vehicle and may vary from data shown in above illustration.

Quality grades can be found, where applicable, on the tire sidewall between tread shoulder and maximum section width. For example:

Treadwear	Traction	Temperature
200	AA	A

All passenger car tires must conform to federal safety requirements in addition to these grades.

### Tires and wheels

#### Treadwear

The treadwear grade is a comparative rating based on the wear rate of the tire when tested under controlled conditions on a specified government test course. For example, a tire graded 150 would wear one and one-half ( $1\frac{1}{2}$ ) times as well on the government course as a tire graded 100. The relative performance of tires depends upon the actual conditions of their use, however, and may depart significantly from the norm due to variations in driving habits, service practices and differences in road characteristics and climate.

#### Traction

The traction grades, from highest to lowest, are AA, A, B, and C. Those grades represent the tire's ability to stop on wet pavement as measured under controlled conditions on specified government test surfaces of asphalt and concrete. A tire marked C may have poor traction performance.

#### Warning!



The traction grade assigned to this tire is based on straight-ahead braking traction tests, and does not include acceleration, cornering, hydroplaning, or peak traction characteristics.

#### Temperature

The temperature grades are A (the highest), B, and C, representing the tire's resistance to the generation of heat and its ability to dissipate heat when tested under controlled conditions on a specified indoor laboratory test wheel. Sustained high temperature can cause the material of the tire to degenerate and reduce tire life, and excessive temperature can lead to sudden tire failure. The grade C corresponds to a level of performance which all passenger car tires must meet under the Federal Motor Vehicle Safety Standard No. 109. Grades B and A represent higher levels of performance on the laboratory test wheel than the minimum required by law.

**Warning!**

The temperature grade for this tire is established for a tire that is properly inflated and not overloaded. Excessive speed, underinflation, or excessive loading, either separately or in combination, can cause excessive heat build-up and possible tire failure.

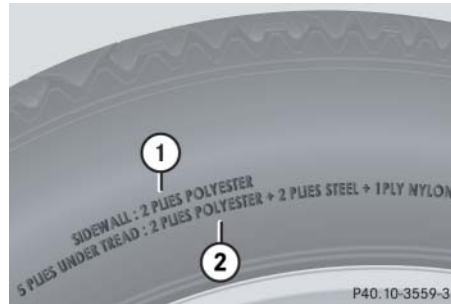
**Tire ply material**

- ① Plies in sidewall
- ② Plies under tread

**i** For illustration purposes only. Actual data on tires are specific to each vehicle and may vary from data shown in above illustration.

This marking tells you about the type of cord and number of plies in the sidewall and under the tread.

**Tire and loading terminology****Accessory weight**

The combined weight (in excess of those standard items which may be replaced) of automatic transmission, power steering, power brakes, power windows, power seats, radio, and heater, to the extent that these items are available as factory-installed equipment (whether installed or not).

**Air pressure**

The amount of air inside the tire pressing outward on each square inch of the tire. Air pressure is expressed in pounds per square inch (psi), or kilopascal (kPa) or bars.

**Aspect ratio**

Dimensional relationship between tire section height and section width expressed in percentage.

### Tires and wheels

#### Bar

Another metric unit for air pressure. There are 14.5038 pounds per square inch (psi) to 1 bar; there are 100 kilopascals (kPa) to 1 bar.

#### Bead

The tire bead contains steel wires wrapped by steel cords that hold the tire onto the rim.

#### Cold tire inflation pressure

Tire inflation pressure when your vehicle has been sitting for at least 3 hours or driven no more than 1 mile (1.6 km).

#### Curb weight

The weight of a motor vehicle with standard equipment including the maximum capacity of fuel, oil, and coolant, and, if so equipped, air conditioning and additional optional equipment, but without passengers and cargo.

#### DOT (Department of Transportation)

A tire branding symbol which denotes the tire meets requirements of the U.S. Department of Transportation.

#### GAWR (Gross Axle Weight Rating)

The GAWR is the maximum permissible axle weight. The gross vehicle weight on each axle must never exceed the GAWR for the front and rear axle indicated on the certification label located on the driver's door B-pillar.

#### GTW (Gross Trailer Weight)

The GTW is the weight of the trailer plus the weight of all cargo, equipment, luggage etc. loaded on the trailer.

#### GVW (Gross Vehicle Weight)

The GVW comprises the weight of the vehicle including fuel, tools, spare wheel, installed accessories, passengers and cargo and, if applicable, trailer tongue load. The GVW must never exceed the GVWR indicated on the certification label located on the driver's door B-pillar.

#### GVWR (Gross Vehicle Weight Rating)

This is the maximum permissible vehicle weight of the fully loaded vehicle (weight of the vehicle including all options, passengers, fuel, and cargo and, if applicable, trailer tongue load). It is indicated on certification label located on the driver's door B-pillar.

#### Kilopascal (kPa)

The metric unit for air pressure. There are 6.9 kPa to 1 psi; another metric unit for air pressure is bars. There are 100 kilopascals (kPa) to 1 bar.

**Maximum load rating**

The maximum load in kilograms and pounds that can be carried by the tire.

**Maximum loaded vehicle weight**

The sum of curb weight, accessory weight, total load limit and production options weight.

**Maximum tire inflation pressure**

This number is the greatest amount of air pressure that should ever be put in the tire under normal driving conditions.

**Normal occupant weight**

The number of occupants the vehicle is designed to seat, multiplied by 68 kilograms (150 lbs).

**Occupant distribution**

The distribution of occupants in a vehicle at their designated seating positions.

**Production options weight**

The combined weight of those installed regular production options weighing over 5 lbs (2.3 kilograms) in excess of those standard items which they replace, not previously considered in curb weight or accessory weight, including heavy duty brakes, ride levelers, roof rack, heavy duty battery, and special trim.

**PSI (Pounds per square inch)**

A standard unit of measure for air pressure -> bar, kilopascal (kPa).

**Recommended tire inflation pressure**

Recommended tire inflation pressure for normal driving conditions is listed on the Tire and Loading Information placard located on driver's door B-pillar. Provides best handling, tread life and riding comfort. If so equipped, supplemental information pertaining to special driving situations can be found on the tire inflation pressure label on the inside of the fuel filler flap.

**Rim**

A metal support for a tire or a tire and tube assembly upon which the tire beads are seated.

**Sidewall**

The portion of a tire between the tread and the bead.

**TIN (Tire Identification Number)**

Unique identifier which facilitates efforts by tire manufacturers to notify purchasers in recall situations or other safety matters concerning tires and gives purchases the means to easily identify such tires. The TIN is comprised of "Manufacturer's identification mark", "Tire size", "Tire type code" and "Date of manufacture".

**Tire load rating**

Numerical code associated with the maximum load a tire can support.

### Tires and wheels

#### Tire ply composition and material used

This indicates the number of plies or the number of layers of rubber-coated fabric in the tire tread and sidewall. Tire manufacturers also must indicate the ply materials in the tire and sidewall, which include steel, nylon, polyester, and others.

#### Tire speed rating

Part of tire designation; indicates the speed range for which a tire is approved.

#### Total load limit

Rated cargo and luggage load plus 68 kilograms (150 lbs) times the vehicle's designated seating capacity.

#### Traction

Force exerted by the vehicle on the road via the tires. The amount of grip provided.

#### Tread

The portion of a tire that comes into contact with the road.

#### Treadwear indicators

Narrow bands, sometimes called “wear bars” that show across the tread of a tire when only  $1/16$  in (1.6 mm) of tread remains.

#### TWR (Tongue Weight Rating)

Maximum permissible weight on trailer tongue.

#### Uniform Tire Quality Grading Standards

A tire information system that provides consumers with ratings for a tire's traction, temperature and treadwear. Ratings are determined by tire manufacturers using government testing procedures. The ratings are molded into the sidewall of the tire.

#### Vehicle maximum load on the tire

Load on an individual tire that is determined by distributing to each axle its share of the maximum loaded vehicle weight and dividing it by two.

#### Rotating tires

##### Warning!



Rotate front and rear wheels only if they are of the same dimension.

If your vehicle is equipped with mixed-size tires (different tire dimensions front vs. rear), tire rotation is not possible.

Tire rotation can be performed on vehicles with tires of the same dimension all around. If your vehicle is equipped with tires of the same dimension all around, tires can be rotated, observing a front-to-rear rotation pattern that will maintain the intended rotation (spinning) direction of the tire (▷ page 387).

In some cases, such as when your vehicle is equipped with mixed-size tires (different tire dimension front vs. rear), tire rotation is not possible.

If applicable to your vehicle's tire configuration, tires can be rotated according to the tire manufacturer's recommended intervals in the tire manufacturer's warranty pamphlet located in your vehicle literature portfolio. If none is available, tires should be rotated every 3000 to 6000 miles (5000 to 10000 km), or sooner if necessary, according to the degree of tire wear. The same rotation (spinning) direction must be maintained (▷ page 387).

Rotate tires before the characteristic tire wear pattern becomes visible (shoulder wear on front tires and tread center wear on rear tires).

Thoroughly clean the mounting face of wheels and brake disks, i.e. the inner side of the wheels/tires, during each rotation. Check for and ensure proper tire inflation pressure.

**Warning!**

Have the tightening torque checked after changing a wheel. Wheels could become loose if not tightened with a torque of 110 lb-ft (150 Nm).

Only use genuine Mercedes-Benz wheel bolts specified for your vehicle's rims.

For information on wheel change, see the "Practical hints" section (▷ page 490) and (▷ page 519).



### Winter driving

Before the onset of winter, have your vehicle winterized at an authorized Mercedes-Benz Light Truck Center. This service includes:

- Check of anticorrosion and antifreeze concentration.
- Addition of cleaning concentrate to the water of the windshield and headlamp cleaning system. Add MB Concentrate “MB SummerFit” to a premixed windshield washer solvent/antifreeze which is formulated for temperatures below freezing point (▷ page 569).
- Battery test. Battery capacity drops with decreasing ambient temperature. A well charged battery helps to make sure that the engine can be started even at low ambient temperatures.
- Tire change. Mercedes-Benz recommends M+S rated radial-ply tires with a minimum tread depth of approximately  $\frac{1}{6}$  in (4 mm) on all four wheels for the winter season.

### Winter tires

Always use winter tires at temperatures below 45°F (7°C) and whenever wintry road conditions prevail. Not all M+S rated tires provide special winter performance. Make sure the tires you use show the mountain/snowflake  marking on the tire sidewall. These tires meet specific snow traction performance requirements of the Rubber Manufacturers Association (RMA) and The Rubber Association of Canada (RAC) and have been designed specifically for use in snow conditions. Use of winter tires is the only way to achieve the maximum effectiveness of the ABS, ESP®, 4-ETS, and EBP in winter operation.

For safe handling, make sure all mounted winter tires are of the same make and have the same tread design.

### Warning!



Winter tires with a tread depth of less than  $\frac{1}{6}$  in (4 mm) must be replaced. They are no longer suitable for winter operation.

Always observe the speed rating of the winter tires installed on your vehicle. If the maximum speed for which your tires are rated is below the speed rating of your vehicle, you must place a notice to this effect where it will be seen by the driver. Such notices are available from your tire dealer or from any authorized Mercedes-Benz Light Truck Center.

**Warning!**

If you use your spare tire when winter tires are fitted on the other wheels, be aware that the difference in tire characteristics may very well impair turning stability and that overall driving stability may be reduced. Adapt your driving style accordingly.

Have the spare tire replaced with a winter tire at the nearest authorized Mercedes-Benz Light Truck Center.

**Snow chains**

**!** *Even on vehicles with all-wheel-drive use snow chains on rear tires only.*

*Some tire sizes do not leave adequate clearance for snow chains. To help avoid serious damage to your vehicle or tires, use of snow chains is not permissible with the spare wheel.*

**!** *Vehicles with ADS\*:  
When driving with snow chains, do not select **SPORT** mode (▷ page 279).*

**i** *When driving with snow chains, you may wish to deactivate the ESP® (▷ page 105) before setting the vehicle in motion. This will improve the vehicle's traction.*

Snow chains should only be driven on snow-covered roads at speeds not to exceed 30 mph (50 km/h). Remove chains as soon as possible when driving on roads without snow.

Please observe the following guidelines when using snow chains:

- Use of snow chains is not permissible with all wheel/tire combinations (▷ page 555).
- Snow chains should only be used on the rear wheels. Follow the manufacturer's mounting instructions.
- Only use snow chains that are approved by Mercedes-Benz. Any authorized Mercedes-Benz Light Truck Center will be glad to advise you on this subject.
- Use of snow chains may be prohibited depending on location. Always check local and state laws before installing snow chains.
- Do not use snow chains on the spare wheel (▷ page 558).

### Maintenance

We strongly recommend that you have your vehicle serviced by an authorized Mercedes-Benz Light Truck Center, in accordance with the Maintenance Booklet at the times called for by the maintenance service indicator display.

**!** *Failure to have the vehicle maintained in accordance with the Maintenance Booklet and maintenance service indicator at the designated times/mileage will result in vehicle damage not covered by the Mercedes-Benz Limited Warranty.*

#### Maintenance service indicator message

The maintenance service indicator message will notify you when the next maintenance service is due.

Starting approximately 1 month before the next maintenance service is due, one of the following messages will appear in the multifunction display while you are driving or when you switch on the ignition (example service A):

Service A In XXXXX Miles (Km)  
Service A In XXX Days  
Service A In X Day  
Service A Due Now

The maintenance services will be indicated by showing a service type A through type H in the multifunction display. Types A through H are classified based on estimated time needed to perform the maintenance service, ranging:

from        Service A  
                  (approximately 1 hour)  
to            Service H  
                  (approximately 8 hours)

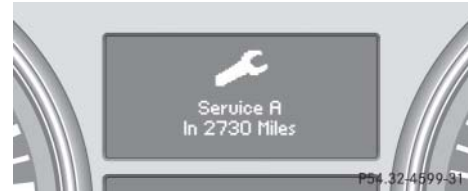

Refer to Maintenance Booklet for a listing of maintenance services and intervals they need to be performed at.

**i** *The Maintenance System in your vehicle tracks distance driven and the time elapsed since the last maintenance service and calculates other maintenance service work required.*

### Clearing the maintenance service indicator message

The maintenance service indicator message is automatically cleared

- after approximately 10 seconds when you switch on the ignition or when reaching the maintenance service threshold while driving
- after approximately 30 seconds, once the suggested maintenance service term has passed

You can also clear it yourself:



#### ① Reset button

- ▶ Press reset button ① on the instrument cluster.

The maintenance service indicator message is cleared and the standard display appears in the multifunction display (▷ page 162).

### Maintenance service term exceeded

If you have exceeded the suggested maintenance service term, you will see the following message in the multifunction display:

Service A Exceeded By XXXXX Miles (Km)  
 Service A Exceeded By XXX Days  
 Service A Exceeded By X Day





In addition, a signal sounds when the message appears.

Any authorized Mercedes-Benz Light Truck Center will reset the maintenance service indicator following a completed maintenance service.

### Calling up the maintenance service indicator display

---

You can call up the maintenance service indicator display at any time to check when the next maintenance service is due.

- ▶ Switch on the ignition (▷ page 42).
- ▶ Press button  or  on the multifunction steering wheel repeatedly until the standard display appears in the multifunction display (▷ page 162).
- ▶ Press button  or  until the maintenance service indicator display with the service symbol  and the service deadline appears in the multifunction display.

**i** *If the battery is disconnected, the days of disconnection will not be included in the count shown by the maintenance service indicator.*

*To arrive at the true maintenance service deadline, you will need to subtract these days from the days shown in the maintenance service indicator message or maintenance service indicator display.*

*Do not confuse the maintenance service indicator with the engine oil level indicator .*

### Resetting the maintenance service indicator

---

In the event that the maintenance service on your vehicle is not carried out by an authorized Mercedes-Benz Light Truck Center, you can have the maintenance service indicator reset. The automotive maintenance facility carrying out the maintenance service will find the information for resetting the maintenance service indicator in the maintenance-relevant information for your vehicle. Such information is available from any authorized Mercedes-Benz Light Truck Center or directly from Mercedes-Benz.

**!** *If the maintenance service indicator was inadvertently reset, have an authorized Mercedes-Benz Light Truck Center correct it.*

*Only reset if the proper maintenance service has been performed. Resetting the system without performing the proper service as called for by the maintenance service indicator will result in engine damage and/or other vehicle damage not covered by the Mercedes-Benz Limited Warranty.*

## ▼ Vehicle care

### Cleaning and care of the vehicle

Regular and proper care will help to maintain the value of your vehicle. The best way to protect your vehicle from harmful environmental influences is to wash it and use protective treatments regularly.

#### Warning!



Many cleaning products can be hazardous. Some are poisonous, others are flammable. Always follow the instructions on the particular container. Always open your vehicle's doors or windows when cleaning the inside.

Never use fluids or solvents that are not designed for cleaning your vehicle.

Always lock away cleaning products and keep them out of reach of children.

While in operation, even while parked, your vehicle is subjected to varying external influences which, if gone unchecked, can attack the paintwork as well as the underbody and cause lasting damage.

Such damage is caused not only by extreme and varying climatic conditions, but also by:

- Air pollution
- Road salt
- Tar
- Gravel and stone chipping

To avoid paint damage, you should immediately remove:

- Grease and oil
- Fuel
- Coolant
- Brake fluid
- Bird droppings
- Insects
- Tree resins, etc.

Frequent washing reduces and/or eliminates the aggressiveness and potency of the above adverse influences.

More frequent washings are necessary to deal with unfavorable conditions:

- near the ocean
- in industrial areas (smoke, exhaust emissions)
- during winter operation

You should check your vehicle from time to time for stone chipping or other damage. Any damage should be repaired as soon as possible to prevent corrosion.

In doing so, do not neglect the underbody of the vehicle. A prerequisite for a thorough check is a washing of the underbody followed by a thorough inspection. Damaged areas need to be re-undercoated.

Your vehicle has been treated at the factory with a wax-base rustproofing in the body cavities which will last for the lifetime of the vehicle. Post-production treatment is neither necessary nor recommended by Mercedes-Benz because of the possibility of incompatibility between materials used in the production process and others applied later.

We have selected car-care products and compiled recommendations which are specially matched to our vehicles and which always reflect the latest technology. You can obtain Mercedes-Benz approved car-care products at an authorized Mercedes-Benz Light Truck Center.

Scratches, corrosive deposits, corrosion or damage due to negligent or incorrect care cannot always be removed or repaired with the car-care products recommended here. In such cases it is best to seek aid at an authorized Mercedes-Benz Light Truck Center.

The following topics deal with the cleaning and care of your vehicle and give important “how-to” information as well as references to Mercedes-Benz approved car-care products.

#### Power washer

**!** Follow the instructions provided by the power washer manufacturer on maintaining a distance between the vehicle and the nozzle of the power washer.

*Never use a round nozzle to power-wash tires. The intense jet of water can result in damage to the tire.*

*Always replace a damaged tire.*

*Always keep the jet of water moving across the surface. Do not aim directly at electrical parts, electrical connectors, seals, or other rubber parts.*

**i** Vehicles with KEYLESS-GO\*:  
*If a door handle is hit by a strong jet of water, and a SmartKey with KEYLESS-GO\* is in close proximity, i.e. within approximately 3 ft (approximately 1 m), the vehicle could be inadvertently locked or unlocked.*

#### Tar stains

Quickly remove tar stains before they dry and become more difficult to remove. A tar remover is recommended.

#### Paintwork, painted body components

**!** Affixing stickers, adhesive tape or similar materials to painted body components may damage the paintwork.

Mercedes-Benz approved Paint Care should be applied when water drops on the paint surface do not “bead up”. This should normally be done every 3 to 5 months, depending on the climate and washing detergent used.

Mercedes-Benz approved Paint Cleaner should be applied if the paint surface shows signs of dirt embedding (i.e. loss of gloss).

Do not apply any of these products or wax if your vehicle is parked in the sun or if the hood is still hot.

- ▶ Use the appropriate MB-Touch-Up Stick for quick and provisional repairs of minor paint damage (i.e. chips from stones, vehicle doors, etc.).

### Engine cleaning

Prior to cleaning the engine compartment make sure to protect electrical components and connectors from the intrusion of water and cleaning agents.

Corrosion protection, such as MB Anticorrosion Wax, should be applied to the engine compartment after every engine cleaning. Before applying, all control linkage bushings and joints should be lubricated. The poly-V-belt and all pulleys should be protected from any wax.

### Vehicle washing

In the winter, thoroughly remove all traces of road salt as soon as possible.

When washing the vehicle underbody, do not forget to clean the inner sides of the wheels.

**i** *Vehicles with KEYLESS-GO\*:  
If a door handle is hit by a strong jet of water, and a SmartKey with KEYLESS-GO\* is in close proximity, i.e. within approximately 3 ft (approximately 1 m), the vehicle could be inadvertently locked or unlocked.*

### Hand-wash

Do not use hot water or wash your vehicle in direct sunlight.

- ▶ Only use a mild car wash detergent, such as Mercedes-Benz approved Car Shampoo.

- ▶ Thoroughly spray the vehicle with a diffused jet of water.

Direct only a very weak spray towards the ventilation intake.

- ▶ Use plenty of water and rinse the sponge and chamois frequently.
- ▶ Rinse with clean water and thoroughly dry with a chamois.

Do not allow cleaning agents to dry on the finish.

- !** *Do not use scouring agents on these parts.*

*Never apply strong force and only use a soft, non-scratching cloth when cleaning the vehicle. Do not attempt to wipe the surface with a dry cloth or sponge.*

*Otherwise you may scratch or damage the paint.*



### Automatic car wash

You can have your car washed in an automatic car wash from the start. Automatic car washes without brushes are preferable.

- ▶ To protect the filter system, switch the climate control system (▷ page 216) or the automatic climate control system\* (▷ page 230) to air recirculation mode.

**!** *Do not clean your vehicle in an automatic touchless car wash which use caustic spray. Otherwise the caustic spray will damage the paint or ornamental moldings.*

If the vehicle is very dirty, prewash it before running it through the automatic car wash.

**!** *Make sure that the windshield wiper switch is set to **0** (▷ page 63). Otherwise, e.g. the rain sensor could activate and cause the wipers to move unintentionally. This may lead to vehicle damage.*

*Due to the width of the vehicle, fold in exterior rear view mirrors prior to running the vehicle through an automatic car wash to prevent damage to the mirrors.*

When taking the vehicle through an automatic conveyor type car wash, observe the following instructions.

### Warning!



When leaving the SmartKey or SmartKey with KEYLESS-GO\* in the starter switch, do not leave children unattended in the vehicle. It is possible for children to switch on the ignition which could result in unsupervised use of vehicle equipment. A child's unsupervised access to a vehicle could result in an accident and/or serious personal injury.

Vehicles with SmartKey:

- ▶ With the vehicle at a standstill and the ignition switched on shift the automatic transmission to neutral position **N**.
- ▶ If engaged, release the parking brake (▷ page 59).
- ▶ Switch off the ignition and leave the SmartKey in the starter switch.

Vehicles with KEYLESS-GO\*:

- ▶ With the vehicle at a standstill, depress the brake pedal and keep it pressed.
- ▶ With the ignition switched on shift the automatic transmission to park position **P**.
- ▶ Release the brake pedal.
- ▶ Remove the KEYLESS-GO\* start/stop button from the starter switch (▷ page 43).
- ▶ Insert the SmartKey with KEYLESS-GO\* into the starter switch.
- ▶ Switch on the ignition.

- ▶ Depress the brake pedal.
- ▶ Shift the automatic transmission to neutral position **N**.
- ▶ Release the brake pedal.
- ▶ If engaged, release the parking brake (▷ page 59).
- ▶ Switch off the ignition and leave the SmartKey with KEYLESS-GO\* in the starter switch.

**i** After running the vehicle through an automatic car wash, wipe any wax off of the windshield (▷ page 431). This will prevent smears and reduce wiping noise which can be caused by residual wax on the windshield.

When leaving the car wash, make sure that the mirrors are folded out. Otherwise they may vibrate.

### Ornamental moldings

For regular cleaning and care of ornamental moldings, use a damp cloth.

**!** Do not use chrome cleaner on ornamental moldings. Although ornamental moldings may have chrome appearance, they could be made of anodized aluminum that will be damaged when cleaned with chrome cleaner. Instead, use a damp cloth to clean those ornamental moldings.

For very dirty ornamental moldings of which you are sure are chrome-plated, use a chrome cleaner. If in doubt whether an ornamental molding is chrome-plated, contact an authorized Mercedes-Benz Light Truck Center.

### Headlamps, brake lamps, tail lamps, side markers, turn signal lenses

- ▶ Use a mild car wash detergent, such as Mercedes-Benz approved Car Shampoo, with plenty of water.

**!** Only use window cleaning solutions that are suitable for plastic lamp lenses. Window cleaning solutions which are not suitable may damage the plastic lamp lenses of the headlamps. Therefore, do not use abrasives, solvents or cleaners that contain solvents.

Never apply strong force and only use a soft, non-scratching cloth when cleaning the lenses. Do not attempt to wipe dirty lenses with a dry cloth or sponge.

Otherwise you may scratch or damage the lens surface.

## Vehicle care

### Cleaning the DISTRONIC\* system sensor cover



① DISTRONIC\* system sensor cover

- ▶ Switch off the ignition (▷ page 42).
- ▶ Use a mild car wash detergent, such as Mercedes-Benz approved Car Shampoo, with plenty of water and a non-scratching cloth to clean sensor cover ①.

**!** To prevent scratches or damage, never apply strong force and only use a soft, non-scratching cloth when cleaning the sensor cover ①. Do not attempt to wipe dirty sensors with a dry cloth or sponge.

- ▶ Restart the engine after cleaning sensor cover ①.

### Cleaning the Parktronic\* system sensors

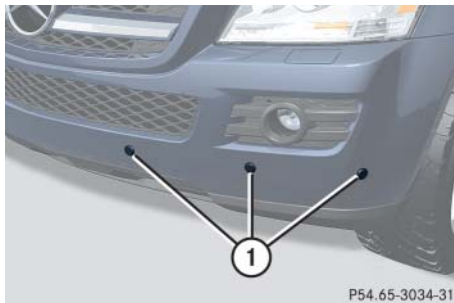

① Parktronic\* system sensors in front bumper

- ▶ Use a mild car wash detergent, such as Mercedes-Benz approved Car Shampoo, with plenty of water and a soft, non-scratching cloth to clean sensors ① on the bumpers.

**!** Do not apply strong pressure to the sensor covers. Applying strong pressure may damage the sensor covers.

Follow the instructions provided by the power washer manufacturer on maintaining a distance between the vehicle and the nozzle of the power washer.

**!** To prevent scratches, never apply strong force and only use a soft, non-scratching cloth when cleaning the sensors. Do not attempt to wipe dirty sensors with a dry cloth or sponge.

### Cleaning the Rear View Camera lens\*



#### ① Camera lens

- ▶ Only use clean water and a soft, non-scratching cloth to clean the camera lens ①.

Be careful not to apply wax to camera lens ① when waxing the vehicle. If necessary, remove the wax using the Mercedes-Benz approved Car Shampoo with plenty of water.

**!** Do not clean the camera and the area around the camera:

- with a high-pressure cleaner
- with a dry cloth and high pressure
- with aggressive cleaning agents

You could otherwise damage the camera.

### Cleaning the windows and the wiper blades

#### Warning!



For safety reasons, switch off wipers and remove SmartKey from starter switch (vehicles with KEYLESS-GO\*: Make sure the vehicle's on-board electronics have status **0**) before cleaning the windshield and/or the wiper blades. Otherwise, the wiper motor could suddenly turn on and cause injury.

- ▶ Fold the wiper arms forward until they engage.

**!** Do not pull on the wiper blade inserts. They could tear.

- ▶ Clean the wiper blade inserts with a clean cloth and detergent solution. ▷▷

### Vehicle care

- ▷▷ Use a soft, clean cloth and a mild window cleaning solution on all outside and inside glass surfaces.

An automotive glass cleaner is recommended.

**!** *Fold the windshield wiper arms back onto the windshield before turning the SmartKey in the starter switch or pressing the KEYLESS-GO start/stop button (vehicles with KEYLESS-GO\*).*

*Hold on to the wiper when folding the wiper arm back. If released, the force of the impact from the tensioning spring could crack the windshield.*

**!** *To clean the window interior, do not use a dry cloth, abrasives, solvents or cleaners containing solvents. Do not touch the inside of the front, rear or side windows and the power tilt/sliding sunroof\* or rear panorama roof with hard objects such as an ice scraper or ring. Doing so may damage the windows.*

#### Light alloy wheels

If possible, clean wheels once a week.

- ▶ Use Mercedes-Benz approved Wheel Care, a soft bristle brush and a strong spray of water for cleaning the light alloy wheels.

**!** *Only use acid-free cleaning materials. Acid may cause corrosion or damage the clear coat.*

**!** *The vehicle should not be parked for an extended period of time immediately after it has been cleaned, especially not after the wheel rims have been cleaned with wheel rim cleaner.*

*Wheel rim cleaners can lead to increased corrosion of the brake disks and brake pads. Non-approved wheel cleaners may also damage the wheel paint if the car is not driven after cleaning. Therefore, the vehicle's brake system should always be warmed-up before it is parked after cleaning. To do so, please drive your vehicle for several minutes to allow the brakes to dry. When applying Mercedes-Benz approved Tire Care and Mercedes-Benz approved Wheel Care products, take care not to spray them on the brake disks.*

#### Plastic and rubber parts

- ▶ Use a gentle dishwashing detergent or mild detergent for delicate fabrics as a washing solution.
- ▶ Wipe with a cloth moistened in a lukewarm solution.

The surface may temporarily change color. If this is the case, wait for it to dry.

#### Warning!



Do not use cleaners or cockpit care sprays containing solvents to clean the cockpit or the steering wheel. Cleaners containing solvents will make the surface porous and vehicle occupants could suffer serious injuries from plastic parts coming loose in the event of air bag deployment.

**!** Do not use oil, wax or scouring agents on these parts.

Never apply strong force and only use a soft, non-scratching cloth when cleaning the surface. Do not attempt to wipe the surface with a dry cloth or sponge.

Otherwise you may scratch or damage the surface.

### Hard plastic trim items

- ▶ Use Mercedes-Benz approved Interior Care, a soft, lint-free cloth and apply with light pressure.

**!** Never apply strong force and only use a soft, non-scratching cloth when cleaning the surface. Do not attempt to wipe the surface with a dry cloth or sponge.

Otherwise you may scratch or damage the surface.

### Steering wheel

- ▶ Wipe with a damp cloth and dry thoroughly or clean with Mercedes-Benz approved Leather Care.

### Carpets

- ▶ Use Mercedes-Benz approved Carpet and Fabric Care for cleaning the carpets.

### Headliner

- ▶ Use a soft bristle brush or a dry-shampoo cleaner in case of excessive dirt.

### Seat belts

- ▶ Only use clear, lukewarm water and soap.

**!** The seat belts must not be treated with chemical cleaning agents. Do not dry the seat belts at temperatures above 176 °F (80 °C) or in direct sunlight.

### Warning!



Do not bleach or dye seat belts as this may severely weaken them. In a crash they may not be able to provide adequate protection.

### Upholstery

Using aftermarket seat covers or wearing clothing that have the tendency to give off coloring (e.g. when wet, etc.) may cause the upholstery to become permanently discolored. By lining the seats with a proper intermediate cover, contact-discoloration will be prevented.

#### Warning!



Only use seat or head restraint covers which have been tested and approved by Mercedes-Benz for your vehicle model. Using other seat or head restraint covers may interfere with or prevent

- deployment of the front side impact air bags
- deployment of the rear side impact air bags\*
- activation of the active head restraints

Contact an authorized Mercedes-Benz Light Truck Center for availability.

### Leather upholstery\*

Please note that leather upholstery is a natural product and is therefore subject to a natural aging process. Leather upholstery may also react to certain ambient influences such as high humidity or high temperature by showing wrinkles for example.

- ▶ Wipe leather upholstery with a damp cloth and dry thoroughly or clean with Mercedes-Benz approved Leather Care.

**!** *To avoid damage to leather upholstery:*

- *Wipe with light pressure only.*
- *Do not clean with abrasive cleaning agents such as scouring milk or powder.*
- *Do not soak the leather upholstery.*

*As leather is a natural product, it could otherwise harden or become porous.*

- *Exercise particular care when cleaning perforated leather as its underside should not become wet.*

### MB Tex upholstery

- ▶ Use Mercedes-Benz approved Interior Care onto a soft, lint-free cloth and apply with light pressure for cleaning the upholstery.

### Wood trims

- ▶ Dampen cloth using water and use damp cloth to clean wood trims in your vehicle.

**!** *Do not use solvents like tar remover or wheel cleaner nor polishes or waxes as these may be abrasive.*



**What to do if ...**

**Where will I find ...?**

**Unlocking/locking in an emergency**

**Resetting activated head restraints**

**Replacing SmartKey batteries**

**Replacing bulbs**

**Replacing wiper blades**

**Flat tire**

**Bleeding the fuel system  
(diesel engine only)**

**Battery**

**Jump starting**

**Towing the vehicle**

**Fuses**



### What to do if ...



#### Lamps in instrument cluster

General information:

If any of the following lamps in the instrument cluster fails to come on during the

bulb self-check when switching on the ignition, have the respective bulb checked and replaced if necessary.

Problem	Possible cause/consequence	Suggested solution
 <p>The yellow ABS indicator lamp comes on while the engine is running.</p>	<p>ABS has detected a malfunction and has switched off. The BAS, ESP®, EBP, and 4-ETS are also switched off (see messages in multifunction display).</p> <p>The brake system is still functioning normally but without the ABS available.</p> <p>If the ABS control unit is malfunctioning, other systems such as the navigation system* or the automatic transmission may also be malfunctioning.</p> <p>The charging voltage has fallen below 10 volts. The ABS has switched off.</p> <p>The battery might not be charged sufficiently.</p>	<ul style="list-style-type: none"> <li>▶ Continue driving with added caution. Wheels may lock during hard braking, reducing steering capability.</li> <li>▶ Read and observe messages in the multifunction display (▷ page 449).</li> <li>▶ Have the system checked at an authorized Mercedes-Benz Light Truck Center as soon as possible.</li> </ul> <p>Failure to follow these instructions increases the risk of an accident.</p> <p>When the voltage is above this value again, the ABS is operational again and the ABS indicator lamp should go out.</p> <p>If the ABS indicator lamp does not go out:</p> <ul style="list-style-type: none"> <li>▶ Have the generator (alternator) and the battery checked.</li> </ul>

Problem	Possible cause/consequence	Suggested solution
 The yellow ABS indicator lamp comes on while the engine is running.	The self-diagnosis has not yet been completed yet.	The display will clear after driving a short distance at a vehicle speed of above 12 mph (20 km/h).
 (USA only)  (Canada only) The red brake warning lamp comes on while driving and an acoustic warning sounds.	<p>You are driving with the parking brake set.</p> <p>There is insufficient brake fluid in the reservoir.</p>	<ul style="list-style-type: none"> <li>▶ Release the parking brake (▷ page 59).</li> <li>▶ Risk of accident! Carefully stop the vehicle in a safe location or as soon as it is safe to do so.</li> <li>▶ Apply the parking brake (▷ page 67).</li> <li>▶ Contact an authorized Mercedes-Benz Light Truck Center. Do not add brake fluid! This will not solve the problem.</li> </ul>

**Warning!**









Driving with the brake warning lamp illuminated can result in an accident. Have your brake system checked immediately if the brake warning lamp stays on.

Do not add brake fluid before checking the brake system. Overfilling the brake fluid reservoir can result in spilling brake fluid on hot engine parts and the brake fluid catching fire. You can be seriously burned.

**!** *If you find that the brake fluid in the brake fluid reservoir has fallen to the minimum mark or below, have the brake system checked for brake pad thickness and leaks.*



### What to do if ...



Problem		Possible cause/consequence	Suggested solution
   	<p>(USA only)</p> <p>(Canada only)</p> <p>The red brake warning lamp comes on while driving. In addition, the yellow ABS malfunction indicator lamp, and the yellow ESP<sup>®</sup> warning lamp come on and an acoustic warning sounds.</p>	<p>The Electronic Brake Proportioning (EBP) has switched off due to a malfunction.</p> <p>The ABS, the BAS, and the ESP<sup>®</sup> are also switched off.</p>	<p>► Have the system checked at an authorized Mercedes-Benz Light Truck Center as soon as possible.</p> <p>Failure to follow these instructions increases the risk of an accident.</p>

Problem		Possible cause/consequence	Suggested solution
 (USA only)  (Canada only)	The yellow engine malfunction indicator lamp comes on while driving.	There is a malfunction in: <ul style="list-style-type: none"> <li>• The fuel management system</li> <li>• The ignition system</li> <li>• The emission control system</li> <li>• Systems which affect emissions</li> </ul> Such malfunctions may result in excessive emissions values and may switch the engine to its limp-home (emergency operation) mode.	► Have the vehicle checked as soon as possible by an authorized Mercedes-Benz Light Truck Center. An on-board diagnostic connector is used by the service station to link the vehicle to the shop diagnostics system. It allows the accurate identification of system malfunctions through the read-out of diagnostic trouble codes. It is located in the front left area of the footwell next to the parking brake pedal.



 Some states may by law require you to visit a workshop as soon as the engine malfunction indicator lamp comes on. Check local requirements.

## What to do if ...

Problem	Possible cause/consequence	Suggested solution
<p> (USA only) The yellow engine malfunction indicator lamp comes on while driving.</p> <p> (Canada only)</p>	<p>A loss of pressure has been detected in the fuel system. The fuel cap may not be closed properly or the fuel system may be leaky.</p> <p>Vehicles with diesel engine: Your fuel tank is empty.</p>	<p>▶ Check the fuel cap (▷ page 374). If it is not closed properly:</p> <p>▶ Close the fuel cap.</p> <p>If it is closed properly:</p> <p>▶ Have the fuel system checked by an authorized Mercedes-Benz Light Truck Center.</p> <p>▶ After refueling start, turn off and restart the engine three or four times in succession.</p> <p>The limp-home mode is canceled. You do not need to have your vehicle checked.</p>
<p> The red distance warning lamp comes on while driving and you hear a warning sound.</p>	<p>You are gaining too rapidly on the vehicle ahead of you.</p> <p>The Distronic* has recognized a stationary obstacle on your probable line of travel.</p>	<p>▶ Apply the brakes immediately.</p> <p>▶ Carefully observe the traffic situation. You may need to brake or maneuver to avoid hitting an obstacle.</p>

Problem	Possible cause/consequence	Suggested solution
 <p>The yellow ESP<sup>®</sup> warning lamp comes on while the engine is running.</p>	<p>The ESP<sup>®</sup> has been switched off with the ESP<sup>®</sup> switch or has switched off due to a malfunction.</p> <p>Risk of accident!</p> <p>Adapt your speed and driving to the prevailing road, weather, and traffic conditions.</p>	<ul style="list-style-type: none"> <li>▶ Switch the ESP<sup>®</sup> back on (▷ page 106). Exceptions: (▷ page 105).</li> </ul> <p>If the ESP<sup>®</sup> cannot be switched back on:</p> <ul style="list-style-type: none"> <li>▶ Continue driving with added caution.</li> <li>▶ Observe additional messages in the multifunction display that may appear.</li> <li>▶ Have the system checked at an authorized Mercedes-Benz Light Truck Center as soon as possible.</li> </ul>
 <p>The yellow ESP<sup>®</sup> warning lamp flashes while driving.</p>	<p>The ESP<sup>®</sup> or the 4-ETS has come into operation because of detected traction loss of at least one tire.</p>	<ul style="list-style-type: none"> <li>▶ When driving off, apply as little throttle as possible.</li> <li>▶ While driving, ease up on the accelerator.</li> <li>▶ Adapt your speed and driving to the prevailing road and weather conditions.</li> <li>▶ Do not deactivate the ESP<sup>®</sup>. Exceptions: (▷ page 105).</li> </ul> <p>Failure to follow these instructions increases the risk of an accident.</p>

### What to do if ...



Problem	Possible cause/consequence	Suggested solution
 <p>The red seat belt telltale comes on for a maximum of 6 seconds after starting the engine.</p>	<p>The seat belt telltale reminds you and your passengers to fasten your seat belts before driving off.</p>	<p>► Fasten your seat belts.</p> <p>Regardless of whether the seat belts are fastened or not, the seat belt telltale always comes on and remains lit for 6 seconds after starting the engine.</p>
 <p>You hear a warning chime for a maximum of 6 seconds after starting the engine.</p>	<p>You have forgotten to fasten your seat belt.</p>	<p>► Fasten your seat belt.</p> <p>The warning chime stops sounding.</p>
 <p>The red seat belt telltale comes on while the vehicle is standing still and the engine is running or during driving.</p>	<p>You and/or your front passenger have forgotten to fasten your seat belts.</p> <p>There are items placed on the front passenger seat and therefore the system senses the front passenger seat as being occupied.</p>	<p>► Fasten your seat belts.</p> <p>The seat belt telltale goes out.</p> <p>► Remove the items from the front passenger seat and put them in a safe place.</p> <p>The seat belt telltale goes out.</p>

Problem	Possible cause/consequence	Suggested solution
 <p>During driving the red seat belt telltale flashes and you additionally hear an intermittent warning chime with increasing intensity.</p>	<p>The vehicle's speed once exceeded 15 mph (25 km/h) and you and/or your front passenger have forgotten to fasten your seat belts.</p>	<p>► Fasten your seat belts.</p> <p>The seat belt telltale goes out and the warning chime stops sounding.</p>
	<p>There are items placed on the front passenger seat and therefore the system senses the front passenger seat as being occupied.</p>	<p>► Remove the items from the front passenger seat and put them in a safe place.</p> <p>The seat belt telltale goes out and the warning chime stops sounding.</p>

**i** After 60 seconds with an unfastened seat belt on one of the front seats, the warning chime stops sounding and the seat belt telltale illuminates continuously. The seat belt telltale will only go out if both, the driver and front passenger's seat belt are fastened, or the vehicle is standing still and a front door is opened.



### What to do if ...

Problem	Possible cause/consequence	Suggested solution
<p> USA only: Combination low tire pressure/TPMS malfunction telltale for the TPMS illuminates continuously. Canada only: Low tire pressure telltale for the Advanced TPMS* illuminates continuously.</p>	<p>The TPMS (USA only) or Advanced TPMS* (Canada only) detects a loss of pressure in at least one tire.</p>	<ul style="list-style-type: none"> <li>▶ Carefully bring the vehicle to a halt, avoiding abrupt steering and braking maneuvers. Observe the traffic situation around you.</li> <li>▶ Read and observe messages in the multifunction display.</li> </ul> <p>If the tire inflation pressure in the respective tire(s) has (have) been corrected, the combination low tire pressure/TPMS malfunction telltale goes out after few minutes driving.</p>
<p> USA only: Combination low tire pressure/TPMS malfunction telltale for the TPMS flashes 60 seconds and then stays illuminated.</p>	<p>There is a malfunction in the TPMS.</p>	<ul style="list-style-type: none"> <li>▶ Read and observe messages in the multifunction display.</li> <li>▶ Have the TPMS checked by an authorized Mercedes-Benz Light Truck Center.</li> </ul> <p>After the malfunction has been remedied the combination low tire pressure/TPMS malfunction telltale goes out after few minutes driving.</p>

**Warning!**

Each tire, including the spare (if provided), should be checked monthly when cold and inflated to the inflation pressure recommended by the vehicle manufacturer on the Tire and Loading Information placard on the driver's door B-Pillar or, if available, the tire inflation pressure label on the fuel filler flap. If your vehicle has tires of a different size than the size indicated on the Tire and Loading Information placard or, if available, the tire inflation pressure label, you should determine the proper tire inflation pressure for those tires.

As an added safety feature, your vehicle has been equipped with a tire pressure monitoring system (TPMS) that illuminates a low tire pressure telltale when one or more of your tires is significantly underinflated. Accordingly, when the low tire pressure telltale illuminates, you should stop and check your tires as soon as possible, and inflate them to the proper pressure. Driving on a significantly underinflated tire causes the tire to overheat and can lead to tire failure.

Underinflation also reduces fuel efficiency and tire tread life, and may affect the vehicle's handling and stopping ability. Please note that the TPMS is not a substitute for proper tire maintenance, and it is the driver's responsibility to maintain correct tire pressure, even if underinflation has not reached the level to trigger illumination of the TPMS low tire pressure telltale.

USA only:

Your vehicle has also been equipped with a TPMS malfunction indicator to indicate when the system is not operating properly. The TPMS malfunction indicator is combined with the low tire pressure telltale. When the system detects a malfunction, the telltale will flash for approximately 1 minute and then remain continuously illuminated. This sequence will continue upon subsequent vehicle start-ups as long as the malfunction exists. When the malfunction indicator is illuminated, the system may not be able to detect or signal low tire pressure as intended.

TPMS malfunctions may occur for a variety of reasons, including the installation of incompatible replacement or alternate tires or wheels on the vehicle that prevent the TPMS from functioning properly. Always check the TPMS malfunction telltale after replacing one or more tires or wheels on your vehicle to ensure that the replacement or alternate tires and wheels allow the TPMS to continue to function properly.

### What to do if ...

Problem	Possible cause/consequence	Suggested solution
The yellow fuel tank reserve warning lamp in the fuel gauge comes on while driving.	The fuel level has gone below the reserve mark.	► Refuel at the next gas station (▷ page 374).
<b>SRS</b> The red SRS indicator lamp comes on while driving.	There is a malfunction in the restraint systems. The air bags or Emergency Tensioning Device (ETDs) could deploy unexpectedly or fail to deploy unexpectedly in an accident.	► Drive with added caution to the nearest authorized Mercedes-Benz Light Truck Center.

#### Warning!



In the event a malfunction of the SRS is indicated as outlined above, the SRS may not be operational. For your safety, we strongly recommend that you visit an authorized Mercedes-Benz Light Truck Center immediately to have the system checked, otherwise

the SRS may not be activated when needed in an accident, which could result in serious or fatal injury, or it might deploy unexpectedly and unnecessarily which could result in an accident and/or injury to you or to others.

## Lamp in center console

Problem	Possible cause/consequence	Suggested solution
 <b>PASS AIR BAG OFF</b> The front passenger front air bag off indicator lamp illuminates and remains illuminated with the weight of a typical adult or someone larger than a small individual on the front passenger seat.	The system is malfunctioning.	<ul style="list-style-type: none"> <li>▶ Have the system checked as soon as possible by an authorized Mercedes-Benz Light Truck Center.</li> <li>▶ Also read and observe any messages in the multifunction display and follow corrective steps (▷ page 460).</li> </ul>

### Warning!



If the  **PASS AIR BAG OFF** indicator lamp illuminates and remains illuminated with the weight of a typical adult or someone larger than a small individual on the front passenger seat, do not have any passenger use the front passenger seat until the system has been repaired.

### What to do if ...

Problem	Possible cause/consequence	Suggested solution
 <b>PASS AIR BAG OFF</b> The front passenger front air bag off indicator lamp does not illuminate and/or does not remain illuminated with the weight of a typical 12-month-old child in a standard child restraint or less on the front passenger seat.	The system is malfunctioning.	<ul style="list-style-type: none"> <li>▶ Make sure there is nothing between seat cushion and child seat and check installation of the child seat.</li> <li>▶ Make sure no objects applying supplemental weight onto the seat are present.</li> <li>▶ Make sure no objects which apply forces to the seat are present (e.g. objects such as books, briefcases etc. lodged behind or around the seat, head restraints pushing against roof etc.). The system may recognize such forces as supplemental weight.</li> <li>▶ If the front passenger front air bag off indicator lamp remains out, have the system checked as soon as possible by an authorized Mercedes-Benz Light Truck Center. Do not transport a child on the front passenger seat until the system has been repaired.</li> <li>▶ Also note any messages in the multifunction display and follow corrective steps (&gt; page 460).</li> </ul>

### Warning!



If the  **PASS AIR BAG OFF** indicator lamp does not illuminate or remains out with the

weight of a typical 12-month-old child in a standard child restraint or less on the front passenger seat, do not transport a child on

the front passenger seat until the system has been repaired.

## Vehicle status messages in the multifunction display





Warning and malfunction messages appear in the multifunction display located in the instrument cluster.





Certain warning and malfunction messages are accompanied by an audible signal.

Address these messages accordingly and follow the additional instructions given in this Operator's Manual.

Selecting the vehicle status message memory menu in the control system (▷ page 167) displays both cleared and uncleared messages.

High-priority messages appear in the multifunction display in red color.

Certain messages of high priority cannot be cleared from the multifunction display using the reset button (▷ page 152) or button , , , or  on the multifunction steering wheel.

Other messages of high priority and messages of less immediate priority can be cleared from the multifunction display using the reset button (▷ page 152) or button , , , or  on the multifunction steering wheel. They are then stored in the vehicle status message memory (▷ page 167). Remember that clearing a message will only make the message disappear. Clearing a message will not correct the condition that caused the message to appear.

### Warning!



All categories of messages contain important information which should be taken note of and, where a malfunction is indicated, addressed as soon as possible at an authorized Mercedes-Benz Light Truck Center.

Failure to repair condition noted may cause damage not covered by the Mercedes-Benz Limited Warranty, or result in property damage or personal injury.

### What to do if ...

#### Warning!



No messages will be displayed if either the instrument cluster or the multifunction display is inoperative.

As a result, you will not be able to see information about your driving conditions, such as speed or outside temperature, warning/indicator lamps, malfunction/warning messages or the failure of any systems. Driving characteristics may be impaired.

If you must continue to drive, please do so with added caution. Visit an authorized Mercedes-Benz Light Truck Center as soon as possible.

**i** *Switching on the ignition causes all instrument cluster lamps (except high beam headlamp indicator lamp, and turn signal indicator lamps unless activated) as well as the multifunction display to come on. Make sure the lamps and multifunction display are in working order before starting your journey.*

On the pages that follow, you will find a compilation of the most important warning and malfunction messages that may appear in the multifunction display.

For your convenience the messages are divided into two sections:

- Text messages (▷ page 451)
- Symbol messages (▷ page 466)

Text messages

Display message	Possible cause/consequence	Possible solution
<p>ABS</p> <p>ABS, ESP Inoperative See Operator's Manual</p>	<p>The ABS and the ESP® have been switched off due to a malfunction.</p> <p>The BAS is also switched off.</p> <p>The brake system is still functioning normally but without the ABS available.</p>	<ul style="list-style-type: none"> <li>▶ Continue driving with added caution. Wheels may lock during hard braking, reducing steering capability.</li> <li>▶ Have the system checked at an authorized Mercedes-Benz Light Truck Center as soon as possible.</li> </ul> <p>Failure to follow these instructions increases the risk of an accident.</p>
<p>ABS, ESP Unavailable See Operator's Manual</p>	<p>The ABS and the ESP® have been switched off because of insufficient power supply. The charging voltage has fallen below 10 volts.</p> <p>The BAS is also switched off.</p> <p>The brake system is still functioning normally but without the ABS available.</p>	<p>When the voltage is above this value again, the ABS is operational again and the message in the multifunction display should disappear.</p> <p>If the message in the multifunction display does not disappear:</p> <ul style="list-style-type: none"> <li>▶ Have the system checked at an authorized Mercedes-Benz Light Truck Center as soon as possible.</li> </ul>



### What to do if ...

Display message	Possible cause/consequence	Possible solution
ABS Unavailable See Operator's Manual	The self-diagnosis has not yet been completed yet.	The display will clear after driving a short distance at a vehicle speed of above 12 mph (20 km/h).
Cruise Control And SPEEDTRONIC Inoperative	The cruise control is malfunctioning.	▶ Have cruise control checked by an authorized Mercedes-Benz Light Truck Center.
Cruise Control --- MPH	You have attempted to set a speed while driving below 20 mph (30 km/h).	▶ Accelerate to a speed exceeding 20 mph (30 km/h) and set the speed (▷ page 255).
	The ESP® is switched off.	▶ Switch on the ESP® (▷ page 103).
	The automatic transmission is set to position <b>P</b> , <b>R</b> , or <b>N</b> .	▶ Set the automatic transmission to position <b>D</b> (▷ page 191).
	The vehicle is secured with the parking brake.	▶ Release the parking brake (▷ page 59).

Display message	Possible cause/consequence	Possible solution
DISTRONIC      --- MPH	You have attempted to set a speed while driving below 20 mph (30 km/h).	▶ Accelerate to a speed exceeding 20 mph (30 km/h) and set the speed (▷ page 260).
	The ESP® is switched off.	▶ Switch on the ESP® (▷ page 106).
	The automatic transmission is set to position <b>P</b> , <b>R</b> , or <b>N</b> .	▶ Set the automatic transmission to position <b>D</b> (▷ page 191).
	The vehicle is secured with the parking brake.	▶ Release the parking brake (▷ page 59).
Inoperative	The DISTRONIC* or the DISTRONIC* display are malfunctioning.	▶ Have the system checked by an authorized Mercedes-Benz Light Truck Center.
Override	You have accelerated. The DISTRONIC* has switched off.	▶ Stop accelerating.



### What to do if ...

Display message	Possible cause/consequence	Possible solution
DISTRONIC Available Again	Distrionic* had been deactivated and is available again.	▶ Activate Distrionic* (▷ page 266).
	Currently Unavailable See Operator's Manual	▶ Leave the area of the external interference. ▶ Activate Distrionic* again (▷ page 266), when the message DISTRONIC Available Again appears.
	Distrionic* is deactivated because the Distrionic* sensor has not sensed any other vehicles or objects, e.g. road sign or such, for a long time.	▶ Try to activate Distrionic* again (▷ page 266), when the message DISTRONIC Available Again appears.



Display message	Possible cause/consequence	Possible solution
<p>DISTRONIC</p> <p>Currently Unavailable See Operator's Manual</p>	<p>Distronic* is deactivated because</p> <ul style="list-style-type: none"> <li>• the Distronic* cover in the radiator grille is dirty</li> <li>• the functionality is impaired by heavy precipitation or fog</li> </ul>	<ul style="list-style-type: none"> <li>▶ Clean the Distronic* cover in the radiator grille (▷ page 430).</li> <li>▶ Restart the vehicle.</li> </ul> <p>Distronic* becomes operational again without the engine being restarted when</p> <ul style="list-style-type: none"> <li>• dirt on the radiator grille has fallen off while driving (e.g. slush or snow)</li> <li>• the system recognizes full sensor availability due to lessening rain or because the road is drying, for example</li> <li>• the message in the multifunction display disappears</li> </ul> <p>You can then operate Distronic* as usual again.</p>

### What to do if ...

Display message	Possible cause/consequence	Possible solution
Depress brake to shift out of P.	You have tried to shift the automatic transmission into position <b>D</b> , <b>R</b> or <b>N</b> using the gear selector lever without depressing the brake pedal.	▶ Depress the brake pedal.
Door Open Vehicle Not In Park	You have opened the driver's door and the automatic transmission is still in position <b>D</b> , <b>R</b> or <b>N</b> .	▶ Before you leave the vehicle, make sure that the automatic transmission is set to position <b>P</b> and that the parking brake is engaged.
Drive to workshop without shifting gears.	The automatic transmission cannot be shifted out of the set position because of a malfunction.	<p>If the automatic transmission is set to position <b>D</b>:</p> <p>▶ Without changing the automatic transmission from position <b>D</b>, drive to an authorized Mercedes-Benz Light Truck Center.</p> <p>If the automatic transmission is set to position <b>N</b>, <b>R</b> or <b>P</b>:</p> <p>▶ Do not drive.</p> <p>▶ Contact an authorized Mercedes-Benz Light Truck Center.</p>

Display message	Possible cause/consequence	Possible solution
<p>ESP</p> <p>Inoperative See Operator's Manual</p>	<p>In addition, the yellow ESP<sup>®</sup> warning lamp  comes on.</p> <p>The ESP<sup>®</sup> has detected a malfunction and switched off.</p> <p>The ABS may still be operational.</p>	<ul style="list-style-type: none"> <li>▶ Continue driving with added caution.</li> <li>▶ Have the system checked at an authorized Mercedes-Benz Light Truck Center as soon as possible.</li> </ul> <p>Failure to follow these instructions increases the risk of an accident.</p>
	<p>In addition, the yellow ESP<sup>®</sup> warning lamp  comes on.</p> <p>The ESP<sup>®</sup> or the ESP<sup>®</sup> display is malfunctioning.</p>	<ul style="list-style-type: none"> <li>▶ Continue driving with added caution.</li> <li>▶ Have the system checked at an authorized Mercedes-Benz Light Truck Center as soon as possible.</li> </ul> <p>Failure to follow these instructions increases the risk of an accident.</p>
	<p>In addition, the yellow ESP<sup>®</sup> warning lamp  comes on.</p> <p>The ESP<sup>®</sup> is deactivated because of a malfunction or interrupted power supply.</p>	<ul style="list-style-type: none"> <li>▶ Continue driving with added caution.</li> <li>▶ Contact an authorized Mercedes-Benz Light Truck Center as soon as possible.</li> </ul> <p>Failure to follow these instructions increases the risk of an accident.</p>

### What to do if ...

Display message	Possible cause/consequence	Possible solution
<p>ESP</p> <p>Unavailable See Operator's Manual</p>	<p>The ESP<sup>®</sup> was deactivated because of insufficient power supply. The charging voltage has fallen below 10 volts.</p> <p>The brake system is still functioning normally but without the ESP<sup>®</sup> available.</p>	<p>When the voltage is above this value again, the ESP<sup>®</sup> is operational again and the message in the multifunction display should disappear.</p> <p>If the message in the multifunction display does not disappear:</p> <ul style="list-style-type: none"> <li>▶ Have the generator (alternator) and the battery checked.</li> <li>▶ Have the system checked at an authorized Mercedes-Benz Light Truck Center as soon as possible.</li> </ul>
	<p>If the yellow ESP<sup>®</sup> warning lamp  flashes while driving and this message appears, the 4-ETS has switched off to prevent overheating of the drive wheel brakes.</p>	<p>As soon as the brakes have cooled off, the 4-ETS switches on again.</p> <p>The message in the multifunction display disappears and the ESP<sup>®</sup> warning lamp  goes out.</p>
	<p>The self-diagnosis has not been completed yet.</p>	<p>The display will clear after driving a short distance at a vehicle speed of above 12 mph (20 km/h).</p>

Display message	Possible cause/consequence	Possible solution
P Shift to P or N to start engine.	You have attempted to start the engine with the KEYLESS-GO* start/stop button while the automatic transmission was set to position <b>R</b> or <b>D</b> .	<ul style="list-style-type: none"> <li>▶ Set the automatic transmission to position <b>P</b> or <b>N</b>.</li> </ul> <p>Make sure the brake pedal is depressed when attempting to start the engine with the KEYLESS-GO* start/stop button.</p>
Only shift to P when vehicle is at a standstill.	You have tried to shift the automatic transmission into position <b>P</b> using the gear selector lever although the vehicle is still in motion.	<ul style="list-style-type: none"> <li>▶ Stop the vehicle.</li> <li>▶ Apply the parking brake (▷ page 67).</li> </ul>
SRS Restraint Sys. Malfunction Service Required	The system is malfunctioning.	<ul style="list-style-type: none"> <li>▶ Drive with added caution to the nearest authorized Mercedes-Benz Light Truck Center.</li> </ul>

**Warning!**





In the event a malfunction of the SRS is indicated as outlined above, the SRS may not be operational. For your safety, we strongly recommend that you contact an authorized Mercedes-Benz Light Truck Center immediately to have the system checked; otherwise

the SRS may not be activated when needed in an accident, which could result in serious or fatal injury, or it might deploy unexpectedly and unnecessarily which could also result in injury.



### What to do if ...

Display message	Possible cause/consequence	Possible solution
Front Passenger Airbag Enabled See Operator's Manual	Front passenger front air bag is activated while driving even though a child, small individual, or object below the system's weight threshold is on the front passenger seat, or the front passenger seat is empty. Objects on the seat or forces acting on the seat may make the system sense supplemental weight.	Stop the vehicle in a safe location as soon as possible and check the front passenger seat for the following: <ul style="list-style-type: none"><li>▶ Apply the parking brake (▷ page 67).</li><li>▶ Switch off the ignition (▷ page 42).</li><li>▶ Remove child and child restraint from front passenger seat and properly secure the child in rear seat employing the child restraint if necessary.</li><li>▶ Remove any other items from on and around the front passenger seat and make sure the storage bag on the back of the front passenger seat is empty.</li><li>▶ Make sure that no objects which apply forces to the seat are present (e.g. objects such as books, briefcases etc. lodged behind or around the seat, head restraints pushing against roof etc.). The system may recognize such forces as supplemental weight and sense that an occupant on the front passenger seat is of a greater weight than actually present.</li><li>▶ Keep the seat unoccupied, close the front passenger door and switch on the ignition (▷ page 42).</li></ul> (Continued on next page)

Display message	Possible cause/consequence	Possible solution
		<p>Monitor the  <b>PASS AIR BAG OFF</b> indicator lamp on the center console (▷ page 85) and the multifunction display in the instrument cluster (▷ page 26) for the following:</p> <p>With the seat unoccupied and the ignition turned on,</p> <ul style="list-style-type: none"> <li>the  <b>PASS AIR BAG OFF</b> indicator lamp on the center console should illuminate and remain illuminated, indicating that the OCS (▷ page 81) has deactivated the air bag.</li> <li>the message <b>Front Passenger Airbag Enabled See Operator's Manual</b> or the message <b>Front Passenger Airbag Disabled See Operator's Manual</b> should not appear in the multifunction display at any time the seat is unoccupied. Wait at least 60 seconds for the system to complete the necessary check cycles and to make sure neither message appears in the multifunction display.</li> </ul> <p>If above conditions are met, you can occupy the front passenger seat again. Depending on the front passenger classification sensed by the OCS (▷ page 81), the  <b>PASS AIR BAG OFF</b> indicator lamp will remain illuminated or go out.</p> <p>If above conditions are not met, the system is not working properly. Have the system checked as soon as possible by an authorized Mercedes-Benz Light Truck Center.</p>

**Warning!**





If the  **PASS AIR BAG OFF** indicator lamp

remains out even after performing the above corrective steps, do not have any children 12 years old and under and other small

individuals use the front passenger seat until the system has been repaired.

### What to do if ...

Display message	Possible cause/consequence	Possible solution
Front Passenger Airbag Disabled See Operator's Manual	Front passenger front air bag is deactivated while driving even though an adult or someone larger than a small individual is occupying the front passenger seat. Forces acting on the seat may make the system sense a decrease in weight.	<p>Stop the vehicle in a safe location as soon as possible and check the front passenger seat for the following:</p> <ul style="list-style-type: none"><li>▶ Apply the parking brake (▷ page 67).</li><li>▶ Switch off the ignition (▷ page 42).</li><li>▶ Have the front passenger vacate the seat and exit the vehicle.</li><li>▶ Adjust the seat in a height position (▷ page 46).</li><li>▶ Make sure that no objects which apply forces to the seat are present (e.g. objects such as books, briefcases etc. lodged underneath, behind or around the seat). Such forces may cause the system to sense that an occupant of a lesser weight than actually present is on the front passenger seat.</li><li>▶ Keep the seat unoccupied, close the front passenger door and switch on the ignition (▷ page 42).</li></ul> <p>(Continued on next page)</p>

Display message	Possible cause/consequence	Possible solution
		<p>Monitor the  <b>PASS AIR BAG OFF</b> indicator lamp on the center console (▷ page 85) and the multifunction display in the instrument cluster (▷ page 26) for the following:</p> <p>With the seat unoccupied and the ignition turned on,</p> <ul style="list-style-type: none"> <li>the  <b>PASS AIR BAG OFF</b> indicator lamp on the center console should illuminate and remain illuminated, indicating that the OCS (▷ page 81) has deactivated the air bag.</li> <li>the message <b>Front Passenger Airbag Enabled See Operator's Manual</b> or the message <b>Front Passenger Airbag Disabled See Operator's Manual</b> should not appear in the multifunction display at any time the seat is unoccupied. Wait at least 60 seconds for the system to complete the necessary check cycles and to make sure neither message appears in the multifunction display.</li> </ul> <p>If above conditions are met, you can occupy the front passenger seat again. Depending on the front passenger classification sensed by the OCS (▷ page 81), the  <b>PASS AIR BAG OFF</b> indicator lamp will remain illuminated or go out. If above conditions are not met, the system is not working properly. Have the system checked as soon as possible by an authorized Mercedes-Benz Light Truck Center.</p>

**Warning!**



If the  **PASS AIR BAG OFF** indicator lamp

remains illuminated with an adult occupant on the front passenger seat even after performing the above corrective steps, do not

have any passenger use the front passenger seat until the system has been repaired.



### What to do if ...



Display message	Possible cause/consequence	Possible solution
Check tires, then restart Run Flat Indicator.	There was a warning message about a loss in the tire inflation pressure and the Run Flat Indicator has not been restarted yet.	<ul style="list-style-type: none"> <li>▶ Make sure that the correct tire inflation pressure is set for each tire.</li> <li>▶ Then restart the Run Flat Indicator (▷ page 397).</li> </ul>
Run Flat Indicator Inoperative	The Run Flat Indicator is malfunctioning.	▶ Have the Run Flat Indicator checked by an authorized Mercedes-Benz Light Truck Center.
Tire Pressure Check Tires	The Run Flat Indicator indicates that the pressure is too low in one or more tires.	<ul style="list-style-type: none"> <li>▶ Carefully bring the vehicle to a halt, avoiding abrupt steering and braking maneuvers. Observe the traffic situation around you.</li> <li>▶ Check and adjust tire inflation pressure as required (▷ page 395).</li> <li>▶ If necessary, replace the wheel (▷ page 519).</li> <li>▶ Reactivate the Run Flat Indicator after adjusting the tire inflation pressure values (▷ page 397).</li> </ul>
Tire pressure displayed after driving for a few minutes.	Vehicles with Advanced TPMS*:  The tire inflation pressure is being checked.	▶ Drive the vehicle for a few minutes.

Display message	Possible cause/consequence	Possible solution
Tire Pressure Monitor Inoperative	The TPMS or Advanced TPMS* is malfunctioning.	<ul style="list-style-type: none"> <li>▶ Have the TPMS or Advanced TPMS* checked by an authorized Mercedes-Benz Light Truck Center.</li> </ul>
Tire Pressure Monitor Inoperative No Wheel Sensors	There are wheels without appropriate wheel sensors mounted (e.g. winter tires).	<ul style="list-style-type: none"> <li>▶ Have the TPMS or Advanced TPMS* checked by an authorized Mercedes-Benz Light Truck Center.</li> <li>▶ Have the wheel sensors installed by an authorized Mercedes-Benz Light Truck Center.</li> </ul>
Tire Pressure Monitor Wheel Sensor Missing	<p>Vehicles with Advanced TPMS*: One or more sensors are defect (e.g. battery is empty).</p> <p>The respective tire is indicated by - - - instead of the tire inflation pressure in the multifunction display.</p>	<ul style="list-style-type: none"> <li>▶ Have the Advanced TPMS* checked by an authorized Mercedes-Benz Light Truck Center.</li> <li>▶ Have the wheel sensors installed by an authorized Mercedes-Benz Light Truck Center.</li> </ul>
	<p>Vehicles with Advanced TPMS*: One or more wheels without appropriate wheel sensors mounted (e.g. spare tire).</p> <p>The respective tire is indicated by - - - instead of the tire inflation pressure in the multifunction display.</p>	<ul style="list-style-type: none"> <li>▶ Have the Advanced TPMS* checked by an authorized Mercedes-Benz Light Truck Center.</li> <li>▶ Have the wheel sensors installed by an authorized Mercedes-Benz Light Truck Center.</li> </ul>
Tire Pressure Monitor Currently Unavailable	The TPMS or Advanced TPMS* is unable to monitor the tire pressure due to a nearby radio interference source.	<ul style="list-style-type: none"> <li>▶ As soon as the causes of the malfunction have been removed, the TPMS or Advanced TPMS* automatically becomes active again after a few minutes driving.</li> </ul>

## What to do if ...

### Symbol messages



Display symbol	Display message	Possible cause/consequence	Possible solution
	Replace air filter.	The air filter is clogged.	<ul style="list-style-type: none"> <li>▶ Have the air filter checked by an authorized Mercedes-Benz Light Truck Center.</li> </ul>
		<p>The battery is no longer charging. Possible causes:</p> <ul style="list-style-type: none"> <li>• alternator malfunctioning</li> <li>• broken poly-V-belt</li> </ul> <p>Do not forget that the brake system requires electrical energy and may be operating with restricted capability. Considerably greater brake pedal force is required and the stopping distance is increased.</p>	<ul style="list-style-type: none"> <li>▶ Stop the vehicle in a safe location or as soon as it is safe to do so.</li> <li>▶ Apply the parking brake (▷ page 67).</li> <li>▶ Check the poly-V-belt.</li> </ul> <p>If it is broken:</p> <ul style="list-style-type: none"> <li>▶ Do not continue to drive. Otherwise the engine will overheat due to an inoperative water pump which may result in damage to the engine. Contact an authorized Mercedes-Benz Light Truck Center.</li> </ul> <p>If it is intact:</p> <ul style="list-style-type: none"> <li>▶ Drive immediately to the nearest authorized Mercedes-Benz Light Truck Center. Adjust driving to be consistent with reduced braking responsiveness.</li> </ul>

Display symbol	Display message	Possible cause/consequence	Possible solution
	Battery/Alternator Stop Vehicle	The battery is defective.	<ul style="list-style-type: none"> <li>▶ Stop the vehicle in a safe location or as soon as it is safe to do so.</li> <li>▶ Apply the parking brake (▷ page 67).</li> <li>▶ Do not continue to drive.</li> <li>▶ Contact an authorized Mercedes-Benz Light Truck Center.</li> </ul>
	Inoperative	Downhill Speed Regulation is malfunctioning.	<ul style="list-style-type: none"> <li>▶ Have the Downhill Speed Regulation checked by an authorized Mercedes-Benz Light Truck Center.</li> </ul>
	Brake Wear	The brake pads have reached their wear limit.	<ul style="list-style-type: none"> <li>▶ Have the brake pads replaced as soon as possible.</li> </ul>

**!** Brake pad thickness must be visually inspected by a qualified technician at the intervals specified in the Maintenance Booklet.



### What to do if ...

Display symbol	Display message	Possible cause/consequence	Possible solution
<b>BRAKE</b> (USA only)  (Canada only)	Release Parking Brake	You are driving with the parking brake set.	<ul style="list-style-type: none"> <li>▶ Release the parking brake (▷ page 59).</li> </ul>
<b>BRAKE</b> (USA only)  (Canada only)	EBV, ABS, ESP Inoperative See Operator's Manual	<p>The EBP, the ABS, and the ESP® have switched off due to a malfunction. The BAS is also switched off.</p> <p>The brake system is still functional but without the EBP, the ABS, and the ESP® available.</p>	<ul style="list-style-type: none"> <li>▶ Continue driving with added caution. Wheels may lock during hard braking, reducing steering capability.</li> <li>▶ Have the system checked at an authorized Mercedes-Benz Light Truck Center as soon as possible.</li> </ul> <p>Failure to follow these instructions increases the risk of an accident.</p>

Display symbol	Display message	Possible cause/consequence	Possible solution
<b>BRAKE</b> (USA only)  (Canada only)	Check Brake Fluid Level	There is insufficient brake fluid in the reservoir.	<ul style="list-style-type: none"> <li>▶ Risk of accident! Stop the vehicle in a safe location or as soon as it is safe to do so.</li> <li>▶ Apply the parking brake (▷ page 67).</li> <li>▶ Contact an authorized Mercedes-Benz Light Truck Center. Do not add brake fluid! This will not solve the problem.</li> </ul>

**Warning!**



Driving with the message **Check Brake Fluid Level** displayed can result in an accident. Have your brake system checked immediately. Do not add brake fluid before checking the brake system. Overfilling the brake fluid reservoir can result in spilling brake fluid on hot engine parts and the brake fluid catching fire. You could be seriously burned.

**!** *If you find that the brake fluid in the brake fluid reservoir has fallen to the minimum mark or below, have the brake system checked for brake pad thickness and leaks.*

## What to do if ...

Display symbol	Display message	Possible cause/consequence	Possible solution
	Coolant Level Stop car, switch engine off.	The coolant is too hot. Among other possible causes (the cooling fan could be malfunctioning), the poly-V-belt could be broken.	<ul style="list-style-type: none"> <li>▶ Stop the vehicle in safe location or as soon as it safe to do so.</li> <li>▶ Apply the parking brake (▷ page 67).</li> <li>▶ Turn off the engine.</li> <li>▶ Check the poly-V-belt.</li> </ul> <p>If it is broken:</p> <ul style="list-style-type: none"> <li>▶ Do not continue to drive. Otherwise, the engine will overheat due to an inoperative water pump which may result in damage to the engine. Contact an authorized Mercedes-Benz Light Truck Center.</li> </ul> <p>If it is intact:</p> <ul style="list-style-type: none"> <li>▶ Do not continue to drive the vehicle with this message displayed. Doing so could result in serious engine damage that is not covered by the Mercedes-Benz Limited Warranty.</li> </ul> <p>(Continued on next page)</p>

Display symbol	Display message	Possible cause/consequence	Possible solution
			<ul style="list-style-type: none"> <li>▶ Observe the coolant temperature in the multifunction display (▷ page 162). If the temperature raises again:</li> <li>▶ Contact an authorized Mercedes-Benz Light Truck Center immediately.</li> </ul>

**Warning!**



- Driving when your engine is overheated can cause some fluids which may have leaked into the engine compartment to catch fire. You could be seriously burned.
- Steam from an overheated engine can cause serious burns which can occur just by opening the hood. Stay away from the engine if you see or hear steam coming from it.

Stop the vehicle in a safe location away from other traffic. Turn off the engine, get out of the vehicle and do not stand near the vehicle until the engine has cooled down.

During severe operation conditions and stop-and-go city traffic, the coolant temperature may rise close to 248°F (120°C).

**!** *The engine should not be operated with the coolant temperature above 248°F (120°C). Doing so may cause serious damage which is not covered by the Mercedes-Benz Limited Warranty.*

### What to do if ...

Display symbol	Display message	Possible cause/consequence	Possible solution
	Top Up Coolant See Operator's Manual	The coolant level is too low.	<ul style="list-style-type: none"><li>▶ Add coolant (▷ page 381).</li><li>▶ If you have to add coolant frequently, have the cooling system checked by an authorized Mercedes-Benz Light Truck Center.</li></ul>

#### Warning!



Do not spill antifreeze on hot engine parts. Antifreeze contains ethylene glycol which may burn if it comes into contact with hot engine parts. You could be seriously burned.

**!** *Do not ignore the low engine coolant level warning. Extended driving with the message and symbol displayed may cause serious engine damage not covered by the Mercedes-Benz Limited Warranty.*

*Do not drive without sufficient amount of coolant in the cooling system. The engine will overheat causing major engine damage.*

Display symbol	Display message	Possible cause/consequence	Possible solution
	Check engine oil level at next refueling.	The engine oil level is too low.	▶ Check the engine oil level (▷ page 380) and add engine oil as required (▷ page 381).

When the message *Check engine oil level at next refueling.* appears while the engine is running and at operating temperature, the engine oil level has dropped to approximately the minimum level.





When this occurs, the warning will first come on intermittently and then stay on if the oil level drops further.

Visually check for oil leaks. If no obvious oil leaks are noted, drive to the nearest service station where the engine oil should be topped to the required level with an approved engine oil.

For information on approved engine oils, refer to the Factory Approved Service Products pamphlet (USA only) or contact an authorized Mercedes-Benz Light Truck Center.

**!** *The engine oil level warning should not be ignored. Extended driving with the symbol displayed could result in serious engine damage that is not covered by the Mercedes-Benz Limited Warranty.*

## What to do if ...

Display symbol	Display message	Possible cause/consequence	Possible solution
		You are driving with one or more doors open.	<ul style="list-style-type: none"> <li>▶ Stop the vehicle in a safe location or as soon as it is safe to do so.</li> <li>▶ Close the door(s).</li> </ul>
	Clean Fuel Filter		<ul style="list-style-type: none"> <li>▶ Contact an authorized Mercedes-Benz Light Truck Center.</li> </ul>
	Gas Cap Open	A loss of pressure has been detected in the fuel system. The fuel cap may not be closed properly or the fuel system may be leaky.	<ul style="list-style-type: none"> <li>▶ Check the fuel cap (▷ page 374).</li> </ul> <p>If it is not closed properly:</p> <ul style="list-style-type: none"> <li>▶ Close the fuel cap.</li> </ul> <p>If it is closed properly:</p> <ul style="list-style-type: none"> <li>▶ Have the fuel system checked by an authorized Mercedes-Benz Light Truck Center.</li> </ul>
		You are driving with the hood or the tailgate open.	<ul style="list-style-type: none"> <li>▶ Carefully bring the vehicle to a halt as soon as it is safe to do so in a safe location.</li> <li>▶ Close the hood (▷ page 379) or the tailgate (▷ page 123).</li> </ul>
		You are trying to lock the vehicle with the KEYLESS-GO* function with a door or the tailgate open.	<ul style="list-style-type: none"> <li>▶ Close all doors and/or the tailgate (▷ page 123).</li> </ul>

Display symbol	Display message	Possible cause/consequence	Possible solution
	Key Not Detected	The SmartKey with KEYLESS-GO* is not detected while the engine is running because <ul style="list-style-type: none"> <li>the SmartKey with KEYLESS-GO* is not in the vehicle</li> <li>there is strong radio-frequency interference</li> </ul>	<ul style="list-style-type: none"> <li>▶ Stop the vehicle in a safe location or as soon as it is safe to do so.</li> <li>▶ Apply the parking brake (▷ page 67).</li> <li>▶ Search for the SmartKey with KEYLESS-GO*.</li> </ul> Otherwise the vehicle cannot be centrally locked nor can the engine be started again after the engine is stopped.
		The SmartKey with KEYLESS-GO* is momentarily not detected.	<ul style="list-style-type: none"> <li>▶ Change the position of the SmartKey with KEYLESS-GO* in the vehicle.</li> <li>▶ Operate the vehicle with the SmartKey in the starter switch if necessary.</li> </ul>
	Key Not Detected	The SmartKey with KEYLESS-GO* is not detected while the ignition is switched on (▷ page 41) and a door is opened or closed and the SmartKey with KEYLESS-GO* is not in the vehicle.	<ul style="list-style-type: none"> <li>▶ Search for the SmartKey with KEYLESS-GO*.</li> </ul> Otherwise the vehicle cannot be locked nor can the engine be started. <ul style="list-style-type: none"> <li>▶ Change the position of the SmartKey with KEYLESS-GO* in the vehicle.</li> </ul>





### What to do if ...

Display symbol	Display message	Possible cause/consequence	Possible solution
	Key Detected In Vehicle	A SmartKey with KEYLESS-GO* left in the vehicle was detected while trying to lock the vehicle from the outside.	▶ Take the SmartKey with KEYLESS-GO* out of the vehicle.
	Remove Key	You have forgotten to remove the SmartKey.	▶ Remove the SmartKey from the starter switch.
	You need a new key.	There is no additional code available for SmartKey or SmartKey with KEYLESS-GO*.	▶ Contact an authorized Mercedes-Benz Light Truck Center as soon as possible.
	Key Does Not Belong to Vehicle	The SmartKey or SmartKey with KEYLESS-GO* in the starter switch does not belong to the vehicle.	▶ Find the SmartKey or SmartKey with KEYLESS-GO* that belongs to the vehicle to operate the vehicle.
	Change Key Batteries	The batteries in the SmartKey with KEYLESS-GO* are discharged.	▶ Replace the batteries (▷ page 502).
	Don't Forget Your Key	This message appears for a maximum of 60 seconds if the driver's door is opened with the engine shut off and no SmartKey in the starter switch. This message is only a reminder.	▶ Insert the SmartKey in the starter switch (▷ page 42). or ▶ Take the SmartKey with KEYLESS-GO* with you when leaving the vehicle.

Display symbol	Display message	Possible cause/consequence	Possible solution
	3rd Brake Lamp	The high mounted brake lamp is malfunctioning. This message will only appear if a critical number of LEDs have stopped working.	▶ Contact an authorized Mercedes-Benz Light Truck Center as soon as possible.
	Active Headlamps Inoperative	The active Bi-Xenon* headlamp system is malfunctioning.	▶ Contact an authorized Mercedes-Benz Light Truck Center as soon as possible.
	AUTO Light Inoperative	The light sensor is malfunctioning. The headlamps switch on automatically.	▶ Contact an authorized Mercedes-Benz Light Truck Center as soon as possible.  To switch off the headlamps (U. S. vehicles only):  ▶ In the control system, set lamp operation to manual mode (▷ page 144).  ▶ Switch off the headlamps using the exterior lamp switch (▷ page 143).
	Brake Lamp Left	The left brake lamp is malfunctioning. A substitute bulb is being used.	▶ Replace the bulb as soon as possible (▷ page 511).
	Brake Lamp Right	The right brake lamp is malfunctioning. A substitute bulb is being used.	▶ Replace the bulb as soon as possible (▷ page 511).

### What to do if ...

Display symbol	Display message	Possible cause/consequence	Possible solution
	Cornering Lamp Left	The left corner-illuminating front fog lamp is malfunctioning.	► Replace the bulb as soon as possible (▷ page 510).
	Cornering Lamp Right	The right corner-illuminating front fog lamp is malfunctioning.	► Replace the bulb as soon as possible (▷ page 510).
	Front Foglamp Left	The left front fog lamp is malfunctioning.	► Replace the bulb as soon as possible (▷ page 510).
	Front Foglamp Right	The right front fog lamp is malfunctioning.	► Replace the bulb as soon as possible (▷ page 510).
	High Beam Left	The left high beam lamp is malfunctioning.	Halogen headlamp: ► Replace the bulb as soon as possible (▷ page 508). Bi-Xenon* headlamp: ► Contact an authorized Mercedes-Benz Light Truck Center as soon as possible.
	High Beam Right	The right high beam lamp is malfunctioning.	Halogen headlamp: ► Replace the bulb as soon as possible (▷ page 508). Bi-Xenon* headlamp: ► Contact an authorized Mercedes-Benz Light Truck Center as soon as possible.

Display symbol	Display message	Possible cause/consequence	Possible solution
	License Plate Lamp Left	The left license plate lamp is malfunctioning.	▶ Replace the bulb as soon as possible (▷ page 514).
	License Plate Lamp Right	The right license plate lamp is malfunctioning.	▶ Replace the bulb as soon as possible (▷ page 514).
	Low Beam Left	The left low beam lamp is malfunctioning.	Halogen headlamp: ▶ Replace the bulb as soon as possible (▷ page 507). Bi-Xenon* headlamp: ▶ Contact an authorized Mercedes-Benz Light Truck Center as soon as possible.
	Low Beam Right	The right low beam lamp is malfunctioning.	Halogen headlamp: ▶ Replace the bulb as soon as possible (▷ page 507). Bi-Xenon* headlamp: ▶ Contact an authorized Mercedes-Benz Light Truck Center as soon as possible.







### What to do if ...

Display symbol	Display message	Possible cause/consequence	Possible solution
	Marker Lamp Front Left	The left front side marker lamp is malfunctioning.	▶ Replace the bulb as soon as possible (▷ page 510).
	Marker Lamp Front Right	The right front side marker lamp is malfunctioning.	▶ Replace the bulb as soon as possible (▷ page 510).
	Parking Lamp Front Left	The front left parking lamp is malfunctioning. A substitute bulb is being used.	▶ Replace the bulb as soon as possible (▷ page 509).
	Parking Lamp Front Right	The right front parking lamp is malfunctioning. A substitute bulb is being used.	▶ Replace the bulb as soon as possible (▷ page 509).
	Foglamp Rear Left	The left rear fog lamp is malfunctioning.	▶ Replace the bulb as soon as possible (▷ page 511).
	Reverse Lamp Left	The left backup lamp is malfunctioning.	▶ Replace the bulb as soon as possible (▷ page 511).
	Reverse Lamp Right	The right backup lamp is malfunctioning.	▶ Replace the bulb as soon as possible (▷ page 511).

Display symbol	Display message	Possible cause/consequence	Possible solution
	Switch Off Lights	You have removed the SmartKey from the starter switch and opened the driver's door or removed the SmartKey with KEYLESS-GO* from the vehicle and left the parking lamps or the rear fog lamp on.	► Turn the exterior lamp switch to <b>0</b> (▷ page 143).
	Tail Lamp Left	The left tail lamp is malfunctioning. A substitute bulb is being used.	► Replace the bulb as soon as possible (▷ page 511).
	Tail Lamp Right	The right tail lamp is malfunctioning. A substitute bulb is being used.	► Replace the bulb as soon as possible (▷ page 511).

### What to do if ...

Display symbol	Display message	Possible cause/consequence	Possible solution
	Turn Signal Rear Left	The left rear turn signal lamp is malfunctioning. A substitute bulb is being used.	► Replace the bulb as soon as possible (▷ page 511).
	Turn Signal Rear Right	The right rear turn signal lamp is malfunctioning. A substitute bulb is being used.	► Replace the bulb as soon as possible (▷ page 511).
	Turn Signal Front Left	The left front turn signal lamp is malfunctioning. A substitute bulb is being used.	► Replace the bulb as soon as possible (▷ page 509).
	Turn Signal Front Right	The right front turn signal lamp is malfunctioning. A substitute bulb is being used.	► Replace the bulb as soon as possible (▷ page 509).
	Turn Signal Left Mirror	The turn signal in the left exterior rear view mirror is malfunctioning. This message will only appear if a critical number of LEDs have stopped working.	► Contact an authorized Mercedes-Benz Light Truck Center as soon as possible.
	Turn Signal Right Mirror	The turn signal in the right exterior rear view mirror is malfunctioning. This message will only appear if a critical number of LEDs have stopped working.	► Contact an authorized Mercedes-Benz Light Truck Center as soon as possible.

Display symbol	Display message	Possible cause/consequence	Possible solution
	Reserve Fuel	The fuel level has gone below the reserve mark.	▶ Refuel at the next gas station (▷ page 374).
	Ultra Low-sulfur Diesel Fuel Only	Vehicles with diesel engine only: The fuel level has gone below the reserve mark.	▶ Refuel at the next gas station (▷ page 374). ▶ Only use commercially available vehicular ULTRA-LOW SULFUR HIGHWAY DIESEL FUEL (15 ppm SULFUR MAXIMUM).
	Tele Aid Inoperative	One or more main functions of the Tele Aid system are malfunctioning.	▶ Have the Tele Aid system checked by an authorized Mercedes-Benz Light Truck Center.
	Tele Aid Battery	The emergency power battery for the Tele Aid system is malfunctioning. If the vehicle battery is also malfunctioning or drained, Tele Aid will not be operational.	▶ Have the Tele Aid system checked by an authorized Mercedes-Benz Light Truck Center.
	Function unavailable	This display appears if button  or  on the multifunction steering wheel is pressed and the vehicle is not equipped with a telephone.	
	Top Up Washer Fluid	The fluid level has dropped to about $\frac{1}{3}$ of total reservoir capacity.	▶ Add washer fluid (▷ page 383).



### What to do if ...

Display symbol	Display message	Possible cause/consequence	Possible solution
	Tire Pressure(s) Please Correct	Vehicles with Advanced TPMS*: The pressure is too low in one or more tires.	▶ Check and correct tire inflation pressure as required.
	Tire Pressure Caution - Tire Defect	One or more tires are deflating.	▶ Carefully bring the vehicle to a halt, avoiding abrupt steering and braking maneuvers. ▶ If necessary, change the wheel.
	Caution: Tire Defect	One or more tires are deflating. Vehicles with Advanced TPMS*: The respective tire is indicated in the multifunction display.	▶ Carefully bring the vehicle to a halt, avoiding abrupt steering and braking maneuvers. ▶ If necessary, change the wheel.

### Warning!



Do not drive with a flat tire. A flat tire affects the ability to steer or brake the vehicle. You may lose control of the vehicle. Continued driving with a flat tire will cause excessive heat build-up and possibly a fire.

Display symbol	Display message	Possible cause/consequence	Possible solution
	Tire Pressure Check Tires	The tire pressure in one or more tires is already below the minimum value.	<ul style="list-style-type: none"> <li>▶ Carefully bring the vehicle to a halt, avoiding abrupt steering and braking maneuvers.</li> <li>▶ Check and adjust tire pressure as required (▷ page 395).</li> <li>▶ If necessary, change the wheel (▷ page 519).</li> </ul>
	Check Tires	<p>The tire pressure in one or more tires is already below the minimum value.</p> <p>Vehicles with Advanced TPMS*: The respective tire is indicated in the multifunction display.</p>	<ul style="list-style-type: none"> <li>▶ Carefully bring the vehicle to a halt, avoiding abrupt steering and braking maneuvers.</li> <li>▶ Check and adjust tire pressure as required (▷ page 395).</li> <li>▶ If necessary, change the wheel (▷ page 519).</li> </ul>

**Warning!**



Do not drive with a flat tire. A flat tire affects the ability to steer or brake the vehicle.

You may lose control of the vehicle. Continued driving with a flat tire will cause excessive heat build-up and possibly a fire.



### What to do if ...

Display symbol	Display message	Possible cause/consequence	Possible solution
	Level Selection Not Permitted	The selected vehicle level cannot adjust, because <ul style="list-style-type: none"> <li>• you are driving too fast for the desired vehicle level</li> <li>• you are towing a trailer</li> <li>• you are using accessories that are connected to the trailer power socket, e.g. a bicycle rack</li> </ul>	<ul style="list-style-type: none"> <li>▶ Reduce vehicle speed.</li> <li>▶ Set the desired vehicle level again (▷ page 279).</li> </ul>
	Malfunction	The air suspension is malfunctioning.	<ul style="list-style-type: none"> <li>▶ Do not drive faster than 50 mph (80 km/h) depending on the set vehicle level.</li> <li>▶ Have the vehicle checked at an authorized Mercedes-Benz Light Truck Center.</li> </ul>
	Compressor Cooling Down	You have selected a higher vehicle level. Due to frequent level changes within a short period, the compressor must first cool down.	<ul style="list-style-type: none"> <li>▶ Let the compressor cool until the message disappears.</li> </ul> <p>The selected level will be set once the compressor has cooled down.</p>

**!** When the message Compressor Cooling Down appears in the multifunction display, driving is still possible. Keep in mind that the

ride height of the vehicle is not yet reached, so you can damage the underbody of the vehicle.

The selected level will be set once the compressor has cooled.

Display symbol	Display message	Possible cause/consequence	Possible solution
	Rising Max. 20 MPH	The vehicle is adjusting to off-road level 3*.	▶ Do not drive faster than 20 mph (30 km/h).
	Max. 20 MPH	You are driving while using off-road level 3*. The message reminds you of the maximum speed at which you may drive with off-road level 3.	▶ Do not drive faster than 20 mph (30 km/h).
	Being Lowered Max. 20 MPH	The vehicle is being lowered from off-road level 3* to off-road level 2.	▶ Do not drive faster than 20 mph (30 km/h) until the off-road level 2 is reached.
	Reduce speed to under 20 MPH	You are driving too fast for the set vehicle level.	▶ Do not drive faster than 20 mph (30 km/h) until the off-road level 2 is reached.

**Warning!**



Adapt your driving style to the modified driving conditions. Avoid extreme, quick steering movements. Please keep in mind that the driving characteristics of the vehicle have been modified. You should therefore

drive in off-road level 3 with particular caution as it could otherwise lead to an accident and/or serious injury to you or others.

### What to do if ...

Display symbol	Display message	Possible cause/consequence	Possible solution
	Locking System Inoperative Service Required	The differential locks* are malfunctioning.	<ul style="list-style-type: none"> <li>▶ Do not drive faster than 50 mph (80 km/h).</li> <li>▶ Have the vehicle checked at an authorized Mercedes-Benz Light Truck Center.</li> </ul>
	Diff. Lock System Overheated - Wait briefly.	The differential locks* are too hot and have been deactivated as a result.	<ul style="list-style-type: none"> <li>▶ Continue driving with added caution. The lock function is unavailable.</li> <li>▶ Wait for the lock system to cool down. The differential locks will be reactivated as soon as they have cooled down.</li> </ul>
	Stop vehicle, engage parking brake.	A shifting procedure could not be completed. LOW RANGE* is in neutral position. There is no connection between the engine and the drive wheels.	<ul style="list-style-type: none"> <li>▶ Do not attempt to continue driving. You could otherwise damage the vehicle's drivetrain.</li> <li>▶ Stop the vehicle in a safe location or soon as it is safe to do so.</li> <li>▶ Engage the parking brake.</li> <li>▶ Perform the shifting procedure again (▷ page 202).</li> </ul>

Display symbol	Display message	Possible cause/consequence	Possible solution
	Service Required If parked engage pk. brake.	The LOW RANGE system* is malfunctioning.	<ul style="list-style-type: none"> <li>▶ Do not drive faster than 50 mph (80 km/h).</li> <li>▶ Engage the parking brake if parked.</li> <li>▶ Contact an authorized Mercedes-Benz Light Truck Center as soon as possible.</li> </ul>
	Max. Speed 25 MPH	Speed too high for shifting procedure.	▶ Continue driving more slowly.
	Max. Speed 40 MPH	Speed too high for shifting procedure.	▶ Continue driving more slowly.
	Shift briefly into N.	You have reduced engine speed. You may now carry out a shifting procedure.	▶ Briefly shift automatic transmission to position <b>N</b> .
	Shifting Process Canceled Reactivate	The shifting procedure was not carried out.	▶ Repeat the shifting procedure if desired.

### Where will I find ...?

#### First aid kit

**i** Check expiration dates and contents for completeness at least once a year and replace missing/expired items.

The first aid kit is located on the driver's side in the cargo compartment behind the cover.

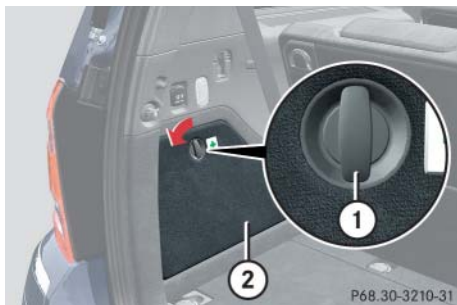

① Lock

② Cover in left side trim panel

▶ Turn lock ① 90° in direction of arrow.

▶ Fold down cover ②.

The first aid kit can be removed.

#### Vehicle tool kit

The vehicle tool kit is stored under the cargo compartment floor.

The vehicle tool kit includes:

- Towing eye bolt
- Wheel wrench
- Alignment bolt
- Vehicle jack
- Fuse chart
- Collapsible wheel chock
- Wheel bolts for spare wheel

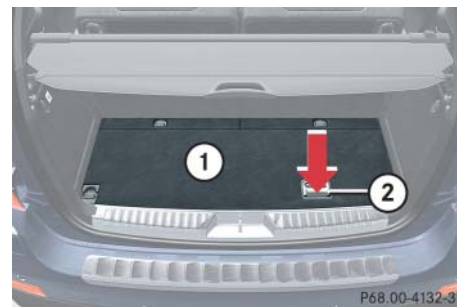

① Cargo compartment floor, lowered

② Handle cover

▶ Open the tailgate (▷ page 122).

▶ Push in handle cover ② as indicated by arrow and pull handle.

▶ Lift cargo compartment floor ①.

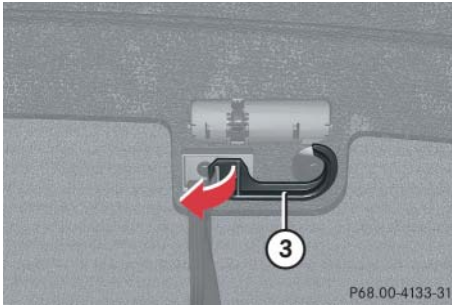

③ Securing hook

- ▶ Release securing hook ③ (located below the floor handle) from holder.

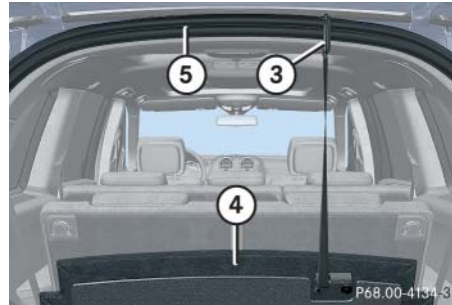

③ Securing hook

- ④ Cargo compartment floor, raised
- ⑤ Upper cargo compartment lip

- ▶ Engage securing hook ③ on upper cargo compartment lip ⑤.

**!** With the cargo compartment cover blind installed behind the third-row seats (▷ page 310), disengage cargo compartment cover blind and flip it forward. Otherwise the strap of the securing hook could damage the cargo compartment cover blind.

You can now access the vehicle tool kit. To remove the vehicle tool kit storage well casing, proceed as described on (▷ page 495).



### Where will I find ...?

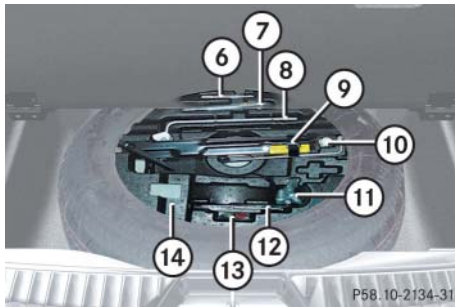

#### Example illustration<sup>1</sup>

- ⑥ Alignment bolt
- ⑦ Towing eye bolt
- ⑧ Wheel wrench
- ⑨ Hook and loop fastener
- ⑩ Vehicle jack<sup>2</sup>
- ⑪ Wheel bolts
- ⑫ Collapsible wheel chock
- ⑬ Fuse chart
- ⑭ Vehicle tool kit storage well casing

<sup>1</sup> Depending on production date, your vehicle may be equipped with a scissors-type vehicle jack. Thus, appearance and alignment of the items may vary.

<sup>2</sup> If your vehicle is equipped with a scissors-type vehicle jack, a reversible ratchet is also included.

- ▶ To remove vehicle jack ⑩, loosen hook and loop fastener ⑨.

**!** Depending on vehicle production date your vehicle may be equipped with a scissors-type jack (located under the cargo compartment floor). If so equipped, only use this jack when jacking up the vehicle as otherwise the vehicle's underbody can be damaged. See separate instructions for scissors-type jack.

**!** To prevent damage, always disengage the strap of the securing hook and lower the cargo compartment floor (▷ page 490) before closing the tailgate.

### Vehicle jack

#### Warning!



Only use the jack supplied with your vehicle to lift the vehicle briefly for wheel changes. If you use the jack for any other purpose, you or others could be injured, as the jack is designed only for the purpose of changing a wheel.

When using the jack, observe the safety notes in the "Mounting the spare wheel" section (▷ page 520) and the notes on the jack.

The vehicle jack is located underneath the cargo compartment floor.

### Screw-type vehicle jack

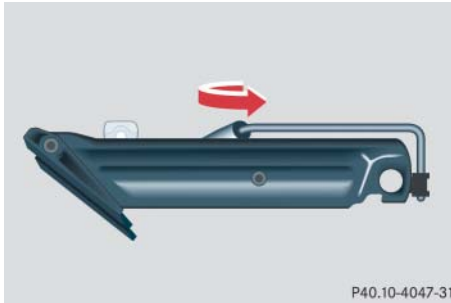

#### Storage position

- ▶ Turn crank handle in the direction of arrow as far as it will go.

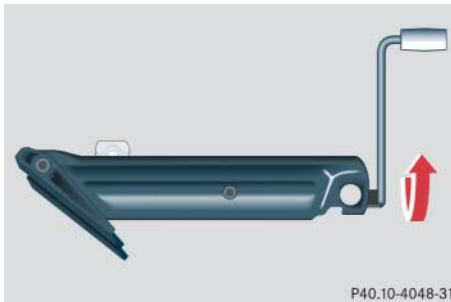

#### Operational position

- ▶ Turn crank handle clockwise.

Before storing the vehicle jack in its storage compartment:

- The vehicle jack should be fully collapsed.
- The handle must be folded in (storage position).

### Scissors-type vehicle jack

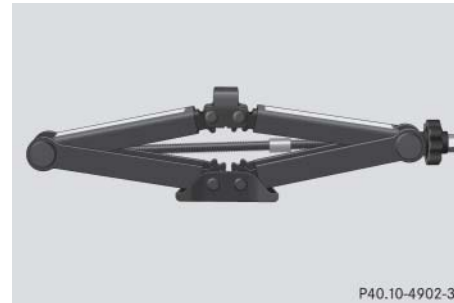

#### Storage position

- ▶ Take the reversible ratchet out of the vehicle tool kit.

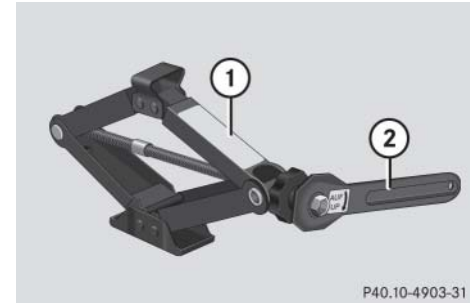

#### Operational position

- ① Scissors-type vehicle jack
- ② Reversible ratchet

- ▶ Attach reversible ratchet ② to vehicle jack in such a way that the word **UP** can be seen.

Before storing the vehicle jack in its storage compartment:

- It should be fully collapsed (storage position).
- The ratchet must be removed.

### Where will I find ...?

#### Setting up the collapsible wheel chock

The collapsible wheel chock serves to additionally secure the vehicle, e.g. while changing the wheel.

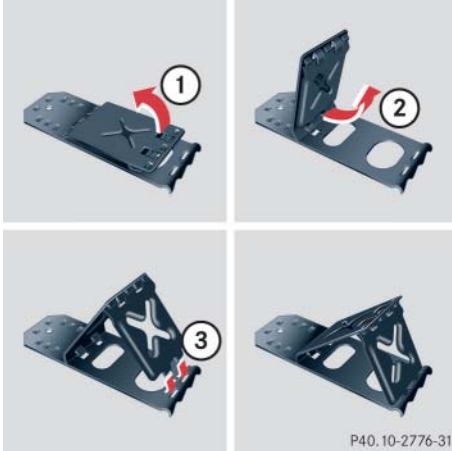

- ① Tilt the plate upward
- ② Fold the lower plate outward
- ③ Insert the plate

- ▶ Tilt both plates upward ①.
- ▶ Fold the lower plate outward ②.
- ▶ Guide the tabs of the lower plate all the way into the openings of base plate ③.

For information on where to place wheel chocks when changing a wheel, see “Lifting the vehicle” (> page 520).

#### Spare wheel

##### Warning!



The dimensions of the Minispare wheel are different from those of the road wheels. As a result, the vehicle handling characteristics change when driving with a Minispare wheel mounted. Adapt your driving style accordingly.

The Minispare wheel is for temporary use only. When driving with a Minispare wheel mounted, ensure proper tire inflation pressure and do not exceed a vehicle speed of 50 mph (80 km/h).

Drive to the nearest Mercedes-Benz Light Truck Center as soon as possible to have the Minispare wheel replaced with a regular road wheel.

Never operate the vehicle with more than one spare wheel mounted.

Do not switch off the ESP® when a Minispare wheel is mounted.

The Minispare wheel is located underneath the cargo compartment floor (▷ page 490).

**i** For information on how to mount the Minispare wheel, see “Mounting the spare wheel” (▷ page 520).

### Removing Minispare wheel

- ▶ Remove the jack from the vehicle tool kit (▷ page 492).

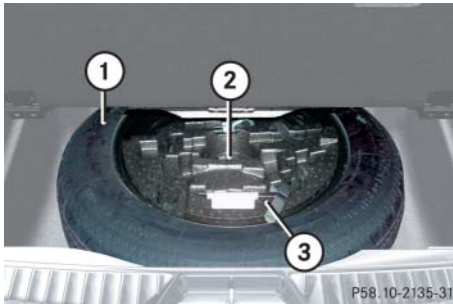

- ① Minispare wheel
- ② Retaining screw
- ③ Vehicle tool kit storage well casing

- ▶ Loosen retaining screw ② by turning it counterclockwise.

**i** If retaining screw ② does not come loose, turn vehicle tool kit storage well casing ③ slightly counterclockwise. Retaining screw ② should then come loose easily.

- ▶ Remove vehicle tool kit storage well casing ③.

You can now access the Minispare wheel.

- ▶ Remove Minispare wheel ①.

### Unlocking/locking in an emergency

#### Unlocking the vehicle

If you cannot unlock the vehicle with the SmartKey or KEYLESS-GO\*, open the driver's door using the mechanical key.

**i** *Unlocking the driver's door with the mechanical key will trigger the anti-theft alarm system.*

*To cancel the alarm, insert the SmartKey or SmartKey with KEYLESS-GO\* in the starter switch.*

#### Removing the mechanical key

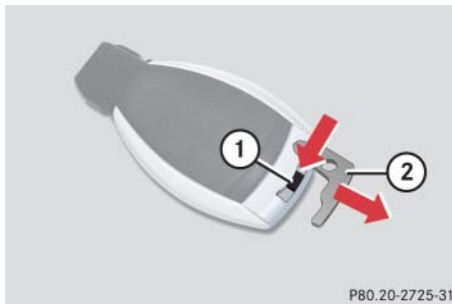

- ① Mechanical key locking tab
- ② Mechanical key

- ▶ Move locking tab ① in direction of arrow.  
The mechanical key ② comes out.
- ▶ Slide mechanical key ② out of the housing.

#### Unlocking the driver's door



- |   |                |
|---|----------------|
| 1 | Unlocking      |
| ② | Mechanical key |

- ▶ Insert mechanical key ② into the driver's door lock until it stops.
- ▶ Turn mechanical key ② counterclockwise to position ① and hold it there.
- ▶ Pull the door handle until the locking knob moves up (▷ page 120).  
The driver's door is unlocked.
- ▶ Pull the door handle once more to open the driver's door.

Unlocking/locking in an emergency

**Locking the vehicle**

If you cannot lock the vehicle with the SmartKey or KEYLESS-GO\*, lock the vehicle carrying out the following steps.

- ▶ Close the front passenger door, the rear right door and the tailgate.
- ▶ Open the driver's door and the rear left door.
- ▶ Press the central locking switch on the driver's door (▷ page 128).

The locking knobs of the front passenger door and the rear doors move down.

If the vehicle battery is disconnected or drained:

- ▶ Press down the locking knobs of the front passenger door and the rear doors manually.

- ▶ Exit the vehicle.
- ▶ Close the driver's door.
- ▶ Enter the vehicle through the rear left door.
- ▶ Press down the locking knob of the driver's door.

**!** *To prevent inadvertent lockout, make sure to have the SmartKey or SmartKey with KEYLESS-GO\* with you before proceeding with the next step. The next step will lock the vehicle.*

- ▶ Exit the vehicle.
  - ▶ Close the rear left door.
- The vehicle is locked.

**i** *This procedure does not arm the anti-theft alarm system, nor does it lock the fuel filler flap.*

**Fuel filler flap**

- ▶ Open the tailgate (▷ page 122).

The fuel filler flap release is located behind a cover in the right side trim panel of the cargo compartment.

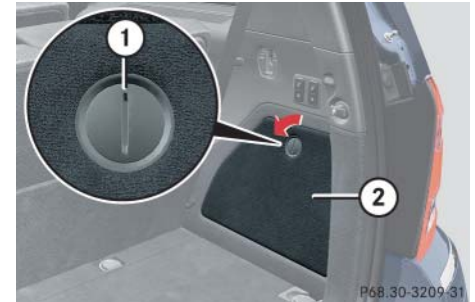

- ① Lock
- ② Cover



### Unlocking/locking in an emergency

- ▷▷ Insert a suitable object such as a coin into the slot of lock ① (▷ page 497).
- ▶ Turn lock ① counterclockwise by 90° in direction of arrow.
- ▶ Remove cover ② (▷ page 497).
- ▶ Pull red fuel filler flap release ③ in direction of arrow.
- ▶ The fuel filler flap is unlocked.
- ▶ Open the fuel filler door (▷ page 374).

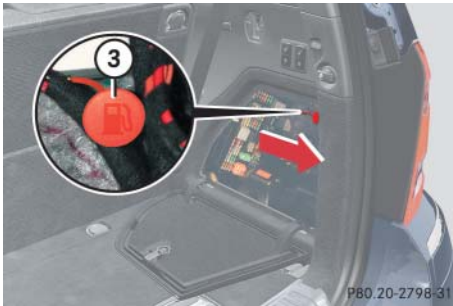

③ Fuel filler flap release

Resetting activated head restraints

▼ **Resetting activated head restraints**

If the active head restraints have been triggered in a rear-end collision, the active head restraints must be reset. Otherwise, the active head restraints cannot offer any additional protection in the event of another rear-end collision.

You can tell that the head restraints have been activated when they have been moved forward and cannot be adjusted.

**Warning!**



For safety reasons, have the active head restraints checked by an authorized Mercedes-Benz Light Truck Center after a rear-end collision.

**Warning!**



When pushing back the head restraint cushion, take care that your fingers do not become caught between the head restraint cushion and the cover. Failing to do so may lead to injury.

**!** *Be careful not to damage upholstery.*

**i** *For your convenience, we recommend that you have this work carried out by an authorized Mercedes-Benz Light Truck Center.*

**Vehicles without Rear seat entertainment system\***

**i** *Pressing the head restraint cushion back requires high force. If you encounter difficulties when pushing the head restraint back please have the procedure performed at an authorized Mercedes-Benz Light Truck Center.*



- ① Pull
- ② Adjust downward
- ③ Press

- ▶ Pull the top of the head restraint cushion in direction of arrow ① as far as it will go.
- ▶ Adjust the head restraint cushion downward in direction of arrow ② as far as it will go.
- ▶ Firmly press the top of the active head restraint cushion towards the head restraint cover in direction of arrow ③ until it engages.





### Resetting activated head restraints

- ▷▷▶ Repeat this procedure on the active head restraint for the second front seat.

For information on active head restraints, see “Active head restraint” (▷ page 90).

For information on head restraint adjustment, see “Seats” (▷ page 45).

### Vehicles with Rear seat entertainment system\*

- ▶ Take the reset tool out of the Mercedes-Benz vehicle literature pouch.

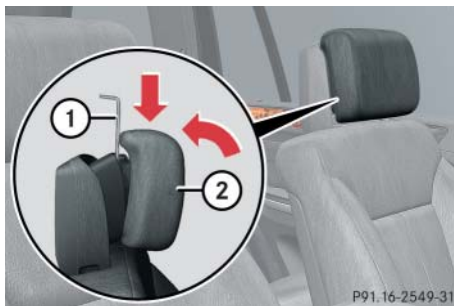

- ① Reset tool
- ② Active head restraint

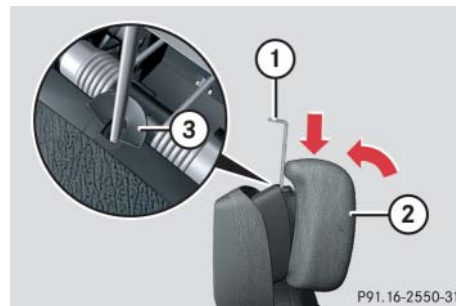

- ① Reset tool
  - ② Active head restraint
  - ③ Rectangular opening
- ▶ Guide reset tool ① into rectangular opening ③ of active head restraint ②.
  - ▶ Press reset tool ① downward in direction of arrow until you hear the head restraint release mechanism audibly disengage.
  - ▶ Pull out reset tool ①.

- ▶ Firmly press the active head restraint cushion backward towards the head restraint cover in direction of arrow until it engages.
- ▶ Repeat this procedure on the active head restraint for the second front seat.
- ▶ After resetting the active head restraints store reset tool ① in the Mercedes-Benz vehicle literature pouch.

For information on active head restraints, see “Active head restraint” (▷ page 90).

For information on head restraint adjustment, see “Seats” (▷ page 45).

### Replacing SmartKey batteries

If the batteries in the SmartKey or the SmartKey with KEYLESS-GO\* are discharged, the vehicle can no longer be locked or unlocked. It is recommended to have the batteries replaced at an authorized Mercedes-Benz Light Truck Center.

#### Warning!



Keep the batteries out of reach of children.  
If a battery is swallowed, seek medical help immediately.

Batteries contain materials that can harm the environment if disposed of improperly. Recycling of batteries is the preferred method of disposal. Many states require sellers of batteries to accept old batteries for recycling.

**i** When inserting the batteries, make sure they are clean and free of lint.

**i** When replacing batteries, always replace both batteries.

*The required replacement batteries are available at any Mercedes-Benz Light Truck Center.*

Replacement batteries: Lithium, type CR 2025 or equivalent.

- ▶ Remove mechanical key ① from the SmartKey or SmartKey with KEYLESS-GO\* (▷ page 496).

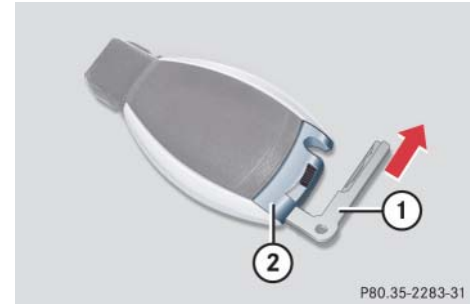

- ① Mechanical key
- ② Battery compartment

- ▶ Insert mechanical key ① into opening.
- ▶ Press mechanical key ① in direction of arrow.  
The battery compartment ② is unlatched.
- ▶ Pull battery compartment ② out of the SmartKey housing.

## Replacing SmartKey batteries

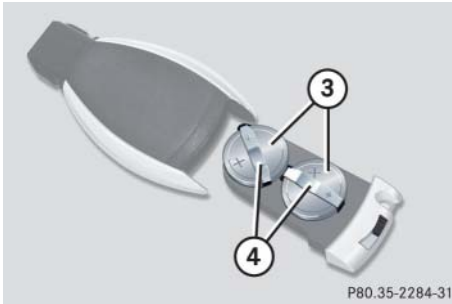

- ③ Batteries
- ④ Contact spring

- ▶ Pull out batteries ③.
- ▶ Using a line-free cloth, insert new batteries ③ under contact springs ④ with the positive terminal (+) side facing up.
- ▶ Return battery compartment ② into housing until it locks into place.
- ▶ Slide mechanical key ① back into the SmartKey or SmartKey with KEYLESS-GO\*.
- ▶ Check the operation of the SmartKey or SmartKey with KEYLESS-GO\*.

### Replacing bulbs

#### Bulbs

---

Safe vehicle operation depends on proper exterior lighting and signaling. It is therefore essential that all bulbs and lamp assemblies are in good working order at all times.

Correct headlamp adjustment is extremely important. Have headlamps checked and readjusted at regular intervals and when a bulb has been replaced. See an authorized Mercedes-Benz Light Truck Center for headlamp adjustment.

**i** *If the headlamps or front fog lamps are fogged up on the inside as a result of high humidity, driving the vehicle a distance with the lights on should clear up the fogging.*

**i** *Substitute bulbs will be brought into use when the following lamps malfunction:*

- *Turn signal lamps*
- *Brake lamps*
- *Parking lamps*
- *Tail lamps*

*Read and observe the messages in the multi-function display (▷ page 477).*

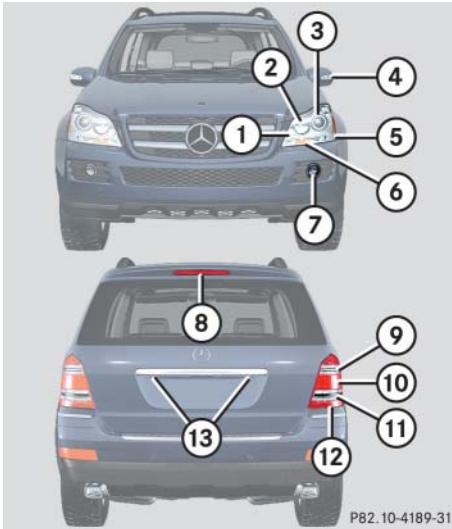

Front lamps

	Lamp	Type
①	Parking and standing lamp	W 5 W
②	Headlamps: High beam/high beam flasher	H7 (55 W)
	Bi-Xenon headlamps*: High beam/high beam flasher spot lamp	H7 (55 W)
③	Headlamps: Low beam	H7 (55 W)
	Bi-Xenon headlamps*: Low beam <sup>1</sup>	D1S-35 W
④	Additional turn signal lamp	LED
⑤	Side marker lamp	WY 5 W

<sup>1</sup> Vehicles with Bi-Xenon\* headlamps: Do not replace the Bi-Xenon bulbs yourself. Contact an authorized Mercedes-Benz Light Truck Center.

	Lamp	Type
⑥	Turn signal lamp	3457 AK S-8 (30/2.2 cp bulb)
⑦	Front fog lamp	H11 (55 W)
	Corner-illuminating front fog lamp*	H11 (55 W)

Rear lamps

	Lamp	Type
⑧	High mounted brake lamp	LED
⑨	Backup lamp	P 21 W
⑩	Tail, brake, parking, standing, side marker lamp	P 21/4 W
⑪	Turn signal lamp	PY 21 W
⑫	Rear fog lamp (driver's side only)	P 21/4 W
⑬	License plate lamps	C 5 W

### Replacing bulbs

#### Warning!



Bulbs and bulb sockets can be very hot. Allow the lamp to cool down before changing a bulb.

Keep bulbs out of reach of children.

Halogen lamps contain pressurized gas.

A bulb can explode if you:

- touch or move it when hot
- drop the bulb
- scratch the bulb

Wear eye and hand protection.

Because of high voltage in Xenon lamps, it is dangerous to replace the bulb or repair the lamp and its components. We recommend that you have such work done by a qualified technician.

#### Notes on bulb replacement

- Only use 12-volt bulbs of the same type and with the specified watt rating.
- Switch lights off before changing a bulb to prevent short circuits.
- Always use a clean lint-free cloth when handling bulbs.
- Your hands should be dry and free of oil and grease.
- If the newly installed bulb does not come on, visit an authorized Mercedes-Benz Light Truck Center.

Have the LEDs and bulbs for the following lamps replaced by an authorized Mercedes-Benz Light Truck Center:

- the additional turn signal lamps in the exterior rear view mirrors
- the high mounted brake lamp
- the Bi-Xenon\* low beam lamps
- the Bi-Xenon high beam flasher spotlight\*

**!** *Do not replace the LEDs yourself. You could otherwise damage the LEDs or parts of the vehicle. Only have the LEDs replaced by an authorized Mercedes-Benz Light Truck Center.*

**i** *Replacing the bulbs for the front lamps is a technically complex process. For your convenience, we recommend that you have this work carried out by an authorized Mercedes-Benz Light Truck Center.*

*Have the headlamp adjustment checked regularly.*

### Replacing bulbs for front lamps

Before you start to replace a bulb for a front lamp, do the following first:

- ▶ Turn the exterior lamp switch to position **0** (▷ page 143).
- ▶ Open the hood (▷ page 378).

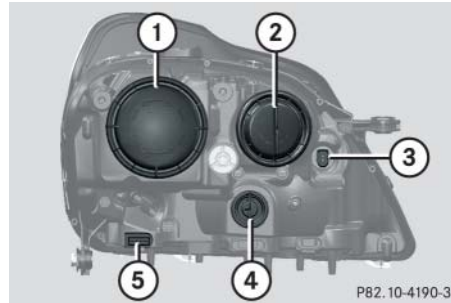

- ① Housing cover for low beam halogen headlamp
- ② Housing cover for high beam halogen bulb (high beam and high beam flasher)
- ③ Bulb socket for parking and standing lamp bulb
- ④ Bulb socket for turn signal lamp bulb
- ⑤ Bulb socket for side marker lamp bulb

### Low beam bulb (halogen headlamp)

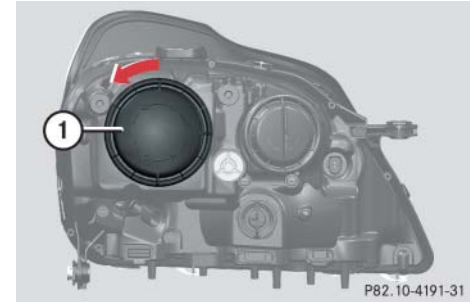

- ① Low beam headlamp cover

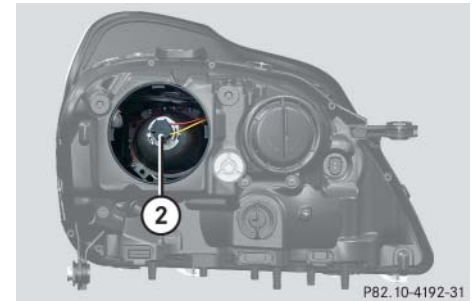

- ② Bulb socket for low beam headlamp



### Replacing bulbs

- ▶ Turn cover ① counterclockwise.
- ▶ Remove cover ①.
- ▶ Turn bulb socket ② counterclockwise.
- ▶ Pull bulb socket ② out of the headlamp housing.
- ▶ Pull the low beam bulb out of bulb socket ②.
- ▶ Insert the new low beam bulb into bulb socket ②.
- ▶ Insert bulb socket ② into the headlamp housing.
- ▶ Turn bulb socket ② clockwise until it engages.
- ▶ Place cover ① on the opening in the headlamp housing.
- ▶ Turn cover ① clockwise until it engages.

### Bi-Xenon\* low beam/high beam headlamp

#### Warning!



Do not remove the low beam/high beam cover for the Bi-Xenon\* headlamp. Because of high voltage in Xenon\* lamps, it is dangerous to replace the bulb or repair the lamp and its components. We recommend that you have such work done by a qualified technician.

### High beam bulb (halogen headlamp)

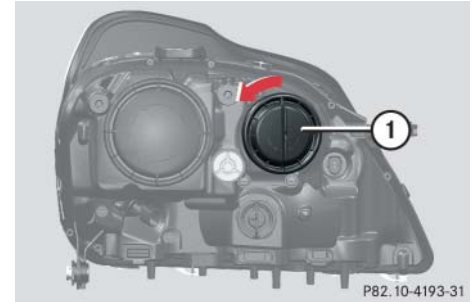

① High beam headlamp cover

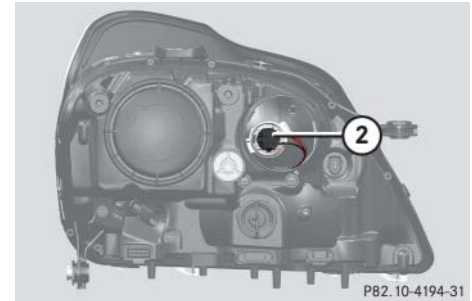

② Bulb socket for high beam headlamp

- ▶ Turn cover ① counterclockwise.
- ▶ Remove cover ①.
- ▶ Turn bulb socket ② counterclockwise.
- ▶ Pull bulb socket ② out of the headlamp housing.
- ▶ Pull the high beam bulb out of bulb socket ②.
- ▶ Insert the new high beam bulb into bulb socket ②.
- ▶ Insert bulb socket ② into the headlamp housing.
- ▶ Turn bulb socket ② clockwise until it engages.
- ▶ Place cover ① on the opening in the headlamp housing.
- ▶ Turn cover ① clockwise until it engages.

### Turn signal lamp bulb

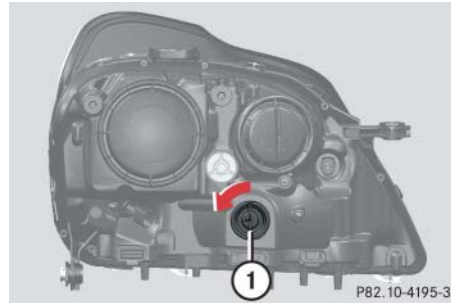

- ① Bulb socket for turn signal lamp
- ▶ Turn bulb socket ① counterclockwise.
- ▶ Pull bulb socket ① out of the headlamp housing.
- ▶ Pull the turn signal bulb out of bulb socket ①.
- ▶ Insert the new turn signal bulb into bulb socket ①.
- ▶ Insert bulb socket ① into the headlamp housing.
- ▶ Turn bulb socket ① clockwise until it engages.

### Parking and standing lamp bulb

- ▶ Turn bulb socket ③ (> page 507) counterclockwise.
- ▶ Pull bulb socket ③ out of the headlamp housing.
- ▶ Pull the bulb out of bulb socket ③.
- ▶ Insert the new bulb into bulb socket ③.
- ▶ Insert bulb socket ③ into the headlamp housing.
- ▶ Turn bulb socket ③ clockwise until it engages.

### Replacing bulbs

#### Side marker lamp bulb

- ▶ Turn bulb socket ⑤ (▷ page 507) counterclockwise.
- ▶ Pull bulb socket ⑤ out of the headlamp housing.
- ▶ Pull the side marker bulb out of bulb socket ⑤.
- ▶ Insert the new side marker bulb into bulb socket ⑤.
- ▶ Insert bulb socket ⑤ into the headlamp housing.
- ▶ Turn bulb socket ⑤ clockwise until it engages.

#### Front fog lamp bulbs

**!** *If not done carefully and properly, damage to the bumper can result. We therefore recommend that you have this work carried out by an authorized Mercedes-Benz Light Truck Center.*

Removing front fog lamp cover:

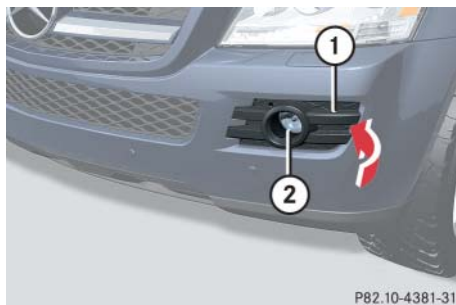

- ① Cover
- ② Front fog lamp or corner-illuminating front fog lamp\*

- ▶ Insert a suitable object (e.g. screwdriver) at point indicated by the arrow and pry out cover ①.

Cover ① is released.

- ▶ Swing cover ① outwards and take it off.

You can now access the front fog lamp.

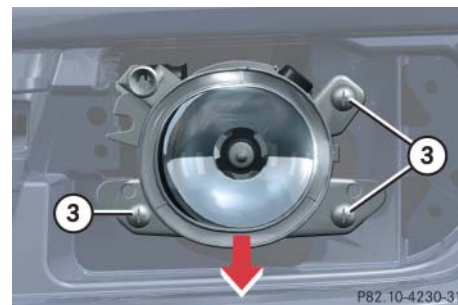

- ③ Retaining screws
- ▶ Turn retaining screws ③ counterclockwise.
- ▶ Remove front fog lamp ② out of the bumper.
- ▶ Pull electrical connector off.

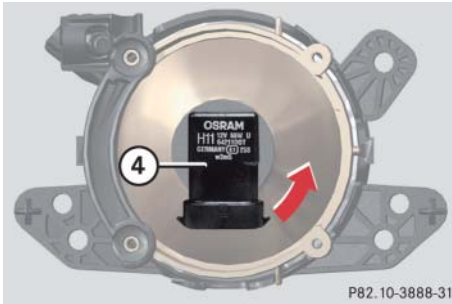

④ Bulb socket of front fog lamp bulb

- ▶ Turn bulb socket ④ counterclockwise.
- ▶ Pull bulb socket ④ out of the housing.
- ▶ Pull the front fog lamp bulb out of bulb socket ④.
- ▶ Insert the new front fog lamp bulb into bulb socket ④.
- ▶ Insert bulb socket ④ into the housing.

- ▶ Turn bulb socket ④ clockwise until it engages.
- ▶ Plug in the electrical connector.
- ▶ Insert front fog lamp ② back into bumper.
- ▶ Fasten retaining screws ③.
- ▶ Reinsert cover ① and press it in until it engages.

### Additional turn signal lamps bulbs

The additional turn signal lamps in the exterior rear view mirrors have LEDs.

If a malfunction occurs or LEDs fail to function, the entire turn signal unit must be replaced. Have the turn signal unit replaced by an authorized Mercedes-Benz Light Truck Center.

### Replacing bulbs for rear lamps

Before you start to replace a bulb for a rear lamp, do the following first:

- ▶ Turn the exterior lamp switch to position **0** (▷ page 143).

### Tail lamp unit

**i** To access the bulb socket, you have to remove the cover in the corresponding side trim panel of the cargo compartment.

- ▶ Open the tailgate (▷ page 122).

### Replacing bulbs

#### Opening the side trim panels

Opening the driver's side trim panel:

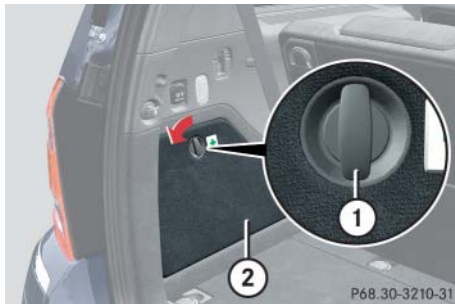

- ① Lock
- ② Cover in left side trim panel
- ▶ Turn lock ① 90° in direction of arrow.
- ▶ Fold down cover ②.

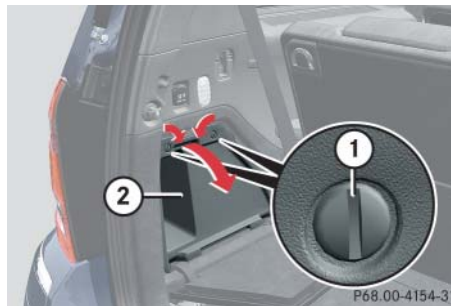

- ① Lock
- ② Storage compartment
- ▶ Insert a suitable object such as a coin into the slot of lock ①.
- ▶ Turn lock ① counterclockwise by 90° in direction of arrow.
- ▶ Remove storage compartment ②.

Opening the passenger side trim panel:

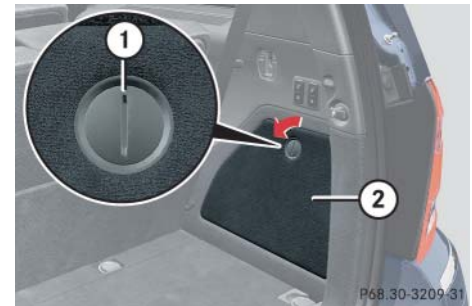

- ① Lock
- ② Cover in right side trim panel
- ▶ Insert a suitable object such as a coin into the slot of lock ①.
- ▶ Turn lock ① counterclockwise by 90° in direction of arrow.
- ▶ Remove cover ②.

**Replacing bulbs**

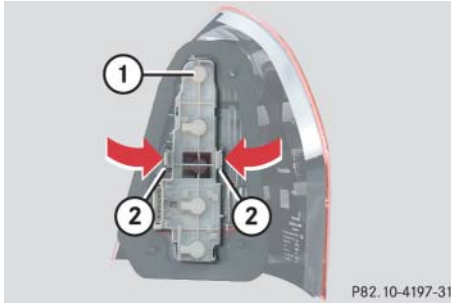

P82.10-4197-31

- ① Bulb socket
- ② Clamp
- ▶ Press and hold clamps ②.
- ▶ Pull bulb socket ① outwards.

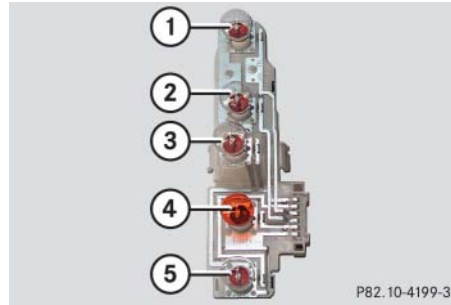

P82.10-4199-31

**Bulb socket**

- ① Backup lamp
- ② Tail lamp, brake lamp, parking and standing lamp
- ③ Tail lamp, brake lamp, parking and standing lamp, side marker lamp
- ④ Turn signal lamp
- ⑤ Rear fog lamp (driver's side only)
- ▶ Depending on which bulb needs to be replaced, turn the respective bulb ① - ⑤ counterclockwise.

- ▶ Pull the bulb out of the housing.
- ▶ Insert the new bulb into the bulb socket.
- ▶ Turn the bulb in the bulb socket clockwise carefully.
- ▶ Insert the bulb socket into the rear lamp.
- ▶ Align bulb socket and press bulb socket into rear lamp until it audibly engages.
- ▶ Make sure bulb socket is attached properly.
- ▶ Close the respective cover in the cargo compartment.
- ▶ Close the tailgate (▷ page 123).

### Replacing bulbs

#### License plate lamp

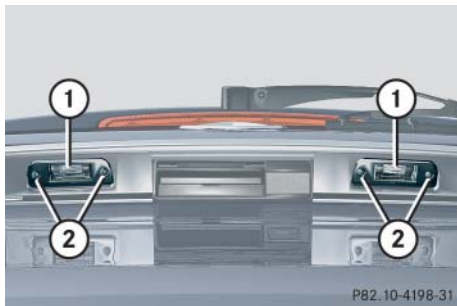

- ① License plate lamp cover
- ② Screws

- ▶ Loosen screws ②.
- ▶ Remove license plate lamp cover ①.
- ▶ Replace the tubular bulb.
- ▶ Reinstall license plate lamp cover ①.
- ▶ Retighten screws ②.

#### Adjusting headlamp aim

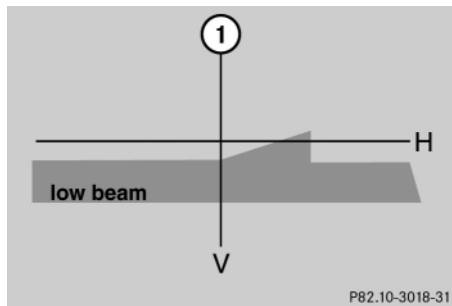

- V** Vertical centerline
- H** Headlamp mounting height, measured from the center

**i** High beam adjustments simultaneously aim the low beam.

Vehicle should have a normal tailgate load.

Correct headlamp adjustment is extremely important. To check and readjust a headlamp, follow the steps described:

- ▶ Park the vehicle on a level surface 25 feet (7.6 m) from a vertical test screen or wall.
- ▶ Switch the headlamps on (▷ page 143).

If the beam does not show a beam pattern as indicated in the figure left, then follow the steps below:

- ▶ Open hood (▷ page 378).

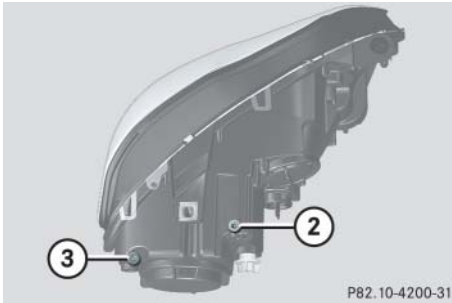

**Example illustration headlamp, driver's side**

- ② Headlamp vertical adjustment screw
- ③ Headlamp vertical adjustment screw

- ▶ Always turn adjustment screws ② and ③ simultaneously for vertical adjustment until the headlamp is adjusted as shown ① (▷ page 514). Turn clockwise for upward movement and counterclockwise for downward movement.

Graduations:

screw ②: 0.50° pitch

screw ③: 0.67° pitch

The left and right headlamps must be adjusted individually.

**i** *If it is not possible to obtain a proper headlamp adjustment, have the system checked at an authorized Mercedes-Benz Light Truck Center.*



### Replacing wiper blades

#### Front wiper blades

##### Warning!



For safety reasons, switch off wipers and remove SmartKey from starter switch (vehicles with KEYLESS-GO\*): Make sure the vehicle's on-board electronics have status **0** before replacing a wiper blade. Otherwise the motor could suddenly turn on and cause injury.

##### Warning!



Wiper blades are components that are subject to wear and tear. Replace the wiper blades twice a year, preferably in the spring and fall. Otherwise the windows will not be properly wiped. As a result, you may not be able to observe surrounding traffic conditions and could cause an accident.

**!** *Never open the hood when the wiper arms are folded forward.*

*Hold on to the wiper when folding the wiper arm back. If released, the force of the impact from the tensioning spring could crack the windshield.*

*Do not allow the wiper arms to contact the windshield glass without a wiper blade inserted.*

*Make sure the wiper blades are properly installed. Improperly installed wiper blades may cause windshield damage.*

*For your convenience, we recommend that you have this work carried out by an authorized Mercedes-Benz Light Truck Center.*

#### Removing

- ▶ Remove the SmartKey from the starter switch.

Vehicles with KEYLESS-GO\*:

- ▶ Make sure the vehicle's on-board electronics have status **0** (▷ page 44).

**!** *Do not pull on the wiper blade inserts. They could tear.*

- ▶ Fold the wiper arms forward until they engage.

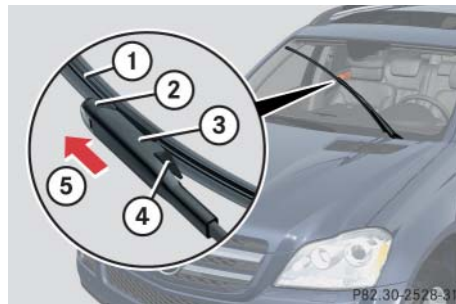

- ① Wiper blade
- ② Cover
- ③ Attachment
- ④ Tab
- ⑤ Removing

- ▶ Press tabs ④ together and tilt wiper blade ① to detach tabs ④ on both recesses of attachment ③.

Wiper blade ① is released on one end.

- ▶ Maintaining its tilted position, slide wiper blade ① out of attachment ③ in direction of arrow ⑤.

## Replacing wiper blades

### Installing

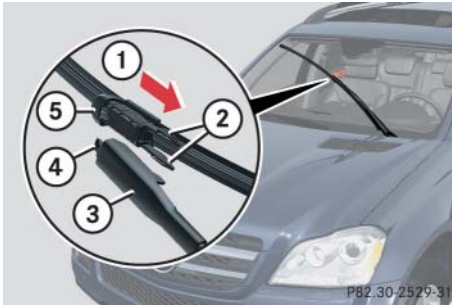

- ① Installing
- ② Tab
- ③ Attachment
- ④ Guide tab
- ⑤ Cover

- ▶ Slide the wiper blade into attachment ③ in direction of arrow ①.
- ▶ Make sure guide tab ④ will be placed under cover ⑤ when fully inserting the wiper blade into attachment.
- ▶ Let tab ② latch into both recesses of attachment ③.

- ▶ Check if the wiper blade is securely fastened.
- ▶ Fold the wiper arm backward to rest on the windshield.

Make sure you hold on to the wiper arm when folding it back.

### Rear wiper blade

#### Warning!



For safety reasons, switch off wipers and remove SmartKey from starter switch (vehicles with KEYLESS-GO\*: Make sure the vehicle's on-board electronics have status **0**) before replacing a wiper blade. Otherwise the motor could suddenly turn on and cause injury.

**!** Hold on to the wiper when folding the wiper arm back. If released, the force of the impact from the tensioning spring could crack the rear window.

Do not allow the wiper arm to contact the rear window glass without a wiper blade inserted.

Make sure the wiper blade is properly installed. Improperly installed wiper blades may cause rear window damage.

For your convenience, we recommend that you have this work carried out by an authorized Mercedes-Benz Light Truck Center.

### Replacing wiper blades

#### Removing

- ▶ Remove the SmartKey from the starter switch.

Vehicles with KEYLESS-GO\*:

- ▶ Make sure the vehicle's on-board electronics have status **0** (▷ page 44).

**!** Do not pull on the wiper blade insert. It could tear.

- ▶ Fold wiper arm ① away from the rear window until it engages.

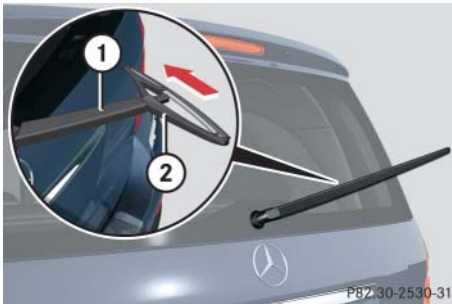

- ① Wiper arm
- ② Wiper blade

- ▶ Turn wiper blade ② to form a right angle with wiper arm ① as shown.
- ▶ Hold wiper arm ① and disengage wiper blade ② by carefully sliding it in direction of arrow.
- ▶ Remove wiper blade ②.

#### Installing

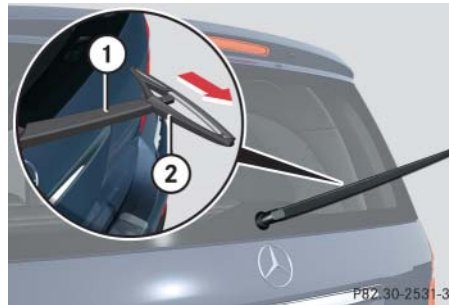

- ① Wiper arm
- ② Wiper blade

- ▶ Insert wiper blade ② into wiper arm ①.

- ▶ Hold wiper arm ① and engage wiper blade ② by pushing it in direction of arrow until it locks into place.
- ▶ Check whether the wiper blade is securely fastened.
- ▶ Fold the wiper arm to rest on the rear window.

Make sure to hold on to the wiper when folding the wiper arm back.

## ▼ Flat tire

**Warning!**

The dimensions of the Minispare wheel are different from those of the road wheels. As a result, the vehicle handling characteristics change when driving with a Minispare wheel mounted. Adapt your driving style accordingly.

The Minispare wheel is for temporary use only. When driving with a Minispare wheel mounted, ensure proper tire pressure and do not exceed a vehicle speed of 50 mph (80 km/h).

Drive to the nearest Mercedes-Benz Light Truck Center as soon as possible to have the Minispare wheel replaced with a regular road wheel.

Never operate the vehicle with more than one spare wheel mounted.

Do not switch off the ESP® when a Minispare wheel is mounted.

**Preparing the vehicle**

- ▶ Make sure the vehicle level is set to highway (▷ page 279).

**Warning!**

Your vehicle is equipped with air suspension. Do not open or close any doors or the tailgate while mounting a spare wheel. The vehicle could rise or lower to a previously selected level. You or others could be injured as a result.

- ▶ Park the vehicle in a safe distance from moving traffic on a hard, flat surface when possible.
- ▶ Turn on the hazard warning flasher (▷ page 149).

- ▶ Turn the steering wheel so that the front wheels are in a straight-ahead position.
  - ▶ Set the parking brake (▷ page 59).
  - ▶ Set the automatic transmission to park position **P** (▷ page 191).
  - ▶ Turn off the engine (▷ page 41).
  - ▶ Have any passenger exit the vehicle at a safe distance from the roadway.
-  *Open door only when conditions are safe to do so.*
- ▶ Vehicles with SmartKey: Remove the SmartKey from the starter switch.
- Vehicles with KEYLESS-GO\*: Open the driver's door (this puts the starter switch in position **O**, same as with the SmartKey removed from the starter switch). The driver's door then can be closed again.
- ▶ Remove the KEYLESS-GO\* start/stop button from the starter switch.

### Flat tire

#### Mounting the spare wheel

##### Preparing the vehicle

- ▶ Prepare the vehicle as described (▷ page 519).
- ▶ Take the wheel wrench, the collapsible wheel chock, and the vehicle jack out of the cargo compartment (▷ page 490).
- ▶ Take the Minispare wheel out of the cargo compartment (▷ page 495).

**!** *Depending on vehicle production date your vehicle may be equipped with a scissors-type jack (located under the cargo compartment floor). If so equipped, only use this jack when jacking up the vehicle as otherwise the vehicle's underbody can be damaged. See separate instructions for scissors-type jack.*

#### Lifting the vehicle

##### Warning!



When jacking up the vehicle, only use the jack which has been specifically approved by Mercedes-Benz for your vehicle.

The jack is designed exclusively for jacking up the vehicle at the jack take-up brackets built into both sides of the vehicle. Make sure the jack arm is fully seated in the jack take-up bracket.

The jack is intended only for lifting the vehicle briefly for wheel changes. It is not suited for performing maintenance work under the vehicle. To help avoid personal injury, use the jack only to lift the vehicle during a wheel change.

Never get beneath the vehicle while it is supported by the jack. Keep hands and feet away from the area under the lifted vehicle. Always lower the vehicle onto sufficient capacity jackstands before working under the vehicle.

Always firmly set parking brake and block wheels with wheel chocks or other sizeable objects before raising vehicle with jack. Do not disengage parking brake while the vehicle is raised.

Make sure that the ground on which the vehicle is standing and where you place the jack is solid, level and not slippery. If necessary, use a large underlay. On slippery surfaces, such as tiled floors, you should use a non-slip underlay, for example a rubber mat.

Do not use wooden blocks or similar objects to support the jack. Otherwise the jack may not be able to achieve its load-bearing capacity if it is not at its full height.

Never start the engine when the vehicle is raised.

Also observe the notes on the jack.

- ▶ Prevent the vehicle from rolling away by blocking wheels with wheel chocks or other sizeable objects.

One collapsible wheel chock is included with the vehicle tool kit (▷ page 490). For information on setting up the collapsible wheel chock, see (▷ page 494).

**Warning!**



Only jack up the vehicle on level ground or on slight inclines/declines. Otherwise, the vehicle could fall off the jack and injure you or others.

**Changing wheel on a level surface**

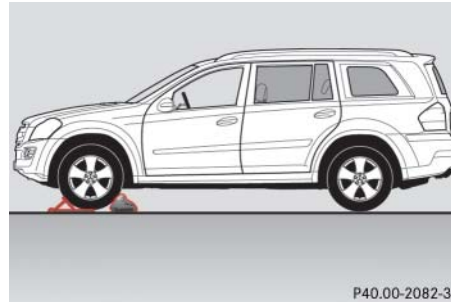

**Changing rear wheel on passenger side (Example illustration)**

- ▶ Place the wheel chock in front of and another sizeable object behind the wheel that is diagonally opposite to the wheel being changed.

**Changing wheel on a slight decline**

Always try lifting the vehicle using the jack on a level surface. However, should circumstances require you to do so on a slight decline, place the wheel chock and another sizeable object as follows:

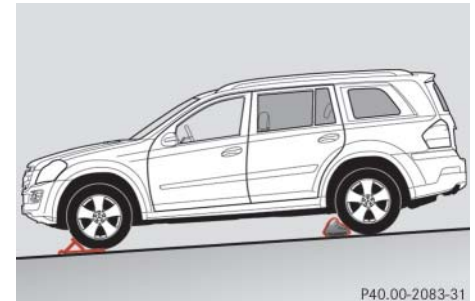

**Changing wheel on passenger side (Example illustration)**

- ▶ Place wheel chock (or another sizeable object) in front of both wheels on the side opposite to the side on which the wheel is to be changed.

### Flat tire

#### *Changing wheel on a slight incline*

Always try lifting the vehicle using the jack on a level surface. However, should circumstances require you to do so on a slight incline, place the wheel chock and another sizeable object as follows:

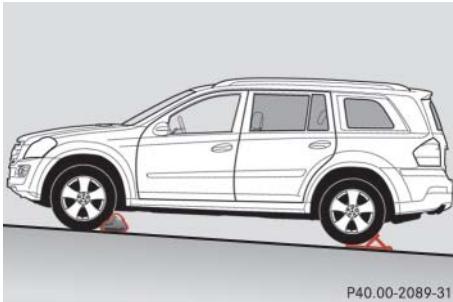

#### **Changing wheel on passenger side (Example illustration)**

- ▶ Place wheel chock (or another sizeable object) behind both wheels on the side opposite to the side on which the wheel is to be changed.



#### ① Wheel wrench

- ▶ On wheel to be changed, loosen but do not yet remove the wheel bolts (approximately one full turn with wheel wrench ①).

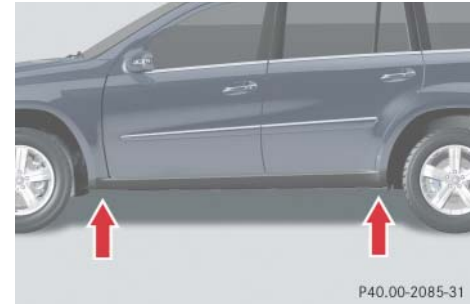

The jack take-up brackets are located directly behind the front wheel housings and in front of the rear wheel housings as indicated by the arrows.

**Warning!**



The jack is designed exclusively for jacking up the vehicle at the jack take-up brackets. Make sure the jack arm is fully seated in the jack take-up bracket.

If you do not position the jack correctly in the jack take-up bracket, the vehicle can:

- fall off the jack
- seriously or fatally injure you or others

**!** Do not position the jack on the body of the vehicle, as this may cause damage to the vehicle.

Depending on production date, your vehicle may be equipped with either a screw-type vehicle jack or a scissors-type jack, see “Vehicle jack” (> page 492).

**!** Depending on vehicle production date your vehicle may be equipped with a scissors-type jack (located under the cargo compartment floor). If so equipped, only use this jack when jacking up the vehicle as otherwise the vehicle’s underbody can be damaged. See separate instructions for scissors-type jack.

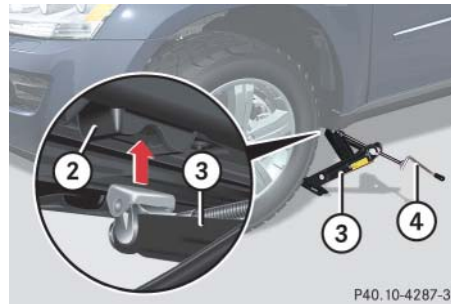

**Screw-type jack**

- ② Take-up bracket
- ③ Jack
- ④ Crank

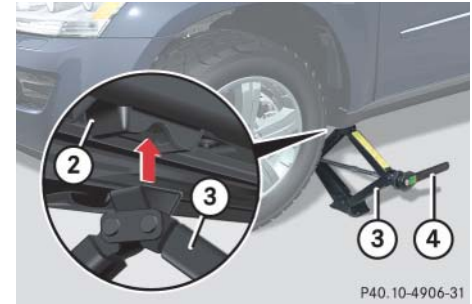

**Scissors-type jack**

- ② Take-up bracket
- ③ Jack
- ④ Ratchet

- ▶ **Vehicles with scissors-type jack:**  
Attach reversible ratchet ④ to vehicle jack in such a way that the word **UP** can be seen.
- ▶ Place jack ③ on firm ground.
- ▶ Position jack ③ under the take-up bracket ② so that it is always vertical (plumb-line) as seen from the side, even if the vehicle is parked on an incline.





## Flat tire

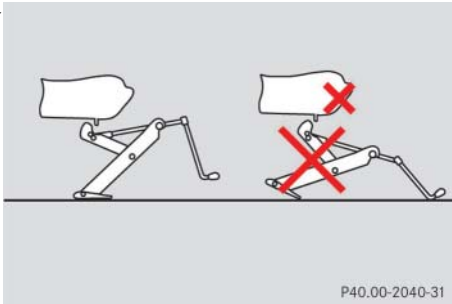

P40.00-2040-31

**Screw-type jack (example illustration)**

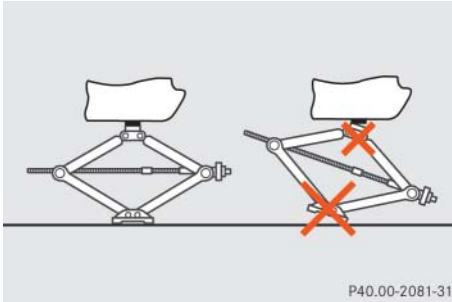

P40.00-2081-31

**Scissors-type jack (example illustration)**

- ▶ **Vehicles with screw-type jack:** Turn crank ④ clockwise until jack ③ is fully seated in take-up bracket ② and the jack base evenly meets the ground.
- ▶ **Vehicles with scissors-type jack:** Turn ratchet ④ up and down until jack ③ is fully seated in take-up bracket ② and the jack base evenly meets the ground.
- ▶ Continue to turn crank/ratchet ④ until the wheel is a maximum of 1.2 in (3 cm) from the ground.

## Removing the wheel



P40.10-4939-31

- ① Alignment bolt
- ▶ Unscrew upper-most wheel bolt and remove it.
- ▶ Replace this wheel bolt with alignment bolt ① supplied with the tool kit (▷ page 490).
- ▶ Remove the remaining wheel bolts.
- ❗ *Do not place wheel bolts in sand or dirt. This could result in damage to the bolts and wheel hub threads.*
- ▶ Remove the wheel.

### Mounting the new wheel

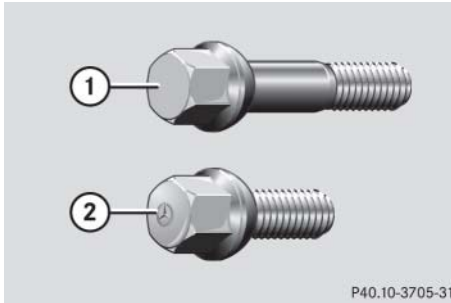

- ① Wheel bolt for 18", 19", 20" and 21" light alloy wheels
- ② Wheel bolt for Minispare wheel (located in vehicle tool kit (▷ page 490))

**!** Wheel bolts ② must be used when mounting the Minispare wheel. The use of any wheel bolts other than wheel bolts ② for the Minispare wheel will damage the vehicle's brakes.

- ▶ Clean contact surfaces of wheel and wheel hub.

**!** To avoid paint damage, place wheel flat against hub and hold it there while installing first wheel bolt.

#### Warning!



Always replace wheel bolts that are damaged or rusted.

Never apply oil or grease to wheel bolts.

Damaged wheel hub threads should be repaired immediately. Do not continue to drive under these circumstances! Contact an authorized Mercedes-Benz Light Truck Center or call Roadside Assistance.

Incorrect wheel bolts or improperly tightened wheel bolts can cause the wheel to come off. This could cause an accident. Make sure to use the correct wheel bolts.



- ▶ Guide spare wheel onto the alignment bolt and push it on the wheel hub.
- ▶ Insert wheel bolts and tighten them slightly.
- ▶ Unscrew the alignment bolt, install last wheel bolt and tighten slightly.

#### Warning!



Only use genuine Mercedes-Benz wheel bolts. Other wheel bolts may come loose.

Do not tighten the wheel bolts when the vehicle is raised. Otherwise the vehicle could fall off the jack.

### Flat tire

#### Lowering the vehicle

- ▶ **Vehicles with scissors-type jack:**  
Attach ratchet to vehicle jack in such a way that the word **DOWN** can be seen.
- ▶ Lower the vehicle until its resting fully on its own weight.
  - ▶ Vehicles with screw-type jack:  
Turn crank counterclockwise.
  - ▶ Vehicles with scissors-type jack:  
Turn ratchet in Direction of **DOWN**.
- ▶ Remove the jack.

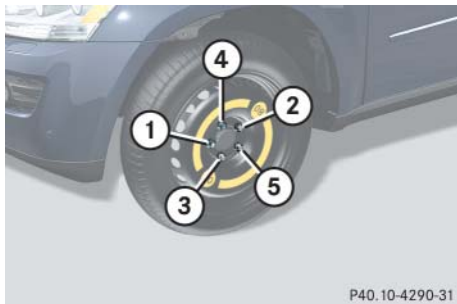

①-⑤ Wheel bolts

- ▶ Tighten the five wheel bolts evenly, following the diagonal sequence illustrated (1 to 5), until all bolts are tight. Observe a tightening torque of 110 lb-ft (150 Nm).

#### Warning!



Have the tightening torque checked after changing a wheel. The wheels could come loose if they are not tightened to a torque of 110 lb-ft (150 Nm).



- ▶ Store jack and all other vehicle tool kit items back into the storage well.

**i** *The removed road wheel cannot be stored in the spare wheel well under the cargo compartment floor, but should be transported in the cargo compartment wrapped in a protective cover.*

*Vehicles with TPMS or Advanced TPMS\*:  
Do not activate the tire inflation pressure monitor until a full size wheel/tire with functioning sensor has been placed back into service on the vehicle.*

## Bleeding the fuel system (diesel engine only)

## ▼ Bleeding the fuel system (diesel engine only)

Driving the vehicle until the fuel tank is empty is not recommended. Otherwise, air may be sucked into the fuel system. If this happens, the  malfunction indicator lamp (USA only) or the  malfunction indicator lamp (Canada only) comes on and the engine may not start immediately after refueling the vehicle.

After refueling:

- ▶ Make sure the automatic transmission is set to **P**.

The gear position indicator in the multi-function display should be on **P**.

- ▶ Do not depress the accelerator.

 *Vehicles with KEYLESS-GO\*: If necessary, remove the KEYLESS-GO start/stop button from the starter switch (▷ page 43).*



- ▶ Turn the SmartKey in the starter switch to position **2** for at least 10 seconds (▷ page 41).
- ▶ Return the SmartKey in the starter switch to position **0** (▷ page 41).

- ▶ Turn the SmartKey in the starter switch to position **3** (▷ page 41) and hold it there for a maximum of 40 seconds or until the engine runs surge-free.

If the engine does not start:

- ▶ Wait for approximately 2 minutes.
- ▶ Turn the SmartKey in the starter switch to position **3** (▷ page 41) and hold it there for a maximum of 40 seconds or until the engine runs surge-free.

If the engine still does not start, do not make any further attempts to start the engine. Contact an authorized Mercedes-Benz Light Truck Center or call Roadside Assistance (▷ page 335).

 *When the  malfunction indicator lamp (USA only) or the  malfunction indicator lamp (Canada only) has been illuminated for the above condition, it will remain illuminated until the engine was cycled on and off four times in a row.*

### Battery

The battery is located under the front passenger seat.

**i** Mercedes-Benz recommends to have the battery replaced at an authorized Mercedes-Benz Light Truck Center.

The battery should always be sufficiently charged in order to achieve its rated service life.

If you use your vehicle mostly for short-distance trips, you will need to have the battery charge checked more frequently.

When replacing the battery, always use batteries approved by Mercedes-Benz.

If you do not intend to operate your vehicle for an extended period of time, consult an authorized Mercedes-Benz Light Truck Center about steps you need to observe.

#### Warning!



Observe all safety instructions and precautions when handling automotive batteries.



Risk of explosion.



Fire, open flames and smoking are prohibited when handling batteries. Avoid creating sparks.



Battery acid is caustic. Do not allow it to come into contact with skin, eyes or clothing.

Wear suitable protective clothing, especially gloves, apron and faceguard.



Wear eye protection.

Rinse any acid spills immediately with clear water. Contact a physician if necessary.



Keep children away.



Follow the instructions in this Operator's Manual.

Batteries contain materials that can harm the environment if disposed of improperly. Recycling of batteries is the preferred method of disposal. Many states require sellers of batteries to accept old batteries for recycling.

**!** The battery is a valve-regulated lead acid (VRLA) battery, also referred to as “fleece” battery. Such batteries do not require topping-up of the electrolyte level. VRLA batteries therefore do not have cell caps and the battery cover is non-removable. Do not attempt to open the battery as otherwise the battery will be damaged.

Even though VRLA batteries do not require topping-up of the electrolyte level and cannot be opened to check the electrolyte level, the battery condition must be checked periodically by performing a battery conductance test. Refer to Maintenance Booklet for battery condition testing intervals.

As with any other battery, the battery may discharge if the vehicle is not operated for an extended period of time. You can connect a battery maintenance charge unit tested and approved for use on your vehicle model or disconnect the battery to prevent battery discharge. Contact an authorized Mercedes-Benz Light Truck Center for more information.

**!** The factory-equipped VRLA battery is leak-proofed. Only use a battery as replacement that has the same security features and is of identical size, voltage, and capacity as the factory-equipped battery.

The battery, the battery ventilation hose (▷ page 534) and the lateral plug (▷ page 534) must always be securely installed when the vehicle is in operation.

### Warning!



Jump starting must only be done using the jump-start contacts located in the engine compartment (▷ page 536).

### Warning!



Failure to follow these instructions can result in severe injury or death.

Observe all safety instructions and precautions when handling automotive batteries (▷ page 528).

Never lean over batteries while connecting, you might get injured.

Battery fluid contains sulfuric acid. Do not allow this fluid to come in contact with eyes, skin or clothing. In case it does, immediately flush affected area with water and seek medical help if necessary.

A battery will also produce hydrogen gas, which is flammable and explosive. Keep flames or sparks away from battery, avoid improper connection of jumper cables, smoking etc.

### Battery

**!** Never loosen or detach battery terminal clamps while the engine is running or the SmartKey is in the starter switch. Otherwise the alternator and other electronic components could be severely damaged.

Have the battery checked regularly by an authorized Mercedes-Benz Light Truck Center.

Contact your authorized Mercedes-Benz Light Truck Center for further information.

#### Warning!



Do not place metal objects on the battery as this could result in a short circuit.

Use leak-proof battery only to avoid the risk of acid burns in the event of an accident.

### Disconnecting, removing, reinstalling and reconnecting the battery

#### Warning!



Disconnecting, removing, reinstalling and reconnecting the battery is a complicated and technically demanding procedure that also requires safety precautions to avoid the risk of injury. We strongly recommend that it be performed by a qualified technician or an authorized Mercedes-Benz Light Truck Center only. Please read the instructions fully before beginning operation and only undertake it if you feel fully capable of performing all of the tasks involved as described in these instructions. Observe all safety instructions and precautions when handling automotive batteries (▷ page 528). Performing the tasks involved incorrectly can cause damage to the vehicle and impair the operating safety of the vehicle, and/or cause severe injury to you or others.

**i** With a disconnected battery you will no longer be able to turn the SmartKey in the starter switch and pressing the KEYLESS-GO\* start/stop button will have no effect.

#### Step 1 (Disconnecting)

**i** If your battery is discharged, the vehicle must be jump started (▷ page 536) using the jump start contacts in the engine compartment, or an accessory battery charge unit\* approved by Mercedes-Benz must be connected using the jump start contacts in the engine compartment (see separate instructions for the accessory battery charge unit\*) before any of the following steps can be performed. If the battery cannot be jumped or charged, please contact an authorized Mercedes-Benz Light Truck Center.

- ▶ Set the automatic transmission to position **P** (▷ page 191).
- ▶ Firmly depress the parking brake (▷ page 67).
- ▶ Turn off the engine (▷ page 68).
- ▶ Leave the ignition switched on (▷ page 42).

**i** If the vehicle battery is discharged and you had the vehicle jump started:

- Leave the engine running.
- Complete step 1, starting with switching off all electrical consumers.
- Continue with step 2.
- When the front passenger seat is in the most forward position, turn off the engine.

- ▶ Switch off all electrical consumers.
- ▶ Read and observe safety instructions and precautions (▷ page 528).
- ▶ Open the front passenger door.

**i** Open doors only when conditions are safe to do so.

- ▶ Move the front passenger seat to the most forward position (▷ page 46).

### Step 2 (Disconnecting)

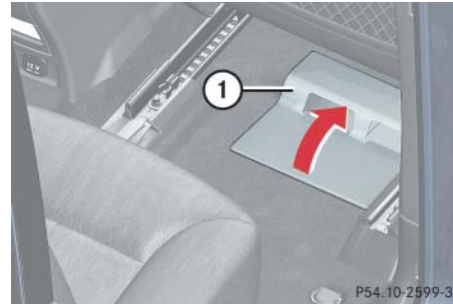

- ① Battery cover
- ▶ Enter the rear passenger compartment and remove main battery cover ①.

### Step 3 (Disconnecting)

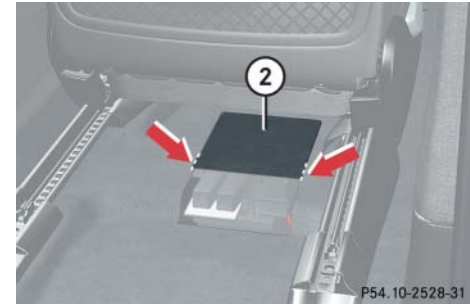

- ② Perforated floor carpet
- ▶ Cut the floor carpet ② along the dotted white line (see illustration) until you reach the perforated part. Start cutting at the point indicated by the arrows. Cut carpet using a sharp object (knife etc.).
- ▶ Enter the front passenger compartment.
- ▶ Move the front passenger seat to the most rearward position (▷ page 46). ▷▷



### Battery

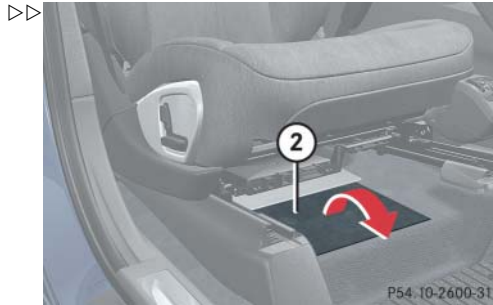

- ② Perforated floor carpet, unfolded
- ▶ Fold the floor carpet piece ② in direction of the arrow.
- ▶ Move the front passenger seat to the most forward and upward position again (▷ page 46).
- ▶ Switch off the ignition (▷ page 42).

**i** If the vehicle battery is discharged and you had the vehicle jump started, turn off the engine.

- ▶ Remove SmartKey from starter switch.
- Vehicles with KEYLESS-GO\*:
- ▶ Make sure the vehicle's on-board electronics have status **0** (Turn off the engine or all electrical systems using the KEYLESS-GO start/stop button. Open the driver's door. With the driver's door open, the vehicle's on-board electronics have status **0**, same as with the SmartKey removed from the starter switch).
  - ▶ Enter the rear passenger compartment again.

#### Step 4 (Disconnecting)

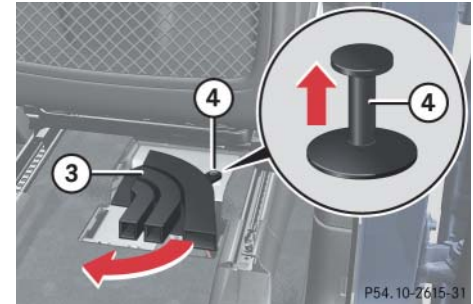

- ③ Air channel
- ④ Clip with pin insert
- ▶ Pull pin out of clip ④ in direction of arrow.
- ▶ Pull clip with pin ④ outwards.
- ▶ Remove air channel ③ by pulling it out in direction of arrow.

Step 5 (Disconnecting)

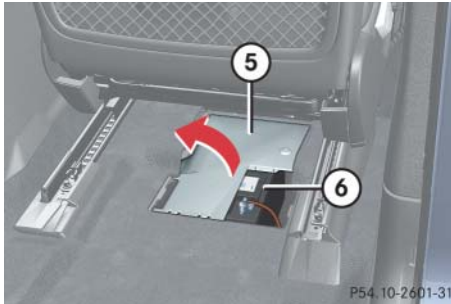

- ⑤ Protection cover
- ⑥ Battery

▶ Unclip protection cover ⑤ from battery ⑥ and remove it.

Step 6 (Disconnecting)

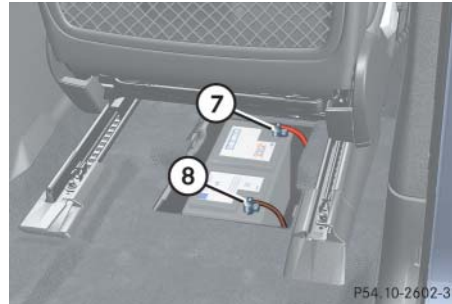

- ⑦ Positive terminal
- ⑧ Negative terminal

- ▶ Disconnect battery negative lead ⑧ from negative terminal.
- ▶ Remove positive terminal cover.
- ▶ Disconnect the battery positive lead ⑦.

Step 7 (Removing)

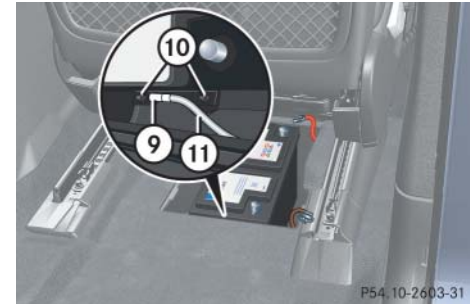

- ⑨ Battery ventilation hose
- ⑩ Attachment nut
- ⑪ Mounting

- ▶ Remove the battery ventilation hose ⑨ by pulling it out.
- ▶ Unfasten and remove attachment nuts ⑩.
- ▶ Remove mounting ⑪.

## Battery

### Step 8 (Removing)

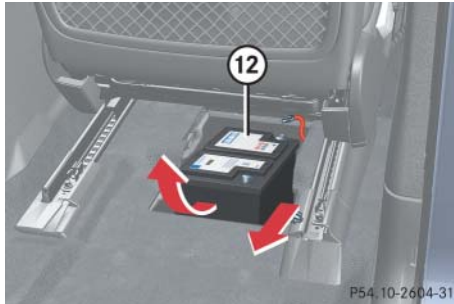

#### ⑫ Battery

- ▶ Tilt the battery ⑫ with the negative terminal side upwards.
- ▶ Take out the battery maintaining its tilted position in the direction of the arrow.

### Step 9 (Reinstalling)

- ▶ Carry out step 8 in reverse order (▷ page 534).

**!** The battery, the battery ventilation hose ⑨ and the lateral plug ⑬ (▷ page 534) must always be securely installed when the vehicle is in operation.

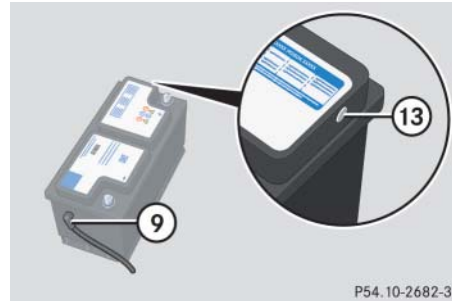

#### Battery, shown removed for illustration

- ⑨ Battery ventilation hose
- ⑬ Vent plug

- ▶ Carry out step 10 to reconnect the battery (▷ page 534).
- ▶ Follow steps 5 to 1 in reverse order to completely reinstall the battery (▷ page 533) to (▷ page 530).

### Step 10 (Reconnecting)

- ▶ If the battery has been removed, first carry out step 8 in reverse order (▷ page 534).
- ▶ Open the driver's door.
- ▶ Make sure all electrical consumers are turned off.
- ▶ Make sure the SmartKey is removed from the starter switch.

Vehicles with KEYLESS-GO\*:

- ▶ Make sure the vehicle's on-board electronics have status **0** (Open the driver's door. With the driver's door open, the vehicle's on-board electronics have status **0**, same as with the SmartKey removed from the starter switch (▷ page 41)).

- ▶ Connect the positive lead to the positive terminal and fasten its cover (▷ page 533).
- ▶ Connect the negative lead to the negative terminal (▷ page 533).

**!** *Never invert the terminal connections!*

**i** *The following procedures must be carried out following any interruption of battery power (e.g. due to reconnection):*

- *Set the clock (▷ page 174).*  
*Vehicles with COMAND system with navigation module\*: Time and date are set automatically.*
- *Synchronize the door windows (▷ page 249).*
- *Synchronize the power tilt/sliding sunroof\* (▷ page 253).*
- *Synchronize the power folding exterior rear view mirrors\* (▷ page 209).*

### Charging the battery

If the battery is discharged, the battery can be charged using the jump-start contacts located in the engine compartment (▷ page 537).

#### Warning!



Never charge a battery while still installed in the vehicle unless the accessory battery charge unit approved by Mercedes-Benz is being used. Gases may escape during charging and cause explosions that may result in paint damage, corrosion or personal injury.

An accessory battery charge unit specially adapted for Mercedes-Benz vehicles and tested and approved by Mercedes-Benz is available, permitting the charging of the battery in its installed position. Contact an authorized Mercedes-Benz Light Truck Center for information and availability. Charge battery in accordance with the separate instructions for the accessory battery charger.

- ▶ Charge the battery in accordance with the instructions of the battery charger manufacturer.

Batteries contain materials that can harm the environment if disposed of improperly. Large 12-volt storage batteries contain lead. Recycling of batteries is the preferred method of disposal. Many states require sellers of batteries to accept old batteries for recycling.

### Jump starting

#### Warning!



Failure to follow these directions will cause damage to the electronic components, and can lead to a battery explosion and severe injury or death.

Never lean over batteries while connecting or jump starting, you might get injured.

Battery fluid contains sulfuric acid. Do not allow this fluid to come in contact with eyes, skin or clothing. In case it does, immediately flush affected area with water, and seek medical help if necessary.

A battery will also produce hydrogen gas, which is flammable and very explosive. Keep flames or sparks away from battery, avoid improper connection of jumper cables, smoking, etc.

Attempting to jump start a frozen battery can result in it exploding, causing personal injury.

Read all instructions before proceeding.

If the battery is discharged, the engine can be started with jumper cables and the battery of another vehicle. Observe the following:

- Jump starting should only be performed using the jump-start contacts located in the engine compartment (▷ page 537).
- Jump starting should only be performed when the engine and catalytic converter<sup>1</sup> are cold.
- Do not start the engine if the battery is frozen. Let the battery thaw out first.
- Only jump start from batteries with the same voltage rating (12 V). Jump starting with a higher voltage battery could damage the vehicle's electrical system, which will not be covered by the Mercedes-Benz Limited Warranty.
- Only use jumper cables with sufficient cross-section and insulated terminal clamps.

- Always make sure the jumper cables are not on or near pulleys, fans or other parts that move when the engine is started or running.

**!** Do not tow-start the vehicle.

**!** Avoid repeated and lengthy starting attempts.

*Do not attempt to start the engine using a battery quick charge unit.*

*If the engine does not run after several unsuccessful starting attempts, have it checked at the nearest authorized Mercedes-Benz Light Truck Center.*

*Excessive unburned fuel generated by repeated failed starting attempts may damage the catalytic converter<sup>1</sup>.*

*Make sure the jumper cables do not have loose or missing insulation.*

*Make sure the cable clamps do not touch any other metal part while the other end is still attached to a battery.*

<sup>1</sup> Vehicles with gasoline engine only.

**Warning!**



Keep flames or sparks away from battery.  
Do not smoke.  
Observe all safety instructions and precautions when handling automotive batteries (▷ page 528).

The jump-start contacts are located in the engine compartment.

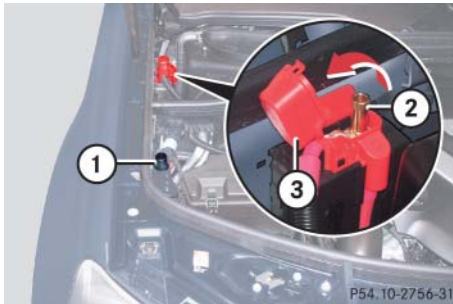

- ① Negative (-) terminal
- ② Positive (+) terminal
- ③ Positive terminal cover

- ▶ Make sure the two vehicles do not touch.

- ▶ Turn off all electrical consumers.
- ▶ Apply parking brake (▷ page 67).
- ▶ Set automatic transmission to position **P** (▷ page 191).
- ▶ Open the hood (▷ page 378).
- ▶ Remove cover from negative terminal ①.
- ▶ Flip up cover ③ of positive terminal ② in direction of arrow.

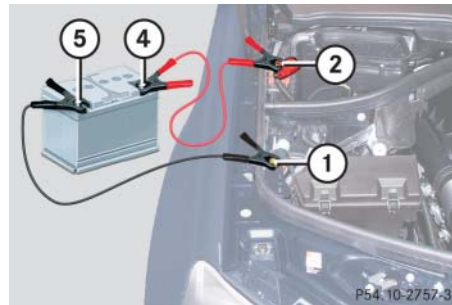

- ① Negative terminal of discharged battery
- ② Positive terminal of discharged battery
- ④ Positive terminal of charged battery
- ⑤ Negative terminal of charged battery

- ▶ Connect positive terminal ② and ④ with the jumper cable. Clamp cable to charged battery ④ first.
- ▶ Start engine of the vehicle with the charged battery and run at idle speed.
- ▶ Connect negative terminals ① and ⑤ of the batteries with the second jumper cable. Clamp the cable to negative terminal ⑤ of the charged battery first.

**!** *Never invert the terminal connections!*

- ▶ Start the engine of the disabled vehicle.

You can now turn on the electrical consumers. Do not switch on the headlamps under any circumstances.

- ▶ Remove the jumper cables first from negative terminals ① and ⑤ and then from positive terminals ② and ④.

You can now switch on the headlamps.

- ▶ Have the battery checked at the nearest authorized Mercedes-Benz Light Truck Center.

### Towing the vehicle

Mercedes-Benz recommends that the vehicle be transported with all wheels off the ground using flatbed or appropriate wheel lift/dolly equipment. This method is preferable to other types of towing.

**!** *Do not tow-start the vehicle.*

**!** *Use flatbed or wheel lift/dolly equipment, with the SmartKey in starter switch turned to position 0.*

*Do not tow with sling-type equipment. Towing with sling-type equipment over bumpy roads will damage radiator and supports.*

*To prevent damage during transport, do not tie down vehicle by its chassis or suspension parts. Use the towing eyes.*

*Switch off the ESP® (▷ page 105) and the automatic central locking (▷ page 128).*

**!** *Do not tow with one axle raised. Doing so could damage the transfer case, which is not covered by the Mercedes-Benz Limited Warranty.*

*All wheels must be on or off the ground. Observe instructions for towing the vehicle with all wheels on the ground.*

If circumstances do not permit the recommended towing methods, the vehicle may be towed with all wheels on the ground only so far as necessary to have the vehicle moved to a safe location where the recommended towing methods can be employed.

When towing the vehicle with all wheels on the ground, the vehicle may be towed only for distances up to 30 miles (50 km) and at a speed not to exceed 30 mph (50 km/h).

#### Warning!



If circumstances require towing the vehicle with all wheels on the ground, always tow with a tow bar if

- the engine will not run
- there is a malfunction in the brake system
- there is a malfunction in the power supply or in the vehicle's electrical system

This is necessary to adequately control the towed vehicle.

Prior to towing the vehicle with all wheels on the ground, make sure the automatic transmission is in neutral position **N**.

**Warning!**



With the engine not running, there is no power assistance for the brake and steering systems. In this case, it is important to keep in mind that a considerably higher degree of effort is necessary to brake and steer the vehicle. Adapt your driving accordingly.

**!** *When towing the vehicle with all wheels on the ground, the automatic transmission must be in neutral position **N**.*

*If you turn off the engine*

- *using the SmartKey and*
  - *remove the SmartKey from the starter switch*
  - or*
  - *open a front door*
- *or when using the KEYLESS-GO\* start/stop button and open a front door*

*the automatic transmission will shift to park position **P** automatically.*

If you want the gear position to remain in neutral position **N**, observe the following instructions.

**Warning!**



When leaving the SmartKey or SmartKey with KEYLESS-GO\* in the starter switch, do not leave children unattended in the vehicle. It is possible for children to switch on the ignition which could result in unsupervised use of vehicle equipment. A child's unsupervised access to a vehicle could result in an accident and/or serious personal injury.

Vehicles with SmartKey:

- ▶ With the vehicle at a standstill and the ignition switched on shift the automatic transmission to neutral position **N**.
- ▶ If engaged, release the parking brake (> page 59).
- ▶ Switch off the ignition and leave the SmartKey in the starter switch.

Vehicles with KEYLESS-GO\*:

- ▶ With the vehicle at a standstill, depress the brake pedal and keep it pressed.
- ▶ With the ignition switched on shift the automatic transmission to park position **P**.
- ▶ Release the brake pedal. ▷▷



### Towing the vehicle

- ▷▷ Remove the KEYLESS-GO\* start/stop button from the starter switch (▷ page 43).
- ▶ Insert the SmartKey with KEYLESS-GO\* into the starter switch.
- ▶ Switch on the ignition.
- ▶ Depress the brake pedal.
- ▶ Shift the automatic transmission to neutral position **N**.
- ▶ Release the brake pedal.
- ▶ If engaged, release the parking brake (▷ page 59).
- ▶ Switch off the ignition and leave the SmartKey with KEYLESS-GO\* in the starter switch.

**!** *Towing of the vehicle should only be done using the properly installed towing eye bolt. Never attach a tow cable, tow rope or tow rod to the vehicle chassis, frame or suspension parts.*

**i** *To signal turns while being towed with hazard warning flasher in use, set the starter switch to position **2** and activate combination switch for left or right turn signal in usual manner – only the selected turn signal will operate.*

*Upon canceling the turn signal, the hazard warning flasher will operate again.*

### Installing towing eye bolt

Depending on whether you are towing a vehicle or you are being towed, the towing eye bolt can be screwed into threaded holes which are located behind covers on the right-hand side of each bumper.

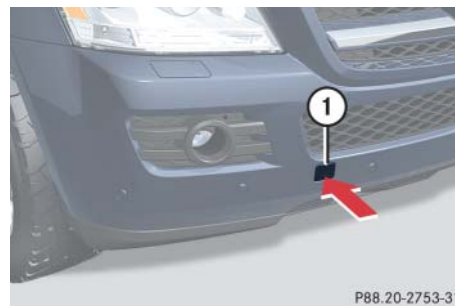

P88.20-2753-31

① Cover

**Warning!**



In order to avoid possible serious burns or injury, use extreme caution when removing the rear cover, because the rear exhaust pipe is extremely hot.

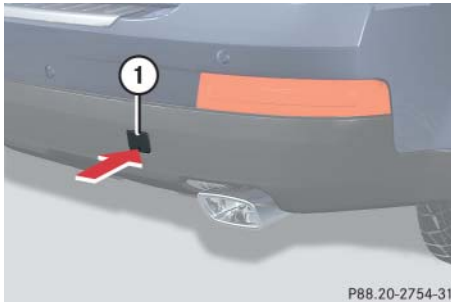

① Cover

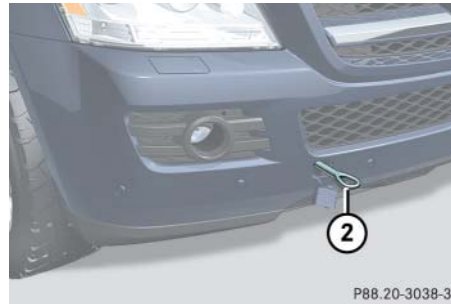

**Example illustration front bumper**

② Towing eye bolt

**Removing cover**

**i** Cover ① is secured to the bumper by a plastic cord.

- ▶ Press mark on cover ① as indicated by the arrow.
- ▶ Lift off cover ① to reveal the threaded hole for towing eye bolt.

**Installing towing eye bolt**

- ▶ Take the towing eye bolt and wheel wrench from the vehicle tool kit (> page 490).
- ▶ Screw towing eye bolt ② in clockwise to its stop and tighten with wheel wrench.

**Removing towing eye bolt**

- ▶ Loosen towing eye bolt ② counter-clockwise with wheel wrench.
- ▶ Unscrew towing eye bolt ②.
- ▶ Store the towing eye bolt and wheel wrench back into the vehicle tool kit (> page 490).

**Installing cover**

- ▶ Engage cover ① at top and press at bottom.

### Towing the vehicle

#### Stranded vehicle

---

Freeing a stranded vehicle, on which the wheels are dug into sand or mud, should be done with the greatest of care, especially if the vehicle is heavily loaded.

Avoid pulling the vehicle abruptly or diagonally, since it could result in damage to the chassis alignment.

Never try to free a vehicle that is still coupled to a trailer.

If possible, a vehicle equipped with trailer hitch receiver should be pulled backward in its own previously made tracks.

## ▼ Fuses

The electrical fuses in your vehicle serve to switch off malfunctioning power circuits.

If a fuse is blown, the components and systems secured by that fuse will stop operating.

### Warning!



Only use fuses approved by Mercedes-Benz with the specified amperage for the system in question and do not attempt to repair or bridge a blown fuse. Using other than approved fuses or using repaired or bridged fuses may cause an overload leading to a fire, and/or cause damage to electrical components and/or systems. Have the cause determined and remedied by an authorized Mercedes-Benz Light Truck Center.

**i** *A blown fuse must be replaced by an appropriate spare fuse (recognizable by its color or the fuse rating given on the fuse) of the amperage recommended in the fuse chart. Any Mercedes-Benz Light Truck Center will be glad to advise you on this subject.*

If a newly inserted fuse blows again, have the cause determined and rectified by an authorized Mercedes-Benz Light Truck Center.

A fuse chart explains the fuse allocation and fuse amperages. It is located in the cargo compartment with the vehicle tool kit (▷ page 490).

The electrical fuses are located in different fuse boxes:

- Fuse box in engine compartment (▷ page 544)
- Fuse box in cargo compartment (▷ page 544)
- Fuse box in passenger compartment (▷ page 545)

Before replacing fuses:

- ▶ Apply parking brake (▷ page 67).
- ▶ Make sure the automatic transmission is set to **P** (▷ page 191).

The gear position indicator in the multi-function display should be on **P**.

- ▶ Turn off all electrical consumers.
- ▶ Turn off the engine (▷ page 41).
- ▶ Remove the SmartKey from the starter switch.

Vehicles with KEYLESS-GO\*:

- ▶ Open the driver's door (this puts the starter switch in position **0**, same as with the SmartKey removed from the starter switch). The driver's door then can be closed again.

### Fuses

#### Fuse box in engine compartment

The fuse box is located on the passenger side of the engine compartment.

- ▶ Open the hood (▷ page 378).

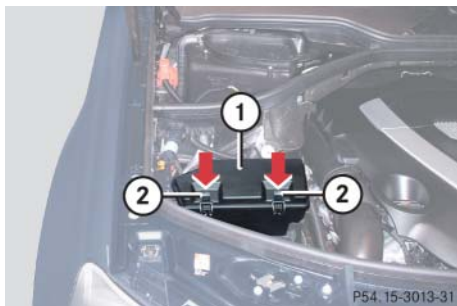

Fuse box GL 450 (GL 320 CDI, GL 550 similar)

- ① Fuse box cover
- ② Clamps

- ▶ Pull clamps ② in direction of arrow.
- ▶ Lift fuse box cover ① up.
- ▶ Install fuse box cover in reverse order.

**!** The fuse box cover must be installed properly to prevent moisture and/or dirt from entering the fuse box and possibly impairing fuse operation.

- ▶ Close the hood after checking or replacing fuses (▷ page 379).

#### Fuse box in cargo compartment

The fuse box is located in the cargo compartment behind the passenger side trim panel.

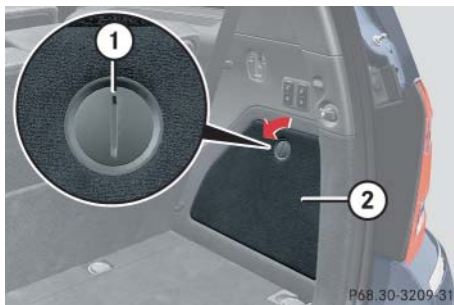

- ① Lock
- ② Cover

#### Removing/installing cover

- ▶ Open the tailgate (▷ page 122).
- ▶ Insert a suitable object such as a coin into the slot of lock ① (▷ page 544).
- ▶ Turn lock ① counterclockwise by 90° in direction of arrow.
- ▶ Remove cover ②.
- ▶ Install cover ② in reverse order.

### Fuse box in passenger compartment

The fuse box is located behind a cover in the dashboard on the front passenger side.

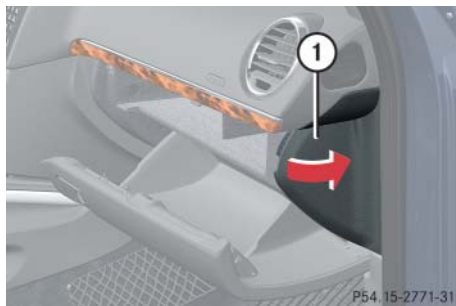

① Cover

**!** Do not use sharp objects such as a screwdriver to open the fuse box cover ① in the dashboard, as this could damage the fuse box cover or the dashboard.

### Opening

- ▶ Open the front passenger door.
- ▶ Open the glove box (▷ page 315).
- ▶ Insert flat, blunt object as a lever into the edge of the cover ① at the position indicated by the arrow.
- ▶ Loosen cover ① from dashboard using lever.
- ▶ Using your hands, pull cover ① out and remove.

### Closing

- ▶ Hook cover ① into the opening at the front.
- ▶ Press cover ① back on until it engages.

### Emergency engine shut-down

If the engine cannot be turned off as described in the “Getting started” section (▷ page 68), you may use the following emergency procedure.

- ▶ Take the fuse chart from the vehicle tool kit (▷ page 492).
- ▶ Open the fuse box in engine compartment (▷ page 544).
- ▶ Remove fuse 120.

Find its location in the fuse chart.





**Parts service**

**Warranty coverage**

**Identification labels**

**Layout of poly-V-belt drive**

**Engine**

**Rims and tires**

**Electrical system**

**Main Dimensions**

**Weights**

**Fuels, coolants, lubricants**



The “Technical data” section provides the necessary technical data for your vehicle.

All authorized Mercedes-Benz Light Truck Centers maintain a stock of Genuine Mercedes-Benz Parts required for maintenance and repair work. In addition, strategically located parts distribution centers provide quick and reliable parts service.

More than 300 000 different parts for Mercedes-Benz models are available.

Genuine Mercedes-Benz Parts are subjected to stringent quality inspections. Each part has been specifically developed, manufactured or selected for and adapted to Mercedes-Benz vehicles.

Therefore, Genuine Mercedes-Benz parts should be installed.

**!** *The use of non-genuine Mercedes-Benz parts and accessories not authorized by Mercedes-Benz could damage the vehicle, which is not covered by the Mercedes-Benz Limited Warranty, or could compromise the vehicle's durability or safety.*

## ▼ Warranty coverage

Your vehicle is covered under the terms of the warranties printed in the Service and Warranty Information booklet. Your authorized Mercedes-Benz Light Truck Center will exchange or repair any defective parts originally installed on the vehicle in accordance with the terms of the following warranties:

- New Vehicle Limited Warranty
- Emission System Warranty
- Emission Performance Warranty
- California, Maine, Massachusetts, and Vermont Emission Control Systems Warranty

Replacement parts and accessories are covered by the Mercedes-Benz Parts and Accessories warranties, copies of which are available at any authorized Mercedes-Benz Light Truck Center.

## Loss of Service and Warranty Information Booklet

---

Should you lose your Service and Warranty Information booklet, have an authorized Mercedes-Benz Light Truck Center arrange for a replacement. It will be mailed to you.

## Identification labels

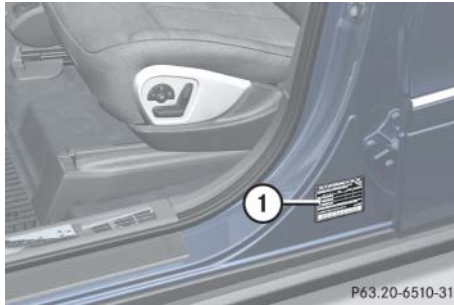

P63.20-6510-31

① Certification label (on driver's B-pillar)

The Vehicle Identification Number (VIN) can be found in the following locations:

- on the certification label
- embossed underneath the passenger-side second-row rear seat (▷ page 551)
- on the lower edge of the windshield (▷ page 551)

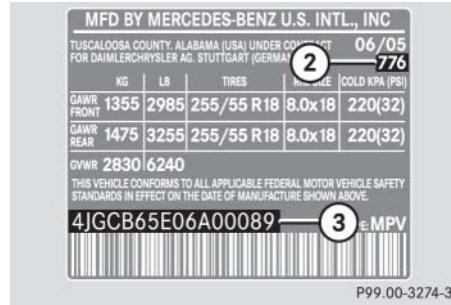

P99.00-3274-31

**Example certification label (U.S. vehicles)**

- ② Paintwork code
- ③ VIN

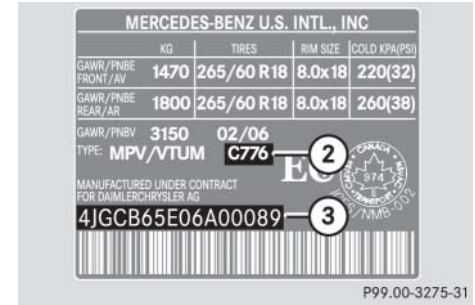

P99.00-3275-31

**Example certification label (Canada vehicles)**

- ② Paintwork code
- ③ VIN

**i** Data shown on certification label are for illustration purpose only. These data are specific to each vehicle and may vary from data shown in the illustration. Refer to certification label on vehicle for actual data specific to your vehicle.

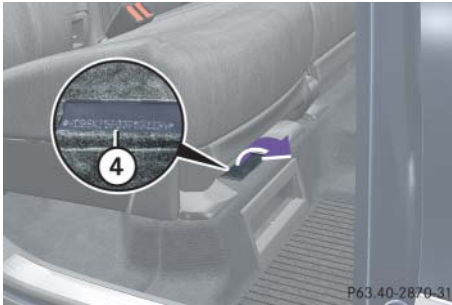

**Second-row seat**

④ VIN

► Fold the carpet forwards.

The VIN ④ is now visible.

**i** When ordering parts, please specify vehicle identification and engine numbers.

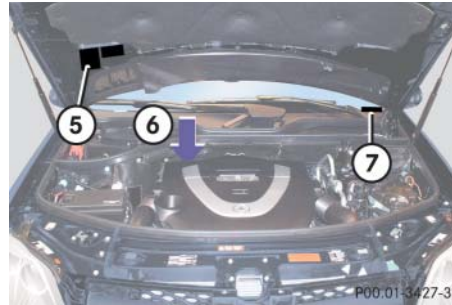

⑤ Emission control information label, includes both federal and California certification exhaust emission standards

⑥ Engine number (engraved on engine)

⑦ VIN (lower edge of windshield)

## Layout of poly-V-belt drive

GL 320 CDI

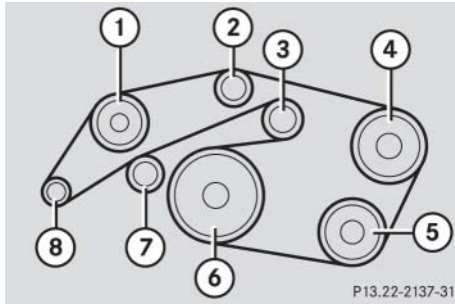

P13.22-2137-31

- ① Coolant pump
- ② Idler pulley
- ③ Automatic belt tensioner
- ④ Power steering pump
- ⑤ Air conditioning compressor
- ⑥ Crankshaft
- ⑦ Idler pulley
- ⑧ Generator (alternator)

GL 450, GL 550

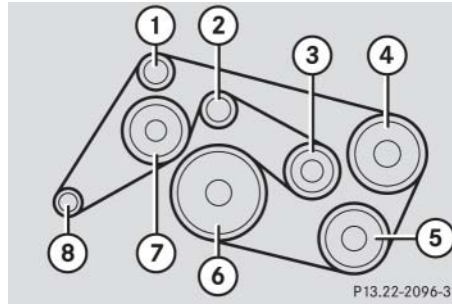

P13.22-2096-31

- ① Idler pulley
- ② Idler pulley
- ③ Automatic belt tensioner
- ④ Power steering pump
- ⑤ Air conditioning compressor
- ⑥ Crankshaft
- ⑦ Coolant pump
- ⑧ Generator (alternator)

▼ Engine

Model	GL 320 CDI (164.822 <sup>1</sup> )	GL 450 (164.871 <sup>1</sup> )
Engine	642	273
Mode of operation	Diesel 4-stroke engine	4-stroke engine, gasoline injection
No. of cylinders	6	8
Bore	3.27 in (83.00 mm)	3.66 in (92.90 mm)
Stroke	3.62 in (92.00 mm)	3.38 in (86.00 mm)
Total piston displacement	182 cu in (2987 cm <sup>3</sup> )	285 cu in (4663 cm <sup>3</sup> )
Compression ratio	17.7:1	10.7:1
Output acc. to SAE J 1349	215 hp/4000 rpm (160 kW/4000 rpm)	335 hp/6000 rpm <sup>2</sup> (250 kW/6000 rpm)
Maximum torque acc. to SAE J 1349	400 lb-ft/1600 - 2400 rpm (543 Nm/1600 - 2400 rpm)	339 lb-ft/2700 - 5000 rpm (460 Nm/2700 - 5000 rpm)
Maximum engine speed	4500 rpm	6500 rpm
Firing order	1-4-2-5-3-6	1-5-4-2-6-3-7-8
Poly-V-belt	2035 mm	2404 mm

<sup>1</sup> The quoted data apply only to the standard vehicle. See an authorized Mercedes-Benz Light Truck Center for the corresponding data of all special bodies and special equipment.

<sup>2</sup> Premium fuel required. Performance may vary with fuel octane rating.

## Engine

<b>Model</b>	<b>GL 550 (164.886<sup>1</sup>)</b>
<b>Engine</b>	273
<b>Mode of operation</b>	4-stroke engine, gasoline injection
<b>No. of cylinders</b>	8
<b>Bore</b>	3.86 in (98.00 mm)
<b>Stroke</b>	3.56 in (90.50 mm)
<b>Total piston displacement</b>	333.2 cu in (5461 cm <sup>3</sup> )
<b>Compression ratio</b>	10.7:1
<b>Output acc. to SAE J 1349</b>	382 hp/6000 rpm <sup>2</sup> (285 kW/6000 rpm)
<b>Maximum torque acc. to SAE J 1349</b>	391 lb-ft/2800 - 4800 rpm (530 Nm/2800 - 4800 rpm)
<b>Maximum engine speed</b>	6500 rpm
<b>Firing order</b>	1-5-4-2-6-3-7-8
<b>Poly-V-belt</b>	2404 mm

<sup>1</sup> All data preliminary. The quoted data apply only to the standard vehicle. See an authorized Mercedes-Benz Light Truck Center for the corresponding data of all special bodies and special equipment.

<sup>2</sup> Premium fuel required. Performance may vary with fuel octane rating.

▼ Rims and tires

**!** Only use tires which have been tested and approved by Mercedes-Benz. Tires approved by Mercedes-Benz are developed to provide best possible performance in conjunction with the driving safety systems on your vehicle such as ABS or ESP®. Tires specially developed for your vehicle and tested and approved by Mercedes-Benz can be identified by finding the following on the tire's sidewall:

- MO = Mercedes-Benz Original equipment tires

Using tires other than those approved by Mercedes-Benz may result in damage that is not covered by the Mercedes-Benz Limited Warranty.

**!** Using tires other than those approved by Mercedes-Benz can have detrimental effects, such as

- poor handling characteristics
- increased noise
- increased fuel consumption

Moreover, tires and rims not approved by Mercedes-Benz may, under load, exhibit dimensional variations and different tire deformation characteristics that could cause them to come into contact with the vehicle body or axle parts. Damage to the tires or the vehicle may be the result.

**i** Further information on tires and rims is available at any authorized Mercedes-Benz Light Truck Center. A placard with the recommended tire inflation pressure is located on the driver's door B-pillar (▷ page 550). Some vehicles may have supplemental tire inflation pressure information for driving at high speeds (▷ page 394) or for vehicle loads less than the maximum loaded vehicle condition (▷ page 394). If such information is provided, it can be found on the placard located on the inside of the fuel filler flap.

The tire inflation pressure should be checked regularly and should only be adjusted on cold tires. Follow tire manufacturer's maintenance recommendation included with vehicle.



**i** The following pages also list the approved wheel rim and tire sizes for equipping your vehicles with winter tires. Winter tires are not available as standard or optional factory equipment, but can be purchased from an authorized Mercedes-Benz Light Truck Center.

Depending on vehicle model and the standard or optional factory-equipped wheel rim/tire configuration on your vehicle (Appearance Package, etc.), equipping your vehicle with winter tires approved for your vehicle model may also require the purchase of two or four wheel rims of the recommended size for use with these winter tires. See an authorized Mercedes-Benz Light Truck Center for more information.





## Rims and tires

### Same size tires

Model	GL 320 CDI GL 450	GL 320 CDI* GL 450*	GL 320 CDI* GL 450*
<b>Rims (light alloy)</b>	8 J x 18 H2	8.5 J x 19 H2	8.5 J x 20 H2
<b>Wheel offset</b>	2.36 in (53 mm)	2.20 in (56 mm)	2.20 in (56 mm)
<b>Summer tires<sup>1</sup></b>	-	-	275/50 R20 109W
<b>All-season tires<sup>1</sup></b>	265/60 R18 110H M+S	275/55 R19 111H M+S	-
<b>Rims (light alloy)</b>	8 J x 18 H2	8.5 J x 19 H2	8.5 J x 19 H2
<b>Wheel offset</b>	2.36 in (53 mm)	2.20 in (56 mm)	2.20 in (56 mm)
<b>Winter tires<sup>1,2</sup></b>	265/60 R18 110H M+S 	265/55 R19 109H M+S 	265/55 R19 109H M+S 
<b>All-terrain tires<sup>1,2</sup></b>	265/60 R18 110H M+S	275/55 R19 111H M+S	275/55 R19 111H M+S

<sup>1</sup> Radial-ply tires

<sup>2</sup> Not available as factory equipment.

<b>Model</b>	<b>GL 550</b>
<b>AMG rims (light alloy)</b>	10 J x 21 H2
<b>Wheel offset</b>	1.46 in (37 mm)
<b>All-season tires<sup>1,2</sup></b>	295/40 R21 111V XL (Extra Load) M+S
<b>Rims (light alloy)</b>	8.5 J x 19 H2
<b>Wheel offset</b>	2.20 in (56 mm)
<b>Winter tires<sup>1,3</sup></b>	265/55 R19 109H M+S 
<b>All-season tires<sup>1,3</sup></b>	265/55 R19 109H M+S 

<sup>1</sup> Radial-ply tires

<sup>2</sup> Must not be used with snow chains.

<sup>3</sup> Not available as factory equipment.

## Rims and tires

### Minispare wheel

---

<b>Model</b>	<b>GL 320 CDI</b> <b>GL 450</b> <b>GL 550</b>
<b>Rim</b>	4.5B x 19 H2
<b>Wheel offset</b>	1.58 in (40 mm)
<b>Minispare tire<sup>1</sup></b>	T 165/90 D19 119M or T 165/90 R19 119M

<sup>1</sup> Must not be used with snow chains.

**!** Please compare the recommended tire inflation pressure for your vehicle with the tire inflation pressure on the yellow label located on the Minispare wheel rim.

If the tire inflation pressure on the yellow label on the Minispare wheel rim differs from the values given in this Operator's Manual, inflate the tire to the recommended tire inflation pressure given on the yellow label on the Minispare wheel rim.

**i** Please note that the tire inflation pressure of the Minispare tire differs from the tire inflation pressure of the road tires.

▼ **Electrical system**

Model	GL 450	GL 550
Generator (alternator)	14 V/180 A	14 V/180 A
Starter motor	12 V/1.7 kW	12 V/1.7 kW
Battery	12 V/95 Ah	12 V/95 Ah
Spark plugs	NGK PLKR7A	NGK PLKR7A
Electrode gap	0.031 in (0.8 mm)	0.031 in (0.8 mm)
Tightening torque	15 – 19 lb-ft (20 – 25 Nm)	15 – 19 lb-ft (20 – 25 Nm)

Model	GL 320 CDI
Generator (alternator)	14 V/180 A
Starter motor	12 V/2.0 kW
Battery	12 V/95 Ah

**Main Dimensions**

<b>Model</b>	<b>GL 320 CDI, GL 450, GL 550</b>
<b>Overall vehicle length</b>	200.6 in (5096 mm)
<b>Vehicle width, exterior rear view mirrors folded out</b>	83.7 in (2127 mm)
<b>Vehicle width, exterior rear view mirrors folded in</b>	76.0 in (1930 mm)
<b>Vehicle width, exterior rear view mirrors folded in (vehicles with AMG rims)</b>	76.9 in (1954 mm)
<b>Overall vehicle height, depending on set vehicle level</b>	72.4 in - 75.6 in (1840 mm - 1920 mm)
<b>Overall vehicle height, depending on set vehicle level (vehicles with enhanced off-road package*)</b>	72.4 in - 76.8 in (1840 mm - 1950 mm)
<b>Wheelbase</b>	121.1 in (3075 mm)
<b>Ground clearance, depending on set vehicle level</b>	7.8 in - 10.9 in (197 mm - 277 mm)
<b>Ground clearance, depending on set vehicle level (vehicles with enhanced off-road package*)</b>	7.8 in - 12.1 in (197 mm - 307 mm)
<b>Turning circle</b>	39.7 ft (12.1 m)
<b>Track, front</b>	65.0 in (1651 mm)
<b>Track, rear</b>	65.1 in (1654 mm)

▼ **Weights**

Roof load max.	198 lb (90 kg)
----------------	----------------

### Fuels, coolants, lubricants

#### Capacities

Vehicle components and their respective lubricants must match. Therefore only use products tested and approved by Mercedes-Benz.

Please refer to the Factory Approved Service Products pamphlet (USA only), or inquire at an authorized Mercedes-Benz Light Truck Center.

#### Warning!



Comply with all valid regulations with respect to handling, storing and disposing of service fluids. Otherwise you could endanger persons or the environment.

Keep service fluids out of the reach of children.

For health reasons, you should prevent service fluids from coming into direct contact with your skin or clothing.

If a service fluid is swallowed, contact a physician immediately.

	Model	Capacity	Fuels, coolants, lubricants, etc.
<b>Engine with oil filter</b>	GL 320 CDI	9.0 US qt (8.5 l)	Approved engine oils
	GL 450, GL 550	9.5 US qt (9.0 l)	Approved engine oils
<b>Automatic transmission</b>	All models	9.5 US qt (9.0 l)	MB Automatic Transmission Fluid
<b>Transfer case single speed</b>	All models	0.5 US qt (0.5 l)	MB Automatic Transmission Fluid
<b>Transfer case double speed*</b>	All models	1.6 US qt (1.5 l)	MB Automatic Transmission Fluid
<b>Front axle</b>	All models	1.2 US qt (1.1 l)	Hypoid gear oil
<b>Rear axle</b>	All models	1.2 US qt (1.1 l)	Hypoid gear oil
<b>Rear axle with differential lock*</b>	All models	1.7 US qt (1.6 l)	Hypoid gear oil
<b>Power steering</b>	All models	approx. 1.3 US qt (1.2 l)	MB Power Steering Fluid or approved Dexron III ATF

	Model	Capacity	Fuels, coolants, lubricants, etc.
<b>Front wheel hubs</b>	All models	approx. 1.5 oz (43 g) each	High temperature roller bearing grease
<b>Brake system</b>	All models	-	MB Brake Fluid (DOT 4+)
<b>Cooling system</b>	GL 320 CDI	approx. 10.0 US qt (9.5 l)	MB Anticorrosion/Antifreeze
	GL 450	approx. 10.6 US qt (10.0 l)	MB Anticorrosion/Antifreeze
	GL 550 <sup>1</sup>	approx. 12.7 US qt (12.0 l)	MB Anticorrosion/Antifreeze
<b>Fuel Tank including a reserve of</b>	All models	26.4 US gal (100.0 l) approx. 3.4 US gal (13.0 l)	Gasoline engine: Premium unleaded gasoline: Minimum Posted Octane 91 (Avg. of 96 RON/86 MON)  Diesel engine: ULTRA-LOW SULFUR HIGHWAY DIESEL FUEL (15 ppm SULFUR MAXIMUM)
<b>Air conditioning system</b>	All models	-	R-134a refrigerant and special PAG lubricant oil (never R-12)
<b>Windshield washer system and headlamp cleaning system*</b>	All models	8.1 US qt (7.7 l)	MB Windshield Washer Concentrate <sup>2</sup>

<sup>1</sup> Data preliminary.

<sup>2</sup> Use MB Windshield Washer Concentrate “MB SummerFit” and water for temperatures above freezing or MB Windshield Washer Concentrate “MB SummerFit” and commercially available premixed windshield washer solvent/antifreeze for temperatures below freezing. Follow suggested mixing ratios (▷ page 569).



### Fuels, coolants, lubricants

#### Engine oils

Engine oils are specifically tested for their suitability in our engines and durability for our service intervals. Therefore, only use approved engine oils and oil filters required for vehicles with Maintenance System. For a listing of approved engine oils and oil filters, refer to the Factory Approved Service Products pamphlet (USA only), or contact an authorized Mercedes-Benz Light Truck Center.

**!** *Using engine oils and oil filters of specification other than those expressly required for the Maintenance System, or changing of oil and oil filter at change intervals longer than those called for by the Maintenance System will result in engine or emission control system damage not covered by the Mercedes-Benz Limited Warranty.*

*Please follow Maintenance System recommendations for scheduled oil changes. Failure to do so will result in engine or emission control system damage not covered by the Mercedes-Benz Limited Warranty.*

#### Engine oil additives

**!** *Do not blend oil additives with engine oil. They may damage the engine. Damage or malfunctions resulting from blending oil additives are not covered by the Mercedes-Benz Limited Warranty.*

#### Air conditioning refrigerant

R-134a (HFC) refrigerant and special PAG lubricating oil are used in the air conditioning system.

**!** *Never use R-12 (CFC) or mineral-based lubricating oil. Otherwise damage to the system will occur.*

#### Brake fluid

##### Warning!



During vehicle operation, the boiling point of the brake fluid is continuously reduced through the absorption of moisture from the atmosphere. Under extremely strenuous operating conditions, this moisture content can lead to the formation of bubbles in the system, thus reducing the system's efficiency.

Therefore, the brake fluid must be replaced regularly. Refer to your vehicle's Maintenance Booklet for replacement interval.

Only brake fluid approved by Mercedes-Benz is recommended. Any authorized Mercedes-Benz Light Truck Center will provide you with additional information.

## Premium unleaded gasoline (gasoline engine)

### Warning!



Gasoline is highly flammable and poisonous. It burns violently and can cause serious personal injury.

Never allow sparks, flame or smoking materials near gasoline!

Turn off the engine before refueling.

Whenever you are around gasoline, avoid inhaling fumes and skin or clothing contact, extinguish all smoking materials.

Direct skin contact with fuels and the inhalation of fuel vapors are damaging to your health.

**!** *To maintain the engine's durability and performance, premium unleaded gasoline must be used. If premium unleaded gasoline is not available and low octane fuel is used, follow these precautions:*

- *Have the fuel tank only partially filled with unleaded regular gasoline and fill up with premium unleaded gasoline as soon as possible.*
- *Avoid full throttle driving and abrupt acceleration.*
- *Do not exceed an engine speed of 3000 rpm if the vehicle is loaded with a light load such as two persons and no luggage.*
- *Do not exceed  $\frac{2}{3}$  of maximum accelerator pedal position if the vehicle is fully loaded or operating in mountainous terrain.*

## Fuel requirements

### Gasoline engine

Only use premium unleaded fuel:

- The octane number (posted at the pump) must be 91 min. It is an average of both the Research Octane Number (RON) and the Motor Octane Number (MON):  $(RON+MON)/2$ . This is also known as the ANTI-KNOCK INDEX.

Unleaded gasoline containing oxygenates such as ethanol, IPA, IBA and TBA can be used provided the ratio of any one of these oxygenates to gasoline does not exceed 10%; MTBE must not exceed 15%.

The ratio of methanol to gasoline must not exceed 3% plus additional cosolvents.

Using mixtures of ethanol and methanol is not allowed. Gasohol, which contains 10% ethanol and 90% unleaded gasoline, can be used.

### Fuels, coolants, lubricants

These blends must also meet all other fuel requirements, such as resistance to spark knock, boiling range, vapor pressure, etc.

#### Diesel engine

Only use commercially available vehicular ULTRA-LOW SULFUR HIGHWAY DIESEL FUEL (15 ppm SULFUR MAXIMUM).

To prevent malfunctions, diesel fuel with improved cold flow characteristics is offered in the winter months. Check with your fuel retailer.

**!** *Do not fill the tank with gasoline. Do not blend diesel fuel with gasoline or kerosene. The fuel system and engine will otherwise be damaged, which is not covered by the Mercedes-Benz Limited Warranty.*

#### Gasoline additives (gasoline engine)

A major concern among engine manufacturers is carbon build-up caused by gasoline. Mercedes-Benz recommends only the use of quality gasoline containing additives that prevent the build-up of carbon deposits.

After an extended period of using fuels without such additives carbon deposits can build up, especially on the intake valves and in the combustion area, leading to engine performance problems such as:

- Warm-up hesitation
- Unstable idle
- Knocking/pinging
- Misfire
- Power loss

In areas where carbon deposits may be encountered due to lack of availability of gasolines which contain these additives, Mercedes-Benz recommends the use of additives approved by us for use on Mercedes-Benz vehicles. Refer to the Factory Approved Service Products pamphlet (USA only) or contact an authorized Mercedes-Benz Light Truck Center for a listing of approved product(s). Follow directions on product label.

Do not blend other fuel additives with fuel. This only results in unnecessary costs and may be harmful to the engine operation.

**!** *Damage or malfunction resulting from poor fuel quality or from blending additional fuel additives other than those tested and approved by us for use on Mercedes-Benz vehicles are not covered by the Mercedes-Benz Limited Warranty.*

## Coolants

The engine coolant is a mixture of water and anticorrosion/antifreeze, which provides:

- Corrosion protection
- Freeze protection
- Boiling protection (by increasing the boiling point)

The cooling system was filled at the factory with a coolant providing freeze protection to approximately -35°F (-37°C) and corrosion protection.

**!** *Add premixed coolant solution only. Adding water and MB 325.0 Anticorrosion/Antifreeze separately from each other, could cause engine damage not covered by the Mercedes-Benz Limited Warranty.*

If the antifreeze mixture is effective to -35°F (-37°C), the boiling point of the coolant in the pressurized cooling system is reached at approximately 266°F (130°C).

The coolant solution must be used year round to provide the necessary corrosion protection and increase boil-over protection. Refer to Maintenance Booklet for replacement interval.

Coolant system design and coolant used determine the replacement interval. The replacement interval published in the Maintenance booklet is only applicable if MB 325.0 Anticorrosion/Antifreeze solution or other Mercedes-Benz approved products of equal specification are used to renew the coolant concentration or bring it back up to the proper level.

For information on other Mercedes-Benz approved products of equal specification, refer to the Factory Approved Service Products pamphlet (USA only) or contact an authorized Mercedes-Benz Light Truck Center.

To provide important corrosion protection, the solution must be at least 50% anticorrosion/antifreeze (equivalent to freeze protection to approximately -35°F [-37°C]). If you use a solution that is more than 55% anticorrosion/antifreeze (freeze protection to approximately -49°F [-45°C]), the engine temperature will increase due to the lower heat transfer capability of the solution. Therefore, do not use more than this amount of anticorrosion/antifreeze.

If the coolant level is low, water and MB 325.0 Anticorrosion/Antifreeze should be used to bring it up to the proper level (have cooling system checked for signs of leakage). Please make sure the mixture is in accordance with label instructions.

The water in the cooling system must meet minimum requirements, which are usually satisfied by normal drinking water. If you are not sure about the water quality, consult an authorized Mercedes-Benz Light Truck Center.

### Fuels, coolants, lubricants

#### Anticorrosion/antifreeze

Your vehicle contains a number of aluminum parts. The use of aluminum components in motor vehicle engines necessitates that anticorrosion/antifreeze coolant used in such engines be specifically formulated to protect the

aluminum parts. Failure to use such anticorrosion/antifreeze coolant will result in a significantly shortened service life.

Therefore, the following product is strongly recommended for use in your vehicle:  
MB 325.0 Anticorrosion/Antifreeze agent.

Before the start of the winter season (or once a year in hot southern regions), you should have the anticorrosion/antifreeze concentration checked. The coolant is also regularly checked each time you bring your vehicle to an authorized Mercedes-Benz Light Truck Center for service.

#### *Anticorrosion/antifreeze quantity*

Model	Approximate freeze protection	
	-35°F (-37°C)	-49°F (-45°C)
GL 320 CDI	5.0 US qt (4.75 l)	5.5 US qt (5.2 l)
GL 450	5.3 US qt (5.0 l)	5.8 US qt (5.5 l)
GL 550 <sup>1</sup>	5.6 US qt (5.25 l)	6.1 US qt (5.8 l)

<sup>1</sup> Data preliminary.

### Windshield washer system and headlamp cleaning system\*

Both the windshield washer system and headlamp cleaning system\* are supplied from the windshield washer reservoir.

The windshield washer reservoir has a capacity of approximately 8.1 US qt (7.7 l).

- ▶ Refill the reservoir with MB Windshield Washer Concentrate and water (or concentrate and commercially available premixed windshield washer solvent/antifreeze, depending on ambient temperatures).

#### Warning!



Washer solvent/antifreeze is highly flammable. Do not spill washer solvent/antifreeze on hot engine parts, because it may ignite and burn. You could be seriously burned.

### Windshield and headlamp washer fluid mixing ration

For temperatures above freezing point, use MB Windshield Washer Concentrate “MB SummerFit” and water:

- 1 part “MB SummerFit” to 100 parts water  
(1.34 fl oz [40 ml] “MB SummerFit” to 1 gal [4.0 l] water)

For temperatures below freezing point, use MB Windshield Washer Concentrate “MB SummerFit ” and commercially available premixed windshield washer solvent/antifreeze:

- 1 part “MB SummerFit” to 100 parts solvent  
(1.34 fl oz [40 ml] “MB SummerFit” to 1 gal [4.0 l] solvent)



- A**
- ABS 101
    - Indicator lamp 436
    - Off-road - ABS 102
  - ABS, ESP®
    - Messages in the multifunction display 451
  - Accelerator position, automatic transmission 195
  - Accessory weight 415
  - Accident 66
  - Active head restraint 90, 133, 499
  - Adaptive Damping System (ADS)\* 278
  - Air bags 76
    - Children 77, 91
    - Front passenger front air bag off indicator lamp 31, 32, 85
    - Front, Driver 79
    - Front, Passenger 79
    - Occupant Classification System (OCS) 81
    - Safety guidelines 78
    - Side impact (front and rear\*) 80
    - Window curtain 80
  - Air conditioning refrigerant 564
  - Air conditioning system see Climate control or Automatic climate control (3-zone)\*
  - Air conditioning, Cooling 224, 239
  - Air distribution, Front 219, 234
  - Air distribution, Rear 227, 243
  - Air pressure see Tire inflation pressure
  - Air recirculation mode 222, 237
  - Air suspension program 278
    - Adaptive Damping System (ADS)\* 278
    - Messages in the multifunction display 486
    - Vehicle level control 279
  - Air vents 227
  - Air vents\*, Rear 245
  - Air vents, Front 220, 234
  - Air volume 220, 235
  - Alarm system see Anti-theft systems
  - Alignment bolt (vehicle tool kit) 492, 524
  - Anticorrosion/antifreeze 563, 568
  - Antiglare, Interior rear view mirror 208
  - Antiglare, Rear view mirrors\* 208
  - Antilock Brake System see ABS
  - Anti-theft systems 110
    - Anti-theft alarm system 109, 110
    - Immobilizer 109
  - Aquaplaning see Hydroplaning
  - Armrest storage/telephone\* compartment
    - Front 317
  - Ashtrays (Depending on vehicle configuration) 321
  - Aspect ratio 415
  - ATF 381
  - Attaching a trailer 366
  - AUDIO menu 164
  - Audio menu
    - CD operation 165
    - Radio operation 164
    - Satellite radio\* operation 164
  - Auto-dimming\*, Rear view mirrors 208
  - Automatic central locking, Control system 180



- Automatic climate control (3-zone)\* 228
    - Air conditioning refrigerant 563
    - Air conditioning, Cooling 239, 240
    - Air distribution, Front 234
    - Air distribution, Rear 243
    - Air recirculation mode 237
    - Air vents\*, second-row seats 245
    - Air vents\*, third-row seats 245
    - Air vents, Front 234
    - Air volume 235
    - Control panel, Front 230
    - Control panel, Rear 241
    - Deactivating system 232
    - Defogging 235
    - Defrosting 235
    - Maximum cooling, MAXCOOL 237
    - Rear passenger compartment 241
    - Rear window defroster 212
    - Residual engine heat (REST) 241
    - Using driver-side settings for
      - all temperature zones 240
  - Automatic headlamp mode 144
  - Automatic lighting control, Interior lighting 150
  - Automatic locking when driving 128
  - Automatic transmission 56
    - Accelerator position 195
    - Emergency operation
      - (limp-home mode) 200
    - Gear ranges 197
    - Gear selector lever 56, 189
    - Gear selector lever position 192
    - Gear shifting malfunctions 200
    - Hill start assist system 196
    - Kickdown 196
    - Shifting procedure 192
    - Starting the engine 56
    - Steering wheel gearshift control 198
    - Towing a trailer 197
    - Transmission fluid level 381
    - Transmission positions 193
  - Automatic Transmission Fluid see ATF
- B**
- Backrest
    - Seat 46
    - Seat, Lumbar support 137
    - Seat, Multicontour\* 138
  - Backup lamps
    - Messages in the multifunction display 477
    - Replacing bulbs 511
  - Bar 416
  - BAS 103
    - Lamps in instrument cluster 436
    - Messages in the multifunction display 451
  - Batteries, SmartKey
    - Check lamp 112, 115
    - Checking battery condition 120
    - Messages in the multifunction display 466
    - Replacing 502

- Battery, Vehicle 528
  - Charging 535
  - Disconnecting and connecting 530
  - Jump starting 536
  - Removing and installing 530
- Bead 416
- Beverage holder see Cup holder
- Bi-Xenon headlamps\* see headlamps
- Bolts, Spare wheel 494
- Brake fluid 564
  - Checking 376
  - Messages in the multifunction display 469
- Brake lamp
  - Cleaning lenses 429
  - Messages in the multifunction display 477
  - Replacing bulbs 511
- Brake pads 348
  - Messages in the multifunction display 467
- Brakes 348
  - Warning lamp 437
- Break-in period 346
- Bulbs, replacing see Replacing bulbs
- Button for Voice control\* system 30, 156
- C**
- California retail buyers and lessees, Important notice for 11
- Camera see Rear view camera\*
- Can holder see Cup holder
- Capacities and recommended fuel/lubricants 562
- Card holder 33, 37, 320
- Cargo compartment cover blind 310
- Cargo net\* 312
- Cargo tie-down rings 302
- Carpets, Cleaning 433
- Carriers\* 295
- Catalytic converter (gasoline engine) 371
- CD changer 165, 315
- CD player 165
- Center console
  - Lower part 33
  - Upper part (Vehicles with enhanced off-road package\*) 32
  - Upper part (Vehicles without enhanced off-road package\*) 31
- Central locking
  - Automatic 128
  - Locking/unlocking from the inside 128
  - Switch 128
- Certification label 550
- CHECK ENGINE malfunction indicator lamp 439, 440
- Checking tire pressure electronically with the Advanced Tire Pressure Monitoring System (Advanced TPMS)\*, (Canada only) 401
- Checking tire pressure electronically with the Tire Pressure Monitoring System (TPMS), (USA only) 398
- Checklist
  - Off-road driving 357
  - Returning from off-road driving 363

- Children in the vehicle 91
  - Air bags 77, 91
  - Blocking rear door window operation 98
  - Indicator lamp, Front passenger front air bag 85
  - Infant and child restraint systems 86, 92
  - LATCH-type child seat anchors 95
  - Occupant Classification System (OCS) 81
- Cigarette lighter
  - (Depending on vehicle configuration) 323
- Climate control 214
  - Air conditioning refrigerant 563
  - Air conditioning, Cooling 224, 225
  - Air distribution, Front 219
  - Air distribution, rear 227
  - Air recirculation mode 222
  - Air vents\*, second-row seats 220
  - Air vents, Front 220
  - Air volume 220
  - Control panel\*, Rear 226
  - Control panel, Front 216
  - Deactivating system 218
  - Defogging 222
  - Defrosting 221
  - Rear window defroster 212
  - Residual engine heat (REST) 225
- Clock 27, 174
- Cloth upholstery, Cleaning and care of 434
- Cockpit 24
- Cockpit Management and Data System see COMAND System
- Cold tire inflation pressure 416
- Collapsible wheel chock 494
- COMAND System see separate operating instructions
- Combination switch 61, 62, 64, 147
- Compass 344
  - Adjustment 178
  - Calibration 179
  - Calling up the compass 344
- Control and operation of radio transmitters 370
- Control system 155
  - Multifunction display 155
  - Multifunction steering wheel 156
  - Resetting to factory default 169
- Control system menus 155
  - AUDIO 164
  - DISTRONIC\* (Canada only) 167
  - NAV\* 166
  - Off-road 166
  - Settings 168
  - Standard display 162
  - TEL\* 186
  - Trip computer 184
  - Vehicle configuration 182
  - Vehicle status message memory 167
- Control system submenus 159, 161, 171
  - Comfort\* 181
  - Instrument cluster 172, 173
  - Lighting 175
  - Time/Date 174
  - Vehicle 178
- Coolant 381, 567
  - Anticorrosion/antifreeze mixing ratio and quantity 568
  - Capacities 562
  - Checking coolant level 376, 381
  - Messages in the multifunction display 470, 472
  - Temperature 372
  - Temperature display 162

- Corner-illuminating front fog lamps\* 147
  - Messages in the multifunction display 478
  - Replacing bulbs 510
- Crossbars\* 295
- Crossing obstacles 361
- Cruise control 255
  - Activating 257
  - Messages in the multifunction display 452
- Cup holders 320
  - Cleaning 321
  - Front center console 321
  - Front center console, Removing/Installing 321
  - Rear armrest 320
- Curb weight 416
- D**
- Date display, Setting 174
- Daytime running lamp mode 145
  - Setting 175
- Deep water see Standing water
- Defogging windshield 221, 235
- Defrosting, Front 221, 235
- Defrosting, Rear 212
- Delayed shut-off
  - Exterior lamps 176
  - Interior lighting 177
- Department of Transportation see DOT
- Diesel engine
  - Preglow indicator lamp 29
- Differential locks\* 204
  - A few words about 204
  - Messages in the multifunction display 488
  - Switching 205
- Difficulties
  - While driving 65
  - While starting 59
- Digital clock see Clock
- Digital speedometer 155, 163
- Dimensions, Vehicle 560
- Direction of rotation (tires) 387
- Displays
  - Digital speedometer 155, 163
  - Distrionic\* 263
  - Maintenance service indicator 422
  - Messages in the multifunction display 449
  - Multifunction display 155
- Outside temperature 155, 163
  - Selecting 173
- Symbol messages 466
- Text messages 451
- Vehicle status message 168, 449
- Vehicle system settings, Control system 159, 161, 168
- Distance to empty (range), Trip Computer 184
- Distrionic\* 260
  - Activating 266
  - Cleaning system sensor 430
  - Control system 264
  - Deactivating 268
  - Distance warning function\* 272
  - Distance warning function\* activating/deactivating 183
  - Driving hints 270
  - Messages in the multifunction display 453
  - Sensor cover 430
  - Warning and indicator lamps 263

- Door
    - Entry lamps 151
    - Locking, In an emergency 497
    - Locking/unlocking,
      - KEYLESS-GO\* 41, 71
    - Locking/unlocking, SmartKey 40, 70
    - Messages in the multifunction display 474
    - Opening from inside/outside 114, 120
    - Remote door unlock (Tele Aid) 337
    - Unlocking, Mechanical key 496
  - Door control panel 35
  - Door handle 35
  - Door windows see Power windows
  - DOT 410, 416
  - Downhill driving
    - Cruise control 257
  - Downhill Speed Regulation (DSR) 273
    - Messages in the multifunction display 467
  - Drinking and driving 347
  - Driving 53, 347
    - Abroad 370
    - Hydroplaning 352
    - In winter 353, 420
    - Instructions 53, 347
    - Problems 65
    - Safety systems 101
    - Systems 255
    - Through standing water 355
    - Through water 360
    - Tips 195
    - With DISTRONIC\* 270
  - Driving off 60
  - Driving safety systems
    - 4-ETS 107
    - ABS 101
    - BAS 103
    - EBP 107
    - ESP® 103
  - Driving systems 255
    - Adaptive Damping System (ADS)\* 278
    - Air suspension program 278
    - Cruise control 255
    - DISTRONIC\* (Canada only) 260
  - Downhill Speed Regulation (DSR) 273
    - Off-road driving program (Vehicles without enhanced off-road package\*) 277
    - Parktronic system\* 288
    - Rear view camera\* 293
    - Vehicle level control 279
- E**
- Easy-entry/exit feature
    - Activating (driver's seat)\* 181
    - For third-row seats 130
  - Easy-entry/exit feature\* 48
  - EBP 107
    - Indicator and warning lamps 438, 468
  - Electrical connections
    - Trailer 365
  - Electrical fuses see Fuses
  - Electrical system, Technical data 559
  - Electronic Brake Proportioning see EBP
  - Electronic Stability Program see ESP®
  - Electronic Traction System see 4-ETS
  - Emergency calls
    - Tele Aid 333

- Emergency operation
  - Fuel filler flap 497
  - Locking/unlocking the vehicle 496, 497
- Emergency operation (Limp-Home Mode) 200
- Emergency operations
  - Exit for third-row seats 132
  - Remote door unlock, Tele Aid 337
  - Tailgate, Opening from the inside manually 122
- Emergency Tensioning Device see ETD
- Emergency, In case of
  - Battery, Jump starting 536
  - Engine shut-down 545
  - First aid kit 490
  - Flat tire 519
  - Fuses 543
  - Hazard warning flasher 149
  - Instrument cluster, Indicator lamps 436, 437, 438, 439, 440, 441, 442, 443, 444, 446
  - Roadside Assistance 12, 335
  - Towing the vehicle 538
- Emission control 372
  - Information label 551
  - System warranties 10
- Engine
  - Belt layout (GL 450, GL 550) 552
  - Belt layout (GL 320 CDI) 552
  - Break-in recommendations 380
  - Cleaning 427
  - Compartment 378
  - Emergency engine shut-down 545
  - Malfunction indicator lamp 29
  - Maximum engine speed 153, 553
  - Number 551
  - Starting 56
  - Starting with KEYLESS-GO\* 57
  - Starting with the SmartKey 57
  - Tachometer 29, 153
  - Technical data 553
  - Turning off with KEYLESS-GO\* 69
  - Turning off with the SmartKey 69
- Engine coolant see Coolant
- Engine oil 380, 564
  - Adding 381, 564
  - Additives 564
  - Changing 381, 564
  - Checking level 380
  - Checking with the oil dipstick 380
  - Consumption 380
  - Filler neck 381
  - Recommended engine oils and oil filters 564
- Enhanced Off-road Package\*
  - Vehicle level control 283
- ESP® 27, 103
  - Four wheel electronic traction system with ESP® 103
  - Messages in the multifunction display 457, 458
  - Off-road-ESP® 106
  - Warning lamp 27, 441

ETD 89, 446

Safety guidelines 78

Expanding cargo compartment 304

Exterior rear view mirrors 51, 208

Folding 210

Power folding\* 209

Synchronizing 209

## F

Fastening the seat belts 53

Filler neck, Engine oil 381

First aid kit 490

Flat tire 519

Lifting the vehicle 520

Lowering the vehicle 526

Minispare wheel 494

Mounting the spare wheel 520

Preparing the vehicle 520

Floormats 325

## Fluids

Automatic transmission fluid 381,  
562

Brake fluid 377, 563, 564

Capacities 562

Engine coolant 377, 381, 563, 567

Engine oil 380, 562, 564

Power steering fluid 562

Windshield washer and headlamp  
cleaning system\* 377, 569

Fog lamps 146

Corner-illuminating front fog  
lamps\* 147

Messages in the multifunction  
display 478

Rear fog lamp 146

Replacing bulbs 510

4-ETS 107

Off-road - 4-ETS 108

Front air bags 79

Front defroster 221, 235

Front lamps see Headlamps

Front passenger front air bag 74, 79

Messages in the multifunction  
display 460, 461, 462, 463

Front passenger front air bag off indicator  
lamp 31, 32, 85

Front seat head restraints see

Head restraints

Front towing eye 540

Fuel 375, 563

Additives 566

Capacities, Fuel tank 563

Consumption statistics 184, 185

Filling the tank 374

Fuel filler flap and cap 374, 497

Fuel gauge 29

Fuel tank reserve warning lamp 29,  
446

Premium unleaded gasoline 375,  
563, 565

Requirements, Octane rating 565

Fuel cap

Messages in the multifunction  
display 474

- Fuel consumption statistics
  - Since last reset 185
  - Since start 184
- Fuel filler flap 374
  - Locking/unlocking 374
  - Opening 374
  - Opening in an emergency 497
- Fuel tank
  - Capacity 563
  - Filler flap 374
- Fuels, coolants, lubricants etc. 562
- Fuses 543
  - Fuse box in cargo compartment 544
  - Fuse box in engine compartment 544
  - Fuse box in passenger compartment 545
  - Fuse chart 490
  - Replacing 543
- G**
- Garage door opener 338
- Gasoline see Fuel
- GAWR 416
- Gear range
  - Automatic transmission 189, 197
  - Limiting 197
  - Shifting into optimal 199
- Gear selector lever 25, 56, 189
  - Cleaning 433
- Gearshift pattern for automatic transmission 189
- Messages in the multifunction display 459
- Position indicator 192, 197
- Transmission position 192
- Global locking/unlocking see Key, SmartKey
- Glove box 315
- Good visibility 208
- Gross Axle Weight Rating see GAWR
- Gross Trailer Weight see GTW
- Gross Vehicle Weight Rating see GVWR
- Gross Vehicle Weight see GVW
- GTW 416
- GVW 416
- GVWR 416
- H**
- Halogen headlamp see Headlamps
- Hands-free microphone 34
- Hard plastic trim items, cleaning 433
- Hazard warning flasher 149
- Head restraints 46, 133
  - Active head restraint 90, 133
  - Front seats, Adjusting 46
  - Rear seats 91
  - Rear seats, Adjusting 135
  - Rear seats, Removing and installing 136
- Headlamp aim
  - Adjusting 514
- Headlamp cleaning system\* 208, 383
  - Reservoir capacity 563
- Headlamp shut-off delay see Delayed shut-off, Exterior lamps



## Headlamps

- Automatic headlamp mode 144
  - Bi-Xenon\* 477, 508
  - Cleaning lenses 429
  - Cleaning system\* 208, 383
  - Halogen 507
  - High beam see High beam flasher
  - High beam see High beam headlamps
  - Light sensor, Messages in the multifunction display 477
  - Low beam see Low beam headlamps
  - Manual headlamp mode 144
  - Messages in the multifunction display 477, 478, 479, 480, 481, 482
  - Replacing bulbs 504, 505
  - Switch 61, 143
- Heated seats see Seat heating\*
- Heated steering wheel\* 327
- Height adjustment
- Vehicle level control (Vehicles with Air suspension program) 281
  - Vehicle level control (Vehicles with enhanced Off-road Package\*) 283

- High beam flasher 61, 147
- High beam headlamps
- Indicator lamp 29
- Messages in the multifunction display 478
- Replacing bulbs 505, 507, 508
- Switching on 61, 147
- High mounted brake lamp 505
- Hill start assist system 196
- Hinged quarter windows\* see Power windows
- Hood 378
- Messages in the multifunction display 474
- Opening 378
- Hooks
- Loading 304
- Horn 25
- HVAC see Climate control or automatic climate control (3-zone)\*
- Hydroplaning 352

## I

- Identification labels see Labels
- Ignition 42, 44, 57
- Immobilizer 109
- Indicator lamps see Lamps, Indicator and warning
- Infant and child restraint systems see Children in the vehicle
- Inflation pressure see Tires, Inflation pressures
- Inflation pressures
- Information button see Tele Aid
- Infrared reflecting windshield\* 344
- Inside door handle 120
- Instrument cluster 26, 28, 152
- Illumination brightness 153
- Lamps 436
- Messages in display see Multifunction display messages
- Multifunction display 155
- Outside temperature indicator 153
- Selecting language 172
- Instrument lighting see Instrument cluster, Illumination brightness
- Instrument panel see Instrument cluster

Instruments and controls see Cockpit

Interior lighting 149

Delayed shut-off 177

Interior rear view mirror 51

Antiglare positions 208

Auto-dimming mirrors\* 208

Interior storage spaces see

Storage compartments

Intermittent wiping

Windshield wipers 63

## J

Jack 492, 493

Lifting the vehicle 520

Jump starting 536

## K

Key, Mechanical 496

Key, SmartKey 112

Batteries 120, 502

Battery check lamp 112

Checking battery condition 120

Closing the power windows

(Convenience closing feature) 250

Closing the tilt/sliding sunroof\*

(Convenience closing feature) 250

Closing, Power tailgate\* 126

Factory setting 114

Locking/unlocking 40, 70, 112

Locking/unlocking, Global

setting 114

Loss of 120

Messages in the multifunction

display 476

Opening the power windows

(Summer opening feature) 249

Opening the tilt/sliding sunroof\*

(Summer opening feature) 249

Remote control 112

Replacing batteries 502

Selective setting 114

Starter switch positions 42

Starting the engine 56

Turning off the engine 69

Key, SmartKey with KEYLESS-GO\*

Batteries 120, 502

Battery check lamp 115

Checking battery condition 120

Closing the power windows

(Convenience closing feature) 250

Closing the tilt/sliding sunroof\*

(Convenience closing feature) 250

Closing/locking, Power

tailgate\* 127

Factory setting 118

Important notes 117

Locking/unlocking 41, 70, 115

Locking/unlocking, Global

setting 118

Loss of 120

Messages in the multifunction

display 475, 476

Opening the power windows

(Summer opening feature) 249

Opening the tilt/sliding sunroof\*

(Summer opening feature) 249

Remote control 115

Replacing batteries 502

Selective setting 119

Start/stop button 43

Starter switch positions 42, 43

Starting the engine 57

Turning off the engine 69

- Kickdown 196
- Kilopascal 416
- L**
- Labels 550
  - Certification 550
  - Emission control information 551
  - Engine number 551
  - Paintwork code 550
  - Vehicle Identification Number (VIN) 550
- Lamp sensor see Light sensor
- Lamps, exterior 505
  - Front 505
  - Light sensor, Messages in the multifunction display 477
  - Messages in display 477
  - Messages in the multifunction display 477, 479, 481
  - Rear 505
  - Switch 143
- Lamps, indicator and warning
  - ABS 27, 436
  - Adaptive Damping System (ADS)\* 279
  - Alarm system 110
  - Battery (SmartKey with KEYLESS-GO\*) 119
  - Battery (SmartKey) 114
  - Brakes 27, 437, 438
  - Center console 31, 32, 447
  - CHECK ENGINE 29, 439, 440
  - Differential locks\* 205
  - Distance warning lamp\* 263
  - Downhill Speed Regulation 274
  - Engine diagnostics 29, 439, 440
  - ESP® 27, 441
  - Fog lamps, Front/rear 143
  - Front passenger front air bag off 31, 32, 80
  - Fuel reserve 29, 446
  - High beam headlamps 29
  - Instrument cluster 26, 28, 436, 437, 438, 439, 440, 441, 442, 443, 444, 446
  - Off-road driving program 278
  - Parktronic\* 290
- Preglow indicator, Diesel engine 29
- Seat belt telltale 29, 89, 442
- Seat belts 443
- Seat heating\* 138
- Seat ventilation\* 140
- SRS 29, 74, 89, 446
- Turn signals 27
  - Vehicle level control 281, 283
- Language, Setting 172
- LATCH-type child seat anchors see Children in the vehicle
- Layout of poly-V-belt drive (GL 320 CDI) 552
- Layout of poly-V-belt drive (GL 450, GL 550) 552
- Leather upholstery\*, Cleaning and care of 434
- Lever for cruise control 255
- License plate lamps 514
  - Messages in the multifunction display 479
  - Replacing bulbs 505, 514
- Light alloy wheels, Cleaning 432
- Light sensor
  - Messages in the multifunction display 477

Lighter see Cigarette lighter (Depending on vehicle configuration)

Lighting, Exterior and interior 143

Limp-Home Mode 200, 439, 440

Loading see Vehicle loading

Locator lighting 146, 176

Lock buttons, KEYLESS-GO\*  
     Outside door handle 71

Locking the vehicle see Key

Loss of keys, Mechanical key 120

Loss of keys, SmartKey 120

Loss of keys, SmartKey with KEYLESS-GO\* 120

Loss of Service and Warranty Information Booklet 549

Low beam headlamps  
     Messages in the multifunction display 479  
     Replacing bulbs 505  
     Switching on 61, 143

LOW RANGE mode\* 201  
     Messages in the multifunction display 488

Lubricants 562

Lumbar support 137

**M**

Main dimensions 560

Maintenance 12, 422  
     Calling up service indicator display 424  
     Clearing service indicator message 423  
     Maintenance System 422  
     Resetting service indicator 424  
     Service indicator message 422  
     Service term exceeded 423

Maintenance System 422

Manual headlamp mode see Headlamps

Maximum cooling, MAXCOOL\* see Automatic climate control (3-zone)\* 237

Maximum load rating, Tires 417

Maximum loaded vehicle weight, Tires 417

MB Tex upholstery, Cleaning and care of 434

Mechanical key 496

Memory function\* see Seats

Menus see Control system menus

Messages in display see Multifunction display messages

Microphone, Hands-free 34

Minispare wheel see Spare wheel

Mirrors  
     Adjusting 51  
     Auto-dimming rear view mirrors\* 208  
     Exterior rear view mirror 51  
     Interior rear view mirror 51, 208

MON 375, 565

Multicontour seat\* 138

Multifunction display 155  
     Changing settings see Control system menus and Control system sub-menus  
     Displaying current gear range 197  
     Selecting display 173  
     Selecting language 172

Multifunction display messages 449  
 ABS 451  
 ABS, ESP® 451  
 Air suspension 486  
 Air suspension program 486  
 Brake fluid 469  
 Brake lamps 477  
 Brake pads 467  
 Coolant 472  
 Corner-illuminating front fog lamps\* 478  
 Cruise control 452  
 Distronic\* 453  
 Doors 474  
 Downhill Speed Regulation 467  
 EBP 468  
 Engine coolant 470, 472  
 ESP® 441  
 Fog lamps, Front 478  
 Fog lamps, Rear 480  
 Front passenger front air bag 460, 461, 462, 463  
 Fuel cap 474  
 Headlamps 477, 478, 480, 482  
 Hood 474

Key, SmartKey 476  
 Key, SmartKey with KEYLESS-GO\* 475, 476  
 Lamps 477, 478, 479, 480, 482  
 Low tire pressure 464, 484, 485  
 Parking brake 468  
 Parking lamps 480  
 Tele Aid 483  
 Telephone\* 483  
 Turn signals 482  
 Vehicle battery 466  
 Windshield washer fluid 483  
 Multifunction steering wheel 30, 156  
 Button operation 156

## N

Navigation system\* 166  
 See separate COMAND System operating instructions  
 Net, Cargo\* 312  
 Net, Parcel 319  
 Neutral gear position, Automatic transmission 189  
 New vehicle, Break-in period 346  
 Night security illumination 146, 176  
 Normal occupant weight 417  
 Number, Vehicle Identification (VIN) 550

## O

Occupant distribution 417  
 Occupant safety 74  
 Active head restraint 90  
 Air bags 76  
 Children and air bags 77, 91, 93  
 Children in the vehicle 91  
 Fastening the seat belt 53  
 Front passenger front air bag off indicator lamp 81, 85, 86  
 Infant and child restraint systems 92  
 LATCH-type child seat anchors 95  
 OCS 81  
 OCS, Messages in the multifunction display 460, 461, 462, 463  
 Seat belts 53, 78  
 OCS 81  
 Self-test 86  
 Odometer 153, 155, 162

- Off-road - 4-ETS 108
  - Off-road - ABS 102
  - Off-road - ESP® 106
  - Off-road driving
    - Checklist 357, 363
    - Crossing obstacles 361
    - Driving instructions for off-road driving 355
    - Driving through water 360
    - Returning 363
    - Rules 356
    - Special driving features 356
    - Steep terrain 358
  - Off-road driving program (Vehicles without enhanced off-road package\*) 277
  - Oil level see Engine oil, Checking level
  - One-touch gearshifting 199
  - Operating safety 17
  - Operator's Manual 10
  - Ornamental moldings, Cleaning 429
  - Outside temperature see Displays
  - Overdue maintenance service term 423
  - Overhead control panel 34
  - Oxidation catalyst (diesel engine) 371
- P**
- Paintwork code 550
  - Paintwork, Cleaning 426
  - Panic alarm 100
  - Panorama roof, Rear 212
  - Parcel net
    - Front passenger footwell 319
    - Front seat backrests 319
  - Parking 67, 350
    - On hills 67
    - Over things that burn, Potential consequences 67, 371
  - Parking brake 59, 67
    - Lamps, Indicator and warning 437
    - Messages in the multifunction display 468
    - Releasing 59
  - Parking lamps 505
    - Messages in the multifunction display 480
    - Replacing bulbs 509
  - Parking position\*
    - Exterior rear view mirrors 182, 209
  - Parktronic\* 31, 32, 288
    - Cleaning system sensors 430
    - Minimum distance 290
    - Range 289
    - Switching on/off 291
    - System malfunction 292
    - System sensors 289
    - System sensors, Cleaning 430
    - Warning indicators 25, 290
  - Parts service 548
  - PASS AIR BAG OFF indicator lamp see Front passenger front air bag off indicator lamp
  - Passenger compartment 370
    - Fuse box 545
    - Interior lighting 149
    - Interior rear view mirror 34
    - Parcel net in front passenger footwell 319
  - Passenger safety see Occupant safety
  - Pedals 347
  - Phone see Telephone\*

- Plastic and rubber parts, cleaning 432
  - Poly-V-belt drive
    - Layout (GL 320 CDI) 552
    - Layout (GL 450, GL 550) 552
  - Positions (Memory function\*) see Seats
  - Pounds per square inch see PSI
  - Power assistance 348
  - Power outlets 324
  - Power seat see Seats, Power
  - Power tilt/sliding sunroof\* 251
    - Convenience closing feature 250
    - Opening/closing 251
    - Stopping 250
    - Summer opening feature 249
    - Synchronizing 253
  - Power washer 426
  - Power windows 246
    - Cleaning 431
    - Convenience closing feature 250
    - Door windows 247
    - Hinged quarter windows\* 248
    - Opening/closing 246
    - Rear door windows, Blocking operation 98
    - Summer opening feature 249
    - Synchronizing, Door windows 249
  - Practical hints 490
  - Premium unleaded gasoline 565
  - Problems
    - While driving 65
    - With starting see Starting difficulties
    - With the vehicle 18
  - Product information 9
  - Production options weight 417
  - PSI 417
  - Push-starting see Tow-starting
- Q**
- Quarter windows\* see Power windows
- R**
- Radio
    - AUDIO menu, Control system 164
    - Selecting station 164
    - Selecting station (satellite\*) 164
  - Radio transmitters 370
  - Range (distance to empty) 185
  - Range of the sensors
    - Parktronic\* 289
  - Reading lamp, front 149
  - Reading lamp, second-row 151
  - Rear automatic climate control 241, 244
  - Rear center console ashtray see Ashtrays  
(Depending on vehicle configuration)
  - Rear climate control\* 226
  - Rear door windows
    - Blocking operation 98
  - Rear fog lamp see Fog lamps

- Rear lamps see Tail lamps
- Rear panorama roof, Sunshade 212
- Rear seat head restraints see Head restraints
- Rear towing eye 541
- Rear view camera\* 293
- Rear view mirrors see Mirrors
- Rear window defroster 212
- Rear window wiper/washer 64
- Rear windows see Power windows
- Rear wiper blade 517
- Recommended tire inflation pressure 417
- Recovery services, Stolen vehicle (Tele Aid) 338
- Refrigerant, Air conditioning 564
- Refueling 374
- Regular checks 376
- Reminder, Seat belt see Seat belts, Telltale
- Remote control
  - SmartKey 112
  - SmartKey with KEYLESS-GO\* 115
- Remote door unlock, Tele Aid 337
- Replacing bulbs 504
  - Additional turn signals, Exterior rear view mirrors 511
  - Backup lamps 504, 505, 511
  - Brake lamps 504, 505, 511
  - Corner-illuminating front fog lamps\* 504, 505, 510
  - Fog lamp, Rear 504, 505, 511
  - Fog lamps, Front 504, 505, 510
  - High beam headlamps 504, 505, 508
  - License plate lamps 504, 505, 514
  - Low beam headlamps 504, 505, 507
  - Parking/standing lamps 504, 505, 509, 511, 513
  - Side marker lamps, Front 504, 505, 507, 510
  - Side marker lamps, Rear 504, 505, 511, 513
  - Tail lamps 504, 505, 511, 513
  - Turn signal lamps, Front 504, 505, 509
  - Turn signal lamps, Rear 504, 505, 511, 513
- Reporting safety defects 19
- Research Octane Number see RON
- Reset button, In instrument cluster 169
- Reset tool
  - Active head restraints, Depository 500
- Residual heat and ventilation 225, 241
- Reverse gear position, Automatic transmission 189
- Rims 417, 555
- Roadside Assistance 12
- Roadside Assistance button see Tele Aid
- RON 375, 565
- Roof rails 295
- Rubber parts, Cleaning 432
- Run Flat Indicator (Canada only) 396
- S**
- Safety
  - Driving safety systems 101
  - Occupant safety 74
  - Reporting safety defects 19
- Safety belts see Seat belts
- Satellite radio\* 164
- Scissors-type vehicle jack 492, 493
- Seat belt force limiter 89



- Seat belts 86
  - Children in the vehicle 91
  - Cleaning 433
  - Fastening 53
  - Height adjustment 55
  - Messages in the multifunction display 443
  - Proper use of 55, 88
  - Safety guidelines 78
  - Telltale 29, 86, 442
  - Warning lamp 442, 443
- Seat cushion depth see Seats
- Seat heating\* see Seats
- Seat ventilation\* see Seats
- Seating capacity 389
- Seats 45, 130
  - Adjusting 45
  - Cushion depth, Multicontour seat\* 138
  - Easy entry/exit feature for third-row seats 130
  - Emergency exit for third-row seats 132
  - Heating\* 138
  - Lumbar support 137
  - Memory function\* 141
  - Multicontour seat\* 138
  - Second-row, Folding 306
  - Third-row, Folding electrically 305, 308
  - Ventilation\* 140
- Securing cargo 302
  - Cargo tie-down rings 302
  - Hooks 304
- Selector lever see Gear selector lever
- Self-test
  - Lamps in the instrument cluster 436
  - OCS\* 86
  - Tele Aid 332
  - Vehicle battery 528
- Service and warranty information 10
- Service intervals see Maintenance, Service indicator
- Service life
  - Tires 385
- Service see Maintenance
- Service system see Maintenance System
- Service, Parts 548
- Settings
  - Adaptive Damping System (ADS)\* 278
  - Air suspension 278
  - Clock 174
  - Comfort functions\* 181
  - Control system menus 158, 160
  - Control system submenus 159, 161, 171
  - Date 161, 171, 174
  - Daytime running lamp mode 175
  - Factory, SmartKey 114
  - Factory, SmartKey with KEYLESS-GO\* 118
  - Individual, Vehicle 168
  - Instrument cluster 172
  - Language, multifunction display 172, 173
  - Lighting 175
  - Memory function\* 141
  - Resetting all, Control system 169
  - Selective, SmartKey 114
  - Selective, SmartKey with KEYLESS-GO\* 119
  - Time 174
  - Vehicle configuration 182

- Vehicle level control 279
- Shifting
  - Automatic transmission 56, 189
- Side impact air bags 80
- Side marker lamps
  - Cleaning lenses 429
  - Messages in the multifunction display 480
  - Replacing bulbs 510, 513
- Side windows see Power windows
- Sidewall 417
- SmartKey see Key, SmartKey
- SmartKey see Key, SmartKey with KEYLESS-GO\*
- Snow chains 421
- Snow tires see Winter tires
- Spare wheel 494
  - Mounting 520
  - Wheel bolts 492, 525
- Speed settings
  - Cruise control 257
  - Distronic\* 266
- Speedometer 27, 263
- Spinning see Tires, Direction of rotation
- SRS 88
  - Indicator lamp 29, 446
  - Messages in the multifunction display 446
- Standing lamps 143
  - Replacing bulbs 504, 505, 509, 511, 513
- Standing water, Driving through 360
- Starter switch 25, 42
  - Positions 42
- Starting difficulties, Engine 59
- Starting, Engine 56
- Steep terrain, Driving 358
- Steering column 49, 50
- Steering wheel 48
  - Adjustment, Electrically\* 50
  - Adjustment, Manually 49
  - Buttons 30, 156
  - Cleaning 433
- Steering wheel gearshift control, Automatic transmission 198
- Stolen Vehicle Recovery services 338
- Storage compartments 36, 315
  - Cup holder 320
  - Cup holders 320
  - Door pockets 36
  - Front center console 317
  - Glove box 315
  - Parcel net, Front passenger footwell 319
  - Parcel nets, Front seat backrest 319
  - Rear seats, In front of 318
- Storage/telephone\* compartment
  - Armrest, Front 317
- Storing tires 386
- Stranded vehicle 542
- Submenus see Control system submenus
- Sun visors 210
- Sunroof see Power tilt/sliding sunroof\*
- Sunshade
  - Rear panorama roof 212
- Suspension tuning see Air suspension program
- Symbols used in this Operator's Manual 16

## T

- Tachometer 29, 153
  - Displaying current gear range 197
  - Overspeed range 153
- Tail lamps 511
  - Cleaning lenses 429
  - Messages in the multifunction display 481
  - Replacing bulbs 505, 513
- Tailgate
  - Closing from the inside,
    - Electrically\* 125
  - Closing from the outside (vehicles without KEYLESS-GO\*) 126
  - Opening from the inside,
    - Electrically\* 124
  - Opening from the inside,
    - Manually 122
  - Opening from the outside 122
- Tar stains 426
- Technical data 547
  - Air conditioning refrigerant 563, 564
  - Brake fluid 563, 564
  - Capacities fuels, coolants, lubricants etc. 562, 563
  - Coolant 563, 567
  - Dimensions, Vehicle 560
  - Electrical system 559
  - Engine 553
  - Engine oil 562, 564
  - Engine oil additives 564
  - Fuel requirements 565
  - Fuels, coolants, lubricants, etc. 562
  - Gasoline additives 566
  - Main dimensions 560
  - Premium unleaded gasoline 565
  - Rims 555
  - Tires 555
  - Weights 561
  - Windshield washer and headlamp cleaning\* system 563, 569
- Tele Aid 331
  - Call priority 337
  - Emergency calls 333
  - Hands-free microphone 34
  - Information 336
  - Initiating an emergency call manually 334
  - Messages in the multifunction display 483
  - Remote door unlock 337
  - Roadside Assistance 335
  - SOS button 334
  - Stolen Vehicle Recovery services 338
  - System self-check 332
- Telephone cradle\*
  - Changing 330
- Telephone\* 328
  - Answering/ending a call 187
  - Changing mobile phone cradle 330
  - Dialing a number from the phone book 187
  - Ending a call or rejecting an incoming call 187

- Hands-free microphone 34
- Inserting in cradle 329
- Installing a different mobile phone cradle 331
- Messages in the multifunction display 483
- Operation 186
- Phone book 187
- Redialing 188
- Rejecting/ending a call 187
- Removing from cradle 330
- Tray 317
- Temperature
  - Coolant 162
  - Display mode, Status indicator 173
  - Interior temperature 219
  - Interior temperature, setting see Climate control or Automatic climate control (3-zone)\*
  - Outside temperature 163
  - Sensor, Interior temperature 216, 230
  - Sensor, Outside temperature 153
  - Setting display unit 163
- Tether attachment points, see Children in the vehicle
- Third-row sunshade 212
- Three-zone Automatic climate control see Automatic climate control (3-zone) \*
- Ticket holder 320
- Tie-down rings 302
- Tightening torque
  - Screws, crossbars\* 298, 299, 300
  - Wheel bolts 526
- Tilt/sliding sunroof\* see Power tilt/sliding sunroof\*
- Time 174
- TIN 410, 417
- Tire and Loading Information
  - Placard 388
  - Terminology 415
- Tire Identification Number see TIN
- Tire inflation pressure
  - Checking manually 395
  - Checking tire pressure electronically with the Advanced Tire Pressure Monitoring System (Advanced TPMS)\*, (Canada only) 401
  - Checking tire pressure electronically with the Tire Pressure Monitoring System (TPMS), (USA only) 398
  - Recommended tire inflation pressure 393
- Tires 384, 555
  - Advanced Tire Pressure Monitoring System (Advanced TPMS)\*, (Canada only) 401
  - Air pressure 415
  - Care and maintenance 385
  - Chains 421
  - Cleaning 386
  - Combination low tire pressure/TPMS malfunction telltale, USA only 27
  - Direction of rotation, Spinning 387
  - Driving instructions 351
  - Hydroplaning 352
  - Important guidelines 384

- Important notes, Tire inflation pressure 394
- Inflation pressure 377, 393, 395
- Information placard 388
- Inspection 385
- Load rating 406, 407, 417
- Loading Information 388
- Loading terminology 415
- Loading the vehicle 387
- Low tire pressure telltale, Canada only 27, 444
- Maximum load 418
- Messages in the multifunction display 444
- Ply composition and material used 418
- Problems under-/overinflation 405
- Retreads 384
- Rims and tires 555
- Rotating 387
- Run Flat Indicator (Canada only) 396
- Service life 385
- Sizes 406
- Snow chains 421
- Spare wheel 494, 520
- Speed rating 353, 408, 418
- Storing 386
- Temperature 394, 414
- Terminology 415
- TIN 410, 417
- Tire Identification Number see TIN
- Tire Pressure Monitoring System (TPMS), (USA only) 398
- TPMS malfunction telltale 444
- Traction 352, 414, 418
- Tread 418
- Tread depth 386, 420
- Treadwear indicators 418
- Vehicle maximum load on 418
- Wear pattern 419
- Winter tires 420
- Tongue Weight Rating see TWR
- Tools 490
- Top tether
  - Children in the vehicle 96
- Towing
  - Trailer 197, 364, 367
- Towing eye bolt 540
- Towing the vehicle 540, 542
- Tow-starting 536, 538
- Traction 414, 418
  - 4-ETS, Driving safety systems 101, 107
- Trailer
  - Attaching 366
  - Checking weights 366
  - Electrical connections 365
  - Hitch\* 364
  - Loading 365
  - Towing 364, 367
  - Weights and ratings 365
- Transfer case 201
  - LOW RANGE mode\* 201
  - Switching LOW RANGE mode\* 202
- Transmission gear selector lever see Gear selector lever
- Transmission position indicator 155
- Transmission positions 192
- Transmission see Automatic transmission
- Traveling abroad 370
- Tread 418
- Tread depth 386, 420
- Treadwear indicators 418
- Trip computer 184
- Trip odometer, resetting 153

- Turn signal lamps
  - Cleaning lenses 429
  - Messages in the multifunction display 482
  - Replacing bulbs 505
- Turn signals 62
  - Additional in mirrors 505
  - Bulbs 505, 513
  - Cleaning lenses 429
  - Indicator lamps 27
- Turning off the engine 69
- TWR (Tongue Weight Rating) 418

## U

- Uniform Tire Quality Grading Standards 418
- Units, Settings
  - Speedometer 173
  - Temperature 173
- Unleaded gasoline, Premium 563
- Unlocking the vehicle see Key
- Uphill driving
  - Cruise control 257
- Upholstery
  - Cleaning and care of 434
- Useful features 315

## V

### Vehicle

- Battery 528
- Break-in period 346
- Care 425
- Control system, Settings menu 168
- Dimensions 560
- Locking/unlocking 40, 67, 112
- Locking/unlocking in an emergency 496
- Modifications and alterations, Operating safety 17
- Proper use of 17
- Total load limit 418
- Towing 538
- Washing 425
- Weights 561
- Vehicle and trailer weights and ratings 365
- Vehicle care 425
- Vehicle Identification Number see VIN
- Vehicle jack 492, 493
- Vehicle level control 279

- Vehicle level control (Vehicles with enhanced Off-road Package\*) 283
- Vehicle level control\*
  - Messages in the multifunction display 486
- Vehicle lighting 377
- Vehicle loading
  - Cargo compartment cover blind 310
  - Cargo net\* 312
  - Cargo tie-down rings 302
  - Carriers\* 295
  - Crossbars\* 295
  - Expanding cargo compartment 304
  - Hooks 304
  - Load limit 389
  - Loading instructions 301
  - Loading terminology 415
  - Parcel nets 319
  - Roof rails 295
  - Terminology 415
- Vehicle maximum load on the tire 418
- Vehicle Recovery services, Stolen (Tele Aid) 338

- Vehicle status message memory
  - menu 167
- Vehicle tool kit 490
- Vehicle washing 427
- VIN 551
- Voice control system\*
  - Button on multifunction steering
    - wheel 30, 156
  - Hands-free microphone 34
- W**
- Warning indicators
  - Parktronic\* 290
- Warning lamps see Lamps, Indicator and warning
- Warning sounds
  - Distance warning function\* 272
  - Distronic\* 263
  - Exterior lamps 143
  - Parking brake 60
  - Parktronic\* 292
  - Seat belt telltale 86
- Warranty coverage 10, 549
- Washer fluid see Windshield washer fluid
- Washer reservoir level 569
- Washing the vehicle 425
- Wear pattern, Tires 419
- Weights, Vehicle 561
- Wheel
  - Bolts 492
  - Change 520
  - Removing 524
  - Spare 495, 520
  - Tightening torque 526
- Wheel, Tires and 384
- Wheels
  - Sizes 556
- Window curtain air bags 80
- Windows see Power windows
- Windows, cleaning 431
- Windshield
  - Cleaning 431
  - Cleaning wiper blades 431
  - Cleaning, Windshield washer fluid 64
  - Defogging 222, 237
  - Infrared reflecting\* 344
  - Washer fluid 383, 563, 569
- Windshield washer fluid
  - Messages in the multifunction display 483
  - Mixing ratio 569
  - Refilling 383
  - Reservoir level 383
  - Wiping with 64
- Windshield washer system 383, 569
- Windshield wipers 62
  - Cleaning wiper blades 431
  - Fast continuous wiping 63
  - Fast intermittent wiping 63
  - Rear window wiper/washer 64
  - Replacing wiper blades 516
  - Slow continuous wiping 63
  - Slow intermittent wiping 63
- Winter driving 420
  - Snow chains 421
  - Tires 420
- Winter driving instructions 353
- Winter tires 420
- Wood trims, cleaning 434











## Service and Literature

Your authorized Mercedes-Benz Light Truck Center has trained technicians and Genuine Mercedes-Benz Parts to service your vehicle properly.

For expert advice and quality service, contact an authorized Mercedes-Benz Light Truck Center.

If you are interested in obtaining service literature for your vehicle, please contact an authorized Mercedes-Benz Light Truck Center.

We consider this the best way for you to obtain accurate information for your vehicle.

For further information you can find us on the Mercedes-Benz web-site *www.mbusa.com* or *www.mercedes-benz.ca*.

### Warning!



To help avoid personal injury, be extremely careful when performing any service work or repairs. Improper or incomplete service or the use of incorrect or inappropriate parts or materials may damage the vehicle or its equipment, which may in turn result in personal injury.

If you have questions about carrying out any type of service, turn to the advice of an authorized Mercedes-Benz Light Truck Center.

We reserve the right to make changes in design and equipment.

Therefore, information, illustrations and descriptions in this Operator's Manual might differ from your vehicle. Reprinting, translation and copying, even of excerpts, is not permitted without our prior authorization in writing.

Press time March 23, 2007

GSP/TID

Printed in U. S. A

