



SL

Operator's Manual

SL Operator's Manual



2315845500

Order no. 6515 3192 13 Part no. 231 584 55 00 Edition A 2015



Mercedes-Benz

Symbols

Registered trademarks:

- Bluetooth® is a registered trademark of Bluetooth SIG Inc.
- DTS is a registered trademark of DTS, Inc.
- Dolby and MLP are registered trademarks of DOLBY Laboratories.
- BabySmart™, ESP® and PRE-SAFE® are registered trademarks of Daimler AG.
- HomeLink® is a registered trademark of Johnson Controls.
- iPod® and iTunes® are registered trademarks of Apple Inc.
- Logic7® is a registered trademark of Harman International Industries.
- Microsoft® and Windows media® are registered trademarks of Microsoft Corporation.
- SIRIUS is a registered trademark of Sirius XM Radio Inc.
- HD Radio is a registered trademark of iBiquity Digital Corporation.
- Gracenote® is a registered trademark of Gracenote, Inc.
- ZAGATSurvey® and related brands are registered trademarks of ZagatSurvey, LLC.

In this Operator's Manual you will find the following symbols:

WARNING

Warning notes make you aware of dangers which could pose a threat to your health or life, or to the health and life of others.

Environmental note

Environmental notes provide you with information on environmentally aware actions or disposal.

 Notes on material damage alert you to dangers that could lead to damage to your vehicle.

 Practical tips or further information that could be helpful to you.

▶ This symbol indicates an instruction that must be followed.

▶ Several of these symbols in succession indicate an instruction with several steps.

(▷ This symbol tells you where you can find more information about a topic.

▷▷ This symbol indicates a warning or an instruction that is continued on the next page.

Display This font indicates a display in the multifunction display/COMAND display.

Parts of the software in the vehicle are protected by copyright © 2005 The FreeType Project <http://www.freetype.org>. All rights reserved.

Publication details

Internet

Further information about Mercedes-Benz vehicles and about Daimler AG can be found on the following websites:

<http://www.mbusa.com> (USA only)

<http://www.mercedes-benz.ca> (Canada only)

Editorial office

©Daimler AG: Not to be reprinted, translated or otherwise reproduced, in whole or in part, without written permission from Daimler AG.

Vehicle manufacturer

Daimler AG
Mercedesstraße 137
70327 Stuttgart
Germany

Welcome to the world of Mercedes-Benz

We urge you to read this Operator's Manual carefully and familiarize yourself with the vehicle before driving. For your own safety and a longer vehicle life, follow the instructions and warning notices in this manual. Ignoring them could result in damage to the vehicle or personal injury to you or others.

Vehicle damage caused by failure to follow instructions is not covered by the Mercedes-Benz Limited Warranty.

The equipment or product designation of your vehicle may vary depending on:

- model
- order
- country specification
- availability

Mercedes-Benz therefore reserves the right to introduce changes in the following areas:

- design
- equipment
- technical features

The equipment in your vehicle may therefore differ from that shown in the descriptions and illustrations.

The following are integral components of the vehicle:

- Operator's Manual
- Maintenance Booklet
- Equipment-dependent supplements

Keep these documents in the vehicle at all times. If you sell the vehicle, always pass all documents on to the new owner.

The technical documentation team at Daimler AG wishes you safe and pleasant motoring.

Mercedes-Benz USA, LLC

Mercedes-Benz Canada, Inc.

A Daimler Company

Index 4

Introduction 30

At a glance 39

Safety 49

Opening and closing 81

Seats, steering wheel and mirrors .. 107

Lights and windshield wipers 121

Climate control 135

Driving and parking 149

On-board computer and displays 221

COMAND 281

Stowage and features 511

Maintenance and care 533

Breakdown assistance 547

Wheels and tires 567

Technical data 599

- 1, 2, 3 ...**
- 12 V socket**
see Sockets
- 911 emergency call** 380
- A**
- ABS (Anti-lock Braking System)**
Display message 240
Function/notes 72
Important safety notes 72
Warning lamp 271
- Access data of the mobile phone network provider**
Deleting 416
Editing 416
Making entries 413
Selecting 412
- Accident**
Automatic measures after an accident 68
- Activating/deactivating cooling with air dehumidification** 139
- Activating/deactivating Night View Assist Plus**
With spotlight function 213
- Active Blind Spot Assist**
Activating/deactivating (on-board computer) 231
Display message 259
Function/information 214
- Active Body Control (AMG vehicles)**
Display message 257
Driving conditions menu in the COMAND display (AMG vehicles) ... 198
Function/notes 197
- Active Body Control (except AMG vehicles)**
Display message 257
Driving conditions menu in the COMAND display 196
Function/notes 194
- Active Driving Assistance package** .. 214
- Active Lane Keeping Assist**
Activating/deactivating (on-board computer) 231
Display message 259
Function/information 217
- Active light function** 127
- Active Parking Assist**
Display message 260
Function/notes 202
Important safety notes 202
- Active partition (USB devices only)**
Selecting 450
- ADAPTIVE BRAKE** 77
- Adaptive Damping System**
Function/notes 193
- Adaptive Highbeam Assist**
Display message 253
Function/notes 127
Switching on/off 128
- Additives (engine oil)** 604
- Address book**
Browsing 401
Calling up 401
Changing an entry 403
Connecting a call 404
Creating an entry 402
Deleting an entry 402
Deleting contacts 407
Details about an entry 403
Entering characters 299
Entry as a home address 360
Hiding contact details 408
Importing contacts 406
Introduction 401
Receiving vCards 407
Searching for an entry 402
Starting route guidance 404
Voice tag 405
- Address entry menu** 322
- Adjusting the sound settings**
Balance 296
- Adjusting the vehicle height**
Active Body Control (AMG vehicles) 197
Active Body Control (except AMG vehicles) 194

- Air bags**
 - Deployment 64
 - Display message 250
 - Front air bag (driver, front passenger) 57
 - Head bag 58
 - Important safety notes 56
 - Introduction 56
 - Knee bag 57
 - PASSENGER AIR BAG OFF indicator lamp 51
 - Side impact air bag 57
- Air-conditioning system**
 - see Climate control
- AIR FLOW** 141
- AIRSCARF**
 - Switching on/off 113
- AIRSCARF vents**
 - Setting the blower output 148
- Air vents**
 - Glove box 148
 - Important safety notes 147
 - Setting 147
 - Setting the blower output of the AIRSCARF vents 148
 - Setting the center air vents 147
 - Setting the side air vents 148
 - Switching AIRSCARF on/off 113
- Alarm**
 - ATA (Anti-Theft Alarm system) 80
 - Switching off (ATA) 80
 - Switching the function on/off (ATA) 80
- Alarm system**
 - see ATA (Anti-Theft Alarm system)
- Alternative Route** 349
- Ambient lighting**
 - Setting the brightness (on-board computer) 233
 - Setting the color (on-board computer) 233
- AMG**
 - Button for AMG menu 164
 - SETUP 164
- AMG menu (on-board computer)** 236
- Anti-lock braking system**
 - see ABS (Anti-lock Braking System)
- Anti-Theft Alarm system**
 - see ATA (Anti-Theft Alarm system)
- Ashtray** 518
- Assistance display (on-board computer)** 230
- Assistance menu (on-board computer)** 230
- ASSYST PLUS**
 - Displaying a service message 539
 - Hiding a service message 538
 - Resetting the service interval display 539
 - Service message 538
 - Special service requirements 539
- ATA (Anti-Theft Alarm system)**
 - Activating/deactivating 80
 - Function 80
 - Switching off the alarm 80
- ATTENTION ASSIST**
 - Activating/deactivating 231
 - Display message 258
 - Function/notes 209
- Audio**
 - Radio mode 435
- Audio CD/DVD and MP3 mode**
 - Switching to (Rear Seat Entertainment System) 489
- Audio format, setting**
 - Video DVD 477
- Audio menu (on-board computer)** 228
- Authorized Mercedes-Benz Center**
 - see Qualified specialist workshop
- Authorized workshop**
 - see Qualified specialist workshop
- AUTO lights**
 - Display message 253
 - see Lights
- Automatic engine start (ECO start/stop function)** 156
- Automatic engine switch-off (ECO start/stop function)** 155
- Automatic headlamp mode** 122
- Automatic transmission**
 - Accelerator pedal position 162
 - Automatic drive program 164
 - Changing gear 162
 - Display message 265

- Driving tips 162
 - Emergency running mode 168
 - Engaging the park position 160
 - Kickdown 163
 - Manual drive program 165
 - Manual drive program (vehicles with Sports package AMG) 166
 - Overview 159
 - Problem (malfunction) 168
 - Program selector button 163
 - Pulling away 154
 - Selector lever 159
 - Starting the engine 154
 - Steering wheel paddle shifters 164
 - Transmission position display 161
 - Transmission positions 162
 - Automatic transmission emergency mode** 168
 - Autostore** 437
 - AUX (audio)**
 - Notes/socket 471
 - Switching to 471
 - AUX (video)**
 - Setting the volume and sound 479
 - Showing/hiding the menu 479
 - Switching to 478
 - AUX jacks**
 - CD/DVD drive 483
 - Avoiding an area** 371
- B**
- Back button** 293
 - Balance, adjusting** 296
 - BAS (Brake Assist System)** 72
 - BAS PLUS (Brake Assist System PLUS)** 72
 - Bass, setting** 296
 - Battery (SmartKey)**
 - Checking 85
 - Important safety notes 85
 - Replacing 85
 - Battery (vehicle)**
 - Charging 555
 - Display message 255
 - Important safety notes 553
 - Jump starting 557
 - Overview 553
 - Belt**
 - see Seat belts
 - Bird's-eye view (navigation)** 366
 - Blind Spot Assist**
 - see Active Blind Spot Assist
 - Bluetooth®**
 - Activating/deactivating 308
 - Activating audio mode 463
 - Conditions (telephone) 380
 - Connecting another mobile phone 384
 - Connecting audio devices 459
 - Device list 460
 - Entering the passcode 383
 - External authorization 384
 - General information 308
 - Interface 379
 - Introduction 379
 - Reconnecting an audio device 461
 - Searching for a mobile phone 382
 - Settings 308
 - Telephone basic menu 385
 - Telephony 380
 - Telephony notes 379
 - Bluetooth® audio basic display** 463
 - Brake Assist**
 - see BAS (Brake Assist System)
 - Brake fluid**
 - Display message 246
 - Notes 604
 - Brake force distribution, electronic**
 - see EBD (electronic brake force distribution)
 - Brake lamps**
 - Display message 252
 - Brakes**
 - ABS 72
 - BAS 72
 - BAS PLUS 72
 - Brake fluid (notes) 604
 - Display message 240
 - EBD 77
 - High-performance brake system 177
 - Important safety notes 176
 - Maintenance 177
 - Parking brake 172

- Riding tips 176
 - Warning lamp 271
 - Breakdown**
 - see Flat tire
 - see Towing away
 - Brightness, setting (TV, video) 473**
 - Brightness control (instrument cluster lighting) 41**
 - Buttons on the COMAND controller 293**
- C**
- California**
 - Important notice for retail customers and lessees 32
 - Call**
 - Accepting/ending/rejecting 387
 - see Telephone
 - Calling up a malfunction**
 - see Display messages
 - Call lists**
 - Displaying details 395
 - Opening and selecting an entry 395
 - Saving an entry in the address book 395
 - Car**
 - see Vehicle
 - Care**
 - Carpets 546
 - Car wash 540
 - Display 544
 - Exhaust pipe 544
 - Exterior lights 543
 - Gear or selector lever 545
 - Interior 544
 - Matte finish 542
 - Night View Assist Plus 544
 - Notes 539
 - Paint 541
 - Plastic trim 545
 - Power washer 541
 - Rear view camera 543
 - Roof lining 546
 - Seat belt 546
 - Seat cover 545
 - Sensors 543
 - Steering wheel 545
 - Trim pieces 545
 - Washing by hand 540
 - Wheels 542
 - Windows 542
 - Wiper blades 543
 - Wooden trim 545
 - Car key**
 - see SmartKey
 - Car pool lanes 321**
 - Car wash (care) 540**
 - Category list (music search) 452**
 - CD**
 - Copy protection 452
 - Fast forward/fast rewind 448
 - General information 452
 - Inserting 444
 - Inserting/loading (Rear Seat Entertainment System) 489
 - Mode, switching to 446
 - Multisession 451
 - Notes on discs 452
 - Pause function 447
 - Removing/ejecting (Rear Seat Entertainment System) 489
 - Safety notes 444
 - Selecting a media type 447
 - Selecting a track 447
 - Sound settings (balance, bass, treble) 296
 - CD/DVD**
 - Inserting 445
 - Removing 445
 - CD mode**
 - Playback options 450
 - CD player/CD changer (on-board computer) 228**
 - Center console**
 - Lower section 45
 - Lower section (AMG vehicles) 46
 - Upper section 44
 - Central locking**
 - Automatic locking (on-board computer) 234
 - Locking/unlocking (SmartKey) 82

- Changing direction**
 - Announcement phase 345
 - Change of direction phase 345
 - Preparation phase 345
- Changing the character set** 302
- Channel presets** 436
- Characters**
 - Changing the character set 300
 - Changing the language 300
 - Deleting 301
 - Entering 301
 - Entering (address book, phone book) 299
 - Entering (navigation) 301
 - Moving the cursor 301
 - Switching to letters 300
- Children**
 - Restraint systems 69
 - Special seat belt retractor 69
- Child seat**
 - Forward-facing restraint system 70
 - On the front-passenger seat 70
 - Rearward-facing restraint system 70
- Cigarette lighter** 518
- Cleaning**
 - Mirror turn signal 543
- Clear button** 293
- Climate control**
 - Automatic climate control (dual-zone) 137
 - Controlling automatically 141
 - Cooling with air dehumidification .. 139
 - Defrosting the windows 144
 - Defrosting the windshield 143
 - General notes 136
 - Indicator lamp 141
 - Information about using automatic climate control 138
 - Maximum cooling 144
 - Overview of systems 136
 - Problems with cooling with air dehumidification 141
 - Problem with the rear window defroster 146
 - Refrigerant 606
 - Refrigerant filling capacity 607
 - Setting the air distribution 142
 - Setting the airflow 143
 - Setting the air vents 147
 - Setting the climate mode (AIR FLOW) 141
 - Setting the temperature 142
 - Switching air-recirculation mode on/off 146
 - Switching on/off 139
 - Switching residual heat on/off 146
 - Switching the rear window defroster on/off 144
 - Switching the ZONE function on/off 143
- Cockpit**
 - Overview 40
 - see Instrument cluster
- Color, setting (TV, video)** 473
- COMAND**
 - Active multicontour seat 314
 - Basic functions 295
 - Calling up drive status regulator (ABC) 313
 - Display 286
 - Examples of operation 293
 - Importing POIs 422
 - Menu overview 288
 - Multicontour seat 314
 - Seat functions 314
 - Settings 433
 - Switching on/off 295
- COMAND and Internet**
 - see Online and Internet functions
- COMAND controller** 292
- COMAND control panel** 291
- COMAND display**
 - Cleaning 544
 - Cleaning instructions 290
 - Driving conditions menu (AMG vehicles) 198
 - Driving conditions menu (except AMG vehicles) 196
 - Setting 306
 - Switching on/off 290
- Combination switch** 125
- Compass function** 373
- Connecting a USB device** 445

Consumption statistics (on-board computer)	225
Contacts	
Deleting	407
Importing	406
Contrast, setting (TV, video)	473
Convenience closing feature	99
Convenience opening feature	
see Side windows	
Coolant (engine)	
Checking the level	537
Display message	254
Filling capacity	605
Important safety notes	605
Temperature (on-board computer)	236
Temperature gauge	222
Warning lamp	277
Cooling	
see Climate control	
Copy protection (CD/DVD)	452
Copyright	37
Cornering light function	
Display message	251
Function/notes	126
Country-specific information (navigation)	374
Crash-responsive emergency lighting	129
Cruise control	
Cruise control lever	180
Deactivating	182
Display message	262
Driving system	180
Function/notes	180
Important safety notes	180
Setting a speed	181
Storing and maintaining current speed	181
Cup holder	
Center console	516
Important safety notes	516
Customer Assistance Center (CAC)	35
Customer Relations Department	35

D

Data

 see Technical data

Data medium

CD/DVD	452
MP3	451
MUSIC REGISTER	455

Date format, setting

Day design, setting

Daytime running lamps

Display message	253
Function/notes	122
Switching on/off (on-board computer)	232

Declarations of conformity

Delayed switch-off

Exterior lighting (on-board computer)	233
Interior lighting	234

Deleting

Call lists	396
------------------	-----

Destination

Assigning a destination to an address book entry	362
--	-----

Destination (navigation)

Displaying information	350
Entering a destination by address ..	322
Entering a destination using the map	329
Entering a point of interest	334
Entering using geo-coordinates	330
Entering using Mercedes-Benz Apps	330
Saving	361
Selecting from the destination memory	328
Selecting from the list of last destinations	328
Selecting storage options	362
Storing after destination entry	362
Storing during route guidance	362

Destination memory (navigation)

Deleting an entry	363
Entering/saving your home address	327
Previous destinations	364

- Diagnostics connection** 34
- Dialing a number (telephone)** 387
- Digital speedometer** 226
- DISC button**
 - Activating audio CD or MP3 mode .. 446
 - Activating Bluetooth® Audio 463
 - Switching on the Media Interface .. 466
 - Switching to the MUSIC REGIS-
TER 456
- Display**
 - Selecting the design 306
- Displaying the arrival time** 350
- Displaying the distance to the des-
tination** 350
- Displaying the track and album** 450
- Display messages**
 - ASSYST PLUS 538
 - Calling up (on-board computer) 239
 - Driving systems 257
 - Engine 254
 - General notes 239
 - Hiding (on-board computer) 239
 - KEYLESS-GO 268
 - Lights 251
 - Safety systems 240
 - SmartKey 268
 - Tires 263
 - Vehicle 265
- Distance recorder**
 - see Trip odometer
- Distance warning (warning lamp)** 279
- DISTRONIC PLUS**
 - Cruise control lever 184
 - Deactivating 189
 - Display message 260
 - Displays in the multifunction dis-
play 189
 - Driving tips 190
 - Function/notes 182
 - Important safety notes 183
 - Setting the specified minimum
distance 188
 - Warning lamp 279
- Dolby® Digital** 297
- Doors**
 - Automatic locking (on-board com-
puter) 234
 - Automatic locking (switch) 89
 - Central locking/unlocking
(SmartKey) 82
 - Control panel 48
 - Display message 266
 - Emergency locking 90
 - Emergency unlocking 90
 - Important safety notes 88
 - Opening (from inside) 88
 - Overview 88
 - Power closing 90
- Drinking and driving** 174
- Drive program**
 - Automatic 164
 - Display 161
 - Manual 165
 - Manual (vehicles with Sports
package AMG) 166
 - SETUP (on-board computer) 236
- Drive program selector** 163
- Driver's door**
 - see Doors
- Driving abroad**
 - Mercedes-Benz Service 539
 - Symmetrical low beam 122
- Driving on flooded roads** 179
- Driving safety systems**
 - ABS (Anti-lock Braking System) 72
 - ADAPTIVE BRAKE 77
 - BAS (Brake Assist System) 72
 - BAS PLUS (Brake Assist System
PLUS) 72
 - EBD (electronic brake force distri-
bution) 77
 - ESP® (Electronic Stability Pro-
gram) 74
 - ETS (Electronic Traction System) 74
 - Important safety information 71
 - Overview 71
 - PRE-SAFE® Brake 77
 - STEER CONTROL 79

- Driving systems**
- Active Blind Spot Assist 214
 - Active Body Control (AMG vehicles) 197
 - Active Body Control (except AMG vehicles) 194
 - Active Driving Assistance package 214
 - Active Lane Keeping Assist 217
 - Active Parking Assist 202
 - Adaptive Damping System 193
 - ATTENTION ASSIST 209
 - Cruise control 180
 - Display message 257
 - DISTRONIC PLUS 182
 - HOLD function 191
 - Night View Assist Plus 210
 - PARKTRONIC 199
 - RACE START (AMG vehicles) 192
 - Rear view camera 206
- Driving tips**
- AMG ceramic brakes 177
 - Automatic transmission 162
 - Brakes 176
 - Break-in period 150
 - Checking brake lining thickness 178
 - DISTRONIC PLUS 190
 - Downhill gradient 176
 - Drinking and driving 174
 - Driving abroad 122
 - Driving in winter 179
 - Driving on flooded roads 179
 - Driving on wet roads 179
 - Exhaust check 175
 - Fuel 174
 - General 174
 - Hydroplaning 179
 - Icy road surfaces 179
 - Limited braking efficiency on salted roads 177
 - Snow chains 571
 - Symmetrical low beam 122
 - Wet road surface 176
- DVD**
- Copy protection 452
 - Inserting 444
 - Inserting/loading (Rear Seat Entertainment System) 489
 - Notes on discs 452
 - Removing/ejecting (Rear Seat Entertainment System) 489
 - Sound settings (balance, bass, treble) 296
- DVD video**
- Operating (on-board computer) 229
 - Rear Seat Entertainment System ... 492
- E**
- EASY-ENTRY feature**
- Activating/deactivating 235
 - Function/notes 115
- EASY-EXIT feature**
- Crash-responsive 116
 - Function/notes 115
 - Switching on/off 235
- EBD (electronic brake force distribution)**
- Display message 242
 - Function/notes 77
- ECO display**
- Function/notes 175
 - On-board computer 226
- ECO start/stop function**
- Automatic engine start 156
 - Automatic engine switch-off 155
 - Deactivating/activating 156
 - General information 155
 - Important safety notes 155
 - Introduction 155
- Electronic Stability Program**
- see ESP® (Electronic Stability Program)
- Emergency**
- Automatic measures after an accident 68
- Emergency release**
- Driver's door 90
 - Trunk 96
 - Vehicle 90
- Emergency Tensioning Devices**
- Activation 64
- Emissions control**
- Service and warranty information 31

- Engine**
- Check Engine warning lamp 277
 - Display message 254
 - ECO start/stop function 155
 - Engine number 601
 - Irregular running 158
 - Jump-starting 557
 - Starting problems 158
 - Starting the engine with the
 - SmartKey 154
 - Starting with KEYLESS-GO 154
 - Switching off 172
 - Tow-starting (vehicle) 562
- Engine electronics**
- Problem (malfunction) 158
- Engine oil**
- Adding 536
 - Additives 604
 - Checking the oil level 535
 - Checking the oil level using the
 - dipstick 535
 - Display message 256
 - Filling capacity 604
 - Notes about oil grades 603
 - Notes on oil level/consumption 535
 - Temperature (on-board com-
 - puter) 236
 - Viscosity 604
- Entering an intersection name** 325
- Entering a street name** 323
- Entering the address (example)** 322
- Entering the city** 323
- Entering the house number** 323
- Entry**
- Deleting 302
 - Saving 300
- ESP® (Electronic Stability Pro-gram)**
- AMG menu (on-board computer) ... 236
 - Characteristics 75
 - Deactivating/activating (AMG
 - vehicles) 76
 - Deactivating/activating (notes;
 - except AMG vehicles) 75
 - Display message 240
 - ETS 74
 - Function/notes 74
 - General notes 74
 - Important safety information 74
 - Warning lamp 273
- ETS (Electronic Traction System)** 74
- Example display**
- Audio CD mode 446
 - MUSIC REGISTER 455
- Exhaust check** 175
- Exhaust pipe (cleaning instruc-tions)** 544
- Exterior lighting**
- Setting options 122
 - see Lights
- Exterior mirrors**
- Adjusting 116
 - Dipping (automatic) 117
 - Folding in/out (electrically) 117
 - Folding in when locking (on-board
 - computer) 235
 - Out of position (troubleshooting) ... 117
 - Storing settings (memory func-
 - tion) 119
 - Storing the parking position 118
- Eyeglasses compartment** 513
- F**
- Factory setting (reset function)** 311
- Fast forward**
- Audio mode (CD, MP3) 448
 - Video DVD 475
- Fast rewind**
- Audio mode (CD, MP3) 448
 - Video DVD 475
- Favorites (Internet)** 431
- Favorites button** 309
- Filler cap**
- see Fuel filler flap
- Filling capacities (Technical data)** ... 601
- Flat tire**
- MOExtended tires 549
 - Preparing the vehicle 548
 - TIREFIT kit 550
- Floormats** 531
- Frequencies**
- Adjusting for radio stations 437

- Front-passenger seat**
 Adjusting from the driver's seat 110
- Fuel**
 Additives 603
 Consumption statistics 225
 Displaying consumption 313
 Displaying the current consumption 226
 Displaying the range 226
 Driving tips 174
 E10 602
 Fuel gauge 41
 Grade (gasoline) 602
 Important safety notes 602
 Problem (malfunction) 171
 Refueling 168
 Tank content/reserve fuel 602
- Fuel filler flap**
 Opening 169
- Fuel level**
 Calling up the range (on-board computer) 226
- Fuel tank**
 Capacity 602
 Problem (malfunction) 171
- Fuse allocation chart (vehicle tool kit)** 548
- Fuses**
 Allocation chart 562
 Before changing 562
 Dashboard fuse box 563
 Fuse box in the engine compartment 563
 Fuse box in the rear compartment .. 564
 Important safety notes 562
- G**
- Garage door opener**
 Clearing the memory 530
 General notes 527
 Important safety notes 528
 Opening/closing the garage door .. 530
 Programming (button in the rear-view mirror) 528
- Gasoline** 602
- Gear indicator (on-board computer)** 236
- Genuine parts** 30
- Glass roof (sunblind)** 104
- Glove box** 512
- Google™ Local Search**
 Importing a destination/route 419
 Popular Searches 420
 Search 418
 Search history 420
 Selecting a search position 419
 Using as the destination 419
- GPS reception** 319
- Gracenote® Media Database** 448
- H**
- Handbrake**
 see Parking brake
- HANDS-FREE ACCESS** 93
- Harman/kardon® Logic 7® surround sound system**
 see Surround sound (harman/kardon® surround sound system)
- Hazard warning lamps**
 Display message 267
 Switching on/off 126
- Head bags**
 Display message 248
 Operation 58
- Heading up (navigation)** 366
- Headlamps**
 Cleaning system (notes) 606
 Fogging up 128
 see Automatic headlamp mode
- Head level heating (AIRSCARF)** 113
- Headphones**
 Changing batteries 485
- Head restraints**
 Adjusting 111
 see NECK-PRO head restraints
- Heating**
 see Climate control
- High-beam headlamps**
 Display message 252
 Switching on/off 125
- Highway information** 369
- Hill start assist** 154

- HOLD function**
 Activating 192
 Deactivating 192
 Display message 258
 Function/notes 191
- Home address**
 Entering and saving 327
 Selecting from the destination
 memory 328
- Hood**
 Closing 535
 Display message 266
 Important safety notes 534
 Opening 534
- Horn** 40
- Hydroplaning** 179
- I**
- Ignition lock**
 see Key positions
- Immobilizer** 79
- Incident (traffic report)** 355
- Indicator lamps**
 see Warning and indicator lamps
- Indicators**
 see Turn signals
- Instrument cluster**
 Overview 41
 Warning and indicator lamps 42
- Instrument cluster lighting** 222
- Interface (USB, iPod®)**
 see Media Interface
- Interior lighting**
 Automatic control 129
 Delayed switch-off (on-board
 computer) 234
 Emergency lighting 129
 Manual control 129
 Overview 128
 Reading lamp 128
 Setting the brightness of the
 ambient lighting (on-board com-
 puter) 233
 Setting the color of the ambient
 lighting (on-board computer) 233
- Internet**
 Calling up the carousel view 426
 Conditions for access 409
 Creating favorites 432
 Entering the URL 427
 Favorites manager 432
 Favorites menu 432
 Menu functions 429
 Opening favorites 431
 Selecting/setting access data 411
 Selecting favorites 428
- Internet radio**
 Calling up 426
 Searching for stations 426
- iPod®**
 Alphabetical track selection 469
 Connecting to the Media Inter-
 face 465
 Selecting a category/playlist 468
- iTunes®** 469
- J**
- Jack**
 Storage location 548
 Using 590
- Jump starting (engine)** 557
- K**
- KEYLESS-GO**
 Convenience closing feature 99
 Display message 268
 Locking 83
 Removing the Start/Stop button ... 153
 Start/Stop button 151
 Starting the engine 154
 Unlocking 83
- Key positions**
 KEYLESS-GO 151
 SmartKey 151
- Kickdown**
 Driving tips 163
 Manual drive program 167
- Knee bag** 57

L

Lamps

see Warning and indicator lamps

Lane Keeping Assist

see Active Lane Keeping Assist

Lane recommendations

Explanation 346

Presentation 346

Lap time (RACETIMER) 237

License plate lamp (display message) 252

Light function, active

Display message 253

Lights

Activating/deactivating the interior lighting delayed switch-off 234

Active light function 127

Automatic headlamp mode 122

Cornering light function 126

Driving abroad 122

Fogged up headlamps 128

Hazard warning lamps 126

High beam flasher 126

High-beam headlamps 125

Light switch 122

Low-beam headlamps 123

Parking lamps 124

Setting the brightness of the ambient lighting (on-board computer) 233

Setting the color of the ambient lighting (on-board computer) 233

Standing lamps 124

Switching the daytime running lamps on/off (on-board computer) 232

Switching the exterior lighting delayed switch-off on/off (on-board computer) 233

Switching the spotlight on/off 233

Switching the surround lighting on/off (on-board computer) 233

Turn signals 125

see Interior lighting

see Replacing bulbs

Light sensor (display message) 253

List of access data

New provider 413

List of mobile phone network providers

Calling up 411

Empty 411

With the selected provider 412

Loading aid (trunk)

Raising/lowering the roof 514

Locking

see Central locking

Locking (doors)

Automatic 89

Emergency locking 90

From inside (central locking button) 89

Locking centrally

see Central locking

Locking verification signal (on-board computer) 234

Low-beam headlamps

Display message 251

Setting for driving abroad (symmetrical) 122

Switching on/off 123

Luggage cover

see Trunk partition

Lumbar support

Adjusting (COMAND) 315

M

M+S tires 570

MAGIC SKY CONTROL 105

Malfunction message

see Display messages

Map (navigation)

Adjusting the scale 365

Arrival time/distance to the destination 368

City model 369

Geo-coordinate display 368

Heading 366

Information in the display 368

Map settings 366

Moving 365

North orientation 366

- Notes 365
- Point of interest symbols 367
- Road display 368
- Saving the crosshair position 365
- Showing the map data version 374
- Topographical map 369
- Updating 375
- Updating process 375
- Matte finish (cleaning instructions)** 542
- mbrace**
 - Call priority 523
 - Display message 246
 - Downloading destinations (COMAND) 523
 - Downloading routes 526
 - Emergency call 520
 - General notes 519
 - Geo fencing 527
 - Locating a stolen vehicle 525
 - MB info call button 522
 - Remote vehicle locking 525
 - Roadside Assistance button 521
 - Search & Send 524
 - Self-test 520
 - Speed alert 527
 - System 520
 - Triggering the vehicle alarm 527
 - Vehicle remote malfunction diagnosis 526
 - Vehicle remote unlocking 524
- Mechanical key**
 - Function/notes 84
 - Locking vehicle 90
 - Unlocking the driver's door 90
- Media Interface**
 - Alphabetical track selection 469
 - Basic menu 467
 - Connecting an external audio source 465
 - Connection options 465
 - iPod® 465
 - Mode 465
 - MP3 player 465
 - Notes for the MP3 player 470
 - Playback options 470
 - Selecting categories 468
 - Selecting folders 468
 - Selecting music files 467
 - Selecting playlists 468
 - Switching to 466
 - USB mass storage device 465
 - see Separate operating instructions
- Media list** 447
- Memory card (audio)** 228
- Memory function** 119
- Message memory (on-board computer)** 239
- Messages**
 - see Display messages
- Microphone, switching on/off** 388
- Mirrors**
 - see Exterior mirrors
 - see Vanity mirror (in the sun visor)
- Mobile phone**
 - Authorizing 383
 - Connecting (Bluetooth® interface) 381
 - De-authorizing 385
 - External authorization 384
 - Menu (on-board computer) 229
 - Registering (authorizing) 383
- Modifying the programming (SmartKey)** 83
- MOExtended tires** 549
- Mounting wheels**
 - Lowering the vehicle 593
 - Mounting a new wheel 592
 - Preparing the vehicle 589
 - Raising the vehicle 590
 - Removing a wheel 592
 - Securing the vehicle against rolling away 590
- MP3**
 - Bit/sampling rates 451
 - Copyright 452
 - Data medium 451
 - Fast forward/fast rewind 448
 - File systems 451
 - Formats 451
 - Mode, switching to 446
 - Notes 451
 - Operation 228
 - Pause function 447

- Playback options 450
 - Safety notes 444
 - Selecting a media type 447
 - Selecting a track 447
 - Sound settings (balance, bass, treble) 296
 - Multifunction display**
 - Function/notes 224
 - Permanent display 232
 - Multifunction steering wheel**
 - Adjusting the volume 295
 - Operating the on-board computer .. 223
 - Overview 43
 - Multisession CD** 451
 - Music files**
 - Recording 456
 - MUSIC REGISTER**
 - Deleting all music files 457
 - Deleting individual music files 458
 - Disk space information 457
 - General notes 455
 - Playback options 458
 - Switching to 455
 - Music search** 452
- N
- Navigation**
 - Adjusting the volume of the navigation announcements 295
 - Alternative route 349
 - Avoiding an area 371
 - Basic settings 320
 - Blocking a route section affected by a traffic jam 349
 - Compass function 373
 - Destination/route download 421
 - Destination memory 360
 - Displaying destination information (arrival time, distance to destination) 350
 - Entering/saving your home address 327
 - Entering a destination 322
 - Entering a destination by address .. 322
 - Entering a destination using the map 329
 - Entering a point of interest 334
 - Entering characters (character bar) 301
 - Freeway information 369
 - General notes 319
 - GPS reception 319
 - Important safety notes 318
 - Lane recommendation 346
 - List of areas 372
 - Map settings 365
 - Menu (on-board computer) 227
 - Off-road/off-map (off-road destination) 354
 - Previous destinations 364
 - Reading out traffic reports 359
 - Repeating announcements 347
 - Route guidance 344
 - Search & Send 343
 - Selecting a destination from the destination memory 328
 - Selecting a destination from the list of last destinations 328
 - Selecting your home address 328
 - Setting options for destination/route download 424
 - Setting route options (avoiding: highways, toll roads, tunnels, ferries) 320
 - Setting the route type (short route, fast route, dynamic route or economic route) 320
 - Showing/hiding the menu 320
 - Starting route calculation 327
 - Switching announcements on/off 348
 - Switching to 319
 - Navigation announcements**
 - Switching off 295
 - NECK-PRO head restraints**
 - Important safety notes 66
 - Operation 66
 - Resetting after being triggered 67
 - Night View Assist Plus**
 - Activating/deactivating 212
 - Cleaning 544
 - Display message 258
 - Function/notes 210
 - Problem (malfunction) 214

Showing the image on the COMAND display	318
Switching automatic activation on/off	318
North orientation (navigation)	366
Notes on breaking-in a new vehicle	150

O

Occupant Classification System (OCS)

Conditions	59
Faults	63
Operation	59
System self-test	61

Occupant safety

Automatic measures after an accident	68
Children in the vehicle	68
Important safety notes	51
Pets in the vehicle	71
PRE-SAFE® (anticipatory occupant protection)	67

OCS

Conditions	59
Faults	63
Operation	59
System self-test	61

Odometer

225

Off-map

355

Off-road

354

Oil

see Engine oil

On-board computer

AMG menu	236
Assistance menu	230
Audio menu	228
Convenience submenu	235
Displaying a service message	539
Display messages	239
DISTRONIC PLUS	189
Factory settings submenu	236
Important safety notes	222
Instrument cluster submenu	232
Lighting submenu	232
Menu overview	225
Message memory	239

Navigation menu	227
Operation	223
RACETIMER	237
Service menu	231
Settings menu	232
Standard display	225
Telephone menu	229
Trip menu	225
Vehicle submenu	234
Video DVD operation	229

Online and Internet functions

Ending the connection	417
Establishing/ending the connection	417
Further Mercedes-Benz Apps	425
Manually setting the access data of the mobile phone network provider	413
Mercedes-Benz Mobile Website	425
Options menu	423
Resetting settings	425
Selecting options for the local search	423
Selecting the access data of the mobile phone network provider	412
Setting options for destination/route download	424

Operating safety

Declaration of conformity	34
Important safety notes	33

Operating system

see On-board computer

Operator's Manual

Vehicle equipment	31
-------------------------	----

Outside temperature display

223

Overhead control panel

47

Own address

360

P

Paint code number

600

Paintwork (cleaning instructions) ...

541

Panic alarm

50

Parking

Engaging park position	160
Important safety notes	171
Parking brake	172

- Position of exterior mirror, front-passenger side 118
- Rear view camera 206
- see PARKTRONIC
- Parking aid**
 - Active Parking Assist 202
 - see Exterior mirrors
 - see PARKTRONIC
- Parking assistance**
 - see PARKTRONIC
- Parking brake**
 - Display message 242
 - Electric parking brake 172
 - Warning lamp 276
- Parking lamps**
 - Switching on/off 124
- PARKTRONIC**
 - Deactivating/activating 201
 - Driving system 199
 - Function/notes 199
 - Important safety notes 199
 - Problem (malfunction) 202
 - Range of the sensors 199
 - Warning display 200
- PASSENGER AIR BAG OFF**
 - Indicator lamp 51
 - Problems (malfunction) 250
- Pause function**
 - Audio mode (CD, MP3) 447
 - Video DVD 476
- Personal POIs**
 - Acoustic notification 340
 - Calling up the menu 339
 - Displaying on the map 339
 - Managing categories 340
 - Saving 341
 - Selecting as the destination 342
 - Settings 339
 - Visual information 340
- Pets in the vehicle** 71
- Phone book**
 - Adding a number to an address
 - book entry 394
 - Calling up 391
 - Creating a new entry 393
 - Deleting an entry 393
 - Entering characters 299
 - Icon overview 392
 - Searching for an entry 392
- Phone call**
 - Dialing 387
- Picture settings (TV, video)** 473
- Picture viewer**
 - Displaying pictures 479
 - Introduction 479
- Plastic trim (cleaning instructions)** 545
- Playback options**
 - Audio mode (CD, MP3) 450
- POI (navigation)**
 - Category 336
 - Defining the position for the POI
 - search 335
 - Entering 334
 - Entering a point of interest using the map 338
 - List 336
 - ZAGAT® survey service 338
 - see Personal POIs
- Point of interest icon**
 - Setting 367
- Point of interest list**
 - With character bar 337
- Power locks** 90
- Power washers** 541
- Power windows**
 - see Side windows
- PRE-SAFE® (anticipatory occupant protection)**
 - Display message 246
 - Operation 67
- PRE-SAFE® Brake**
 - Activating/deactivating 231
 - Display message 247
 - Function/notes 77
 - Warning lamp 279
- Previous destinations (navigation)** .. 364
- Program selector button** 163
- Protection against theft**
 - ATA (Anti-Theft Alarm system) 80
 - Immobilizer 79
- Protection of the environment**
 - General notes 30

Pulling away (automatic transmission) 154

Q

Qualified specialist workshop 35

R

RACE START

Important safety notes 192

RACETIMER (on-board computer) 237

Radar sensor system

Activating/deactivating 235

Display message 258

Radio

Overview 435

Selecting a station 228

Setting a station 436

Sound settings (balance, bass, treble) 296

Storing stations 437

Switching HD Radio on/off 435

Switching on 435

Switching wavebands 436

Radio-wave reception/transmission in the vehicle

Declaration of conformity 34

Read-aloud function 359

Reading lamp 128

Real-time traffic reports 355

Rear-compartment screens 482

Rear fog lamp

Display message 252

Rear lamps

see Lights

Rear Seat Entertainment System

Active COMAND source 496

Adjusting sound settings 487

Adjusting the brightness 487

Adjusting the color 487

Adjusting the contrast 487

AUX mode 498

CD/DVD audio and MP3 mode 489

Changing the batteries 485

Changing the picture format 488

Cordless headphones 484

Multiple users 487

Operating with the headphones 486

Picture settings 487

System settings 488

Using the main loudspeaker 486

Video DVD mode 492

Rear view camera

Cleaning instructions 543

Displaying the image 317

Function/notes 206

Switching on/off 207

Rear-view mirror

Dipping (automatic) 117

Rear window defroster

Problem (malfunction) 146

Switching on/off 145

Receiving vCards 407

Redialing (telephone) 388

Refrigerant (air-conditioning system)

Important safety notes 606

Refueling

Fuel gauge 41

Important safety notes 168

Refueling process 169

see Fuel

Remote control

Button lighting 483

Programming (garage door opener) 528

Rear Seat Entertainment System ... 482

Replacing bulbs

General notes 129

Reporting safety defects 35

Reserve (fuel tank)

see Fuel

Reserve fuel

Display message 256

Warning lamp 277

see Fuel

Reset function 311

Resetting (factory settings) 311

Residual heat (climate control) 146

Restraint system

Display message 248

Introduction 50

Warning lamp 276

Warning lamp (function) 51

- Reverse gear (selector lever)** 159
 - Reversing feature**
 - Side windows 97
 - Trunk lid 91
 - Reversing lamps (display message)** 252
 - Roadside Assistance (breakdown)** 32
 - Roll bar**
 - Display message 247
 - Operation 63
 - Roller sunblind** 104
 - Roof**
 - Display message 266
 - Important safety notes 100
 - Opening/closing (with roof switch) 101
 - Opening/closing (with Smart-Key) 102
 - Overview 100
 - Problem (malfunction) 106
 - Relocking 102
 - Roof lining and carpets (cleaning guidelines)** 546
 - Roof switch** 101
 - Route**
 - Estimated time of arrival 350
 - Route (navigation)**
 - Calling up the "Routes" menu 352
 - Displaying the distance to the destination 350
 - Recording 352
 - Route overview 351
 - Selecting an alternative route 349
 - Setting route options (avoiding: highways, toll roads, tunnels, ferries) 320
 - Setting the route type (short route, fast route, dynamic route or economic route) 320
 - Starting calculation 327
 - Route demonstration** 351
 - Route guidance**
 - Canceling 349
 - Continuing 349
 - Destination reached 349
 - General notes 344
 - Lane recommendations 346
 - Off-road 354
 - Traffic reports 355
- S**
- Safety**
 - Children in the vehicle 68
 - Child restraint systems 69
 - Occupant Classification System (OCS) 59
 - Safety notes**
 - Audio CD and MP3 mode 444
 - Using the telephone 379
 - Video DVD mode 473
 - Safety system**
 - see Driving safety systems
 - SatRadio**
 - Displaying information 443
 - Notes 439
 - Registering 440
 - Selecting a category 441
 - Switching to 440
 - Saving the crosshair position** 365
 - Screen**
 - Selecting for remote operation 482
 - SD memory card**
 - Ejecting 445
 - Inserting 445
 - Search & Send** 343
 - Seat belts**
 - Adjusting the driver's and front-passenger seat belt 55
 - Cleaning 546
 - Correct usage 54
 - Fastening 54
 - Important safety guidelines 52
 - Introduction 52
 - Releasing 55
 - Seat belt guide 111
 - Switching belt adjustment on/off (on-board computer) 235
 - Warning lamp 269
 - Warning lamp (function) 55
 - Seats**
 - Active multicontour seat 314
 - Adjusting (electrically) 110
 - Adjusting the head restraint 111

- Adjusting the lumbar support
 - (COMAND) 315
 - Balance (seat heating) 316
 - Belt guide 111
 - Cleaning the cover 545
 - Correct driver's seat position 108
 - Important safety notes 109
 - Multicontour seat 314
 - Overview 109
 - Resetting settings 317
 - Seat functions (COMAND) 314
 - Seat heating problem 113
 - Seat ventilation problem 113
 - Selecting for adjustment (COMAND) 314
 - Sliding forward/back 111
 - Storing settings (memory function) 119
 - Switching AIRSCARF on/off 113
 - Switching seat heating on/off 112
 - Switching seat ventilation on/off .. 113
- Selecting a province** 323
- Selecting a state** 323
- Selecting stations**
 - Radio 436
- Selector lever**
 - Cleaning 545
 - Positions 159
- Sending DTMF tones** 389
- Sensors (cleaning instructions)** 543
- Service center**
 - see Qualified specialist workshop
- Service Center**
 - see Qualified specialist workshop
- Service menu (on-board computer)** 231
- Service products**
 - Brake fluid 604
 - Coolant (engine) 605
 - Engine oil 603
 - Fuel 602
 - Important safety notes 601
 - Refrigerant (air-conditioning system) 606
 - Washer fluid 606
- Settings**
 - Factory (on-board computer) 236
 - Menu overview 288
 - On-board computer 232
 - Picture (COMAND) 473
 - Sound settings 296
 - Setting the air distribution** 142
 - Setting the airflow** 143
 - Setting the audio format**
 - Rear Seat Entertainment System ... 496
 - Setting the language**
 - COMAND 308
 - Rear Seat Entertainment System ... 496
 - Setting the night design** 306
 - Setting the text reader speed** 308
 - Setting the volume**
 - Telephone calls 296
 - Video AUX 479
 - SETUP (on-board computer)** 236
 - Side impact air bag** 57
 - Side windows**
 - Cleaning 542
 - Convenience closing feature 99
 - Important safety information 96
 - Opening/closing (all) 98
 - Opening/closing (front) 97
 - Opening/closing (rear) 98
 - Overview 96
 - Problem (malfunction) 100
 - Resetting 99
 - SIRIUS weather display**
 - 5-day forecast 501
 - Daily forecast 500
 - Detail information 501
 - Information chart 500
 - Selecting the area for the weather forecast 501
 - Switching on/off 500
 - Weather map 503
 - SmartKey**
 - Changing the battery 85
 - Changing the programming 83
 - Checking the battery 85
 - Convenience opening feature 98
 - Display message 268
 - Door central locking/unlocking 82
 - Important safety notes 82

- Loss 87
- Mechanical key 84
- Opening/closing the roof 102
- Overview 82
- Positions (ignition lock) 151
- Problem (malfunction) 87
- Starting the engine 154
- Snow chains** 571
- Sockets**
 - Front-passenger footwell 519
 - General notes 518
 - Trunk 519
 - Under the armrest 519
- Sound**
 - Switching on/off 295
- Sound menu** 296
- Sound mode** 298
- Sound settings**
 - Calling up the sound menu 296
 - Surround sound 297
 - Treble and bass 296
- Specialist workshop** 35
- Special seat belt retractor** 69
- Speed, controlling**
 - see Cruise control
- Speed dial list**
 - Storing a phone book entry in the speed dial list 397
- Speedometer**
 - Digital 226
 - In the Instrument cluster 41
 - Segments 223
 - Selecting the unit of measurement 232
- SPLITVIEW** 303
- SPORT handling mode**
 - Activating/deactivating (AMG vehicles) 76
 - Warning lamp 274
- Standing lamps**
 - Display message 252
 - Switching on/off 124
- Start/stop function**
 - see ECO start/stop function
- Starting (engine)** 153
- Station search** 436
- STEER CONTROL** 79
- Steering (display message)** 266
- Steering assistant STEER CONTROL**
 - see STEER CONTROL
- Steering wheel**
 - Adjusting (electrically) 114
 - Button overview 43
 - Buttons (on-board computer) 223
 - Cleaning 545
 - Important safety notes 114
 - Paddle shifters 164
 - Storing settings (memory function) 119
- Steering wheel paddle shifters** 164
- Stop function**
 - Video DVD 475
- Stopwatch (RACETIMER)** 237
- Storing stations**
 - Radio 437
- Stowage areas** 512
- Stowage compartments**
 - Armrest (under) 513
 - Center console 513
 - Center console (rear) 514
 - Cup holders 516
 - Eyeglasses compartment 513
 - Glove box 512
 - Important safety information 512
 - Rear 514
 - Stowage net 514
- Stowage net** 514
- Stowage space**
 - Umbrella holder 513
- Stowage well beneath the trunk floor** 516
- Street View** 331
- Summer tires** 570
- Sun visor** 517
- Surround lighting (on-board computer)** 233
- Surround sound** 297
- Surround sound (harman/kardon® surround sound system)**
 - Notes 297
 - Switching on/off 297

- Suspension tuning**
- Active Body Control (AMG vehicles) 198
 - Active Body Control (except AMG vehicles) 195
 - SETUP (on-board computer) 236
- Switching air-recirculation mode on/off** 146
- Switching between picture formats (TV, video)** 473
- Switching between summer time and standard time** 307
- Switching HD Radio on/off**
see Radio
- Switching the hands-free microphone on/off** 388
- Switching wavebands (radio)** 436
- System settings**
- Bluetooth® 308
 - Date 306
 - Language 308
 - Text reader speed 308
 - Time 306
 - Time zone 307
 - Voice Control System 308
- T**
- Tachometer** 223
- Tail lamps**
- Display message 252
 - see Lights
- Tank content**
- Fuel gauge 41
- Technical data**
- Capacities 601
 - Information 600
 - Tires/wheels 593
 - Vehicle data 607
- TELEAID**
- Call priority 523
 - Downloading destinations (COMAND) 523
 - Downloading routes 526
 - Emergency call 520
 - General notes 519
 - Geo fencing 527
 - Locating a stolen vehicle 525
 - MB info call button 522
 - Remote vehicle locking 525
 - Roadside Assistance button 521
 - Search & Send 524
 - Self-test 520
 - Speed alert 527
 - System 520
 - Triggering the vehicle alarm 527
 - Vehicle remote malfunction diagnosis 526
 - Vehicle remote unlocking 524
- Telephone**
- Accepting/ending a call 387
 - Accepting a call 229
 - Adjusting the volume for calls 296
 - Calling (outgoing call) 387
 - Conference connection 390
 - Connecting a mobile phone (general information) 381
 - De-authorizing a mobile phone 385
 - Display message 266
 - Ending an active call 390
 - Entering a number 387
 - Entering phone numbers 387
 - External authorization (Bluetooth®) 384
 - Function restrictions 380
 - General notes 379
 - Incoming call 387
 - Making a call 390
 - Making a call via speed dial 388
 - Menu (on-board computer) 229
 - Number from the phone book 230
 - Operating options 380
 - Overview of functions 388
 - Reception and transmission volume 386
 - Redialing 230
 - Rejecting/accepting a waiting call 389
 - Rejecting/ending a call 229
 - Rejecting a call 387
 - Safety notes 379
 - Sending DTMF tones 389
 - Single call 388
 - Switching hands-free microphone on/off 388

- Text messages (SMS) 398
- Toggling 390
- Using the telephone 387
- see Bluetooth®
- Telephone basic menu**
- Bluetooth® interface 385
- Telephone mode**
- Redialing 388
- Telephone number**
- Entering 387
- Temperature**
- Coolant 222
- Coolant (on-board computer) 236
- Engine oil (on-board computer) 236
- Outside temperature 223
- Setting (climate control) 142
- Text messages (SMS)**
- Calling the sender 400
- Deleting 400
- Inbox 399
- Information and requirements 398
- Reading 399
- Reading aloud 399
- Storing sender in address book 400
- Storing the sender as a new address book entry 400
- Time**
- Setting 307
- Setting summer/standard time 307
- Setting the format 306
- Setting the time 306
- Setting the time/date format 306
- Setting the time manually 306
- Setting the time zone 307
- Timing (RACETIMER)** 237
- TIREFIT kit** 550
- Tire pressure**
- Calling up (on-board computer) 575
- Checking manually 575
- Display message 263
- Important safety notes 575
- Maximum 574
- Notes 573
- Not reached (TIREFIT) 552
- Reached (TIREFIT) 552
- Recommended 572
- Tire pressure monitor**
- Radio type approval for the tire pressure monitor 578
- Tire pressure monitoring system**
- Checking the tire pressure electronically 577
- Function/notes 575
- General notes 575
- Important safety notes 575
- Restarting 577
- Warning lamp 280
- Warning message 577
- Tires**
- Aspect ratio (definition) 587
- Average weight of the vehicle occupants (definition) 586
- Bar (definition) 586
- Changing a wheel 588
- Characteristics 586
- Checking 569
- Curb weight (definition) 587
- Definition of terms 586
- Direction of rotation 589
- Display message 263
- Distribution of the vehicle occupants (definition) 588
- DOT, Tire Identification Number (TIN) 585
- DOT (Department of Transportation) (definition) 586
- GAWR (Gross Axle Weight Rating) (definition) 587
- GVW (Gross Vehicle Weight) (definition) 587
- GVWR (Gross Vehicle Weight Rating) (definition) 587
- Important safety notes 568
- Increased vehicle weight due to optional equipment (definition) 587
- Kilopascal (kPa) (definition) 587
- Labeling (overview) 582
- Load bearing index (definition) 588
- Load index 585
- Load index (definition) 587
- M+S tires 570
- Maximum loaded vehicle weight (definition) 587

- Maximum load on a tire (definition) 587
- Maximum permissible tire pressure (definition) 587
- Maximum tire load 585
- Maximum tire load (definition) 587
- MOExtended tires 570
- Optional equipment weight (definition) 588
- Overview 568
- PSI (pounds per square inch) (definition) 587
- Replacing 588
- Service life 570
- Sidewall (definition) 588
- Speed rating (definition) 587
- Storing 589
- Structure and characteristics (definition) 586
- Summer tires 570
- Temperature 582
- TIN (Tire Identification Number) (definition) 588
- Tire bead (definition) 588
- Tire pressure (definition) 587
- Tire pressures (recommended) 586
- Tire size (data) 593
- Tire size designation, load-bearing capacity, speed rating 582
- Tire tread 569
- Tire tread (definition) 588
- Total load limit (definition) 588
- Traction 581
- Traction (definition) 588
- Tread wear 581
- Uniform Tire Quality Grading Standards 581
- Uniform Tire Quality Grading Standards (definition) 586
- Wear indicator (definition) 588
- Wheel and tire combination 596
- Wheel rim (definition) 587
- see Flat tire
- Tone settings**
 - Balance and fader 296
- Towing**
 - Important safety guidelines 559
 - Installing the towing eye 560
 - Removing the towing eye 561
 - With the rear axle raised 561
- Towing away**
 - With both axles on the ground 561
- Tow-starting**
 - Emergency engine starting 562
 - Important safety notes 559
- Track**
 - Selecting (CD, MP3) 447
 - Selecting using the number keypad 448
- Track information** 492
- Traffic jam function** 349
- Traffic reports**
 - Calling up a list 357
 - Reading out on route 359
 - Real-time traffic report 358
- Transmission**
 - Selector lever 159
 - see Automatic transmission
- Transporting the vehicle** 562
- Treble, adjusting (sound)** 296
- Trim pieces (cleaning instructions)** 545
- Trip computer (on-board computer)** 225
- Trip odometer**
 - Calling up 225
 - Resetting (on-board computer) 226
- True Image™** 298
- Trunk**
 - Emergency release 95
 - Important safety notes 91
 - Locking separately 95
 - Opening/closing (automatically from inside) 95
 - Opening/closing (automatically from outside) 92
 - Opening/closing (from outside, HANDS-FREE ACCESS) 93
 - Opening/closing (manually from outside) 92
 - Overview 91
 - Power closing 90

- Trunk lid**
 Display message 266
 Opening/closing 91
 Opening dimensions 607
- Trunk load (maximum)** 607
- Trunk partition**
 Display message 266
 General notes 102
 Installing 103
 Opening/closing 103
 Removing 103
- Turn signals**
 Display message 251
 Switching on/off 125
- TV**
 Automatic picture shutoff 472
 Picture settings 473
 Sound settings (balance, bass, treble) 296
- Type identification plate**
 see Vehicle identification plate
- U**
- Umbrella holder** 513
- Unlocking**
 Emergency unlocking 90
 From inside the vehicle (central unlocking button) 89
- Updating the digital map** 375
- USB**
 see Media Interface
- V**
- Vanity mirror (in the sun visor)** 517
- Vehicle**
 Correct use 35
 Data acquisition 36, 284
 Display message 265
 Equipment 31
 Individual settings 232
 Limited Warranty 36
 Loading 578
 Locking (in an emergency) 90
 Locking (SmartKey) 82
 Lowering 593
 Maintenance 32
 Parking for a long period 174
 Pulling away 154
 Raising 590
 Reporting problems 35
 Securing from rolling away 590
 Towing away 559
 Tow-starting 559
 Transporting 562
 Unlocking (in an emergency) 90
 Unlocking (SmartKey) 82
 Vehicle data 607
- Vehicle battery**
 see Battery (vehicle)
- Vehicle data** 607
- Vehicle dimensions** 607
- Vehicle emergency locking** 90
- Vehicle identification number**
 see VIN
- Vehicle identification plate** 600
- Vehicle level**
 Active Body Control (AMG vehicles) 197
 Active Body Control (except AMG vehicles) 194
 Display message 257
- Vehicle tool kit** 548
- Video**
 Operating the DVD 229
 see Video DVD
- Video AUX**
 Setting the picture 473
- Video DVD**
 Automatic picture shutoff 472
 DVD menu 476
 Fast forward/rewind 475
 Function restrictions 474
 Interactive content 478
 Notes on discs 473
 Operation 473
 Pause function 476
 Playing conditions 474
 Safety notes 473
 Selecting 476
 Selecting a film/title 476
 Selecting a scene/chapter 476
 Setting the audio format 477
 Setting the language 477

- Setting the picture 473
 - Showing/hiding the control menu 474
 - Showing/hiding the menu 475
 - Stop function 475
 - Subtitles 478
 - Switching to 474
 - VIN** 600
 - Voice Control System**
 - Settings 308
 - Volume, adjusting**
 - COMAND 295
 - Navigation messages 295
- W**
- Warning and indicator lamps**
 - ABS 271
 - Brakes 271
 - Check Engine 277
 - Coolant 277
 - Distance warning 279
 - DISTRONIC PLUS 279
 - ESP® 273
 - ESP® OFF 274
 - Overview 42
 - PASSENGER AIR BAG OFF 51
 - Reserve fuel 277
 - Restraint system 276
 - Seat belt 269
 - SPORT handling mode 274
 - Tire pressure monitor 280
 - Warranty** 31
 - Washer fluid**
 - Display message 267
 - Waypoints**
 - Accepting waypoints for the route 334
 - Creating 331
 - Editing 333
 - Entering 331
 - Searching for a gas station when the fuel level is low 334
 - Weather Band**
 - Searching for a channel 438
 - Switching on 438
 - Weather map (SIRIUS)**
 - Calling up 503
 - Legend 508
 - Moving 504
 - Showing/hiding layers 504
 - Showing/hiding the menu 504
 - Time stamp 508
 - Weather memory (SIRIUS)**
 - Selecting an area 503
 - Storing an area 503
 - Website**
 - Add to favorites 431
 - Wheel and tire combination**
 - see Tires
 - Wheel bolt tightening torque** 593
 - Wheel chock** 590
 - Wheels**
 - Changing a wheel 588
 - Checking 569
 - Cleaning 542
 - Cleaning (warning) 589
 - Important safety notes 568
 - Interchanging/changing 588
 - Mounting a new wheel 592
 - Mounting a wheel 589
 - Overview 568
 - Removing a wheel 592
 - Storing 589
 - Tightening torque 593
 - Wheel size/tire size 593
 - Windows**
 - see Side windows
 - Wind screen**
 - Electrical wind screen 104
 - Windshield**
 - Defrosting 143
 - Windshield washer fluid**
 - see Windshield washer system
 - Windshield washer system**
 - Adding washer fluid 537
 - Notes 606
 - Windshield wipers**
 - Display message 267
 - Problem (malfunction) 133
 - Replacing the wiper blades 131
 - Switching on/off 130

Winter driving

Important safety notes	570
Slippery road surfaces	179
Snow chains	571

Winter operation

Overview	570
----------------	-----

Winter tires

M+S tires	570
-----------------	-----

Wiper blades

Cleaning	543
Important safety notes	131
Replacing	131

Wooden trim (cleaning instruc-

tions)	545
---------------------	------------

Workshop

see Qualified specialist workshop

Z

ZAGAT® rating service	338
------------------------------------	------------

ZONE function

Switching on/off	143
------------------------	-----

Protection of the environment

General notes

Environmental note

Daimler's declared policy is one of comprehensive environmental protection.

The objectives are for the natural resources that form the basis of our existence on this planet to be used sparingly and in a manner that takes the requirements of both nature and humanity into account.

You too can help to protect the environment by operating your vehicle in an environmentally responsible manner.

Fuel consumption and the rate of engine, transmission, brake and tire wear are affected by these factors:

- operating conditions of your vehicle
- your personal driving style

You can influence both factors. You should bear the following in mind:

Operating conditions:

- avoid short trips as these increase fuel consumption.
- always make sure that the tire pressures are correct.
- do not carry any unnecessary weight.
- remove roof racks once you no longer need them.
- a regularly serviced vehicle will contribute to environmental protection. You should therefore adhere to the service intervals.
- always have service work carried out at a qualified specialist workshop.

Personal driving style:

- do not depress the accelerator pedal when starting the engine.
- do not warm up the engine when the vehicle is stationary.
- drive carefully and maintain a safe distance from the vehicle in front.
- avoid frequent, sudden acceleration and braking.

- change gear in good time and use each gear only up to $\frac{2}{3}$ of its maximum engine speed.
- switch off the engine in stationary traffic.
- keep an eye on the vehicle's fuel consumption.

Environmental concerns and recommendations

Wherever the operating instructions require you to dispose of materials, first try to regenerate or re-use them. Observe the relevant environmental rules and regulations when disposing of materials. In this way you will help to protect the environment.

Genuine Mercedes-Benz parts

Environmental note

Daimler AG also supplies reconditioned major assemblies and parts which are of the same quality as new parts. They are covered by the same Limited Warranty entitlements as new parts.

 Air bags and Emergency Tensioning Devices, as well as control units and sensors for these restraint systems, may be installed in the following areas of your vehicle:

- doors
- door pillars
- door sills
- seats
- cockpit
- instrument cluster
- center console

Do not install accessories such as audio systems in these areas. Do not carry out repairs or welding. You could impair the operating efficiency of the restraint systems.

Have aftermarket accessories installed at a qualified specialist workshop.

You could jeopardize the operating safety of your vehicle if you use parts, tires and wheels as well as accessories relevant to safety which have not been approved by Mercedes. This could lead to malfunctions in safety-relevant systems, e.g. the brake system. Use only genuine Mercedes-Benz parts or parts of equal quality. Only use tires, wheels and accessories that have been specifically approved for your vehicle.

Genuine Mercedes-Benz parts are subject to strict quality control. Every part has been specifically developed, manufactured or selected for and adapted to Mercedes-Benz vehicles. Only genuine Mercedes-Benz parts should therefore be used.

More than 300,000 different genuine Mercedes-Benz parts are available for Mercedes-Benz models.

All authorized Mercedes-Benz Centers maintain a supply of genuine Mercedes-Benz parts for necessary service and repair work. In addition, strategically located parts delivery centers provide quick and reliable parts service.

Always specify the vehicle identification number (VIN) when ordering genuine Mercedes-Benz parts (> page 600).

Operator's Manual

Vehicle equipment

This Operator's Manual describes all models and all standard and optional equipment of your vehicle available at the time of going to print. Country-specific differences are possible. Bear in mind that your vehicle may not feature all functions described here. This also applies to safety-relevant systems and functions. The equipment in your vehicle may therefore differ from that shown in the descriptions and illustrations.

The original purchase agreement lists all systems installed in your vehicle.

Should you have any questions concerning equipment and operation, please consult an authorized Mercedes-Benz Center.

The Operator's Manual and Maintenance Booklet are important documents and should be kept in the vehicle.

Service and vehicle operation

Warranty

The implied warranty for your vehicle applies in accordance with the warranty terms and conditions in the Service and Warranty Information booklet.

Your authorized Mercedes-Benz Center will replace and repair all factory-installed parts in accordance with the following warranty terms and conditions:

- New Vehicle Limited Warranty
- Emission System Warranty
- Emission Performance Warranty
- California, Connecticut, Maine, Massachusetts, New York, Pennsylvania, Rhode Island and Vermont Emission Control System Warranty
- State warranty enforcement laws (lemon laws)

Replacement parts and accessories are covered by the Mercedes-Benz Parts and Accessories warranties. These are available at any authorized Mercedes-Benz Center.

- i** Should you lose your Service and Warranty Information booklet, have an authorized Mercedes-Benz Center arrange for a replacement. The new Service and Warranty Information booklet will be posted to you.

Information for customers in California

Under California law you may be entitled to a replacement of your vehicle or a refund of the purchase price or lease price, if after a reasonable number of repair attempts Mercedes-Benz USA, LLC and/or its authorized repair or service facilities fail to fix one or more substantial defects or malfunctions in the vehicle that are covered by its express warranty. During the period of 18 months from original delivery of the vehicle or the accumulation of 18,000 miles (approximately 29,000 km) on the odometer of the vehicle, whichever occurs first, a reasonable number of repair attempts is presumed for a retail buyer or lessee if one or more of the following occurs:

- (1) the same substantial defect or malfunction results in a condition that is likely to cause death or serious bodily injury if the vehicle is driven, that defect or malfunction has been subject to repair two or more times, and you have directly notified Mercedes-Benz USA, LLC in writing of the need for its repair,
- (2) the same substantial defect or malfunction of a less serious nature than category (1) has been subject to repair four or more times and you have directly notified us in writing of the need for its repair, or
- (3) the vehicle is out of service by reason of repair of the same or different substantial defects or malfunctions for a cumulative total of more than 30 calendar days.

Please send your written notice to:
 Mercedes-Benz USA, LLC
 Customer Assistance Center
 One Mercedes Drive
 Montvale, NJ 07645-0350

Maintenance

The Service and Warranty Booklet describes all the necessary maintenance work which should be done at regular intervals.

Always have the Service and Warranty Booklet with you when you bring the vehicle to an authorized Mercedes-Benz Center. The service advisor will record every service for you in the Service and Warranty Booklet.

Roadside Assistance

The Mercedes-Benz Roadside Assistance Program offers technical help in the event of a breakdown. Calls to the toll-free Roadside Assistance Hotline are answered by our agents 24 hours a day, 365 days a year.

1-800-FOR-MERCedes(1-800-367-6372) (USA)

1-800-387-0100 (Canada)

For additional information, refer to the Mercedes-Benz Roadside Assistance Program brochure (USA) or the "Roadside Assistance" section in the Service and Warranty booklet (Canada). You will find both in your vehicle literature portfolio.

Change of address or change of ownership

In the event of a change of address, please send us the "Notification of Address Change" in the Service and Guarantee booklet or simply call the Mercedes-Benz Customer Assistance Center (USA) at the hotline number 1-800-FOR-MERCedes(1-800-367-6372) or Customer Service Center (Canada) at 1-800-387-0100. This will assist us in contacting you in a timely manner should the need arise.

If you sell your Mercedes, please leave the entire literature in the vehicle so that it is available to the next owner.

If you have purchased a used car, please send us the "Notification of Used Car Purchase" in

the Service and Guarantee booklet or simply call the Mercedes-Benz Customer Assistance Center (USA) at the hotline number 1-800-FOR-MERCEDES(1-800-367-6372) or Customer Service (Canada) at 1-800-387-0100.

Vehicle operation outside the USA and Canada

If you plan to operate your vehicle in foreign countries, please be aware that:

- service facilities or replacement parts may not be readily available.
- unleaded fuel for vehicles with a catalytic converter may not be available. Leaded fuel may cause damage to the catalytic converter.
- the fuel may have a considerably lower octane rating. Unsuitable fuel can cause engine damage.

Some Mercedes-Benz models are available for delivery in Europe through our European Delivery Program. For details, consult an authorized Mercedes-Benz Center or write to one of the following addresses.

In the USA

Mercedes-Benz USA, LLC
European Delivery Department
One Mercedes Drive
Montvale, NJ 07645-0350

In Canada

Mercedes-Benz Canada, Inc.
European Delivery Department
98 Vanderhoof Avenue
Toronto, Ontario M4G 4C9

Operating safety

Important safety notes

WARNING

If you do not have the prescribed service/maintenance work or any required repairs

carried out, this can result in malfunctions or system failures. There is a risk of an accident. Always have the prescribed service/maintenance work as well as any required repairs carried out at a qualified specialist workshop.

WARNING

If you switch off the ignition while driving, safety-relevant functions are only available with limitations, or not at all. This could affect, for example, the power steering and the brake boosting effect. You will require considerably more effort to steer and brake. There is a risk of an accident.

Do not switch off the ignition while driving.

WARNING

Flammable material such as leaves, grass or twigs may ignite if they come into contact with hot parts of the exhaust system. There is a risk of fire.

When driving off road or on unpaved roads, check the vehicle's underside regularly. In particular, remove parts of plants or other flammable materials which have become trapped. In the case of damage, contact a qualified specialist workshop.

WARNING

Modifications to electronic components, their software as well as wiring can impair their function and/or the function of other networked components. In particular, systems relevant to safety could also be affected. As a result, these may no longer function as intended and/or jeopardize the operating safety of the vehicle. There is an increased risk of an accident and injury.

Never tamper with the wiring as well as electronic components or their software. You should have all work to electrical and electronic equipment carried out at a qualified specialist workshop.

If you make any changes to the vehicle electronics, the general operating permit is rendered invalid.

! There is a risk of damage to the vehicle if:

- the vehicle becomes stuck, e.g. on a high curb or an unpaved road
- you drive too fast over an obstacle, e.g. a curb or a hole in the road
- a heavy object strikes the undercarriage or parts of the chassis

In situations like this, the body, the undercarriage, chassis parts, wheels or tires could be damaged without the damage being visible. Components damaged in this way can unexpectedly fail or, in the case of an accident, no longer withstand the strain they are designed to.

If the underbody paneling is damaged, combustible materials such as leaves, grass or twigs can gather between the underbody and the underbody paneling. If these materials come in contact with hot parts of the exhaust system, they can catch fire.

In such situations, have the vehicle checked and repaired immediately at a qualified specialist workshop. If on continuing your journey you notice that driving safety is impaired, pull over and stop the vehicle immediately, paying attention to road and traffic conditions. In such cases, visit a qualified specialist workshop.

Declarations of conformity

Vehicle components which receive and/or transmit radio waves

USA: "The wireless devices of this vehicle comply with Part 15 of the FCC Rules. Operation is subject to the following two conditions: 1) These devices may not cause harmful interference, and 2) These devices must accept any interference received, including interference that may cause undesired operation. Changes or modifications not expressly

approved by the party responsible for compliance could void the user's authority to operate the equipment."

Canada: "The wireless devices of this vehicle comply with Industry Canada license-exempt RSS standard(s). Operation is subject to the following two conditions: (1) These devices may not cause interference, and (2) These devices must accept any interference, including interference that may cause undesired operation of the device."

Diagnostics connection

The diagnostics connection is only intended for the connection of diagnostic equipment at a qualified specialist workshop.

WARNING

If you connect equipment to the diagnostics connection in the vehicle, it may affect the operation of the vehicle systems. As a result, the operating safety of the vehicle could be affected. There is a risk of an accident.

Do not connect any equipment to a diagnostics connection in the vehicle.

WARNING

Objects in the driver's footwell can restrict the pedal travel or obstruct a depressed pedal. The operating and road safety of the vehicle is jeopardized. There is a risk of an accident.

Make sure that all objects in the vehicle are stowed correctly, and that they cannot enter the driver's footwell. Install the floor mats securely and as specified in order to ensure sufficient clearance for the pedals. Do not use loose floor mats and do not place floor mats on top of one another.

! If the engine is switched off and equipment on the diagnostics connection is used, the starter battery may discharge.

Connecting equipment to the diagnostics connection can lead to emissions monitoring information being reset, for example. This may lead to the vehicle failing to meet the

requirements of the next emissions test during the main inspection.

Qualified specialist workshop

An authorized Mercedes-Benz Center is a qualified specialist workshop. It has the necessary specialist knowledge, tools and qualifications to correctly carry out the work required on your vehicle. This is especially the case for work relevant to safety.

Observe the notes in the Maintenance Booklet.

Always have the following work carried out at an authorized Mercedes-Benz Center:

- work relevant to safety
- service and maintenance work
- repair work
- alterations, installation work and modifications
- work on electronic components

Correct use

If you remove any warning stickers, you or others could fail to recognize certain dangers. Leave warning stickers in position.

Observe the following information when driving your vehicle:

- the safety notes in this manual
- the Technical Data section in this manual
- traffic rules and regulations
- laws and safety standards pertaining to motor vehicles

Problems with your vehicle

If you should experience a problem with your vehicle, particularly one that you believe may affect its safe operation, we urge you to contact an authorized Mercedes-Benz Center immediately to have the problem diagnosed and rectified. If the problem is not resolved to your satisfaction, please discuss the problem

again with a Mercedes-Benz Center or contact us at one of the following addresses.

In the USA

Customer Assistance Center
Mercedes-Benz USA, LLC
One Mercedes Drive
Montvale, NJ 07645-0350

In Canada

Customer Relations Department
Mercedes-Benz Canada, Inc.
98 Vanderhoof Avenue
Toronto, Ontario M4G 4C9

Reporting safety defects

USA only:

The following text is published as required of manufacturers under Title 49, Code of U.S. Federal Regulations, Part 575 pursuant to the "National Traffic and Motor Vehicle Safety Act of 1966".

If you believe that your vehicle has a defect which could cause a crash or could cause injury or death, you should immediately inform the National Highway Traffic Safety Administration (NHTSA) in addition to notifying Mercedes-Benz USA, LLC.

If NHTSA receives similar complaints, it may open an investigation, and if it finds that a safety defect exists in a group of vehicles, it may order a recall and remedy campaign. However, NHTSA cannot become involved in individual problems between you, your dealer, or Mercedes-Benz USA, LLC.

To contact NHTSA, you may call the Vehicle Safety Hotline toll-free at 1-888-327-4236 (TTY: 1-800-424-9153); go to <http://www.safercar.gov>; or write to: Administrator, NHTSA, 400 Seventh Street, SW., Washington, DC 20590.

You can also obtain other information about motor vehicle safety from <http://www.safercar.gov>

Limited Warranty

! Follow the instructions in this manual about the proper operation of your vehicle as well as about possible vehicle damage. Damage to your vehicle that arises from culpable contraventions against these instructions is not covered either by the Mercedes-Benz Limited Warranty or by the New or Used-Vehicle Warranty.

Data stored in the vehicle

Data recording

This vehicle is capable of recording diagnostic information relating to vehicle operation, malfunctions, and user settings. This may include information about the performance or status of various systems, including but not limited to, engine, throttle, steering or brake systems, that is stored and can be read out with suitable devices, particularly when the vehicle is serviced. The data obtained is used to properly diagnose and service your vehicle or to further optimize and develop vehicle functions.

COMAND/mbrace (Canada: TELEAID)

If the vehicle is equipped with COMAND or mbrace, additional data about the vehicle's operation, the use of the vehicle in certain situations, and the location of the vehicle may be compiled through COMAND or the mbrace system.

For additional information please refer to the COMAND User Manual and/or the mbrace Terms and Conditions.

Event data recorders

This vehicle is equipped with an event data recorder (EDR). The main purpose of an EDR is to record data that will assist in understanding how a vehicle's systems performed in certain crash or near crash-like situations,

such as during air bag deployment or when hitting a road obstacle. The EDR is designed to record data related to vehicle dynamics and safety systems for a short period of time, typically 30 seconds or less.

The EDR in this vehicle is designed to record such data as:

- how various systems in your vehicle are operating
- whether or not the driver and passenger seat belts are fastened
- how far (if at all) the driver is depressing the accelerator and/or brake pedal and
- how fast the vehicle is traveling

This data can help provide a better understanding of the circumstances in which crashes and injuries occur. NOTE: EDR data is recorded by your vehicle only if a non-trivial crash situation occurs; no data is recorded by the EDR under normal driving conditions and no personal data (e.g., name, gender, age, and crash location) are recorded. However, other parties, such as law enforcement, can combine the EDR data with the type of personal identification data routinely acquired during a crash investigation.

Access to the vehicle and/or the EDR is needed to read data that is recorded by an EDR, and special equipment is required. In addition to the vehicle manufacturer, other parties that have the special equipment, such as law enforcement, can read the information by accessing the vehicle or the EDR.

EDR data may be used in civil and criminal matters as a tool in accident reconstruction, accident claims, and vehicle safety. Since the Crash Data Retrieval CDR tool that is used to extract data from the EDR is commercially available, Mercedes-Benz USA, LLC ("MBUSA") expressly disclaims any and all liability arising from the extraction of this information by unauthorized Mercedes-Benz personnel.

MBUSA will not share EDR data with others without the consent of the vehicle owners or, if the vehicle is leased, without the consent of

the lessee. Exceptions to this representation include responses to subpoenas by law enforcement; by federal, state or local government; in connection with or arising out of litigation involving MBUSA or its subsidiaries and affiliates; or, as required by law.

Warning: The EDR is a component of the Supplemental Restraint System ("SRS") Module. Tampering with, altering, modifying or removing the EDR component may result in a malfunction of the SRS Module and other systems.

State laws or regulations regarding EDRs that conflict with federal regulation are pre-empted. This means that in the event of such conflict, the federal regulation governs. As of February 2013, 13 states have enacted laws relating to EDRs.

Information on copyright

General information

Information on license for free and open-source software used in your vehicle and its electronic components is available on the following website:

[http://www.mercedes-benz.com/
opensource](http://www.mercedes-benz.com/opensource)

Cockpit	40
Instrument cluster	41
Multifunction steering wheel	43
Center console	44
Overhead control panel	47
Door control panel	48

Cockpit

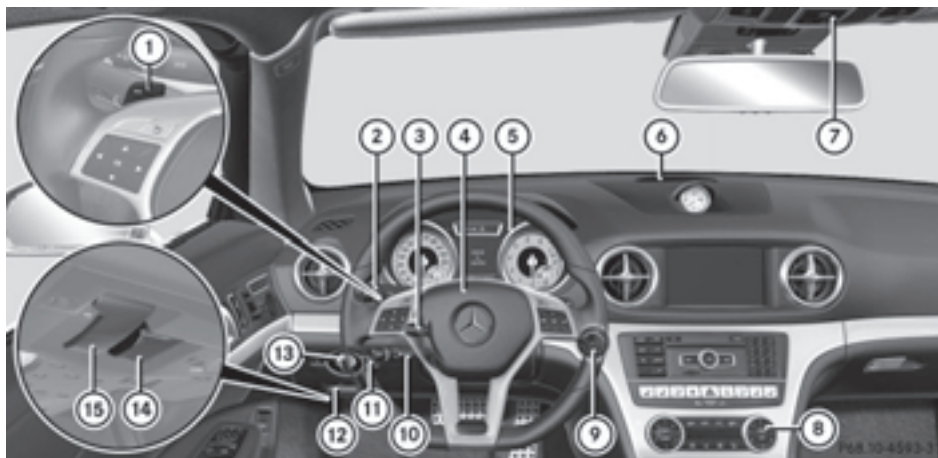

	Function	Page
①	Steering wheel paddle shifters	164
②	Combination switch	125
③	Adjusts the steering wheel electrically	114
④	Horn	
⑤	Instrument cluster	41
⑥	PARKTRONIC warning display	199
⑦	Overhead control panel	47
⑧	Climate control systems	136

	Function	Page
⑨	Ignition lock	151
	Start/Stop button	151
⑩	Cruise control lever	180
⑪	Activates Night View Assist Plus	212
⑫	Electric parking brake	172
⑬	Light switch	122
⑭	Diagnostics connection	34
⑮	Opens the hood	534

Instrument cluster

Displays and controls



	Function	Page		Function	Page
①	Speedometer with segments	223	④	Coolant temperature	222
②	Fuel gage		⑤	Multifunction display	224
③	Tachometer	223	⑥	Instrument cluster lighting	222

Warning and indicator lamps















	Function	Page
①	Low-beam head-lamps	123
②	Parking lamps	124
③	ESP®	273
④	High-beam head-lamps	125
⑤	Electric parking brake (red) (USA only) (Canada only)	276
⑥	Electric parking brake (yellow)	276
⑦	Distance warning	279
⑧	Turn signals	125
⑨	Tire pressure monitor	280

	Function	Page
⑩	Restraint system	50
⑪	Seat belt	269
⑫	SPORT handling mode (AMG vehicles)	274
⑬	Coolant	277
⑭	Check Engine	277
⑮	Reserve fuel	277
⑯	ESP® OFF	273
⑰	ABS	271
⑱	Brakes (USA only) (Canada only)	271

Multifunction steering wheel









	Function	Page
①	Multifunction display	224
②	COMAND display	286
③	 Switches on the Voice Control System; see the separate operating instructions	
④	 Rejects or ends a call Exits phone book/redial memory  Makes or accepts a call Switches to the redial memory   Adjusts the volume  Mute	229

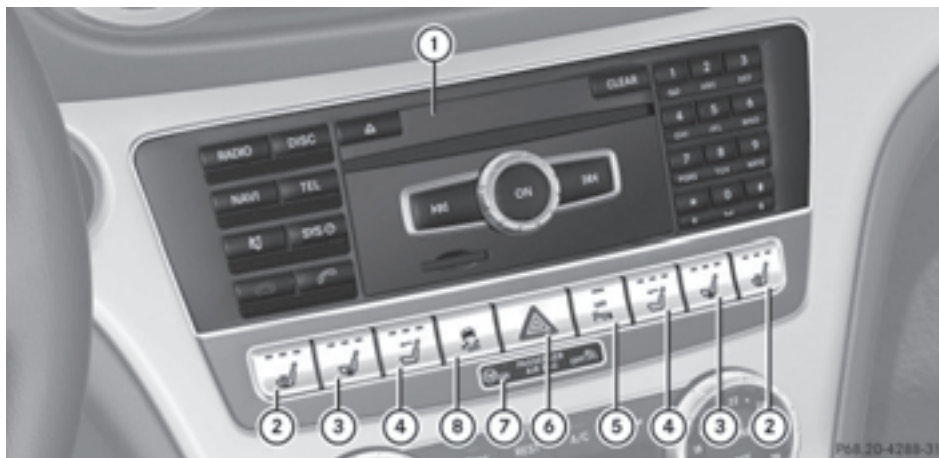

	Function	Page
⑤	  Selects a menu   Selects a submenu or scrolls through lists  Confirms your selection Hides display messages	223
⑥	 Back Switches off the Voice Control System; see the separate operating instructions	223

Center console

Center console, upper section





	Function	Page
①	COMAND	291
②	 Seat heating	112
③	 Seat ventilation	113
④	 AIRSCARF	113
⑤	 PARKTRONIC	199
⑥	 Hazard warning lamps	126

	Function	Page
⑦	 PASSENGER AIR BAG ON/OFF indicator lamp	51
⑧	 ESP® (except AMG vehicles)	74
	 ECO start/stop button (AMG vehicles)	155

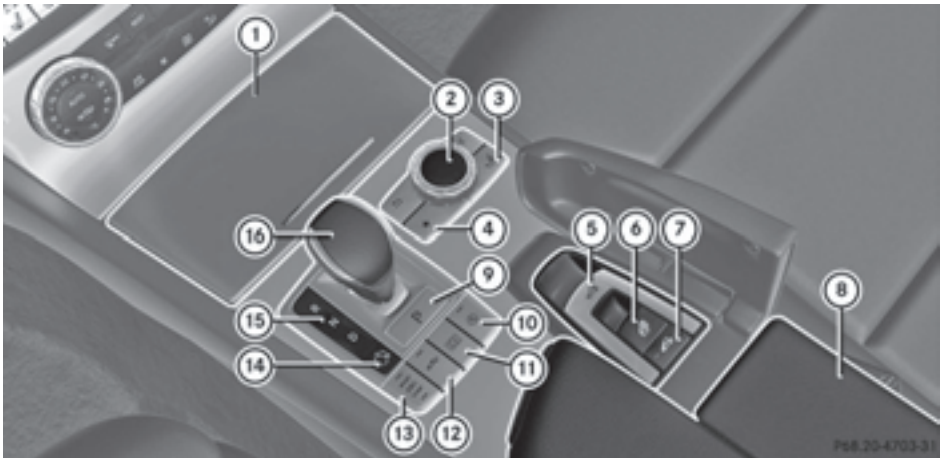
Center console, lower section (except AMG vehicles)



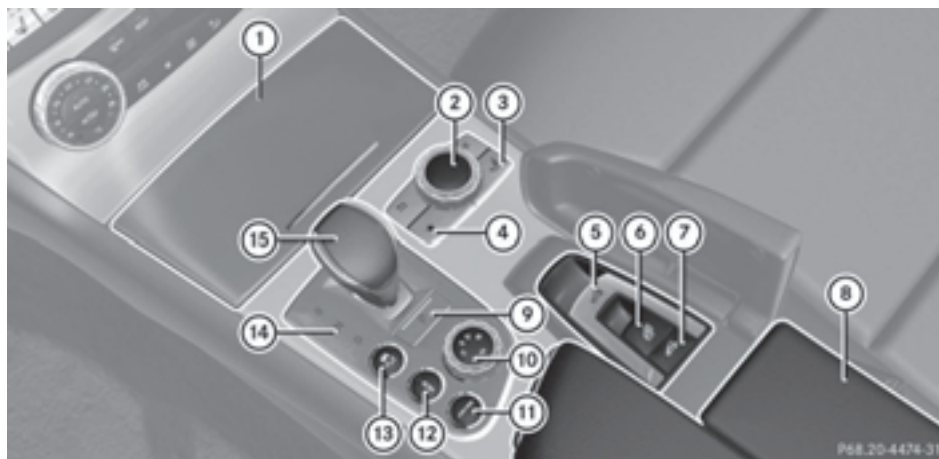

	Function	Page		Function	Page
①	Stowage compartment	513	⑩	 Start/Stop button	155
	Cup holder	516		⑪	Shows the driving conditions menu in the COMAND display (vehicles with Active Body Control)
	Ashtray	518	⑫		 Sets the vehicle level
②	COMAND controller	292		⑬	Adjusts the suspension settings
③	Seat adjustment	314	Sets the suspension tuning (vehicles with Active Body Control)		195
④	Favorites button	309	⑭	 Selects the drive program/program selector button	163
⑤	Roof switch	101		⑮	Transmission positions
⑥	Opens/closes the side windows	98	⑯		Selector lever
	⑦	Extends/retracts the wind screen		104	
⑧	Stowage compartment with Media Interface	513			
	Cigarette lighter	518			
	Socket	519			
⑨	Selects park position	159			

Center console, lower section (AMG vehicles)





	Function	Page
①	Stowage compartment Cup holder Ashtray	513 516 518
②	COMAND controller	292
③	Seat adjustment	314
④	Favorites button	309
⑤	Roof switch	101
⑥	Opens/closes the side windows	98
⑦	Extends/retracts the wind screen	104
⑧	Stowage compartment with Media Interface Cigarette lighter Socket	513 518 519

	Function	Page
⑨	Selects park position	159
⑩	Drive program selector	163
⑪	 AMG button (drive program or calls up/stores suspension tuning)	164
⑫	 Sets the suspension tuning	198
⑬	 ESP®	74
⑭	Transmission positions	162
⑮	Selector lever	159

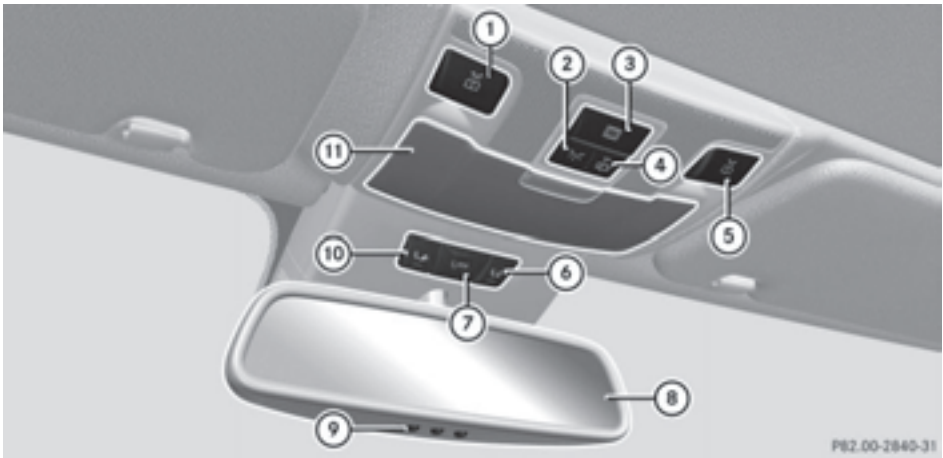
Overhead control panel









	Function	Page
①	 Switches the left-hand reading lamp on/off	128
②	 Switches the interior lighting on/off	128
③	 Operates MAGIC SKY CONTROL	105
④	 Switches the automatic interior lighting control on/off	128
⑤	 Switches the right-hand reading lamp on/off	128
⑥	 MB Info call button (mbrace system)	522







	Function	Page
⑦	 SOS button (mbrace system)	520
⑧	Rear-view mirror	117
⑨	Buttons for the garage door opener	530
⑩	 Roadside Assistance call button (mbrace system)	521
⑪	Eyeglasses compartment	513

P82.00-2840-31

Door control panel



	Function	Page
①	Opens the door	88
②	  Unlocks/locks the vehicle	89
③	Adjusts the seats	109
④	    Stores settings for the seat, exterior mirrors and steering wheel (memory function)	119
	 Adjusts the front-passenger seat from the driver's seat	110

	Function	Page
⑤	 Opens the trunk lid	95
	 Opens/closes the trunk lid	95
⑥	   Adjusts the exterior mirrors electrically	116
⑦	 Opens/closes the side windows	96

Useful information	50
Panic alarm	50
Occupant safety	50
Children in the vehicle	68
Pets in the vehicle	71
Driving safety systems	71
Protection against theft	79

Useful information

- i** This Operator's manual describes all models and all standard and optional equipment of your vehicle available at the time of publication of the Operator's manual. Country-specific differences are possible. Please note that your vehicle may not be equipped with all features described. This also applies to safety-related systems and functions.
- i** Read the information on qualified specialist workshops (▷ page 35).

Panic alarm



- ▶ **To activate:** press **PANIC** button ① for at least one second.
An alarm sounds and the exterior lighting flashes.
 - ▶ **To deactivate:** press **PANIC** button ① again.
- or
- ▶ Insert the SmartKey into the ignition lock.
- or
- ▶ Press the KEYLESS-GO Start/Stop button.
The KEYLESS-GO key must be in the vehicle.

Occupant safety

Restraint system: introduction

The restraint system reduces the risk of vehicle occupants coming into contact with parts of the vehicle's interior in the event of an accident. The restraint system can also reduce the forces to which vehicle occupants are subjected during an accident.

The restraint system comprises:

- Seat belt system
- Air bags
- Child restraint system

The components of the restraint system work in conjunction with each other. They can only deploy their protective function if, at all times, all vehicle occupants:

- have fastened their seat belts correctly (▷ page 54)
- have adjusted their seat and head restraint properly (▷ page 109).

As the driver, you also have to make sure that the steering wheel is adjusted correctly. Observe the information relating to the correct driver's seat position (▷ page 108).

You also have to make sure that an air bag can inflate properly if deployed (▷ page 56).

An air bag supplements a correctly worn seat belt. As an additional safety device, the air bag increases the level of protection for vehicle occupants in the event of an accident. For example, if, in the event of an accident, the protection offered by the seat belt is sufficient, the air bags are not deployed. When an accident occurs, only the air bags that increase protection in that particular accident situation are deployed. However, seat belts and air bags generally do not protect against objects penetrating the vehicle from the outside.

Information on restraint system operation can be found under "Triggering of the Emergency Tensioning Device and air bags" (▷ page 64).

For more information about children traveling with you in the vehicle and on child restraint systems, see "Children in the vehicle" (▷ page 68).

Important safety notes

WARNING

Modifications to the restraint system may cause it to no longer work as intended. The restraint system may then not perform its intended protective function and may fail in an accident or trigger unexpectedly, for example. This poses an increased risk of injury or even fatal injury.

Never modify parts of the restraint system. Never tamper with the wiring, the electronic components or their software.

If it is necessary to modify an air bag system to accommodate a person with disabilities, contact an authorized Mercedes-Benz Center for details. USA only: for further information contact our Customer Assistance Center at 1-800-FOR-MERCEDES (1-800-367-6372).

Restraint system warning lamp

The functions of the restraint system are checked after the ignition is switched on and at regular intervals while the engine is running. Therefore, malfunctions can be detected in good time.

The  restraint system warning lamp in the instrument cluster lights up when the ignition is switched on. It goes out no later than a few seconds after the engine is started. The components of the restraint system are in operational readiness.

A malfunction has occurred if the  restraint system warning lamp:

- does not light up after the ignition is switched on
- does not go out after a few seconds with the engine running
- lights up again while the engine is running

WARNING

If restraint system is malfunctioning, restraint system components may be triggered unintentionally or might not be triggered at all in the event of an accident with a high rate of vehicle deceleration. This can affect the Emergency Tensioning Device or air bag, for example. This poses an increased risk of injury or even fatal injury.

Have the restraint system checked and repaired in a qualified specialist workshop as soon as possible.

PASSENGER AIR BAG OFF indicator lamp



PASSENGER AIR BAG OFF indicator lamp ① and PASSENGER AIR BAG ON indicator lamp ② are part of the Occupant Classification System (OCS).

The PASSENGER AIR BAG OFF indicator lamp informs you about the status of the front-passenger front air bag.

If the PASSENGER AIR BAG OFF indicator lamp:

- **is lit:** the front-passenger front air bag is deactivated. They will then not be deployed in the event of an accident.
- **does not light up:** the front-passenger front air bag is enabled. If, in the event of an accident, all deployment criteria are met, the front-passenger front air bag is deployed.

The PASSENGER AIR BAG ON indicator lamp is inoperative. It lights up briefly when the ignition is switched on and then goes out again.

Depending on the person in the front-passenger seat, the front-passenger front air bag must either be disabled or enabled; see the following points. You must make sure of this both before and during a journey.

- **Children in a child restraint system:** whether the front-passenger front air bag is enabled or deactivated depends on the installed child restraint system, and the age and size of the child. Therefore, be sure to observe the notes on the "Occupant classification system (OCS)" (▷ page 59) and on "Children in the vehicle" (▷ page 68). There you will also find instructions on backwards- and forwards-facing child restraint systems on the front-passenger seat.
- **All other persons:** depending on the classification of the person in the front-passenger seat, the front-passenger front air bag is enabled or deactivated (▷ page 59). Be sure to observe the notes on "Seat belts" (▷ page 52) and "Air bags" (▷ page 56). There you can also find information on the correct seat position.

Seat belts

Introduction

Seat belts are the most effective means of restricting the movement of vehicle occupants in the event of an accident or the vehicle rolling over. This reduces the risk of vehicle occupants coming into contact with parts of the vehicle interior or being ejected from the vehicle. Furthermore, the seat belt helps to keep the vehicle occupant in the best position in relation to the air bag.

The seat belt system comprises:

- Seat belts
- Emergency Tensioning Devices and seat belt force limiters

If the seat belt is pulled by the seat belt guide quickly or with a jerky movement, the belt retractor locks. The belt strap cannot be extracted any further.

The Emergency Tensioning Device tightens the seat belt in an accident, pulling the belt close against the body. However it does not pull the vehicle occupant back in the direction of the backrest.

The Emergency Tensioning Device does not correct an incorrect seat position or the routing of an incorrectly fastened seat belt.

When triggered, seat belt force limiters help to reduce the force exerted by the seat belt on the vehicle occupant.

The seat belt force limiters are synchronized with the front air bags, which absorb part of the deceleration force. This can reduce the force exerted on the vehicle occupants during an accident.

! If the front-passenger seat is unoccupied, do not insert the belt tongue into the buckle of the front-passenger seat. This may otherwise lead to the triggering of the Emergency Tensioning Device in the event of an accident, which will then need to be replaced.

Important safety notes

The use of seat belts and child restraint systems is required by law in:

- all 50 states
- the U.S. territories
- the District of Columbia
- all Canadian provinces

Even where this is not required by law, all vehicle occupants should correctly fasten their seat belts before starting the journey.

⚠ WARNING

If the seat belt is incorrectly fastened, it cannot protect as intended. Furthermore, an incorrectly fastened seat belt can cause additional injury, for example, in an accident, during braking or when abruptly changing direction. This poses an increased risk of injury or even fatal injury.

Make sure that all vehicle occupants are seated properly with a correctly fastened seat belt.

⚠ WARNING

The seat belt does not offer the intended level of protection if you have not moved the backrest to an almost vertical position. When braking or in the event of an accident, you could slide underneath the seat belt and sustain abdomen or neck injuries, for example. This poses an increased risk of injury or even fatal injury.

Adjust the seat properly before beginning your journey. Always ensure that the backrest is in an almost vertical position and that the shoulder section of your seat belt is routed across the center of your shoulder.

⚠ WARNING

Persons under 5 ft (1.50 m) in height cannot fasten the seat belt correctly without an additional suitable restraint system. If the seat belt is incorrectly fastened, it cannot protect as intended. Furthermore, an incorrectly fastened seat belt can cause additional injury, for example, in an accident, during braking or an abrupt change of direction. This poses an increased risk of injury or even fatal injury.

For this reason, always secure persons under 5 ft (1.50 m) in height in suitable restraint systems.

If a child younger than 12 years and under 5 ft (1.50 m) in height is traveling in the vehicle:

- always secure the child in a child restraint system suitable for this Mercedes-Benz vehicle. The child restraint system must be

appropriate to the age, weight and size of the child

- always observe the instructions and safety notes in the "Children in the vehicle" section of this Operator's Manual (> page 68) in addition to the child restraint system manufacturer's installation instructions
- be sure to observe the instructions and safety notes on the "Occupant classification system (OCS)" (> page 59)

⚠ WARNING

The seat belts may not perform their intended protective function if:

- they are damaged, modified, extremely dirty, bleach or dyed
- the seat belt buckle is damaged or extremely dirty
- the Emergency Tensioning Devices, belt anchorages or inertia reels have been modified

Seat belts may be damaged in an accident, although the damage may not be visible, e.g. due to splinters of glass. Modified or damaged seat belts may tear or fail, e.g. in an accident. Modified Emergency Tensioning Devices could accidentally trigger or fail to deploy when necessary. This poses an increased risk of injury or even fatal injury.

Never modify the seat belts, Emergency Tensioning Devices, belt anchorages or inertia reels. Make sure that the seat belts are undamaged, not worn out and clean. Following an accident, have the seat belts checked immediately at a qualified specialist workshop.

Only use seat belts that have been approved for your vehicle by Mercedes-Benz. Any such modifications could invalidate the vehicle's general operating permit.

Proper use of the seat belts

Observe the safety notes on the seat belt (▷ page 52).

All vehicle occupants must be wearing the seat belt correctly before beginning the journey. Also make sure that all vehicle occupants are always wearing the seat belt correctly while the vehicle is in motion.

When fastening the seat belt, always make sure that:

- the seat belt tongue is only inserted to the belt buckle belonging to that seat.
- the seat belt is tight across your body.
Avoid wearing bulky clothing, e.g. a winter coat.
- the seat belt is not twisted.
Only then can the forces which occur be distributed over the area of the belt.
- the shoulder section of the belt is always routed across the center of your shoulder.
The shoulder section of the belt must not come into contact with your neck or be routed under your arm.
- the lap belt passes tightly and as low down as possible across your lap.
The lap belt must always be routed across your hip joints and not across your abdomen. This applies particularly to pregnant women. If necessary, push the lap belt down to your hip joint and pull it tight using the shoulder section of the belt.
- the seat belt is not routed across sharp, pointed or fragile objects.
If you have such items located on or in your clothing, e.g. pens, keys or eyeglasses, store these in a suitable place.
- only one person is using a seat belt at a time.

Infants and children must never travel sitting on the lap of a vehicle occupant. In the event of an accident, they could be crushed

between the vehicle occupant and seat belt.

- objects are never secured with a seat belt if the seat belt is also being used by one of the vehicle's occupants.

Seat belts are only intended to secure and restrain vehicle occupants. Always observe the notes in the "Stowage options/compartments" section for securing objects, luggage or loads (▷ page 512).

Fastening seat belts

Please take note of the safety notes on seat belts (▷ page 52) and the notes on their correct use (▷ page 54).



- ▶ Adjust the seat (▷ page 108).
The seat backrest must be in an almost upright position.
- ▶ Pull the seat belt smoothly out of seat belt guide (3) and engage belt tongue (2) into belt buckle (1).
The driver's and front-passenger's seat belts are automatically pulled taut as required, see "Belt adjustment" (▷ page 55).
- ▶ If necessary, pull upwards on the shoulder section of the seat belt to tighten the belt across your body.

In order to attach the child restraint system securely in the vehicle, the seat belt on the co-driver's seat is equipped with a child seat lock. Further information on the "Child seat lock" (> page 69).

Releasing seat belts

! Make sure that the seat belt is fully rolled up. Otherwise, the seat belt or belt tongue will be trapped in the door or in the seat mechanism. This could damage the door, the door trim panel and the seat belt. Damaged seat belts can no longer fulfill their protective function and must be replaced. Visit a qualified specialist workshop.



► Press release button ①, hold belt tongue ② and guide it back towards seat belt guide ③.

Seat belt adjustment

The seat-belt adjustment is an integral part of the PRE-SAFE® convenience function. This function adjusts the driver's and front-passenger seat belt to the upper body of the occupants.

The belt strap is tightened slightly when:



- the belt tongue is engaged in the buckle and
- the ignition is switched on

The seat-belt adjustment will apply a certain tightening force if any slack is detected between the vehicle occupant and the seat belt. Do not hold on to the seat belt tightly while it is adjusting.

You can switch the seat-belt adjustment on and off in the on-board computer (> page 235).

Belt warning for the driver and front passenger

The  seat belt warning lamp in the instrument cluster is a reminder that all occupants must fasten their seat belts. It may light up continuously or flash. In addition, there may be a warning tone.

Regardless of whether the driver's seat belt has already been fastened, the  seat belt warning lamp lights up for six seconds each time the engine is started. If, after six seconds, the driver or front-passenger seat belt has not been fastened and the doors are closed, the  seat belt warning lamp lights up again. As soon as the driver's and front-passenger seat belts are fastened or a front door is opened again, the  seat belt warning lamp goes out.

If the driver's seat belt is not fastened after the engine is started, an additional warning tone will sound. This warning tone stops after six seconds or when the driver's seat belt is fastened.

If the vehicle's speed exceeds 15 mph (25 km/h) once and the driver's and front-passenger seat belts are not fastened, a warning tone sounds. The warning tone sounds with increasing intensity for 60 seconds or until the driver or front passenger have fastened their seat belts.

If the driver or front passenger unfasten their seat belts during the journey, the seat belt warning is activated again.

i For more information on the  seat belt warning lamp, see "Warning and indicator lamps in the instrument cluster, seat belts" (> page 269).

Air bags

Introduction

The installation point of an air bag can be recognized by the AIR BAG symbol.

An air bag complements the correctly fastened seat belt. It is no substitute for the seat belt. The air bag provides additional protection in applicable accident situations.

Not all air bags are deployed in an accident. The different air bag systems function independently from one another (▷ page 64).

However, no system available today can completely eliminate injuries and fatalities.

It is also not possible to rule out a risk of injury caused by an air bag due to the high speed at which the air bag must be deployed.

Important safety notes

WARNING

If you do not sit in the correct seat position, the air bag cannot protect as intended and could even cause additional injury when deployed. This poses an increased risk of injury or even fatal injury.

To avoid hazardous situations, always make sure that all of the vehicle's occupants:

- have fastened their seat belts correctly, including pregnant women
- are sitting correctly and maintain the greatest possible distance to the air bags
- follow the following instructions

Always make sure that there are no objects between the air bag and the vehicle's occupants.

- Adjust the seats properly before beginning your journey. Always make sure that the seat is in an almost upright position. The center of the head restraint must support the head at about eye level.
- Move the driver's and front-passenger seats as far back as possible. The driver's seat position must allow the vehicle to be driven safely.

- Only hold the steering wheel on the outside. This allows the air bag to be fully deployed.
- Always lean against the backrest while driving. Do not lean forwards or lean against the door or side window. You may otherwise be in the deployment area of the air bags.
- Always keep your feet in the footwell in front of the seat. Do not put your feet on the dashboard, for example. Your feet may otherwise be in the deployment area of the air bag.
- For this reason, always secure persons less than 5 ft (1.50 m) tall in suitable restraint systems. Up to this height, the seat belt cannot be worn correctly.

If a child is traveling in your vehicle, also observe the following notes:

- Always secure children under 12 years of age and less than 5 ft (1.50 m) in height in suitable child restraint systems.
- Only secure a child in a rearward-facing child restraint system on the front-passenger seat when the front-passenger front air bag is deactivated. If the PASSENGER AIR BAG OFF indicator lamp is permanently lit, the front-passenger front air bag is deactivated (▷ page 51).
- Always observe the instructions and safety notes on the "Occupant Classification System (OCS)" (▷ page 59) and on "Children in the vehicle" (▷ page 68) in addition to the child restraint system manufacturer's installation instructions.

Objects in the vehicle interior may prevent the air bag from functioning correctly.

Before starting your journey and to avoid risks resulting from the speed of the air bag as it deploys, make sure that:

- there are no people, animals or objects between the vehicle occupants and an air bag.
- there are no objects between the seat, door and B-pillar.

- no hard objects, e.g. coat hangers, hang on the grab handles or coat hooks.
- no accessories, such as cup holders, are attached to the vehicle within the deployment area of an air bag, e.g. to doors or side windows.
- no heavy, sharp-edged or fragile objects are in the pockets of your clothing. Store such objects in a suitable place.

WARNING

If you modify the air bag cover or affix objects such as stickers to it, the air bag can no longer function correctly. There is an increased risk of injury.

Never modify an air bag cover or affix objects to it.

WARNING

Sensors to control the air bags are located in the doors. Modifications or work not performed correctly to the doors or door paneling, as well as damaged doors, can lead to the function of the sensors being impaired. The air bags might therefore not function properly any more. Consequently, the air bags cannot protect vehicle occupants as they are designed to do. There is an increased risk of injury.

Never modify the doors or parts of the doors. Always have work on the doors or door paneling carried out at a qualified specialist workshop.

Front air bags



Driver's air bag ① inflates in front of the steering wheel; front-passenger air bag ② inflates in front of and above the glove box. When deployed, the front air bags offer additional head and thorax protection on the front seats.

The PASSENGER AIR BAG OFF indicator lamp shows you the status of the front-passenger front air bag (▷ page 51).

Front-passenger air bag ② is only deployed if:

- the Occupant Classification System (OCS) recognizes that the front-passenger seat is occupied (▷ page 59)
- the PASSENGER AIR BAG OFF indicator lamp is not lit (▷ page 59)
- the restraint system control unit predicts a high accident severity

Knee bags

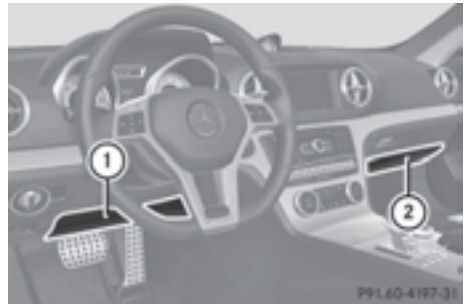

Driver's knee bag ① deploys under the steering column and front-passenger knee bag ② under the glove box. The driver's and front-passenger knee bags are triggered together with the front air bags.

The driver's and front-passenger knee bags offer additional thigh, knee and lower leg protection.

Side impact air bags

WARNING

Unsuitable seat covers could restrict or even prevent the deployment of the air bags inte-

grated into the seats. Consequently, the air bags cannot protect vehicle occupants as they are designed to do. In addition, the function of the Occupant Classification System (OCS) could be restricted. This poses an increased risk of injury or even fatal injury. You should only use seat covers that have been approved for the respective seat by Mercedes-Benz.



Side impact air bags ① deploy next to the outer bolster of the seat backrest.

When deployed, the side impact air bag offers additional thorax protection. However, it does not protect the:

- head
- neck
- arms

In the event of a side impact, the side impact air bag is deployed on the side on which the impact occurs.

The side impact air bag on the front-passenger side deploys under the following conditions:

- the OCS system detects that the front-passenger seat is occupied or
- the belt tongue is engaged in the belt buckle of the front-passenger seat

If the belt tongue is engaged in the belt buckle, the side impact air bag on the front-passenger side deploys if an appropriate accident situation occurs. In this case, deployment is independent of whether the front-passenger seat is occupied or not.

Head bags

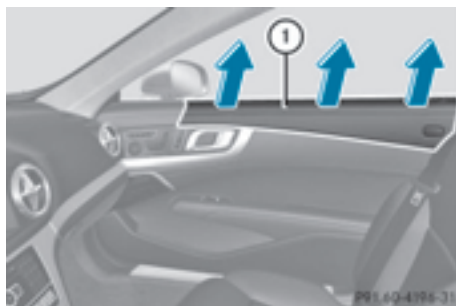

Head bags ① deploy in the area of the side windows at the front.

When deployed, the headbag enhances the level of protection for the head. However, it does not protect your:

- chest
- arms

In the event of a side impact, the headbag is deployed on the side on which the impact occurs.

If the system determines that they can offer additional protection to that provided by the seat belt, a headbag may be deployed in other accident situations (▷ page 64).

The headbag on the front-passenger side does not deploy under the following conditions:

- OCS has detected that the front-passenger seat is unoccupied.
- the front-passenger seat belt is not fastened.

If the belt tongue is engaged in the belt buckle, the headbag on the front-passenger side deploys if an appropriate accident situation occurs. In this case, it will deploy regardless of whether the front-passenger seat is occupied or not.

Occupant Classification System (OCS)

Introduction

The Occupant Classification System (OCS) categorizes the person in the front-passenger seat. Depending on that result, the front-passenger front air bag and front-passenger knee bag are either enabled or deactivated.

The system does not deactivate:

- the side impact air bag
- the front-passenger head bag
- the Emergency Tensioning Devices

Prerequisites

To be classified correctly, the front passenger must sit:

- with the seat belt fastened correctly
- in an almost upright position with their back against the seat backrest
- with their feet resting on the floor, if possible

If the front passenger does not observe these conditions, OCS may produce a false classification, e.g. because the front passenger:

- transfers their weight by supporting themselves on a vehicle armrest
- sits in such a way that their weight is raised from the seat cushion

If you install a child restraint system on the front-passenger seat, be sure to observe the correct positioning of the child restraint system. Never place objects under or behind the child restraint system, e.g. cushions. The entire base of the child restraint system must always rest on the seat cushion of the front-passenger seat. The backrest of the forward-facing child restraint system must, as far as possible, be resting on the backrest of the front-passenger seat.

The child restraint system must not touch the roof or be put under strain by the head restraint. Adjust the angle of the seat back-

rest and the head restraint position accordingly.

Only then can OCS be guaranteed to function correctly. Always observe the child restraint system manufacturer's installation instructions.

Occupant Classification System operation (OCS)



① PASSENGER AIR BAG OFF indicator lamp

② PASSENGER AIR BAG ON indicator lamp

PASSENGER AIR BAG OFF indicator lamp ① informs you whether the front-passenger front air bag is deactivated.

- Turn the SmartKey to position **1** or **2** in the ignition lock, or press the Start/Stop button once or twice on vehicles with KEY-LESS-GO.

The system carries out a self-diagnosis.

The PASSENGER AIR BAG ON indicator lamp is inoperative. It lights up briefly when the ignition is switched on and then goes out again.

The PASSENGER AIR BAG OFF indicator lamp must light up for approximately six seconds.

The PASSENGER AIR BAG OFF indicator lamp then displays the status of the front-passenger front air bag. If the status of the front-passenger front air bag changes while the vehicle is in motion, an air bag display message may appear in the instrument cluster (► page 250). When the front-passenger seat is occupied, always pay attention to the PASSENGER AIR BAG OFF indicator lamp. Be

aware of the status of the front-passenger front air bag both before and during the journey.

If the PASSENGER AIR BAG OFF indicator lamp:

- **is lit**, the front-passenger front air bag is deactivated. They will then not be deployed in the event of an accident.
- **does not light up**: the front-passenger front air bag is enabled. If, in the event of an accident, all deployment criteria are met, the front-passenger front air bag is deployed.

 **WARNING**

If the PASSENGER AIR BAG OFF indicator lamp is lit, the front-passenger front air bag is disabled. It will not be deployed in the event of an accident and cannot perform its intended protective function. A person in the front-passenger seat could then, for example, come into contact with the vehicle's interior, especially if the person is sitting too close to the dashboard. This poses an increased risk of injury or even fatal injury.

When the front-passenger seat is occupied, always ensure that:

- the classification of the person in the front-passenger seat is correct and the front-passenger front air bag is enabled or disabled in accordance with the person in the front-passenger seat
- the front-passenger seat has been moved back as far back as possible.
- the person is seated correctly.

Make sure, both before and during the journey, that the status of the front-passenger front air bag is correct.

 **WARNING**

If you secure a child in a child restraint system on the front-passenger seat and the PASSENGER AIR BAG OFF indicator lamp is off, the front-passenger front air bag can deploy in the event of an accident. The child

could be struck by the air bag. This poses an increased risk of injury or even fatal injury.

Make sure that the front-passenger front air bag has been disabled. The PASSENGER AIR BAG OFF indicator lamp must be lit.

 **WARNING**

If you secure a child in a forward-facing child restraint system on the front-passenger seat and you position the front-passenger seat too close to the dashboard, in the event of an accident, the child could:

- come into contact with the vehicle's interior if the PASSENGER AIR BAG OFF indicator lamp is lit, for example
- be struck by the air bag if the PASSENGER AIR BAG OFF indicator lamp is off

This poses an increased risk of injury or even fatal injury.

Always move the front-passenger seat as far back as possible and fully retract the seat cushion length. Always make sure that the shoulder belt strap is correctly routed from the vehicle seat belt guide to the shoulder belt guide on the child restraint system. The shoulder belt strap must be routed forwards and downwards from the seat belt guide. Always observe the child restraint system manufacturer's installation instructions.

If OCS determines that:

- the front-passenger seat is unoccupied, the PASSENGER AIR BAG OFF indicator lamp lights up after the system self-test and remains lit. This indicates that the front-passenger front air bag is deactivated.
- the front-passenger seat is occupied by a child of up to 12 months old, in a standard child restraint system, the PASSENGER AIR BAG OFF indicator lamp lights up after the system self-test and remains lit. This indicates that the front-passenger front air bag is deactivated.

But in the case of a 12-month-old child, in a standard child restraint system, the PASSENGER AIR BAG OFF indicator lamp

can go out after the system self-test. This indicates that the front-passenger front air bag is activated. The result of the classification is dependent on, among other factors, the child restraint system and the child's stature. Make sure that the conditions for a correct classification are met. If the PASSENGER AIR BAG OFF indicator lamp remains off, do not install a child restraint system on the front-passenger seat.

- the front-passenger seat is occupied by a person of smaller stature (e.g. a teenager or small adult), the PASSENGER AIR BAG OFF indicator lamp lights up and remains lit after the system self-test depending on the result of the classification or, alternatively, goes out.
 - if the PASSENGER AIR BAG OFF indicator lamp is off, move the front-passenger seat as far back as possible.
 - if the PASSENGER AIR BAG OFF indicator lamp is lit, a person of smaller stature should not use the front-passenger seat.
- the front-passenger seat is occupied by an adult or a person of a stature corresponding to that of an adult, the PASSENGER AIR BAG OFF indicator lamp goes out after the system self-test. This indicates that the front-passenger front air bag is activated.

If children are traveling in the vehicle, be sure to observe the notes on "Children in the vehicle" (▷ page 68).

When OCS is malfunctioning, the red  restraint system warning lamp in the instrument cluster and the PASSENGER AIR BAG OFF indicator lamp light up simultaneously. The front-passenger front air bag is deactivated in this case and does not deploy during an accident. Have the system checked by qualified technicians as soon as possible. Consult an authorized Mercedes-Benz Center. The front-passenger seat should only be repaired at an authorized Mercedes-Benz Center. If the front-passenger seat, the seat cover or the seat cushion is damaged, have the nec-

essary repair work carried out at an authorized Mercedes-Benz Center.

For safety reasons, Mercedes-Benz recommends that you only use seat accessories that have been approved by Mercedes-Benz. If the driver's air bag deploys, this does not mean that the front-passenger front air bag will also deploy. The Occupant Classification System (OCS) categorizes the occupant in the front-passenger seat. Depending on that result, the front-passenger front air bag is either enabled or deactivated.

System self-test

DANGER

If the PASSENGER AIR BAG OFF indicator lamp does not light up during the system self-test, then the system is malfunctioning. The front-passenger front air bag might be triggered unintentionally or might not be triggered at all in the event of an accident with high deceleration. This poses an increased risk of injury or even fatal injury.

In this case the front-passenger seat may not be used. Do not install a child restraint system on the front-passenger seat. Have the Occupant Classification System (OCS) checked and repaired immediately at a qualified specialist workshop.

DANGER

If the PASSENGER AIR BAG OFF indicator lamp remains lit after the system self-test, the front-passenger front air bag is disabled. It will not be deployed in the event of an accident. In this case, the front-passenger front air bag cannot perform its intended protective function, e.g. when a person is seated in the front-passenger seat.

That person could, for example, come into contact with the vehicle's interior, especially if the person is sitting too close to the dashboard. This poses an increased risk of injury or even fatal injury.

When the front-passenger seat is occupied, always ensure that:

- the classification of the person in the front-passenger seat is correct and the front-passenger front air bag is enabled or disabled in accordance with the person in the front-passenger seat
- the person is seated properly with a correctly fastened seatbelt
- the front-passenger seat has been moved back as far back as possible

If the PASSENGER AIR BAG OFF indicator lamp remains lit when it should not, the front-passenger seat may not be used. Do not install a child restraint system on the front-passenger seat. Have the Occupant Classification System (OCS) checked and repaired immediately at a qualified specialist workshop.

WARNING

Objects between the seat surface and the child restraint system could affect OCS operation. This could result in the front-passenger air bag not functioning as intended during an accident. This poses an increased risk of injury or even fatal injury.

Do not place any objects between the seat surface and the child restraint system. The entire base of the child restraint system must always rest on the seat cushion of the front-passenger seat. The backrest of the forwards-facing child restraint system must, as far as possible, be resting on the backrest of the front-passenger seat. Always comply with the child restraint system manufacturer's installation instructions.

After the system self-test, the PASSENGER AIR BAG OFF indicator lamp displays the status of the front-passenger front air bag (▷ page 59).

For more information about the OCS, see "Problems with the Occupant Classification System" (▷ page 63).

Problems with the Occupant Classification System (OCS)

Be sure to observe the notes on "System self-test" (▷ page 61).

Problem	Possible causes/consequences and ► Solutions
<p>The PASSENGER AIR BAG OFF indicator lamp lights up and remains lit, even though the front-passenger seat is occupied by an adult or a person of a stature corresponding to that of an adult.</p>	<p>The classification of the person on the front-passenger seat is incorrect.</p> <ul style="list-style-type: none"> ► Make sure the conditions for a correct classification of the person on the front-passenger seat are met (▷ page 59). ► If the PASSENGER AIR BAG OFF indicator lamp remains lit, the front-passenger seat may not be used. ► Have OCS checked as soon as possible at an authorized Mercedes-Benz Center.
<p>The PASSENGER AIR BAG OFF indicator lamp does not light up and/or does not stay on.</p> <p>The front-passenger seat is:</p> <ul style="list-style-type: none"> • unoccupied • occupied by the weight of a child up to 12 months old in a child restraint system 	<p>OCS is malfunctioning.</p> <ul style="list-style-type: none"> ► Make sure there is nothing between the seat cushion and the child seat. ► Make sure that the entire base of the child restraint system rests on the seat cushion of the front-passenger seat. The backrest of the forwards-facing child restraint system must, as far as possible, be resting on the backrest of front-passenger seat. If necessary, adjust the position of the front-passenger seat. ► Make sure that the seat cushion length is fully retracted. ► When installing the child restraint system, make sure that the seat belt is tight. Do not pull the seat belt tight with the front-passenger seat adjustment. This could result in the seat belt and the child restraint system being pulled too tightly. ► Check the installation of the child restraint system. <p>Make sure that the head restraint does not apply a load to the child restraint system. If necessary, adjust the head restraint accordingly.</p> <ul style="list-style-type: none"> ► Make sure that no objects are applying additional weight onto the seat. ► If the PASSENGER AIR BAG OFF indicator lamp remains off, do not install a child restraint system on the front-passenger seat. ► Have OCS checked as soon as possible at an authorized Mercedes-Benz Center.

Roll bar

DANGER

If the roll bar has developed a malfunction, it may not function, e.g. in the event of an acci-

dent. The roll bars may then not protect the vehicle occupants as intended. This poses an increased risk of injury or even fatal injury.

Have roll bars checked immediately at a qualified specialist workshop.

⚠ WARNING

If you place objects or clothing on the roll bar covers, these could impair roll bar extension. The roll bars may then not protect the vehicle occupants as intended. In addition, objects could endanger the vehicle occupants when the roll bar is extending. This poses an increased risk of injury or even fatal injury. Ensure that the movement area of the roll bar covers is kept clear. Always stow all objects in the vehicle correctly.

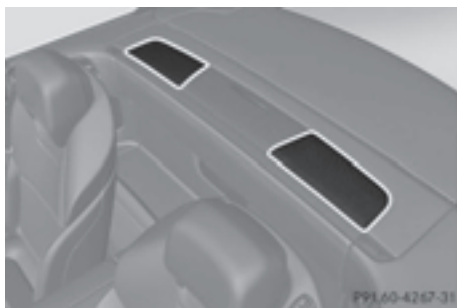

The roll bars are located in the rear area of the vehicle under the two outer rear compartment trim covers.

They extend if systems detect that the vehicle is in danger of rollover. The two outer rear compartment trim covers are opened and the roll bars are extended within fractions of a second.

Once the roll bars are extended, you can no longer lower them. An open roof can no longer be closed. In this case, visit the nearest qualified specialist workshop.

Deployment of Emergency Tensioning Devices and air bags

Important safety notes

⚠ WARNING

The air bag parts are hot after an air bag has been deployed. There is a risk of injury.

Do not touch the air bag parts. Have a deployed air bag replaced at a qualified specialist workshop as soon as possible.

⚠ WARNING

A deployed air bag no longer offers any protection and cannot provide the intended protection in an accident. There is an increased risk of injury.

Have the vehicle towed to a qualified specialist workshop in order to have a deployed air bag replaced.

It is important for your safety and that of your passenger to have deployed air bags replaced and to have any malfunctioning air bags repaired. This will help to make sure the air bags continue to perform their protective function for the vehicle occupants in the event of a crash.

⚠ WARNING

Pyrotechnic Emergency Tensioning Devices that have been deployed are no longer operational and are unable to perform their intended protective function. This poses an increased risk of injury or even fatal injury.

Therefore, have pyrotechnic Emergency Tensioning Devices which have been triggered immediately replaced at a qualified specialist workshop.

An electric motor is used by PRE-SAFE® to trigger the tightening of the seat belt in hazardous situations. This procedure is reversible.

If the Emergency Tensioning Devices or air bags are deployed, you will hear a bang and a small amount of powder may also be released. The  restraint system warning lamp will light up.

Only in rare cases will the bang affect your hearing. The powder released is generally not hazardous to health, it could however cause short-term breathing difficulties in people with asthma or other respiratory problems. In order to prevent breathing difficulties, you

should leave the vehicle as soon as it is safe to do so, or open the window.

Air bags and pyrotechnic seat belt tensioners contain perchlorate material, which may require special handling or environmental protection measures. Check with your local government's disposal guidelines. California residents, see www.dtsc.ca.gov/HazardousWaste/Perchlorate/index.cfm.

Method of operation

During the first stage of a collision, the restraint system control unit evaluates important physical data relating to vehicle deceleration or acceleration, such as:

- Duration
- Direction
- Intensity

Based on the evaluation of this data, the restraint system control unit triggers the belt tensioners in the event of a frontal or rear collision.

An Emergency Tensioning Device can only be triggered if:

- the ignition is switched on
- the restraint system components are ready for operation, see "Restraint system warning lamp" (▷ page 51)
- the belt tongue is inserted into the buckle on the respective front seat

If the restraint system control unit detects a high accident severity, additional components of the restraint system are activated independently of one another in certain frontal collision situations:

- Front air bags as well as driver's and front-passenger kneebag

Depending on the person occupying the front-passenger seat, the front-passenger air bag is activated or deactivated. The front-passenger front air bag can only be deployed in an accident if the PASSENGER AIR BAG OFF indicator lamp is off. Observe the information on the

PASSENGER AIR BAG OFF indicator lamp (▷ page 51).

Your vehicle has two-stage front air bags. During the first deployment stage, the front air bag fills with propellant gas which reduces the risk of injury. The second stage is then triggered within milliseconds, filling the front air bag with the maximum amount of propellant gas.

The deployment thresholds for the Emergency Tensioning Devices and air bags are calculated on the basis of the vehicle deceleration or acceleration occurring at various points in the vehicle. This process is pre-emptive in nature. The air bag must be deployed on time, at the start of the collision.

The rate of vehicle deceleration or acceleration and the direction of the force are essentially determined by:

- distribution of the force during the impact
- collision angle
- deformation characteristics of the vehicle
- characteristics of the object with which the vehicle has collided

Factors which can only be seen and measured after the collision has occurred do not play a decisive role in the deployment of an airbag, nor do they provide an indication of air bag deployment.

The vehicle may be considerably deformed without an air bag being deployed. This is the case if only relatively easily deformable parts have been hit and a high rate of deceleration has not been reached. Conversely, an air bag may be deployed even though the vehicle suffers only minor deformation. This is the case if, for example, very rigid vehicle parts such as the longitudinal body members are hit in an accident and the rate of deceleration is sufficient.

If the restraint system control unit detects a side impact or an overturn situation, the relevant restraint system components are activated independently of one another depending on the apparent type of accident. If additional protection for the vehicle occupants is determined in this situation, the belt tensioners are also triggered.

- Sidebag on the side on which the impact occurs, independently of the belt tensioner and of the use of the seat belt on the driver's seat

The sidebag on the front-passenger side deploys under the following conditions:

- the OCS system detects that the front-passenger seat is occupied or
- the belt tongue has engaged in the belt buckle of the front-passenger seat.

- Headbag on the side on which the impact occurs, independently of the use of the seat belt and independently of whether the front-passenger seat is occupied
- Headbags on the driver's and front-passenger sides in certain overturn situations if the system determines that they can offer additional protection to that provided by the seat belt

i Not all air bags are deployed in an accident. The various air bag systems work independently of each other.

How the air bag system works is determined by the severity of the accident detected, especially the vehicle deceleration or acceleration, and the apparent type of accident:

- frontal collision
- side impact
- rollover

NECK-PRO head restraints

Important safety notes

WARNING

The function of the head restraint may be impaired if you:

- attach objects such as coat hangers to the head restraints, for example
- use head restraint covers

If you do so, the head restraints cannot fulfill their intended protective function in the event of an accident. In addition, objects attached to the head restraints could endanger other vehicle occupants. There is an increased risk of injury.

Do not attach any objects to the head restraints and do not use head restraint covers.

Method of operation

NECK-PRO head restraints reduce the likelihood of head and chest injuries. The NECK-PRO head restraints on the driver's and front-passenger seats are moved forwards and upwards in the event of a rear-end collision of a certain severity. This provides better head support.

If the NECK-PRO head restraints have been triggered in an accident, you must reset the NECK-PRO head restraints on the driver's and front-passenger seat (▷ page 67). Otherwise, the additional protection will not be available in the event of another rear-end collision. You can recognize when NECK-PRO head restraints have been triggered by the fact that they have moved forwards and can no longer be adjusted.

Mercedes-Benz recommends that you have the NECK-PRO head restraints checked for functionality at a qualified specialist workshop after a rear-end collision.

Resetting triggered NECK-PRO head restraints



Do not insert your finger between the upholstery of the head restraint and the seat. Pay particular attention while resetting the NECK-PRO head restraints.

- ▶ Tilt the top of the NECK-PRO head restraint cushion forwards in the direction of arrow ①.
- ▶ Push the NECK-PRO head restraint cushion down as far as it will go in the direction of arrow ②.
- ▶ Firmly push the NECK-PRO head restraint cushion back in the direction of arrow ③ until the cushion engages.
- ▶ Repeat this procedure for the second NECK-PRO head restraint.

i Resetting the NECK-PRO head restraints requires a lot of strength. If you have difficulty resetting the NECK-PRO head restraints, have this work carried out at a qualified specialist workshop.

PRE-SAFE® (anticipatory occupant protection system)

Introduction

In certain hazardous situations, PRE-SAFE® takes pre-emptive measures to protect the vehicle occupants.

Important safety notes

! Make sure that there are no objects in the footwell or behind the seats. There is a danger that the seats and/or objects could be damaged when PRE-SAFE® is activated.

Although your vehicle is equipped with PRE-SAFE®, the possibility of injury in the event of an accident cannot be ruled out. Always adapt your driving style to suit the prevailing road and weather conditions and maintain a safe distance from the vehicle in front. Drive carefully.

Function

PRE-SAFE® intervenes:

- in emergency braking situations, e.g. when BAS is activated
- in critical driving situations, e.g. when physical limits are exceeded and the vehicle understeers or oversteers severely
- on vehicles with the Active Driving Assistance package: if BAS PLUS intervenes powerfully or the radar sensor system detects an imminent danger of collision in certain situations

PRE-SAFE® takes the following measures depending on the hazardous situation detected:

- the seat belts are pre-tensioned.
- if the vehicle skids, the side windows are closed so that only a small gap remains.
- the front-passenger seat is adjusted if it is in an unfavorable position.
- vehicles with a multicontour seat: the air pressure in the side bolsters of the seat backrest is increased.

If the hazardous situation passes without resulting in an accident, PRE-SAFE® slackens the belt pre-tensioning. On vehicles with multicontour seats, the air pressure in the side bolsters is reduced again. All settings made by PRE-SAFE® can then be reversed.

If the seat belt pre-tensioning is not reduced:

- ▶ Move the seat backrest or seat back slightly when the vehicle is stationary. The seat belt pre-tensioning is reduced and the locking mechanism is released.

The seat-belt adjustment is an integral part of the PRE-SAFE® convenience function. Information about the convenience function can be found under "Belt adjustment" (▷ page 55).

Automatic measures after an accident

Immediately after an accident, the following measures are implemented, depending on the type and severity of the impact:

- by activating the hazard warning lamps
- the emergency lighting is activated
- the vehicle doors are unlocked
- the front side windows are lowered
- the electrically adjustable steering wheel is raised
- the engine is switched off
- vehicles with mbrace: automatic emergency call

Children in the vehicle

Important safety notes

If a child younger than 12 years and under 5 ft (1.50 m) in height is traveling in the vehicle:

- always secure the child in a child restraint system suitable for Mercedes-Benz vehicles. The child restraint system must be appropriate to the age, weight and size of the child
- be sure to observe the instructions and safety notes in this section in addition to

the child restraint system manufacturer's installation instructions

- be sure to observe the instructions and safety notes on the "Occupant classification system (OCS)" (▷ page 59)

WARNING

If you leave children unsupervised in the vehicle, they could set it in motion by, for example:

- release the parking brake.
- shift the automatic transmission out of the parking position **P**.
- start the engine.

In addition, they may operate vehicle equipment and become trapped. There is a risk of an accident and injury.

When leaving the vehicle, always take the SmartKey with you and lock the vehicle. Never leave children unsupervised in the vehicle.

WARNING

If persons, particularly children are subjected to prolonged exposure to extreme heat or cold, there is a risk of injury, possibly even fatal. Never leave children unattended in the vehicle.

WARNING

If the child restraint system is subjected to direct sunlight, parts may get very hot. Children may burn themselves on these parts, particularly on the metal parts of the child restraint system. There is a risk of injury.

If you leave the vehicle, taking the child with you, always ensure that the child restraint system is not exposed to direct sunlight. Protect it with a blanket, for example. If the child restraint system has been exposed to direct sunlight, let it cool down before securing the child in it. Never leave children unattended in the vehicle.

Always ensure that all vehicle occupants have their seat belts fastened correctly and are sitting properly. Particular attention must be paid to children.

Observe the safety notes on the seat belt (▷ page 52) and the notes on correct use of seat belts (▷ page 54).

A booster seat may be necessary to achieve proper seat belt positioning for children over 41 lbs (18 kg) or until they reach a height where a lap/shoulder belt can be fastened properly without a booster seat.

Special seat belt retractor

WARNING

If the seat belt is released while driving, the child restraint system will no longer be secured properly. The special seat belt retractor is disabled and the inertia reel draws in a portion of the seat belt. The seat belt cannot be immediately refastened. There is an increased risk of injury, possibly even fatal.

Stop the vehicle immediately, paying attention to road and traffic conditions. Reactivate the special seat belt retractor and secure the child restraint system properly.

The seat belt on the front passenger side is equipped with a special seat belt retractor. When activated, the special seat belt retractor ensures that the seat belt cannot slacken once the child seat is secured.

Installing a child restraint system:

- ▶ Make sure you observe the child restraint system manufacturer's installation instructions.
- ▶ Pull the seat belt smoothly out of the seat belt guide.
- ▶ Engage seat belt tongue in belt buckle.

Activating the special seat belt retractor:

- ▶ Pull the seat belt out fully and let the inertia reel retract it again.
While the seat belt is retracting, you should hear a ratcheting sound. The special seat belt retractor is enabled.
- ▶ Push the child restraint system down so that the seat belt is tight and does not loosen.

Removing a child restraint system/deactivating the special seat belt retractor:

- ▶ Make sure you observe the child restraint system manufacturer's installation instructions.
- ▶ Press the belt buckle release button, hold the belt tongue and guide it back towards the seat belt guide.
The special seat belt retractor is deactivated.

Child restraint system

The use of seat belts and child restraint systems is required by law in:

- all 50 states
- the U.S. territories
- the District of Columbia
- all Canadian provinces

You can obtain further information about the correct child restraint system from any authorized Mercedes-Benz Center.

WARNING

If the child restraint system is installed incorrectly on a suitable seat, it cannot protect as intended. The child cannot then be restrained in the event of an accident, heavy braking or sudden changes of direction. There is an increased risk of injury, possibly even fatal.

Make sure that you observe the child restraint system manufacturer's installation instructions and the notes on use. Please ensure, that the base of the child restraint system is always resting completely on the seat cushion. Never place objects, e.g. cushions, under or behind the child restraint system. Only use child restraint systems with the original cover designed for them. Only replace damaged covers with genuine covers.

WARNING

If the child restraint system is installed incorrectly or is not secured, it can come loose in the event of an accident, heavy braking or a

sudden change in direction. The child restraint system could be thrown about, striking vehicle occupants. There is an increased risk of injury, possibly even fatal.

Always install child restraint systems properly, even if they are not being used. Make sure that you observe the child restraint system manufacturer's installation instructions.

Further information on stowing objects, luggage and loads securely can be found under "Stowing options/stowage compartments" (▷ page 512).

WARNING

Child restraint systems or their securing systems which have been damaged or subjected to a load in an accident can no longer protect as intended. The child cannot then be restrained in the event of an accident, heavy braking or sudden changes of direction. There is an increased risk of injury, possibly even fatal.

Replace child restraint systems which have been damaged or subjected to a load in an accident as soon as possible. Have the securing systems on the child restraint system checked at a qualified specialist workshop, before you install a child restraint system again.

If a child is carried on the front-passenger seat, be sure to observe the information on the "Occupant Classification System (OCS)" (▷ page 59). There you will also find information on deactivating the front-passenger front air bag.

All child restraint systems must meet the following standards:

- U.S. Federal Motor Vehicle Safety Standards 213 and 225
- Canadian Motor Vehicle Safety Standards 213 and 210.2

Confirmation that the child restraint system corresponds to the standards can be found on an instruction label on the child restraint system. This confirmation can also be found

in the installation instructions that are included with the child restraint system.

Observe the warning labels in the vehicle interior and on the child restraint system.

Child restraint system on the front-passenger seat

General notes

If you secure a child in a child restraint system on the front-passenger seat, be sure to observe the instructions and safety notes on the "Occupant Classification System (OCS)" (▷ page 59).

You can thus avoid the risks that could arise as a result of:

- an incorrectly categorized person in the front-passenger seat
- the unintentional deactivation of the front-passenger front air bag
- the unsuitable positioning of the child restraint system, e.g. too close to the dashboard

Rearward-facing child restraint system

If it is absolutely necessary to install a rearward-facing child restraint system on the front-passenger seat, always make sure that the front-passenger front air bag is deactivated. Only if the PASSENGER AIR BAG OFF indicator lamp is permanently lit (▷ page 51) is the front-passenger front air bag deactivated.

Always observe the child restraint system manufacturer's installation and operating instructions.

Forward-facing child restraint system

If you secure a child in a forward-facing child restraint system on the front-passenger seat, always move the front-passenger seat as far back as possible. Fully retract the seat cushion length. The entire base of the child restraint system must always rest on the seat

cushion of the front-passenger seat. The backrest of the child restraint system must, as far as possible, lie flat against the backrest of the front-passenger seat. The child restraint system must not touch the roof or be put under strain by the head restraint. Adjust the angle of the seat backrest and the head restraint position accordingly. Always make sure that the shoulder belt strap is correctly routed from the front-passenger seat belt guide to the shoulder belt guide on the child restraint system. The shoulder belt strap must be routed forwards and downwards from the front-passenger seat belt guide. If necessary, adjust the front-passenger seat accordingly.

Always observe the child restraint system manufacturer's installation and operating instructions.

Pets in the vehicle

WARNING

If you leave animals unattended or unsecured in the vehicle, they could press buttons or switches, for example.

As a result, they could:

- activate vehicle equipment and become trapped, for example
- activate or deactivate systems, thereby endangering other road users

Unsecured animals could also be flung around the vehicle in the event of an accident or sudden steering or braking, thereby injuring vehicle occupants. There is a risk of an accident and injury.

Never leave animals unattended in the vehicle. Always secure animals properly during the journey, e.g. use a suitable animal transport box.

Driving safety systems

Overview of driving safety systems

In this section, you will find information about the following driving safety systems:

- **ABS (Anti-lock Braking System)** (▷ page 72)
- **BAS (Brake Assist System)** (▷ page 72)
- **BAS PLUS (Brake Assist System Plus)** (▷ page 72)
- **ESP® (Electronic Stability Program)** (▷ page 74)
- **EBD (Electronic Brake force Distribution)** (▷ page 77)
- **ADAPTIVE BRAKE** (▷ page 77)
- **PRE-SAFE® Brake** (▷ page 77)
- **STEER CONTROL** (▷ page 79)

Important safety notes

If you fail to adapt your driving style or become distracted, the driving safety systems can neither reduce the risk of accident nor override the laws of physics. Driving safety systems are merely aids designed to assist driving. You are responsible for the distance to the vehicle in front, for vehicle speed and for braking in good time. Always adapt your driving style to suit the prevailing road and weather conditions and maintain a safe distance from the vehicle in front. Drive carefully.

- i** The driving safety systems described only work as effectively as possible when there is adequate contact between the tires and the road surface. Please pay special attention to the notes on tires, recommended minimum tire tread depths, etc. (▷ page 568).

In wintry driving conditions, always use winter tires (M+S tires) and if necessary, snow chains. Only in this way will the driving safety systems described in this section work as effectively as possible.

ABS (Anti-lock Braking System)

General information

ABS regulates brake pressure in such a way that the wheels do not lock when you brake. This allows you to continue steering the vehicle when braking.

The yellow  ABS warning lamp in the instrument cluster lights up when the ignition is switched on. It goes out when the engine is running.

Important safety notes

- i** Observe the "Important safety notes" section (▷ page 71).

WARNING

If ABS is faulty, the wheels could lock when braking. The steerability and braking characteristics may be severely impaired. Additionally, further driving safety systems are deactivated. There is an increased danger of skidding and accidents.

Drive on carefully. Have ABS checked immediately at a qualified specialist workshop.

When ABS is malfunctioning, other systems, including driving safety systems, will also become inoperative. Observe the information on the ABS warning lamp (▷ page 271) and display messages which may be shown in the instrument cluster (▷ page 240).

ABS works from a speed of about 5 mph (8 km/h), regardless of road-surface conditions. ABS works on slippery surfaces, even if you only brake gently.

Braking

- ▶ **If ABS intervenes:** continue to depress the brake pedal vigorously until the braking situation is over.
- ▶ **To make a full brake application:** depress the brake pedal with full force.

If ABS intervenes when braking, you will feel a pulsing in the brake pedal.

The pulsating brake pedal can be an indication of hazardous road conditions, and functions as a reminder to take extra care while driving.

BAS (Brake Assist System)

General information

BAS operates in emergency braking situations. If you depress the brake pedal quickly, BAS automatically boosts the braking force, thus shortening the stopping distance.

Important safety notes

- i** Observe the "Important safety notes" section (▷ page 71).

WARNING

If BAS is malfunctioning, the braking distance in an emergency braking situation is increased. There is a risk of an accident.

In an emergency braking situation, depress the brake pedal with full force. ABS prevents the wheels from locking.

Braking

- ▶ Keep the brake pedal firmly depressed until the emergency braking situation is over. ABS prevents the wheels from locking.

The brakes will function as usual once you release the brake pedal. BAS is deactivated.

BAS PLUS (Brake Assist System PLUS)

General information

- i** Observe the "Important safety notes" section (▷ page 71).

BAS PLUS is only available in vehicles equipped with DISTRONIC PLUS.

For BAS PLUS to assist you, the radar sensor system must be operational.

With the help of the radar sensor system, BAS PLUS can detect obstacles that are in the path of your vehicle for an extended period of time.

If the radar sensor system is malfunctioning, BAS PLUS will not be available. The brake system is still available with complete brake boosting effect and BAS.

BAS PLUS can help you to minimize the risk of a collision with a vehicle or reduce the effects of such a collision. If BAS PLUS detects a danger of collision, you are assisted when braking.

Important safety notes

WARNING

BAS PLUS cannot always clearly identify objects and complex traffic situations.

In such cases, BAS PLUS may:

- intervene unnecessarily
- not intervene

There is a risk of an accident.

Always pay careful attention to the traffic situation and be ready to brake. Terminate the intervention in a non-critical driving situation.

WARNING

BAS PLUS does not react:

- to people or animals
- to oncoming vehicles
- to crossing traffic
- when cornering

As a result, BAS PLUS may not intervene in all critical situations. There is a risk of an accident.

Always pay careful attention to the traffic situation and be ready to brake.

In the event of snowfall or heavy rain, the recognition can be impaired.

Recognition by the radar sensor system is also impaired in the event of:

- dirt on the sensors or anything else covering the sensors
- there is interference by other radar sources
- there are strong radar reflections, for example in parking garages
- a narrow vehicle traveling in front, e.g. a motorbike
- a vehicle traveling in front on a different line relative to the center of your vehicle

Following damage to the front end of the vehicle, have the configuration and operation of the radar sensors checked at a qualified specialist workshop. This also applies to collisions at low speeds where there is no visible damage to the front of the vehicle.

Function

To avoid a collision, BAS PLUS calculates the brake force necessary if:

- you approach an obstacle, and
- BAS PLUS has detected a risk of collision

When driving at a speed under 20 mph

(30 km/h): if you depress the brake pedal, BAS PLUS is activated. The increase in brake pressure will be carried out at the last possible moment.

When driving at a speed above 20 mph

(30 km/h): if you depress the brake pedal sharply, BAS PLUS automatically raises the brake pressure to a value adapted to the traffic situation.

BAS PLUS provides braking assistance in hazardous situations with vehicles in front within a speed range between 4 mph (7 km/h) and 155 mph (250 km/h).

At speeds of up to approximately 40 mph (70 km/h), BAS PLUS can also react to stationary objects. Examples of stationary objects are stopped or parked vehicles.

-  If BAS PLUS demands particularly high braking force, preventative passenger pro-

tection measures (PRE-SAFE®) are activated simultaneously.

- ▶ Keep the brake pedal depressed until the emergency braking situation is over. ABS prevents the wheels from locking.

BAS PLUS is deactivated and the brakes function as usual again, if:

- you release the brake pedal.
- there is no longer a risk of collision.
- no obstacle is detected in front of your vehicle.
- you depress the accelerator pedal.
- you activate kickdown.

ESP® (Electronic Stability Program)

General notes

- i** Observe the "Important safety notes" section (▷ page 71).

ESP® monitors driving stability and traction, i.e. power transmission between the tires and the road surface.

If ESP® detects that the vehicle is deviating from the direction desired by the driver, one or more wheels are braked to stabilize the vehicle. The engine output is also modified to keep the vehicle on the desired course within physical limits. ESP® assists the driver when pulling away on wet or slippery roads. ESP® can also stabilize the vehicle during braking.

ETS (Electronic Traction System)

- i** Observe the "Important safety notes" section (▷ page 71).

ETS traction control is part of ESP®.

ETS brakes the drive wheels individually if they spin. This enables you to pull away and accelerate on slippery surfaces, for example if the road surface is slippery on one side. In addition, more drive torque is transferred to the wheel or wheels with traction.

ETS remains active when you deactivate ESP®.

- i** **AMG vehicles:** your vehicle may be equipped with 20-inch tires on the rear axle. If replaced with a 19-inch tire, ETS may intervene noticeably sooner for the first few kilometers. After approximately 10 km ETS will function as usual again. Information on the dimensions and types of wheels and tires for your vehicle can be found in the "Wheel/tire combinations" section (▷ page 593).

Important safety notes



WARNING

If ESP® is malfunctioning, ESP® is unable to stabilize the vehicle. Additionally, further driving safety systems are deactivated. This increases the risk of skidding and an accident. Drive on carefully. Have ESP® checked at a qualified specialist workshop.

- !** When testing the electric parking brake on a braking dynamometer, switch off the ignition. Application of the brakes by ESP® may otherwise destroy the brake system.

When towing the vehicle with the rear axle raised, observe the notes on ESP® (▷ page 561).

ESP® is deactivated if the  warning lamp in the instrument cluster lights up continuously when the engine is running.

If the  warning lamp and the  warning lamp are lit continuously, ESP® is not available due to a malfunction.

Observe the information on warning lamps (▷ page 273) and display messages which may be shown in the instrument cluster (▷ page 240).

- i** Only use wheels with the recommended tire sizes. Only then will ESP® function properly.

Characteristics of ESP®

General information

If the  ESP warning lamp goes out before beginning the journey, ESP® is automatically active.

If ESP® intervenes, the  ESP® warning lamp flashes in the instrument cluster.

If ESP® intervenes:

- ▶ Do not deactivate ESP® under any circumstances.
- ▶ Only depress the accelerator pedal as far as necessary when pulling away.
- ▶ Adapt your driving style to suit the prevailing road and weather conditions.

ECO start/stop function

The ECO start/stop function switches the engine off automatically when the vehicle stops moving. The engine starts automatically when the driver wants to pull away again. ESP® remains in its previously selected status. **Example:** if ESP® was deactivated before the engine was switched off, ESP® remains deactivated when the engine is switched on again.

Deactivating/activating ESP® (except AMG vehicles)

Important safety notes

- ❗ Observe the "Important safety notes" section (▶ page 71).

You can select between the following states of ESP®:

- ESP® is activated.
- ESP® is deactivated.

WARNING

If you deactivate ESP®, ESP® no longer stabilizes the vehicle. There is an increased risk of skidding and an accident.

Only deactivate ESP® in the situations described in the following.

It may be best to deactivate ESP® in the following situations:

- when using snow chains
- in deep snow
- on sand or gravel

❗ Activate ESP® as soon as the situations described above no longer apply. ESP® will otherwise not be able to stabilize the vehicle if the vehicle starts to skid or a wheel starts to spin.

❗ Avoid spinning the driven wheels for an extended period with ESP® deactivated. You could otherwise damage the drivetrain.

Deactivating/activating ESP®

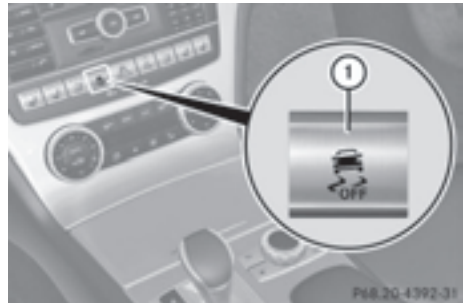

▶ **To switch off:** press button ①.

The  ESP® OFF warning lamp in the instrument cluster lights up.

▶ **To switch on:** press button ①.

The  ESP® OFF warning lamp in the instrument cluster goes out.

Characteristics when ESP® is deactivated

If ESP® is deactivated and one or more wheels start to spin, the  ESP® warning lamp in the instrument cluster flashes. In such situations, ESP® will not stabilize the vehicle.

If you deactivate ESP®:

- ESP® no longer improves driving stability.
- engine torque is no longer limited and the drive wheels are able to spin.

The spinning of the wheels results in a cutting action for better traction on loose surfaces.

- traction control is still activated.
- ESP® still provides support when you brake.

Deactivating/activating ESP® (AMG vehicles)

Important safety notes

- ❗ Observe the "Important safety notes" section (▷ page 71).

You can select between the following states of ESP®:

- ESP® is activated.
- SPORT handling mode is activated.
- ESP® is deactivated.

⚠ WARNING

When SPORT handling mode is activated, there is a greater risk of skidding and accidents.

Only activate SPORT handling mode in the situations described in the following.

⚠ WARNING

If you deactivate ESP®, ESP® no longer stabilizes the vehicle. There is an increased risk of skidding and an accident.

Only deactivate ESP® in the situations described in the following.

In the following situations, it may be better to activate SPORT handling mode or deactivate ESP®:

- when using snow chains
- in deep snow
- on sand or gravel
- on designated roads when the vehicle's own oversteering and understeering characteristics are desired

Driving in SPORT handling mode or without ESP® requires an extremely qualified and experienced driver.

- ❗ Activate ESP® as soon as the situations described above no longer apply. ESP® will otherwise not be able to stabilize the vehicle if the vehicle starts to skid or a wheel starts to spin.

- ❗ Avoid spinning the driven wheels for an extended period with ESP® deactivated. You could otherwise damage the drivetrain.

Deactivating/activating ESP®



► To activate SPORT handling mode:

briefly press button ①.

The **SPORT** SPORT handling mode warning lamp in the instrument cluster lights up. The **SPORT handling mode** message appears in the multifunction display.

► To deactivate SPORT handling mode:



briefly press button ①.

The **SPORT** SPORT handling mode warning lamp in the instrument cluster goes out.

► To deactivate ESP®: press button ① until the ESP® OFF warning lamp lights up in the instrument cluster.

The  **OFF** message appears in the multifunction display.

► To activate ESP®: briefly press button ①.

The  ESP® OFF warning lamp in the instrument cluster goes out. The  **ESP® ON** message appears in the multifunction display.

Characteristics of activated SPORT handling mode

If SPORT handling mode is activated and one or more wheels start to spin, the  ESP® warning lamp in the instrument cluster flashes. ESP® only stabilizes the vehicle to a limited degree.

When SPORT handling mode is activated:

- ESP® only improves driving stability to a limited degree.
- the engine's torque is restricted only to a limited degree and the drive wheels can spin. The spinning of the wheels results in a cutting action, which provides better grip.
- ETS is still active.
- ESP® still provides support when you brake.

Characteristics when ESP® is deactivated

If ESP® is deactivated and one or more wheels start to spin, the  ESP® warning lamp in the instrument cluster does not flash. In such situations, ESP® will not stabilize the vehicle.

If you deactivate ESP®:

- ESP® no longer improves driving stability.
- engine torque is no longer limited and the drive wheels are able to spin.
The spinning of the wheels results in a cutting action for better traction on loose surfaces.
- traction control is still activated.
- PRE-SAFE® is no longer available, nor is it activated if you brake firmly and ESP® intervenes.
- PRE-SAFE® Brake is no longer available, it is also not activated if you brake firmly and ESP® intervenes.
- ESP® still provides support when you brake.

EBD (electronic brake force distribution)

General information

EBD monitors and controls the brake pressure on the rear wheels to improve driving stability while braking.

Important safety notes

- ❗ Observe the "Important safety notes" section for driving safety systems (▷ page 71).

WARNING

If EBD has malfunctioned, the rear wheels can still lock, e.g. under full braking. This increases the risk of skidding and an accident.

You should therefore adapt your driving style to the different handling characteristics. Have the brake system checked at a qualified specialist workshop.

Observe information regarding indicator and warning lamps (▷ page 271) as well as display messages (▷ page 242).

ADAPTIVE BRAKE

- ❗ Observe the "Important safety notes" section (▷ page 71).

ADAPTIVE BRAKE enhances braking safety and offers increased braking comfort. In addition to the braking function, ADAPTIVE BRAKE also has the HOLD function (▷ page 191) and hill start assist (▷ page 154).

PRE-SAFE® Brake

General information

- ❗ Observe the "Important safety notes" section (▷ page 71).

PRE-SAFE® Brake is only available in vehicles with DISTRONIC PLUS.

For PRE-SAFE® Brake to assist you when driving, the radar sensor system must be operational.

With the help of the radar sensor system, PRE-SAFE® Brake can detect obstacles that are in front of your vehicle for an extended period of time.

PRE-SAFE® Brake can help you to minimize the risk of a collision with a vehicle ahead, and reduce the effects of such a collision. If PRE-SAFE® Brake has detected a risk of collision, you will be warned visually and acoustically as well as by automatic braking. PRE-SAFE® Brake cannot prevent a collision without your intervention.

Important safety notes

WARNING

PRE-SAFE® Brake will initially brake your vehicle by a partial application of the brakes if a danger of collision is detected. There may be a collision unless you also brake. Automatic emergency braking cannot prevent a collision. There is a risk of an accident.

Always apply the brakes yourself and try to take evasive action.

WARNING

PRE-SAFE® Brake cannot always clearly identify objects and complex traffic conditions.

In these cases, PRE-SAFE® Brake may:

- give an unnecessary warning and then brake the vehicle
- not give a warning or intervene

There is a risk of an accident.

Always pay particular attention to the traffic situation and be ready to brake, especially if PRE-SAFE® Brake warns you. Terminate the intervention in a non-critical driving situation.

In order to maintain the appropriate distance to the vehicle in front and thus prevent a collision, you must apply the brakes yourself.

WARNING

PRE-SAFE® Brake does not react:

- to people or animals
- to oncoming vehicles
- to crossing traffic
- when cornering

As a result, PRE-SAFE® Brake may neither give warnings nor intervene in all critical situations. There is a risk of an accident.

Always pay careful attention to the traffic situation and be ready to brake.

In the event of snowfall or heavy rain, the recognition can be impaired.

Recognition by the radar sensor system is also impaired in the event of:

- there is dirt on the sensors or anything else covering the sensors
- there is interference by other radar sources
- there are strong radar reflections, for example in parking garages
- a narrow vehicle traveling in front, e.g. a motorbike
- a vehicle traveling in front on a different line relative to the center of your vehicle

Following damage to the front end of the vehicle, have the configuration and operation of the radar sensors checked at a qualified specialist workshop. This also applies to collisions at low speeds where there is no visible damage to the front of the vehicle.

Function

► **To activate/deactivate:** activate or deactivate PRE-SAFE® Brake in the on-board computer (> page 231).

When the PRE-SAFE® Brake is deactivated, the multifunction display in the assistance graphic shows the  symbol.

Starting at a speed of around 4 mph (7 km/h), this function warns you if you rapidly approach a vehicle in front. An intermittent warning tone will then sound and the 

distance warning lamp will light up in the instrument cluster.

- ▶ Brake immediately to defuse the situation.
- or
- ▶ Take evasive action provided it is safe to do so.

PRE-SAFE® Brake can also brake the vehicle automatically under the following conditions:

- the driver and front-passenger have their seat belts fastened and
- the vehicle speed is between approximately 4 mph (7 km/h) and 124 mph (200 km/h)

At speeds of up to approximately 40 mph (70 km/h) PRE-SAFE® Brake can also detect stationary objects. Examples of stationary objects are stopped or parked vehicles.

- i** If there is an increased risk of collision, preventive passenger protection measures (PRE-SAFE®) are activated.

If the risk of collision with the vehicle in front remains and you do not brake, take evasive action or accelerate significantly, the vehicle may perform automatic emergency braking, up to the point of full brake application. Automatic emergency braking is not performed until immediately prior to an imminent accident.

You can prevent the intervention of the PRE-SAFE® Brake at any time by:

- depressing the accelerator pedal further.
- activating kickdown.
- releasing the brake pedal.

The braking action of PRE-SAFE® Brake is ended automatically if:

- you maneuver to avoid the obstacle.
- there is no longer any danger of a collision.
- there is no longer an obstacle detected in front of your vehicle.

STEER CONTROL

General information

STEER CONTROL helps you by transmitting a noticeable steering force to the steering wheel in the direction required for vehicle stabilization.

This steering assistance is provided in particular if:

- both right wheels or both left wheels are on a wet or slippery road surface when you brake.
- the vehicle starts to skid.

Important safety notes

- i** Observe the "Important safety notes" section (▷ page 71).

No steering support is provided from STEER CONTROL, if:

- ESP® is malfunctioning.
- the lighting is faulty.

Power steering will, however, continue to function.

Protection against theft

Immobilizer

- ▶ **To activate with the SmartKey:** remove the SmartKey from the ignition lock.
- ▶ **To activate with KEYLESS-GO:** switch the ignition off and open the driver's door.
- ▶ **To deactivate:** switch on the ignition.

The immobilizer prevents your vehicle from being started without the correct SmartKey. When leaving the vehicle, always take the SmartKey with you and lock the vehicle. The engine can be started by anyone with a valid SmartKey that is left inside the vehicle.

- i** The immobilizer is always deactivated when you start the engine.

In the event that the engine cannot be started (yet the vehicle's battery is charged),

the system is not operational. Contact an authorized Mercedes-Benz Center or call 1-800-FOR-MERCEdes (in the USA) or 1-800-387-0100 (in Canada).

ATA (anti-theft alarm system)



- ▶ **To arm:** lock the vehicle with the SmartKey or KEYLESS-GO.

Indicator lamp ① flashes. The alarm system is armed after approximately 15 seconds.

- ▶ **To deactivate:** unlock the vehicle with the SmartKey or KEYLESS-GO.

A visual and audible alarm is triggered if the alarm system is armed and you open:

- a door
- the vehicle with the mechanical key
- the trunk lid
- the hood
- the glove box
- the stowage space under the armrest
- a stowage compartment in the rear

- ▶ **To turn the alarm off with the SmartKey:**

press the  or  button on the SmartKey.

The alarm is switched off.

or

- ▶ Insert the SmartKey into the ignition lock. The alarm is switched off.

- ▶ **To stop the alarm using KEYLESS-GO:** grasp the outside door handle. The SmartKey must be outside the vehicle. The alarm is switched off.

or

- ▶ Press the Start/Stop button on the dashboard. The SmartKey must be inside the vehicle. The alarm is switched off.

The alarm is not switched off, even if you close the open door that triggered it, for example.

- ▶ **i** If the alarm continues for more than 30 seconds, the mbrace emergency call system automatically notifies the Customer Assistance Center. This is done either by text message or data connection. The emergency call system sends the message or data provided that:

- you have subscribed to the mbrace service.
- the mbrace service has been activated properly.
- the necessary mobile phone network is available.

Useful information	82
SmartKey	82
Doors	88
Trunk	91
Side windows	96
Roof	100

Useful information

- i** This Operator's manual describes all models and all standard and optional equipment of your vehicle available at the time of publication of the Operator's manual. Country-specific differences are possible. Please note that your vehicle may not be equipped with all features described. This also applies to safety-related systems and functions.
- i** Read the information on qualified specialist workshops (▷ page 35).

SmartKey

Important safety notes

WARNING

If children are left unsupervised in the vehicle, they could:

- open the doors, thus endangering other people or road users.
- get out and disrupt traffic.
- operate the vehicle's equipment.

Additionally, children could set the vehicle in motion if, for example, they:

- release the parking brake.
- shifting the automatic transmission out of park position **P**
- Start the engine.

There is a risk of an accident and injury.

When leaving the vehicle, always take the SmartKey with you and lock the vehicle. Never leave children or animals unattended in the vehicle. Always keep the SmartKey out of reach of children.

WARNING

If you attach heavy or large objects to the SmartKey, the SmartKey could be unintentionally turned in the ignition lock. This could cause the engine to be switched off. There is a risk of an accident.

Do not attach any heavy or large objects to the SmartKey. Remove any bulky key rings before inserting the SmartKey into the ignition lock.



- !** Keep the SmartKey away from strong magnetic fields. Otherwise, the remote control function could be affected. Strong magnetic fields can occur in the vicinity of powerful electrical installations.

Do not keep the SmartKey:

- with electronic devices, e.g. a mobile phone or another SmartKey
- with metallic objects, e.g. coins or metal foil
- inside metallic objects, e.g. a metal case
This can affect the functionality of the SmartKey.

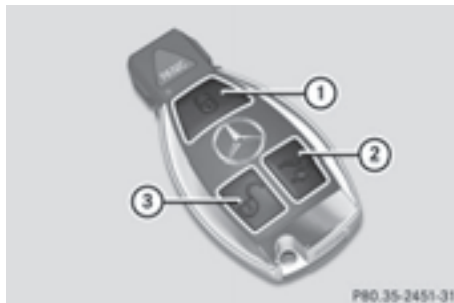
SmartKey functions



- ①  To lock the vehicle
- ②  To unlock the trunk lid
- ③  To unlock the vehicle

- ▶ **To unlock centrally:** press the  button.

If you do not open the vehicle within approximately 40 seconds of unlocking:

- the vehicle is locked again.
- the theft deterrent locking system is armed again.

- ▶ **To lock centrally:** press the  button.

The SmartKey centrally locks/unlocks:

- the doors
- the trunk lid
- the glove box
- the stowage compartment under the arm-rest
- the stowage compartment in the rear compartment
- the fuel filler flap

The turn signals flash once when unlocking and three times when locking.

You can also set an audible signal to confirm that the vehicle has been locked. The audible signal can be activated and deactivated using the on-board computer (▷ page 234).

When it is dark, the surround lighting also comes on if it is activated in the on-board computer (▷ page 233).

KEYLESS-GO

General notes

Bear in mind that the engine can be started by any of the vehicle occupants if there is a KEYLESS-GO key in the vehicle.

Locking/unlocking centrally

You can start, lock or unlock the vehicle using KEYLESS-GO. To do this, you only need carry the SmartKey with you. You can combine the functions of KEYLESS-GO with those of a conventional SmartKey. Unlock the vehicle by using KEYLESS-GO, for instance, and lock it using the  button on the SmartKey.

When locking or unlocking with KEYLESS-GO, the distance between the key and the corresponding door handle must not be greater than 3 ft (1 m).

A check which periodically establishes a radio connection between the vehicle and the SmartKey determines whether a valid SmartKey is in the vehicle. This occurs, for example:

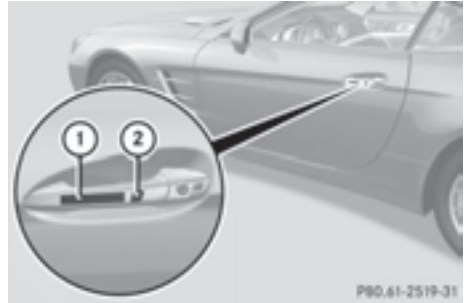

- when the external door handles are touched
- when starting the engine
- while the vehicle is in motion





- ▶ **To unlock the vehicle:** touch the inner surface of the door handle.
- ▶ **To lock the vehicle:** touch sensor surface ①.
- ▶ **Convenience closing feature:** touch recessed sensor surface ② for an extended period.
Further information on the convenience closing feature (▷ page 99).
- ▶ **To unlock the trunk lid:** pull the handle on the trunk lid.
The vehicle only unlocks the trunk lid.

Changing the settings of the locking system

You can change the settings of the locking system. This means only the driver's door, the lockable stowage compartments in the vehicle interior and the fuel filler flap are unlocked when the vehicle is unlocked. This is useful if you frequently travel on your own.



- ▶ **To change the setting:** press and hold down the  and  buttons simultaneously for approximately six seconds until

the battery check lamp flashes twice (▷ page 85).



i If the setting of the locking system is changed within the signal range of the vehicle, pressing the  or  button:

- locks or
- unlocks the vehicle

The SmartKey now functions as follows:

- ▶ **To unlock the driver's door:** press the  button once.
- ▶ **To unlock centrally:** press the  button twice.
- ▶ **To lock centrally:** press the  button.

The KEYLESS-GO function is changed as follows:

- ▶ **To unlock the driver's door:** touch the inner surface of the door handle on the driver's door.
- ▶ **To unlock centrally:** touch the inner surface of the front-passenger door handle.
- ▶ **To lock centrally:** touch the outer sensor surface on one of the door handles.
- ▶ **To restore the factory settings:** press and hold down the  and  buttons simultaneously for approximately six seconds until the battery check lamp flashes twice (▷ page 85).

Mechanical key

General notes

If the vehicle can no longer be locked or unlocked with the SmartKey, use the mechanical key.

If you use the mechanical key to unlock and open the driver's door or the trunk lid, the anti-theft alarm system will be triggered (▷ page 80).

There are several ways to turn off the alarm:

▶ **To turn the alarm off with the SmartKey:** press the  or  button on the SmartKey.

or

▶ Insert the SmartKey into the ignition lock.

or

▶ **To deactivate the alarm with KEYLESS-GO:** press the Start/Stop button in the ignition lock. The SmartKey must be in the vehicle.

or

▶ Lock or unlock the vehicle using KEYLESS-GO. The SmartKey must be outside the vehicle.

If you unlock the vehicle using the mechanical key, the fuel filler flap will not be unlocked automatically.

▶ **To unlock the fuel filler flap:** insert the SmartKey into the ignition lock.

Removing the mechanical key



▶ Push release catch ① in the direction of the arrow and at the same time remove mechanical key ② from the SmartKey.

For further information about:

- unlocking the driver's door (▷ page 90)
- unlocking the trunk (▷ page 95)
- locking the vehicle (▷ page 90)

Inserting the mechanical key

- ▶ Push mechanical key ② completely into the SmartKey until it engages and release catch ① is back in its basic position.

SmartKey battery

Important safety notes

WARNING

Batteries contain toxic and corrosive substances. If batteries are swallowed, it can result in severe health problems. There is a risk of fatal injury.



Keep batteries out of the reach of children. If a battery is swallowed, seek medical attention immediately.

Mercedes-Benz recommends that you have the batteries replaced at a qualified specialist workshop.



The SmartKey batteries contain perchlorate material, which may require special handling and regard for the environment. National guidelines must be observed during disposal. In California, see www.dtsc.ca.gov/HazardousWaste/Perchlorate/index.cfm.

Checking the battery



- ▶ Press the  or  button. The battery is working properly if battery check lamp ① lights up briefly.

The battery is discharged if battery check lamp ① does not light up briefly.

- ▶ Change the battery (▷ page 85).
- ❗ If the SmartKey battery is checked within the signal reception range of the vehicle, pressing the  or  button:
 - locks or
 - unlocks the vehicle
- ❗ You can get a battery at any qualified specialist workshop.

Replacing the battery

You require a CR 2025 3 V cell battery.



- ▶ Take the mechanical key out of the SmartKey (▷ page 84).

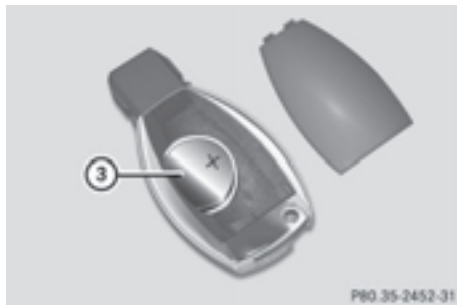

- ▶ Press mechanical key ② into the SmartKey opening in the direction of the arrow until battery compartment cover ① opens. Do not hold battery compartment cover ① closed while doing so.
- ▶ Remove battery compartment cover ①.



- ▶ Repeatedly tap the SmartKey against your palm until battery ③ falls out.
- ▶ Insert the new battery with the positive terminal facing upwards. Use a lint-free cloth to do so.
- ▶ Make sure that the surface of the battery is free of lint, grease and other contaminants.
- ▶ Insert the front tabs of battery compartment cover ① into the housing and then press to close it.
- ▶ Insert mechanical key ② into the SmartKey (▷ page 84).
- ▶ Check the function of all SmartKey buttons on the vehicle.

Problems with the SmartKey	
Problem	Possible causes/consequences and ► Solutions
You can no longer lock or unlock the vehicle using the SmartKey.	<p>The SmartKey battery is discharged or nearly discharged.</p> <ul style="list-style-type: none"> ► Check the SmartKey battery (▷ page 85) and replace it if necessary (▷ page 85). <p>If this does not work:</p> <ul style="list-style-type: none"> ► Unlock (▷ page 90) or lock (▷ page 90) the vehicle using the mechanical key.
	<p>The SmartKey is faulty.</p> <ul style="list-style-type: none"> ► Unlock (▷ page 90) or lock (▷ page 90) the vehicle using the mechanical key. ► Have the SmartKey checked at a qualified specialist workshop.
You can no longer lock or unlock the vehicle using KEYLESS-GO.	<p>There is interference from a powerful source of radio waves.</p> <ul style="list-style-type: none"> ► Lock/unlock the vehicle using the remote control function of the SmartKey. To do this, hold the SmartKey as close as possible to the vehicle and press the  or  button. <p>If the vehicle can also not be locked/unlocked using the remote control function:</p> <ul style="list-style-type: none"> ► Unlock (▷ page 90) or lock (▷ page 90) the vehicle using the mechanical key.
	<p>KEYLESS-GO is malfunctioning.</p> <ul style="list-style-type: none"> ► Lock/unlock the vehicle using the remote control function of the SmartKey. ► Have KEYLESS-GO checked at a qualified specialist workshop. <p>If the vehicle can also not be locked/unlocked using the remote control function:</p> <ul style="list-style-type: none"> ► Unlock (▷ page 90) or lock (▷ page 90) the vehicle using the mechanical key. ► Have KEYLESS-GO checked at a qualified specialist workshop.
	<ul style="list-style-type: none"> ► Have KEYLESS-GO checked at a qualified specialist workshop.
You have lost a SmartKey.	<ul style="list-style-type: none"> ► Have the SmartKey deactivated at a qualified specialist workshop. ► Report the loss immediately to the vehicle insurers. ► If necessary, have the locks changed as well.
You have lost the mechanical key.	<ul style="list-style-type: none"> ► Report the loss immediately to the vehicle insurers. ► If necessary, have the locks changed as well.

Problem	Possible causes/consequences and ► Solutions
The engine can no longer be started using the SmartKey.	<p>The on-board voltage is too low.</p> <ul style="list-style-type: none"> ► Switch off non-essential consumers, e.g. seat heating or interior lighting, and try to start the engine again. <p>If this does not work:</p> <ul style="list-style-type: none"> ► Check the starter battery and charge it if necessary (▷ page 555). <p>or</p> <ul style="list-style-type: none"> ► Jump-start the vehicle (▷ page 557). <p>or</p> <ul style="list-style-type: none"> ► Consult a qualified specialist workshop.
The engine can no longer be started using KEYLESS-GO. The SmartKey is in the vehicle.	<p>The vehicle is locked.</p> <ul style="list-style-type: none"> ► Unlock the vehicle and try to start the vehicle again. <p>There is interference from a powerful source of radio waves.</p> <ul style="list-style-type: none"> ► Start your vehicle with the SmartKey in the ignition lock.

Doors

Important safety notes

WARNING

If children are left unsupervised in the vehicle, they could:

- open the doors, thus endangering other people or road users.
- get out and disrupt traffic.
- operate the vehicle's equipment.

Additionally, children could set the vehicle in motion if, for example, they:

- release the parking brake.
- shifting the automatic transmission out of park position **P**
- Start the engine.

There is a risk of an accident and injury.

When leaving the vehicle, always take the SmartKey with you and lock the vehicle. Never leave children or animals unattended in the vehicle. Always keep the SmartKey out of reach of children.

Unlocking and opening doors from the inside

 The side windows will not open/close if the battery is discharged or if the side windows have iced up. It will then not be possible to close the door. Do not attempt to force the door closed. You could otherwise damage the door or the side window.

You can open a door from inside the vehicle even if it has been locked.

If the vehicle was previously locked with the SmartKey or with KEYLESS-GO, opening the vehicle from the inside will activate the anti-theft alarm system. Switch off the alarm (▷ page 80).

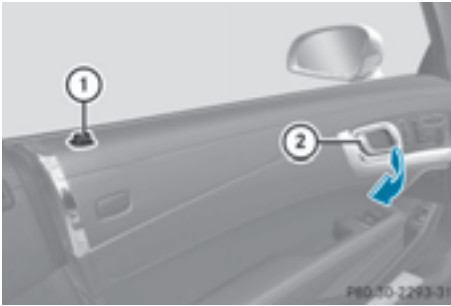

- ▶ Pull door handle ②.
If the door is locked, locking knob ① pops up. The door is unlocked and can be opened.

i When a door is opened, the side window on that side opens slightly. When the door is closed, the side window closes again.

Centrally locking and unlocking the vehicle from the inside

You can centrally lock or unlock the vehicle from the inside. For example, you can unlock the front-passenger door from the inside or lock the vehicle before you pull away.



- ▶ **To unlock:** press button ①.
- ▶ **To lock:** press button ②.
If the front-passenger door is closed, the vehicle locks.

The central locking/unlocking button does not lock or unlock the fuel filler flap or the stowage compartments, such as the glove box.

You cannot unlock the vehicle centrally from the inside if the vehicle has been locked with the SmartKey or KEYLESS-GO.

You can open a door from inside the vehicle even if it has been locked.

If a locked door is opened from the inside, the previous unlock status of the vehicle will be taken into consideration if:

- the vehicle was locked using the locking button for the central locking, or
- if the vehicle was locked automatically

The vehicle will be fully unlocked if it had previously been fully unlocked. If only the driver's door had been previously unlocked, only the door which has been opened from the inside is unlocked.

Automatic locking feature



- ① Disarming
- ② Arming

- ▶ **To disarm:** press and hold button ① for about five seconds until a tone sounds.
- ▶ **To arm:** press and hold button ② for about five seconds until a tone sounds.

i If you press one of the two buttons and do not hear a tone, the relevant setting has already been selected.

The vehicle is locked automatically when the ignition is switched on and the wheels are turning.

You could therefore lock yourself out if:

- the vehicle is being pushed.
- the vehicle is being towed.
- the vehicle is on a roller dynamometer.

You can also switch the automatic locking function on and off using the on-board computer (▷ page 234).

Power closing

Power closing pulls the doors and trunk lid into their locks automatically even if they are only partly closed.

- ▶ **Power closing feature (doors):** push the door past the first detent position into the lock.
Power closing will pull the door fully closed.
- ▶ **To power close the trunk lid:** lightly push the trunk lid closed.
The power closing function pulls the trunk lid closed.

Unlocking the driver's door (mechanical key)

If the vehicle can no longer be unlocked with the SmartKey, use the mechanical key.

If you use the mechanical key to unlock and open the driver's door, the anti-theft alarm system will be triggered (▷ page 80).

- ▶ Take the mechanical key out of the SmartKey (▷ page 84).
- ▶ Insert the mechanical key into the lock of the driver's door as far as it will go.



- ▶ Turn the mechanical key counter-clockwise as far as it will go to position **1**.
The door is unlocked.
- ▶ Turn the mechanical key back and remove it.
- ▶ Insert mechanical key into the SmartKey (▷ page 84).

Locking the vehicle (mechanical key)

If the vehicle can no longer be locked with the SmartKey, use the mechanical key.

- ▶ Open the driver's door.
- ▶ Close the front-passenger door and the trunk lid.
- ▶ Press the locking button (▷ page 89).
- ▶ Check whether the locking knob on the front-passenger door is still visible. Press the locking knob down by hand, if necessary.
- ▶ Close the driver's door.
- ▶ Take the mechanical key out of the SmartKey (▷ page 84).
- ▶ Insert the mechanical key into the lock of the driver's door as far as it will go.



1 To lock

- ▶ Turn the mechanical key clockwise as far as it will go to position **1**.
- ▶ Turn the mechanical key back and remove it.
- ▶ Make sure that the doors and the trunk lid are locked.
- ▶ Insert mechanical key into the SmartKey (> page 84).

i If you lock the vehicle as described above, the fuel filler flap is not locked. The anti-theft alarm system is not armed.

Trunk

Important safety notes

WARNING

If objects, luggage or loads are not secured or not secured sufficiently, they could slip, tip over or be flung around and thereby hit vehicle occupants. There is a risk of injury, particularly in the event of sudden braking or a sudden change in direction.

Always store objects so that they cannot be flung around. Secure objects, luggage or loads against slipping or tipping before the journey.

! The trunk lid swings upwards when opened. Therefore, make sure that there is sufficient clearance above the trunk lid.

! Only close the trunk once the roof is lowered completely. Otherwise, you could damage the roof.

If you close the trunk lid before the roof is lowered completely, the loading aid switch lights up and a warning tone sounds.

i Opening dimensions of the trunk lid (> page 607).

i With the roof open, you can use the loading aid (> page 514) to raise the folded roof in the trunk to make loading easier. For this purpose, you can also open the trunk partition.

The trunk partition must be closed again after loading. Otherwise, the roof can no longer be closed.

You can unlock the trunk lid if the vehicle is stationary and the roof is completely open or closed.

Do not leave the SmartKey in the trunk. You could otherwise lock yourself out.

The trunk lid can be:

- opened/closed from outside
- opened and closed automatically from outside (vehicles with trunk lid remote closing feature)
- opened and closed automatically from inside (vehicles with trunk lid remote closing feature)
- opened, closed or stopped during operation without the use of your hands (vehicles with KEYLESS-GO and HANDS-FREE ACCESS)
- locked separately
- unlocked with the mechanical key
- opened with the emergency release button

Trunk lid reversing feature

The trunk lid is equipped with an automatic reversing feature. It reacts if a solid object obstructs or restricts the trunk lid during the closing procedure. The trunk lid opens again automatically. The automatic reversing func-

tion is only an aid and is not a substitute for your attentiveness to the trunk lid while it is closing.

WARNING

The reversing feature does not react:

- to soft, light and thin objects, e.g. small fingers
- over the last 1/3 in(8 mm) of the closing movement

This means that the reversing feature cannot prevent someone being trapped in these situations. There is a risk of injury.

Make sure that no body parts are in close proximity during the closing procedure.

If somebody becomes trapped:

- press the  button on the SmartKey, or
- press the remote operating switch on the driver's door, or
- press the closing or locking button on the trunk lid, or
- pull on the trunk lid handle

Opening/closing from outside

Opening



- ▶ Press the  button on the SmartKey.
- ▶ Pull handle ①.
- ▶ Raise the trunk lid.

i When the soft top is open, you can use the loading aid (▶ page 514) to raise the folded soft top when loading it into the trunk. For

this purpose, you can also open the trunk partition.

The trunk partition must be closed again after loading. It will otherwise not be possible to close the roof.

Closing



- ▶ Pull the trunk lid down using recess ①.
- ▶ Lock the vehicle if necessary with the  button on the SmartKey or with KEYLESS-GO.

i If a KEYLESS-GO key is detected in the trunk, the trunk lid cannot be locked and will open again.

Opening/closing automatically from outside

Important safety notes

WARNING

Parts of the body could become trapped during automatic closing of the tailgate. Moreover, people, e.g. children, may be standing in the closing area or may enter the closing area during the closing process. There is a risk of injury.

Make sure that nobody is in the vicinity of the closing area during the closing process.

Use one of the following options to stop the closing process:

- press the  button on the SmartKey.
- press the remote operating switch on the driver's door.
- press the closing or locking button on the tailgate.
- pull the handle on the tailgate.

! The trunk lid swings upwards when opened. Therefore, make sure that there is sufficient clearance above the trunk lid.

i Opening dimensions of the trunk lid (> page 607).

Opening

You can open the trunk lid automatically using the handle in the trunk lid.

► If the trunk lid is unlocked, pull the trunk lid handle and let it go again immediately.

Vehicles with the trunk lid remote closing feature: the trunk lid can be also be opened automatically using the SmartKey.

► Press and hold the  button on the SmartKey until the trunk lid opens.

Closing

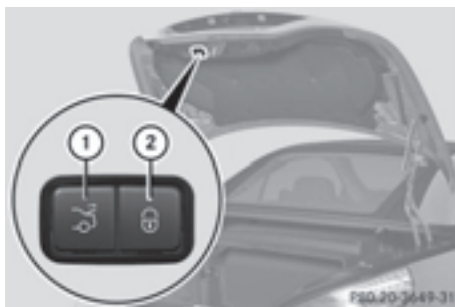

① Closing button

② Locking button

► **To close:** press closing button ① in the trunk lid.

Vehicles with trunk lid remote closing feature and KEYLESS-GO: you can simultaneously close the trunk lid and lock the vehicle.

► Press locking button ② in the trunk lid. If a KEYLESS-GO key is detected outside the vehicle, the trunk lid closes and the vehicle locks.

i If a SmartKey with KEYLESS-GO is detected in the trunk, the trunk lid opens again after it is closed. It does not lock.

HANDS-FREE ACCESS

Important safety notes

WARNING

The vehicle's exhaust system may be very hot. You could burn yourself by touching the exhaust system if you use HANDS-FREE ACCESS. There is a risk of injury. Always ensure that you only make the kicking movement within the detection range of sensors.

! If the SmartKey is within the rear detection range of KEYLESS-GO, the following situations, for example, could lead to the unintentional opening of the trunk:

- using a car wash
- using a power washer

Make sure that the SmartKey is at least 10 ft (3 m) away from the vehicle.

General notes

With KEYLESS-GO and HANDS-FREE ACCESS, you can open or close the trunk lid or stop the procedure without using your hands. This is useful if you have your hands full. To do this, make a kicking movement under the bumper with your foot.

Observe the following points:

- Carry your KEYLESS-GO key about your person. The KEYLESS-GO key must be in the rear detection range of the vehicle.
- When making the kicking movement, make sure that you are standing firmly on the

ground and that there is sufficient clearance to the rear of the vehicle. You could otherwise lose your balance e.g. on ice.



- Always ensure that you only make the kicking movement within the detection range of sensors ①.
- Stand at least 12 in (30 cm) away from the rear area while doing so.
- Do not come into contact with the bumper while making the kicking movement. Otherwise, the sensors may not function correctly.
- HANDS-FREE ACCESS does not function when the engine is started.
- If a KEYLESS-GO key is within the rear detection range of KEYLESS-GO, HANDS-FREE ACCESS could be triggered. The trunk lid could thus be opened or closed unintentionally, for example, if you:
 - set something down or lift something up behind the vehicle.
 - polish the rear of the vehicle.

Do not carry the KEYLESS-GO key about your person in these situations or in situations similar to these. This will prevent the unintentional opening/closing of the trunk.

- Dirt caused by road salt around sensors ① may restrict functionality.
- Using the HANDS-FREE ACCESS with a prosthetic leg may restrict functionality.

Operation



- ▶ **To open/close:** move your foot in sensor detection range ① using your leg. You will hear a warning tone while the trunk lid is opening or closing.
- ▶ **If the trunk lid does not open after several attempts:** wait at least ten seconds then move your leg under the bumper once again.
- ❗ If you hold your foot under the bumper for too long, the trunk lid does not open or close. Repeat the leg movement more quickly if this occurs.

To stop the opening or closing procedure:

- move your foot in sensor detection range ① under the bumper, or
- pull the handle on the outside of the trunk lid or
- press the closing button in the trunk lid or
- press the  button on the SmartKey

If the trunk lid closing procedure has been stopped:

- move your foot under the bumper again and the trunk lid will open.

If the trunk lid opening procedure has been stopped:

- move your foot under the bumper again and the trunk lid will close.

Opening/closing automatically from inside

Important safety notes

WARNING

Parts of the body could become trapped during automatic closing of the tailgate. In addition, people may be standing in the closing area or may enter the closing area, e.g. children, during the closing procedure. There is a risk of injury.

Make sure that nobody is in the vicinity of the closing area during the closing process.

Release the remote operating switch immediately if somebody becomes trapped. To re-open the tailgate pull on the remote operating switch.

WARNING

The trunk lid can be automatically opened or closed even if the SmartKey is not in the vehicle. If children are left unsupervised in the vehicle, they could activate the functions. There is a risk of injury.

When leaving the vehicle, always take the SmartKey with you and lock the vehicle. Never leave children unsupervised in the vehicle.

! The trunk lid swings upwards when opened. Therefore, make sure that there is sufficient clearance above the trunk lid.

i Opening dimensions of the trunk lid (▷ page 607).

Opening and closing



- ▶ **To open:** pull remote operating switch for trunk lid **1** until the trunk lid opens.
- ▶ **To close:** press remote operating switch for trunk lid **1** until the trunk lid is closed.

You can open and close the trunk lid from the driver's seat when the vehicle is stationary and unlocked.

Locking the trunk separately

You can lock the trunk separately. If you then unlock the vehicle centrally, the trunk remains locked and cannot be opened.

- ▶ Close the trunk lid.
- ▶ Take the mechanical key out of the SmartKey (▷ page 84).



- 1** Basic position
- 2** To lock

- ▶ Insert the mechanical key into the trunk lid lock as far as it will go.
- ▶ Turn the mechanical key clockwise from position **1** to position **2**.
- ▶ Remove the mechanical key.
- ▶ Insert mechanical key into the SmartKey (▷ page 84).

Unlocking the trunk (mechanical key)

! The trunk lid swings upwards when opened. Therefore, make sure that there is sufficient clearance above the trunk lid.

If the trunk cannot be unlocked with the SmartKey or KEYLESS-GO, use the mechanical key.

If you use the mechanical key to unlock and open the trunk lid, the anti-theft alarm system will be triggered (▷ page 80).

- ▶ Take the mechanical key out of the SmartKey (▷ page 84).
- ▶ Insert the mechanical key into the trunk lid lock as far as it will go.



- 1 Basic position
- 2 To unlock

- ▶ Turn the mechanical key counter-clockwise as far as it will go from position 1 to position 2.
- ▶ Pull the trunk lid handle. The trunk is unlocked.
- ▶ Turn the mechanical key back to position 1 and remove it.
- ▶ Insert mechanical key into the SmartKey (▷ page 84).

i When you lock the vehicle (▷ page 90), the trunk is also locked.

Trunk emergency release

You can unlock the trunk lid from the inside with the emergency release button.



- ▶ Press emergency release button 1 briefly. The trunk lid unlocks and opens slightly.
- ▶ Push the trunk lid upwards to open it completely.

The trunk lid can be unlocked with the trunk lid emergency release when the vehicle is stationary or while driving.

The trunk lid emergency release does not unlock the trunk lid if the battery is disconnected or discharged.

Trunk lid emergency release light:

- emergency release button 1 flashes for 30 minutes after the trunk lid is opened
- emergency release button 1 flashes for 60 minutes after the trunk lid is closed

Side windows

Important safety notes

⚠ WARNING

While opening the side windows, body parts could become trapped between the side window and the door frame as the side window moves. There is a risk of injury.

Make sure that nobody touches the side window during the opening procedure. If somebody becomes trapped, release the switch or pull the switch to close the side window again.

⚠ WARNING

While closing the side windows, body parts in the closing area could become trapped. There is a risk of injury.

When closing make sure that no parts of the body are in the closing area. If somebody becomes trapped, release the switch or press the switch to open the side window again.

WARNING

If children operate the side windows they could become trapped, particularly if they are left unsupervised. There is a risk of injury.

When leaving the vehicle, always take the SmartKey with you and lock the vehicle. Never leave children unsupervised in the vehicle.

Side window reversing feature

The front side windows are equipped with an automatic reversing feature. If a solid object blocks or restricts one of the front side windows from traveling upwards during the automatic closing process, the side window opens again automatically. During the manual closing process, the side window only opens again automatically after the corresponding switch is released. However, the automatic reversing feature is only an aid and does not relieve you of the responsibility of paying attention when closing a side window.

WARNING

The reversing feature does not react:

- to soft, light and thin objects, e.g. small fingers
- while resetting

This means that the reversing feature cannot prevent someone being trapped in these situations. There is a risk of injury.

Make sure that no body parts are in close proximity during the closing procedure. If someone becomes trapped, press the switch to open the side window again.

Opening and closing the side windows

Opening and closing the side windows in the front

The switches for the side windows are located on the driver's door. There is also a switch for the front-passenger side window on the front-passenger door.

The switches on the driver's door take precedence.



- ① Left
- ② Right

- ▶ Turn the SmartKey to position **1** or **2** in the ignition lock.
- ▶ **To open manually:** press and hold the corresponding button.
- ▶ **To open fully:** press the button beyond the point of resistance and release it. Automatic operation is started.
- ▶ **To close manually:** pull the corresponding button and hold it.
- ▶ **To close fully:** pull the button beyond the point of resistance and release it. Automatic operation is started.
- ▶ **To interrupt automatic operation:** press or pull the corresponding button again.

- i** You can continue to operate the side windows after you switch off the engine. This function is available for up to five minutes or until the driver's or front-passenger door is opened.

Opening/closing the rear side windows

- ▶ **To open:** open the front side window on the corresponding side (▷ page 97).
- ▶ Press the corresponding switch again and release.
The corresponding rear side window opens fully.
- ▶ **To stop the rear side windows:** briefly pull the corresponding switch up and release.
- ▶ **To close:** close the front side window on the corresponding side (▷ page 97).
- ▶ Pull the respective switch and hold it.
The corresponding rear side window will continue to close until you release the switch.

Opening and closing all side windows

Using the switch on the center console

You can use the switch on the center console to close all side windows simultaneously.

- ▶ Open the cover in the lower center console.
The switch for all side windows is under the cover.



- ▶ **To open all side windows:** press switch ① to the point of resistance.
- ▶ **To open all side windows fully:** press switch ① beyond the point of resistance.
All side windows open simultaneously.

- ① If, after opening the windows, you close one side window using the switch in the door control panel:
 - the front side window closes first and
 - then the corresponding rear side window closes.
- ▶ **To close all side windows:** pull switch ①.
All side windows begin the closing procedure simultaneously. The rear side windows close after the front side windows.
- ▶ Make sure that all the side windows are fully closed.



Using the SmartKey

⚠ WARNING



When using the convenience closing feature, parts of the body could be trapped in the closing area when a side window is being closed. There is a risk of injury.



Observe the complete closing procedure when the convenience closing feature is operating. Make sure that no body parts are in close proximity during the closing procedure.

If someone is trapped:

- ▶ Release the  button immediately.
- ▶ Press and hold the  button until the side windows open again.

You can use the SmartKey to open or close all side windows simultaneously.

- ▶ Close the roof (▷ page 101).
- ▶ Open the trunk partition (▷ page 102).
- ▶ **Vehicles without KEYLESS-GO:** point the tip of the SmartKey at the door handle on the driver's door.
- ▶ **Vehicles with KEYLESS-GO:** the SmartKey must be within 6 ft (2 m) of the vehicle.
- ▶ **To open all side windows:** press the  button on the SmartKey until the side windows are fully opened.
- ▶ **To interrupt the opening procedure:** release the  button.

- ▶ **To close all side windows:** press the  button on the SmartKey until the side windows are fully closed.
- ▶ **To interrupt the closing procedure:** release the  button.

Convenience closing with KEYLESS-GO

WARNING

When using the convenience closing feature, parts of the body could be trapped in the closing area when a side window is being closed. There is a risk of injury.

Observe the complete closing procedure when the convenience closing feature is operating. Make sure that no body parts are in close proximity during the closing procedure.

If someone is trapped:

- ▶ Release the recessed sensor surface on the door handle immediately.
- ▶ Pull the door handle immediately and hold it until the side windows open again.

With KEYLESS-GO you can close all side windows simultaneously. The KEYLESS-GO key must be outside the vehicle. All the doors must be closed.

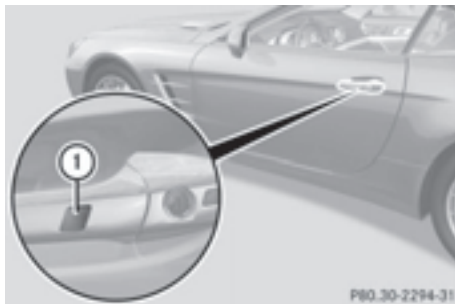

- ▶ Touch recessed sensor surface ① on the door handle until the side windows are fully closed.
- i** Make sure you only touch recessed sensor surface ①.

- ▶ Make sure that all the side windows are closed.
- ▶ **To interrupt convenience closing:** release recessed sensor surface ① on the door handle.

Resetting the side windows

If a side window can no longer be closed fully, you must reset it.

- ▶ Close all the doors.
- ▶ Turn the SmartKey to position **1** or **2** in the ignition lock.
- ▶ Pull the corresponding switch on the door control panel until the side window is completely closed. (▷ page 97)
- ▶ Hold the switch for an additional second.

If the side window opens again slightly:

- ▶ Immediately pull the corresponding switch on the door control panel until the side window is completely closed (▷ page 97).
- ▶ Hold the switch for an additional second.
- ▶ If the corresponding side window remains closed after the button has been released, the side window has been reset correctly. If this is not the case, repeat the steps above again.

Problems with the side windows

WARNING

If you close a side window again immediately after it has been blocked or reset, the side window closes with increased or maximum force. The reversing feature is then not active. Parts of the body could be trapped in the closing area in the process. This poses an increased risk of injury or even fatal injury.

Make sure that no parts of the body are in the closing area. To stop the closing process, release the switch or push the switch again to reopen the side window.

Problem	Possible causes/consequences and ► Solutions
A side window cannot be closed because it is blocked by objects, e.g. leaves in the window guide.	<ul style="list-style-type: none"> ► Remove the objects. ► Close the side window.
A side window cannot be closed and you cannot see the cause.	<p>If a side window is obstructed during closing and reopens again slightly:</p> <ul style="list-style-type: none"> ► Immediately after the window blocks, pull the corresponding switch again until the side window has closed. The side window is closed with increased force. <p>If a side window is obstructed again during closing and reopens again slightly:</p> <ul style="list-style-type: none"> ► Immediately after the window blocks, pull the corresponding switch again until the side window has closed. The side window is closed without the anti-entrapment feature.

Roof

Important safety notes

WARNING



If you do not fully open/close the soft top, the soft-top hydraulics depressurize after a short time. This causes the soft top to lower unexpectedly and may cause you or others to be trapped. There is a risk of injury.

Always open or close the soft top completely.

WARNING

Closing the roof manually is a complicated and technically demanding procedure, which requires a lot of strength. You or others can become trapped. There is a risk of injury.

Only have the soft top closed manually at a qualified specialist workshop.

-  Never sit on the rear compartment trim or stow heavy objects there. You will otherwise damage the roof and rear compartment trim of the vehicle.
-  Do not forget that the weather can change abruptly. Make certain that the roof is closed when you leave the vehicle. The vehicle electronics can be damaged if water enters the vehicle interior.
-  When opening and closing the roof, make sure that:

- there is sufficient clearance, as the roof swings upwards.
- there is sufficient clearance behind the vehicle, as the trunk lid swings backwards beyond the bumper.
- the trunk is only loaded to below the trunk partition.
- the trunk partition is not pushed up by the load.
- the trunk partition is closed.
- the trunk lid is closed.
- the outside temperature is above 5 °F (-15 °C).

You could otherwise damage the roof, trunk and other parts of the vehicle.

- i** Vehicle dimensions when opening/closing the roof (▷ page 607).
- i** Make sure that the roof and rear window are clean and dry before opening the roof. Otherwise, water or dirt could enter the vehicle interior or trunk.

Opening and closing using the roof switch

Important safety notes

WARNING

When opening or closing the roof, body parts could be trapped by, for example, the roof mechanism, trunk lid or side windows. There is a risk of injury.

When raising or lowering the roof, make sure that no body parts are in the vicinity of moving components. If someone becomes trapped, release the button.

Opening and closing



- ▶ Secure the vehicle against rolling away (▷ page 171).
- ▶ Close the trunk partition (▷ page 103).
- ▶ Close the trunk lid.
- ▶ Turn the SmartKey to position **2** in the ignition lock.
- ▶ Open the cover in the lower center console. Roof switch **1** is located under the cover.
- ▶ **To open:** pull roof switch **1** until the entire roof is stowed away in the trunk. The **Vario-Roof in Operation** message appears in the multifunction display. Once the opening procedure is complete, the message disappears and a tone will sound. All of the side windows open.
- ▶ **To close:** press and hold roof switch **1** until the roof is fully closed. The **Vario-Roof in Operation** message appears in the multifunction display. Once the opening procedure is complete, the message disappears and a tone will sound. All of the side windows open.
- ▶ To close all side windows, pull the switch under the cover of the center console (▷ page 98).

Opening and closing using the SmartKey





Important safety notes

WARNING

When opening or closing the roof, body parts could be trapped by, for example, the roof mechanism, trunk lid or side windows. There is a risk of injury.

When raising or lowering the roof, make sure that no body parts are in the vicinity of moving components. If someone becomes trapped, release the button.

Opening and closing

- ▶ Close the trunk partition (▷ page 102).
- ▶ Close the trunk lid (▷ page 91).
- ▶ **Vehicles without KEYLESS-GO:** point the tip of the SmartKey at the door handle on the driver's door.
- ▶ **Vehicles with KEYLESS-GO:** the SmartKey must be within 6 ft (2 m) of the vehicle.
- ▶ **To open:** press and hold the  button on the SmartKey until the roof is fully opened.
The roof and the rear side windows open. The front side windows close.
- ▶ **To interrupt the opening procedure:** release the  button.
- ▶ **To open the front side windows:** press and hold the  button on the SmartKey again.
- ▶ **To close:** press and hold the  button on the SmartKey until the roof is fully closed.
The roof and the side windows close.
- ▶ **To interrupt the closing procedure:** release the  button.
- ▶ **i** When the roof is closed and the trunk partition is open, the roof cannot be opened using the SmartKey functions. Instead, all of the side windows open or close simultaneously (▷ page 98).

Locking the roof again



Important safety notes

WARNING

If you do not fully open/close the soft top, the soft-top hydraulics depressurize after a short time. This causes the soft top to lower unexpectedly and may cause you or others to be trapped. There is a risk of injury.

Always open or close the soft top completely.

The roof is not locked if:

- the  symbol and the **Vario-Roof in Operation** message appear in the multi-function display.
- the  symbol and the **Open/Close Vario-Roof Completely** message appear and you hear a warning tone.
- you hear a warning tone for up to 10 seconds when pulling away or while driving.

Locking

You can lock the roof again if it is not locked fully.

- ▶ Pull over and stop the vehicle safely as soon as possible, paying attention to road and traffic conditions.
- ▶ Make sure that the SmartKey is in position **2** in the ignition lock.
- ▶ Press the roof switch (▷ page 101).

Trunk partition

General notes

- ▶ **i** To avoid damaging the roof or luggage when folding back the roof, you should:
 - only load the trunk to below the trunk partition
 - not place any objects on or in front of the trunk partition

- not place any objects on the cover behind the roll bars
- not allow the cargo to push the trunk partition upwards

! Make sure the trunk separator is completely closed. Otherwise, the roof can be blocked when it is opened or closed.

The trunk partition can be used to cover luggage and loads in the trunk.

Opening and closing

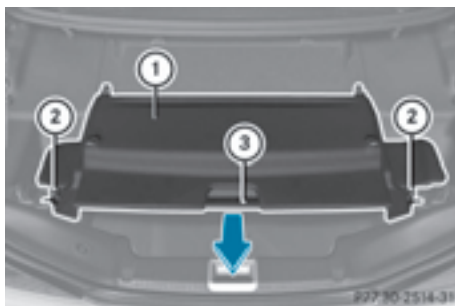

Closed trunk partition

- ① Trunk partition
- ② Eyelets
- ③ Handle

- ▶ **To close:** pull trunk partition ① in the direction of the arrow by handle ③.
- ▶ Hook trunk partition ① into fastening eyelets ② in the side panels.
- ▶ **To open:** remove trunk partition ① from fastening eyelets ② in the side panels.
- ▶ Push trunk partition ① against the direction of the arrow by handle ③.

Removing and installing

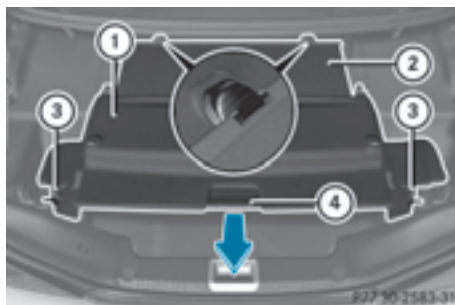

Closed trunk partition

- ① Trunk partition
- ② Net
- ③ Eyelets
- ④ Handle

- ▶ **To remove:** unhook net ② from the holder on the left and right-hand sides and guide it to the rear until it is completely rolled up.
- ▶ Remove trunk partition ① from fastening eyelets ③ in the side panels.
- ▶ Push trunk partition ① against the direction of the arrow by handle ④.



Opened trunk partition

- ① Trunk partition
- ⑤ Catch lever (example: driver's side)

- ▶ Turn driver's side catch lever ⑤ in the direction of the arrow.
- ▶ Repeat the same process on the catch lever on the passenger side. Trunk partition ① is unlocked.
- ▶ Pull out trunk partition ① in the direction of the arrow.

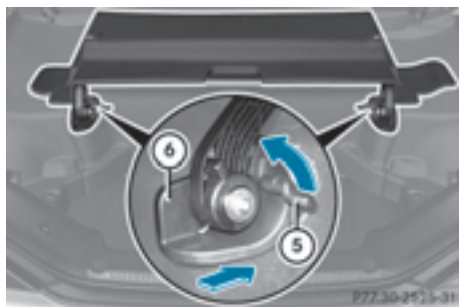

⑤ Catch lever (example: driver's side)

⑥ Guide

► **To install:** insert guides ⑥ of trunk partition ① into the brackets.

► Slide in trunk partition ① as far as it will go.

► Turn driver's side catch lever ⑤ in the direction of the arrow.

► Repeat the same process on the catch lever on the passenger side.
Trunk partition ① is unlocked.

► Pull trunk partition ① by handle ④ in the direction of the arrow.

► Hook trunk partition ① into fastening eyelets ③ in the side panels.

► Pull net ② forwards and hook the left and right-hand sides into the holder.

Wind screen

Wind screen

Important safety notes

WARNING

If you use the wind screen in darkness or in other conditions offering poor visibility, your view to the rear is further impaired. There is a risk of an accident.

Only use the wind screen when visibility conditions are good.

! When extending or retracting the wind screen, make sure there are no objects on the rear compartment trim. Otherwise, the objects could damage the wind screen.

The wind screen offers protection from the wind when driving with the roof down. The roof must be fully open before the wind screen can be extended.

Extending and retracting

► Open the roof (▷ page 100).

► Open the cover in the lower center console. The switch for the electrical wind screen is under the cover.

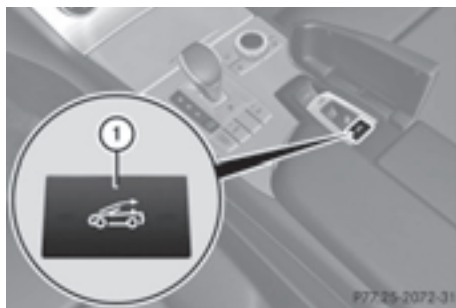

► **To extend:** press button ①.

► **To retract:** press button ① again.

Roller sunblind for the glass roof



The roller sunblind protects you from excessive glare and heat caused by the sun shining through the glass roof.

► **To close:** using handle ① slide the roller blind in the direction of the arrow.

► **To open:** using handle ① slide the roller blind in the opposite direction to the arrow.

MAGIC SKY CONTROL

General notes

MAGIC SKY CONTROL is a glass roof, the transparency of which can be changed by applying electrical voltage.

MAGIC SKY CONTROL can be switched between darkened and transparent states.

- i** MAGIC SKY CONTROL darkens automatically when you turn the SmartKey to position **0** in the ignition lock or remove the SmartKey.

Risk of electric shock

DANGER

MAGIC SKY CONTROL operates using high voltage. If the trim behind the overhead control panel is damaged or removed, electrical components will be exposed. If you touch these components, you could get an electric shock. There is a risk of fatal injury.

- Never remove the trim behind the overhead control panel.
- If the trim is damaged, never touch the electrical components behind it.
- Always have work on the MAGIC SKY CONTROL carried out at a qualified specialist workshop.

The electrical components of MAGIC SKY CONTROL are protected by a paneling behind the overhead control panel.

The MAGIC SKY CONTROL control unit is marked with a yellow warning sticker that warns you of high voltage. The electric cables of the high-voltage section are colored orange.

Operating MAGIC SKY CONTROL



- ▶ Turn the SmartKey to position **1** or **2** in the ignition lock. MAGIC SKY CONTROL switches to the status it was set to before the engine was switched off.
- ▶ **To change the degree of transparency:** press button **①**.
- i** At sub-zero temperatures, the change is slower and uneven. The entire process may take some time.

Problems with the roof

Problem	Possible causes/consequences and ► Solutions
The roof will not open or close.	<p>The trunk partition is not in place.</p> <p>► Close the trunk partition (▷ page 103).</p>
	<p>The trunk lid is open.</p> <p>► Close the trunk lid (▷ page 92).</p>
	<p>The on-board voltage is too low.</p> <p>► Leave the engine running.</p>
	<p>The roof has been opened and closed several times in a row. The roof drive has been automatically deactivated.</p> <p>You can open and close the roof again after approximately ten minutes.</p> <p>► Switch off the ignition and turn it back on.</p> <p>► Repeat the opening or closing procedure.</p>
	<p>The automatic roof mechanism is faulty.</p> <p>► Consult a qualified specialist workshop.</p>

Useful information	108
Correct driver's seat position	108
Seats	109
Steering wheel	114
Mirrors	116
Memory function	119

Useful information

i This Operator's manual describes all models and all standard and optional equipment of your vehicle available at the time of publication of the Operator's manual. Country-specific differences are possible. Please note that your vehicle may not be equipped with all features described. This also applies to safety-related systems and functions.

i Read the information on qualified specialist workshops (▷ page 35).

Correct driver's seat position



- ▶ Observe the safety guidelines on seat adjustment (▷ page 109).
- ▶ Make sure that seat ③ is adjusted properly.

Electrical seat adjustment (▷ page 110)

When adjusting the seat, make sure that:

- you are as far away from the driver's air bag as possible
- you are sitting in a normal upright position
- you can fasten the seat belt properly
- you have moved the backrest to an almost vertical position

- you have set the seat cushion angle so that your thighs are gently supported
- you can depress the pedals properly

- ▶ Check whether the head restraint is adjusted properly.

When doing so, make sure that you have adjusted the head restraint so that the back of your head is supported at eye level by the center of the head restraint.

- ▶ Observe the safety guidelines on steering wheel adjustment (▷ page 114).
- ▶ Make sure that steering wheel ① is adjusted properly.

Adjusts the steering wheel electrically (▷ page 114)

When adjusting the steering wheel, make sure that:

- you can hold the steering wheel with your arms slightly bent
- you can move your legs freely
- you can see all the displays in the instrument cluster clearly
- ▶ Observe the safety guidelines for seat belts (▷ page 52).
- ▶ Check whether you have fastened seat belt ② properly (▷ page 54).

The seat belt should:

- fit snugly across your body
- be routed across the middle of your shoulder
- be routed in your pelvic area across the hip joints
- ▶ Before starting off, adjust the rear-view mirror and the exterior mirrors (▷ page 116) in such a way that you have a good view of road and traffic conditions.
- ▶ Store the seat, steering wheel and exterior mirror settings using the memory function (▷ page 119).

Seats

Important safety notes

WARNING

Children could become trapped if they adjust the seats, particularly when unattended.

There is a risk of injury.

When leaving the vehicle, always take the SmartKey with you and lock the vehicle. Never leave children unsupervised in the vehicle.

The seats can still be adjusted when there is no SmartKey in the ignition lock.

WARNING

When you adjust a seat, you or other vehicle occupants could become trapped, e.g. on the seat guide rail. There is a risk of injury.

Make sure when adjusting a seat that no one has any body parts in the sweep of the seat.

Observe the safety notes on "Air bags" (▷ page 56) and "Children in the Vehicle" (▷ page 68).

WARNING

If you adjust the seat height carelessly, you or other vehicle occupants could be trapped and thereby injured. Children in particular could accidentally press the electrical seat adjustment buttons and become trapped. There is a risk of injury.

While moving the seats, make sure that your hands or other body parts do not get under the lever assembly of the seat adjustment system.

WARNING

If head restraints are not installed and adjusted correctly, they cannot provide protection as intended. There is an increased risk of injury in the head and neck area, e.g. in the event of an accident or when braking.

Always drive with the head restraints installed. Before driving off, make sure for every vehicle occupant that the center of the head

restraint supports the back of the head at about eye level.

WARNING

You could lose control of your vehicle if you do the following while driving:

- adjust the driver's seat, steering wheel or mirrors
- fasten the seat belt

There is a risk of an accident.

Adjust the driver's seat, steering wheel or mirrors and fasten your seat belt before starting the engine.

 To avoid damage to the seats and the seat heating, observe the following information:

- keep liquids from spilling on the seats. If liquid is spilled on the seats, dry them as soon as possible.
- if the seat covers are damp or wet, do not switch on the seat heating. The seat heating should also not be used to dry the seats.
- clean the seat covers as recommended; see the "Interior care" section.
- do not transport heavy loads on the seats. Do not place sharp objects on the seat cushions, e.g. knives, nails or tools. The seats should only be occupied by passengers, if possible.
- when the seat heating is in operation, do not cover the seats with insulating materials, e.g. blankets, coats, bags, seat covers, child seats or booster seats.

 To avoid damage to the seats and the seat heating, observe the following information:

- keep liquids from spilling on the seats. If liquid is spilled on the seats, dry them as soon as possible.
- if the seat covers are damp or wet, do not switch on the seat heating. The seat heating should also not be used to dry the seats.

- clean the seat covers as recommended; see "Interior care".
- do not transport heavy loads on the seats. Do not place sharp objects on the seat cushions, e.g. knives, nails or tools. The seats should only be occupied by passengers, if possible.
- when the seat heating is in operation, do not cover the seats with insulating materials, e.g. blankets, coats, bags, seat covers, child seats or booster seats.

! Make sure that there are no objects in the footwell under or behind the seats when moving the seats back. There is a risk that the seats and/or the objects could be damaged.

i The head restraints cannot be removed. For more information, contact a qualified specialist workshop.

Adjusting the seats electrically

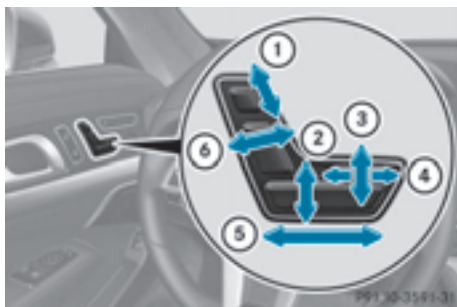

- ① Head restraint height
- ② Seat height
- ③ Seat cushion angle
- ④ Seat cushion length
- ⑤ Seat fore-and-aft adjustment
- ⑥ Backrest angle

i Further related subjects:

- You can store the seat settings using the memory function (▷ page 119).
- If PRE-SAFE® is triggered, the front-passenger seat will be moved to a better

position if it was previously in an unfavorable position (▷ page 67).

Adjusting the front-passenger seat from the driver's seat

⚠ WARNING

The front-air bags for could also injure the vehicle occupants in the front. If the front seats are positioned too close to the dashboard or steering wheel. This poses an increased risk of injury or even fatal injury. Always adjust the front seats so that they are as far from the front air bags as possible. Also observe the notes on the correct adjustment of the seats.

! Do not move the front-passenger seat fully forwards if there are objects in the parcel net in the front-passenger footwell. The objects could otherwise be damaged.



You can use the seat switches on the driver's side to adjust the front-passenger seat.

► **To activate/deactivate:** press button ①.

If the indicator lamp in button ① is lit, you can access the following functions for the front-passenger seat:

- seat adjustment
- call up the memory function

Removing the seat belt from the belt guide

⚠ WARNING

When driving off-road, your body is subject to forces from all directions, due to the uneven surface. You could be thrown from your seat, for instance. There is a risk of injury.

Always wear a seat belt, even when driving off-road.

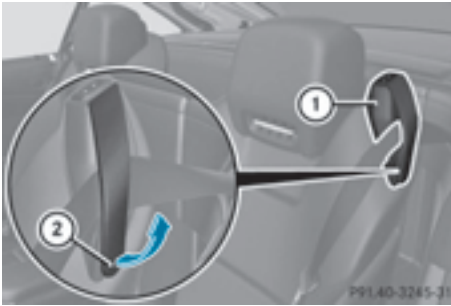

Both the driver's seat belt and the front-passenger seat belt can be removed from the seat belt guide. This makes it easier to move the seats forward.

Before you drive off, the seat belt must be inserted into the seat belt guide.

Observe the safety guidelines for seat belts (▷ page 52).

- ▶ **To remove:** open up magnetic head ② and fold the tab up in the direction of the arrow.
- ▶ Take the seat belt out of seat belt guide ①.
- ▶ **To insert:** fold the tab up in the direction of the arrow.
- ▶ Insert the seat belt back into the seat belt guide and fold the tab back down.

Adjusting the head restraints

Adjusting the height of the head restraints electrically

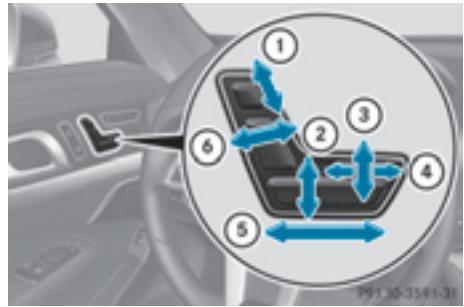

- ① Head restraint height
- ② Seat height
- ③ Seat cushion angle
- ④ Seat cushion length
- ⑤ Seat fore-and-aft adjustment
- ⑥ Backrest angle

- ▶ **To adjust the head restraint height:** slide the switch for the head restraint adjustment ① up or down in the direction of the arrow.

Moving the seats forward/back

⚠ WARNING

When you adjust a seat, you or other vehicle occupants could become trapped, e.g. on the seat guide rail. There is a risk of injury.

Make sure when adjusting a seat that no one has any body parts in the sweep of the seat.

- ❗ Make sure that there are no containers in the cup holder and no objects in the footwell or behind the seats when adjusting the seats. Otherwise, you could damage the seats and the objects.

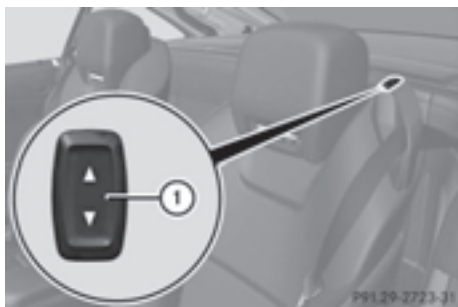

You can move the seat forwards in order to gain better access to the rear compartment, e.g. to reach the stowage compartment in the rear (▷ page 514).

- ▶ Remove the seat belt from the seat belt guide (▷ page 111).
- ▶ **To move the seat forwards:** press on switch ①.
The seat moves automatically to the foremost position.
- ▶ **To move the seat backwards:** press on switch ①.
The seat moves back to the previous position.
- ▶ **To stop seat movement:** press or in the opposite direction.

Adjusting the multicontour seat

You can set the multicontour seat using COMAND (▷ page 314).

Adjusting the active multicontour seat

You can set the active multicontour seat using COMAND (▷ page 314).

Adjusting the 4-way lumbar support

You can adjust the 4-way lumbar support using COMAND (▷ page 315).

Switching the seat heating on/off

Activating/deactivating

WARNING

Repeatedly switching on the seat heating can cause the seat cushion and backrest pads to become very hot. The health of persons with limited temperature sensitivity or a limited ability to react to excessively high temperatures may be affected or they may even suffer burn-like injuries. There is a risk of injury.

Therefore, do not switch the seat heating on repeatedly.



Driver's and front-passenger seat

The three red indicator lamps in the button indicate the heating level you have selected.

The system automatically switches down from level **3** to level **2** after approximately eight minutes.

The system automatically switches down from level **2** to level **1** after approximately ten minutes.

The system automatically switches off approximately 20 minutes after it is set to level **1**.

You can set the distribution of the heated sections of the seat cushion and backrest using COMAND (▷ page 316).

- ▶ Make sure that the SmartKey is in position **1** or **2** in the ignition lock.
- ▶ **To switch on:** press button ① repeatedly until the desired heating level is set.
- ▶ **To switch off:** press button ① repeatedly until all the indicator lamps go out.

i If the battery voltage is too low, the seat heating may switch off.

Problems with the seat heating

The seat heating has switched off prematurely or cannot be switched on. The vehicle's electrical system voltage is too low because too many electrical consumers are switched on.

- ▶ Switch off electrical consumers that you do not need, such as the rear window defroster or interior lighting.
- ▶ Once the battery is sufficiently charged, switch on the seat heating again.

Switching the seat ventilation on/off

Activating/deactivating

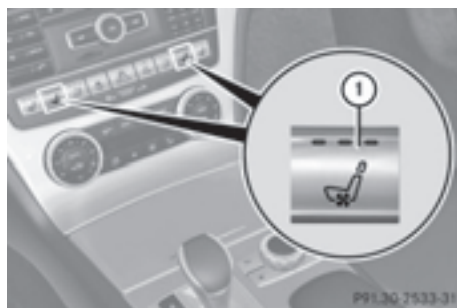

The three blue indicator lamps in the buttons indicate the ventilation level you have selected.

- ▶ Make sure that the SmartKey is in position **2** in the ignition lock.
- ▶ **To switch on:** press button ① repeatedly until the desired ventilation level is set.
- ▶ **To switch off:** press button ① repeatedly until all the indicator lamps go out.

i If the battery voltage is too low, the seat ventilation may switch off.

i If you open the roof with the SmartKey (▷ page 102), the seat ventilation of the driver's seat switches on automatically and the side windows open.

Problems with the seat ventilation

The seat ventilation has switched off prematurely or cannot be switched on. The vehicle's electrical system voltage is too low because too many electrical consumers are switched on.

- ▶ Switch off electrical consumers which you do not need, such as the rear window defroster or interior lighting.

AIRSCARF

Activating/deactivating

⚠ WARNING

When AIRSCARF is switched on, very hot air can flow from the vents in the head restraints. This could result in burns in the immediate vicinity of the air vents. There is a risk of injury. Reduce the heater output before it becomes too hot.



The AIRSCARF function warms the head and neck area of vehicle occupants with warm air. The warm air flows out of the holes in the head restraints.

The three red indicator lamps in the button indicate the heating level you have selected.

► Make sure that the SmartKey is in position **2** in the ignition lock.

► **To switch on:** press button ①.

Three red indicator lamps in the button light up. The blower starts up after a preheating phase of seven seconds.

► Press button ① repeatedly until the desired heating level is set.

► **To switch off:** press button ① repeatedly until all the indicator lamps go out.

i The blower continues running for seven seconds to cool down the heating elements.

i If the battery voltage is too low, AIRSCARF may switch off.

Steering wheel

Important safety notes

⚠ WARNING

You could lose control of your vehicle if you do the following while driving:

- adjust the driver's seat, head restraint, steering wheel or mirrors
- fasten the seat belt

There is a risk of an accident.

Adjust the driver's seat, head restraint, steering wheel and mirror and fasten your seat belt before starting the engine.

⚠ WARNING

You can no longer steer the vehicle if the steering wheel lock has been engaged. There is a risk of an accident.

Always switch off the ignition when towing the vehicle with a tow cable or a tow bar.

⚠ WARNING

Children could injure themselves if they adjust the steering wheel. There is a risk of injury.

When leaving the vehicle, always take the SmartKey with you and lock the vehicle. Never leave children unsupervised in the vehicle.

The electrically adjustable steering wheel can still be adjusted when there is no key in the ignition lock.

Adjusting the steering wheel electrically

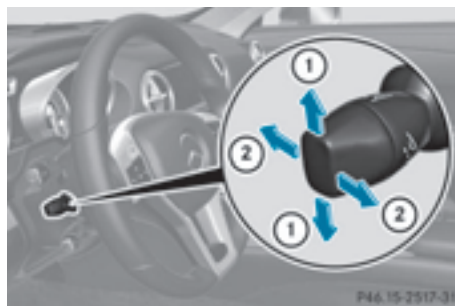

① To adjust the steering wheel height

② To adjust the steering wheel position (fore-and-aft adjustment)

i Further related subjects:

- EASY-ENTRY/EXIT feature (► page 115)
- Storing settings (► page 119)

EASY-ENTRY/EXIT feature**Important safety notes** **WARNING**

If you drive off while the EASY-ENTRY/EXIT feature is making adjustments, you could lose control of the vehicle. There is a risk of an accident.

Always wait until the adjustment process is complete before driving off.

 **WARNING**

When the EASY-ENTRY/EXIT feature adjusts the steering wheel, you and other vehicle occupants – particularly children – could become trapped. There is a risk of injury. While the EASY-ENTRY/EXIT feature is making adjustments, make sure that no one has any body parts in the sweep of the steering wheel.

If somebody becomes trapped:

- press one of the memory function position buttons, or
- move the switch for steering wheel adjustment in the opposite direction to that in which the steering wheel is moving.

The adjustment process is stopped.

 **WARNING**

When the EASY-ENTRY/EXIT feature adjusts the steering wheel and the driver's seat, you and other vehicle occupants – particularly children – could become trapped. There is a risk of injury.

While the EASY-ENTRY/EXIT feature is making adjustments, make sure that no one has any body parts in the sweep of the seat and the steering wheel.

If somebody becomes trapped:

- press one of the memory function position buttons, or
- press one of the memory function memory buttons, or
- move the switch for steering wheel adjustment in the opposite direction to that in which the steering wheel is moving

The adjustment process is stopped.

 **WARNING**

If you use openings in the bodywork or detachable parts as steps, you could:

- slip and/or fall
- damage the vehicle and cause yourself to fall.

There is a risk of injury.

Always use secure climbing aids, e.g. a suitable ladder.

The EASY-ENTRY/EXIT feature makes getting in and out of your vehicle easier.

You can activate and deactivate the EASY-ENTRY/EXIT feature in the on-board computer (▷ page 235).

Position of the steering wheel when the EASY-ENTRY/EXIT feature is active

The steering wheel swings upwards when you:

- remove the SmartKey from the ignition lock
- open the driver's door with KEYLESS-GO in position **1**
- open the driver's door and the SmartKey is in position **0** or **1** in the ignition lock

 The steering wheel only moves upwards if it has not already reached the upper end stop.

Position of the steering wheel for driving

The steering wheel is moved to the last selected position when:

- the driver's door is closed
- you insert the SmartKey into the ignition lock
or
- you press the Start/Stop button once on vehicles with KEYLESS-GO

When you close the driver's door with the ignition switched on, the steering wheel is also automatically moved to the previously set position.

The last position of the steering wheel is stored when you switch off the ignition or when you store the setting with the memory function (▷ page 119).

Crash-responsive EASY-EXIT feature

If the crash-responsive EASY-EXIT feature is triggered in an accident, the steering column will move upwards when the driver's door is opened. This occurs irrespective of the position of the SmartKey in the ignition lock. This makes it easier to exit the vehicle and rescue the occupants.

The crash-responsive EASY-EXIT feature is only operational if the EASY-EXIT/ENTRY feature is activated in the on-board computer (▷ page 235).

Mirrors

Exterior mirrors

Adjusting the exterior mirrors

WARNING

The exterior mirrors reduce the size of the image. Visible objects are actually closer than they appear. This means that you could misjudge the distance from road users traveling behind, e.g. when changing lane. There is a risk of an accident.

For this reason, always make sure of the actual distance from the road users traveling behind by glancing over your shoulder.

WARNING

The exterior mirror on the front-passenger side reduces the size of the image. Visible objects are actually closer than they appear. This means that you could misjudge the distance from road users traveling behind, e.g. when changing lane. There is a risk of an accident.

For this reason, always make sure of the actual distance from the road users traveling behind by glancing over your shoulder.



- ▶ Make sure that the SmartKey is in position **1** or **2** in the ignition lock.
- ▶ Press button **1** for the left-hand exterior mirror or button **2** for the right-hand exterior mirror.
The indicator lamp in the corresponding button lights up in red.
The indicator lamp goes out again after some time. You can adjust the selected mirror using adjustment button **3** as long as the indicator lamp is lit.
- ▶ Press adjustment button **3** up, down, to the right or to the left.
The exterior mirror must be set to a position that provides you with a good overview of traffic conditions.

The convex exterior mirrors provide a larger field of vision.

The exterior mirrors are automatically heated after starting the vehicle if the rear window defroster is switched on and the outside temperature is low. Mirror heating lasts up to 10 minutes.

- i** You can also heat up the exterior mirrors manually by switching on the rear window defroster.

Folding the exterior mirrors in or out electrically



- ▶ Make sure that the SmartKey is in position **1** or **2** in the ignition lock.
- ▶ Briefly press button **1**. Both exterior mirrors fold in or out.
- i** Make sure that the exterior mirrors are always folded out fully while driving. They could otherwise vibrate.

Exterior mirror pushed out of position

If an exterior mirror has been pushed out of position, proceed as follows:

- ▶ Move the exterior mirror into the correct position manually. The mirror housing is engaged again and you can adjust the exterior mirrors as usual (> page 116).

Automatic anti-glare mirrors

WARNING

Electrolyte may escape if the glass in an automatic anti-glare mirror breaks. The electrolyte

is harmful and causes irritation. It must not come into contact with your skin, eyes, respiratory organs or clothing or be swallowed. There is a risk of injury.

If you come into contact with the electrolyte, observe the following:

- Rinse off the electrolyte from your skin immediately with water.
- Immediately rinse the electrolyte out of your eyes thoroughly with clean water.
- If the electrolyte is swallowed, immediately rinse your mouth out thoroughly. Do not induce vomiting.
- If electrolyte comes into contact with your skin or hair or is swallowed, seek medical attention immediately.
- Immediately change out of clothing which has come into contact with electrolyte.
- If an allergic reaction occurs, seek medical attention immediately.

The rear-view mirror and the exterior mirror on the driver's side automatically go into anti-glare mode if the following conditions are met simultaneously:

- the ignition is switched on and
- incident light from headlamps strikes the sensor in the rear-view mirror.

The mirrors do not go into anti-glare mode if reverse gear is engaged or if the interior lighting is switched on.

Electrolyte may escape if the glass in an automatic anti-glare mirror breaks. The electrolyte

Parking position for the exterior mirror on the front-passenger side

Setting and storing the parking position

Using reverse gear

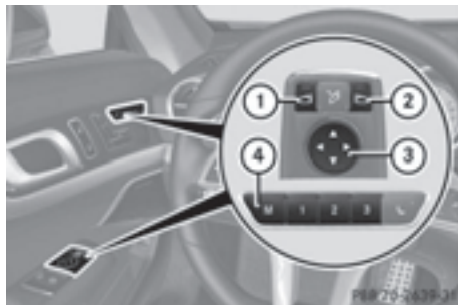

- ① Button for the driver's side exterior mirror
- ② Button for the front-passenger side exterior mirror
- ③ Adjustment button
- ④ Memory button **M**

You can position the front-passenger side exterior mirror in such a way that you can see the rear wheel on that side as soon as you engage reverse gear. You can store this position.

- ▶ Make sure that the vehicle is stationary and that the SmartKey is in position **2** in the ignition lock.
- ▶ Press button ② for the exterior mirror on the front-passenger side.
- ▶ Engage reverse gear.
The exterior mirror on the front-passenger side moves to the preset parking position.
- ▶ Use adjustment button ③ to adjust the exterior mirror to a position that allows you to see the rear wheel and the curb.
The parking position is stored.

i If you shift the transmission to another position, the exterior mirror on the front-passenger side returns to the driving position.

Using the memory button

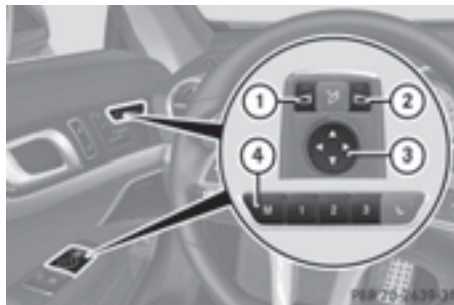

- ① Button for the driver's side exterior mirror
- ② Button for the front-passenger side exterior mirror
- ③ Adjustment button
- ④ Memory button **M**

You can position the front-passenger side exterior mirror in such a way that you can see the rear wheel on that side as soon as you engage reverse gear. This setting can be stored using memory button **M** ④.

- ▶ Make sure that the SmartKey is in position **2** in the ignition lock.
- ▶ With the exterior mirror on the front-passenger side activated, use adjustment button ③ to adjust the exterior mirror. In the exterior mirror, the rear wheel and the curb should be visible.
- ▶ Press memory button **M** ④ and one of the arrows on adjustment button ③ within three seconds.
The parking position is stored if the exterior mirror does not move.
- ▶ If the mirror moves out of position, repeat the steps.

Calling up a stored parking position setting

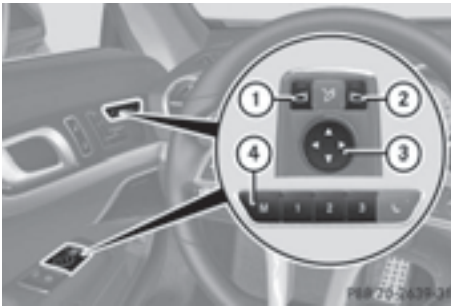

- ① Button for the driver's side exterior mirror
- ② Button for the front-passenger side exterior mirror
- ③ Adjustment button
- ④ Memory button **M**

- ▶ Turn the SmartKey to position **2** in the ignition lock.
- ▶ Adjust the exterior mirror on the front-passenger side using button ②.
- ▶ Engage reverse gear.

The exterior mirror on the front-passenger side moves to the stored parking position.

The exterior mirror on the front-passenger side moves back to its original position:

- as soon as you exceed a speed of 9 mph (15 km/h)
- if you press button ① for the exterior mirror on the driver's side

Memory function

Storing settings

WARNING

If you use the memory function on the driver's side while driving, you could lose control of the vehicle as a result of the adjustments being made. There is a risk of an accident.

Only use the memory function on the driver's side when the vehicle is stationary.

WARNING

When the memory function adjusts the seat or steering wheel, you and other vehicle occupants – particularly children – could become trapped. There is a risk of injury.

While the memory function is making adjustments, make sure that no one has any body parts in the sweep of the seat or steering wheel. If somebody becomes trapped, immediately release the memory function position button. The adjustment process is stopped.

WARNING

When the memory function adjusts the seat, you and other vehicle occupants – particularly children – could become trapped. There is a risk of injury.

While the memory function is making adjustments, make sure that no one has any body parts in the sweep of the seat. If somebody becomes trapped, immediately release the memory function position button. The adjustment process is stopped.

WARNING

Children could become trapped if they activate the memory function, particularly when unattended. There is a risk of injury.

When leaving the vehicle, always take the SmartKey with you and lock the vehicle. Never leave children unsupervised in the vehicle.



- ▶ Adjust the seat electrically (▷ page 110).
- ▶ On the driver's side, adjust the steering wheel (▷ page 114) and the exterior mirrors (▷ page 116).
- ▶ Press memory button **M** and one of the storage position buttons **1**, **2** or **3** within three seconds.

The settings are stored in the selected pre-set position. A tone sounds when the settings have been completed.

Calling up a stored setting

- ▶ Press and hold the relevant storage position button **1**, **2** or **3** until the seat, steering wheel and exterior mirrors are in the stored position.
- i** The setting procedure is interrupted as soon as you release the storage position button.

Useful information	122
Exterior lighting	122
Interior lighting	128
Replacing bulbs	129
Windshield wipers	130

Useful information

i This Operator's manual describes all models and all standard and optional equipment of your vehicle available at the time of publication of the Operator's manual. Country-specific differences are possible. Please note that your vehicle may not be equipped with all features described. This also applies to safety-related systems and functions.

i Read the information on qualified specialist workshops (▷ page 35).

Exterior lighting

General notes

For reasons of safety, Mercedes-Benz recommends that you drive with the lights switched on even during the daytime. In some countries, operation of the headlamps varies due to legal requirements and self-imposed obligations.

Driving abroad

Symmetrical low-beam headlamps

Switch the headlamps to symmetrical low beam in countries in which traffic drives on the opposite side of the road from the country where the vehicle is registered. This prevents glare to oncoming traffic. When using symmetrical lights, the edge of the road is not lit as widely and as far ahead as normal.

Have the headlamps converted at a qualified specialist workshop as close to the border as possible before driving in these countries.

Asymmetrical low beam

Have the headlamps converted back to asymmetrical low-beam headlamps at a qualified specialist workshop as soon as possible after crossing the border again.

Setting the exterior lighting

Setting options

Exterior lighting can be set using:

- the light switch
- the combination switch (▷ page 125)
- the on-board computer (▷ page 232)

Light switch

Operation



- 1** Left-hand standing lamps
- 2** Right-hand standing lamps
- 3** Parking lamps, license plate and instrument cluster lighting
- 4** **AUTO** Automatic headlamp mode, controlled by the light sensor
- 5** Low-beam/high-beam headlamps

If you hear a warning tone when you leave the vehicle, the lights may still be switched on.

► Turn the light switch to **AUTO**.

The exterior lighting (except the parking/standing lamps) switches off automatically if you:

- remove the SmartKey from the ignition lock
- open the driver's door with the SmartKey in position **0**.

Automatic headlamp mode

WARNING

When the light switch is set to **AUTO**, the low-beam headlamps may not be switched on automatically if there is fog, snow or other

causes of poor visibility due to the weather conditions such as spray. There is a risk of an accident.

In such situations, turn the light switch to



The automatic headlamp feature is only an aid. The driver is responsible for the vehicle's lighting at all times.



- 1 Left-hand standing lamps
- 2 Right-hand standing lamps
- 3 Parking lamps, license plate and instrument cluster lighting
- 4 Automatic headlamp mode, controlled by the light sensor
- 5 Low-beam/high-beam headlamps

AUTO is the favored light switch setting. The light setting is automatically selected according to the brightness of the ambient light (exception: poor visibility due to weather conditions such as fog, snow or spray):

- SmartKey in position 1 in the ignition lock: the parking lamps are switched on or off automatically depending on the brightness of the ambient light.
- With the engine running: if you have activated the daytime running lamps function via the on-board computer, the daytime running lamps or the low-beam headlamps and parking lamps are switched on or off automatically depending on the brightness of the ambient light.

- **To switch on automatic headlamp mode:** turn the light switch to **AUTO**.

Only for Canada:

The daytime running lamps improve the visibility of your vehicle during the day. The daytime running lamps function is required by law in Canada. It cannot therefore be deactivated.

When the engine is running and the vehicle is stationary: if you move the selector lever from a drive position to **P**, the daytime running lamps/low-beam headlamps go out after three minutes.

When the engine is running, the vehicle is stationary and in bright ambient light: if you turn the light switch to , the daytime running lamps and parking lamps switch on.

If the engine is running and you turn the light switch to , the manual settings take precedence over the daytime running lamps.

USA only:

The daytime running lamps improve the visibility of your vehicle during the day. To do this, the daytime running lamps function must be switched on using the on-board computer (► page 232).

If the engine is running and you turn the light switch to or , the manual settings take precedence over the daytime running lamps.

Low-beam headlamps

WARNING

When the light switch is set to **AUTO**, the low-beam headlamps may not be switched on automatically if there is fog, snow or other causes of poor visibility due to the weather conditions such as spray. There is a risk of an accident.

In such situations, turn the light switch to





- 1 Left-hand standing lamps
- 2 Right-hand standing lamps
- 3 Parking lamps, license plate and instrument cluster lighting
- 4 **AUTO** Automatic headlamp mode, controlled by the light sensor
- 5 Low-beam/high-beam headlamps

Even if the light sensor does not detect that it is dark, the parking lamps and low-beam headlamps switch on when the ignition is switched on and the light switch is set to the position. This is a particularly useful function in the event of rain and fog.

- ▶ **To switch on the low-beam headlamps:** turn the SmartKey in the ignition lock to position **2** or start the engine.
- ▶ Turn the light switch to . The green indicator lamp in the instrument cluster lights up.

Parking lamps

- ! If the battery has been excessively discharged, the parking lamps or standing lamps are automatically switched off to enable the next engine start. Always park your vehicle safely and sufficiently lit according to legal standards. Avoid the continuous use of the parking lamps for several hours. If possible, switch on the right or the left standing lamp.



- 1 Left-hand standing lamps
- 2 Right-hand standing lamps
- 3 Parking lamps, license plate and instrument cluster lighting
- 4 **AUTO** Automatic headlamp mode, controlled by the light sensor
- 5 Low-beam/high-beam headlamps



- ▶ **To switch on:** turn the light switch to . The green indicator lamp in the instrument cluster lights up.

Standing lamps



- 1 Left-hand standing lamps
- 2 Right-hand standing lamps
- 3 Parking lamps, license plate and instrument cluster lighting
- 4 **AUTO** Automatic headlamp mode, controlled by the light sensor
- 5 Low-beam/high-beam headlamps

Switching on the standing lamps ensures the corresponding side of the vehicle is illuminated.

- ▶ **To switch on the standing lamps:** the SmartKey is not in the ignition lock or it is in position **0**.
- ▶ Turn the light switch to  (left-hand side of the vehicle) or  (right-hand side of the vehicle).

Combination switch

Turn signal

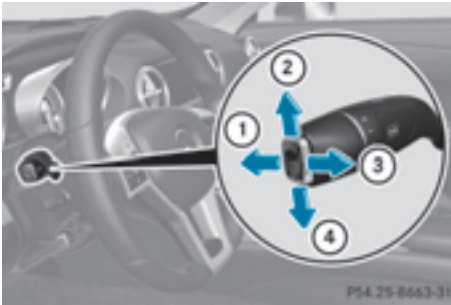



- ① High-beam headlamps
- ② Turn signal, right
- ③ High-beam flasher
- ④ Turn signal, left

- ▶ **To indicate briefly:** press the combination switch briefly to the pressure point in the direction of arrow ② or ④. The corresponding turn signal flashes three times.
- ▶ **To indicate:** press the combination switch beyond the pressure point in the direction of arrow ② or ④.

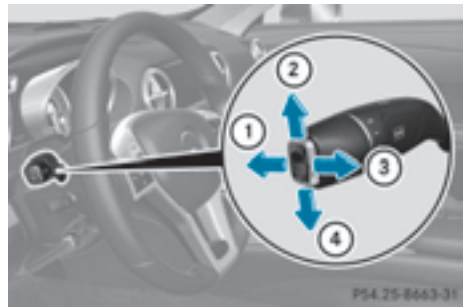
High-beam headlamps



- ① High-beam headlamps
- ② Turn signal, right
- ③ High-beam flasher
- ④ Turn signal, left

- ▶ **To switch on the high-beam headlamps:** turn the SmartKey in the ignition lock to position **2** or start the engine.
- ▶ Turn the light switch to  or **AUTO**.
- ▶ Press the combination switch beyond the pressure point in the direction of arrow ①. In the **AUTO** position, the high-beam headlamps are only switched on when it is dark and the engine is running. The  indicator lamp in the instrument cluster lights up when the high-beam headlamps are switched on.
- ▶ **To switch off the high-beam headlamps:** move the combination switch back to its normal position. The  indicator lamp in the instrument cluster goes out.

High-beam flasher

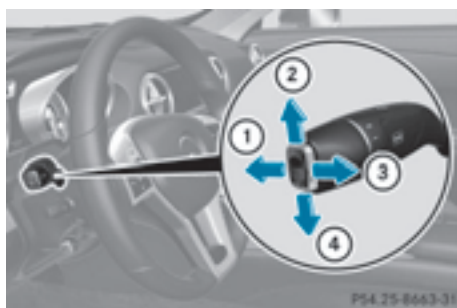

- ① High-beam headlamps
- ② Turn signal, right
- ③ High-beam flasher
- ④ Turn signal, left

- ▶ **To switch on:** turn the SmartKey in the ignition lock to position **1** or **2** or start the engine.
- ▶ Pull the combination switch in the direction of arrow **③**.

Hazard warning lamps



- ▶ **To switch on the hazard warning lamps:** press button **①**. All turn signals flash. If you now switch on a turn signal using the combination switch, only the turn signal lamp on the corresponding side of the vehicle will flash.
- ▶ **To switch off the hazard warning lamps:** press button **①**.

The hazard warning lamps automatically switch on if:

- an air bag is deployed or
- the vehicle decelerates rapidly from a speed of above 45 mph (70 km/h) and comes to a standstill

The hazard warning lamps switch off automatically if the vehicle reaches a speed of above 6 mph (10 km/h) again after a full brake application.

- i** The hazard warning lamps still operate if the ignition is switched off.

Cornering light function



The cornering light function improves the illumination of the road over a wide angle in the direction you are turning, enabling better visibility in tight bends, for example. The cornering light function can only be activated when the low-beam headlamps are switched on.

Active:

- if you are driving at speeds below 25 mph (40 km/h) and switch on the turn signal or turn the steering wheel
- if you are driving at speeds between 25 mph (40 km/h) and 45 mph (70 km/h) and turn the steering wheel

The cornering lamp may remain lit for a short time, but is automatically switched off after no more than three minutes.

Active light function

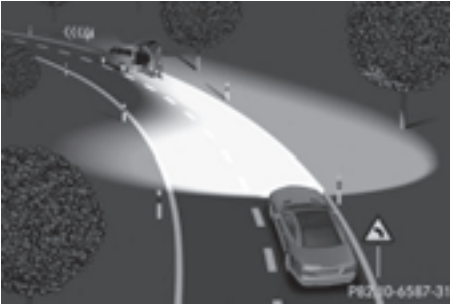

The active light function is a system that moves the headlamps according to the steering movements of the front wheels. In this way, relevant areas remain illuminated while driving. This allows you to identify pedestrians, cyclists and animals.

Active: when the lights are switched on.

Adaptive Highbeam Assist

General notes



You can use this function to set the headlamps to change between low beam and high beam automatically. The system recognizes vehicles with their lights on, either approaching from the opposite direction or traveling in front of your vehicle, and consequently

switches the headlamps from high beam to low beam.

The system automatically adapts the low-beam headlamp range depending on the distance to the other vehicle. Once the system no longer detects any other vehicles, it reactivates the high-beam headlamps.

The system's optical sensor is located behind the windshield near the overhead control panel.

Important safety notes

WARNING

Adaptive Highbeam Assist does not recognize road users:

- who have no lights, e.g. pedestrians
- who have poor lighting, e.g. cyclists
- whose lighting is blocked, e.g. by a barrier

In very rare cases, Adaptive Highbeam Assist may fail to recognize other road users that have lights, or may recognize them too late. In this or similar situations, the automatic high-beam headlamps will not be deactivated or activated regardless. There is a risk of an accident.

Always carefully observe the traffic conditions and switch off the high-beam headlamps in good time.

Adaptive Highbeam Assist cannot take into account road, weather or traffic conditions. Adaptive Highbeam Assist is only an aid. You are responsible for adjusting the vehicle's lighting to the prevailing light, visibility and traffic conditions.

In particular, the detection of obstacles can be restricted if there is:

- poor visibility, e.g. due to fog, heavy rain or snow
- dirt on the sensors or the sensors are obscured

Switching Adaptive Highbeam Assist on/off

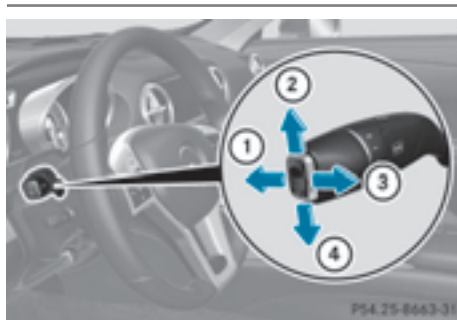

- ① High-beam headlamps
- ② Turn signal, right
- ③ High-beam flasher
- ④ Turn signal, left

► **To switch on:** turn the light switch to **AUTO**.

► Press the combination switch beyond the pressure point in the direction of arrow ①. The  indicator lamp in the multifunction display lights up when it is dark and the light sensor activates the low-beam headlamps.



If you are driving at speeds above approximately 16 mph (25 km/h):

The headlamp range is set automatically depending on the distance between the vehicle and other road users.

If you are driving at speeds above approximately 19 mph (30 km/h) and no other road users have been detected:

The high-beam headlamps are switched on automatically. The  indicator lamp in the instrument cluster also lights up.

If you are driving at speeds below approximately 16 mph (25 km/h) or other road users have been detected or the roads are adequately lit:

The high-beam headlamps are switched off automatically. The  indicator lamp in the instrument cluster goes out. The 

indicator lamp in the multifunction display remains lit.

► **To switch off:** move the combination switch back to its normal position or move the light switch to another position.

The  indicator lamp in the multifunction display goes out.

Headlamps fogged up on the inside





Certain climatic and physical conditions may cause moisture to form in the headlamp. This moisture does not affect the functionality of the headlamp.

Interior lighting

Overview of interior lighting



Overhead control panel

- ①  Switches the left-hand reading lamp on/off
- ②  Switches the interior lighting on
- ③  Switches the interior lighting/automatic interior lighting control off
- ④  Switches the right-hand reading lamp on/off
- ⑤  Switches the automatic interior lighting control on

Interior lighting control

General notes

In order to prevent the vehicle's battery from discharging, the interior lighting functions are automatically deactivated after some time unless the SmartKey is in position **2** in the ignition lock.

Automatic interior lighting control



Overhead control panel

- ① To switch the left-hand reading lamp on/off
- ② To switch the interior lighting on
- ③ To switch the interior lighting/automatic interior lighting control off
- ④ To switch the right-hand reading lamp on/off
- ⑤ To switch the automatic interior lighting control on

► **To switch on:** set the switch to center position ⑤.

► **To switch off:** set the switch to the position.

The interior lighting automatically switches on if you:

- unlock the vehicle
- open a door
- remove the SmartKey from the ignition lock

The interior light is activated for a short while when the SmartKey is removed from the ignition lock. You can activate this delayed

switch-off using the on-board computer (► page 234).

Manual interior lighting control

- **To switch the interior lighting on:** set the switch to the position.
- **To switch the interior lighting off:** set the switch to the or (if the door is closed) to the center position.
- **To switch the reading lamps on/off:** press the button.

Crash-responsive emergency lighting

The interior lighting is activated automatically if the vehicle is involved in an accident.

- **To switch off the crash-responsive emergency lighting:** press the hazard warning lamp button.

or

- Lock and then unlock the vehicle using the SmartKey.

Replacing bulbs

DANGER

Xenon bulbs carry a high voltage. You can get an electric shock if you remove the cover of the Xenon bulb and touch the electrical contacts. There is a risk of fatal injury.

Never touch the parts or the electrical contacts of the Xenon bulb. Always have work on the Xenon bulbs carried out at a qualified specialist workshop.

The front and rear lamps of your vehicle are equipped with either Xenon or LED bulbs. Do not replace the bulbs yourself. Contact a qualified specialist workshop which has the necessary specialist knowledge and tools to carry out the work required.

Bulbs and lamps are an important aspect of vehicle safety. You must therefore make sure

that these function correctly at all times. Have the headlamp setting checked regularly.

Windshield wipers

Switching the windshield wipers on/off

! Do not operate the windshield wipers when the windshield is dry, as this could damage the wiper blades. Moreover, dust that has collected on the windshield can scratch the glass if wiping takes place when the windshield is dry.

If it is necessary to switch on the windshield wipers in dry weather conditions, always use washer fluid when operating the windshield wipers.

! If the windshield wipers leave smears on the windshield after the vehicle has been washed in an automatic car wash, wax or other residues may be the reason for this. Clean the windshield using washer fluid after washing the vehicle in an automatic car wash.

! Intermittent wiping with rain sensor: due to optical influences and the windshield becoming dirty in dry weather conditions, the windshield wipers may be activated inadvertently. This could then damage the windshield wiper blades or scratch the windshield.

For this reason, you should always switch off the windshield wipers in dry weather.

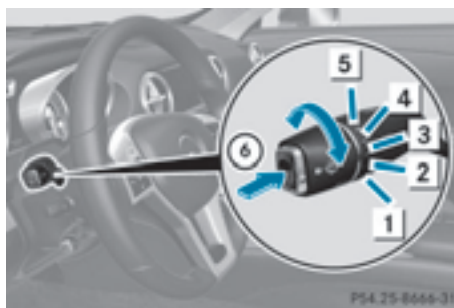

Combination switch

- 1 0 Windshield wiper off
- 2 ... Intermittent wipe, low (rain sensor set to low sensitivity)
- 3 Intermittent wipe, high (rain sensor set to high sensitivity)
- 4 — Continuous wipe, slow
- 5 == Continuous wipe, fast
- 6 To wipe the windshield using washer fluid

► Switch on the ignition.

► Turn the combination switch to the corresponding position.

In the ... or position, the appropriate wiping frequency is set automatically according to the intensity of the rain. In the position, the rain sensor is more sensitive than in the ... position, causing the windshield wipers to wipe more frequently.

If the wiper blades are worn, the windshield will no longer be wiped properly. This could prevent you from observing the traffic conditions, thereby causing an accident.

i The vehicle is equipped with the MAGIC VISION CONTROL wipe/wash system. The washer fluid is fed through the wiper blades and when wiping the screen with washer fluid , the water is emitted directly from the blades.



Replacing the wiper blades

Important safety notes

WARNING

If the windshield wipers begin to move while you are changing the wiper blades, you could be trapped by the wiper arm. There is a risk of injury.

Always switch off the windshield wipers and ignition before changing the wiper blades.

-  To avoid damaging the wiper blades, make sure that you touch only the wiper arm of the wiper.
-  Never open the hood if a windshield wiper arm has been folded away from the windshield.

Never fold a windshield wiper arm without a wiper blade back onto the windshield.

Hold the windshield wiper arm firmly when you change the wiper blade. If you release the windshield wiper arm without a wiper blade and it falls onto the windshield, the windshield may be damaged by the force of the impact.

Mercedes-Benz recommends that you have the wiper blades changed at a qualified specialist workshop.

-  Always position the windshield wiper arms vertically before folding them away from the windshield. By doing so, you will avoid damage to the hood.

Changing the windshield wiper blades

Moving the wiper arm to a vertical position

On vehicles without KEYLESS-GO:

- ▶ Turn the SmartKey to position **1** or **2** in the ignition lock.
- ▶ Set the windshield wipers to position .

- ▶ When the wiper arms have reached a vertical position, turn the SmartKey to position **0** and remove it from the ignition lock.
- ▶ Fold the wiper arm away from the windshield until it engages.

On vehicles with KEYLESS-GO:

- ▶ Switch off the engine.
- ▶ Remove your foot from the brake pedal.
- ▶ Set the windshield wipers to position .
- ▶ Press the Start/Stop button repeatedly until the windshield wiper starts.
- ▶ When the wiper arms have reached a vertical position, press the Start/Stop button.
- ▶ Fold the wiper arm away from the windshield until it engages.

Removing a wiper blade

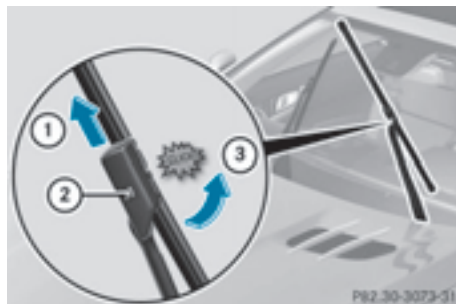

- ▶ **To bring the wiper blade into position to be removed:** hold the wiper arm firmly with one hand. With the other hand, turn the wiper blade in the direction of arrow **3** beyond the point of resistance. The wiper blade engages in the removal position with an audible click.
- ▶ **To remove a wiper blade:** firmly press release knob **2** and pull the wiper blade upwards **1**.

Installing the wiper blades



- ▶ Push the new wiper blade in the direction of arrow ① onto the wiper arm until tab ② engages.
- ▶ Push the wiper blade out of the removal position in the direction of arrow ③ beyond the point of resistance. The wiper blade disengages with an audible click and is freely movable again.
- ▶ Make sure that the wiper blade is seated correctly.
- ▶ Fold the wiper arm back onto the windshield.

Problems with the windshield wipers

Problem	Possible causes/consequences and ► Solutions
The windshield wipers are jammed.	Leaves or snow, for example, may be obstructing the windshield wiper movement. The wiper motor has been deactivated. ► For safety reasons, you should remove the SmartKey from the ignition lock. or ► Switch off the engine using the Start/Stop button and open the driver's door. ► Remove the cause of the obstruction. ► Switch the windshield wipers back on.
The windshield wipers fail completely.	The windshield wiper drive is malfunctioning. ► Select another wiper speed on the combination switch. ► Have the windshield wipers checked at a qualified specialist workshop.

Useful information	136
Overview of climate control systems	136
Operating the climate control systems	139
Setting the air vents	147

Useful information

- i** This Operator's manual describes all models and all standard and optional equipment of your vehicle available at the time of publication of the Operator's manual. Country-specific differences are possible. Please note that your vehicle may not be equipped with all features described. This also applies to safety-related systems and functions.
- i** Read the information on qualified specialist workshops (▷ page 35).

- i** It is possible that the dehumidification function of the climate control system may be activated automatically an hour after the SmartKey has been removed. The vehicle is then ventilated for 30 minutes to dry the air-conditioning system.

Overview of climate control systems

General notes

Observe the settings recommended on the following pages. The windows could otherwise fog up.

To prevent the windows from fogging up:

- switch off climate control only briefly
- switch on air-recirculation mode only briefly
- switch on the cooling with air dehumidification function
- switch on the defrost windshield function briefly, if required

Climate control regulates the temperature and the humidity in the vehicle interior and filters undesirable substances out of the air.

Climate control can only be operated when the engine is running. Optimum operation is only achieved with the side windows and roof closed.

The residual heat function can only be activated or deactivated with the ignition switched off (▷ page 146).

- i** When the weather is warm, ventilate the vehicle for a brief period. This will speed up the cooling process and the desired vehicle interior temperature will be reached more quickly.

Control panel for dual-zone automatic climate control

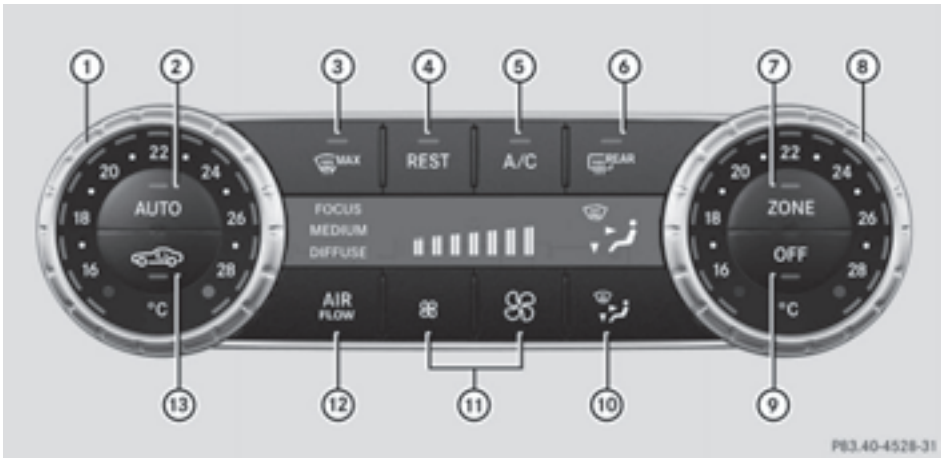

Canada only

- ① To set the temperature, left (▷ page 142)
- ② To set climate control to automatic (▷ page 141)
- ③ To defrost the windshield (▷ page 143)
- ④ To switch the residual heat function on/off (▷ page 146)
- ⑤ To switch cooling with air dehumidification on/off (▷ page 139)
- ⑥ To switch the rear window defroster on/off (▷ page 144)
- ⑦ To switch the ZONE function on/off (▷ page 143)
- ⑧ To set the temperature, right (▷ page 142)
- ⑨ To switch climate control on/off (▷ page 139)
- ⑩ To set the air distribution (▷ page 142)
- ⑪ To set the airflow (▷ page 143)
- ⑫ To adjust the climate mode settings (▷ page 141)
- ⑬ To activate/deactivate air-recirculation mode (▷ page 146)

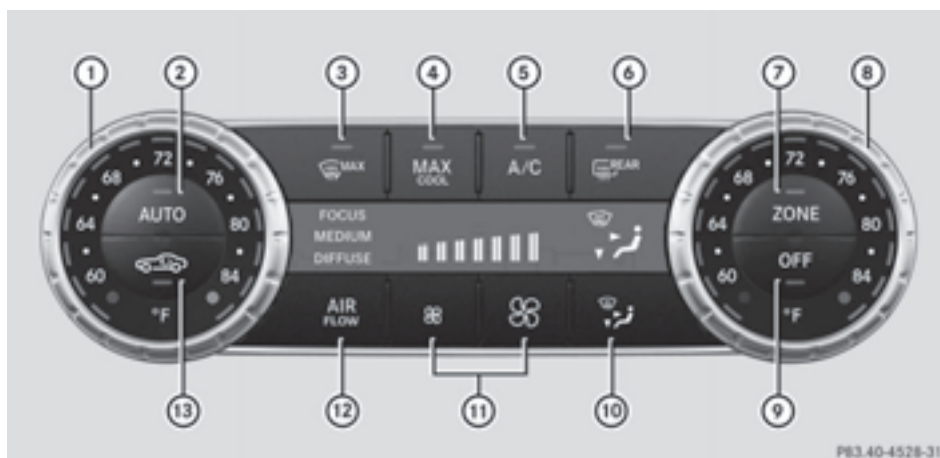

USA only

- ① To set the temperature, left (▷ page 142)
- ② To set climate control to automatic (▷ page 141)
- ③ To defrost the windshield (▷ page 143)
- ④ To switch maximum cooling on/off (▷ page 144)
- ⑤ To switch cooling with air dehumidification on/off (▷ page 139)
- ⑥ To switch the rear window defroster on/off (▷ page 144)
- ⑦ To switch the ZONE function on/off (▷ page 143)
- ⑧ To set the temperature, right (▷ page 142)
- ⑨ To switch climate control on/off (▷ page 139)
- ⑩ To set the air distribution (▷ page 142)
- ⑪ To set the airflow (▷ page 143)
- ⑫ To adjust the climate mode settings (▷ page 141)
- ⑬ To activate/deactivate air-recirculation mode (▷ page 146)

Optimum use of dual-zone automatic climate control

Automatic climate control

The following contains instructions and recommendations to enable you to get the most out of your automatic climate control.

- Activate climate control using the **AUTO** and **A/C** buttons on the control panel of the climate control. The indicator lamps in the **AUTO** and **A/C** buttons light up.
- In automatic mode, the **AIR FLOW** button on the climate control panel may be used to additionally adjust the airflow (FOCUS/MEDIUM/DIFFUSE). The MEDIUM level is recommended.
- Set the temperature to 72 °F (22 °C).
- Only use the "Windshield defrosting" function briefly until the windshield is clear again.
- Only use air-recirculation mode briefly, e.g. if there are unpleasant outside odors or when in a tunnel. The windows could otherwise fog up, since no fresh air is drawn into the vehicle in air-recirculation mode.

- Use the ZONE function to adopt the temperature settings on the driver's side for the front-passenger side as well. The indicator lamp in the **ZONE** button goes out.
- Use the residual heat function if you want to heat or ventilate the vehicle interior when the ignition is switched off. The residual heat function can only be activated or deactivated with the ignition switched off.
- **Vehicles with COMAND:** if you change the settings of the climate control system, the climate status display appears for three seconds at the bottom of the screen in the COMAND display. See also the separate COMAND operating instructions. You will see the current settings of the various climate control functions.

ECO start/stop function

During automatic engine switch-off, the climate control only operates at a reduced capacity. If you require full climate control capacity, the ECO start/stop function can be deactivated by pressing the ECO button (▷ page 156).

Operating the climate control systems

Switching climate control on/off

General notes

When the climate control is switched off, the air supply and air circulation are also switched off. The windows could fog up. Therefore, switch off climate control only briefly

- ① Activate climate control primarily using the **AUTO** button (▷ page 141).

Activating/deactivating

- ▶ Turn the SmartKey to position **2** in the ignition lock (▷ page 151).
 - ▶ **To activate:** press the **AUTO** button on the control panel for the climate control. The indicator lamp in the **AUTO** button lights up. Airflow and air distribution are set to automatic mode.
- or
- ▶ Press the **OFF** button on the control panel for the climate control. The indicator lamp in the **OFF** button goes out. The previously selected settings are restored.
 - ▶ **To deactivate:** press the **OFF** button. The indicator lamp in the **OFF** button lights up.

Activating/deactivating cooling with air dehumidification

General notes

If you deactivate the "Cooling with air-dehumidification" function, the air inside the vehicle will not be cooled. The air inside the vehicle will also not be dehumidified. The windows can fog up more quickly. Therefore, deactivate the cooling with air-dehumidification function only briefly.

The "Cooling with air dehumidification" function is only available when the engine is running. The air inside the vehicle is cooled and dehumidified according to the temperature selected.

Condensation may drip from the underside of the vehicle when it is in cooling mode. This is normal and not a sign that there is a malfunction.

Activating/deactivating



Example: A/C button

- ▶ **To activate:** press the A/C button.
The indicator lamp in the A/C button lights up.
- ▶ **To deactivate:** press the A/C button.
The indicator lamp in the A/C button goes out. The "Cooling with air dehumidification" function has a delayed switch-off feature.

Problems with the "Cooling with air dehumidification" function

Problem	Possible causes/consequences and ► Solutions
The indicator lamp in the  button flashes three times or remains off. The "Cooling with air dehumidification" function cannot be switched on.	Cooling with air dehumidification has been deactivated due to a malfunction. ► Visit a qualified specialist workshop.

Setting climate control to automatic

General notes

In automatic mode, the set temperature is maintained automatically at a constant level. The system automatically regulates the temperature of the dispensed air, the airflow and the air distribution.

The automatic mode functions optimally when the "Cooling with air dehumidification" function is activated. If necessary, cooling with air dehumidification can be deactivated.



If you deactivate the "Cooling with air-dehumidification" function, the air inside the vehicle will not be cooled. The air inside the vehicle will also not be dehumidified. The windows can fog up more quickly. Therefore, deactivate the cooling with air-dehumidification function only briefly.

Activating/switching



► Turn the SmartKey to position **2** in the ignition lock (▷ page 151).



► Set the desired temperature.

► **To activate:** press the  button. The indicator lamp in the  button lights up. Automatic air distribution and airflow are activated.

i When automatic mode is enabled, the climate mode can be selected (▷ page 141).

► **To switch to manual mode:** press the  button.

or

► Press the  or  button. The indicator lamp in the  button goes out.

Adjusting the climate mode settings

You can select the following climate mode settings in automatic mode:

- FOCUS high airflow that is set slightly cooler
- MEDIUM medium airflow, standard setting
- DIFFUSE low airflow that is set slightly warmer and with less draft



button (example)

- ▶ Turn the SmartKey to position **2** in the ignition lock (▷ page 151).
- ▶ Press the button.
- ▶ Press the button repeatedly until the desired climate mode appears in the display.

Setting the temperature

Activating/deactivating



Different temperatures can be set for the driver's and front-passenger sides.

- ▶ Turn the SmartKey to position **2** in the ignition lock (▷ page 151).
- ▶ Turn controls **1** or **2** clockwise or counter-clockwise (▷ page 137). Only change the temperature setting in small increments. Start at 72 °F (22 °C).
- i** If you turn controls **1** and **2** counter-clockwise to the lowest temperature setting, air-recirculation mode may activate

automatically, depending on the outside temperature.

Setting the air distribution

Activating/deactivating



- ▶ Turn the SmartKey to position **2** in the ignition lock (▷ page 151).
- ▶ Press the button repeatedly until the desired symbol appears in the display.

Air distribution settings

The following air distribution settings can be selected:

- Directs air through the center and side air vents
- Directs air through the footwell air vents
- Directs air through the center, side and footwell vents
- Directs air through the defroster vents
- Directs the airflow through the defroster, center and side air vents (Canada only)
- Directs air through the defroster and footwell vents
- Directs the airflow through the defroster, center and side air vents, as well as the footwell air vents (Canada only)

i Regardless of the air distribution setting, airflow is always directed through the side



air vents. The side air vents can only be closed when the controls on the side air vents are turned downwards.

er's side is adopted for the front-passenger side.

Setting the airflow





Activating/deactivating



- ▶ Turn the SmartKey to position **2** in the ignition lock (▷ page 151).
- ▶ **To increase:** press the  button.
- ▶ **To reduce:** press the  button.

Switching the ZONE function on/off



- ▶ **To switch on:** press the  button. The indicator lamp in the  button lights up. The temperature setting for the driver's side is not adopted for the front-passenger side.
- ▶ **To switch off:** press button . The indicator lamp in the  button goes out. The temperature setting for the driv-

Defrosting the windshield

General notes







Example:  button

You can use this function to defrost the windshield or to defrost the inside of the windshield and the side windows.

Switch off the "Windshield defrosting" function as soon as the windshield is clear again.

Switching the "Windshield defrosting" function on/off

- ▶ Turn the SmartKey to position **2** in the ignition lock (▷ page 151).
- ▶ **To activate:** press the  button. The indicator lamp in the  button lights up. The climate control system switches to the following functions:
 - high airflow
 - high temperature
 - air distribution to the windshield and front side windows
 - air-recirculation mode off
- ▶ **To deactivate:** press the  button. The indicator lamp in the  button goes out. The previously selected settings are

restored. Air-recirculation mode remains deactivated.

or

- ▶ Press the **AUTO** button.

The indicator lamp in the  button goes out. Airflow and air distribution are set to automatic mode.

or

- ▶ Turn the temperature controls to the left or to the right on the control panel for the climate control or clockwise or counter-clockwise.

Turn temperature controls ① or ⑧ clockwise or counter-clockwise (▷ page 137).

or



- ▶ Press the  or  button.

MAX COOL maximum cooling

The MAX COOL function is only available in vehicles for the USA.



MAX COOL is only operational when the engine is running.



- ▶ **To activate:** press the  button.
The indicator lamp in the button lights up.
- ▶ **To activate:** press off-road button  again.
The indicator lamp goes out. The previously selected settings are restored.

When you activate MAX COOL, climate control switches to the following functions:



- maximum cooling
- maximum airflow
- air-recirculation mode on

Defrosting the windows

Windows fogged up on the inside

- ▶ Activate the  cooling with air dehumidification function.
 - ▶ Activate the **AUTO** mode button.
 - ▶ If the windows continue to fog up, activate the  "Windshield defrosting" function.
- i** You should only select this setting until the windshield is clear again.

Windows fogged up on the outside

- ▶ Activate the windshield wipers.
 - ▶ Press the  button repeatedly until the  or  symbol appears in the display.
- i** You should only select this setting until the windshield is clear again.

Rear window defroster

General notes





The rear window defroster has a high current draw. You should therefore switch it off as soon as the rear window is clear. Otherwise,

the rear window defroster switches off automatically after several minutes.

If the battery voltage is too low, the rear window defroster may switch off.

Activating/deactivating

- ▶ Turn the SmartKey to position **2** in the ignition lock (▷ page 151).
- ▶ Press the  button.
The indicator lamp in the  button lights up or goes out.

Problems with the rear window defroster

Problem	Possible causes/consequences and ► Solutions
The rear window defroster has deactivated prematurely or cannot be activated.	<p>The on-board voltage is too low because too many electrical consumers are switched on.</p> <p>► Switch off any consumers that are not required, e.g. reading lamps, interior lighting or the seat heating.</p> <p>When the battery is sufficiently charged, the rear window defroster can be activated again.</p>

Activating/deactivating air-recirculation mode

General notes

If you switch on air-recirculation mode, the windows can fog up more quickly, in particular at low temperatures. Only use air-recirculation mode briefly to prevent the windows from fogging up.

Activating/deactivating



- Turn the SmartKey to position **2** in the ignition lock (► page 151).
- **To activate:** press the button. The indicator lamp in the button lights up.
- i** Air-recirculation mode is automatically activated at high levels of pollution or at high outside temperatures. When air-recirculation mode is activated automatically, the indicator lamp in the button is not

lit. Outside air is added after about 30 minutes.

- **To deactivate:** press the button. The indicator lamp in the button goes out.
- i** Air-recirculation mode deactivates automatically:
 - after approximately five minutes at outside temperatures below approximately 41 °F (5 °C)
 - after approximately five minutes if cooling with air dehumidification is deactivated
 - after approximately 30 minutes at outside temperatures above approximately 41 °F (5 °C) if the "Cooling with air dehumidification" function is activated

Activating/deactivating the residual heat function

General notes



The residual heat function is only available on vehicles for Canada.

It is possible to make use of the residual heat of the engine to continue heating the stationary vehicle for up to 30 minutes after the engine has been switched off. The heating time depends on the temperature that has been set.

Activating/deactivating

- ▶ Turn the SmartKey to position **0** in the ignition lock or remove it (▶ page 151).
- ▶ **To activate:** press the **REST** button. The indicator lamp in the **REST** button lights up.
 - ❶ The blower will run at a low speed regardless of the airflow setting.
 - ❷ If you activate the residual heat function at high temperatures, only the ventilation will be activated. The blower runs at medium speed.
- ▶ **To deactivate:** press the **REST** button. The indicator lamp in the **REST** button goes out.

Residual heat is deactivated automatically:

- after approximately 30 minutes
- when the ignition is switched on
- if the battery voltage drops

Setting the air vents

Important safety notes

⚠ WARNING

Very hot or very cold air can flow from the air vents. This could result in burns or frostbite in the immediate vicinity of the air vents. There is a risk of injury.

Make sure that all vehicle occupants always maintain a sufficient distance to the air outlets. If necessary, redirect the airflow to another area of the vehicle interior.

⚠ WARNING

When AIRSCARF is switched on, very hot air can flow from the vents in the head restraints. This could result in burns in the immediate vicinity of the air vents. There is a risk of injury. Reduce the heater output before it becomes too hot.

In order to ensure the direct flow of fresh air through the air vents into the vehicle interior, please observe the following notes:

- keep the air inlet grille on the hood and in the engine compartment on the front-passenger side free of blockages, such as ice, snow or leaves.
- never cover the air vents or air intake grilles in the vehicle interior.
- ❶ You can move the adjusters for the air vents vertically or horizontally to set the direction of the airflow.
- ❷ For optimal climate control in the vehicle, open the air vents completely and set the adjusters to the central position.

Setting the center air vents

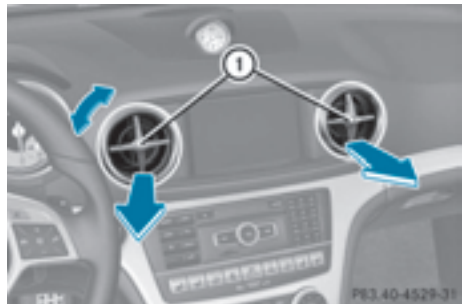

- ▶ **To open the center air vent:** turn the adjuster in one of center air vents ❶ counter-clockwise.
- ▶ **To close the center air vent:** turn the adjuster in one of center air vents ❶ clockwise until it engages.

Setting the side air vents

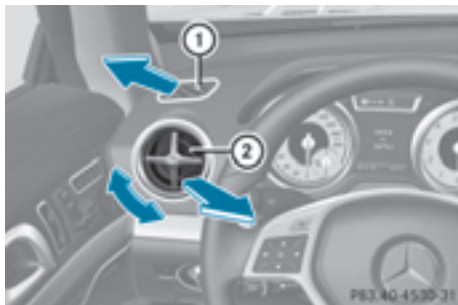

- ① Side window defroster vent
- ② Side air vent

- ▶ **To open a side air vent:** turn the adjuster in side air vent ② counter-clockwise.
- ▶ **To close a side air vent:** turn the adjuster in side air vent ② clockwise until it engages.

Setting the glove box air vent

- ! Close the air vent when heating the vehicle.

At high outside temperatures, open the air vent and activate the "cooling with air dehumidification" function. Otherwise, temperature-sensitive items stored in the glove box could be damaged.

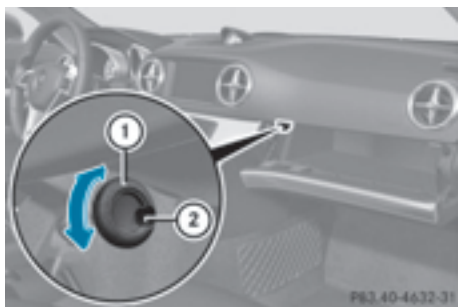

- ① Air vent thumbwheel
- ② Air vent

When automatic climate control is activated, the glove box can be ventilated, for instance to cool its contents. The level of airflow

depends on the airflow and air distribution settings.

- ▶ **To open/close:** turn thumbwheel ① clockwise or counter-clockwise.

Setting the blower output of the AIR-SCARF vents

⚠ WARNING

Very hot or very cold air can flow from the air vents. This could result in burns or frostbite in the immediate vicinity of the air vents. There is a risk of injury.

Make sure that all vehicle occupants always maintain a sufficient distance to the air outlets. If necessary, redirect the airflow to another area of the vehicle interior.

⚠ WARNING

When AIRSCARF is switched on, very hot air can flow from the vents in the head restraints. This could result in burns in the immediate vicinity of the air vents. There is a risk of injury. Reduce the heater output before it becomes too hot.



You can adjust the blower output of AIR-SCARF vents ① using the AIRSCARF button (▷ page 113).

Useful information	150
Notes on breaking-in a new vehicle	150
Driving	150
Automatic transmission	159
Refueling	168
Parking	171
Driving tips	174
Driving systems	180

Useful information

- i** This Operator's manual describes all models and all standard and optional equipment of your vehicle available at the time of publication of the Operator's manual. Country-specific differences are possible. Please note that your vehicle may not be equipped with all features described. This also applies to safety-related systems and functions.
- i** Read the information on qualified specialist workshops (▷ page 35).

Notes on breaking-in a new vehicle

Important safety notes

The sensor system of some driving and driving safety systems adjusts automatically while a certain distance is being driven after the vehicle has been delivered or after repairs. Full system effectiveness is not reached until the end of this teach-in procedure.

New and replaced brake pads and discs only reach their optimum braking effect after several hundred kilometers of driving. Compensate for this by applying greater force to the brake pedal.

The first 1000 miles (1500 km)

The more you look after the engine when it is new, the more satisfied you will be with its performance in the future.

- You should therefore drive at varying vehicle and engine speeds for the first 1,000 miles (1,500 km).
- Avoid heavy loads, e.g. driving at full throttle, during this period.
- Change gear in good time, before the tachometer needle is $\frac{2}{3}$ of the way to the red area of the tachometer.

- Do not manually shift to a lower gear to brake the vehicle.
- Try to avoid depressing the accelerator pedal beyond the point of resistance (kick-down).
- Ideally, for the first 1,000 miles (1,500 km), drive in program **C**.

After 1,000 miles (1,500 km), you can increase the engine speed gradually and bring the vehicle to full speed.

Additional breaking-in notes for AMG vehicles:

- Do not drive faster than 85 mph (140 km/h) for the first 1,000 miles (1,500 km).
 - Only allow the engine to reach a maximum engine speed of 4,500 rpm briefly.
 - Change gear in good time.
- i** You should also observe these notes on breaking in if the engine or parts of the drive train on your vehicle have been replaced.

AMG vehicles with self-locking rear axle differential

Your vehicle is equipped with a self-locking differential on the rear axle. To protect the differential on the rear axle, carry out an oil change after a breaking-in phase of 2,000 miles (3,000 km). This oil change prolongs the service life of the differential. Have the oil change carried out at a qualified specialist workshop. Mercedes-Benz recommends that you use an authorized Mercedes-Benz Center for this purpose.

Driving

Important safety notes

WARNING

Objects in the driver's footwell can restrict the pedal travel or obstruct a depressed pedal. The operating and road safety of the vehicle is jeopardized. There is a risk of an accident.

Make sure that all objects in the vehicle are stowed correctly, and that they cannot enter the driver's footwell. Install the floor mats securely and as specified in order to ensure sufficient clearance for the pedals. Do not use loose floor mats and do not place floor mats on top of one another.

WARNING

Unsuitable footwear can hinder correct usage of the pedals, e.g.:

- shoes with thick soles
- shoes with high heels
- slippers

There is a risk of an accident.

Wear suitable footwear to ensure correct usage of the pedals.

WARNING

If you switch off the ignition while driving, safety-relevant functions are only available with limitations, or not at all. This could affect, for example, the power steering and the brake boosting effect. You will require considerably more effort to steer and brake. There is a risk of an accident.

Do not switch off the ignition while driving.

WARNING

If the parking brake has not been fully released when driving, the parking brake can:

- overheat and cause a fire
- lose its hold function.

There is a risk of fire and an accident. Release the parking brake fully before driving off.

! Warm up the engine quickly. Do not use the engine's full performance until it has reached operating temperature.

Only shift the automatic transmission to the desired drive position when the vehicle is stationary.

Where possible, avoid spinning the drive wheels when pulling away on slippery

roads. You could otherwise damage the drive train.

! **AMG vehicles:** at low engine oil temperatures below 68 °F (+20 °C), the maximum engine speed is restricted in order to protect the engine. To protect the engine and maintain smooth engine operation, avoid driving at full throttle when the engine is cold.

SmartKey positions

SmartKey

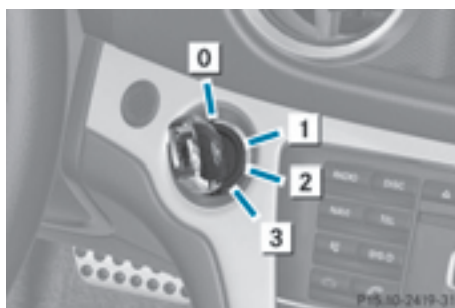

- 0** To remove the SmartKey
 - 1** Power supply for some consumers, such as the windshield wipers
 - 2** Ignition (power supply for all consumers) and drive position
 - 3** To start the engine
- i** The SmartKey can be turned in the ignition lock even if it is not the correct SmartKey for the vehicle. The ignition is not switched on. The engine cannot be started.

KEYLESS-GO

General notes

Vehicles with KEYLESS-GO are equipped with a SmartKey featuring an integrated KEYLESS-GO start function and a detachable Start/Stop button.

The Start/Stop button must be inserted in the ignition lock and the SmartKey must be in the vehicle.

When you insert the Start/Stop button into the ignition lock, the system needs approximately two seconds recognition time. You can then use the Start/Stop button.

Pressing the Start/Stop button several times in succession corresponds to the different key positions in the ignition lock. This is only the case if you are not depressing the brake pedal.

If you depress the brake pedal and press the Start/Stop button, the engine starts immediately.

A check which periodically establishes a radio connection between the vehicle and the SmartKey determines whether a valid SmartKey is in the vehicle. This occurs, for example, when starting the engine.

To start the vehicle without actively using the SmartKey:

- the Start/Stop button must be inserted in the ignition lock.
- the SmartKey must be in the vehicle.
- the vehicle must not be locked with the SmartKey or KEYLESS-GO (▷ page 83).

Do not keep the SmartKey:

- with electronic devices, e.g. a mobile phone or another SmartKey
- with metallic objects, e.g. coins or metal foil
- inside metallic objects, e.g. a metal case

This can impair the functionality of the KEYLESS-GO key.

If you lock the vehicle with the SmartKey's remote control or with KEYLESS-GO, after a short time:

- you will not be able to switch on the ignition with the Start/Stop button.
- you will not be able to start the engine with the Start/Stop button until the vehicle is unlocked again.

i The engine can be turned off while the vehicle is in motion by pressing and holding the Start/Stop button for approximately three seconds. This function operates inde-

pendently of the ECO start/stop automatic engine switch-off function.

Key positions with KEYLESS-GO



- ① Start/Stop button
- ② Ignition lock

As soon as the ignition is switched on, all the indicator lamps in the instrument cluster light up. If an indicator lamp does not go out after starting the engine or lights up while driving, see (▷ page 271).

If Start/Stop button ① has not yet been pressed, this corresponds to the SmartKey being removed from the ignition.

► **To switch on the power supply:** press Start/Stop button ① once.

The power supply is switched on. You can now activate the windshield wipers, for example.

i The power supply is switched off again if:

- the driver's door is opened and
- you press Start/Stop button ① twice when in this position

► **To switch on the ignition:** press Start/Stop button ① twice.

The ignition is switched on.

i The ignition is switched off when:

- the driver's door is opened and
- you press Start/Stop button ① once when in this position



- ③ Start/Stop button USA
- ④ Start/Stop button Canada

Removing the Start/Stop button

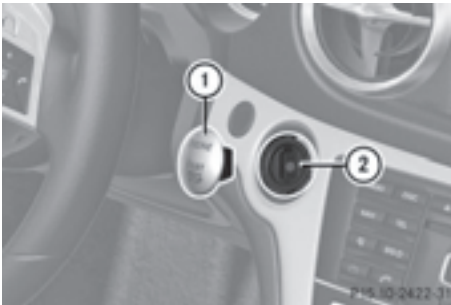

You can remove the Start/Stop button from the ignition lock and start the vehicle as normal using the SmartKey.

- ▶ Remove Start/Stop button ① from ignition lock ②.
- ❗ You do not have to remove the Start/Stop button from the ignition lock when you leave the vehicle. You should, however, always take the SmartKey with you when leaving the vehicle. As long as the SmartKey is in the vehicle:
 - the vehicle can be started using the Start/Stop button
 - electrically powered equipment can be operated.

Starting the engine

Important safety notes

⚠ WARNING

If children are left unsupervised in the vehicle, they could:

- open the doors, thus endangering other people or road users.
- get out and disrupt traffic.
- operate the vehicle's equipment.

Additionally, children could set the vehicle in motion if, for example, they:

- release the parking brake.
- shifting the automatic transmission out of park position **P**
- Start the engine.

There is a risk of an accident and injury.

When leaving the vehicle, always take the SmartKey with you and lock the vehicle. Never leave children or animals unattended in the vehicle. Always keep the SmartKey out of reach of children.

⚠ WARNING

Combustion engines emit poisonous exhaust gases such as carbon monoxide. Inhaling these exhaust gases leads to poisoning. There is a risk of fatal injury. Therefore never leave the engine running in enclosed spaces without sufficient ventilation.

⚠ WARNING

Flammable materials introduced through environmental influence or by animals can ignite if in contact with the exhaust system or parts of the engine that heat up. There is a risk of fire.

Carry out regular checks to make sure that there are no flammable foreign materials in the engine compartment or in the exhaust system.

- ❗ Do not depress the accelerator when starting the engine.

- i** The catalytic converter is preheated for up to 30 seconds after a cold start. During this time, the engine sound may be different.

Starting procedure with the SmartKey

- ▶ Depress the brake pedal and keep it depressed.
- ▶ Shift the transmission to position **P**. The transmission position display in the multifunction display shows **P**.
- i** You can also start the engine when the transmission is in position **N**.
- ▶ Turn the SmartKey to position **3** in the ignition lock (▷ page 151) and release it as soon as the engine is running.

Using KEYLESS-GO to start the engine

The Start/Stop button can be used to start the vehicle without inserting the SmartKey into the ignition lock. The SmartKey must be in the vehicle and the Start/Stop button must be inserted in the ignition lock.

- ▶ Depress the brake pedal and keep it depressed.
- ▶ Shift the transmission to position **P**. The transmission position display in the multifunction display shows **P**.
- i** You can also start the engine when the transmission is in position **N**.
- ▶ Press the Start/Stop button once (▷ page 151). The engine starts.

Pulling away

Automatic transmission

WARNING

If the engine speed is above the idling speed and you engage transmission position **D** or **R**, the vehicle could pull away suddenly. There is a risk of an accident.

When engaging transmission position **D** or **R**, always firmly depress the brake pedal and do not simultaneously accelerate.

- i** It is only possible to shift the transmission from position **P** to the desired position if you depress the brake pedal. Only then is the shift lock released.
- ▶ Depress the brake pedal and keep it depressed.
- ▶ Shift the transmission to position **D** or **R**.
- ▶ Release the electric parking brake (▷ page 172).
- ▶ Release the brake pedal.
- ▶ Carefully depress the accelerator pedal.
- !** If a warning tone sounds and the **Release Park. Brake** message appears in the multifunction display, the parking brake is still applied. Release the parking brake.
- i** The vehicle locks centrally once you have pulled away. The locking knobs in the doors drop down. You can open the doors from the inside at any time. You can also deactivate the automatic locking feature (▷ page 234).
- i** Upshifts take place at higher engine speeds after a cold start. This helps the catalytic converter to reach its operating temperature more quickly.

Hill start assist

Hill start assist helps you when pulling away forwards or in reverse on an uphill gradient. It holds the vehicle for a short time after you have removed your foot from the brake pedal. This gives you enough time to move your foot from the brake pedal to the accelerator pedal and to depress it before the vehicle begins to roll.

⚠ WARNING

After a short time, hill start assist will no longer brake your vehicle and it could roll away. There is a risk of an accident and injury.

Therefore, quickly move your foot from the brake pedal to the accelerator pedal. Never leave the vehicle when it is held by hill start assist.

- ▶ Remove your foot from the brake pedal. The vehicle is then held for about a second.
- ▶ Pull away.

Hill start assist is not active if:

- you are pulling away on a level road or on a downhill gradient.
- the transmission is in position **N**.
- the electric parking brake is applied.
- ESP® is malfunctioning.

ECO start/stop function**Introduction**

The ECO start/stop function switches the engine off automatically if the vehicle is stopped under certain conditions.

The engine starts automatically when the driver wants to pull away again. The ECO start/stop function thereby helps you to reduce the fuel consumption and emissions of your vehicle.

Important safety notes**⚠ WARNING**

If the engine is switched off automatically and you exit the vehicle, the engine is restarted automatically. The vehicle may begin moving. There is a risk of accident and injury.

If you wish to exit the vehicle, always turn off the ignition and secure the vehicle against rolling away.

General notes**① ECO start/stop display**

If the engine has been switched off automatically by the ECO start/stop function, the  ECO symbol is shown in the multifunction display.

Every time you switch on the engine using the SmartKey or the Start/Stop button, the ECO start/stop function is activated.

AMG vehicles: the ECO start/stop function is only available in drive program **C**.

For further information on automatic engine switch-off (▷ page 155) and automatic engine start (▷ page 156).

Automatic engine switch-off

If the vehicle is braked to a standstill in **D** or **N**, the ECO start/stop function switches off the engine automatically.

The ECO start/stop function is operational when:

- the indicator lamp in the ECO button is lit green.
- the outside temperature is within the range that is suitable for the system.
- the engine is at normal operating temperature.
- the set temperature for the vehicle interior has been reached.
- the battery is sufficiently charged.
- the system detects that the windshield is not fogged up when the air-conditioning system is switched on.
- the hood is closed.
- the driver's door is closed and the driver's seat belt is fastened.

i All of the vehicle's systems remain active when the engine is stopped automatically.

i All vehicles (apart from AMG vehicles): automatic engine switch-off can take place a maximum of four times consecutively (initial stop then repeated three times).

i AMG vehicles: times which the engine can be automatically switched off.

i The HOLD function can be activated if the engine has been switched off automatically. It is then not necessary to continue applying the brakes during the automatic stop phase. When you depress the accelerator pedal, the engine starts automatically and the braking effect of the HOLD function is deactivated.

Automatic engine start

The engine starts automatically if:

- you switch off the ECO start/stop function by pressing the ECO button.
 - in transmission position **D** or **N** the brake pedal is released and the HOLD function is not active.
 - you depress the accelerator pedal.
 - you engage reverse gear **R**.
 - you move the transmission out of position **P**.
 - you switch to drive program **S**, **S+** or **M** (AMG vehicles).
 - you unfasten your seat belt or open the driver's door.
 - the vehicle starts to roll.
 - the brake system requires this.
 - the temperature in the vehicle interior deviates from the set range.
 - the system detects moisture on the windshield when the air-conditioning system is switched on.
 - the battery's condition of charge is too low.
- i** Shifting the transmission to position **P** does not start the engine.

Deactivating/activating the ECO start/stop function

All vehicles (except AMG vehicles)



► **To deactivate:** press ECO button ①. Indicator lamp ② goes out.

► **To activate:** press ECO button ①. Indicator lamp ② lights up.

If the indicator lamp on the ECO button is off, the ECO start/stop function has been deactivated manually or as the result of a malfunction.

AMG vehicles



► **To switch off:** in drive program **C**, press ECO button ①.

or

► Switch to drive program **S**, **S+** or **M** (▷ page 163). Indicator lamp ② goes out.

► **To activate:** press ECO button ①. Indicator lamp ② lights up.

If drive program **S**, **S+** or **M** is active, the automatic transmission switches to drive program **C**.

If the indicator lamp on the ECO button is off, the ECO start/stop function has been deactivated manually or as the result of a malfunction.

Problems with the engine

Problem	Possible causes/consequences and ► Solutions
The engine does not start.	<p>The HOLD function is activated.</p> <ul style="list-style-type: none"> ► Deactivate the HOLD function (▷ page 191). ► Try to start the engine again.
The engine does not start. The starter motor can be heard.	<ul style="list-style-type: none"> • There is a malfunction in the engine electronics. • There is a malfunction in the fuel supply. <p>► Turn the SmartKey back to position 0 in the ignition lock before attempting to start the engine again.</p> <p>or</p> <ul style="list-style-type: none"> ► Press the Start/Stop button repeatedly until all indicator lamps in the instrument cluster go out. ► Try to start the engine again (▷ page 153). Avoid excessively long and frequent attempts to start the engine as these will drain the battery. <p>If the engine does not start after several attempts:</p> <ul style="list-style-type: none"> ► Consult a qualified specialist workshop.
The engine does not start. You cannot hear the starter motor.	<p>The on-board voltage is too low because the battery is too weak or discharged.</p> <ul style="list-style-type: none"> ► Jump-start the vehicle (▷ page 557). <p>If the engine does not start despite attempts to jump-start it:</p> <ul style="list-style-type: none"> ► Consult a qualified specialist workshop. <hr/> <p>The starter motor was exposed to a thermal load that was too high.</p> <ul style="list-style-type: none"> ► Allow the starter motor to cool down for approximately two minutes. ► Try to start the engine again. <p>If the engine still does not start:</p> <ul style="list-style-type: none"> ► Consult a qualified specialist workshop.
The engine is not running smoothly and is misfiring.	<p>There is a malfunction in the engine electronics or in a mechanical component of the engine management system.</p> <ul style="list-style-type: none"> ► Only depress the accelerator pedal slightly. Otherwise, non-combusted fuel may get into the catalytic converter and damage it. ► Have the cause rectified immediately at a qualified specialist workshop.

Problem	Possible causes/consequences and ► Solutions
<p>The coolant temperature gauge shows a value above 248 °F (120 °C). The coolant warning lamp may also be on and a warning tone may sound.</p>	<p>The coolant level is too low. The coolant is too hot and the engine is no longer being cooled sufficiently.</p> <ul style="list-style-type: none"> ► Stop as soon as possible and allow the engine and the coolant to cool down. ► Check the coolant level (► page 537). Observe the warning notes as you do so and add coolant if necessary.
	<p>If the coolant level is correct, the engine radiator fan may be faulty. The coolant is too hot and the engine is no longer being cooled sufficiently.</p> <ul style="list-style-type: none"> ► At coolant temperatures below 248 °F (120 °C), drive to the nearest qualified specialist workshop. ► Avoid heavy loads on the engine as you do so, e.g. driving in mountainous terrain and start/stop traffic.

Automatic transmission

Important safety notes

WARNING

If the engine speed is above the idling speed and you engage transmission position **D** or **R**, the vehicle could pull away suddenly. There is a risk of an accident.

When engaging transmission position **D** or **R**, always firmly depress the brake pedal and do not simultaneously accelerate.

WARNING

The automatic transmission switches to neutral position **N** when you switch off the engine. The vehicle may roll away. There is a risk of an accident.

After switching off the engine, always switch to parking position **P**. Prevent the parked vehicle from rolling away by applying the parking brake.

Selector lever

Overview of transmission positions



! If the engine speed is too high or if the vehicle is rolling, do not shift the transmission directly from **D** to **R**, from **R** to **D** or directly to **P**.

Do not open the driver's door while the vehicle is in motion. At low speeds in transmission position **D** or **R**, park position **P** is otherwise engaged automatically.

The transmission could be damaged.



Selector lever

-  Park position
-  Reverse gear

- N** Neutral
- D** Drive

When you select a transmission position, the selector lever subsequently returns to its original position.

The current transmission position **P**, **R**, **N** or **D** appears in the transmission position display in the multifunction display.

Engaging park position **P**

- ▶ When the vehicle is stationary, depress the brake pedal.
- ▶ Press the **P** button in the center console.

i Park position **P** is disengaged if you:

- depress the brake pedal and
- push the selector lever forwards or back to the first point of resistance.

The transmission shifts to neutral **N**.

Park position **P** is engaged automatically and the electric parking brake applied:

- if you remove the SmartKey from the ignition lock
- if you switch off the engine using the Start/Stop button and open the driver's or front-passenger door
- if you open the driver's door while traveling at low speed in transmission position **D** or **R**
- when HOLD (▷ page 191) or DISTRONIC PLUS (▷ page 182) brakes your vehicle until it is stationary and at least one of the following conditions is fulfilled:
 - the engine is switched off.
 - the driver's door is open and the seat belt is not fastened.
 - there is a system malfunction.
 - the power supply is insufficient.

Engaging reverse gear **R**

- !** Only shift the automatic transmission to **R** when the vehicle is stationary.

- ▶ When the vehicle is stationary, depress the brake pedal.
- ▶ Push the selector lever forwards past the first point of resistance.

i When reverse gear is engaged and the ECO start/stop function is switched on, the engine starts up automatically (▷ page 156).

Shifting to neutral **N**

- ▶ When the vehicle is stationary, depress the brake pedal.
- ▶ Push the selector lever forwards or back to the first point of resistance.

i If the vehicle is braked to a standstill when in neutral **N** and the brake pedal continues to be depressed, the ECO start/stop function switches the engine off automatically (▷ page 155).

Remaining in neutral **N**

WARNING

If children are left unsupervised in the vehicle, they could:

- open the doors, thus endangering other people or road users.
- get out and disrupt traffic.
- operate the vehicle's equipment.

Additionally, children could set the vehicle in motion if, for example, they:

- release the parking brake.
- shifting the automatic transmission out of park position **P**
- Start the engine.

There is a risk of an accident and injury.

When leaving the vehicle, always take the SmartKey with you and lock the vehicle. Never leave children or animals unattended in the vehicle. Always keep the SmartKey out of reach of children.

Using the SmartKey:

- Make sure that the ignition is switched on.
- When the vehicle is stationary, depress the brake pedal and keep it depressed.
- Shift to neutral **N**.
- Release the brake pedal.
- If the electric parking brake is engaged, release it.
- Switch off the ignition and leave the SmartKey in the ignition lock.

Using KEYLESS-GO:

- Make sure that the ignition is switched on.
- When the vehicle is stationary, depress the brake pedal and keep it depressed.
- Engage park position **P**.
- Release the brake pedal.
- Remove the Start/Stop button from the ignition lock.
- Insert the SmartKey into the ignition lock.
- Switch on the ignition.
- Depress the brake pedal and keep it depressed.
- Shift to neutral **N**.
- Release the brake pedal.
- If the electric parking brake is engaged, release it.
- Switch off the ignition and leave the SmartKey in the ignition lock.

Shifting to transmission position D

- ▶ When the vehicle is stationary, depress the brake pedal.
- ▶ Push the selector lever back past the first point of resistance.

i If the vehicle is braked to a standstill when in transmission position **D** (▷ page 155) and the brake pedal continues to be depressed, the ECO start/stop function switches the engine off automatically.

Transmission position and drive program display**Display in transmission positions P, R and N**

- ① Transmission position: currently selected transmission position will be highlighted
- ② Drive program (**E/S/M**)

AMG vehicles: in addition to drive program ② being shown in the multifunction display, the currently selected drive program is indicated in red on the drive program selector (▷ page 163).

Display when in transmission position D

- ① Transmission position
- ② Gear
- ③ Drive program (**E/S**)

When you have selected drive program **E** or **S**, the transmission position is displayed in position ①. The selected gear is displayed in position ②.

Display when in transmission position D and drive program M



- ① Gear
- ② Drive program (M)

Transmission positions

P Park position

Do not shift the transmission into position **P** (▷ page 159) unless the vehicle is stationary. The parking lock should not be used as a brake when parking. Always apply the electronic parking brake in addition to the parking lock in order to secure the vehicle.

If the SmartKey is removed from the ignition lock, the transmission is locked.

The automatic transmission shifts into **P** automatically:

- when the SmartKey is removed from the ignition lock
- when the engine is switched off with the transmission in position **R** or **D** and one of the doors is opened

If the vehicle electronics are malfunctioning, the transmission may be locked in position **P**.

Have the vehicle electronics checked immediately at a qualified specialist workshop, e.g. an authorized Mercedes-Benz Center.

R Reverse gear

Only shift the transmission to **R** when the vehicle is stationary.

N Neutral

Do not shift the transmission to **N** while driving. Otherwise, the automatic transmission could be damaged.

No power is transmitted from the engine to the drive wheels.

Releasing the brake pedal will allow you to move the vehicle freely, e.g. to push it or tow it.

If ESP® is deactivated or faulty: only shift the transmission to position **N** if the vehicle is in danger of skidding, e.g. on icy roads.

! Rolling in neutral **N** can damage the drive train.

D Drive

The automatic transmission changes gear automatically. All forward gears are available.

Driving tips

Changing gear

The automatic transmission shifts to the individual gears automatically when it is in transmission position **D**. This automatic gear shifting behavior is determined by:

- the selected drive program (▷ page 163)
- the position of the accelerator pedal (▷ page 162)
- the road speed

Accelerator pedal position

Your style of driving influences how the automatic transmission shifts gear:

- little throttle: early upshifts
- more throttle: late upshifts

Double-clutch function

When shifting down, the double-clutch function is active regardless of the currently selected drive program. The double-clutch function reduces load change reactions and is conducive to a sporty driving style. The sound generated by the double-clutch function depends on the drive program selected.

Kickdown

Use kickdown for maximum acceleration.

- ▶ Depress the accelerator pedal beyond the pressure point.
The automatic transmission shifts to a lower gear depending on the engine speed.
- ▶ Ease off the accelerator pedal once the desired speed is reached.
The automatic transmission shifts back up.

Program selector button

Selecting drive program



Program selector button

Program selector button ① allows you to choose between different driving characteristics.

- ▶ Press program selector button ① repeatedly until the letter for the desired gearshift program appears in the multifunction display in the speedometer.

- **E** Economy: comfortable, economical driving
- **S** Sport: sporty driving style
- **M** Manual: manual gearshifting

- ① Further information about permanent drive program **M** (> page 166).
As well as this permanent drive program **M**, you can also activate temporary drive program **M** (> page 165).
- ① The automatic transmission shifts to automatic drive program **E** each time the engine is started.
- ① Further information on the "Automatic drive program" (> page 164).

Drive program for AMG vehicles



With the drive program selector switch, you can choose from a range of different transmission configurations or select the RACE START drive mode.

- ▶ Turn drive program selector ① until the desired drive program appears in the multifunction display.
The drive program indicator on the drive program selector lights up red.
- **C** Controlled Efficiency: comfortable engine and transmission design that provides for optimum fuel consumption
- **S** Sport: sporty engine and transmission settings
- **S+** SportPlus: extremely sporty engine and transmission settings

- **M Manual**: manual gearshifting
- **RS driving mode RACE START**: optimum acceleration dynamics from a standstill (SL 63 AMG only)

i Further information about permanent drive program **M** (▷ page 166).

As well as this permanent drive program **M**, you can also activate temporary drive program **M** (▷ page 165).

i The automatic transmission shifts to automatic drive program **C** each time the engine is started.

i **RS** cannot be selected during normal driving. For further information on RACE START, see (▷ page 192).

AMG button (SETUP)

You can save and call up the following pre-settings with the AMG button:

- Drive program (▷ page 163)
- Suspension tuning



- ▶ **To store**: press and hold AMG button **1** until you hear a tone.
- ▶ **To call up**: press AMG button **1**. The stored drive program is selected.
- ▶ **To display**: briefly press AMG button **1**. The multifunction display shows the SETUP in the AMG menu (▷ page 236).

Steering wheel paddle shifters



- 1** Left-hand steering wheel paddle shifter
- 2** Right-hand steering wheel paddle shifter

In the manual drive program, you can change gear yourself by using the steering wheel paddle shifters (▷ page 165).

Further information about permanent drive program **M** (▷ page 166).

Further information about temporary drive program **M** (▷ page 165).

i The full range of functions for the steering wheel paddle shifters is available only once operating temperature has been reached.

i You can only change gear with the steering wheel paddle shifters when the transmission is in position **D**.

Automatic drive program

Automatic drive programs E and S

Drive program **E** is characterized by the following:

- comfort-oriented engine and transmission settings
- optimal fuel consumption resulting from the automatic transmission shifting up sooner
- the vehicle pulling away more gently in forward and reverse gears, unless the accelerator pedal is depressed fully

- increased sensitivity. This improves driving stability on slippery road surfaces, for example
- the automatic transmission shifting up sooner. This results in the vehicle being driven at lower engine speeds and the wheels being less likely to spin

Drive program **S** is characterized by the following:

- sporty engine and transmission settings
- the vehicle pulling away in first gear
- the automatic transmission shifting up later
- the fuel consumption possibly being higher as a result of the later automatic transmission shift points

Manual drive program M

General notes

In this drive program, you can briefly change gear yourself by using the steering wheel paddle shifters. The transmission must be in position **D**.

You can activate manual drive program **M** in the **E** and **S** automatic drive programs.

- ❗ As well as temporary drive program **M**, you can also activate permanent drive program **M** (▷ page 163).

Further information about permanent drive program **M** (▷ page 166).

Activating

- ▶ Shift the transmission to position **D**.
- ▶ Pull the left or right steering wheel paddle shifter (▷ page 164).
Manual drive program **M** is temporarily activated. The selected gear and **M** appear in the multifunction display.

Shifting gears

If you pull on the left or right steering wheel paddle shifter, the automatic transmission switches to manual drive program **M** for a limited amount of time. Depending on which

paddle shifter is pulled, the automatic transmission immediately shifts into the next gear down or up, if permitted.

- ▶ **To shift up:** pull the right-hand steering wheel paddle shifter (▷ page 164).
The automatic transmission shifts up to the next gear.

- ❗ If the maximum engine speed on the currently engaged gear is reached and you continue to accelerate, the automatic transmission automatically shifts up in order to prevent engine damage.

- ▶ **To shift down:** pull on the left-hand steering wheel paddle shifter (▷ page 164).
The automatic transmission shifts down to the next gear.

- ❗ If the engine exceeds the maximum engine speed when shifting down, the automatic transmission protects against engine damage by not shifting down.

- ❗ Automatic down shifting occurs when coasting.

Shift recommendation



The gearshift recommendations assist you in adopting an economical driving style. The recommended gear is shown in the multifunction display.

- ▶ Shift to recommended gear ② according to gearshift recommendation ① when shown in the multifunction display of the instrument cluster.

Deactivating

If you have activated manual drive program **M**, it will remain active for a certain amount of time. Under certain conditions the minimum amount of time is extended, e.g. in the case of

lateral acceleration, during an overrun phase or when driving on steep terrain.

If manual drive program **M** has been deactivated, the automatic transmission shifts into the automatic drive program that was last selected, i.e. **E** or **S**.

You can also deactivate manual drive program **M** yourself:

- ▶ Pull on the right-hand steering wheel paddle shifter and hold it in place (▷ page 164).

or

- ▶ Use the lever to switch the transmission position.

or

- ▶ Use the program selector button to change the drive program (▷ page 163).

Manual drive program **M** is deactivated.

The automatic transmission switches into the automatic drive program that was last selected, i.e. **E** or **S**.

Manual drive program

General information

In this drive program, you can permanently change gear yourself by using the steering wheel paddle shifters. The transmission must be in position **D**.

i As well as this permanent drive program **M**, you can also activate temporary drive program **M** (▷ page 165).

Switching on the manual drive program

Manual drive program **M** is different from drive program **S** with regard to spontaneity, responsiveness and smoothness of gear changes.

You can select manual drive program **M** with the program selector button or the drive program selector (**AMG vehicles**). In manual drive program **M**, you can change gear using the steering wheel paddle shifters if the trans-

mission is in position **D**. The selected gear appears in the multifunction display.

- ▶ Press the program selector button repeatedly until **M** (▷ page 163) appears in the multifunction display.

- ▶ **AMG vehicles:** turn the drive program selector until **M** (▷ page 163) appears in the multifunction display.

Upshifting

- ▶ Pull the right-hand steering wheel paddle shifter (▷ page 164).

The automatic transmission shifts up to the next gear.

Before the engine speed reaches the red area, an upshift indicator will be shown in the multifunction display.

Shift recommendation



The gearshift recommendations assist you in adopting an economical driving style. The recommended gear is shown in the multifunction display.

- ▶ Shift to recommended gear ② according to gearshift recommendation ① when shown in the multifunction display of the instrument cluster.

AMG vehicles

! In manual drive program **M**, the automatic transmission does not shift up automatically even when the engine limiting speed for the current gear is reached. When the engine limiting speed is reached, the fuel supply is cut to prevent the engine from overrevving. Always make sure that the engine speed does not reach the red area of

the tachometer. There is otherwise a risk of engine damage.

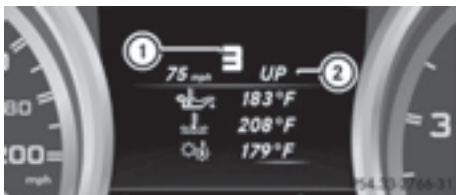

- ① Gear indicator
- ② Upshift indicator

Before the engine speed reaches the red area, an upshift indicator will be shown in the multifunction display.

- ▶ If the color in the speedometer multifunction display changes to red and the **UP** display message is shown, shift up a gear.

Downshifting

- ▶ Pull the left-hand steering wheel paddle shifter (▷ page 164).
The automatic transmission shifts down to the next gear.

Maximum acceleration

- ▶ Pull the left-hand steering wheel paddle shifter until the transmission selects the optimum gear according to the speed.
- i** If you brake the vehicle or stop without shifting down, the automatic transmission will shift down to a gear that will allow the vehicle to accelerate or pull away again.

Kickdown

You can also use kickdown for maximum acceleration in manual drive program **M**.

- ▶ Depress the accelerator pedal beyond the pressure point.
The automatic transmission shifts to a lower gear depending on the engine speed.
- i** **AMG vehicles:** it is not possible to use kickdown in manual drive program **M**.

Switching off the manual drive program

- ▶ Press the program selector button repeatedly until **E** or **S** appears in the multifunction display (▷ page 163).
- ▶ **AMG vehicles:** turn the drive program selector until **C**, **S** or **S+** (▷ page 163) appears in the multifunction display.

Problems with the transmission

Problem	Possible causes/consequences and ► Solutions
The transmission has problems shifting gear.	The transmission is losing oil. ► Have the transmission checked at a qualified specialist workshop immediately.
The acceleration ability is deteriorating. The transmission no longer changes gear.	The transmission is in emergency mode. It is only possible to shift into second gear and reverse gear. ► Stop the vehicle. ► Shift the transmission to position P . ► Switch off the engine. ► Wait at least ten seconds before restarting the engine. ► Shift the transmission to position D or R . If D is selected, the transmission shifts into second gear; if R is selected, the transmission shifts into reverse gear. ► Have the transmission checked at a qualified specialist workshop, e.g. an authorized Mercedes-Benz Center, immediately.

Refueling

Important safety notes

WARNING

Fuel is highly flammable. If you handle fuel incorrectly, there is a risk of fire and explosion.

You must avoid fire, open flames, creating sparks and smoking. Switch off the engine and, if applicable, the auxiliary heating before refueling.

WARNING

Fuel is poisonous and hazardous to health. There is a risk of injury.

You must make sure that fuel does not come into contact with your skin, eyes or clothing and that it is not swallowed. Do not inhale fuel vapors. Keep fuel away from children.

If you or others come into contact with fuel, observe the following:

- Wash away fuel from skin immediately using soap and water.
- If fuel comes into contact with your eyes, immediately rinse them thoroughly with clean water. Seek medical assistance without delay.
- If fuel is swallowed, seek medical assistance without delay. Do not induce vomiting.
- Immediately change out of clothing which has come into contact with fuel.

WARNING

Electrostatic buildup can create sparks and ignite fuel vapors. There is a risk of fire and explosion.

Always touch the vehicle body before opening the fuel filler flap or touching the fuel pump nozzle. Any existing electrostatic buildup is thereby discharged.

! Do not use diesel to refuel vehicles with a gasoline engine. Do not switch on the ignition if you accidentally refuel with the wrong fuel. Otherwise, the fuel will enter the fuel system. Even small amounts of the wrong fuel could result in damage to the fuel system and the engine. Notify a qualified specialist workshop and have the fuel tank and fuel lines drained completely.

! Overfilling the fuel tank could damage the fuel system.

! Take care not to spill any fuel on painted surfaces. You could otherwise damage the paintwork.

! Use a filter when refueling from a fuel can. Otherwise, the fuel lines and/or injection system could be blocked by particles from the fuel can.

Do not get into the vehicle again during the refueling process. Otherwise, electrostatic charge could build up again.

If you overfill the fuel tank, fuel could spray out when the fuel pump nozzle is removed.

For further information on fuel and fuel quality (▷ page 602).

Refueling

General information

The fuel filler flap is unlocked or locked automatically when you open or close the vehicle with the SmartKey or with KEYLESS-GO.

The position of the fuel filler cap is displayed  in the instrument cluster. The arrow next to the filling pump indicates the side of the vehicle.

Opening the fuel filler flap



- ① To open the fuel filler flap
 - ② To insert the fuel filler cap
 - ③ Tire pressure table
 - ④ Fuel type to be used
- ▶ Switch the engine off.
 - ▶ Remove the SmartKey from the ignition lock.
 - ▶ Press the fuel filler flap in the direction of arrow ①.
The fuel filler flap swings up.
 - ▶ Turn the fuel filler flap counter-clockwise and remove it.
 - ▶ Insert the fuel filler cap into the holder bracket on the inside of fuel filler flap ②.
 - ▶ Completely insert the filler neck of the fuel pump nozzle into the tank, hook in place and refuel.
 - ▶ Only fill the tank until the pump nozzle switches off.
 - i** Do not add any more fuel after the pump stops filling for the first time. Otherwise, fuel may leak out.

Closing the fuel filler flap

- ▶ Place fuel filler cap on the fuel filler neck and turn clockwise until it engages.
- ▶ Close the fuel filler flap.
- i** Close the fuel filler flap before locking the vehicle.
- i** If you are driving with the fuel filler cap open, the  reserve fuel warning lamp

flashes. The  Check Engine warning lamp may also light up. A message appears in the multifunction display (▷ page 256).

For further information on warning and indicator lamps in the instrument cluster, see (▷ page 277).

Problems with fuel and the fuel tank

This section provides descriptions of and solutions to safety-relevant problems. Descriptions of and solutions to further problems can be found in the Digital Operator's Manual.

Problem	Possible causes/consequences and ► Solutions
Fuel is leaking from the vehicle.	<p>The fuel line or the fuel tank is faulty.</p> <p> WARNING</p> <p>Risk of explosion or fire.</p> <ul style="list-style-type: none"> ► Turn the SmartKey to position 0 in the ignition lock and remove it immediately (> page 151). ► Do not restart the engine under any circumstances. ► Consult a qualified specialist workshop.

Parking

Important safety notes

 **WARNING**

Flammable material such as leaves, grass or twigs may ignite if they come into contact with hot parts of the exhaust system or exhaust gas flow. There is a risk of fire.

Park the vehicle so that no flammable materials come into contact with parts of the vehicle which are hot. Take particular care not to park on dry grassland or harvested grain fields.

 **WARNING**

If you switch off the ignition while driving, safety-relevant functions are only available with limitations, or not at all. This could affect, for example, the power steering and the brake boosting effect. You will require considerably more effort to steer and brake. There is a risk of an accident.

Do not switch off the ignition while driving.

 **WARNING**

If you leave children unsupervised in the vehicle, they could set it in motion by, for example:

- release the parking brake.
- shift the automatic transmission out of the parking position **P**.
- start the engine.

In addition, they may operate vehicle equipment and become trapped. There is a risk of an accident and injury.

When leaving the vehicle, always take the SmartKey with you and lock the vehicle. Never leave children unsupervised in the vehicle.

 Always secure the vehicle correctly against rolling away. Otherwise, the vehicle or its drivetrain could be damaged.

To ensure that the vehicle is secured against rolling away unintentionally:

- the electric parking brake must be applied.
- the transmission must be in position **P** and the SmartKey must be removed from the ignition lock.
- the front wheels must be turned towards the curb on steep uphill or downhill gradients.

Switching off the engine

Important safety notes

WARNING

The automatic transmission switches to neutral position **N** when you switch off the engine. The vehicle may roll away. There is a risk of an accident.

After switching off the engine, always switch to parking position **P**. Prevent the parked vehicle from rolling away by applying the parking brake.

Vehicles with automatic transmission

- ▶ **Vehicles with a SmartKey:** move the transmission to position **P**.
- ▶ Turn the SmartKey to position **0** in the ignition lock and remove it.
The immobilizer is activated.
- ▶ **Vehicles with KEYLESS-GO:** press the Start/Stop button (▷ page 151).
The engine stops and all the indicator lamps in the instrument cluster go out.
When the driver's door is closed, this corresponds to key position **1**. When the driver's door is open, this corresponds to key position **0** (▷ page 151).

If you try to switch off the engine when the transmission is not in position **P**, a message appears in the multifunction display. A signal sounds.

-  The engine can be turned off while the vehicle is in motion by pressing and holding the Start/Stop button for about three seconds. This function operates independently of the ECO start/stop automatic engine switch-off function.

Electric parking brake

General notes

WARNING

If you leave children unsupervised in the vehicle, they could set it in motion by, for example:

- release the parking brake.
- shift the automatic transmission out of the parking position **P**.
- start the engine.

In addition, they may operate vehicle equipment and become trapped. There is a risk of an accident and injury.

When leaving the vehicle, always take the SmartKey with you and lock the vehicle. Never leave children unsupervised in the vehicle.

The function of the electric parking brake is dependent on the on-board voltage. If the on-board voltage is low or there is a malfunction in the system, it may not be possible to apply the released parking brake.

- ▶ If this is the case, only park the vehicle on level ground and secure it to prevent it rolling away.
- ▶ Shift the automatic transmission to position **P**.

It may not be possible to release an applied parking brake if the on-board voltage is low or there is a malfunction in the system. Contact a qualified specialist workshop.

-  The electric parking brake performs a function test at regular intervals while the engine is switched off. The sounds that can be heard while this is occurring are normal.

Applying/releasing manually



► To engage: push handle ①.

When the electric parking brake is engaged, the **PARK** (USA only) or **(P)** (Canada only) red indicator lamp lights up in the instrument cluster.

i The electric parking brake can also be applied when the SmartKey is removed.

► To release: switch on the ignition.

► Pull handle ①.

The red **PARK** (USA only) or **(P)** (Canada only) indicator lamp in the instrument cluster goes out.

i The electric parking brake can only be released:

- if the SmartKey is in position **1** in the ignition lock (▷ page 151) or
- if the ignition was switched on using the Start/Stop button.

Applying automatically

The electric parking brake is applied automatically:

- if DISTRONIC PLUS brings the vehicle to a standstill or
- if the HOLD function is keeping the vehicle stationary

In addition, at least one of the following conditions must be fulfilled:

- the engine is switched off, unless it is automatically switched off by the ECO start/stop function.
- the driver's seat belt is not inserted in the belt buckle and the driver's door is open.
- the vehicle is stationary for a lengthy period.

The red **PARK** (USA only) or **(P)** (Canada only) indicator lamp in the instrument cluster lights up.

Releasing automatically

The electric parking brake is released automatically when all of the following conditions are fulfilled:

- the engine is running.
- the transmission is in position **D** or **R**.
- the driver's seat belt is fastened.
- you depress the accelerator pedal.

If the transmission is in position **R**, the trunk lid must be closed.

If your seat belt is not fastened, the following conditions must be fulfilled to automatically release the electric parking brake:

- the driver's door is closed.
- you have shifted out of **P** or you have previously driven faster than 2 mph (3 km/h).

Ensure that you do not depress the accelerator pedal unintentionally. Otherwise the parking brake will be released and the vehicle will start to move.



Emergency braking

The vehicle can also be braked during an emergency by using the electric parking brake.

► While driving, push handle ① of the electric parking brake.

i The vehicle is braked for as long as the handle of the electric parking brake is pressed. The longer the electric parking brake handle is depressed, the greater the braking force.

During braking:

- a warning tone sounds
- the **Please Release Parking Brake** message appears
- the red  (USA only) or  (Canada only) indicator lamp in the instrument cluster flashes

When the vehicle has been braked to a standstill, the electric parking brake is engaged.

Parking the vehicle for a long period

If you leave the vehicle parked for longer than four weeks, the battery may be damaged by exhaustive discharging.

► Connecting a trickle charger.

-  You can obtain information about trickle chargers from a qualified specialist workshop.

If you leave the vehicle parked for longer than six weeks, the vehicle may suffer damage as a result of lack of use.

► Visit a qualified specialist workshop and seek advice.

Driving tips

General notes

Important safety notes

WARNING

If you switch off the ignition while driving, safety-relevant functions are only available with limitations, or not at all. This could affect, for example, the power steering and the brake boosting effect. You will require considerably more effort to steer and brake. There is a risk of an accident.

Do not switch off the ignition while driving.

WARNING

If you operate mobile communication equipment while driving, you will be distracted from

traffic conditions. You could also lose control of the vehicle. There is a risk of an accident.

Only operate this equipment when the vehicle is stationary.

Observe the legal requirements for the country in which you are driving. Some jurisdictions prohibit the driver from using a mobile phone while driving a vehicle.

If you make a call while driving, always use hands-free mode. Only operate the telephone when the traffic situation permits. If you are unsure, pull over to a safe location and stop before operating the telephone.

Bear in mind that at a speed of only 30 mph (approximately 50 km/h), the vehicle covers a distance of 44 ft (approximately 14 m) per second.

Drive sensibly – save fuel

Observe the following tips to save fuel:

- The tires should always be inflated to the recommended tire pressure.
- Remove unnecessary loads.
- Warm up the engine at low engine speeds.
- Avoid frequent acceleration or braking.
- Observe the service intervals in the Maintenance Booklet or in the service interval display. Have all the maintenance work carried in accordance with Daimler AG regulations.

Fuel consumption also increases when driving in cold weather, in stop-start traffic and in hilly terrain.

Drinking and driving

WARNING

Drinking and driving and/or taking drugs and driving are very dangerous combinations. Even a small amount of alcohol or drugs can affect your reflexes, perceptions and judgment.

The possibility of a serious or even fatal accident is greatly increased when you drink or take drugs and drive.

Do not drink or take drugs and drive or allow anyone to drive who has been drinking or taking drugs.

Emission control

WARNING

Combustion engines emit poisonous exhaust gases such as carbon monoxide. Inhaling these exhaust gases leads to poisoning. There is a risk of fatal injury. Therefore never leave the engine running in enclosed spaces without sufficient ventilation.

Certain engine systems are designed to keep the level of poisonous components in exhaust fumes within legal limits.

These systems only work at peak efficiency if they are serviced exactly in accordance with the manufacturer's specifications. All work on the engine must be carried out only by qualified and authorized Mercedes-Benz technicians.

The engine settings must not be changed under any circumstances. Furthermore, all specific service work must be carried out at regular intervals and in accordance with the Mercedes-Benz service requirements. Details can be found in the Maintenance Booklet.

ECO display



Example: ECO display

The ECO display provides feedback on how economical your driving characteristics are. The ECO display assists you in achieving the

most economical driving style for the selected settings and prevailing conditions. Your driving style can significantly influence the vehicle's consumption.

The ECO display consists of three bars:

- **Acceleration**
- **Constant**
- **Coasting**

The percent value is the average value of the three bars. The three bars and the mean value begin at the value of 50 %. A higher percentage indicates a more economical driving style.

The ECO display does not indicate the actual fuel consumption. A fixed percentage count in the ECO display does not indicate a fixed consumption.

Apart from driving style, consumption is dependent on many factors such as, e.g.:

- load
- tire pressure
- cold start
- choice of route
- electrical consumers switched on

These factors are not included in the ECO display.

The evaluation of your driving style is carried out using the following three categories:

- **Acceleration** (evaluation of all acceleration processes):
 - The bar fills up: moderate acceleration, especially at higher speeds
 - The bar empties: sporty acceleration
- **Constant** (assessment of driving behavior at all times):
 - The bar fills up: constant speed and avoidance of unnecessary acceleration and deceleration
 - The bar empties: fluctuations in speed
- **Coasting** (assessment of all deceleration processes):
 - The bar fills up: anticipatory driving, keeping your distance and early release

of the accelerator. The vehicle can coast without use of the brakes.

- The bar empties: frequent braking

i An economical driving style specially requires driving at moderate engine speeds.

To achieve a higher value in the categories **Acceleration** and **Constant**:

- observe the gearshift recommendations.
- drive in drive program **E**.

i On long journeys at a constant speed, e.g. on the highway, only the bar for **Constant** will change.

i The ECO display summarizes the driving characteristics from the start of the journey to its completion. For this reason, the bars change dynamically at the beginning of the journey. On longer journeys, there are fewer changes. For more dynamic changes, carry out a manual reset.

For further information on the ECO display, see (▷ page 226).

Brakes

Important safety notes

WARNING

If you shift down on a slippery road surface in an attempt to increase the engine's braking effect, the drive wheels could lose their grip. There is an increased danger of skidding and accidents.

Do not shift down for additional engine braking on a slippery road surface.

Downhill gradients

! On long, steep gradients, you must reduce the load on the brakes. To use engine braking, shift to a lower gear in good time. This helps you to avoid overheating the brakes and wearing them out excessively.

When making use of the engine braking effect, it is possible that a drive wheel may not turn for some time, e.g. in the case of suddenly changing or slippery road surface conditions. This could cause damage to the drive train. This type of damage is not covered by the Mercedes-Benz warranty.

Change into a lower gear in good time on long and steep downhill gradients. This is especially important if the vehicle is laden.

Heavy and light loads

WARNING

If you rest your foot on the brake pedal while driving, the braking system can overheat. This increases the stopping distance and can even cause the braking system to fail. There is a risk of an accident.

Never use the brake pedal as a footrest. Never depress the brake pedal and the accelerator pedal at the same time.

! Depressing the brake pedal constantly results in excessive and premature wear to the brake pads.

If the brakes have been subjected to a heavy load, do not stop the vehicle immediately, but drive on for a short while. This allows the airflow to cool the brakes more quickly.

Wet roads

If you have driven for a long time in heavy rain without braking, there may be a delayed reaction from the brakes when braking for the first time. This may also occur after the vehicle has been washed or driven through deep water.

You then have to depress the brake pedal more firmly. Maintain a greater distance from the vehicle in front.

After driving on a wet road or having the vehicle washed, brake firmly while paying attention to the traffic conditions. This will warm up the brake discs, thereby drying them more quickly and protecting them against corrosion.

Limited braking performance on salt-treated roads

If you drive on salted roads, a layer of salt residue may form on the brake discs and brake pads. This can result in a significantly longer braking distance.

- Brake occasionally to remove any possible salt residue. Make sure that you do not endanger other road users when doing so.
- Carefully depress the brake pedal and the beginning and end of a journey.
- Maintain a greater distance to the vehicle ahead.

Servicing the brakes

! If the brake warning lamp lights up in the instrument cluster and you hear a warning tone even though the parking brake has been released, the brake fluid level may be too low. Observe additional warning messages in the multifunction display.

The brake fluid level may be too low due to brake pad wear or leaking brake lines.

Have the brake system checked immediately. This work should be carried out at a qualified specialist workshop.

! As the ESP® system operates automatically, the engine and the ignition system must be switched off (SmartKey in position **0** or **1** in the ignition lock or Start/Stop button in position **0** or **1**) when:

- testing the parking brake on a brake dynamometer.
- you intend to have the vehicle towed with the front axle raised.

Braking maneuvers triggered automatically by ESP® may seriously damage the brake system.

All checks and maintenance work on the brake system must be carried out at a qualified specialist workshop. Have this work carried out at an authorized Mercedes-Benz Center.

Have the brake pads replaced and the brake fluid renewed at a qualified specialist workshop, e.g. an authorized Mercedes-Benz Center.

If the brake system has only been subject to moderate loads, you should test the functionality of your brakes at regular intervals. To do so, depress the brake pedal firmly when driving at a high speed. This improves the grip of the brake pads.

A description of Brake Assist (BAS):

(▷ page 72)

Mercedes-Benz recommends that you only have brake pads/linings installed on your vehicle which have been approved for Mercedes-Benz vehicles or which correspond to an equivalent quality standard. Brake pads/linings which have not been approved for Mercedes-Benz vehicles or which are not of an equivalent quality could affect your vehicle's operating safety.

Mercedes-Benz recommends that you only use brake fluid that has been specially approved for your vehicle by Mercedes-Benz, or which corresponds to an equivalent quality standard. Brake fluid which has not been approved for Mercedes-Benz vehicles or which is not of an equivalent quality could affect your vehicle's operating safety.

High performance and ceramic brake system for AMG vehicles

The AMG brake systems are designed for heavy loads. This may lead to noise when braking. This will depend on:

- speed
- braking force
- ambient conditions, e.g. temperature and humidity

The wear of individual components of the brake system, such as the brake pads/linings or brake discs, depends on the individual driving style and operating conditions.

For this reason, it is impossible to state a mileage that will be valid under all circum-

stances. An aggressive driving style will lead to high wear. You can obtain more information on this from a qualified specialist workshop.

New and replaced brake pads and discs only reach their optimum braking effect after several hundred kilometers of driving. Compensate for this by applying greater force to the brake pedal. Keep this in mind, and adapt your driving and braking accordingly during this break-in period.

Excessive heavy braking results in correspondingly high brake wear. Observe the brake system warning lamp in the instrument cluster and note any brake status messages in the multifunction display. Especially for high performance driving, it is important to maintain and have the brake system checked regularly.

Checking brake lining thickness

You can measure the brake pad/lining thickness using a test gauge. Color-coding (green or red) on the test gauge allows you to determine whether the brake pad/lining thickness is still sufficient. The test gauge is in the vehicle document wallet in the glove box.

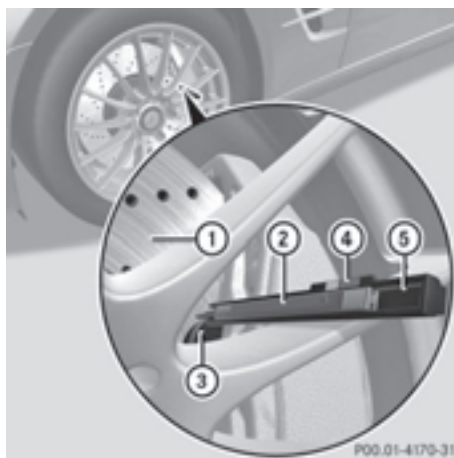

Front wheel



Rear wheel

- ▶ Bring the vehicle and wheels into a suitable position so that you can attach test gauge ⑤.
- ▶ Secure the vehicle against rolling away (▷ page 171).
- ▶ Move the selector lever to position **P**.
- ▶ Switch off the engine.
- ▶ Place test gauge ⑤ between the wheel's spokes on brake pad/lining ③.

- ▶ Hold test gauge ⑤ vertically on brake disc ① and slide measuring pin ② onto brake disc ①.
 - ▶ Check which color field ④ the arrow on measuring pin ② is pointing to.
 - Green:** the brake pad/lining thickness is sufficient.
 - Red:** the brake pad/lining thickness is not sufficient. Have the brake pads/lining checked at a qualified specialist workshop.
- i** To avoid an inaccurate measurement:
- make sure you position the wheels suitably
 - do not put the measuring pin on a recess in the brake disc

Driving on wet roads

Hydroplaning

If water has accumulated to a certain depth on the road surface, there is a danger of hydroplaning occurring, even if:

- you drive at low speeds.
- the tires have adequate tread depth.

For this reason, in the event of heavy rain or in conditions in which hydroplaning may occur, you must drive in the following manner:

- lower your speed.
- avoid ruts.
- avoid sudden steering movements.
- brake carefully.

Driving on flooded roads

! Do not drive through flooded areas. Check the depth of any water before driving through it. Drive slowly through standing water. Otherwise, water may enter the vehicle interior or the engine compartment. This can damage the electronic components in the engine or the automatic transmission. Water can also be drawn in by the engine's air suction nozzles and this can cause engine damage.

Winter driving

WARNING

If you shift down on a slippery road surface in an attempt to increase the engine's braking effect, the drive wheels could lose their grip. There is an increased danger of skidding and accidents.

Do not shift down for additional engine braking on a slippery road surface.

DANGER

If the exhaust pipe is blocked or adequate ventilation is not possible, poisonous gases such as carbon monoxide (CO) may enter the vehicle. This is the case, e.g. if the vehicle becomes trapped in snow. There is a risk of fatal injury.

If you leave the engine or the auxiliary heating running, make sure the exhaust pipe and area around the vehicle are clear of snow. To ensure an adequate supply of fresh air, open a window on the side of the vehicle that is not facing into the wind.

Have your vehicle winter-proofed at a qualified specialist workshop at the onset of winter.

Drive particularly carefully on slippery road surfaces. Avoid sudden acceleration, steering and braking maneuvers. Do not use cruise control.

If the vehicle threatens to skid or cannot be stopped when moving at low speed:

- ▶ Shift the transmission to position **N**.

The outside temperature indicator is not designed to serve as an ice-warning device and is therefore unsuitable for that purpose. Changes in the outside temperature are displayed after a short delay.

Indicated temperatures just above the freezing point do not guarantee that the road surface is free of ice. The road may still be icy, especially in wooded areas or on bridges. The vehicle could skid if you fail to adapt your driving style. Always adapt your driving style

and drive at a speed to suit the prevailing weather conditions.

You should pay special attention to road conditions when temperatures are around freezing point.

For more information on driving with snow chains, see (▷ page 571).

For more information on driving with summer tires, see (▷ page 570).

Observe the notes in the "Winter operation" section (▷ page 570).

Driving systems

Cruise control

General notes

Cruise control maintains a constant road speed for you. It brakes automatically in order to avoid exceeding the set speed. On long and steep downhill gradients, especially if the vehicle is laden, you must select a lower gear in good time. By doing so, you will make use of the braking effect of the engine. This relieves the load on the brake system and prevents the brakes from overheating and wearing too quickly.

Use cruise control only if road and traffic conditions make it appropriate to maintain a steady speed for a prolonged period. You can store any road speed above 20 mph (30 km/h).

Important safety notes

If you fail to adapt your driving style, cruise control can neither reduce the risk of an accident nor override the laws of physics. Cruise control cannot take into account the road, traffic and weather conditions. Cruise control is only an aid. You are responsible for the distance to the vehicle in front, for vehicle speed, for braking in good time and for staying in lane.

Do not use cruise control:

- in road and traffic conditions which do not allow you to maintain a constant speed e.g. in heavy traffic or on winding roads
- on slippery road surfaces. Braking or accelerating could cause the drive wheels to lose traction and the vehicle could then skid
- when there is poor visibility, e.g. due to fog, heavy rain or snow

If there is a change of drivers, advise the new driver of the speed stored.

Cruise control lever



Cruise control lever

- ① To store the current speed or a higher speed
- ② To store the current speed or call up the last stored speed
- ③ To store the current speed or a lower speed
- ④ To deactivate cruise control

When you activate cruise control, the stored speed is shown in the status indicator of the multifunction display:

- USA only: e.g. **CRUISE 55 Miles**
- Canada only: e.g.  **90 Km/h**

Storing, maintaining and calling up a speed

Storing and maintaining a speed



Cruise control lever

- ▶ Accelerate the vehicle to the desired speed.
- ▶ Briefly press the cruise control lever up ① or down ②.
- ▶ Remove your foot from the accelerator pedal.
Cruise control is activated. The vehicle automatically maintains the stored speed.

You can store the current speed if you are driving faster than 20 mph (30 km/h).

- ① Cruise control may be unable to maintain the stored speed on uphill gradients. The stored speed is resumed when the gradient evens out. Cruise control maintains the stored speed on downhill gradients by automatically applying the brakes.

Storing or calling up a speed

⚠ WARNING

If you call up the stored speed and it differs from the current speed, the vehicle accelerates or decelerates. If you do not know the stored speed, the vehicle could accelerate or brake unexpectedly. There is a risk of an accident.

Pay attention to the road and traffic conditions before calling up the stored speed. If you do not know the stored speed, store the desired speed again.



Cruise control lever

- ▶ Briefly pull the cruise control lever toward you ①.
- ▶ Remove your foot from the accelerator pedal.
The first time cruise control is activated, it stores the current speed or regulates the speed of the vehicle to the previously stored speed.

Setting a speed

⚠ WARNING

Keep in mind that it may take a brief moment until the vehicle has made the necessary adjustments.

Increase or decrease the set vehicle speed to a value that the prevailing road conditions and legal speed limits permit. Otherwise, sudden and unexpected acceleration or deceleration of the vehicle could cause an accident and/or serious injury to you and others.



Cruise control lever

- ▶ **To adjust the set speed in 1 mph increments (1 km/h increments):** briefly press the cruise control lever up ① to the pressure point for a higher speed or down ② for a lower speed.

Every time the cruise control lever is pressed up or down, the last speed stored is increased or reduced.

- ▶ **To adjust the set speed in 5 mph increments (10 km/h increments):** briefly press the cruise control lever up ① past the pressure point for a higher speed or down ② for a lower speed.

Every time the cruise control lever is pressed up or down, the last speed stored is increased or reduced.

- ❗ Cruise control is not deactivated if you depress the accelerator pedal. For example, if you accelerate briefly to overtake, cruise control adjusts the vehicle's speed to the last speed stored after you have finished overtaking.

Deactivating cruise control



Cruise control lever

There are several ways to deactivate cruise control:

- ▶ Briefly press the cruise control lever forwards ①.

or

- ▶ Brake.

Cruise control is automatically deactivated if:

- you engage the electric parking brake
- you are driving at less than 20 mph (30 km/h)
- ESP® intervenes or you deactivate ESP®
- you shift the transmission to position **N** while driving

If cruise control is deactivated, you will hear a warning tone. You will see the **Cruise Control Off** message in the multifunction display for approximately five seconds.

- ❗ When you switch off the engine, the last speed stored is cleared.

DISTRONIC PLUS

General notes

DISTRONIC PLUS regulates the speed and automatically helps you maintain the distance to the vehicle detected in front. DISTRONIC PLUS brakes automatically so that the set speed is not exceeded.

On long and steep downhill gradients, especially if the vehicle is laden, you must select a lower gear in good time. By doing so, you will make use of the braking effect of the engine. This relieves the load on the brake system and prevents the brakes from overheating and wearing too quickly.

If a slower-moving vehicle is detected in front, DISTRONIC PLUS brakes your vehicle. It maintains the preset distance to the vehicle in front.

If DISTRONIC PLUS detects that there is a risk of a collision, you will be warned visually and acoustically. DISTRONIC PLUS cannot prevent a collision without your intervention. An intermittent warning tone will then sound and the distance warning lamp will light up in the instrument cluster. Brake immediately in order to increase the distance to the vehicle in front or take evasive action provided it is safe to do so.

For DISTRONIC PLUS to assist you, the radar sensor system must be operational.

If there is no vehicle in front, DISTRONIC PLUS operates in the same way as cruise control in the speed range between 20 mph (Canada: 30 km/h) and 120 mph (Canada: 200 km/h). If a vehicle is driving in front of you, it operates in the speed range between 0 mph (0 km/h) and 120 mph (Canada: 200 km/h).

Do not use DISTRONIC PLUS while driving on roads with steep gradients.

As DISTRONIC PLUS transmits radar waves, it can resemble the radar detectors of the responsible authorities. You can refer to the relevant chapter in the Operator's Manual if questions are asked about this.

i USA only: This device has been approved by the FCC as a "Vehicular Radar System". The radar sensor is intended for use in an automotive radar system only. Removal, tampering, or altering of the device will void any warranties, and is not permitted by the FCC. Do not tamper with, alter, or use in any non-approved way.

Any unauthorized modification to this device could void the user's authority to operate the equipment.

i Canada only: This device complies with RSS-210 of Industry Canada. Operation is subject to the following two conditions:

1. This device may not cause harmful interference, and
2. this device must accept any interference received, including interference that may cause undesired operation of the device.

Removal, tampering, or altering of the device will void any warranties, and is not permitted. Do not tamper with, alter, or use in any non-approved way.

Any unauthorized modification to this device could void the user's authority to operate the equipment.

Important safety notes

WARNING

DISTRONIC PLUS does not react to:

- people or animals
- stationary obstacles on the road, e.g. stopped or parked vehicles
- oncoming and crossing traffic

As a result, DISTRONIC PLUS may neither give warnings nor intervene in such situations.

There is a risk of an accident.

Always pay careful attention to the traffic situation and be ready to brake.

WARNING

DISTRONIC PLUS cannot always clearly identify other road users and complex traffic situations.

In such cases, DISTRONIC PLUS may:

- give an unnecessary warning and then brake the vehicle
- neither give a warning nor intervene
- accelerate unexpectedly

There is a risk of an accident.

Continue to drive carefully and be ready to brake, in particular when warned to do so by DISTRONIC PLUS.

WARNING

DISTRONIC PLUS brakes your vehicle with up to 40% of the maximum braking force. If this braking force is insufficient, DISTRONIC PLUS warns you visually and audibly. There is a risk of an accident.

In such cases, apply the brakes yourself and try to take evasive action.

! If DISTRONIC PLUS or the HOLD function is activated, the vehicle brakes automatically in certain situations. To prevent damage to the vehicle, deactivate DISTRONIC PLUS and the HOLD function in the following or other similar situations:

- when towing the vehicle
- in the car wash

If you fail to adapt your driving style, DISTRONIC PLUS can neither reduce the risk of accident nor override the laws of physics. DISTRONIC PLUS cannot take into account the road, traffic and weather conditions. DISTRONIC PLUS is only an aid. You are responsible for the distance to the vehicle in front, for vehicle speed, for braking in good time and for staying in lane.

Do not use DISTRONIC PLUS:

- in road and traffic conditions which do not allow you to maintain a constant speed e.g. in heavy traffic or on winding roads
- on slippery road surfaces. Braking or accelerating could cause the drive wheels to lose traction and the vehicle could then skid
- when there is poor visibility, e.g. due to fog, heavy rain or snow

DISTRONIC PLUS may not detect narrow vehicles driving in front, e.g. motorcycles, or vehicles driving on a different line.

In particular, the detection of obstacles can be impaired if:

- there is dirt on the sensors or anything else covering the sensors
- snow or heavy rain
- interference by other radar sources
- strong radar reflections, for example, in parking garages

If DISTRONIC PLUS no longer detects a vehicle in front, DISTRONIC PLUS may unexpectedly accelerate the vehicle to the stored speed.

This speed may:

- be too high if you are driving in a filter lane or an exit lane
- be so high when driving in the right-hand lane that you overtake vehicles in the left-hand lane
- be so high when driving in the left-hand lane that you overtake vehicles in the right-hand lane

If there is a change of drivers, advise the new driver of the speed stored.

Cruise control lever

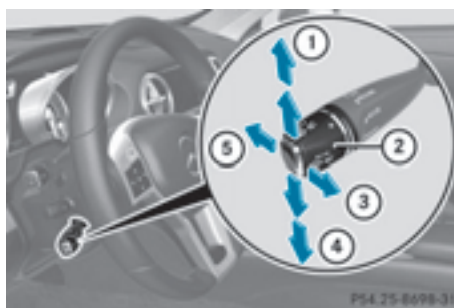

Cruise control lever

- ① To store the current speed or a higher speed
- ② To set the specified minimum distance
- ③ To store the current speed or call up the last stored speed
- ④ To store the current speed or a lower speed
- ⑤ To deactivate DISTRONIC PLUS

Activating DISTRONIC PLUS; storing, maintaining and calling up a speed

Important safety notes

! If DISTRONIC PLUS or the HOLD function is activated, the vehicle brakes automatically in certain situations. To prevent damage to the vehicle, deactivate DISTRONIC PLUS and the HOLD function in the following or other similar situations:

- when towing the vehicle
- in the car wash

In order to activate DISTRONIC PLUS, the following conditions must be fulfilled:

- the engine must be started. It may take up to two minutes after pulling away before DISTRONIC PLUS is operational.
- your vehicle must not be secured by the electric parking brake.
- ESP[®] must be activated.
- the transmission must be in position **D**.
- the hood must be closed.
- the driver's door must be closed when you shift from **P** to **D** or your seat belt must be fastened.
- the front-passenger door must be closed.
- the vehicle must not skid.

Activating



Cruise control lever

► Briefly pull the cruise control lever towards you ②, or press it up ① or down ③. DISTRONIC PLUS is selected.

► **To adjust the set speed in 1 mph increments (1 km/h increments):** briefly press the cruise control lever up ① to the pressure point for a higher speed or down ③ for a lower speed. Every time the cruise control lever is pressed up or down, the last speed stored is increased or reduced.

or

► **To adjust the set speed in 5 mph increments (10 km/h increments):** briefly press the cruise control lever up ① past the pressure point for a higher speed or down ③ for a lower speed. Every time the cruise control lever is pressed up or down, the last speed stored is increased or reduced.

► Remove your foot from the accelerator pedal. Your vehicle adapts its speed to that of the vehicle in front, but only up to the desired stored speed.

When driving at speeds below 20 mph (30 km/h), you can only activate DISTRONIC PLUS if the vehicle in front has been detected and is shown in the multifunction display. If the vehicle in front is no longer detected and displayed, for example because it has changed lanes, DISTRONIC PLUS is deactivated. You will hear a warning tone if this is the case.

i If you do not fully release the accelerator pedal, the **DISTRONIC PLUS Inactive** message appears in the multifunction display. The set distance to a slower-moving vehicle in front will then not be maintained. You will be driving at the speed you determine by the position of the accelerator pedal.

Pulling away and driving



Cruise control lever

If you depress the brake, DISTRONIC PLUS is deactivated unless your vehicle is stationary.

- ▶ **If the vehicle in front pulls away:** remove your foot from the brake pedal.
- ▶ Briefly pull the cruise control lever towards you ②, or up ① or down ③.

or

- ▶ Accelerate briefly.
Your vehicle pulls away and adapts its speed to that of the vehicle in front.

If there is no vehicle in front, DISTRONIC PLUS operates in the same way as cruise control.

If DISTRONIC PLUS detects that the vehicle in front has slowed down, it brakes your vehicle. It maintains the preset distance to the vehicle in front.

If DISTRONIC PLUS detects that there is a risk of a collision, you will be warned visually and acoustically. DISTRONIC PLUS cannot prevent a collision without your intervention. An intermittent warning tone will then sound and the distance warning lamp will light up in the instrument cluster. Brake immediately in order to increase the distance from the vehicle in front, or take evasive action, provided it is safe to do so.

If DISTRONIC PLUS detects a faster-moving vehicle in front, it increases the driving speed. However, the vehicle is only accelerated up to the speed you have stored.

Changing lanes

If you wish to change to the passing lane (in countries where traffic drives on the right, the passing lane is the left-hand lane), DISTRONIC PLUS supports you if:

- you are driving faster than 40 mph (60 km/h)
- DISTRONIC PLUS is maintaining the distance to a vehicle in front
- you have switched on the corresponding turn signal
- DISTRONIC PLUS does not detect a danger of collision

If these conditions are fulfilled, your vehicle is accelerated. Acceleration will be interrupted if changing lanes takes too long or if the distance between your vehicle and the vehicle in front becomes too small.

Stopping

WARNING

When leaving the vehicle, even if it is braked only by DISTRONIC PLUS, it could roll away if:

- there is a malfunction in the system or in the voltage supply.
- DISTRONIC PLUS has been deactivated with the cruise control lever, e.g. by a vehicle occupant or from outside the vehicle.
- the electrical system in the engine compartment, the battery or the fuses have been tampered with.
- the battery is disconnected.
- the accelerator pedal has been depressed, e.g. by a vehicle occupant.

There is a risk of an accident.

If you wish to exit the vehicle, always turn off DISTRONIC PLUS and secure the vehicle against rolling away.

Deactivating DISTRONIC PLUS (▷ page 189).

If DISTRONIC PLUS detects that the vehicle in front is stopping, it brakes your vehicle until it is stationary.

Once your vehicle is stationary, it remains stationary and you do not need to depress the

brake. After a time, the electric parking brake secures the vehicle and relieves the service brake.

Depending on the specified minimum distance, your vehicle will come to a standstill at a sufficient distance behind the vehicle in front. The specified minimum distance is set using the control on the cruise control lever.

The electric parking brake automatically secures the vehicle if DISTRONIC PLUS is activated and:

- the driver's door is open and the driver's seat belt is unfastened.
- the engine is switched off, unless it is automatically switched off by the ECO start/stop function.
- a system malfunction occurs.
- the power supply is not sufficient.

If a malfunction occurs, then the transmission may also be shifted into position **P** automatically.

Storing the current speed or calling up the last stored speed

WARNING

If you call up the stored speed and it differs from the current speed, the vehicle accelerates or decelerates. If you do not know the stored speed, the vehicle could accelerate or brake unexpectedly. There is a risk of an accident.

Pay attention to the road and traffic conditions before calling up the stored speed. If you do not know the stored speed, store the desired speed again.



Cruise control lever

- ▶ Briefly pull the cruise control lever towards you ①.
- ▶ Remove your foot from the accelerator pedal. DISTRONIC PLUS is activated. The first time it is activated, the current speed is stored. Otherwise, it sets the vehicle cruise speed to the previously stored value.

Setting a speed



Cruise control lever

Keep in mind that it may take a brief moment until the vehicle has accelerated or braked to the speed set.

- ▶ **To adjust the set speed in 1 mph increments (1 km/h increments):** briefly press the cruise control lever up ① to the

pressure point for a higher speed or down ② for a lower speed.

Every time the cruise control lever is pressed up or down, the last speed stored is increased or reduced.

- ▶ **To adjust the set speed in 5 mph increments (10 km/h increments):** briefly press the cruise control lever up ① past the pressure point for a higher speed or down ② for a lower speed. Every time the cruise control lever is pressed up or down, the last speed stored is increased or reduced.

Setting the specified minimum distance

You can set the specified minimum distance for DISTRONIC PLUS by varying the time span between one and two seconds. With this function, you can set the minimum distance that DISTRONIC PLUS keeps to the vehicle in front, dependent on vehicle speed. You can see this distance in the multifunction display (> page 189).

Make sure that you maintain a sufficiently safe distance from the vehicle in front. Adjust the distance to the vehicle in front if necessary.



Cruise control lever

- ▶ **To increase:** turn control ③ toward ②. DISTRONIC PLUS then maintains a greater distance between your vehicle and the vehicle in front.
- ▶ **To decrease:** turn control ③ toward ①. DISTRONIC PLUS then maintains a shorter distance between your vehicle and the vehicle in front.

DISTRONIC PLUS displays in the instrument cluster

Displays in the speedometer



When DISTRONIC PLUS is activated, one or two segments ② in the set speed range light up.

If DISTRONIC PLUS detects a vehicle in front, segments ② between speed of the vehicle in front ③ and stored speed ① light up.

- ❗ For design reasons, the speed displayed in the speedometer may differ slightly from the speed set for DISTRONIC PLUS.

Display when DISTRONIC PLUS is deactivated



- ① Vehicle in front, if detected
- ② Distance indicator, current distance to the vehicle in front
- ③ Specified minimum distance to the vehicle in front; adjustable
- ④ Own vehicle

► Select the **Assistance Graphic** function using the on-board computer (► page 230).

In the Assistance menu of the on-board computer, you can also activate or deactivate PRE-SAFE® Brake (► page 231).

Display when DISTRONIC PLUS is activated



- ① Vehicle in front, if detected
- ② Specified minimum distance to the vehicle in front; adjustable
- ③ Own vehicle
- ④ DISTRONIC PLUS activated

► Select the **Assistance Graphic** function using the on-board computer (► page 230).

You will initially see the stored speed for about five seconds when you activate DISTRONIC PLUS.

Deactivating DISTRONIC PLUS

⚠ WARNING

DISTRONIC PLUS is deactivated and releases the brakes if the vehicle is slowed down to a speed below 20 mph (30km/h) by the system, provided that DISTRONIC PLUS does not detect a vehicle directly in front. At this point, the driver must apply the brakes in order to slow down further and bring the vehicle to a standstill.



Cruise control lever

There are several ways to deactivate DISTRONIC PLUS:

► Briefly press the cruise control lever forwards ①.

or

► Brake, unless the vehicle is stationary.

When you deactivate DISTRONIC PLUS, you will see the **DISTRONIC PLUS Off** message in the multifunction display for approximately five seconds.

- ⓘ The last speed stored remains stored until you switch off the engine.
- ⓘ DISTRONIC PLUS is not deactivated if you depress the accelerator pedal. If you accel-

erate to overtake, DISTRONIC PLUS adjusts the vehicle's speed to the last speed stored after you have finished overtaking.

DISTRONIC PLUS is automatically deactivated if:

- you engage the electric parking brake or if the vehicle is automatically secured with the electric parking brake
- you are driving slower than 15 mph (25 km/h) and there is no vehicle in front, or if the vehicle in front is no longer detected
- ESP® intervenes or you deactivate ESP®
- the transmission is in the **P**, **R** or **N** position
- you pull the cruise control lever towards you in order to pull away and the front-passenger door is open
- the vehicle has skidded

If DISTRONIC PLUS is deactivated, you will hear a warning tone. You will see the **DISTRONIC PLUS Off** message in the multifunction display for approximately five seconds.

Tips for driving with DISTRONIC PLUS

General notes

The following contains descriptions of certain road and traffic conditions in which you must be particularly attentive. In such situations, brake if necessary. DISTRONIC PLUS is then deactivated.

Cornering, going into and coming out of a bend

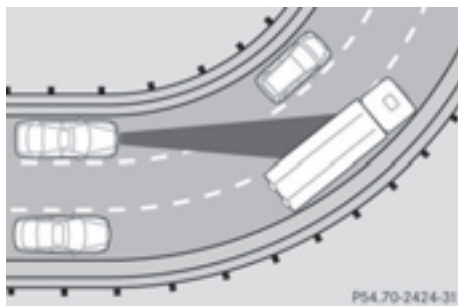

The ability of DISTRONIC PLUS to detect vehicles when cornering is limited. Your vehicle may brake unexpectedly or late.

Vehicles traveling on a different line

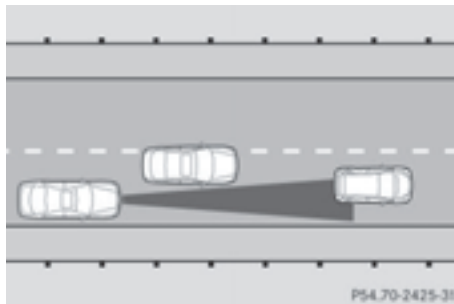

DISTRONIC PLUS may not detect vehicles traveling on a different line. The distance to the vehicle in front will be too short.

Other vehicles changing lanes

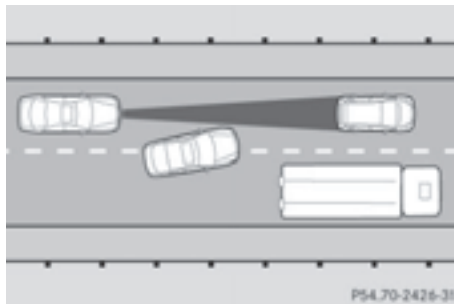

DISTRONIC PLUS has not detected the vehicle cutting in yet. The distance to this vehicle will be too short.

Narrow vehicles

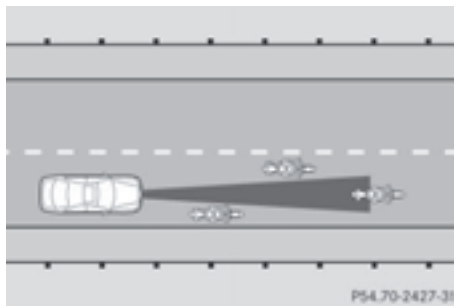

DISTRONIC PLUS has not yet detected the vehicle in front on the edge of the road, because of its narrow width. The distance to the vehicle in front will be too short.

Obstructions and stationary vehicles

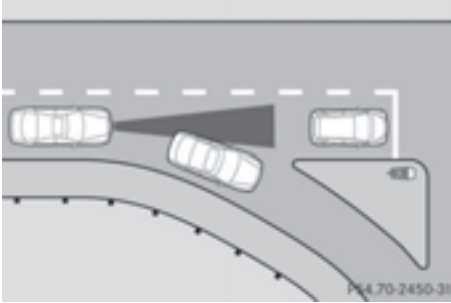

DISTRONIC PLUS does not brake for obstacles or stationary vehicles. If, for example, the detected vehicle turns a corner and reveals an obstacle or stationary vehicle, DISTRONIC PLUS will not brake for these.

Crossing vehicles

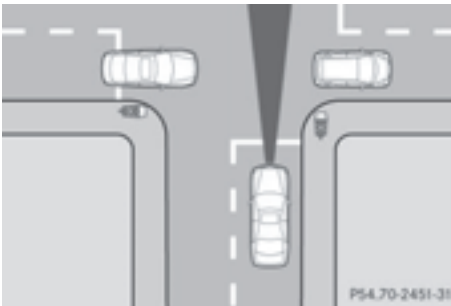

DISTRONIC PLUS may mistakenly detect vehicles that are crossing your lane. Activating DISTRONIC PLUS at traffic lights with crossing traffic, for example, could cause your vehicle to pull away unintentionally.

HOLD function

General notes

The HOLD function can assist the driver in the following situations:

- when pulling away, especially on steep slopes
- when maneuvering on steep slopes
- when waiting in traffic

The vehicle is kept stationary without the driver having to depress the brake pedal.

The braking effect is canceled and the HOLD function deactivated when you depress the accelerator pedal to pull away.

Important safety notes

WARNING

When leaving the vehicle, it can still roll away despite being braked by the HOLD function if:

- there is a malfunction in the system or in the voltage supply.
- the HOLD function has been deactivated by pressing the accelerator pedal or the brake pedal, e.g. by a vehicle occupant.
- the electrical system in the engine compartment, the battery or the fuses have been tampered with.
- the battery is disconnected

There is a risk of an accident.

If you wish to exit the vehicle, always turn off the HOLD function and secure the vehicle against rolling away.

! If DISTRONIC PLUS or the HOLD function is activated, the vehicle brakes automatically in certain situations. To prevent damage to the vehicle, deactivate DISTRONIC PLUS and the HOLD function in the following or other similar situations:

- when towing the vehicle
- in the car wash

Deactivating the HOLD function
(▷ page 192).

Activation conditions

You can activate the HOLD function if:

- the vehicle is stationary
- the engine is running or if it has been automatically switched off by the ECO start/stop function
- the driver's door is closed or your seat belt is fastened
- the electric parking brake is released
- the transmission is in position **D**, **R** or **N**
- DISTRONIC PLUS is deactivated

Activating the HOLD function



- ▶ Make sure that the activation conditions are met.
- ▶ Depress the brake pedal.
- ▶ Quickly depress the brake pedal further until **HOLD** appears in the multifunction display. The HOLD function is activated. You can release the brake pedal.

- i** If depressing the brake pedal the first time does not activate the HOLD function, wait briefly and then try again.

Deactivating the HOLD function

The HOLD function is deactivated automatically if:

- you accelerate and the transmission is in position **D** or **R**.
- you shift the transmission to position **P**.
- you apply the brakes again with a certain amount of pressure until **HOLD** disappears from the multifunction display.

- you secure the vehicle using the electric parking brake.
- you activate DISTRONIC PLUS.

- i** After a time, the electric parking brake secures the vehicle and relieves the service brake.

The electric parking brake automatically secures the vehicle if the HOLD function is activated and:

- the driver's door is open and the driver's seat belt is unfastened.
- the engine is switched off, unless it is automatically switched off by the ECO start/stop function.
- a system malfunction occurs.
- the power supply is not sufficient.

If a malfunction occurs, then the transmission may also be shifted into position **P** automatically.

RACE START

Important safety notes

- i** Observe the safety notes for the SPORT handling mode (> page 76).

RACE START is intended solely for activation on dedicated race circuits.

RACE START enables optimal acceleration from a standing start. The precondition for this is a suitable high-grip road surface.

- i** RACE START is only available for the SL 63 AMG model.

Conditions for activation

You can activate RACE START if:

- the doors are closed.
- the engine is running and it has reached an operating temperature of approximately 176 °F (80 °C). This is the case when the engine oil temperature in the multifunction display stops flashing.

- SPORT handling mode is activated. (▷ page 76)
- the steering wheel is in the straight-ahead position.
- the vehicle is stationary and the brake pedal is depressed (left foot).
- the transmission is in position **D**.

Activating RACE START

- ▶ Depress the brake pedal with your left foot and keep it depressed.
- ▶ Turn the drive program selector clockwise (▷ page 163) until the **RS** lamp lights up. The **RACE START Confirm: Paddle UP Cancel: Paddle DOWN** message appears in the multifunction display.

i If the activation conditions are no longer fulfilled, RACE START is canceled. The multifunction display shows the **RACE START Canceled** message.

- ▶ To cancel: pull the left steering wheel paddle shifter (▷ page 164).

or

- ▶ To confirm: pull the right steering wheel paddle shifter (▷ page 164). The **RACE START Available Depress gas pedal** message appears in the multifunction display.

i If you do not depress the accelerator pedal fully within two seconds, RACE START is canceled. The **RACE START Not Possible See Operator's Manual** message appears in the multifunction display.

- ▶ Fully depress the accelerator pedal. The engine speed increases to at least 3,500 rpm. The **RACE START Release brake to start** message appears in the multifunction display.

i If you do not release the brake pedal within five seconds, RACE START is can-

celed. The multifunction display shows the **RACE START Canceled** message.

- ▶ Take your foot off the brake, but keep the accelerator pedal depressed. The vehicle pulls away at maximum acceleration. The **RACE START Active** appears in the multifunction display.

RACE START is deactivated when the vehicle reaches a speed of approximately 30 mph (Canada: 50 km/h). Drive program **S+** is activated. SPORT handling mode remains activated.

RACE START is deactivated immediately if you release the accelerator pedal during RACE START or if any of the activation conditions are no longer fulfilled. The **RACE START Not Possible See Operator's Manual** message appears in the multifunction display.

- i** If RACE START is used repeatedly within a short period of time, it is only available again after the vehicle has been driven a certain distance.

Adaptive Damping System

General notes

The adjustable damping system adapts to the current driving conditions. The adjustment depends on whether you have selected Sport or Comfort mode. Your selection remains stored even if you remove the SmartKey from the ignition lock.

Selecting sports tuning



► Make sure that the engine is running or that it has been switched off by the ECO start/stop function.

► **If indicator lamp ② is not lit:** press button ①.

Indicator lamp ② lights up. You have selected the suspension for a sporty driving style.

The message **SPORT** appears in the multi-function display.

The firmer setting of the suspension tuning in sports mode ensures even better contact with the road. Select this mode if you want more direct contact with the road when employing a sporty driving style, e.g. on winding country roads.

Selecting comfort tuning

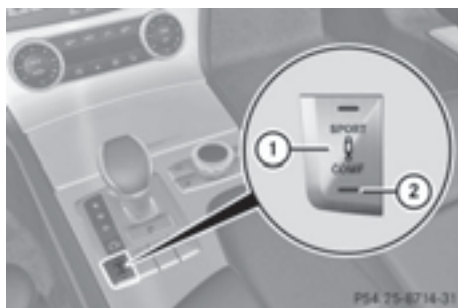

► Make sure that the engine is running or that it has been switched off by the ECO start/stop function.

► **If indicator lamp ② is not lit:** press button ①.

Indicator lamp ② lights up. You have selected the suspension for a comfortable driving style.

The message **COMFORT** appears in the multi-function display.

In Comfort mode, the driving characteristics of your vehicle are more comfortable. Select this mode if you favor a more comfortable driving style.

Active Body Control (except AMG vehicles)

Vehicle level

General notes

In order to reduce fuel consumption and improve the driving dynamics, the vehicle is lowered as its speed increases. With the SPORT suspension setting, it is lowered by up to 0.5 in (13 mm), with COMFORT by up to 0.2 in (5 mm). As the speed is reduced, the vehicle is raised up to the set vehicle height. Select the "Normal" setting for normal road surfaces and "Raised" for driving with snow chains or on particularly poor road surfaces. Your selection remains stored even if you remove the SmartKey from the ignition lock.

Important safety notes

WARNING

The vehicle is slightly lowered if you:

- have selected the SPORT suspension tuning at normal level and
- switch off the engine

Persons in the vicinity of the wheel arch or the underbody may thus become trapped. There is a risk of injury.

Make sure that nobody is in the vicinity of the wheel arch or the underbody when you switch off the engine.

Setting raised level



► Make sure that the engine is running or that it has been switched off by the ECO start/stop function.

► Make sure that a speed of 75 mph (120 km/h) is not exceeded.

► **If indicator lamp ② is not lit:** press button ①.

If the engine has been switched off by the ECO start/stop function, it is now restarted.

Indicator lamp ② lights up. The vehicle height is adjusted to raised level.

Setting the normal level



► Make sure that the engine is running or that it has been switched off by the ECO start/stop function.

► **If indicator lamp ② is lit:** press button ①.

Indicator lamp ② goes out. The vehicle is adjusted to normal level.

The "Raised level" setting is canceled if you:

- are driving faster than approximately 75 mph (120 km/h).
- drive for approximately three minutes at a speed over 50 mph (80 km/h).

Suspension tuning

General notes

The electronically controlled ABC suspension system features improved driving dynamics and ride comfort.

The ABC suspension system is tuned individually to each wheel and depends on:

- the road surface condition, e.g. bumps
- the vehicle load
- your individual selection of the sporty or comfort button

Your selection remains stored even if you remove the SmartKey from the ignition lock.

Selecting sports tuning



- ▶ Make sure that the engine is running or that it has been switched off by the ECO start/stop function.
- ▶ **If indicator lamp ② is not lit:** press button ①. Indicator lamp ② lights up. You have selected the suspension for a sporty driving style. The **ABC Active Body Control¹ SPORT** message appears in the multifunction display.

The firmer suspension tuning in Sport mode ensures even better contact with the road. Select this mode if you favor a firmer suspension tuning.

Selecting comfort tuning

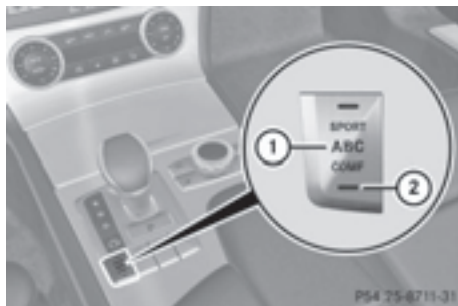

- ▶ Make sure that the engine is running or that it has been switched off by the ECO start/stop function.
- ▶ **If indicator lamp ② is not lit:** press button ①. Indicator lamp ② lights up. You have selected the suspension for a comfortable driving style. The **ABC Active Body Control¹ COMFORT** message appears in the multifunction display.

In comfort mode, the driving characteristics of your vehicle are more comfortable. Select this mode if you favor a more comfortable driving style.

Driving conditions menu in the COMAND display



You can display some driving systems and additional information in the COMAND display.

- ▶ Make sure that the SmartKey is in position 2 in the ignition lock.
- ▶ Make sure COMAND is switched on (▷ page 295).
- ▶ Press button ①. The corresponding displays appear in the COMAND display.

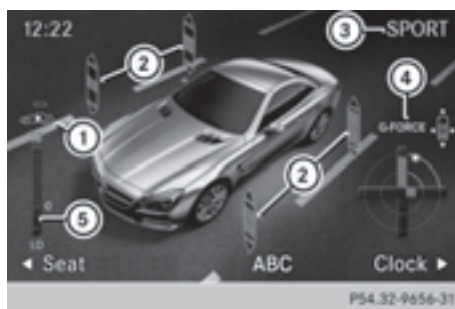

Example: displays in the COMAND display

- ① Selection of raised level (▷ page 194)
- ② Activity of ABC spring struts for roll and pitching support
- ③ Selected suspension tuning, i.e. sporty or comfortable (▷ page 195)
- ④ G-FORCE (longitudinal and lateral acceleration)
- ⑤ Current vehicle level

Active Body Control (AMG vehicles)

Vehicle level

General notes

In order to reduce fuel consumption and improve the driving dynamics, the vehicle is lowered as its speed increases. With the SPORT suspension setting, it is lowered by up to 0.5 in (13 mm), with COMFORT by up to 0.2 in (5 mm). As the speed is reduced, the vehicle is raised up to the set vehicle height. Select the "Normal" setting for normal road surfaces and "Raised" for driving with snow chains or on particularly poor road surfaces.

Important safety notes

The vehicle is slightly lowered when the engine is switched off.

WARNING







When the vehicle is being lowered, people could become trapped if their limbs are between the vehicle body and the wheels or underneath the vehicle. There is a risk of injury.

Make sure no one is underneath the vehicle or in the immediate vicinity of the wheel arches when the vehicle is being lowered.

Setting raised level









- ▶ Make sure that the engine is running or that it has been switched off by the ECO start/stop function.
- ▶ Make sure that a speed of 75 mph (120 km/h) is not exceeded.

- ▶ If icon ② is not shown: press  or  on the steering wheel to select the **DriveAssist** menu.
- ▶ Press the  or  button to select **Vehicle Level**.
- ▶ Press the  button.
The following message appears: **Vehicle Level Press 'OK' to Raise**.
- ▶ Press the  button.
If the engine has been switched off by the ECO start/stop function, it is now restarted.
Icon ② appears. The vehicle height is adjusted to raised level.

Setting the normal level



- ▶ Make sure that the engine is running or that it has been switched off by the ECO start/stop function.
- ▶ If icon ② is shown: press  or  on the steering wheel to select the **DriveAssist** menu.
- ▶ Press the  or  button to select **Vehicle Level**.
- ▶ Press the  button.
The following message appears: **Vehicle Level Press 'OK' to Lower**.
- ▶ Press the  button.
Icon ② is faded out. The vehicle is adjusted to normal level.

The "Raised level" setting is canceled if you:

- are driving faster than approximately 75 mph (120 km/h).
- drive for approximately three minutes at a speed over 50 mph (80 km/h).

Suspension tuning

General notes

The electronically controlled ABC suspension system features improved driving dynamics and ride comfort.

The ABC suspension system is tuned individually to each wheel and depends on:

- the road surface condition, e.g. bumps
- the vehicle load
- your individual selection of the sporty or comfort button

Selecting sports tuning



- ▶ Make sure that the engine is running or that it has been switched off by the ECO start/stop function.
- ▶ **If indicator lamp ② is not lit:** press button ①. Indicator lamp ② lights up. You have selected the suspension for a sporty driving style. The **AMG Suspension System SPORT** message appears in the multifunction display.

The firmer suspension tuning in Sport mode ensures even better contact with the road. Select this mode if you favor a firmer suspension tuning.

Selecting comfort tuning



- ▶ Make sure that the engine is running or that it has been switched off by the ECO start/stop function.
- ▶ **If indicator lamp ② is lit:** press button ①. Indicator lamp ② goes out. You have selected the suspension for a comfortable driving style. The **AMG Suspension System COMFORT** message appears in the multifunction display.

In comfort mode, the driving characteristics of your vehicle are more comfortable. Select this mode if you favor a more comfortable driving style.

Driving conditions menu in the COMAND display

You can display some driving systems and additional information in the COMAND display.

- ▶ Call up the driving conditions menu in the COMAND display (▷ page 313). The corresponding displays appear in the COMAND display.

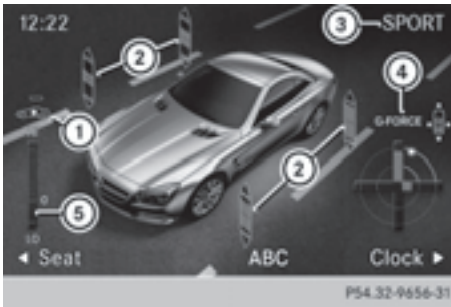

Example: displays in the COMAND display

- ① Selection of raised level (▷ page 197)
- ② Activity of ABC spring struts for roll and pitching support
- ③ Selected suspension tuning, i.e. sporty or comfortable (▷ page 198)
- ④ G-FORCE (longitudinal and lateral acceleration)
- ⑤ Current vehicle level

PARKTRONIC

Important safety notes

PARKTRONIC is an electronic parking aid with ultrasonic sensors. It indicates visually and audibly the distance between your vehicle and an object.

PARKTRONIC is only an aid. It is not a replacement for your attention to your immediate surroundings. You are always responsible for safe maneuvering, parking and exiting a parking space. When maneuvering, parking or pulling out of a parking space, make sure that there are no persons, animals or objects in the area in which you are maneuvering.

! When parking, pay particular attention to objects above or below the sensors, such as flower pots or trailer drawbars. PARKTRONIC does not detect such objects when they are in the immediate vicinity of the vehicle. You could damage the vehicle or the objects.

The sensors may not detect snow and other objects that absorb ultrasonic waves.

Ultrasonic sources such as an automatic car wash, the compressed-air brakes on a truck or a pneumatic drill could cause PARKTRONIC to malfunction.

PARKTRONIC may not function correctly on uneven terrain.

PARKTRONIC is activated automatically when you:

- switch on the ignition
- shift the transmission to position **D**, **R** or **N**
- release the electric parking brake.

PARKTRONIC is deactivated at speeds above 11 mph (18 km/h). It is reactivated at lower speeds.

PARKTRONIC monitors the area around your vehicle using six sensors in the front bumper and four sensors in the rear bumper.

Range of the sensors

General notes

PARKTRONIC does not take objects into consideration that are:

- below the detection range, e.g. people, animals or objects.
- above the detection range, e.g. overhanging loads, truck overhangs or loading ramps.

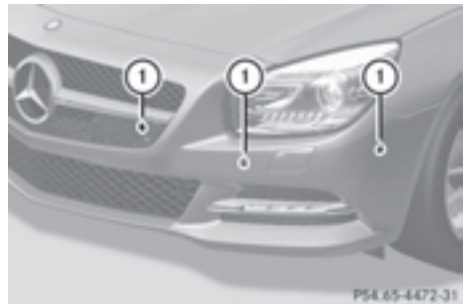

- ① Sensors in the front bumper, left-hand side (example)

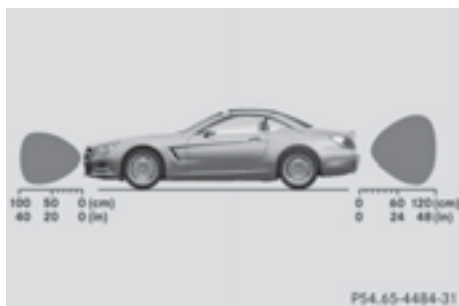

Side view

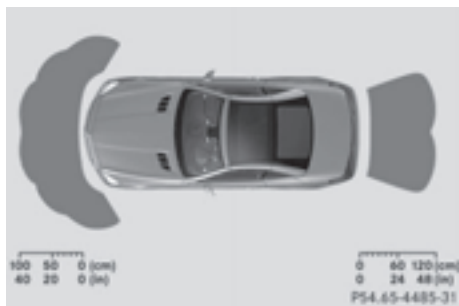

Top view

The sensors must be free from dirt, ice or slush. They can otherwise not function correctly. Clean the sensors regularly, taking care not to scratch or damage them (► page 543).

Front sensors

Center	Approx. 40 in (approx. 100 cm)
Corners	Approx. 24 in (approx. 60 cm)

Rear sensors

Center	Approx. 48 in (approx. 120 cm)
Corners	Approx. 32 in (approx. 80 cm)

Minimum distance

Center	Approx. 8 in (approx. 20 cm)
Corners	Approx. 6 in (approx. 15 cm)

If there is an obstacle within this range, the relevant warning displays light up and a warning tone sounds. If the distance falls below the minimum, the distance may no longer be shown.

Warning displays



Warning display for the front area

- ① Segments on the left-hand side of the vehicle
- ② Segments on the right-hand side of the vehicle
- ③ Segments showing operational readiness

The warning displays show the distance between the sensors and the obstacle. The warning display for the front area is located on the dashboard above the center air vents. The warning display for the rear area is located on the cover behind the seats in the rear compartment.

The warning display for each side of the vehicle is divided into five yellow and two red segments. PARKTRONIC is operational if yellow segments showing operational readiness ③ light up.

The selected transmission position and the direction in which the vehicle is rolling deter-

mine which warning display is active when the engine is running.

Transmission position	Warning display
D	Front area activated
R, N or the vehicle is rolling backwards	Rear and front areas activated
P	No areas activated

One or more segments light up as the vehicle approaches an obstacle, depending on the vehicle's distance from the obstacle.

From the:

- sixth segment onwards, you will hear an intermittent warning tone for approximately two seconds.
- seventh segment onwards, you will hear a warning tone for approximately two seconds. This indicates that you have now reached the minimum distance.

Deactivating/activating PARKTRONIC

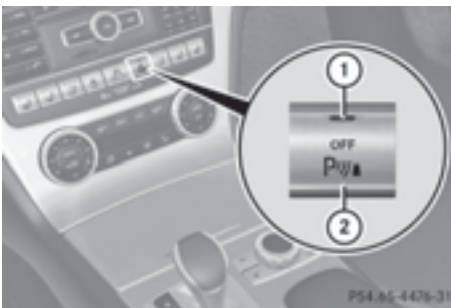

- ① Indicator lamp
- ② Deactivates/activates PARKTRONIC

If indicator lamp ① is on then PARKTRONIC is deactivated. Active Parking Assist is then also deactivated.

- ❗ PARKTRONIC is automatically activated when you turn the SmartKey to position 2 in the ignition lock.

Problems with PARKTRONIC

Problem	Possible causes/consequences and ► Solutions
<p>Only the red segments in the PARKTRONIC warning displays are lit. You also hear a warning tone for approximately two seconds.</p> <p>PARKTRONIC is deactivated after approximately five seconds, and the indicator lamp in the PARKTRONIC button lights up.</p>	<p>PARKTRONIC has malfunctioned and has switched off.</p> <p>► If problems persist, have PARKTRONIC checked at a qualified specialist workshop.</p>
<p>Only the red segments in the PARKTRONIC warning displays are lit. PARKTRONIC is deactivated after approximately five seconds.</p>	<p>The PARKTRONIC sensors are dirty or there is interference.</p> <p>► Clean the PARKTRONIC sensors (▷ page 543).</p> <p>► Switch the ignition back on.</p>
	<p>The problem may be caused by an external source of radio or ultrasound waves.</p> <p>► See if PARKTRONIC functions in a different location.</p>

Active Parking Assist

General notes

Active Parking Assist is an electronic parking aid with ultrasound. Ultrasound is used to measure the road on both sides of the vehicle. A suitable parking space is indicated by the parking symbol. Active steering intervention can assist you during parking.

You may also use PARKTRONIC (▷ page 199). When PARKTRONIC is switched off, Active Parking Assist is also unavailable.

Use Active Parking Assist for parking spaces:

- that are parallel to the direction of travel
- that are on straight roads, not bends
- that are on the same level as the road, e.g. not on the pavement

Important safety notes

Active Parking Assist is merely an aid. It is not a replacement for your attention to your immediate surroundings. You are always responsible for safe maneuvering, parking and exiting a parking space. When maneuvering, parking or pulling out of a parking space, make sure that there are no persons, animals or objects in the area in which you are maneuvering.

WARNING

The vehicle swings out when parking and in doing so could cross into the opposite lane. This could result in a collision with another road user. There is a risk of an accident.

Pay attention to other road users when parking. Stop the vehicle if necessary or cancel the Active Parking Assist parking procedure.

! If unavoidable, you should drive over obstacles such as curbs slowly and not at a sharp angle. Otherwise, you may damage the wheels or tires.

Active Parking Assist may possibly indicate parking spaces which are not suitable for parking, for example:

- where parking or stopping is prohibited
- in front of driveways or entrances and exits
- on unsuitable surfaces

Parking tips:

- On narrow roads, drive as close to the parking space as possible.
- Parking spaces that are littered or overgrown might be identified or measured incorrectly.
- Parking spaces that are partially occupied by trailer drawbars might not be identified as such or be measured incorrectly.
- Snowfall or heavy rain may lead to a parking space being measured inaccurately.
- Pay attention to the PARKTRONIC (▷ page 200) warning messages during the parking procedure.
- You can intervene in the steering procedure to correct it at any time. Active Parking Assist will then be canceled.
- When transporting a load which protrudes from your vehicle, you should not use Active Parking Assist.
- Never use Active Parking Assist when snow chains are installed.
- Make sure that the tire pressures are always correct. This has a direct influence on the parking characteristics of the vehicle.

Parking

Important safety notes

Objects located above the height range of Active Parking Assist will not be detected when the parking space is measured. These are not taken into account when the parking

procedure is calculated, e.g. overhanging loads, tail sections or loading ramps of goods vehicles. In some circumstances, Active Parking Assist may therefore guide you into the parking space too early.

WARNING

If there are objects above the detection range, Active Parking Assist may turn prematurely. You may cause a collision as a result. There is a risk of an accident.

If there are objects above the detection range, stop and deactivate Active Parking Assist.

WARNING

Active Parking Assist merely aids you by intervening actively in the steering. If you do not brake there is a risk of an accident.

Always apply the brakes yourself when maneuvering and parking.

Detecting parking spaces



Example: detected parking space

Active Parking Assist is switched on automatically when driving forwards. The system is operational at speeds of up to approximately 22 mph (35 km/h). While in operation, the system independently locates and measures parking spaces on both sides of the vehicle. When driving at speeds below 19 mph (30 km/h) you will see parking symbol ② as a status indicator in the instrument cluster. When a parking space has been detected, an arrow towards the right ③ or the left ① also appears.

By default, Active Parking Assist only displays parking spaces on the front-passenger side. Parking spaces on the driver's side are displayed as soon as the turn signal on the driver's side is activated. If you wish to park in a



space on the driver's side, the indicator on the driver's side must remain on. The turn signal must remain switched on until you acknowledge the use of Active Parking Assist by pressing the **OK** button on the multifunction steering wheel.

Active Parking Assist will only detect parking spaces:

- that are parallel to the direction of travel
- that are at least 59 in (1.5 m) wide
- that are at least 40 in (1.0 m) longer than your vehicle

A parking space is displayed while you are driving past it, and until you are approximately 50 ft (15 m) away from it.

Backing up into the parking space

- ▶ Stop the vehicle when the parking space symbol shows the desired parking space in the instrument cluster.
- ▶ Shift the transmission to position **R**. The **Start Park Assist? Yes: OK No: ** message appears in the multifunction display.
- ▶ **To cancel the procedure:** press the **** button on the multifunction steering wheel or pull away.

or

- ▶ **To park using Active Parking Assist:** press the **OK** button on the multifunction steering wheel. The **Park Assist Active Accelerate and Brake Observe Surroundings** message appears in the multifunction display.
- ▶ Let go of the multifunction steering wheel.
- ▶ Back up the vehicle, being ready to brake at all times. Do not exceed a maximum speed of approximately 6 mph (10 km/h) when backing up. Otherwise Active Parking Assist will be canceled.
- i** When parking in tight spaces, you will achieve the best results by backing up as

far as possible. When doing so, also observe the PARKTRONIC messages.

- ▶ Stop as soon as PARKTRONIC sounds the continuous warning tone, if not before. Additional maneuvering may be required in tight parking spaces.

The **Park Assist Active Select D Observe Surroundings** message appears in the multifunction display.

- ▶ Shift the transmission to position **D** while the vehicle is stationary. Active Parking Assist immediately steers in the other direction.

The **Park Assist Active Accelerate and Brake Observe Surroundings** message appears in the multifunction display.

- i** You will achieve the best results by waiting for the steering procedure to complete before pulling away.
- ▶ Drive forwards and be ready to brake at all times.
- ▶ Stop as soon as PARKTRONIC sounds the continuous warning tone, if not before.

The **Park Assist Active Select R Observe Surroundings** message appears in the multifunction display.

- ▶ Drive forwards and back up according to the information shown in the multifunction display.

As soon as the parking procedure is complete, the **Park Assist Finished** message appears in the multifunction display. PARKTRONIC continues to be available.

- ▶ Maneuver if necessary.
- ▶ Always observe the warning messages displayed by PARKTRONIC (▷ page 200).

Parking tips:

- On narrow roads, drive as close to the parking space as possible.
- Parking spaces that are littered, overgrown or partially occupied by trailer drawbars might be identified incorrectly or not at all.

- Snowfall or heavy rain may lead to a parking space being measured inaccurately.
 - The way your vehicle is positioned in the parking space after parking is dependent on various factors. These include the position and shape of the vehicles parked in front and behind it and the conditions of the location. In some cases, Active Parking Assist may guide you too far into a parking space, or not far enough into it. In some cases, it may also lead you across or onto the curb. If necessary, you should cancel the parking procedure with Active Parking Assist.
 - You can also engage forward gear prematurely. The vehicle redirects and does not drive as far into the parking space. Should a gear be changed too early, the parking procedure will be canceled. A sensible parking position can no longer be achieved from this position.
- ▶ Let go of the multifunction steering wheel.
 - ▶ Reverse the vehicle or drive forwards, being ready to brake at all times. Do not exceed a maximum speed of approximately 6 mph (10 km/h) when exiting a parking space. Otherwise Active Parking Assist will be canceled.
 - ▶ Stop as soon as PARKTRONIC sounds the continuous warning tone, if not before.
 - ▶ Shift the transmission to position **D** or **R** as required while the vehicle is stationary. Active Parking Assist immediately steers in the other direction.
- i** You will achieve the best results by waiting for the steering procedure to complete before pulling away.
- If you back up after activation, the steering wheel is moved to the straight-ahead position.

- ▶ Drive forwards or back up the vehicle, being ready to brake at all times.
- ▶ Stop as soon as PARKTRONIC sounds the continuous warning tone, if not before.
- ▶ Drive forwards and back up as instructed by the PARKTRONIC warning displays.

Once you have exited the parking space completely, the steering wheel is moved to the straight-ahead position. You hear a tone and the **Park Assist Finished** message appears in the multifunction display. You will then have to steer and merge into traffic on your own. PARKTRONIC is still available.

Exiting a parking space

Active Parking Assist can only assist you with exiting a parking space if you have parked the vehicle using Active Parking Assist.

- ▶ Start the engine.
- ▶ Switch on the turn signal on the side facing the street.
- ▶ Shift the transmission to position **D** or **R**. The **Start Park Assist? Yes: OK No: [↔]** message appears in the multifunction display.
- ▶ **To cancel the procedure:** press the **[↔]** button on the multifunction steering wheel or pull away.

or

- ▶ **To exit a parking space using Active Parking Assist:** press the **[OK]** button on the multifunction steering wheel. The **Park Assist Active Accelerate and Brake Observe Surroundings** message appears in the multifunction display.

Canceling Active Parking Assist

You can cancel Active Parking Assist at any time.

- ▶ Stop the movement of the multifunction steering wheel or steer yourself. Active Parking Assist will be canceled at once. The **Park Assist Canceled** message appears in the multifunction display.

or

- ▶ Press the PARKTRONIC button on the center console (▷ page 201). PARKTRONIC is switched off and Active Parking Assist is immediately canceled. The **Park Assist Canceled** message appears in the multifunction display.

Active Parking Assist is canceled automatically if:

- parking using Active Parking Assist is no longer possible
- you are driving faster than 6 mph (10 km/h)
- a wheel spins, ESP® intervenes or fails. The  ESP warning lamp lights up in the instrument cluster

A warning tone sounds. The parking symbol goes out and the **Park Assist Canceled** message appears in the multifunction display.

If Active Parking Assist is canceled, you must steer again yourself.

Rear view camera

General notes



Rear view camera ① is in the trunk lid handle.

Rear view camera ① is an optical parking and maneuvering aid. It shows the area behind

your vehicle with guide lines in the COMAND display.

The area behind the vehicle is displayed as a mirror image, as in the rear view mirror.

- i** The text of messages shown in the COMAND display depends on the language setting. The following are examples of rear view camera messages in the COMAND display.

Important safety notes

The rear view camera is only an aid. It is not a replacement for your attention to your immediate surroundings. You are always responsible for safe maneuvering and parking. When maneuvering or parking, make sure that there are no persons, animals or objects in the area in which you are maneuvering.

Under the following circumstances, the rear view camera will not function, or will function in a limited manner:

- the tailgate is open
- in heavy rain, snow or fog
- at night or in very dark places
- if the camera is exposed to very bright light
- if the area is lit by fluorescent light or LED lighting (the display may flicker)
- if there is a sudden change in temperature, e.g. when driving into a heated garage in winter
- if the camera lens is dirty or obstructed
- if the rear of your vehicle is damaged. In this event, have the camera position and setting checked at a qualified specialist workshop

The field of vision and other functions of the rear view camera may be restricted due to additional accessories on the rear of the vehicle (e.g. license plate holder, bicycle rack).

Activating/deactivating the rear view camera

- ▶ **To activate:** make sure that the SmartKey is in position **2** in the ignition lock.
- ▶ Make sure that the "Show rear view camera display" function is selected in COMAND (> page 317).
- ▶ Engage reverse gear.
The area behind the vehicle is shown in the COMAND display with guide lines.

To deactivate: the rear view camera deactivates if you shift the transmission to **P** or after driving forwards a short distance.

Displays in the COMAND display

The rear view camera may show a distorted view of obstacles, show them incorrectly or not at all. The rear view camera does not show objects in the following positions:

- very close to the rear bumper
 - under the rear bumper
 - in the area immediately above the tailgate handle
- !** Objects not at ground level may appear to be further away than they actually are, e.g.:
- the bumper of a parked vehicle
 - the drawbar of a trailer
 - the ball coupling of a trailer tow hitch
 - the rear section of an HGV
 - a slanted post
- Use the guidelines only for orientation. Approach objects no further than the bottom-most guideline.

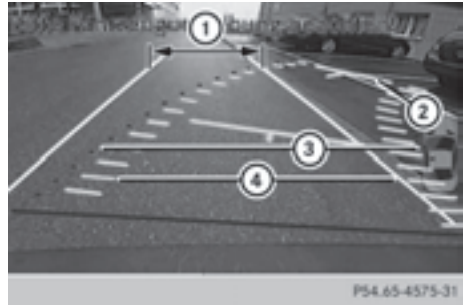

- ① White guide line without turning the steering wheel, vehicle width including the exterior mirrors (static)
- ② Yellow guide line at a distance of approximately 13 ft (4.0 m) from the rear of the vehicle
- ③ Red guide line for the vehicle width including the exterior mirrors, for current steering wheel angle (dynamic)
- ④ Yellow lane marking tires at current steering wheel angle (dynamic)



- ⑤ Yellow guide line at a distance of approximately 3 ft (1.0 m) from the rear of the vehicle
- ⑥ Vehicle center axle (marker assistance)
- ⑦ Bumper
- ⑧ Red guide line at a distance of approximately 10 in (0.25 m) from the rear of the vehicle

The guide lines are shown when the transmission is in position **R**.

The distance specifications only apply to objects that are at ground level.

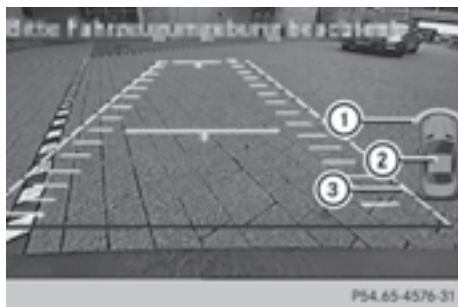

Additional messages for vehicles with PARKTRONIC

- ① Front warning display
- ② Additional PARKTRONIC measurement operational readiness indicator
- ③ Rear warning display

Vehicles with PARKTRONIC: if PARKTRONIC is operational (▷ page 200), an additional operational readiness indicator will appear in COMAND display ②. If the PARKTRONIC warning displays are active or light up, warning displays ① and ③ are also active or light up correspondingly in the COMAND display.

"Reverse parking" function

Backing up straight into a parking space without turning the steering wheel

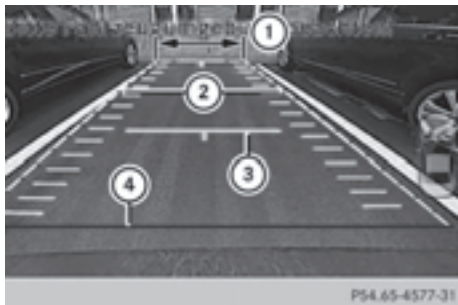

- ① White guide line without turning the steering wheel, vehicle width including the exterior mirrors (static)
- ② Red guide line for the vehicle width including the exterior mirrors, for current steering wheel angle (dynamic)

- ③ Yellow guide line at a distance of approximately 3 ft (1.0 m) from the rear of the vehicle
- ④ Red guide line at a distance of approximately 10 in (0.25 m) from the rear of the vehicle

- ▶ Make sure that the rear view camera is switched on (▷ page 207). The lane and the guide lines are shown.
- ▶ With the help of white guide line ①, check whether the vehicle will fit into the parking space.
- ▶ Using white guide line ① as a guide, carefully back up until you reach the end position. Red guide line ④ is then at the end of the parking space. The vehicle is almost parallel in the parking space.

Reverse perpendicular parking with the steering wheel at an angle



Turning the steering wheel

- ① Red guide line for the vehicle width including the exterior mirrors, for current steering wheel angle (dynamic)
- ② Parking space marking
- ▶ Make sure that the rear view camera is switched on (▷ page 207). The lane and the guide lines are shown.
- ▶ Drive past the parking space and bring the vehicle to a standstill.
- ▶ While the vehicle is at a standstill, turn the steering wheel in the direction of the parking

ing space until red guide line ① reaches parking space marking ②.

- ▶ Keep the steering wheel in that position and back up carefully.



Backing up with the steering wheel turned

- ① Red guide line for the vehicle width including the exterior mirrors, for current steering wheel angle (dynamic)

- ▶ Stop the vehicle when it is almost exactly in front of the parking space. The white lane should be as close to parallel with the parking space marking as possible.



Driving to the final position

- ① White guide line at current steering wheel angle
- ② Parking space marking
- ▶ Turn the steering wheel to the center position while the vehicle is stationary.

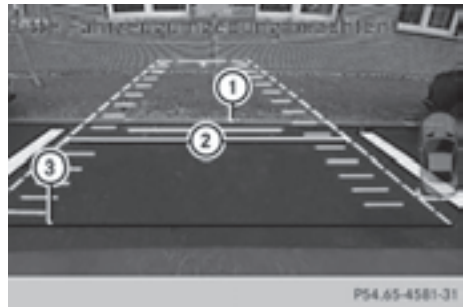

- ① End of parking space
- ② White guide line without turning the steering wheel
- ③ Red guide line at a distance of approximately 10 in (0.25 m) from the rear of the vehicle

- ▶ Back up carefully until you have reached the final position. Red guide line ③ is then at end of parking space ①. The vehicle is almost parallel in the parking space.

ATTENTION ASSIST

Important safety notes

ATTENTION ASSIST helps you during long, monotonous journeys, such as on highways. It is active in the range between 50 mph (80 km/h) and 112 mph (180 km/h).

If ATTENTION ASSIST detects typical indicators of fatigue or increasing lapses in concentration on the part of the driver, it suggests you take a break.

ATTENTION ASSIST assesses your level of fatigue or lapses in concentration by taking the following criteria into account:

- your personal driving style, e.g. steering characteristics
- journey details, e.g. time of day and length of journey

The functionality of ATTENTION ASSIST is restricted and warnings may be delayed or not occur at all:

- if the road condition is poor, e.g. if the surface is uneven or if there are potholes
- if there is a strong side wind
- if you have adopted a sporty driving style with high cornering speeds or high rates of acceleration
- if you are predominantly driving slower than 50 mph (80 km/h) or faster than 112 mph (180 km/h)
- if you are currently using COMAND or making a telephone call with it
- if the time has been set incorrectly
- in active driving situations, such as when you change lanes or change your speed

ATTENTION ASSIST is only an aid to the driver. It might not always recognize fatigue or increasing inattentiveness in time or fail to recognize them at all. The system is not a substitute for a well-rested and attentive driver.

Warning and display messages in the multifunction display

- ▶ Activate ATTENTION ASSIST using the on-board computer (▷ page 231).
If ATTENTION ASSIST is active, you will be warned no sooner than 20 minutes after your journey has begun. You then hear an intermittent warning tone twice and the **Attention Assist: Take a Break!** message appears in the multifunction display.
- ▶ If necessary, take a break.
- ▶ Press the **[OK]** or **[↩]** button to confirm the message.

On long journeys, take regular breaks in good time to allow yourself to rest properly. If you do not take a break and ATTENTION ASSIST still detects increasing lapses in concentration, you will be warned again after 15 minutes at the earliest.

ATTENTION ASSIST is reset when you continue your journey and starts assessing your tiredness again if:

- you switch off the engine.
- you take off your seat belt and open the driver's door, e.g. for a change of drivers or to take a break.

When ATTENTION ASSIST is deactivated, the **[OFF]** symbol appears in the multifunction display in the assistance graphics display.

Night View Assist Plus

General notes



In addition to the illumination provided by the normal headlamps, Night View Assist Plus uses infrared light to illuminate the road. Camera ② of Night View Assist Plus picks up the infrared light and displays a black and white image in COMAND. The image shown in COMAND corresponds to a road lit up by high-beam headlamps. This enables you to see the road's course and any obstacles in good time. When pedestrian recognition is active, pedestrians recognized by the system are visually highlighted in color in the Night View Assist Plus display with small frame corners.

i Infrared light is not visible to the human eye and therefore does not glare. Night View Assist Plus can therefore remain switched on even if there is oncoming traffic.

In addition, thermal imaging camera ① is integrated in the radiator grill. The camera helps detect pedestrians and animals.

Observe the notes on cleaning the thermal imaging camera and cleaning the windshield (▷ page 544).

Important safety notes

Night View Assist Plus is only an aid and is not a substitute for attentive driving. Do not rely on the Night View Assist Plus display. You are responsible for the distance to the vehicle in front, for vehicle speed and for braking in good time. Drive carefully and always adapt your driving style to suit the prevailing road and traffic conditions.

The system may be impaired or may not function if:

- if there is poor visibility, e.g. due to snow, rain, fog or spray
- if the windshield is dirty, fogged up or covered, for instance by a sticker, in the vicinity of the camera
- if the thermal imaging camera in the radiator grill is dirty, fogged up or covered
- on bends, hilltops or downhill gradients
- at high outside temperatures

Night View Assist Plus cannot display objects directly in front of or beside the vehicle. The actual distance to objects and pedestrians cannot be gaged accurately by looking at a screen.

It may be the case that other objects are marked or highlighted as well as pedestrians and animals.

Pedestrian and animal recognition

General notes

Pedestrian or animal recognition may be impaired or inoperative if:

- pedestrians or animals are partially or entirely obscured by other objects, e.g. parked vehicles
- the silhouette of the pedestrian or of the animal in the Night View Assist Plus display is incomplete or interrupted, e.g. by powerful light reflections
- pedestrians or animals do not contrast with the surroundings
- the camera system no longer recognizes pedestrians as persons due to special clothing or other objects
- pedestrians are not in an upright position, e.g. sitting, squatting or lying
- animals are not recognized by the system, e.g. because of their size or shape

Pedestrian and animal recognition is deactivated at temperatures above 90 °F (32 °C). The spotlight function and automatic delayed switch-off are then no longer active.

Pedestrian recognition



- ① Night View Assist Plus display in the COMAND display
- ② Readiness symbol for active pedestrian recognition
- ③ Highlighting
- ④ Pedestrian recognized

Night View Assist Plus can recognize pedestrians using typical characteristics, e.g. the

body contours and posture of a person standing upright.

Pedestrian recognition is then switched on automatically if:

- Night View Assist Plus is activated.
- you are driving faster than approximately 6 mph (10 km/h).
- it is dark.

If pedestrian recognition is active, symbol ② appears. Persons who are detected are highlighted by framing ③. If the pedestrian recognition system has brought a pedestrian to your attention, look through the windshield to evaluate the situation.

Animal recognition

Animals can be recognized in the following situations:

- darkness
- outside built-up areas
- below an outside temperature of 90 °F (32 °C)

Night View Assist Plus can recognize larger animals such as deer, cows or horses using typical characteristics.

The system does not detect:

- smaller animals, e.g. dogs and cats
- animals whose silhouette is not clearly recognizable

When detected, animals are marked with small color frame corners. In contrast to pedestrian recognition, there is no separate standby symbol in the multifunction display.

Activating/deactivating Night View Assist Plus

Activation conditions

You can only activate Night View Assist Plus if all of the following conditions are met:

- the ignition is switched on (▷ page 151) or the engine has been started.
- the light switch is in the **AUTO** or  position.
- reverse gear has not been engaged.

Activating Night View Assist Plus



- ▶ Press button ①.
The Night View Assist Plus display appears in the COMAND display.

i The infrared headlamps only switch on in the dark from speeds of approximately 6 mph (10 km/h). This means that you do not have the full visual range while the vehicle is stationary and cannot check whether Night View Assist Plus is working. The infrared headlamps are deactivated at speeds below 3 mph (5 km/h). The Night View image continues to be displayed.

Automatic activation

You can use COMAND to select the **Night View Assist Automatic Activation** option. The pedestrian and animal search function remains active even when the Night View image is not displayed. In the dark, in unlit surroundings and at speeds of more than 60 km/h, the Night View image is automati-

cally displayed in the COMAND display as soon as pedestrians or animals are detected.

- ▶ In COMAND, select automatic activation of Night View Assist Plus (▷ page 318)

Deactivating Night View Assist Plus



- ▶ Press button ①.
The Night View Assist Plus display goes off in the COMAND display. Night View Assist Plus is deactivated.

Spotlight function

General notes

- ❗ The function described below is not available in all countries.

Under certain conditions, the spotlight function uses the headlamps to flash at detected pedestrians.

The spotlight function is only active if:

- pedestrian recognition is active
- the road surface is not lit
- the driving speed is at least 40 mph (60 km/h)
- the "Adaptive Highbeam Assist" (▷ page 128) or "Adaptive Highbeam Assist PLUS" function is activated

- reverse gear has not been engaged

The spotlight function is not active or is active only to a limited extent if:

- you are driving in city traffic
- there are pedestrians located in the area of an oncoming vehicle or a vehicle in front

Activating the spotlight function

The pedestrian detection with spotlight function is running in the background. If the prerequisites are met, the spotlight function uses the headlamps to flash four short pulses at a pedestrian detected on or near to the road surface.

- ▶ In the light menu, select the spotlight function of Night View Assist Plus (▷ page 233).

The spotlight function does not flash at animals.

Display in the assistance graphic



Pedestrian symbol ① in the assistance graphic indicates the status of the spotlight function. If the symbol is displayed not filled in, the function is switched on. If the symbol is displayed filled in, the conditions for the spotlight function are met.

Displaying the assistance graphic

- ▶ Select the **Assistance Graphic** from the **DriveAssist** menu (▷ page 230).

Problems with Night View Assist Plus

Problem	Possible causes/consequences and ► Solutions
The picture quality of Night View Assist Plus has deteriorated.	The windshield is fogged up on the inside. ► Fold down camera cover (▷ page 544). ► Defrost the windshield (▷ page 144).
	The windshield is iced up. ► De-ice the windshield (▷ page 143).
	The windshield wipers are smearing the windshield. ► Replace the wiper blades (▷ page 131).
	The windshield is smeared after the vehicle has been cleaned in a car wash. ► Clean the windshield (▷ page 542).
	There is windshield chip damage in the camera's field of vision. ► Replace the windshield.
The pedestrian and animal recognition is not available.	The infrared camera in the radiator grill is dirty. ► Use a soft cloth and water to clean the infrared camera.

Active Driving Assistance package

General notes

The Active Driving Assistance package consists of DISTRONIC PLUS (▷ page 182), Active Blind Spot Assist (▷ page 214) and Active Lane Keeping Assist (▷ page 217).

Active Blind Spot Assist

General notes

Active Blind Spot Assist uses a radar sensor system to monitor the side areas of your vehicle which are behind the driver. A warning display in the exterior mirrors draws your attention to vehicles detected in the monitored area. If you then switch on the corresponding turn signal to change lanes, you will also receive an optical and audible collision warning. If a risk of lateral collision is detected, corrective braking may help you avoid a

collision. To support the course-correcting brake application, Active Blind Spot Assist also uses the forward-facing radar sensor system.

Active Blind Spot Assist supports you from a speed of approximately 20 mph (30 km/h). For Active Blind Spot Assist to assist you when driving, the radar sensor system must be operational.

Important safety notes

Active Blind Spot Assist is only an aid. It may fail to detect some vehicles and is no substitute for attentive driving.

WARNING

Active Blind Spot Assist does not react to:

- vehicles overtaken too closely on the side, placing them in the blind spot area
- vehicles which approach with a large speed differential and overtake your vehicle

As a result, Active Blind Spot Assist may neither give warnings nor intervene in such situations. There is a risk of an accident.

Always observe the traffic conditions carefully, and maintain a safe lateral distance.

i USA only: This device has been approved by the FCC as a "Vehicular Radar System". The radar sensor is intended for use in an automotive radar system only. Removal, tampering, or altering of the device will void any warranties, and is not permitted by the FCC. Do not tamper with, alter, or use in any non-approved way.

Any unauthorized modification to this device could void the user's authority to operate the equipment.

i Canada only: This device complies with RSS-210 of Industry Canada. Operation is subject to the following two conditions:

1. This device may not cause harmful interference, and
 2. this device must accept any interference received, including interference that may cause undesired operation of the device.
- Removal, tampering, or altering of the device will void any warranties, and is not permitted. Do not tamper with, alter, or use in any non-approved way.

Any unauthorized modification to this device could void the user's authority to operate the equipment.

Radar sensors

The Active Blind Spot Assist radar sensors are integrated into the front and rear bumpers and behind a cover in the radiator grill. Make sure that the bumpers and the cover in the radiator grill are free of dirt, ice or slush. The rear sensors must not be covered, for example by cycle racks or overhanging cargo. Following a severe impact or in the event of damage to the bumpers, have the function of the radar sensors checked at a qualified specialist workshop. Active Blind Spot Assist may otherwise no longer work properly.

Monitoring area

WARNING

Active Blind Spot Assist does not detect all traffic situations and road users. There is a risk of an accident.

Always make sure that there is sufficient distance on the side for other traffic or obstacles.

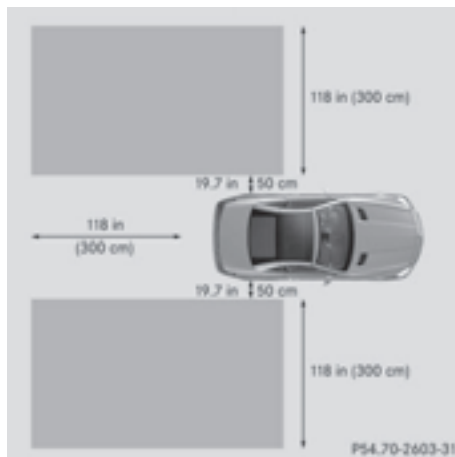

Active Blind Spot Assist monitors the area up to 10 ft (3.0 m) behind your vehicle and directly next to your vehicle, as shown in the diagram.

The detection of obstacles can be impaired in the case of:

- dirt on the sensors or anything else covering the sensors
- poor visibility, e.g. due to rain, snow or spray

Vehicles in the monitoring range are then not indicated or indicated with a delay.

Active Blind Spot Assist may not detect narrow vehicles, such as motorcycles or bicycles, or may only detect them too late.

If the lanes are narrow, vehicles driving in the lane beyond the lane next to your vehicle may be indicated, especially if the vehicles are not driving in the middle of their lane. This may be the case if there are vehicles driving at the inner edge of their lanes.

Due to the nature of the system:

- warnings may be issued in error when driving close to crash barriers or similar solid lane borders.
- warnings may be interrupted when driving alongside particularly long vehicles, e.g. trucks, for a prolonged time.

Indicator and warning display



① Yellow indicator lamp/red warning lamp

Active Blind Spot Assist is not active at speeds below approximately 20 mph (30 km/h). Vehicles in the monitoring range are then not indicated.

When Active Blind Spot Assist is activated, indicator lamp ① in the exterior mirrors lights up yellow at speeds of up to 20 mph (30 km/h). At speeds above 20 mph (30 km/h), the indicator lamp goes out and Active Blind Spot Assist is operational.

If a vehicle is detected within the blind spot monitoring range at speeds above 20 mph (30 km/h), warning lamp ① on the corresponding side lights up red. This warning is always given when a vehicle enters the blind spot monitoring range from behind or from the side. When you overtake a vehicle, the warning only occurs if the difference in speed is less than 7 mph (12 km/h).

The yellow indicator lamp goes out if reverse gear is engaged. In this event, Active Blind Spot Assist is no longer active.

The brightness of the indicator/warning lamps is adjusted automatically according to the ambient light.

Visual and acoustic collision warning



When you switch on the turn signals to change lanes and a vehicle is detected in the side monitoring range, you receive a visual and acoustic collision warning. You then hear a double warning tone and red warning lamp ① flashes. If the turn signal remains on, detected vehicles are indicated by the flashing of red warning lamp ①. There are no further warning tones.

Course-correcting brake application

⚠ WARNING

A course-correcting brake application cannot always prevent a collision. There is a risk of an accident.

Always steer, brake or accelerate yourself, especially if Active Blind Spot Assist warns you or makes a course-correcting brake application. Always maintain a safe distance at the sides.



If a course-correcting brake application occurs, red warning lamp ① flashes in the exterior mirror and a dual warning tone sounds. In addition, display ② appears in the multifunction display.

If Active Blind Spot Assist detects a risk of a lateral collision in the monitoring range, a course-correcting brake application is carried out. This is meant to assist you in avoiding a collision.

The course-correcting brake application is available in the speed range between 20 mph (30 km/h) and 120 mph (200 km/h).

Either a very slight course-correcting brake application, or none at all, may occur if:

- there are vehicles or obstacles, e.g. crash barriers, located on both sides of your vehicle.
- a vehicle approaches you too closely at the side.
- you have adopted a sporty driving style with high cornering speeds.
- you clearly brake or accelerate.

- a driving safety system intervenes, e.g. ESP® or PRE-SAFE® Brake.
- ESP® is switched off.
- a loss of tire pressure or a defective tire is detected.

Switching on Active Blind Spot Assist

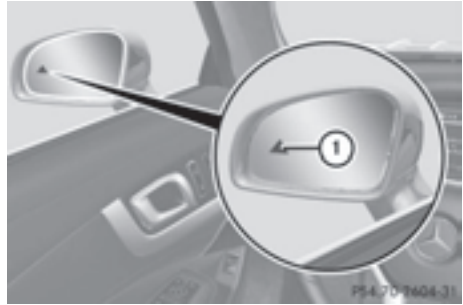

- ▶ Make sure that the radar sensor system (▷ page 235) and Active Blind Spot Assist (▷ page 231) are activated in the on-board computer.
- ▶ Turn the SmartKey to position 2 in the ignition lock. Warning lamps ① in the exterior mirrors light up red for approximately 1.5 seconds and then turn yellow.

Active Lane Keeping Assist

General notes



Active Lane Keeping Assist monitors the area in front of your vehicle by means of camera ① at the top of the windshield. Active Lane Keeping Assist detects lane markings on the road and warns you before you leave your

lane unintentionally. If you do not react to the warning, a lane-correcting application of the brakes can bring the vehicle back into the original lane.

If you select **km** on the on-board computer in the **Display Unit Speed-/Odometer** function (▷ page 232), Active Lane Keeping Assist is activated starting at a speed of 60 km/h. If the **miles** display unit is selected, the assistance range begins at 40 mph.

Important safety notes

If you fail to adapt your driving style, Active Lane Keeping Assist can neither reduce the risk of accident nor override the laws of physics. Lane Keeping Assist cannot take into account the road, traffic and weather conditions. Lane Keeping Assist is merely an aid. You are responsible for the distance to the vehicle in front, for vehicle speed, for braking in good time and for staying in your lane.

Active Lane Keeping Assist cannot continuously keep your vehicle in its lane.

WARNING

Active Lane Keeping Assist cannot always clearly detect lane markings.

In such cases, Active Lane Keeping Assist can:

- give an unnecessary warning and then make a course-correcting brake application to the vehicle
- not give a warning or intervene

There is a risk of an accident.

Always pay particular attention to the traffic situation and keep within the lane, especially if Active Lane Keeping Assist alerts you. Terminate the intervention in a non-critical driving situation.

The system may be impaired or may not function if:

- there is poor visibility, e.g. due to insufficient illumination of the road, or due to snow, rain, fog or spray
- there is glare, e.g. from oncoming traffic, the sun or reflections (e.g. when the road surface is wet)
- the windshield is dirty, fogged up, damaged or covered, for instance by a sticker, in the vicinity of the camera
- there are no, several or unclear lane markings for a lane, e.g. in areas with road construction work
- the lane markings are worn away, dark or covered up, e.g. by dirt or snow
- the distance to the vehicle in front is too small and the lane markings thus cannot be detected
- the lane markings change quickly, e.g. lanes branch off, cross one another or merge
- the road is narrow and winding
- there are strong shadows cast on the lane

Warning vibration in the steering wheel

A warning may be given if a front wheel passes over a lane marking. It will warn you by means of intermittent vibration in the steering wheel for up to 1.5 seconds.

In order that you are warned only when necessary and in good time if you cross the lane marking, the system recognizes certain conditions and warns you accordingly.

The warning vibration occurs earlier if:

- you approach the outer lane marking on a bend.
- the road has very wide lanes, e.g. a highway.
- the system recognizes solid lane markings.

The warning vibration occurs later if:

- the road has narrow lanes.
- you cut the corner on a bend.

Lane-correcting brake application

WARNING

A lane-correcting brake application cannot always bring the vehicle back into the original lane. There is a risk of an accident.

Always steer, brake or accelerate yourself, especially if Active Lane Keeping Assist warns you or makes a lane-correcting brake application.

WARNING

Active Lane Keeping Assist does not detect traffic conditions or road users. In very rare cases, the system may make an inappropriate brake application, e.g. after intentionally driving over a solid lane marking. There is a risk of an accident.

An inappropriate brake application may be interrupted at any time if you steer slightly in the opposite direction. Always make sure that there is sufficient distance on the side for other traffic or obstacles.

In rare cases, Active Lane Keeping Assist can recognize unclear markings or particular structures on the roadway as solid lane markings. An inappropriate brake application may be interrupted at any time if you steer slightly in the opposite direction.



If a lane-correcting brake application occurs, display  appears in the multifunction display.

If you leave your lane, under certain circumstances the vehicle will brake briefly on one

side. This is meant to assist you in bringing the vehicle back to the original lane.

This function is available in the range between 40 mph and 120 mph (60 km/h and 200 km/h).

A lane-correcting brake application can only be made after driving over a solid, recognizable lane marking. Before this, a warning must be given by means of intermittent vibration in the steering wheel. In addition, a lane with lane markings on both sides must be recognized. The brake application also slightly reduces vehicle speed.

 A further lane-correcting brake application can only occur after your vehicle has returned to the original lane.

No lane-correcting brake application occurs if:

- you clearly and actively steer, brake or accelerate.
- you cut the corner on a sharp bend.
- you have switched on the turn signals.
- a driving safety system intervenes, e.g. ESP®, PRE-SAFE® Brake or Active Blind Spot Assist.
- you have adopted a sporty driving style with high cornering speeds or high rates of acceleration.
- ESP® is switched off.
- the transmission is not in position **D**.
- a loss of tire pressure or a defective tire has been detected and displayed.

Active Lane Keeping Assist does not detect traffic situations or road users. An inappropriate brake application may be interrupted at any time if you:

- steer slightly in the opposite direction
- switch on the turn signal
- clearly brake or accelerate

A lane-correcting brake application is interrupted automatically if:

- a driving safety system intervenes, e.g. ESP®, PRE-SAFE® Brake or Active Blind Spot Assist.
- lane markings can no longer be recognized.

Switching on Active Lane Keeping Assist

► Switch on Active Lane Keeping Assist using the on-board computer; to do so, select **Standard** or **Adaptive** (▷ page 231).

If you drive at speeds above 40 mph (60 km/h) and lane markings are detected, the lines in the assistance graphics display (▷ page 230) are shown in green. Lane Keeping Assist is ready for use.

If **Standard** is selected, no warning vibration occurs if:

- you have switched on the turn signals. In this event, the warnings are suppressed for a certain period of time.
- a driving safety system intervenes, such as ABS, BAS or ESP®.

When **Adaptive** is selected, no warning vibration occurs if:

- you have switched on the turn signals. In this event, the warnings are suppressed for a certain period of time.
- a driving safety system intervenes, e.g. ABS, BAS or ESP®.
- you accelerate hard, e.g. kickdown.
- you brake hard.
- you steer actively, e.g. swerve to avoid an obstacle or change lanes quickly.
- you cut the corner on a sharp bend.

Useful information	222
Important safety notes	222
Displays and operation	222
Menus and submenus	225
Display messages	239
Warning and indicator lamps	269

Useful information

- i** This Operator's manual describes all models and all standard and optional equipment of your vehicle available at the time of publication of the Operator's manual. Country-specific differences are possible. Please note that your vehicle may not be equipped with all features described. This also applies to safety-related systems and functions.
- i** Read the information on qualified specialist workshops (▷ page 35).

Important safety notes

WARNING

If you operate information systems and communication equipment integrated in the vehicle while driving, you will be distracted from traffic conditions. You could also lose control of the vehicle. There is a risk of an accident.

Only operate the equipment when the traffic situation permits. If you are not sure that this is possible, park the vehicle paying attention to traffic conditions and operate the equipment when the vehicle is stationary.

You must observe the legal requirements for the country in which you are currently driving when operating the on-board computer.

WARNING

If the instrument cluster has failed or malfunctioned, you may not recognize function restrictions in systems relevant to safety. The operating safety of your vehicle may be impaired. There is a risk of an accident.

Drive on carefully. Have the vehicle checked at a qualified specialist workshop immediately.

The on-board computer only shows messages or warnings from certain systems in the multifunction display. You should therefore make sure your vehicle is operating safely at all

times. Otherwise, a vehicle that is not operating safely may cause an accident.

If the operating safety of your vehicle is impaired, pull over as soon as it is safe to do so. Contact a qualified specialist workshop. For an overview, see the instrument panel illustration (▷ page 41).



Displays and operation

Instrument cluster lighting

The lighting in the instrument cluster, in the displays and the controls in the vehicle interior can be adjusted using the brightness control knob.

The brightness control knob is on the bottom left of the instrument cluster (▷ page 41).

- ▶ Turn the brightness control knob counter-clockwise or clockwise.

If the light switch is set to ,  or , the brightness is dependent upon the brightness of the ambient light.

- i** The light sensor in the instrument cluster automatically controls the brightness of the multifunction display.

In daylight, the displays in the instrument cluster are not lit.

Coolant temperature display

WARNING

Opening the hood when the engine is overheated or when there is a fire in the engine compartment could expose you to hot gases or other service products. There is a risk of injury.

Let an overheated engine cool down before opening the hood. If there is a fire in the engine compartment, keep the hood closed and contact the fire department.

- !** A display message is shown if the coolant temperature is too high.

If the coolant temperature is over 248 °F (120 °C), do not continue driving. The engine will otherwise be damaged.

The coolant temperature gauge is in the instrument cluster on the right-hand side (▷ page 41).

Under normal operating conditions and with the specified coolant level, the coolant temperature may rise to 248 °F (120 °C).

Tachometer

! Do not drive in the overrevving range, as this could damage the engine.

The red band in the tachometer indicates the engine's overrevving range.

The fuel supply is interrupted to protect the engine when the red band is reached.

Outside temperature display

You should pay special attention to road conditions when temperatures are around freezing point.

Bear in mind that the outside temperature display indicates the temperature measured and does not record the road temperature.

The outside temperature display is in the multifunction display (▷ page 224).

Changes in the outside temperature are displayed after a short delay.

Speedometer with segments

The segments in the speedometer indicate which speed range is available.

- Cruise control activated (▷ page 180):
The segments light up from the stored speed to the maximum speed.
- DISTRONIC PLUS activated (▷ page 182):
One or two segments in the set speed range light up.
- DISTRONIC PLUS detects a vehicle in front:

The segments between the speed of the vehicle in front and the stored speed light up.

Operating the on-board computer

Overview









- ① Multifunction display
- ② Switches on the Voice Control System; see the separate operating instructions
- ③ Right control panel
- ④ Left control panel
- ⑤ Back button



► **To activate the on-board computer:** turn the SmartKey to position **1** in the ignition lock.



You can control the multifunction display and the settings in the on-board computer using the buttons on the multifunction steering wheel.

Left control panel



	• Calls up the menu and menu bar
	
	Press briefly:
	<ul style="list-style-type: none"> • Scrolls in lists • Selects a submenu or function • In the Audio menu: selects a stored station, an audio track or a video scene • In the Tel (telephone) menu: switches to the phone book and selects a name or telephone number
	Press and hold:
	<ul style="list-style-type: none"> • In the Audio menu: selects the previous/next station or selects an audio track or a video scene using rapid scrolling • In the Tel (Telephone) menu: starts rapid scrolling if the phone book is open
	<ul style="list-style-type: none"> • Confirms a selection/display message • In the Tel (telephone) menu: switches to the telephone book and starts dialing the selected number • In the Audio menu: stops the station search function at the desired station

Right control panel

	<ul style="list-style-type: none"> • Rejects or ends a call • Exits phone book/redial memory
	<ul style="list-style-type: none"> • Makes or accepts a call • Switches to the redial memory

	• Adjusts the volume
	
	• Mute

Back button

	Press briefly:
	<ul style="list-style-type: none"> • Back • Switches off the Voice Control System; see the separate operating instructions • Hides display messages/calls up the last Trip menu function used • Exits the telephone book/redial memory
	Press and hold:
	<ul style="list-style-type: none"> • Calls up the standard display in the Trip menu

Multifunction display



- ① Transmission position (▷ page 161)
- ② Drive program (▷ page 161)
- ③ Text field
- ④ Menu bar

- ⑤ Time (▷ page 307)
- ⑥ Outside temperature or speed (▷ page 232)

Text field ③ shows the selected menu or submenu as well as display messages.

- ▶ **To show menu bar ④:** press the ◀ or ▶ button on the steering wheel. Menu bar ④ disappears after a few seconds of inactivity.

The following messages may appear in the multifunction display:

- ↑ Gearshift recommendation when shifting manually (▷ page 165)
- ← P → Active Parking Assist (▷ page 202)
- CRUISE Cruise control (▷ page 180)
- Adaptive Highbeam Assist (▷ page 128)
- A ECO start/stop function (▷ page 155)
- HOLD HOLD function (▷ page 191)

Menus and submenus

Menu overview

Press the ◀ or ▶ button on the steering wheel to call up the menu bar and select a menu.

Operating the on-board computer (▷ page 223).

Depending on the equipment installed in the vehicle, you can call up the following menus:

- **Trip** menu (▷ page 225)
- **Navi** menu (navigation instructions) (▷ page 227)
- **Audio** menu (▷ page 228)
- **Tel** menu (telephone) (▷ page 229)
- **DriveAssist** menu (assistance) (▷ page 230)
- **Serv** menu (▷ page 231)
- **Sett** menu (settings) (▷ page 232)
- **AMG** menu in AMG vehicles (▷ page 236)

Trip menu

Standard display



- ▶ Press and hold the ◀ button on the steering wheel until the **Trip** menu with trip odometer ① and odometer ② is shown.

Trip computer "From Start" or "From Reset"

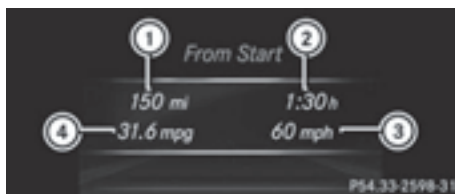

Example: trip computer "From Start"

- ① Distance
- ② Time
- ③ Average speed
- ④ Average fuel consumption
- ▶ Press the ◀ or ▶ button on the steering wheel to select the **Trip** menu.
- ▶ Press the ▲ or ▼ button to select **From Start** or **From Reset**.

The values in the **From Start** submenu are calculated from the start of a journey whilst the values in the **From Reset** submenu are calculated from the last time the submenu was reset (▷ page 226).

The **From Start** trip computer is automatically reset when:

- the ignition has been switched off for more than four hours.
- 999 hours have been exceeded.
- 9,999 miles have been exceeded.

The **From Reset** trip computer is automatically reset if the value exceeds 9,999 hours or 99,999 miles.

ECO display



Example: ECO display

- ▶ Press the or button on the steering wheel to select the **Trip** menu.
- ▶ Press the or button to select **ECO DISPLAY**.

If the ignition remains switched off for longer than four hours, the ECO display will be automatically reset.

For further information on the ECO display, see (▷ page 175).

Displaying the range and current fuel consumption

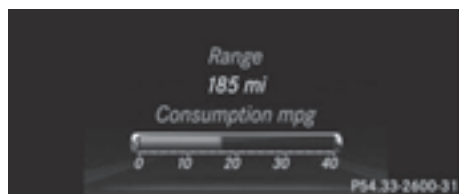

- ▶ Press the or button on the steering wheel to select the **Trip** menu.
- ▶ Press the or button to select the current fuel consumption (not for AMG vehicles) and the approximate range.

The approximate range that can be covered depends on the fuel level and your current driving style. If there is only a small amount of fuel left in the fuel tank, the display shows a vehicle being refueled  instead of the range.

Digital speedometer



- ① Shift recommendation (▷ page 165)
- ② Digital speedometer

Gearshift recommendation ① is not given on AMG vehicles.

- ▶ Press the or button on the steering wheel to select the **Trip** menu.
- ▶ Press the or button to select the digital speedometer.

Resetting values

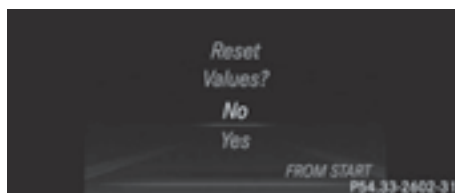

Example: resetting the trip computer "From Start"

- ▶ Press the or button on the steering wheel to select the **Trip** menu.
- ▶ Press the or button to select the function that you wish to reset.
- ▶ Press the button.
- ▶ Press the button to select **Yes** and press the button to confirm.

You can reset the values of the following functions:

- Trip odometer
- "From Start" trip computer
- "From Reset" trip computer
- ECO display



i If you reset the values in the ECO display, the values in the "From start" trip computer are also reset. If you reset the values in the

"From start" trip computer, the values in the ECO display are also reset.

Navigation system menu

Displaying navigation instructions

In the **Navi** menu, the multifunction display shows navigation instructions. For further information on navigation, see (▷ page 318).

- ▶ Switch on COMAND (▷ page 295).
- ▶ Press the  or  button on the steering wheel to select the **Navi** menu.

Route guidance not active



- ① Direction of travel
- ② Current road

Route guidance active

No change of direction announced



- ① Distance to the destination
- ② Distance to the next change of direction
- ③ Current road
- ④ "Follow the road's course" symbol

Change of direction announced without a lane recommendation



- ① Road into which the change of direction leads
- ② Distance to change of direction and visual distance display
- ③ Change-of-direction symbol

When a change of direction is announced, you will see symbol ③ for the change of direction and distance graphic ②. The distance indicator shortens towards the top of the display as you approach the point of the announced change of direction.

Change of direction announced with a lane recommendation



- ① Road into which the change of direction leads
- ② Distance to change of direction and visual distance display
- ③ Recommended lane and new lane during a change of direction
- ④ Lanes not recommended
- ⑤ Recommended lane
- ⑥ Change-of-direction symbol

On multilane roads, lane recommendations can be displayed for the next change of direction if the digital map supports this data. During the change of direction, new lanes may be added.

Recommended lane and new lane during a change of direction ③: in this lane you will be

able to complete the next two changes of direction without changing lane.

Lane not recommended (4): you will not be able to complete the next change of direction if you stay in this lane.

Recommended lane (5): in this lane, you will only be able to complete the next change of direction without changing lane.





Other status indicators of the navigation system



- : you have reached the destination or an intermediate destination.
- **New Route...** or **Calculating Route:** calculating a new route.
- **Off Map** or **Off Mapped Road:** the vehicle position is outside the area of the digital map (off-map position).
- **No Route:** no route could be calculated to the selected destination.

Audio menu



Selecting a radio station



- ① Waveband
- ② Station frequency with memory position
- **Station ②** is displayed with the station frequency or station name. The memory position is only displayed along with station ② if this has been stored.
- ▶ Switch on COMAND (▷ page 295).
- ▶ Select Radio (▷ page 435).
- ▶ Press the  or  button on the steering wheel to select the **Audio** menu.
- ▶ **To select a stored station:** briefly press the  or  button.

- ▶ **To select a station from the station list:** press and briefly hold the  or  button.

If no station list is received:

- ▶ **To select a station using the station search:** press and briefly hold the  or  button.

• **Switching wavebands** (▷ page 436).

• **Storing stations** (▷ page 437).

• **SIRIUS XM satellite radio functions** like a normal radio.









For more information on satellite radio operation (▷ page 439).

Operating an audio player or audio media



Example: CD/DVD changer display

Audio data from various audio devices or media can be played, depending on the equipment installed in the vehicle.

- ▶ Switch on COMAND (▷ page 295).
- ▶ Select the audio player or audio media (▷ page 446).
- ▶ Press the  or  button on the steering wheel to select the **Audio** menu.
- ▶ **To select the next/previous track:** briefly press the  or  button.
- ▶ **To select a track from the track list (rapid scrolling):** press and hold the  or  button until desired track ① has been reached.
- If you press and hold  or , the rapid scrolling speed is increased. Not all audio drives or data carriers support this function.

If track information is stored on the audio device or medium, the multifunction display will show the number and title of the track. The current track does not appear in audio AUX mode (**A**uxiliary audio mode: external audio source connected).

Video DVD operation



Example: CD/DVD changer display

- ▶ Switch on COMAND (▷ page 295).
- ▶ Select video DVD (▷ page 474).
- ▶ Press the ◀ or ▶ button on the steering wheel to select the **Audio** menu.
- ▶ **To select the next/previous scene:** briefly press the ▲ or ▼ button.
- ▶ **To select a scene from the scene list (rapid scrolling):** press and hold the ▲ or ▼ button until desired scene ① has been reached.

Telephone menu

Introduction

WARNING

If you operate information systems and communication equipment integrated in the vehicle while driving, you will be distracted from traffic conditions. You could also lose control of the vehicle. There is a risk of an accident.

Only operate the equipment when the traffic situation permits. If you are not sure that this is possible, park the vehicle paying attention to traffic conditions and operate the equipment when the vehicle is stationary.

When telephoning, you must observe the legal requirements for the country in which you are currently driving.

- ▶ Switch on the mobile phone (see the separate operating instructions).
- ▶ Switch on COMAND (▷ page 295).
- ▶ Establish a Bluetooth® connection to COMAND (▷ page 380).
- ▶ Press the ◀ or ▶ button on the steering wheel to select the **Te1** menu.

You will see one of the following display messages in the multifunction display:

- **Phone READY** or the name of the network provider: the mobile phone has found a network and is ready to receive.
- **Phone No Service:** there is no network available or the mobile phone is searching for a network.

Accepting a call

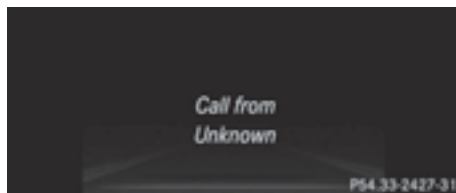

Example: incoming call

- ▶ Press the  button on the steering wheel to accept an incoming call.

If someone calls you when you are in the **Te1** menu, a display message appears in the multifunction display.







You can accept a call even if you are not in the **Te1** menu.

Rejecting or ending a call





- ▶ Press the  button on the steering wheel.

You can end or reject a call even if you are not in the **Te1** menu.







Dialing an entry from the phone book

- ▶ Press the  or  button on the steering wheel to select the **Te1** menu.
- ▶ Press the ,  or  button to switch to the phone book.
- ▶ Press the  or  button to select the desired name.



or

- ▶ **To begin rapid scrolling:** press and hold the  or  button for longer than one second. Rapid scrolling stops when you release the button or reach the end of the list.
- ▶ **If only one telephone number is stored for a name:** press the  or  button to start dialing.

or







- ▶ **If there is more than one number for a particular name:** press the  or  button to display the numbers.
- ▶ Press the  or  button to select the number you want to dial.
- ▶ Press the  or  button to start dialing.

or



- ▶ **To exit the phone book:** press the  or  button.

Redialing

The on-board computer saves the last names or numbers dialed in the redial memory.

- ▶ Press the  or  button on the steering wheel to select the **Te1** menu.
- ▶ Press the  button to switch to the redial memory.
- ▶ Press the ,  button to select the desired name or number.
- ▶ Press the  or  button to start dialing.

or

- ▶ **To exit the redial memory:** press the  or  button.

Assistance menu

Introduction







In the **DriveAssist** menu, you have the following options:

- Displaying the assistance graphic (▷ page 230)
- AMG vehicles only: setting the vehicle level (▷ page 197)
- Activating/deactivating PRE-SAFE® Brake (▷ page 231)
- Activating/deactivating ATTENTION ASSIST (▷ page 231)
- Activating/deactivating Active Blind Spot Assist (▷ page 231)
- Activating/deactivating Active Lane Keeping Assist (▷ page 231)

Displaying the assistance graphic



- ▶ Press the  or  button on the steering wheel to select the **DriveAssist** menu.
- ▶ Press  or  to select **Assistance Graphic**.
- ▶ Press the  button. The multifunction display shows the DIS-TRONIC PLUS distance display in the assistance graphic.

The assistance graphic displays the status of and information from the following driving systems or driving safety systems:

- ATTENTION ASSIST (▷ page 209)
- Active Lane Keeping Assist (▷ page 217)
- PRE-SAFE® Brake (▷ page 77)
- Spotlight function of Night View Assist Plus (▷ page 233)

Activating/deactivating PRE-SAFE® Brake

PRE-SAFE® Brake is only available in vehicles with DISTRONIC PLUS.

- ▶ Press or on the steering wheel to select the **DriveAssist** menu.
- ▶ Press the or button to select **PRE-SAFE Brake**.
- ▶ Press the button.
The current selection is displayed.
- ▶ **To activate/deactivate:** press the button again.
When the PRE-SAFE® Brake is deactivated, the multifunction display in the assistance graphic shows the symbol.

For more information on PRE-SAFE® Brake, see (▷ page 77).

Activating/deactivating ATTENTION ASSIST

- ▶ Press or on the steering wheel to select the **DriveAssist** menu.
- ▶ Press the or button to select **ATTENTION ASSIST**.
- ▶ Press the button.
The current selection is displayed.
- ▶ **To activate/deactivate:** press the button again.
When ATTENTION ASSIST is deactivated, the symbol appears in the multifunction display in the assistance graphics display.

For further information about ATTENTION ASSIST, see (▷ page 209).

Activating/deactivating Active Blind Spot Assist

- ▶ Press the or button on the steering wheel to select the **DriveAssist** menu.
- ▶ Press the or button to select **Blind Spot Assist**.
- ▶ Press the button.
The current selection is displayed.
- ▶ **To activate/deactivate:** press the button again.

For further information about Active Blind Spot Assist, see (▷ page 214).

Activating/deactivating Active Lane Keeping Assist

- ▶ Press the or button on the steering wheel to select the **DriveAssist** menu.
- ▶ Press or to select **Lane Keeping Assist**.
- ▶ Press the button.
The current selection is displayed.
- ▶ Press to confirm.
- ▶ Press or to set **Off**, **Standard** or **Adaptive**.
- ▶ Press the button to save the setting.
When Active Lane Keeping Assist is activated, the multifunction display shows the lane markings as bright lines in the assistance graphic.

For further information about Active Lane Keeping Assist, see (▷ page 217).

Maintenance menu

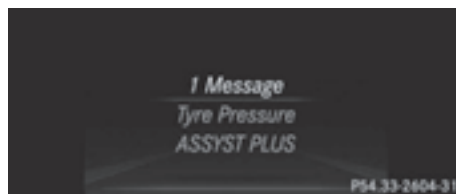

In the **Service** menu, you have the following options:

- Calling up display messages (▷ page 239)
- Checking the tire pressure electronically (▷ page 575)
- Calling up the service due date (▷ page 539)

Settings menu

Introduction



In the **Sett** menu, you have the following options:

- Changing the instrument cluster settings (▷ page 232)
- Changing the light settings (▷ page 232)
- Changing the vehicle settings (▷ page 234)
- Changing the convenience settings (▷ page 235)
- Restoring the factory settings (▷ page 236)

Instrument cluster

Selecting the unit of measurement for distance

You can determine whether the multifunction display shows some messages in miles or kilometers.

- ▶ Press the or button on the steering wheel to select the **Sett** menu.
- ▶ Press the or button to select the **Instrument Cluster** submenu.
- ▶ Press to confirm.

- ▶ Press the or button to select the **Display Unit Speed-/Odometer** function.

You will see the selected setting: **km** or **miles**.

- ▶ Press the button to save the setting.

The selected unit of measurement for distance applies to:

- Digital speedometer in the **Trip** menu
- Odometer and the trip odometer
- Trip computer
- Current consumption and the range
- Navigation instructions in the **Navi** menu
- Cruise control
- DISTRONIC PLUS
- ASSYST PLUS service interval display

Selecting the permanent display function

You can determine whether the multifunction display permanently shows your speed or the outside temperature.







- ▶ Press the or button on the steering wheel to select the **Sett** menu.
- ▶ Press the or button to select the **Instrument Cluster** submenu.
- ▶ Press to confirm.
- ▶ Press the or button to select the **Permanent Display** function. You will see the selected setting **Outside Temperature** or **Additional Speedometer [km/h]/Additional Speedometer [mph]**.
- ▶ Press the button to save the setting.

- i** The speed is highlighted in km/h or in mph conversely to your speedometer.

Lights

Setting the daytime running lamps

- i** This function is not available in Canada.









- ▶ Press the  or  button on the steering wheel to select the **Sett** menu.
- ▶ Press the  or  button to select the **Light** submenu.
- ▶ Press  to confirm.
- ▶ Press the  or  button to select the **Daytime Running Lights** function.

If the **Daytime Running Lights** function has been switched on, the cone of light and the  symbol in the multifunction display are shown in orange.

- ▶ Press the  button to save the setting.









Further information on daytime running lamps (> page 122).





Switching the spotlight function on/off

- ▶ Press the  or  button on the steering wheel to select the **Settings** menu.
 - ▶ Press the  or  button to select the **Lights** submenu.
 - ▶ Press  to confirm.
 - ▶ Press the  or  to select the **Spotlight** function.
- When the spotlight function is activated, the assistance graphic shows the pedestrian symbol.
- ▶ Press the  button to save the setting.













Further information on the spotlight function of Night View Assist Plus (> page 213).

Setting the brightness of the ambient lighting









- ▶ Press the  or  button on the steering wheel to select the **Sett** menu.
 - ▶ Press the  or  button to select the **Light** submenu.
 - ▶ Press  to confirm.
 - ▶ Press the  or  button to select the **Amb. Light +/-** function.
- You will see the selected setting.
- ▶ Press  to confirm.

- ▶ Press the  or  button to adjust the brightness to a level from **Off** to **Level 5** (bright).
- ▶ Press the  or  button to save the setting.

Setting the ambient lighting color

- ▶ Press the  or  button on the steering wheel to select the **Sett** menu.
- ▶ Press the  or  button to select the **Light** submenu.
- ▶ Press  to confirm.
- ▶ Press the  or  button to select the **Ambient Light Color** function.
- ▶ Press  to confirm.
- ▶ Press the  or  button to set the color to **SOLAR**, **SOLAR orange** or **SOLAR red**.
- ▶ Press the  or  button to save the setting.

Activating/deactivating surround lighting and exterior lighting delayed switch-off

- ▶ Press the  or  button on the steering wheel to select the **Sett** menu.
 - ▶ Press the  or  button to select the **Light** submenu.
 - ▶ Press  to confirm.
 - ▶ Press the  or  button to select the **Surround Lighting** function.
- When the **Surround Lighting** function is activated, the light cone and the area around the vehicle are displayed in orange in the multifunction display.
- ▶ Press the  button to save the setting.

Deactivating delayed switch-off of the exterior lighting temporarily:

- ▶ Before leaving the vehicle, turn the SmartKey to position **0** in the ignition lock.
 - ▶ Turn the SmartKey to position **2** in the ignition lock.
- The exterior lighting delayed switch-off is deactivated.

Delayed switch-off of the exterior lighting is reactivated the next time you start the engine.

If you have activated the **Surround Lighting** function and the light switch is set to **AUTO**, the following functions are activated when it is dark:







- **surround lighting:** the exterior lighting remains lit for 40 seconds after unlocking with the SmartKey. If you start the engine, the surround lighting is switched off and automatic headlamp mode is activated (> page 122).
- **exterior lighting delayed switch-off:** the exterior lighting remains lit for 60 seconds after the engine is switched off. If you close all the doors and the trunk lid, the exterior lighting goes off after 15 seconds.

i Depending on your vehicle's equipment, when the surround lighting and delayed switch-off exterior lighting are on, the following light up:

- Parking lamps
- Low-beam headlamps
- Daytime running lamps
- Side marker lamps
- Surround lighting in the exterior mirrors

Activating/deactivating the interior lighting delayed switch-off

If you activate the **Interior Lighting Delay** function, the interior lighting remains on for 20 seconds after you remove the SmartKey from the ignition lock.







- ▶ Press the  or  button on the steering wheel to select the **Sett** menu.
- ▶ Press the  or  button to select the **Lights** submenu.
- ▶ Press **OK** to confirm.
- ▶ Press the  or  button to select the **Interior Lighting Delay** function. If the **Interior Lighting Delay** function has been switched on, the vehicle interior is

displayed in orange in the multifunction display.

- ▶ Press the **OK** button to save the setting.

Vehicle

Activating/deactivating the automatic door locking mechanism

- ▶ Press the  or  button on the steering wheel to select the **Sett** menu.
- ▶ Press the  or  button to select the **Vehicle** submenu.
- ▶ Press **OK** to confirm.
- ▶ Press  or  to select the **Automatic Door Lock** function.

When the **Automatic Door Lock** function is activated, the left-hand vehicle door is displayed in orange in the multifunction display.







- ▶ Press the **OK** button to save the setting.

If you activate the **Automatic Door Lock** function, the vehicle is centrally locked above a speed of around 9 mph (15 km/h).

For further information on the automatic locking feature, see (> page 89).

Activating/deactivating the acoustic locking verification signal









If you switch on the **Acoustic Lock** function, an acoustic signal sounds when you lock the vehicle.

- ▶ Press the  or  button on the steering wheel to select the **Sett** menu.
- ▶ Press the  or  button to select the **Vehicle** submenu.
- ▶ Press **OK** to confirm.
- ▶ Press the  or  button to select the **Acoustic Lock** function.

If the **Acoustic Lock** function is activated, the  symbol in the multifunction display lights up orange.

- ▶ Press the **OK** button to save the setting.

Activating/deactivating the radar sensor system

- ▶ Press the  or  button on the steering wheel to select the **Settings** menu.
- ▶ Press the  or  button to select the **Vehicle** submenu.
- ▶ Press  to confirm.
- ▶ Press the  or  button to select **Radar Sensor (See Oper. Manual)**:. You will see the selected setting: **Enabled** or **Disabled**.
- ▶ Press the  button to save the setting.

The following systems are switched off when the radar sensor system is deactivated:

- DISTRONIC PLUS (▷ page 182)
- BAS PLUS (▷ page 72)
- PRE-SAFE® Brake (▷ page 77)
- Active Blind Spot Assist (▷ page 214)

Convenience

Activating/deactivating the EASY-ENTRY/EXIT feature

WARNING





When the EASY-ENTRY/EXIT feature adjusts the steering wheel, you and other vehicle occupants – particularly children – could become trapped. There is a risk of injury.





While the EASY-ENTRY/EXIT feature is making adjustments, make sure that no one has any body parts in the sweep of the steering wheel.

If somebody becomes trapped:

- press one of the memory function position buttons, or
- move the switch for steering wheel adjustment in the opposite direction to that in which the steering wheel is moving.









The adjustment process is stopped.

- ▶ Press the  or  button on the steering wheel to select the **Sett** menu.
- ▶ Press the  or  button to select the **Convenience** submenu.

- ▶ Press  to confirm.
- ▶ Press the  or  button to select the **Easy Entry/Exit** function. If the **Easy Entry/Exit** function is activated, the vehicle steering wheel is displayed in orange in the multifunction display.
- ▶ Press the  button to save the setting.

Further information on the EASY-ENTRY/EXIT feature (▷ page 115).

Switching the belt adjustment on/off

- ▶ Press the  or  button on the steering wheel to select the **Sett** menu.
- ▶ Press the  or  button to select the **Convenience** submenu.
- ▶ Press  to confirm.
- ▶ Press the  or  button to select the **Belt Adjustment** function. When the **Belt Adjustment** function is activated, the vehicle seat belt is displayed in orange in the multifunction display.
- ▶ Press the  button to save the setting.

For further information on belt adjustment, see (▷ page 55).







Switching the fold-in mirrors when locking feature on/off

This function is only available on vehicles with the memory function (▷ page 119).

This function is only available in Canada.

When you activate the **Auto. Mirror Folding** function, the exterior mirrors are folded in when the vehicle is locked.

If you unlock the vehicle and then open a door, the exterior mirrors fold out again.

- ▶ Press the  or  button on the steering wheel to select the **Sett** menu.
- ▶ Press the  or  button to select the **Convenience** submenu.
- ▶ Press  to confirm.
- ▶ Press the  or  button to select the **Auto. Mirror Folding** function. If the **Auto. Mirror Folding** function is activated, the vehicle's exterior mirror is

displayed in orange in the multifunction display.

- ▶ Press the **OK** button to save the setting.



- ① To fold the exterior mirrors in or out

If you have switched the **Auto. Mirror Folding** on and you fold the exterior mirrors in using button ①, they will not fold out automatically (▷ page 117).

You can then only fold out the exterior mirrors using button ①.

If you have switched the function on and you fold the exterior mirrors in using the button on the door (▷ page 117), they will not fold out automatically. The exterior mirrors can then only be folded out using the button on the door.

Restoring the factory settings

- ▶ Press the **◀** or **▶** button on the steering wheel to select the **Sett.** menu.
- ▶ Press the **▼** or **▲** button to select the **Factory Setting** submenu.
- ▶ Press **OK** to confirm.
The **Reset All Settings?** message appears.
- ▶ Press the **▼** or **▲** button to select **No** or **Yes**.
- ▶ Press the **OK** button to confirm the selection.

If you have selected **Yes**, the multifunction display shows a confirmation message.

For safety reasons, the **Daytime Running Lights** function in the **Light** submenu is only reset if the vehicle is stationary.

AMG menu in AMG vehicles

AMG displays

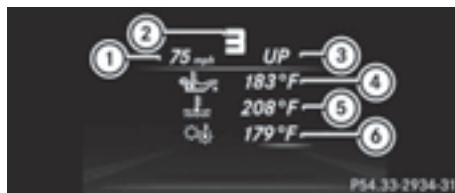

- ① Digital speedometer
- ② Gear indicator
- ③ Uphift indicator
- ④ Engine oil temperature
- ⑤ Coolant temperature
- ⑥ Transmission fluid temperature

- ▶ Press **◀** or **▶** on the steering wheel to select the **AMG** menu.

Uphift indicator **UP** ③ indicates that the engine has reached the overrevving range when in the manual gearshift program. Uphift indicator **UP** ③ fades out other messages until you have shifted up.

If the engine oil temperature is below 160 °F (71 °C), oil temperature ④ is shown in blue. Avoid driving at full engine output during this time.

If the transmission fluid temperature is below 122 °F (50 °C), oil temperature ⑥ is shown in blue. Avoid driving at full engine output during this time.

SETUP



- ① Drive program (**C/SS+/M**)
- ② ESP® mode (**ON/OFF**) or SPORT handling mode (**SPORT**)
- ③ Suspension tuning (**SPORT/COMFORT**)

SETUP shows the drive program, the ESP® (Electronic Stability Program) mode and the SPORT handling mode.

- ▶ Press the ◀ or ▶ button on the steering wheel to select the **AMG** menu.
- ▶ Press the ▲ button repeatedly until SETUP is displayed.

or

- ▶ Briefly press the AMG button on the center console (▷ page 163).

RACETIMER

Displaying and starting RACETIMER

The RACETIMER is only intended for use on a closed race circuit. Do not use the function on public roads.



- ① Lap
- ② RACETIMER

You can start the RACETIMER when the engine is running or if the SmartKey is in position **2** in the ignition lock.

- ▶ Press ◀ or ▶ on the steering wheel to select the **AMG** menu.
- ▶ Press the ▲ button repeatedly until the RACETIMER is shown.
- ▶ **To start:** press the **OK** button to start the RACETIMER.

Displaying the intermediate time



- ▶ Press the ◀ or ▶ button to select **Interm. Time**.
- ▶ Press **OK** to confirm. The intermediate time is displayed for five seconds.

Starting a new lap



- ① RACETIMER
 - ② Fastest lap time (best lap)
 - ③ Lap
- ▶ Press **OK** to confirm **New Lap**.

i It is possible to store a maximum of sixteen laps. The 16th lap can only be completed with **Finish Lap**.

Stopping the RACETIMER

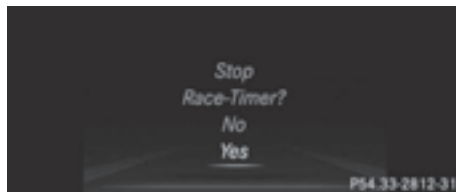

- ▶ Press the ⏪ button on the steering wheel.
- ▶ Press **OK** to confirm **Yes**.

The RACETIMER interrupts timing when you stop the vehicle and turn the SmartKey to position **1** in the ignition lock. If you turn the SmartKey to position **2** or **3** and then press **OK** to confirm **Start**, timing is continued.

Resetting the current lap

- ▶ Stop the RACETIMER.
- ▶ Press the ◀ or ▶ button to select **Reset Lap**.
- ▶ Press **OK** to reset the lap time to "0".

Deleting all laps



If you switch off the engine, the RACETIMER is reset to "0" after 30 seconds. All laps are deleted.

You cannot delete individual stored laps. If you have stopped 16 laps, the current lap does not have to be reset.

- ▶ Reset the current lap.
- ▶ Press **OK** to confirm **Reset**. **Reset Race Timer?** appears in the multi-function display.
- ▶ Press the **▼** button to select **Yes** and press the **OK** button to confirm. All laps are deleted.

Overall statistics



- ① RACETIMER overall evaluation
- ② Total time driven
- ③ Average speed
- ④ Distance covered
- ⑤ Maximum speed

This function is shown if you have stored at least one lap and stopped the RACETIMER.

- ▶ Press **◀** or **▶** on the steering wheel to select the **AMG** menu.
- ▶ Press the **▲** button repeatedly until the overall evaluation is shown.

Lap statistics



- ① Lap
- ② Lap time
- ③ Average lap speed
- ④ Lap length
- ⑤ Top speed during lap

This function is only available if you have stored at least two laps and have stopped the RACETIMER.

- ▶ Press **◀** or **▶** on the steering wheel to select the **AMG** menu.
- ▶ Press the **▲** button repeatedly until the lap evaluation is shown. Each lap is shown in a separate submenu. The fastest lap is indicated by flashing symbol ①.
- ▶ Press the **▲** or **▼** button to select a different lap evaluation.

Display messages

Introduction

General notes

Display messages appear in the multifunction display.

Display messages with graphic displays may be shown in simplified form in the Operator's Manual and may differ from the messages shown in the multifunction display.



Please respond in accordance with the display messages and follow the additional notes in this Operator's Manual.

Certain display messages are accompanied by an audible warning tone or a continuous tone.

When you stop and park the vehicle, please observe the notes on:

- HOLD function (▷ page 191)
- Parking (▷ page 171)

Hiding display messages







- ▶ Press the  or  button on the steering wheel to hide the display message. The display message is cleared.

The multifunction display shows high-priority display messages in red. Some high-priority display messages cannot be hidden.

The multifunction display shows these messages continuously until the causes for the messages have been remedied.

Message memory

The on-board computer saves certain display messages in the **message memory**. You can call up the display messages:

- ▶ Press the  or  button on the steering wheel to select the **Serv.** menu. If there are display messages, the multifunction display shows **2 Messages**, for example.
- ▶ Press the  or  button to select the entry, e.g. **2 Messages**.
- ▶ Press  to confirm.
- ▶ Press the  or  button to scroll through the display messages.

When the ignition is switched off, all display messages are deleted, apart from some high-priority display messages. Once the causes of the high-priority display messages have been rectified, the corresponding display messages are also deleted.

Safety systems

Display messages



Currently Unavailable See Operator's Manual

Possible causes/consequences and ► Solutions

ABS (Anti-lock Braking System), ESP[®] (Electronic Stability Program), BAS (Brake Assist), PRE-SAFE[®], the HOLD function and hill start assist are temporarily unavailable.

BAS PLUS and PRE-SAFE[®] Brake may also have failed.

In addition, the ,  and  warning lamps light up in the instrument cluster.

ATTENTION ASSIST is deactivated.

Possible causes are:

- self-diagnosis is not yet complete.
- the on-board voltage may be insufficient.

 **WARNING**

The brake system continues to function normally, but without the functions listed above. The wheels could therefore lock if you brake hard, for example.

The steerability and braking characteristics may be severely affected. The braking distance in an emergency braking situation can increase.

If ESP[®] is not operational, ESP[®] is unable to stabilize the vehicle. There is an increased risk of skidding and an accident.

► Carefully drive a suitable distance, making slight steering movements at a speed above 12 mph (20 km/h).

If the display message disappears, the functions mentioned above are available again.

If the display message continues to be displayed:





- Drive on carefully.
- Visit a qualified specialist workshop.



Inoperative See Operator's Manual

ABS, ESP[®], BAS, PRE-SAFE[®], the HOLD function and hill start assist are unavailable due to a malfunction.





BAS PLUS and PRE-SAFE[®] Brake may also have failed.











The  (USA only)/ (Canada only), ,  and  warning lamps in the instrument cluster also light up.









ATTENTION ASSIST is deactivated.









 **WARNING**















The brake system continues to function normally, but without the functions listed above. The wheels could therefore lock if you brake hard, for example.







Display messages	Possible causes/consequences and ► Solutions
	<p>The steerability and braking characteristics may be severely affected. The braking distance in an emergency braking situation can increase.</p> <p>If ESP® is not operational, ESP® is unable to stabilize the vehicle. There is an increased risk of skidding and an accident.</p> <ul style="list-style-type: none"> ► Drive on carefully. ► Visit a qualified specialist workshop immediately.
<div data-bbox="120 424 202 469" style="border: 1px solid black; padding: 2px; display: inline-block;">  </div> <p data-bbox="115 472 348 560">Currently Unavailable See Operator's Manual</p>	<p>ESP®, BAS, PRE-SAFE®, the HOLD function and hill start assist are temporarily unavailable.</p> <p>BAS PLUS and PRE-SAFE® Brake may also have failed. In addition, the  and  warning lamps light up in the instrument cluster.</p> <p>ATTENTION ASSIST is deactivated.</p> <p>The self-diagnosis function might not be complete, for example.</p> <p> WARNING</p> <p>The brake system continues to function normally, but without the functions listed above.</p> <p>The braking distance in an emergency braking situation can thus increase.</p> <p>If ESP® is not operational, ESP® is unable to stabilize the vehicle. There is an increased risk of skidding and an accident.</p> <ul style="list-style-type: none"> ► Carefully drive a suitable distance, making slight steering movements at a speed above 12 mph (20 km/h). If the display message disappears, the functions mentioned above are available again. <p>If the display message continues to be displayed:</p> <ul style="list-style-type: none"> ► Drive on carefully. ► Visit a qualified specialist workshop.

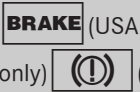

Display messages	Possible causes/consequences and ► Solutions
 <p>Inoperative See Operator's Manual</p>	<p>ESP®, BAS, PRE-SAFE®, the HOLD function and hill start assist are unavailable due to a malfunction.</p> <p>BAS PLUS and PRE-SAFE® Brake may also have failed.</p> <p>In addition, the  and  warning lamps light up in the instrument cluster.</p> <p>ATTENTION ASSIST is deactivated.</p> <p>⚠ WARNING</p> <p>The brake system continues to function normally, but without the functions listed above.</p> <p>The braking distance in an emergency braking situation can thus increase.</p> <p>If ESP® is not operational, ESP® is unable to stabilize the vehicle. There is an increased risk of skidding and an accident.</p> <ul style="list-style-type: none"> ► Drive on carefully. ► Visit a qualified specialist workshop.
 <p>Inoperative See Operator's Manual</p>	<p>EBD (electronic brake force distribution), ABS, ESP®, BAS, PRE-SAFE®, the HOLD function and hill start assist are unavailable due to a malfunction.</p> <p>BAS PLUS and PRE-SAFE® Brake may also have failed.</p> <p>In addition, the ,  and  warning lamps light up in the instrument cluster and a warning tone sounds.</p> <p>⚠ WARNING</p> <p>The brake system continues to function normally, but without the functions listed above. The front and rear wheels could therefore lock if you brake hard, for example.</p> <p>The steerability and braking characteristics may be severely affected. The braking distance in an emergency braking situation can increase.</p> <p>If ESP® is not operational, ESP® is unable to stabilize the vehicle. There is an increased risk of skidding and an accident.</p> <ul style="list-style-type: none"> ► Drive on carefully. ► Visit a qualified specialist workshop immediately.
 <p>Please Release Parking Brake</p>	<p>The red  (USA only)/ (Canada only) indicator lamp flashes and a warning tone sounds. A condition for automatic release of the electric parking brake is not fulfilled (► page 172).</p> <p>You are driving with the electric parking brake applied.</p> <ul style="list-style-type: none"> ► Release the electric parking brake manually.



Display messages	Possible causes/consequences and ► Solutions
	<p>The red  (USA only)/ (Canada only) indicator lamp flashes and a warning tone sounds.</p> <p>You are making an emergency stop using the electric parking brake (► page 172).</p>
<p> (USA only)  (Canada only)</p> <p>Parking Brake See Operator's Manual</p>	<p>The yellow  warning lamp lights up.</p> <p>The electric parking brake is malfunctioning.</p> <p>To apply:</p> <ul style="list-style-type: none"> ► Switch the ignition off. ► Press the electric parking brake handle for at least ten seconds. ► Shift the transmission to P. ► Consult a qualified specialist workshop. <p>The yellow  warning lamp and the red  (USA only)/ (Canada only) indicator lamp light up.</p> <p>The electric parking brake is malfunctioning.</p> <p>To release:</p> <ul style="list-style-type: none"> ► Switch off the ignition and turn it back on. ► Release the electric parking brake manually. <p>or</p> <ul style="list-style-type: none"> ► Release the electric parking brake automatically (► page 172). <p>If the electric parking brake still cannot be released:</p> <ul style="list-style-type: none"> ► Do not drive on. ► Consult a qualified specialist workshop.

Display messages	Possible causes/consequences and ► Solutions
	<p>The red  (USA only)/ (Canada only) indicator lamp flashes and the yellow  warning lamp lights up. The electric parking brake is malfunctioning.</p> <p>To release:</p> <ul style="list-style-type: none"> ► Switch off the ignition and turn it back on. ► Release the electric parking brake manually. <p>To apply:</p> <ul style="list-style-type: none"> ► Switch off the ignition and turn it back on. ► Apply the electric parking brake manually. <p>If the red  (USA only)/ (Canada only) indicator lamp continues to flash:</p> <ul style="list-style-type: none"> ► Do not drive on. ► Secure the vehicle against rolling away (► page 590). ► Shift the transmission to P. ► Turn the front wheels towards the curb. ► Consult a qualified specialist workshop.
	<p>The yellow  warning lamp lights up. The red  (USA only)/ (Canada only) indicator lamp flashes for about ten seconds after the electric parking brake has been applied or released. It then goes out or remains lit. The electric parking brake is malfunctioning.</p> <ul style="list-style-type: none"> ► Switch off the ignition and turn it back on. ► Apply the electric parking brake. <p>If it is not possible to engage the electric parking brake:</p> <ul style="list-style-type: none"> ► Shift the transmission to P. ► Visit a qualified specialist workshop. <p>If it is not possible to release the electric parking brake:</p> <ul style="list-style-type: none"> ► Release the electric parking brake automatically (► page 172). <p>If the electric parking brake still cannot be released:</p> <ul style="list-style-type: none"> ► Consult a qualified specialist workshop.

Display messages	Possible causes/consequences and ► Solutions
	<p>The yellow  warning lamp lights up. If you manually apply or release the electric parking brake, the red  (USA only)/ (Canada only) indicator lamp flashes.</p> <p>The electric parking brake is malfunctioning. It is not possible to apply the electric parking brake manually.</p> <ul style="list-style-type: none"> ► Shift the transmission to P as the electric parking brake is not being applied automatically. ► Visit a qualified specialist workshop.
<p> (USA only)  (Canada only)</p> <p>Parking Brake Inoperative</p>	<p>The yellow  warning lamp lights up. The red  (USA only)/ (Canada only) indicator lamp flashes for about ten seconds after the electric parking brake has been applied or released. It then goes out or remains lit.</p> <p>The electric parking brake is malfunctioning, e.g. because of over-voltage or undervoltage.</p> <ul style="list-style-type: none"> ► Remove the cause for the overvoltage or undervoltage, e.g. by charging the battery or restarting the engine. ► Engage or release the electric parking brake. <p>If it remains impossible to apply or release the electric parking brake:</p> <ul style="list-style-type: none"> ► Switch off the ignition and turn it back on. ► Engage or release the electric parking brake. <p>If the electric parking brake still cannot be released:</p> <ul style="list-style-type: none"> ► Consult a qualified specialist workshop. <p>If the electric parking brake still cannot be applied:</p> <ul style="list-style-type: none"> ► Visit a qualified specialist workshop. <p>The yellow  warning lamp lights up and the red  (USA only)/ (Canada only) indicator lamp flashes.</p> <p>It is not possible to apply the electric parking brake manually.</p> <ul style="list-style-type: none"> ► Shift the transmission to P. ► Visit a qualified specialist workshop.
<p> (USA only)  (Canada only)</p> <p>Turn On the Ignition to Release the Parking Brake</p>	<p>The red  (USA only)/ (Canada only) indicator lamp lights up.</p> <p>You attempted to release the electric parking brake while the ignition was switched off.</p> <ul style="list-style-type: none"> ► SmartKey: turn the SmartKey to position 1 in the ignition lock. ► KEYLESS-GO: switch on the ignition.

Display messages	Possible causes/consequences and ► Solutions
<p> (USA only)  (Canada only)</p> <p>Check Brake Fluid Level</p>	<p>There is not enough brake fluid in the brake fluid reservoir. In addition, the  (USA only)/ (Canada only) warning lamp lights up in the instrument cluster and a warning tone sounds.</p> <p> WARNING</p> <p>The braking effect may be impaired. There is a risk of an accident.</p> <ul style="list-style-type: none"> ► Pull over and stop the vehicle safely as soon as possible, paying attention to road and traffic conditions. Do not continue driving under any circumstances. ► Secure the vehicle against rolling away (► page 171). ► Consult a qualified specialist workshop. ► Do not add brake fluid. This does not correct the malfunction.
<p></p> <p>Check Brake Pad Wear</p>	<p>The brake pads/linings have reached their wear limit.</p> <ul style="list-style-type: none"> ► Visit a qualified specialist workshop.
<p></p> <p>mbrace Inoperative</p>	<p>One or more main features of the mbrace system are malfunctioning.</p> <ul style="list-style-type: none"> ► Have the mbrace system checked immediately at a qualified specialist workshop.
<p>PRE-SAFE Inoperative See Operator's Manual</p>	<p>Important functions of PRE-SAFE® have failed. All other occupant safety systems, e.g. air bags, remain available.</p> <ul style="list-style-type: none"> ► Visit a qualified specialist workshop immediately.

Display messages	Possible causes/consequences and ► Solutions
<p>PRE-SAFE Functions Cur- rently Limited See Operator's Manual</p>	<p>PRE-SAFE® Brake is deactivated or temporarily inoperative. Possible causes are:</p> <ul style="list-style-type: none"> • function is impaired due to heavy rain or snow. • the sensors in the radiator trim and the bumper are dirty. • the radar sensor system is temporarily inoperative, e.g. due to electromagnetic radiation emitted by nearby TV or radio stations or other sources of electromagnetic radiation. • AMG vehicles: ESP® is deactivated. • the system is outside the operating temperature range. • the on-board voltage is too low. <p>When the causes stated above no longer apply, the display message disappears.</p> <p>PRE-SAFE® Brake is operational again.</p> <ul style="list-style-type: none"> ► Pull over and stop the vehicle safely as soon as possible, paying attention to road and traffic conditions. ► Secure the vehicle against rolling away (▷ page 171). ► Clean the sensors in the radiator trim and the bumper (▷ page 543). ► Restart the engine. ► AMG vehicles: reactivate ESP® (▷ page 76).
<p>PRE-SAFE Functions Limited See Operator's Man- ual</p>	<p>PRE-SAFE® Brake is inoperative due to a malfunction. BAS PLUS or the distance warning signal may also have failed.</p> <ul style="list-style-type: none"> ► Visit a qualified specialist workshop.
<p> Malfunction Ser- vice Required</p>	<p>The roll bars are defective.</p> <p> WARNING</p> <p>The roll bars will then possibly not be extended in the event of an accident.</p> <p>There is an increased risk of injury.</p> <ul style="list-style-type: none"> ► Visit a qualified specialist workshop immediately.





Display messages	Possible causes/consequences and ► Solutions
 <p>SRS Malfunction Service Required</p>	<p>The restraint system is faulty. The  warning lamp also lights up in the instrument cluster.</p> <p> WARNING</p> <p>The air bags or Emergency Tensioning Devices may either be triggered unintentionally or, in the event of an accident, may not be triggered.</p> <p>There is an increased risk of injury.</p> <p>► Visit a qualified specialist workshop.</p> <p>For further information about the restraint system, see (► page 50).</p>
 <p>Front Left Malfunction Service Required or Front Right Malfunction Service Required</p>	<p>The restraint system has malfunctioned at the front on the left or right. The  warning lamp also lights up in the instrument cluster.</p> <p> WARNING</p> <p>The air bags or Emergency Tensioning Devices may either be triggered unintentionally or, in the event of an accident, may not be triggered.</p> <p>There is an increased risk of injury.</p> <p>► Visit a qualified specialist workshop.</p>
 <p>Left Side Curtain Airbag Malfunction Service Required or Right Side Curtain Airbag Malfunction Service Required</p>	<p>There is a malfunction in the left-hand and/or right-hand head bag. The  warning lamp also lights up in the instrument cluster.</p> <p> WARNING</p> <p>The left or right head bag may either be triggered unintentionally or, in the event of an accident, may not be triggered.</p> <p>There is an increased risk of injury.</p> <p>► Visit a qualified specialist workshop.</p>

Display messages	Possible causes/consequences and ► Solutions
<p data-bbox="116 177 353 296">Front-Passenger Airbag Disabled See Operator's Manual</p>	<p data-bbox="371 177 1001 233">The front-passenger air bag and front-passenger knee bag are deactivated during the journey, although:</p> <ul data-bbox="371 245 975 371" style="list-style-type: none"> <li data-bbox="371 245 479 304">• an adult or <li data-bbox="371 317 975 371">• a person larger than a certain size is occupying the front-passenger seat <p data-bbox="371 381 1031 437">If additional forces are applied to the seat, the system may interpret the occupant's weight as lower than it actually is.</p> <p data-bbox="371 453 535 483"> WARNING</p> <p data-bbox="371 496 1020 552">The front-passenger front air bag and front passenger knee bag may not be triggered in the event of an accident.</p> <p data-bbox="371 560 729 587">There is an increased risk of injury.</p> <ul data-bbox="371 596 1031 1329" style="list-style-type: none"> <li data-bbox="371 596 1031 652">► Pull over and stop the vehicle safely as soon as possible, paying attention to road and traffic conditions. <li data-bbox="371 660 936 687">► Secure the vehicle against rolling away (> page 171). <li data-bbox="371 695 624 722">► Switch the ignition off. <li data-bbox="371 730 815 758">► Have the occupant get out of the vehicle. <li data-bbox="371 766 1031 821">► Keep the seat unoccupied, close the front-passenger door and switch on the ignition. <li data-bbox="371 829 1031 916">► Observe the PASSENGER AIR BAG OFF indicator lamp in the center console and the multifunction display and check the following: Seat unoccupied and ignition switched on: <ul data-bbox="400 963 1031 1201" style="list-style-type: none"> <li data-bbox="400 963 1031 1075">• the PASSENGER AIR BAG OFF indicator lamp must light up and remain lit. If the indicator lamp is on, OCS has deactivated the front-passenger air bag and front-passenger knee bag (> page 59). <li data-bbox="400 1083 1031 1201">• the Front Passenger Airbag Enabled See Operator's Manual or Front Passenger Airbag Disabled See Operator's Manual display messages must not be shown in the multifunction display. <li data-bbox="371 1209 1031 1265">► Wait for a period of at least 60 seconds until the necessary system checks have been completed. <li data-bbox="371 1273 1031 1329">► Make sure that the display messages do not appear in the multifunction display. <p data-bbox="371 1342 1031 1453">If these conditions are fulfilled, the front-passenger seat can be occupied again. Whether the PASSENGER AIR BAG OFF indicator lamp remains lit or goes out depends on how OCS classifies the occupant.</p> <p data-bbox="371 1461 1031 1517">If the conditions are not fulfilled, the system is not operating correctly.</p>





Display messages	Possible causes/consequences and ► Solutions
	<p>► Visit a qualified specialist workshop immediately.</p> <p>For further information about the Occupant Classification System, see (> page 59).</p>
<p>Front-Passenger Airbag Enabled See Operator's Manual</p>	<p>The front-passenger air bag and front-passenger knee bag are enabled during the journey, even though:</p> <ul style="list-style-type: none"> • a child, a small adult or an object weighing less than the system's weight threshold is located on the front-passenger seat or • the front-passenger seat is unoccupied <p>The system may detect objects or forces applying additional weight on the seat.</p> <p> WARNING</p> <p>The front-passenger front air bag and front-passenger knee bag may be triggered unintentionally.</p> <p>There is an increased risk of injury.</p> <ul style="list-style-type: none"> ► Pull over and stop the vehicle safely as soon as possible, paying attention to road and traffic conditions. ► Secure the vehicle against rolling away (> page 171). ► Switch the ignition off. ► Open the front-passenger door. ► Remove the child and the child restraint system from the front-passenger seat. ► Make sure that there are no objects on the seat adding to the weight. <p>The system may otherwise detect the additional weight and interpret the seat occupant's weight as greater than it actually is.</p> <ul style="list-style-type: none"> ► Keep the seat unoccupied, close the front-passenger door and switch on the ignition. ► Observe the PASSENGER AIR BAG OFF indicator lamp in the center console and the multifunction display and check the following: Seat unoccupied and ignition switched on: <ul style="list-style-type: none"> • the PASSENGER AIR BAG OFF indicator lamp must light up and remain lit. If the indicator lamp is on, OCS has deactivated the front-passenger air bag and front-passenger knee bag (> page 59). • the Front Passenger Airbag Enabled See Operator's Manual or Front Passenger Airbag Disabled See Oper-

Display messages	Possible causes/consequences and ► Solutions
	<p>ator's Manual display messages must not be shown in the multifunction display.</p> <ul style="list-style-type: none"> ► Wait for a period of at least 60 seconds until the necessary system checks have been completed. ► Make sure that the display messages do not appear in the multifunction display. <p>If these conditions are fulfilled, the front-passenger seat can be occupied again. Whether the PASSENGER AIR BAG OFF indicator lamp remains lit or goes out depends on how OCS classifies the occupant.</p> <p>If the conditions are not fulfilled, the system is not operating correctly.</p> <ul style="list-style-type: none"> ► Visit a qualified specialist workshop immediately. <p>For further information about the Occupant Classification System, see (► page 59).</p>

Lights

Display messages	Possible causes/consequences and ► Solutions
 <p>Check Left Cornering Light or Check Right Cornering Light</p>	<p>The left or right-hand cornering light is defective.</p> <ul style="list-style-type: none"> ► Visit a qualified specialist workshop.
 <p>Check Left Low Beam or Check Right Low Beam</p>	<p>The left or right-hand low-beam headlamp is defective.</p> <ul style="list-style-type: none"> ► Visit a qualified specialist workshop.
 <p>Check Rear Left Turn Signal or Check Rear Right Turn Signal</p>	<p>The rear left-hand or rear right-hand turn signal is defective.</p> <ul style="list-style-type: none"> ► Visit a qualified specialist workshop.
 <p>Check Front Left Turn Signal or Check Front Right Turn Signal</p>	<p>The front left-hand or front right-hand turn signal is defective.</p> <ul style="list-style-type: none"> ► Visit a qualified specialist workshop.

Display messages	Possible causes/consequences and ► Solutions
 <p>Check Left Mirror Turn Signal or Check Right Mirror Turn Signal</p>	<p>The turn signal in the left-hand or right-hand exterior mirror is defective.</p> <p>► Visit a qualified specialist workshop.</p>
 <p>Check Center Brake Lamp</p>	<p>The high-mounted brake lamp is faulty.</p> <p>► Visit a qualified specialist workshop.</p>
 <p>Check Left Brake Lamp or Check Right Brake Lamp</p>	<p>The left or right-hand brake lamp is defective.</p> <p>► Visit a qualified specialist workshop.</p>
 <p>Check Left Tail and Brake Lamps or Check Right Tail and Brake Lamps</p>	<p>The left or right-hand tail lamp/brake lamp is defective.</p> <p>► Visit a qualified specialist workshop.</p>
 <p>Check Left High Beam or Check Right High Beam</p>	<p>The left or right-hand high beam is defective.</p> <p>► Visit a qualified specialist workshop.</p>
 <p>License Plate Lamp</p>	<p>The left or right-hand license plate lamp is defective.</p> <p>► Visit a qualified specialist workshop.</p>
 <p>Rear Fog Lamp</p>	<p>The rear fog lamp is defective.</p> <p>► Visit a qualified specialist workshop.</p>
 <p>Check Front Left Parking Lamp or Check Front Right Parking Lamp</p>	<p>The front left or front right parking or standing lamp is defective.</p> <p>► Visit a qualified specialist workshop.</p>
 <p>Backup Light</p>	<p>The backup lamp is defective.</p> <p>► Visit a qualified specialist workshop.</p>

Display messages	Possible causes/consequences and ► Solutions
 <p>Check Left Daytime Running Light or Check Right Daytime Running Light</p>	<p>The left-hand or right-hand daytime running lamp is faulty.</p> <p>► Visit a qualified specialist workshop.</p>
 <p>Active Headlamps Inoperative</p>	<p>The active light function is defective.</p> <p>► Visit a qualified specialist workshop.</p>
 <p>Malfunction See Operator's Manual</p>	<p>The exterior lighting is defective.</p> <p>► Visit a qualified specialist workshop.</p>
 <p>Auto Lamp Function Inoperative</p>	<p>The light sensor is defective.</p> <p>► Visit a qualified specialist workshop.</p>
 <p>Switch Off Lights</p>	<p>The lights are still switched on when you leave the vehicle. A warning tone also sounds.</p> <p>► Turn the light switch to AUTO.</p>
<p>Adaptive Highbeam Assist Inoperative</p>	<p>Adaptive Highbeam Assist is faulty.</p> <p>► Visit a qualified specialist workshop.</p>
<p>Adaptive Highbeam Assist Currently Unavailable See Operator's Manual</p>	<p>Adaptive Highbeam Assist is deactivated and temporarily inoperative. Possible causes are:</p> <ul style="list-style-type: none"> • the windshield in the camera's field of vision is dirty. • visibility is impaired due to heavy rain, snow or fog. <p>► Clean the windshield.</p> <p>If the system detects that the camera is fully operational again, the Adaptive Highbeam Assist Now Available message is displayed.</p> <p>Adaptive Highbeam Assist is operational again.</p>

Engine

Display messages

Possible causes/consequences and ► Solutions



Check Coolant
Level See Opera-
tor's Manual

The coolant level is too low.

- ! Avoid making long journeys with too little coolant in the engine cooling system. The engine will otherwise be damaged.
- Add coolant, observing the warning notes before doing so (► page 537).
- If coolant needs to be added more often than usual, have the engine coolant system checked at a qualified specialist workshop.



The fan motor is faulty.

- At coolant temperatures below 248 °F (120 °C), drive to the nearest qualified specialist workshop.
- Avoid subjecting the engine to heavy loads, e.g. driving in mountainous terrain, and stop-and-go traffic.



Coolant Too Hot
Stop Vehicle Turn
Engine Off

The coolant is too hot.

A warning tone also sounds.

⚠ **WARNING**





Do not drive when your engine is overheated. This can cause some fluids which may have leaked into the engine compartment to catch fire.





Steam from the overheated engine can also cause serious burns which can occur just by opening the hood.



There is a risk of injury.



- Pull over and stop the vehicle safely and switch off the engine, paying attention to road and traffic conditions.
- Secure the vehicle against rolling away (► page 171).
- Leave the vehicle and keep a safe distance from the vehicle until the engine has cooled down.
- Make sure that the air supply to the engine radiator is not blocked, e.g. by snow, slush or ice.
- Do not start the engine again until the display message goes out and the coolant temperature is below 248 °F (120 °C). Otherwise, the engine could be damaged.
- Pay attention to the coolant temperature display.
- If the temperature increases again, visit a qualified specialist workshop immediately.

Under normal operating conditions and with the specified coolant level, the coolant temperature may rise to 248 °F (120 °C).

Display messages	Possible causes/consequences and ► Solutions
 <p data-bbox="116 229 353 284">See Operator's Manual</p>	<p data-bbox="371 178 706 204">The battery is not being charged.</p> <p data-bbox="371 215 658 240">A warning tone also sounds.</p> <p data-bbox="371 248 580 274">Possible causes are:</p> <ul style="list-style-type: none"> <li data-bbox="371 288 613 314">• a defective alternator <li data-bbox="371 325 572 351">• a torn poly-V-belt <li data-bbox="371 362 714 387">• a malfunction in the electronics <p data-bbox="371 399 1028 453">► Pull over and stop the vehicle safely and switch off the engine, paying attention to road and traffic conditions.</p> <p data-bbox="371 475 1028 501">! Do not continue driving. The engine could otherwise overheat.</p> <p data-bbox="371 512 934 537">► Secure the vehicle against rolling away (▷ page 171).</p> <p data-bbox="371 549 796 574">► Consult a qualified specialist workshop.</p>
 <p data-bbox="116 657 331 711">Stop Vehicle See Operator's Manual</p>	<p data-bbox="371 606 1031 660">The battery is no longer being charged and the battery charge level is too low.</p> <p data-bbox="371 671 658 697">A warning tone also sounds.</p> <p data-bbox="371 708 1028 762">► Pull over and stop the vehicle safely and switch off the engine, paying attention to road and traffic conditions.</p> <p data-bbox="371 774 934 799">► Secure the vehicle against rolling away (▷ page 171).</p> <p data-bbox="371 810 986 865">► Observe the instructions in the display message  See Operator's Manual.</p> <p data-bbox="371 876 796 901">► Consult a qualified specialist workshop.</p>
 <p data-bbox="116 971 331 1026">Start Engine See Operator's Manual</p>	<p data-bbox="371 920 1031 946">The engine is switched off and the battery charge level is too low.</p> <p data-bbox="371 957 1023 1011">► Switch off electrical consumers that you do not need, such as the rear window defroster and interior lighting.</p> <p data-bbox="371 1023 1028 1077">► Leave the engine running for a few minutes or drive a long distance.</p> <p data-bbox="394 1088 689 1114">The battery is being charged.</p>

Display messages	Possible causes/consequences and ► Solutions
 <p>Check Engine Oil At Next Refueling</p>	<p>The engine oil level has dropped to the minimum level. A warning tone also sounds.</p> <ul style="list-style-type: none"> ► Check the oil level at the latest when next refueling (▷ page 535). ► If necessary, add engine oil (▷ page 536). ► Have the engine checked at a qualified specialist workshop if engine oil needs to be added more often than usual. <p>! Avoid long journeys with too little engine oil. The engine will otherwise be damaged.</p> <p>Information on approved engine oils can be obtained from any qualified specialist workshop or on the Internet at http://bevo.mercedes-benz.com.</p>
 <p>Check Engine Oil Level (Add 1 quart)</p>	<p>AMG vehicles: the engine oil level is too low.</p> <ul style="list-style-type: none"> ► Check the oil level at the latest when next refueling (▷ page 535). ► If necessary, add engine oil (▷ page 536). ► Have the engine checked at a qualified specialist workshop if engine oil needs to be added more often than usual. <p>! Avoid long journeys with too little engine oil. The engine will otherwise be damaged.</p> <p>Information on approved engine oils can be obtained from any qualified specialist workshop or on the Internet at http://bevo.mercedes-benz.com.</p>
 <p>Fuel Level Low</p>	<p>The fuel level has dropped into the reserve range.</p> <ul style="list-style-type: none"> ► Refuel at the nearest gas station.
	<p>There is only a very small amount of fuel in the fuel tank.</p> <ul style="list-style-type: none"> ► Refuel at the nearest gas station without fail.
 <p>Gas Cap Loose</p>	<p>The fuel system pressure is too low. The fuel filler cap is not closed correctly or the fuel system is leaking.</p> <ul style="list-style-type: none"> ► Check that the fuel filler cap is correctly closed. <p>If the fuel filler cap is not correctly closed:</p> <ul style="list-style-type: none"> ► Close the fuel filler cap. <p>If the fuel filler cap is correctly closed:</p> <ul style="list-style-type: none"> ► Visit a qualified specialist workshop.

Driving systems	
Display messages	Possible causes/consequences and ► Solutions
ABC Malfunction	<p>The ABC function (Active Body Control) is restricted.</p> <p> WARNING</p> <p>The vehicle's suspension tuning characteristics may be affected. There is a risk of an accident.</p> <ul style="list-style-type: none"> ► Do not drive at speeds above 50 mph (80 km/h). ► Visit a qualified specialist workshop.
ABC Malfunction Stop Vehicle	<p>The vehicle level of the ABC is too low.</p> <ul style="list-style-type: none"> ► Pull over and stop the vehicle safely as soon as possible, paying attention to road and traffic conditions. After a few seconds, the vehicle level is adjusted and the display message disappears. <p>The vehicle is leaking oil. The display message is shown continuously.</p> <p> WARNING</p> <p>The vehicle's suspension tuning characteristics may be affected. There is a risk of an accident.</p> <ul style="list-style-type: none"> ► Pull over and stop the vehicle safely as soon as possible, paying attention to road and traffic conditions. Do not continue driving under any circumstances. ► Secure the vehicle against rolling away (► page 171). ► Notify a qualified specialist workshop or breakdown service. <p>ABC is malfunctioning. The display message is shown continuously.</p> <p> WARNING</p> <p>The suspension tuning characteristics are thus affected. There is a risk of an accident.</p> <ul style="list-style-type: none"> ► Do not drive at speeds above 50 mph (80 km/h). ► Make only slight steering movements. Otherwise, the front fender or the tires could be damaged if the steering movement is too large. ► Listen for scraping sounds. ► Visit a qualified specialist workshop.

Display messages	Possible causes/consequences and ► Solutions
 <p>Attention Assist: Take a Break!</p>	<p>Based on certain criteria, ATTENTION ASSIST has detected fatigue or a lack of concentration on the part of the driver. A warning tone also sounds.</p> <p>► If necessary, take a break.</p> <p>During long journeys, take regular breaks in good time so you get enough rest.</p>
 <p>Attention Assist Inoperative</p>	<p>ATTENTION ASSIST is inoperative.</p> <p>► Visit a qualified specialist workshop.</p>
 <p>Off</p>	<p>The HOLD function is deactivated. The vehicle is skidding. A warning tone also sounds.</p> <p>► Reactivate the HOLD function later (► page 191).</p>
<p>Radar Sensors Deactivated See Operator's Manual</p>	<p>The radar sensor system is deactivated.</p> <p>► Switch on the radar sensor system (► page 235).</p>
<p>Spotlight Inoperative</p>	<p>Night View Assist Plus is deactivated and temporarily inoperative. Possible causes are:</p> <ul style="list-style-type: none"> • the windshield in the camera's field of vision is dirty. • the camera in the radiator trim is dirty. • visibility is impaired due to heavy rain, snow or fog. • the outside temperature is too high. <p>► Clean the windshield.</p> <p>► Clean the camera in the radiator trim.</p> <p>If the system has been switched off due to excessive outside temperatures, the system will switch back on automatically once it has cooled down.</p> <p>If the system detects that the camera is fully operational, the display message disappears.</p> <p>Night View Assist Plus is operational again.</p> <hr/> <p>Night View Assist Plus is defective.</p> <p>► Visit a qualified specialist workshop.</p>

Display messages	Possible causes/consequences and ► Solutions
<p>Active Lane Keeping Assist Currently Unavailable See Operator's Manual</p>	<p>Active Lane Keeping Assist is deactivated and temporarily inoperative. Possible causes are:</p> <ul style="list-style-type: none"> • the windshield in the camera's field of vision is dirty. • visibility is impaired due to heavy rain, snow or fog. • there are no lane markings for a longer period. • the lane markings are worn, dark or covered, e.g. by dirt or snow. <p>When the causes stated above no longer apply, the display message disappears.</p> <p>Active Lane Keeping Assist is operational again.</p> <p>If the display message does not disappear:</p> <ul style="list-style-type: none"> ► Pull over and stop the vehicle safely as soon as possible, paying attention to road and traffic conditions. ► Secure the vehicle against rolling away (▷ page 171). ► Clean the windshield.
<p>Active Lane Keeping Assist Inoperative</p>	<p>Active Lane Keeping Assist is defective.</p> <ul style="list-style-type: none"> ► Visit a qualified specialist workshop.
<p>Active Blind Spot Assist Currently Unavailable See Operator's Manual</p>	<p>Active Blind Spot Assist is temporarily inoperative. Possible causes are:</p> <ul style="list-style-type: none"> • the sensors are dirty. • function is impaired due to heavy rain or snow. • the radar sensor system is outside the operating temperature range. • the radar sensor system is temporarily inoperative, e.g. due to electromagnetic radiation emitted by nearby TV or radio stations or other sources of electromagnetic radiation. <p>The yellow  indicator lamps also light up in the exterior mirrors.</p> <p>When the causes stated above no longer apply, the display message disappears.</p> <p>Active Blind Spot Assist is operational again.</p> <p>If the display message does not disappear:</p> <ul style="list-style-type: none"> ► Pull over and stop the vehicle safely as soon as possible, paying attention to road and traffic conditions. ► Secure the vehicle against rolling away (▷ page 171). ► Clean the sensors (▷ page 543). ► Restart the engine.

Display messages	Possible causes/consequences and ► Solutions
Active Blind Spot Assist Inoperative	<p>Active Blind Spot Assist is defective.</p> <p>The yellow  indicator lamps also light up in the exterior mirrors.</p> <p>► Visit a qualified specialist workshop.</p>
Park Assist Canceled	<p>The driver's door is open and the driver's seat belt has not been fastened.</p> <p>► Repeat the parking process with the seat belt fastened and the driver's door closed.</p>
	<p>You have inadvertently touched the multifunction steering wheel while steering intervention was active.</p> <p>► While steering intervention is active, make sure that the multifunction steering wheel is not touched unintentionally.</p>
	<p>The vehicle has started to skid and ESP[®] has intervened.</p> <p>► Use Active Parking Assist again later (▷ page 202).</p>
Park Assist Inoperative	<p>You have just carried out a large number of turning or parking maneuvers.</p> <p>Active Parking Assist will become available again after approximately ten minutes (▷ page 202).</p> <p>► Pull over and stop the vehicle safely as soon as possible, paying attention to road and traffic conditions.</p> <p>► Switch off and restart the engine.</p> <p>If the display message continues to be displayed:</p> <p>► Visit a qualified specialist workshop.</p>
	<p>PARKTRONIC is defective.</p> <p>► Visit a qualified specialist workshop.</p>
Park Assist Finished	<p>The vehicle is parked. A warning tone also sounds.</p> <p>The display message disappears automatically.</p>
DISTRONIC PLUS Off	<p>DISTRONIC PLUS has been deactivated (▷ page 182).</p> <p>If it was deactivated automatically, a warning tone also sounds.</p>
DISTRONIC PLUS Now Available	<p>DISTRONIC PLUS is operational again after having been temporarily unavailable. You can now reactivate DISTRONIC PLUS (▷ page 182).</p>









Display messages	Possible causes/consequences and ► Solutions
<p>DISTRONIC PLUS Currently Unavailable See Operator's Manual</p>	<p>DISTRONIC PLUS is temporarily inoperative. Possible causes are:</p> <ul style="list-style-type: none"> • function is impaired due to heavy rain or snow. • the sensors in the radiator trim and the bumper are dirty. • the radar sensor system is temporarily inoperative, e.g. due to electromagnetic radiation emitted by nearby TV or radio stations or other sources of electromagnetic radiation. • the system is outside the operating temperature range. • the on-board voltage is too low. <p>A warning tone also sounds.</p> <p>When the causes stated above no longer apply, the display message disappears.</p> <p>DISTRONIC PLUS is operational again.</p> <p>If the display message does not disappear:</p> <ul style="list-style-type: none"> ► Pull over and stop the vehicle safely as soon as possible, paying attention to road and traffic conditions. ► Secure the vehicle against rolling away (▷ page 171). ► Clean the sensors in the radiator trim and the bumper (▷ page 543). ► Restart the engine.
<p>DISTRONIC PLUS Inoperative</p>	<p>DISTRONIC PLUS is defective.</p> <p>BAS PLUS (Brake Assist PLUS) and PRE-SAFE® Brake may be inoperative as well.</p> <p>A warning tone also sounds.</p> <ul style="list-style-type: none"> ► Visit a qualified specialist workshop.
<p>DISTRONIC PLUS Suspended</p>	<p>You have depressed the accelerator pedal. DISTRONIC PLUS is no longer controlling the speed of the vehicle.</p> <ul style="list-style-type: none"> ► Remove your foot from the accelerator pedal.
<p>DISTRONIC PLUS - - - mph</p>	<p>An activation condition for DISTRONIC PLUS is not fulfilled.</p> <ul style="list-style-type: none"> ► Check the activation conditions for DISTRONIC PLUS (▷ page 182).





Display messages	Possible causes/consequences and ► Solutions
Cruise Control Inoperative	<p>Cruise control is defective. A warning tone also sounds.</p> <p>► Visit a qualified specialist workshop.</p>
Cruise Control - - - mph	<p>A condition for activating cruise control has not been fulfilled. You have tried to store a speed below 20 mph (30 km/h), for example.</p> <p>► If conditions permit, drive faster than 20 mph (30 km/h) and store the speed.</p> <p>► Check the activation conditions for cruise control (► page 180).</p>







Tires	
Display messages	Possible causes/consequences and ► Solutions
Please Correct Tire Pressure	<p>The tire pressure is too low in at least one of the tires, or the tire pressure difference between the wheels is too great.</p> <ul style="list-style-type: none"> ► Check the tire pressures at the next opportunity (▷ page 575). ► If necessary, correct the tire pressure. ► Restart the tire pressure monitor (▷ page 577).
Check Tires	<p>The tire pressure in one or more tires has dropped significantly. The wheel position is displayed in the multifunction display. A warning tone also sounds.</p> <p> WARNING</p> <p>With tire pressures which are too low, there is a risk of the following hazards:</p> <ul style="list-style-type: none"> • they may burst, especially as the load and vehicle speed increase. • they may wear excessively and/or unevenly, which may greatly impair tire traction. • the driving characteristics, as well as steering and braking, may be greatly impaired. <p>There is a risk of an accident.</p> <ul style="list-style-type: none"> ► Stop the vehicle without making any sudden steering or braking maneuvers. Pay attention to the traffic conditions as you do so. ► Secure the vehicle against rolling away (▷ page 171). ► Check the tires and, if necessary, follow the instructions for a flat tire (▷ page 548). ► Check the tire pressure (▷ page 575). ► If necessary, correct the tire pressure.



Display messages	Possible causes/consequences and ► Solutions
<p>Warning Tire Malfunction</p>	<p>The tire pressure in one or more tires has dropped suddenly. The wheel position is shown in the multifunction display.</p> <p> WARNING</p> <p>If you drive with a flat tire, there is a risk of the following hazards:</p> <ul style="list-style-type: none"> • a flat tire affects the ability to steer or brake the vehicle. • you could lose control of the vehicle. • continued driving with a flat tire will cause excessive heat build-up and possibly a fire. <p>There is a risk of an accident.</p> <ul style="list-style-type: none"> ► Stop the vehicle without making any sudden steering or braking maneuvers. Pay attention to the traffic conditions as you do so. ► Secure the vehicle against rolling away (► page 171). ► Check the tires and, if necessary, follow the instructions for a flat tire (► page 548).
<p>Tire Pressure Monitor Currently Unavailable</p>	<p>Due to a source of radio interference, no signals can be received from the wheel sensors. The tire pressure monitor is temporarily malfunctioning.</p> <ul style="list-style-type: none"> ► Drive on. The tire pressure monitor restarts automatically as soon as the problem has been solved.
<p>TirePress. Sensor(s) Missing</p>	<p>There is no signal from the tire pressure sensor of one or several wheels. The pressure of the affected tire is not displayed in the multifunction display.</p> <ul style="list-style-type: none"> ► Have the faulty tire pressure sensor replaced at a qualified specialist workshop.
<p>Tire Pressure Monitor Inoperative No Wheel Sensors</p>	<p>The wheels mounted do not have a suitable tire pressure sensor. The tire pressure monitor is deactivated.</p> <ul style="list-style-type: none"> ► Mount wheels with suitable tire pressure sensors. The tire pressure monitor is activated automatically after driving for a few minutes.
<p>Tire Pressure Monitor Inoperative</p>	<p>The tire pressure monitor is faulty.</p> <ul style="list-style-type: none"> ► Visit a qualified specialist workshop.

Vehicle	
Display messages	Possible causes/consequences and ► Solutions
Shift to 'P' or 'N' to Start Engine	<p>You have attempted to start the engine with the transmission in position R or D.</p> <ul style="list-style-type: none"> ► Shift the transmission to position P or N.
Apply Brake to Shift from 'P'	<p>You have attempted to move the transmission selector lever to position D, R or N without depressing the brake pedal.</p> <ul style="list-style-type: none"> ► Depress the brake pedal.
Auxiliary Battery Malfunction	<p>The auxiliary battery for the automatic transmission is no longer being charged.</p> <ul style="list-style-type: none"> ► Visit a qualified specialist workshop at the next opportunity. ► Until then, set the automatic transmission to position P before you switch off the engine. ► Before leaving the vehicle, apply the electric parking brake. ► Secure the vehicle against rolling away (▷ page 171).
Transmission Not in P Risk of Vehicle Rolling Away	<p>The driver's door is open and the transmission is in position R, N or D.</p> <p>A warning tone also sounds.</p> <p> WARNING</p> <p>The vehicle may roll away. There is a risk of an accident.</p> <ul style="list-style-type: none"> ► Shift the transmission to position P. ► Secure the vehicle against rolling away (▷ page 171).
Service Required Do Not Shift Gears Visit Dealer	<p>You cannot change the transmission position due to a malfunction. A warning tone also sounds.</p> <p>If transmission position D is selected:</p> <ul style="list-style-type: none"> ► Drive to a qualified specialist workshop without shifting the transmission from position D. <p>If transmission position R, N or P is selected:</p> <ul style="list-style-type: none"> ► Notify a qualified specialist workshop or breakdown service.
Only Shift to 'P' when Vehicle is Stationary	<p>The vehicle is moving.</p> <ul style="list-style-type: none"> ► Pull over and stop the vehicle safely as soon as possible, paying attention to road and traffic conditions. ► Shift the transmission to position P.

Display messages	Possible causes/consequences and ► Solutions
	<p>The trunk lid is open.</p> <ul style="list-style-type: none"> ► Close the trunk lid.
	<p>The hood is open.</p> <p> WARNING</p> <p>The open hood may block your view when the vehicle is in motion. There is a risk of an accident.</p> <ul style="list-style-type: none"> ► Pull over and stop the vehicle safely as soon as possible, paying attention to road and traffic conditions. ► Secure the vehicle against rolling away (▷ page 171). ► Close the hood.
	<p>At least one door is open. A warning tone also sounds.</p> <ul style="list-style-type: none"> ► Close all the doors.
 <p>Power Steering Malfunction See Operator's Manual</p>	<p>The power steering is malfunctioning. A warning tone also sounds.</p> <p> WARNING</p> <p>You will need to use more force to steer. There is a risk of an accident.</p> <ul style="list-style-type: none"> ► Check whether you are able to apply the extra force required. ► If you are able to steer safely: carefully drive on to a qualified specialist workshop. ► If you are unable to steer safely: do not drive on. Contact the nearest qualified specialist workshop.
 <p>Trunk Partition Open</p>	<p>The trunk partition is open.</p> <ul style="list-style-type: none"> ► Close the trunk partition (▷ page 103).
<p>Phone No Service</p>	<p>Your vehicle is outside the network provider's transmitter/receiver range.</p> <ul style="list-style-type: none"> ► Wait until the mobile phone operational readiness symbol appears in the multifunction display.
 <p>Decrease Speed</p>	<p>You wanted to open the roof while the vehicle was in motion.</p> <ul style="list-style-type: none"> ► Pull over and stop the vehicle safely as soon as possible, paying attention to road and traffic conditions. ► Open the roof (▷ page 101).

Display messages	Possible causes/consequences and ► Solutions
 <p>Vario-Roof Lowering</p>	<p>The roof is not fully opened or closed. The hydraulics are depressurized.</p> <ul style="list-style-type: none"> ► Fully open or close the roof (▷ page 101).
 <p>Open/Close Vario-Roof Completely</p>	<p>The roof is not locked.</p> <ul style="list-style-type: none"> ► Pull over and stop the vehicle safely as soon as possible, paying attention to road and traffic conditions. ► Push or pull the roof switch until the roof is fully open or closed (▷ page 101).
 <p>Start Engine See Operator's Manual</p>	<p>The on-board voltage is too low.</p> <ul style="list-style-type: none"> ► Start the engine. ► After approximately ten seconds, repeat the opening or closing procedure (▷ page 101). <p>The roof has been opened and closed several times in a row. The roof drive has been switched off automatically for safety reasons. You can open and close the roof again after approximately ten minutes.</p> <ul style="list-style-type: none"> ► Switch off the ignition and turn it back on. ► Repeat the opening or closing procedure (▷ page 101).
<p>Close Rear Side Windows</p>	<p>You leave the vehicle and at least one of the rear side windows is open.</p> <ul style="list-style-type: none"> ► Close the rear side windows (▷ page 98).
 <p>Check Washer Fluid</p>	<p>The washer fluid level in the washer fluid reservoir has dropped below the minimum.</p> <ul style="list-style-type: none"> ► Add washer fluid (▷ page 537).
<p>Wiper Malfunctioning</p>	<p>The windshield wipers are malfunctioning.</p> <ul style="list-style-type: none"> ► Visit a qualified specialist workshop.
<p>Hazard Warning Flashers Malfunctioning</p>	<p>The hazard warning lamps are faulty.</p> <ul style="list-style-type: none"> ► Visit a qualified specialist workshop.



SmartKey	
Display messages	Possible causes/consequences and ► Solutions
 Key Does Not Belong to Vehicle	You have put the wrong SmartKey in the ignition lock. ► Use the correct SmartKey.
 Take Your Key from Ignition	The SmartKey is in the ignition lock. ► Remove the SmartKey.
 Obtain a New Key	The SmartKey needs to be replaced. ► Visit a qualified specialist workshop.
 Replace Key Battery	The batteries of the KEYLESS-GO key are discharged. ► Change the batteries (▷ page 85).
 Don't Forget Your Key	The display message is shown for a maximum of 60 seconds and is only a reminder. You have opened the driver's door with the engine switched off. The KEYLESS-GO key is not in the ignition lock. ► Remember to take the KEYLESS-GO key with you when you leave the vehicle.
 Key Not Detected (red display message)	The KEYLESS-GO key is not in the vehicle. A warning tone also sounds. If the engine is switched off, you can no longer lock the vehicle centrally or start the engine. ► Pull over and stop the vehicle safely as soon as possible, paying attention to road and traffic conditions. ► Secure the vehicle against rolling away (▷ page 171). ► Locate the KEYLESS-GO key.
	The KEYLESS-GO key is not detected while the engine is running because there is interference from a strong source of radio waves. A warning tone also sounds. ► Pull over and stop the vehicle safely as soon as possible, paying attention to road and traffic conditions. ► Secure the vehicle against rolling away (▷ page 171). ► Operate the vehicle with the SmartKey in the ignition lock.

Display messages	Possible causes/consequences and ► Solutions
 <p>Key Not Detected (white display message)</p>	<p>The KEYLESS-GO key cannot be detected at present.</p> <ul style="list-style-type: none"> ► Change the location of the SmartKey with the KEYLESS-GO functions in the vehicle. <p>If the KEYLESS-GO key is still not detected:</p> <ul style="list-style-type: none"> ► Operate the vehicle with the SmartKey in the ignition lock.
 <p>Remove 'Start' Button and Insert Key</p>	<p>The KEYLESS-GO key can continuously not be detected. KEYLESS-GO is temporarily malfunctioning or is defective. A warning tone also sounds.</p> <ul style="list-style-type: none"> ► Insert the SmartKey into the ignition lock and turn it to the desired position. ► Visit a qualified specialist workshop.

Warning and indicator lamps





Safety



Seat belts









Problem	Possible causes/consequences and ► Solutions
 <p>After starting the engine, the red seat belt warning lamp lights up for 6 seconds.</p>	<p>The seat belt warning lamp reminds the driver and front passenger to fasten their seat belts.</p> <ul style="list-style-type: none"> ► Fasten your seat belt (▷ page 54).
 <p>After starting the engine, the red seat belt warning lamp lights up. In addition, a warning tone sounds for up to 6 seconds.</p>	<p>The driver's seat belt is not fastened.</p> <ul style="list-style-type: none"> ► Fasten your seat belt (▷ page 54). The warning tone ceases.
 <p>The red seat belt warning lamp lights up after the engine starts, as soon as the driver's or the front-passenger door is closed.</p>	<p>The driver or front passenger has not fastened their seat belt.</p> <ul style="list-style-type: none"> ► Fasten your seat belt (▷ page 54). The warning lamp goes out. <p>There are objects on the front-passenger seat.</p> <ul style="list-style-type: none"> ► Remove the objects from the front-passenger seat and stow them in a secure place. The warning lamp goes out.





Problem	Possible causes/consequences and ► Solutions
 <p>The red seat belt warning lamp flashes and an intermittent audible warning sounds.</p>	<p>The driver or front passenger has not fastened their seat belt. The vehicle is being driven faster than 15 mph (25 km/h) or has briefly been driven faster than 15 mph (25 km/h).</p> <ul style="list-style-type: none"> ► Fasten your seat belt (▷ page 54). The warning lamp goes out and the intermittent warning tone ceases. <p>There are objects on the front-passenger seat. The vehicle is being driven faster than 15 mph (25 km/h) or has briefly been driven faster than 15 mph (25 km/h).</p> <ul style="list-style-type: none"> ► Remove the objects from the front-passenger seat and stow them in a secure place. The warning lamp goes out and the intermittent warning tone ceases.





Safety systems





Problem	Possible causes/consequences and ► Solutions
<p> (USA only)</p> <p> (Canada only)</p> <p>The red brake system warning lamp comes on while the engine is running. A warning tone also sounds.</p>	<p>There is not enough brake fluid in the brake fluid reservoir.</p> <p> WARNING</p> <p>The braking effect may be impaired. There is a risk of an accident.</p> <ul style="list-style-type: none"> ► Pull over and stop the vehicle safely as soon as possible, paying attention to road and traffic conditions. Do not continue driving under any circumstances. ► Secure the vehicle against rolling away (> page 171). ► Do not add brake fluid. Adding more will not remedy the malfunction. ► Consult a qualified specialist workshop. ► Observe the additional display messages in the multifunction display.
<p></p> <p>The yellow ABS warning lamp is lit while the engine is running.</p>	<p>ABS (Anti-lock Braking System) is deactivated due to a malfunction. BAS (Brake Assist), BAS PLUS, ESP® (Electronic Stability Program), PRE-SAFE®, PRE-SAFE® Brake, the HOLD function and hill start assist are therefore also deactivated, for example. ATTENTION ASSIST is deactivated.</p> <p> WARNING</p> <p>The brake system continues to function normally, but without the functions listed above. The wheels could therefore lock if you brake hard, for example.</p> <p>The steerability and braking characteristics may be severely affected. The braking distance in an emergency braking situation can increase.</p> <p>If ESP® is not operational, ESP® is unable to stabilize the vehicle. There is an increased risk of skidding and an accident.</p> <ul style="list-style-type: none"> ► Observe the additional display messages in the multifunction display. ► Drive on carefully. ► Visit a qualified specialist workshop. <p>If the ABS control unit is faulty, there is also a possibility that other systems, such as the navigation system or the automatic transmission, will not be available.</p>





Problem	Possible causes/consequences and ► Solutions
 <p>The yellow ABS warning lamp is lit while the engine is running.</p>	<p>ABS is temporarily unavailable. BAS, BAS PLUS, ESP[®], EBD (electronic brake force distribution), PRE-SAFE[®], PRE-SAFE[®] Brake, the HOLD function, hill start assist are therefore also deactivated, for example.</p> <p>Possible causes are:</p> <ul style="list-style-type: none"> • Self-diagnosis is not yet complete. • The on-board voltage may be insufficient. <p>ATTENTION ASSIST is deactivated.</p> <p> WARNING</p> <p>The brake system continues to function normally, but without the functions listed above. The front and rear wheels could therefore lock if you brake hard, for example.</p> <p>The steerability and braking characteristics may be severely affected. The braking distance in an emergency braking situation can increase.</p> <p>If ESP[®] is not operational, ESP[®] is unable to stabilize the vehicle. There is a risk of an accident.</p> <p>► Carefully drive a suitable distance, making slight steering movements at a speed above 12 mph (20 km/h). The functions mentioned above are available again when the warning lamp goes out.</p> <p>If the warning lamp is still on:</p> <ul style="list-style-type: none"> ► Observe the additional display messages in the multifunction display. ► Drive on carefully. ► Visit a qualified specialist workshop.



Problem	Possible causes/consequences and ► Solutions
 <p>The yellow ABS warning lamp is lit while the engine is running. A warning tone also sounds.</p>	<p>EBD is not available due to a malfunction. Therefore, ABS, BAS, BAS PLUS, ESP[®], PRE-SAFE[®], PRE-SAFE[®] Brake, the HOLD function and hill start assist are also unavailable, for example. ATTENTION ASSIST is deactivated.</p> <p> WARNING</p> <p>The brake system continues to function normally, but without the functions listed above. The front and rear wheels could therefore lock if you brake hard, for example.</p> <p>The steerability and braking characteristics may be severely affected. The braking distance in an emergency braking situation can increase.</p> <p>If ESP[®] is not operational, ESP[®] is unable to stabilize the vehicle. There is an increased risk of skidding and an accident.</p> <ul style="list-style-type: none"> ► Observe the additional display messages in the multifunction display. ► Drive on carefully. ► Visit a qualified specialist workshop.
<p> (USA only)</p> <p> (Canada only)</p> <p>  </p> <p>The red brake warning lamp, the yellow ESP[®] and ESP[®] OFF warning lamps and the yellow ABS warning lamp are lit while the engine is running.</p>	<p>ABS and ESP[®] are not available due to a malfunction. Therefore, BAS, BAS PLUS, EBD, PRE-SAFE[®], PRE-SAFE[®] Brake, the HOLD function and hill start assist, for example, are not available either. ATTENTION ASSIST is deactivated.</p> <p> WARNING</p> <p>The brake system continues to function normally, but without the functions listed above. The front and rear wheels could therefore lock if you brake hard, for example.</p> <p>The steerability and braking characteristics may be severely affected. The braking distance in an emergency braking situation can increase.</p> <p>If ESP[®] is not operational, ESP[®] is unable to stabilize the vehicle. There is an increased risk of skidding and an accident.</p> <ul style="list-style-type: none"> ► Observe the additional display messages in the multifunction display. ► Drive on carefully. ► Visit a qualified specialist workshop.

Problem	Possible causes/consequences and ► Solutions
 <p>The yellow ESP® warning lamp flashes while the vehicle is in motion.</p>	<p>ESP® or traction control has intervened because there is a risk of skidding or at least one wheel has started to spin. Cruise control or DISTRONIC PLUS is deactivated.</p> <ul style="list-style-type: none"> ► When pulling away, only depress the accelerator pedal as far as necessary. ► Ease off the accelerator pedal while the vehicle is in motion. ► Adapt your driving style to suit the road and weather conditions. ► Do not deactivate ESP®. <p>For exceptions, see: (▷ page 74).</p>
 <p>The yellow ESP® OFF warning lamp is lit while the engine is running.</p>	<p>ESP® is deactivated.</p> <p> WARNING</p> <p>If ESP® is switched off, ESP® is unable to stabilize the vehicle. There is an increased risk of skidding and an accident.</p> <ul style="list-style-type: none"> ► Reactivate ESP®. <p>For exceptions, see: (▷ page 74).</p> <ul style="list-style-type: none"> ► Adapt your driving style to suit the road and weather conditions. <p>If ESP® cannot be activated:</p> <ul style="list-style-type: none"> ► Drive on carefully. ► Have ESP® checked at a qualified specialist workshop.
 <p>AMG vehicles only: The yellow SPORT handling mode warning lamp is lit while the engine is running.</p>	<p>SPORT handling mode is activated.</p> <p> WARNING</p> <p>When SPORT handling mode is switched on, ESP® is unable to stabilize the vehicle. There is an increased risk of skidding and an accident.</p> <ul style="list-style-type: none"> ► Only switch on SPORT handling mode in certain situations (▷ page 76).

Problem	Possible causes/consequences and ► Solutions
 <p>The yellow ESP[®] and ESP[®] OFF warning lamps are lit while the engine is running.</p>	<p>ESP[®], BAS, BAS PLUS, PRE-SAFE[®], PRE-SAFE[®] Brake, the HOLD function and hill start assist are not available due to a malfunction. ATTENTION ASSIST is deactivated.</p> <p> WARNING</p> <p>The brake system continues to function normally, but without the functions listed above.</p> <p>The braking distance in an emergency braking situation can thus increase.</p> <p>If ESP[®] is not operational, ESP[®] is unable to stabilize the vehicle. There is an increased risk of skidding and an accident.</p> <ul style="list-style-type: none"> ► Observe the additional display messages in the multifunction display. ► Drive on carefully. ► Visit a qualified specialist workshop.
 <p>The yellow ESP[®] and ESP[®] OFF warning lamps are lit while the engine is running.</p>	<p>ESP[®], BAS, PRE-SAFE[®], the HOLD function and hill start assist are temporarily unavailable.</p> <p>BAS PLUS and PRE-SAFE[®] Brake may also have failed. ATTENTION ASSIST is deactivated.</p> <p>Self-diagnosis is not yet complete.</p> <p> WARNING</p> <p>The brake system continues to function normally, but without the functions listed above.</p> <p>The braking distance in an emergency braking situation can thus increase.</p> <p>If ESP[®] is not operational, ESP[®] is unable to stabilize the vehicle. There is an increased risk of skidding and an accident.</p> <ul style="list-style-type: none"> ► Carefully drive a suitable distance, making slight steering movements at a speed above 12 mph (20 km/h). The functions mentioned above are available again when the warning lamp goes out. <p>If the warning lamp is still on:</p> <ul style="list-style-type: none"> ► Observe the additional display messages in the multifunction display. ► Drive on carefully. ► Visit a qualified specialist workshop.

Problem	Possible causes/consequences and ► Solutions
<p> (USA only)  (Canada only)</p> <p>The red electric parking brake indicator lamp flashes or lights up and/or</p> <p></p> <p>warning lamp for the electric parking brake lights up.</p>	<p>► Observe the additional display messages in the multifunction display.</p>
<p></p> <p>The red restraint system warning lamp is lit while the engine is running.</p>	<p>The restraint system is faulty.</p> <p> WARNING</p> <p>The air bags or Emergency Tensioning Devices may either be triggered unintentionally or, in the event of an accident, may not be triggered.</p> <p>There is an increased risk of injury.</p> <p>► Drive on carefully.</p> <p>► Have the restraint system checked at a qualified specialist workshop immediately.</p> <p>For further information about the restraint system, see (► page 50).</p>

Engine	
Problem	Possible causes/consequences and ► Solutions
 <p>The yellow Check Engine warning lamp lights up while the engine is running.</p>	<p>There may be a malfunction, for example:</p> <ul style="list-style-type: none"> • in the engine management • in the fuel injection system • in the exhaust system • in the ignition system • in the fuel system <p>The emission limit values may be exceeded and the engine may be in emergency mode.</p> <p>► Have the vehicle checked as soon as possible at a qualified specialist workshop.</p> <p>i In some states, you must immediately visit a qualified specialist workshop as soon as the yellow Check Engine warning lamp lights up. This is due to the legal requirements in effect in these states. If in doubt, check whether such legal regulations apply in the state in which you are currently driving.</p>
 <p>The yellow reserve fuel warning lamp lights up while the engine is running.</p>	<p>The fuel level has dropped into the reserve range.</p> <p>► Refuel at the nearest gas station.</p>
 <p>The yellow reserve fuel warning lamp flashes while the vehicle is in motion.</p> <p>In addition, the  Check Engine warning lamp may light up.</p>	<p>The fuel system pressure is too low. The fuel filler cap is not closed correctly or the fuel system is leaking.</p> <p>► Check that the fuel filler cap is correctly closed.</p> <p>► If the fuel filler cap is not correctly closed: close the fuel filler cap.</p> <p>► If the fuel filler cap is closed: visit a qualified specialist workshop.</p>
 <p>The red coolant warning lamp lights up while the engine is running and the coolant temperature gauge is at the start of the scale.</p>	<p>The temperature sensor for the coolant temperature gauge is defective.</p> <p>The coolant temperature is no longer being monitored. There is a risk of engine damage if the coolant temperature is too high.</p> <p>► Pull over and stop the vehicle safely and switch off the engine, paying attention to road and traffic conditions. Do not continue driving under any circumstances.</p> <p>► Secure the vehicle against rolling away (► page 171).</p> <p>► Consult a qualified specialist workshop.</p>

Problem	Possible causes/consequences and ► Solutions
 <p>The red coolant warning lamp comes on while the engine is running.</p>	<p>The coolant level is too low.</p> <p>If the coolant level is correct, the airflow to the engine radiator may be blocked or the electric engine radiator fan may be malfunctioning.</p> <p>The coolant is too hot and the engine is no longer being cooled sufficiently.</p> <ul style="list-style-type: none"> ► Observe the additional display messages in the multifunction display. ► Pull over and stop the vehicle safely and switch off the engine, paying attention to road and traffic conditions. ► Secure the vehicle against rolling away (▷ page 171). ► Leave the vehicle and keep a safe distance from the vehicle until the engine has cooled down. ► Check the coolant level and add coolant, observing the warning notes (▷ page 537). ► If you need to add coolant more often than usual, have the engine coolant system checked. ► Make sure that the air supply to the engine radiator is not blocked, e.g. by snow, slush or ice. ► Do not start the engine again until the coolant temperature is below 248 °F (120 °C). Otherwise, the engine could be damaged. ► Drive to the nearest qualified specialist workshop. ► Avoid subjecting the engine to heavy loads, e.g. driving in mountainous terrain, and stop-and-go traffic.
 <p>The red coolant warning lamp comes on while the engine is running. A warning tone also sounds.</p>	<p>The coolant temperature has exceeded 248 °F (120 °C). The airflow to the engine radiator may be blocked or the coolant level may be too low.</p> <p> WARNING</p> <p>The engine is not being cooled sufficiently and may be damaged. Do not drive when your engine is overheated. This can cause some fluids which may have leaked into the engine compartment to catch fire.</p> <p>Steam from the overheated engine can also cause serious burns which can occur just by opening the hood.</p> <p>There is a risk of injury.</p> <ul style="list-style-type: none"> ► Observe the additional display messages in the multifunction display. ► Pull over and stop the vehicle safely and switch off the engine, paying attention to road and traffic conditions. ► Secure the vehicle against rolling away (▷ page 171).

Problem	Possible causes/consequences and ► Solutions
	<ul style="list-style-type: none"> ▶ Leave the vehicle and keep a safe distance from the vehicle until the engine has cooled down. ▶ Check the coolant level and add coolant, observing the warning notes (▷ page 537). ▶ If you need to add coolant more often than usual, have the engine coolant system checked. ▶ Make sure that the air supply to the engine radiator is not blocked, e.g. by snow, slush or ice. ▶ At coolant temperatures below 248 °F (120 °C), drive to the nearest qualified specialist workshop. ▶ Avoid subjecting the engine to heavy loads, e.g. driving in mountainous terrain, and stop-and-go traffic.

Driving systems

Problem	Possible causes/consequences and ► Solutions
 <p>The red distance warning lamp lights up while the vehicle is in motion. A warning tone also sounds.</p>	<p>You are approaching a vehicle or a stationary obstacle in your line of travel at too high a speed.</p> <ul style="list-style-type: none"> ▶ Be prepared to brake immediately. ▶ Pay careful attention to the traffic situation. You may have to brake or take evasive action. <p>Further information on DISTRONIC PLUS (▷ page 182). Further information on PRE-SAFE® Brake (▷ page 77).</p>

Tires

Problem



The yellow tire pressure monitor warning lamp (pressure loss/malfunction) is lit.

Possible causes/consequences and ► Solutions

The tire pressure monitor has detected a loss of pressure in at least one of the tires.

WARNING

With tire pressures which are too low, there is a risk of the following hazards:

- they may burst, especially as the load and vehicle speed increase.
- they may wear excessively and/or unevenly, which may greatly impair tire traction.
- the driving characteristics, as well as steering and braking, may be greatly impaired.

There is a risk of an accident.

- Stop the vehicle without making any sudden steering or braking maneuvers. Pay attention to the traffic conditions as you do so.
- Secure the vehicle against rolling away (▷ page 171).
- Observe the additional display messages in the multifunction display.
- Check the tires and, if necessary, follow the instructions for a flat tire (▷ page 548).
- Check the tire pressure (▷ page 575).
- If necessary, correct the tire pressure.



The yellow tire pressure monitor warning lamp (pressure loss/malfunction) flashes for approximately one minute and then remains lit.

The tire pressure monitor is faulty.

WARNING

The system is possibly unable to recognize or register low tire pressure.

There is a risk of an accident.

- Observe the additional display messages in the multifunction display.
- Visit a qualified specialist workshop.

Useful information	282
Operating safety	282
At a glance	285
System settings	305
Vehicle functions	312
Navigation	318
Telephone	379
Online and Internet functions	409
Audio	434
Video	472
Rear Seat Entertainment System	480
SIRIUS weather	499

Useful information

i These operating instructions describe all the standard and optional equipment of your COMAND system, as available at the time of going to print. Country-specific differences are possible. Please note that your COMAND system may not be equipped with all the features described. This also applies to safety-related systems and functions.

i Read the information on qualified specialist workshops: (▷ page 35).

Operating safety

Important safety notes

WARNING

Modifications to electronic components, their software as well as wiring can impair their function and/or the function of other networked components. In particular, systems relevant to safety could also be affected. As a result, these may no longer function as intended and/or jeopardize the operating safety of the vehicle. There is an increased risk of an accident and injury.

Never tamper with the wiring as well as electronic components or their software. You should have all work to electrical and electronic equipment carried out at a qualified specialist workshop.

If you make any changes to the vehicle electronics, the general operating permit is rendered invalid.

WARNING

If you operate information systems and communication equipment integrated in the vehicle while driving, you will be distracted from traffic conditions. You could also lose control of the vehicle. There is a risk of an accident. Only operate the equipment when the traffic situation permits. If you are not sure that this

is possible, park the vehicle paying attention to traffic conditions and operate the equipment when the vehicle is stationary.

You must observe the legal requirements for the country in which you are currently driving when operating COMAND.

COMAND calculates the route to the destination without taking account of the following, for example:

- traffic lights
- stop and yield signs
- merging lanes
- parking or stopping in a no parking/no stopping zone
- other road and traffic rules and regulations
- narrow bridges

COMAND can give incorrect navigation commands if the actual street/traffic situation does not correspond with the digital map's data. Digital maps do not cover all areas nor all routes in an area. For example, a route may have been diverted or the direction of a one-way street may have changed.

For this reason, you must always observe road and traffic rules and regulations during your journey. Road and traffic rules and regulations always have priority over the system's driving recommendations.

Navigation announcements are intended to direct you while driving without diverting your attention from the road and driving.

Please always use this feature instead of consulting the map display for directions. Looking at the icons or map display can distract you from traffic conditions and driving, and increase the risk of an accident.

Bear in mind that at a speed of only 30 mph (approximately 50 km/h) your vehicle covers a distance of 44 feet (approximately 14 m) per second.

This equipment complies with FCC radiation exposure limits set forth for uncontrolled equipment and meets the FCC radio fre-

quency (RF) Exposure Guidelines in Supplement C to OET65.

This equipment has very low levels of RF energy that is deemed to comply without maximum permissive exposure evaluation (MPE). But it is desirable that it should be installed and operated with at least 8 inches (20 cm) and more between the radiator and a person's body (excluding extremities: hands, wrists, feet and legs.)

Declarations of conformity

Vehicle components which receive and/or transmit radio waves

- i USA only:** The wireless devices of this vehicle comply with Part 15 of the FCC Rules. Operation is subject to the following two conditions:
 - 1) These devices may not cause interference, and
 - 2) These devices must accept any interference, including interference that may cause undesired operation of the device. Changes or modifications not expressly approved by the party responsible for compliance could void the user's authority to operate the equipment.
- i Canada only:** The wireless devices of this vehicle comply with Industry Canada license-exempt RSS standard(s). Operation is subject to the following two conditions:
 - 1) These devices may not cause interference, and
 - 2) These devices must accept any interference, including interference that may cause undesired operation of the device.

Correct use

Observe the following information when using COMAND:

- the safety notes in this manual
 - traffic rules and regulations
 - laws and safety standards pertaining to motor vehicles
- i** Work improperly carried out on electronic components or systems (e.g. radio, DVD changer) and associated software could cause them to cease functioning. Even systems that have not been modified could be affected because the electronic systems are connected. Electronic malfunctions can seriously jeopardize the operational safety of your vehicle.
 - i** Roof antenna functionality (telephone, satellite radio, GPS) can be affected by the use of roof carrier systems. Attaching metalized retrofit film to the windshield may affect radio reception and have a negative impact on all other antennas (e.g. emergency antenna) in the vehicle interior.
 - i** Therefore, have all work on or modifications to electronic components carried out at a qualified specialist workshop. This workshop should have the necessary specialist knowledge and tools to carry out the work required. Mercedes-Benz recommends that you use an authorized Mercedes-Benz Center for this purpose. In particular, work relevant to safety or on safety-related systems must be carried out at a qualified specialist workshop.
 - i** **Protection against theft:** this device is equipped with technical provisions to protect it against theft. Further information on protection against theft can be obtained from an authorized Mercedes-Benz Center.

Data stored in the vehicle

A wide range of electronic components in your vehicle contain data memories.

These data memories temporarily or permanently store technical information about:

- The vehicle's operating state
- Incidents
- Malfunctions

In general, this technical information documents the state of a component, a module, a system or the surroundings.

These include, for example:

- operating conditions of system components, e.g. fluid levels
- the vehicle's status messages and those of its individual components, e.g. number of wheel revolutions/speed, deceleration in movement, lateral acceleration, accelerator pedal position
- malfunctions and defects in important system components, e.g. lights, brakes
- vehicle reactions and operating conditions in special driving situations, e.g. air bag deployment, intervention of stability control systems
- ambient conditions, e.g. outside temperature

This data is of an exclusively technical nature and can be used to:

- assist in recognizing and rectifying malfunctions and defects
- analyze vehicle functions, e.g. after an accident
- optimize vehicle function

The data cannot be used to trace the vehicle's movements.

When your vehicle is serviced, technical information can be read from the event data memory and malfunction data memory.

Services include, for example:

- repair services
- service processes

- warranties
- quality assurance

It is read by employees of the service network (including manufacturers) using special diagnostic devices. More detailed information is obtained from it, if required.

After a malfunction has been rectified, the information is deleted from the malfunction memory or is continually overwritten.

When operating the vehicle, situations are conceivable in which this technical data, in connection with other information (if necessary, under consultation with an authorized expert), could be traced to a person.

Examples include:

- accident reports
- damages to the vehicle
- witness statements

Further additional functions that have been contractually agreed upon with the customer allow certain vehicle data to be conveyed by the vehicle as well. The additional functions include, for example, vehicle location in case of an emergency.

Qualified specialist workshop

Read the information on qualified specialist workshops in the vehicle Operator's Manual.

Information on copyright

General information

Information on licenses for free and Open Source software used in your vehicle and in the electronic components can be found on this website: <http://www.mercedes-benz.com/opensource>.

Registered trademarks

Registered trademarks:

- Bluetooth® is a registered trademark of Bluetooth® SIG Inc.
- DTS is a registered trademark of DTS, Inc.
- Dolby and MLP are registered trademarks of DOLBY Laboratories.
- BabySmart™, ESP® and PRE-SAFE® are registered trademarks of Daimler AG.
- HomeLink® is a registered trademark of Prince.
- iPod® and iTunes® are registered trademarks of Apple Inc.
- Logic7® is a registered trademark of Harman International Industries.
- Microsoft® and Windows media® are registered trademarks of Microsoft Corporation.
- SIRIUS is a registered trademark of Sirius XM Radio Inc.
- HD Radio is a registered trademark of iBiquity Digital Corporation.
- Gracenote® is a registered trademark of Gracenote, Inc.
- ZAGATSurvey® and related brands are registered trademarks of ZagatSurvey, LLC.

Your COMAND equipment

This manual describes all standard and optional equipment available for your COMAND system at the time of purchase. Country-specific differences are possible. Please note that your COMAND system may not be equipped with all the features described. This also applies to safety-relevant systems and functions. Therefore, the equipment on your COMAND system may differ from that in the descriptions and illustrations. Should you have any questions concerning equipment and operation, please consult an authorized Mercedes-Benz Center.

Function restrictions

For safety reasons, some COMAND functions are restricted or unavailable while the vehicle is in motion. You will notice this, for example because either you will not be able to select certain menu items or COMAND will display a message to this effect.

At a glance

Your COMAND equipment

These operating instructions describe all the standard and optional equipment for your COMAND system, as available at the time of going to print. Country-specific differences are possible. Please note that your COMAND system may not be equipped with all the features described.

COMAND operating system

Overview



- ① COMAND display (▷ page 286)
- ② COMAND control panel with a single DVD drive
- ③ COMAND controller (▷ page 292)

You can use COMAND to operate the following main functions:

- the navigation system
- the audio function
- the telephone function
- the video function
- the system settings
- the online and Internet functions
- the Digital Operator's Manual
(available depending on the vehicle model)

You can call up the main functions:

- using the corresponding buttons
- using the main function bar in the COMAND display
- using the remote control

COMAND display

General notes

! Do not use the space in front of the display for storage. Objects placed here could damage the display or impair its function. Avoid any direct contact with the display surface. Pressure on the display surface may result in impairments to the display, which could be irreversible.

Wearing polarized sunglasses may impair your ability to read the display.

The display has an automatic temperature-controlled switch-off feature. The brightness is automatically reduced if the temperature is too high. The display may temporarily switch off completely.

Display overview



Example display for radio

- ① Status bar
- ② Calls up the audio menu
- ③ Main function bar
- ④ Display/selection window
- ⑤ Radio menu bar

Status bar ① displays the time, the current mobile phone network provider and the signal level.

The main functions – navigation, audio, telephone and video – feature additional menus. This is indicated by triangle ②. The following table lists the available menu items.

Main function bar ③ allows you to call up the desired main function. When the main function is activated, it is identifiable by the white lettering.

In the example, the radio mode is switched on within the audio main function, display/selection window ④ is active.

Menu bar ⑤ allows you to operate the radio functions.

Menu overview

Navi	Audio	Telephone	Video	System	Symbol 
Route settings	FM/AM radio (using HD Radio™)	Telephone	Video DVD	Calls up the system menu	Calls up the Digital Operator's Manual (available depending on the vehicle model)
Map settings	Satellite radio	Address book	AUX		Calls up COMAND and Internet
Personal POIs	Disc				Calls up the weather service SIRIUS Weather
Messages (street name announcements, acoustic information during calls, audio fadeout, reserve fuel level)	Memory card				Calls up the Mercedes-Benz Mobile website
<input checked="" type="checkbox"/> Activates/deactivates alternative routes	MUSIC REGISTER				
Avoids an area	USB storage device				
SIRIUS service	Bluetooth Audio				
Map version	Media Interface				
	AUX				

System menu overview

System	Time	SPLITVIEW	Consumption	the seat	Display off
Display settings	<input checked="" type="checkbox"/> Switches the automatic time settings on/off	Operates COMAND functions from the passenger side	Calls up the fuel consumption display	Changes the driver/front-passenger seat settings	Switches off the display
Text reader speed	Sets the time zone				
Voice-operated control settings	Switches to summer time				
Rear view camera	Manual time setting				
Language	Sets the time/date format				
Favorites button					
Activates/deactivates Bluetooth®					
Automatic volume adjustment					
Imports/exports data					
Resets COMAND i Delete your personal data using this function, for example before selling your vehicle.					



If equipped with the rear view camera: when the function is activated and COMAND is switched on, the image from the rear view camera is automatically shown in the COMAND display when reverse gear is engaged.

i If the **360° Camera** menu item is displayed, **Display Off** can be called up under **System**.

Switching the COMAND display on/off



▶ Press the  button.

or

▶ Select **System** in the main function bar by sliding  and turning  the COMAND controller and press  to confirm.

In both cases, the system menu appears.

▶ **To switch off:** select **Display Off** and press  to confirm.

▶ **To switch on:** press one of the buttons, e.g. ,  or the  back button.

Cleaning instructions

 Do not touch the display. The display has a very sensitive high-gloss surface; there is a risk of scratching. If you have to clean the screen, however, use a mild cleaning agent and a soft, lint-free cloth.

The display must be switched off and have cooled down before you start cleaning. Clean the display screen, when necessary, with a commercially available microfiber cloth and cleaning agent for TFT/LCD displays. Do not apply pressure to the display surface when cleaning it, as this could cause irreversible damage. Then, dry the surface with a dry microfiber cloth.

Avoid using alcoholic thinners, gasoline or abrasive cleaning agents. These could damage the display surface.

COMAND control panel

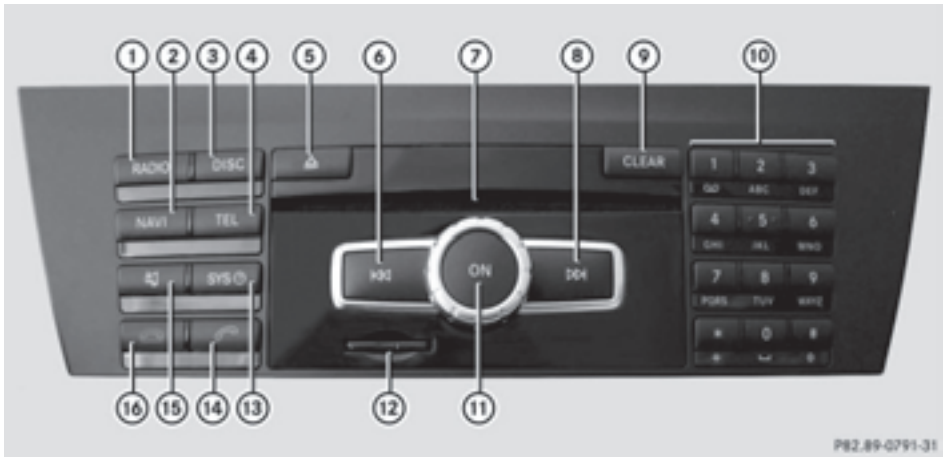

P82.89-G791-31

	Function	Page		Function	Page
①	Switches to radio mode	435	⑥	Selects stations via the station search function	436
	Switches wavebands	436		Rewinds	448
	Switches to satellite radio	440		Selects the previous track	447
②	Switches to navigation mode	319	⑦	Disc slot	
	Shows the menu system	320		• To insert CDs/DVDs	445
③	Press DISC repeatedly			• To remove CDs/DVDs	445
	• Switches to audio CD and MP3 mode	446	• Updates the digital map	375	
	• Switches to memory card mode	446	⑧	Selects stations via the station search function	436
	• Switches to MUSIC REGISTER	455		Fast forward	448
	• Switches to USB storage device mode	446		Selects the next track	447
	• Switches to Media Interface or audio AUX mode	466	⑨	Clear button	
• Switches to Bluetooth® audio mode	463	• Deletes characters		302	
④	Calls up the telephone basic menu:		• Deletes an entry	302	
	• Telephony via the Bluetooth® interface	385			
⑤	Load/eject button	445			

	Function	Page
⑩	Number pad	
	• Selects stations via the station presets	436
	• Stores stations manually	437
	• Mobile phone authorization	383
	• Telephone number entry	387
	• Sends DTMF tones	389
	• Character entry	301
	• Selects a location for the weather forecast from the memory	503
	<input type="checkbox"/> # Displays the current track being played	450
	<input type="checkbox"/> * Selects stations by entering the frequency manually	437
⑪	<input type="checkbox"/> * Selects a track	447
	Switches COMAND on/off	295
	Adjusts the volume	295

	Function	Page
⑫	SD memory card slot	445
⑬	Calls up the system menu	306
⑭	Accepts a call	387
	Dials a number	387
	Redials	388
	Accepts a waiting call	389
⑮	Switches the sound on or off	295
	Switches the microphone on/off	388
	Cancels the text message read-aloud function	399
	Switches off navigation announcements	295
	⑯	Rejects a call
⑰	Ends an active call	390
	Rejects a waiting call	389

COMAND controller

Overview



① COMAND controller

You can use the COMAND controller to select the menu items in the COMAND display.

You can:

- call up menus or lists
- scroll within menus or lists and
- exit menus or lists

Operation

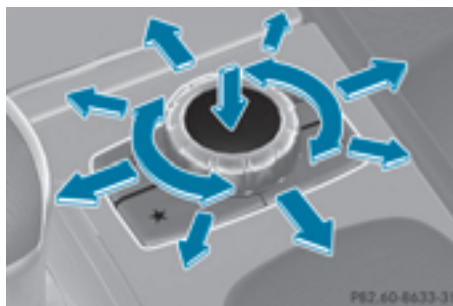

Example: operating the COMAND controller

The COMAND controller can be:

- pressed briefly or pressed and held
- turned clockwise or counter-clockwise
- slid left or right
- slid forwards or backwards
- slid diagonally

Example of operation

In the instructions, operating sequences are described as follows:

- ▶ Press the **RADIO** button.
Radio mode is activated.
- ▶ Select **Radio** by sliding $\odot \downarrow$ and turning $\left[\odot \right] \left[\odot \right]$ the COMAND controller and press \odot to confirm.
- ▶ Confirm **Station List** by pressing \odot .
The station list appears.

Buttons on the COMAND controller

Overview

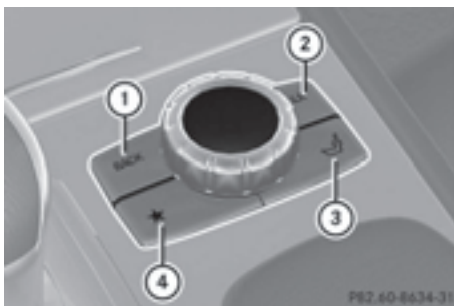

- ① Back button (▷ page 293)
 - ② Clear button (▷ page 293)
 - ③ Seat function button (▷ page 314)
 - ④ Favorites button (▷ page 309)
- i** If your vehicle does not have the seat function button, it will have two Favorites buttons.
- i** For AMG vehicles: the COMAND controller is configured with the ① and ② buttons.

Back button

You can use the **BACK** button to exit a menu or to call up the basic display of the current operating mode.

- ▶ **To exit the menu:** briefly press the **BACK** back button.
COMAND changes to the next higher menu level in the current operating mode.
- ▶ **To call up the basic display:** press and hold the **BACK** back button.
COMAND changes to the basic display of the current operating mode.

Clear button

- ▶ **To delete individual characters:** briefly press the **CLR** clear button.
- ▶ **To delete an entire entry:** press and hold the **CLR** clear button.

Seat function button

You can use the  button to call up the following seat functions:

- Multicontour seat (with 4-way lumbar support)
- Active multicontour seat (dynamic seat and massage function)
- Balance (seat heating distribution)

More information on the seat functions (▷ page 314).

Favorites button

You can assign predefined functions to the  favorites button and call them up by pressing the button (▷ page 309).

Using COMAND

Selecting a main function



Address entry menu

① Main function bar

Situation: switching from navigation mode (address entry menu) to the system settings.

▶ **To switch on navigation mode:** press the **NAVI** function button.

▶ **To show the menu:** press **COMAND** the COMAND controller.

▶ Select **Destination** by sliding **COMAND** and turning **COMAND** and press **COMAND** to confirm.

▶ Select **Address Entry** and press **COMAND** to confirm.
The address entry menu appears.

▶ Slide **COMAND** and switch to main function bar ①.

▶ Select **System** in the main function bar by turning **COMAND** and press **COMAND** to confirm.
The system menu appears.



Selecting the menu of a main function

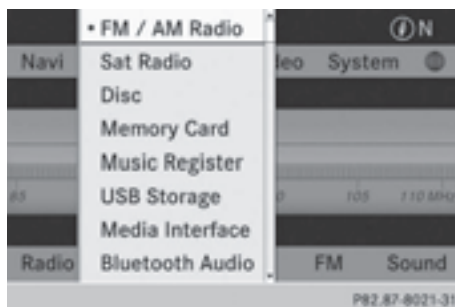

Example display for audio CD mode and audio menu (below)

① Calls up the audio menu

If one of the navigation, audio, telephone or video main functions is switched on, triangle ① appears next to the entry in the main function bar. You can now select an associated menu.

The example describes how to call up the audio menu from audio CD mode (an audio CD is playing).

▶ Select **Audio** in the main function bar by sliding **COMAND** and turning **COMAND** and press **COMAND** to confirm.
The Audio menu appears.

The • dot indicates the currently selected audio mode.

▶ Select another audio mode, e.g. **Radio**, by turning **COMAND** and press **COMAND** to confirm.
Radio mode is activated.

Selecting a menu item

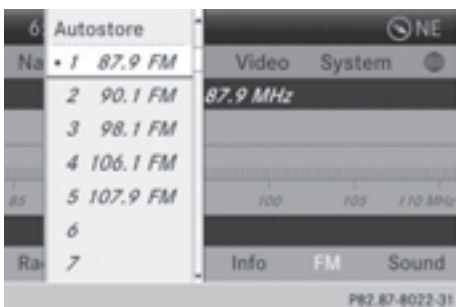

- ▶ Select the station by turning **⏪** **⏩** the COMAND controller and press **⏵** to confirm. The station is set.

Basic COMAND functions

Switching COMAND on/off

- ▶ Press the **Ⓞ** control knob. When you switch on COMAND, a warning message will appear. COMAND calls up the previously selected menu. If you switch off COMAND, playback of the current audio or video source will also be switched off.

Switching the sound on or off

Audio/video source sound

- ▶ Press the **⏵** button on the COMAND controller or on the multifunction steering wheel. The sound from the respective audio or video source is switched on or off.
 - i** When the sound is switched off, you will see the **⏵** symbol in the status bar. If you change the audio or video source or change the volume, the sound is automatically switched on.
 - i** Even if the sound is switched off, you will still hear navigation system announcements.

Switching off navigation announcements

- ▶ **Navigation announcements:** press the **⏵** button during the announcement.

Switching navigation announcements back on

- ▶ Press the **⏵** button again. The navigation announcements are active again:
 - if COMAND is switched off/on with the **Ⓞ** control knob
 - or after starting route guidance

Adjusting the volume

Adjusting the volume for the audio or video source

- ▶ Turn the **Ⓞ** control knob. or
- ▶ Press the **+** or **-** button on the multifunction steering wheel. The volume of the currently selected audio or video source changes.

You can also adjust the volume for the following:

- Navigation announcements
- Phone calls
- Voice output of the Voice Control System (see the separate operating instructions)



Adjusting the volume for navigation announcements

During a navigation announcement:

- ▶ Turn the **Ⓞ** control knob. or
- ▶ Press the **+** or **-** button on the multifunction steering wheel.

Adjusting the volume for phone calls

You can adjust the volume for hands-free mode during a telephone call.

- ▶ Turn the  control knob.
- or
- ▶ Press the  or  button on the multifunction steering wheel.





Adjusting the sound settings

Calling up the sound menu



You can make various sound settings for the different audio and video sources. This means that it is possible to set more bass for radio mode than for audio CD mode, for example. You can call up the respective sound menu from the menu of the desired mode.





The example describes how to call up the sound menu in radio mode.

- ▶ Press the  button.
The radio display appears. You will hear the last station played on the last waveband.
- ▶ Select **Sound** by sliding  and turning  the COMAND controller and press  to confirm.
You can now set the treble, bass and balance for radio mode.

Adjusting treble and bass



Setting the bass

- ▶ Select **Treble** or **Bass** in the sound menu by turning  the COMAND controller and press  to confirm.
An adjustment scale appears.
- ▶ Select a setting by turning  the COMAND controller and press  to confirm.
The setting is saved.

Adjusting balance and fader







Setting the balance

With the balance function, you can control whether the sound is louder on the driver's or front-passenger side.

The fader function is used to control whether the sound is louder in the front or the rear of the vehicle.

You can adjust the fader depending on the vehicle model.

Equipped with Bang & Olufsen sound system: for the best sound focus, choose the setting **0**.

- ▶ Select **Bal/Fad** (balance/fader) in the sound menu by turning  the COMAND controller and press  to confirm.
- ▶ Select a balance setting by sliding   the COMAND controller and press  to confirm.

Surround

General notes

If your vehicle is equipped with surround sound, you can use one of two sound systems:

- harman/kardon® Logic 7® Surround Sound system
The harman/kardon® Logic 7® Surround Sound system allows you to set the optimum surround sound in the vehicle interior ([▷ page 297](#)).
- Bang & Olufsen sound system ([▷ page 298](#))

Both sound systems are available for the following operating modes:

- radio (FM only)
- Satellite radio
- audio CD
- MP3 (including SD memory card and USB storage device)
- Media Interface
- Bluetooth® audio mode
- video DVD (PCM, dts and Dolby Digital audio formats)
- AUX

Because some DVDs contain both stereo and multichannel audio formats, it may be necessary to set the audio format ([▷ page 477](#)).

Discs which support the audio formats mentioned have the following logos:



harman/kardon® Logic 7® surround sound system



The example describes how to set the surround sound for radio mode.

- ▶ **To switch surround sound on/off:** press the **RADIO** button.

The radio display appears. You will hear the last station played on the last waveband.

- ▶ Select **Sound** by sliding **⊙↓** and turning **Ⓢ** the COMAND controller and press **Ⓢ** to confirm.
- ▶ Select **Surround** and press **Ⓢ** to confirm.
- ▶ Select **Logic7® On** or **Logic7® Off** by turning **Ⓢ** the COMAND controller and press **Ⓢ** to confirm.

Depending on your selection, surround sound is switched on or off and the menu is exited.

- ▶ **To exit the menu without saving:** press the **BACK** back button or slide **←⊙→** the COMAND controller.

- i** Please note the following: for the optimum audio experience for all passengers when Logic7® is switched on, the balance should be set to the center of the vehicle interior.

You will achieve the best sound results by playing video DVD media.

MP3 tracks should have a bit rate of at least 128 kbit/s.

Surround sound playback does not function for mono signal sources, such as for AM radio mode.

If radio reception is poor, e.g. in a tunnel, you should switch off Logic7®, since it may otherwise switch dynamically between stereo and mono and cause temporary sound distortions.

On some stereo recordings, the sound characteristics may differ from conventional stereo playback.

- i** The **Logic7® On** function creates a surround sound experience for every passenger when playing stereo recordings, for example. It enables optimum playback of music and films on CD or video DVD with

multichannel audio formats, such as MLP, dts or Dolby Digital. This results in sound characteristics like those intended by the sound engineer when the original was recorded.

- i** If you select **Logic7® Off**, the sound system plays the tracks as stored on the medium. Due to the design of the passenger compartment, an optimum audio experience cannot be guaranteed for all passengers.

Bang & Olufsen sound system

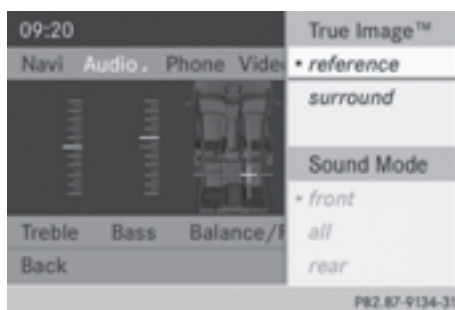

You can optimize the sound in the vehicle with the Bang & Olufsen sound system and the **True Image™** sound technology. The **Sound Mode** function enables you to focus the selected sound setting within the vehicle.

The example describes how to set the optimum sound for radio mode.

Selecting the sound setting for True Image™

- ▶ Press a number key, such as **RADIO**.
- ▶ Select **Sound** by sliding **⊙↓** and turning **Ⓢ** the COMAND controller and press **Ⓢ** to confirm.
- ▶ Select **Bang&Olufsen** and press **Ⓢ** to confirm. A menu appears. A **•** dot marks the current setting for True Image™.
- ▶ Select **reference** or **surround** and press **Ⓢ** to confirm.
- **reference**

This setting provides a crisp, clear, luxury high-end sound setting for a studio atmosphere in your vehicle.

- **Surround sound**

This setting enables a wide-ranging sound experience for playing music and videos.

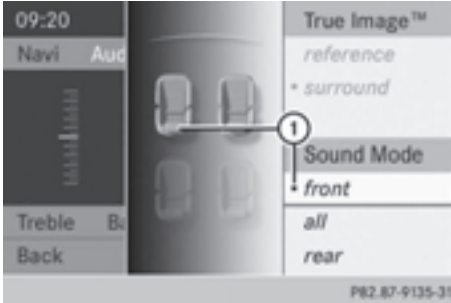

① Current position of the sound setting

For the optimum musical enjoyment, you can focus the sound image precisely on one seat. This means you are right at the center of the listening experience, with all system parameters being precisely calculated for the selected position. The result is authentic music reproduction inside the vehicle.

Focusing the sound setting

- ▶ Press the **RADIO** button.
- ▶ Select **Sound** by sliding $\odot \downarrow$ and turning $\leftarrow \odot \rightarrow$ the COMAND controller and press \odot to confirm.
- ▶ Select **Bang&Olufsen** and press \odot to confirm.

A menu appears. A \bullet dot marks the current setting for Sound Mode.

Depending on the vehicle model series

- ▶ Select **left, all** or **rear** and press \odot to confirm.
- or
- ▶ Select **left, all** or **right** and press \odot to confirm.

- ▶ **To exit the menu:** press the **BACK** back button or slide $\leftarrow \odot \rightarrow$ the COMAND controller.

- ▶ Please note the following: you will achieve the best sound results on your Bang & Olufsen sound system by playing high-quality CDs.

MP3 tracks should have a bit rate of at least 224 kbit/s.

When playing using an iPod®, the bit rate should also be at least 224 kbit/s.

For optimum playback quality:

- ▶ Deactivate the “EQ” setting on the iPod®.

Surround-sound playback does not function for mono signal sources, such as the medium wave range (MW) in radio mode.

On some stereo recordings, the sound characteristics may differ from conventional stereo playback.



Character entry (telephony)

Example: entering characters





- ① **ABC** To switch the character bar to uppercase/lowercase letters
- ② **...** To switch the character bar from uppercase/lowercase letters to digits
- ③ **ABC** To change the language of the character bar
- ④ **CLR** To delete a character/an entry

The example describes how to enter the surname “Schulz”.



- ▶ Call up the input menu with data fields (▷ page 393).
- ▶ Select **S** and confirm  with the COMAND controller. **S** appears in the data field.
- ▶ Select **c** and confirm  with the COMAND controller. The letter **c** is added to **S** in the data field.
- ▶ Repeat the process until the name has been entered in full.

Other input menu functions:

- Deleting a character/an entry (▷ page 301)
- Switching between upper/lower-case letters (▷ page 300)
- Changing the character set (▷ page 300)
- Moving the cursor to the next data field (▷ page 301)
- ▶ **To enter a phone number:** select the digits one by one in the corresponding data field by turning  and sliding  the COMAND controller and press  to confirm.



Switching data fields





- ① Cursor in the next data field
- ② To store the entry
- ③  and  symbols to select a data field

In the input menu, if you want to enter a first name after you have entered a surname, for example, proceed as follows to switch between the data fields:



Option 1

- ▶ Select  or  in the character bar and press  to confirm. The input menu shows the data field selected.

Option 2:

- ▶ Slide  the COMAND controller repeatedly until the character bar disappears.
- ▶ Select the data field by sliding  and press  to confirm.





Storing the entry

- ▶ **After making an entry in the input menu, e.g. to create a new entry** (▷ page 393): select the  symbol in the character bar by turning  the COMAND controller and press  to confirm. The entry is stored in the address book.

Further functions available in the character bar



Changing the language of the character bar

While making an entry in the input menu (▷ page 393):

- ▶ Select  and press  to confirm.
- ▶ Select a language by turning  the COMAND controller and press  to confirm.



Switching the character bar to letters

While making an entry in the input menu, e.g. to create a new entry (▷ page 393):

- ▶ Select the  (upper case) or  (lower case) symbol and press  to confirm.



Changing the character set

While making an entry in the input menu (▷ page 393):



- ▶ Select the  symbol and press  to confirm.
 - **ABC** (upper/lower case)
 - **123** (digits)
 - **Other** (special characters such as @, €, etc.)

Moving the cursor to the next data field



- ① Cursor (repositioned)
- ②  and  symbol to reposition the cursor

While making an entry in the input menu (▷ page 393):



- ▶ Select the  or  symbol and press  to confirm.

Deleting a character/an entry

While making an entry in the input menu (▷ page 393):

- ▶ **To delete characters:** press the **CLEAR** button on the control panel.

or

- ▶ Select the **CLR** symbol by sliding  and turning  the COMAND controller and press  to confirm.

or

- ▶ Press the **CLR** button next to the COMAND controller.

- ▶ **To delete an entry:** press and hold the **CLEAR** button on the control panel until the entire entry has been deleted.

or

- ▶ Select the **CLR** symbol and press and hold  the COMAND controller until the entire entry has been deleted.

or

- ▶ Press and hold the **CLR** button next to the COMAND controller until the entire entry is deleted.

Character entry (navigation)

General information

The following paragraphs describe how to enter characters using city input for **NEW YORK** as an example.

If you want to use the address entry menu to enter a city, a street or a house number, for example, COMAND offers you:

- a list with a character bar (option 1)
- a selection list (option 2)

You can enter the characters using either the character bar or the number keypad. In the selection list, you select an entry to copy it to the address entry menu.

Option 1: city list/street list with character bar

- ▶ Call up the city list with character bar (▷ page 323).

The alphabetically sorted city list shows the first available entries.

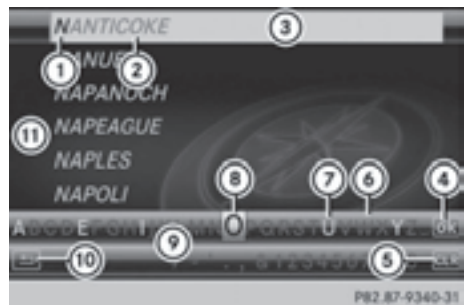

- ① Character **N** entered by the user
- ② Characters automatically added by COMAND **ANTICOKE**

- ③ List entry that most closely resembles the current entry by the user
- ④ Switches to the selection list
- ⑤ Deletes an entry
- ⑥ Characters not currently available
- ⑦ Characters currently available
- ⑧ Currently selected character
- ⑨ Character bar
- ⑩ Cancels an entry
- ⑪ List

Entering characters using the character bar

- ▶ Select **N** by turning **⏪** **⊙** **⏩** the COMAND controller and press **⏩** to confirm. List ⑪ shows all available city names beginning with **N**. The list entry most closely resembling user's current entry ③ is always highlighted at the top of the list (**NANTICOKE** in the example).

All characters currently entered by the user are shown in black (letter **N** ① in the example). Letters added by COMAND are shown in gray ② (**ANTICOKE** in the example).

Character bar ⑨ shows the letters still available for selection in black ⑦. These can be selected. In the example, the letter **O** is highlighted ⑧. The characters available depend on the entry made by the user so far and the data contained in the digital map. Characters that are no longer available ⑥ are shown in gray.

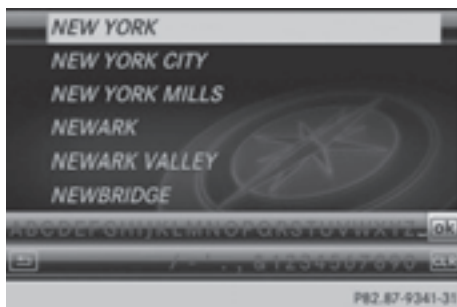

- ▶ Select **E**, **W**, space, **Y** in order and confirm each with **⏩**.

Entering characters using the number keypad

- ▶ To enter the letter **N**: press the **6** **MNO** number key twice in quick succession.

The character appears at the bottom of the display when the key is pressed. The first available letter is highlighted.

You see which characters you can enter with that key. Each time the key is pressed, the next character is selected.

Example: **6** **MNO** key:

- press once = M
 - press twice = N
 - press three times = O
- ▶ Wait until the character display goes out. The entries matching your input are shown in the list.
 - ▶ Enter **E**, **W**, space, **Y** with the corresponding keys.

- i** The space is entered using number key **0**.

Further functions in the list with character bar

- ▶ **To delete characters:** press the **CLEAR** button on the control panel.

or

- ▶ Press the **CLR** button next to the COMAND controller.

or



- ▶ Select the **CLR** symbol in the character bar by sliding **⊙** **⏩** and turning **⏪** **⊙** **⏩** the COMAND controller and press **⏩** to confirm.

- ▶ **To delete an entry:** press and hold the **CLEAR** button on the control panel.

or

- ▶ Press and hold the **CLR** button next to the COMAND controller until the entire entry is deleted.

or



- ▶ Select the **CLR** symbol in the character bar and press and hold  the COMAND controller until the entire entry is deleted.
- ▶ **To cancel an entry:** select the  symbol in the bottom left of the character bar and press  to confirm.

or



- ▶ Press the **BACK** back button.
The address entry menu appears.
- ▶ **To accept the first list entry:** press and hold  the COMAND controller until the address entry menu appears.
The accepted list entry is shown there.

Calling up the list as a selection list

You can switch from the list of cities with the character bar to the list of cities as a selection list at any point during character entry.

- ▶ Slide   the COMAND controller repeatedly until the city list appears as a selection list.
Select the desired city from the selection list.

or

- ▶ Select **ok** in the character bar by turning   the COMAND controller and press  to confirm.

If there are several entries for a city or if several cities of the same name are stored, then **ok** is highlighted in the character bar.

- ▶ Press  the COMAND controller.

Option 2: city list as selection list



COMAND either shows the selection list automatically or you can call up the selection list from the list with the character bar.

The example shows the selection list after the city **NEW YORK** has been entered. The entry is highlighted automatically.

- ▶ Confirm **NEW YORK** by pressing  the COMAND controller.
The address entry menu appears. You can now enter a street, for example.

Observe the information on destination entry ([▷ page 322](#)).

SPLITVIEW

Method of operation

SPLITVIEW allows you to simultaneously use different COMAND functions on the front-passenger side and on the driver's side. Different content is seen depending on your perspective when viewing the display.

The "Navi" function, for example, can be used from the driver's side while a video is watched from the front-passenger side.

SPLITVIEW is operated with the remote control from the front-passenger side.

To do so, use the special cordless headphones ([▷ page 484](#)). Using the headphones on the correct sides ensures an optimal sound.

You can connect your own headphones to a special headphones jack. You can use the remote control to operate them.

Points to remember

- You can only adjust the volume for the headphones supplied, directly on the headphones.
- Only entertainment functions, i.e. audio, TV, video and Internet, for example, may be used with SPLITVIEW.
- Different media can be used on the driver and front-passenger sides as long as they use different media sources. Example: if a medium from the single DVD drive is being played on the driver's side, then another medium that is also played from the single DVD drive cannot be played separately on the front-passenger side. However, other media can be used at the same time on the front-passenger side, including radio, memory card, MUSIC REGISTER, Media Interface, USB or AUX.
- If you use the same medium on both sides, you can both carry out the respective settings.
- Internet use is only available at any one time to the driver or the front passenger. A corresponding message appears on the display.
- Internet can only be used, if it is set and connected via a telephone on the driver's side.
- The multifunction steering wheel can only be used for functions which relate to the driver's side.

Switching SPLITVIEW on/off



Switching on SPLITVIEW

- ▶ Select **System** in the main function bar by turning the COMAND controller and press to confirm.
- ▶ Select **2** in the menu bar and confirm. SPLITVIEW symbol **1** appears in the display and display **2** switches to **Off**.

The front passenger sees the display of the function last activated. If the switch-on time was longer than 30 minutes previously, the display from the driver's side is shown.

The front passenger can now call up the COMAND functions with the remote control.

Switching off SPLITVIEW





- ▶ Select **2** in the menu bar by turning the COMAND controller and press to confirm. SPLITVIEW symbol **1** disappears from the display. Display **2** switches to **On**.

i If COMAND has already been switched on, you can also use the remote control to switch SPLITVIEW on and off. Make sure that the SPLITVIEW symbol is set on the remote control thumbwheel (▷ page 482).

The SPLITVIEW display remains on for approximately 30 minutes after the SmartKey has been turned to position **0** in the ignition lock. After this time or after the SmartKey has been removed, the settings on the front-passenger side are saved for approximately 30 minutes

longer. After this period, reactivation on the front-passenger side means that the settings from the driver's side will be used.

Transferring the driver's website







- ▶ To switch on SPLITVIEW: select **System** from the main function bar by turning  the COMAND controller and press  to confirm.
- ▶ Select  in the menu bar and confirm. SPLITVIEW symbol  appears in the display, and display  switches to **Off**.



- ▶ Select  in the main function bar with the remote control. A menu appears with the following options:
 - **Operator's Manual**
 - **Enter URL**
 - **Internet Favorites**
 - **Mercedes-Benz Apps**
 - **Internet Radio**
 - **Mercedes Mobile Website**
 - **Transfer Driver's Website**
- ▶ Select **Transfer Driver's Website** with the remote control. You see the last website called up by the driver.

Transferring a destination to the driver

Using SPLITVIEW you can select a destination from the front-passenger side and transfer this to the driver's side.

- ▶ To switch on SPLITVIEW: select **Settings** from the main function bar by turning  the COMAND controller and press  to confirm.
- ▶ Select  in the menu bar and confirm. SPLITVIEW symbol  appears in the display, and display  switches to **Off**.
- ▶ Select  in the main function bar with the remote control. A menu appears.
 - ▶ Select **Mercedes-Benz Apps** with the remote control. You see the selection of Mercedes-Benz Apps.
 - ▶ Select **Google Local Search** with the remote control. Using a menu you can select a category for the destination.
 - ▶ Select **At Current Position**, for example. Using a menu you can determine the type of search inquiry.
 - ▶ Select **Enter Search Term:**, for example. An input field appears.
 - ▶ Enter the destination with the remote control and confirm the entry with **OK**. You see the results list from Google.
 - ▶ Select the exact destination with the remote control. An additional menu appears.
 - ▶ Select **Navigate to**.
 - ▶ A window appears on the driver's side with the message: **Accept the navigation data from Mercedes-Benz Apps?**

System settings

Your COMAND equipment

These operating instructions describe all the standard and optional equipment for your COMAND system, as available at the time of going to print. Country-specific differences are possible. Please note that your COMAND system may not be equipped with all the features described.

Display settings

Setting the brightness

The brightness detected by the display light sensor affects the setting options for this function.

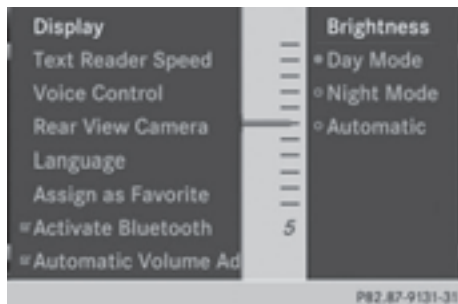

- ▶ Press **sys**.
- ▶ Select **Settings** by turning **⏪** the COMAND controller and press **⏩** to confirm.
- ▶ Select **Display** and press **⏩** to confirm.
- ▶ Select **Brightness** and press **⏩** to confirm.
- ▶ Adjust the brightness by turning **⏪** the COMAND controller and press **⏩** to confirm.

Display design

Your COMAND display features optimized designs for operation during daytime and night-time hours. You can customize the design by manually selecting day or night design, or opt for an automatic setting.

- ▶ Press **sys**.
- ▶ Select **Settings** by turning **⏪** the COMAND controller and press **⏩** to confirm.
- ▶ Select **Display** and press **⏩** to confirm.
- ▶ Select **Day Mode**, **Night Mode** or **Automatic** by turning **⏪** the COMAND controller and press **⏩** to confirm. A dot indicates the current setting.

Design	Explanation
Day Mode	The display is set permanently to day design.
Night Mode	The display is set permanently to night design.
Automatic	If the Automatic setting is selected, COMAND evaluates the readings from the automatic vehicle light sensor and automatically switches between the display designs.

Time settings

General information

If COMAND is equipped with a navigation system and has GPS reception, COMAND automatically sets the time and date. You can change the time in minute increments. The date can also be changed.

- i** If you adjust the time in minute increments, any time zone settings and settings for changing between summer and standard time are lost. Switching between summer and standard time (> page 307).
- i** The following navigation system functions require the time, time zone and summer/standard time to be set correctly in order to work properly:
 - route guidance on routes with time-dependent traffic guidance
 - calculation of expected time of arrival
- i** With this function, you can set the time for every display in the vehicle.

Setting the time/date format

- ▶ Press the **sys** button.
- ▶ Select **Time** by turning **⏪** the COMAND controller and press **⏩** to confirm.

- ▶ Select **Format** and press to confirm. The • symbols show the current settings.
- ▶ Set the format by turning the COMAND controller and press to confirm.

Abbreviation	Meaning
DD . MM . YY	Day . Month . Year (date format, two digits)
MM / DD / YYYY	Month/Day/Year date format, year (all four digits)
YY / MM / DD	Year/Month/Day date format, year (two digits)
HH : MM (24 hrs)	Hours : Minutes (24 hour time format)
HH : MM (AM/PM)	Hours : Minutes (AM/PM time format)

Adjusting the time zone and switching to Daylight Savings Time (Summer)

- ▶ Press .
- ▶ Select **Time** by turning the COMAND controller and press to confirm.
- ▶ Select **Time Zone** and press to confirm. A list of countries or time zones appears. The • dot indicates the current setting.
- ▶ Select the country or time zone by turning the COMAND controller and press to confirm. A time zone list may also be displayed, depending on the country selected.
- ▶ Select the time zone and press to confirm. The entry for the **Automatic Time Settings** is accepted.





Subsequent operation depends on whether the automatic changeover function to summer time is available.

- ▶ **To change manually:** select **ON** or **OFF** and press to confirm.
- ▶ **To change to automatic time:** select **Automatic** and press to confirm. The entry for the **Automatic Time Settings** is accepted.
- ▶ **To switch the automatic time setting off/on:** press the button.
- ▶ Select **Time** by turning the COMAND controller and press to confirm.
- ▶ Press to confirm the **Automatic Time Settings**. Switch the automatic time setting off or on again .
 - To switch on:** the menu item is switched on as the default setting. If the **Automatic Time Settings** is switched off and you switch it on again, the last settings for the time zone and summer time changeover are selected.
 - To switch off:** the time zone is deselected and the summer time is switched off. If **Automatic** is set for the summer time changeover, a prompt will appear asking whether this should be maintained.
- ▶ Select **Yes** or **No** and press to confirm.







Setting the time manually



- ▶ Press the button.
- ▶ Select **Time** by turning the COMAND controller and press to confirm.

- ▶ Select **Set Time Manually** and press  to confirm.
- ▶ Set the time by turning   the COMAND controller and press  to confirm. The time is accepted.





Text reader settings

- ▶ Press the **sys** button.
- ▶ Select **System** by turning   the COMAND controller and press  to confirm.
- ▶ Select **Text Reader Speed** and press  to confirm.
A list appears. The • dot indicates the current setting.
- ▶ Select a setting by turning   the COMAND controller and press  to confirm.

Voice Control System settings

Opening/closing the help window

The help window provides information in addition to the audible instructions during individualization and during the subsequent voice control.

- ▶ Press **sys**.
- ▶ Select **Settings** by turning   the COMAND controller and press  to confirm.
- ▶ Select **Voice Control** and press  to confirm.
- ▶ Select **Help Window** and press  to confirm.
You have switched the help window on or off .

Individualization

Using individualization, you can fine-tune the Voice Control System to your own voice and

thus improve voice recognition. See the separate operating instructions.

Bluetooth® settings

General information about Bluetooth®





Bluetooth®-capable devices, e.g. mobile phones, have to comply with a certain profile in order to be connected to COMAND. Every Bluetooth® device has its own specific Bluetooth® name.

Bluetooth® technology is a standard for short-range wireless data transmissions up to approximately 10 meters. Bluetooth® allows, for example, the exchange of vCards.



Bluetooth® is a registered trademark of Bluetooth Special Interest Group (SIG) Inc.

Activating/deactivating Bluetooth®

- ▶ Press **sys**.
The system menu appears.
- ▶ Select **Settings** by turning   the COMAND controller and press  to confirm.
- ▶ Select **Activate Bluetooth** and press  to confirm.
This switches Bluetooth® on or off .

Setting the system language

This function allows you to determine the language for the menu displays and the navigation announcements. The selected language affects the characters available for entry.

The navigation announcements are not available in all languages. If a language is not avail-

able, the navigation announcements will be in English.

When you set the system language, the language of the Voice Control System will change accordingly. If the selected language is not supported by the Voice Control System, English will be selected.

- ▶ Press the **sys** button.
- ▶ Select **System** by turning **⏮** the COMAND controller and press **⏹** to confirm.
- ▶ Select **Language** and press **⏹** to confirm. The list of languages appears. The **•** dot indicates the current setting.
- ▶ Select the language by turning **⏮** the COMAND controller and press **⏹** to confirm. COMAND loads the selected language and sets it.

Assigning a favorites button

- ▶ **To assign a favorites button:** press the **sys** button.
- ▶ Select **System** by turning **⏮** the COMAND controller and press **⏹** to confirm.
- ▶ Select **Assign as Favorite** and press **⏹** to confirm. The list of predefined functions appears. The dot **•** indicates the currently selected function.
- ▶ Select the function by turning **⏮** the COMAND controller and press **⏹** to confirm. The favorites button is assigned the selected function.
- ▶ **Example: to call up a favorite:** press the ***** favorites button. This calls up the predefined function.

You can select the following predefined functions in a menu:

- **SplitView on/off:** you can switch the screen view for the front passenger on or off.
- **Display On/Off:** you can switch the display off or on.
- **Full Screen: 'Clock':** you can call up the full screen with the clock.
- **Menu:** you can call up the online and Internet functions.
- **360° Camera:** you can call up the picture of the 360° camera.
- **Full screen: 'Map':** you can call up the full screen with the map.
- **Spoken Driving Tip:** you can call up the current driving recommendation.
- **Display Traffic Messages:** you can call up traffic reports.
- **Navigate Home:** you can start route guidance to your home address if you have already entered and saved the address (▷ page 327).
- **Detour Menu:** you can call up the Detour menu and then block a section of the route and recalculate the route (▷ page 349).
- **Compass Screen:** you can call up the compass.

Importing/exporting data

General notes

- ! Never remove the stick or card when writing data to the USB stick or the memory card. You may otherwise lose data.

Using this function, you can:

- transfer your personal COMAND data from one system/vehicle to another.
- make a backup copy of your personal data (export data) and load it again (import data).
- protect your data from unwanted export by activating a pin prompt (presetting: deactivated).

You can either use an SD memory card or a USB storage device (e.g. a USB stick) as temporary storage.

Activating/deactivating PIN protection

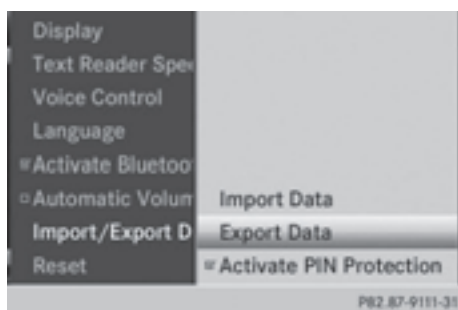

- ▶ Press the **[sys]** button. The system menu appears.
- ▶ Select **Settings** by turning **[⏪]** the COMAND controller and press **[⏩]** to confirm.
- ▶ Select **Import/Export Data** and press **[⏩]** to confirm.
- ▶ Select **Activate PIN Protection** and press **[⏩]** to confirm. Activate or deactivate PIN protection. When activating PIN protection, you will be prompted to enter a PIN.



- ▶ Enter a 4-digit PIN, select **[ok]** and press **[⏩]** to confirm. You will be prompted to enter the PIN again.
- ▶ Re-enter the PIN, select **[ok]** and press **[⏩]** to confirm. The PIN prompt now protects your personal data from unwanted export.

i If you deactivate your PIN protection, you will first be prompted to enter your PIN. If you have forgotten your PIN, a Mercedes-Benz service station can deactivate your PIN protection for you. Alternatively, you can deactivate PIN protection by resetting your personal COMAND data (▷ page 311).

Importing/exporting data

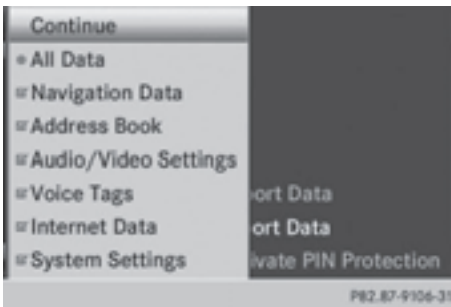

- ▶ Insert the SD memory card (▶ page 445).
or
- ▶ Connect a USB device (e.g. a USB memory stick) (▶ page 445).
- ▶ Press **[SYS]**.
The system menu appears.
- ▶ Select **Settings** by turning **[⊖]** the COMAND controller and press **[OK]** to confirm.
- ▶ Select **Import/Export Data** and press **[OK]** to confirm.
- ▶ Select **Import Data** or **Export Data** and press **[OK]** to confirm.



If PIN protection is activated, a PIN prompt appears when you select **Export Data**.

- ▶ Enter the PIN, select **[OK]** and press **[OK]** to confirm.
You can now proceed in the same way as if PIN protection was deactivated.
- ▶ **To select a preset:** select **Memory Card** or **USB Storage** and press **[OK]** to confirm.
- ▶ Select **All Data** and press **[OK]** to confirm.
This function exports all the data to the selected disc.

or

- ▶ Select the data type and press **[OK]** to confirm.
Depending on the previous entry, select the data type for the export or not .
- ▶ Select **Cont.** and press **[OK]** to confirm.
- i** Personal music files in the MUSIC REGISTER cannot be saved and imported again using this function.

Reset function

You can completely reset COMAND to the factory settings. Amongst other things, this will delete all personal COMAND data. This includes the station presets, entries in the destination memory and in the list of previous destinations in the navigation system and address book entries. In addition, any activated PIN protection, which you have used to protect your data against unwanted export, will be deactivated. Resetting is recommen-

ded before selling or transferring ownership of your vehicle, for example.

Data on the internal hard drive, e.g. music files in the MUSIC REGISTER, will be deleted. You can also delete music files from the MUSIC REGISTER using the "Delete all music files" function (▷ page 457).

- ▶ Press the **sys** function button.
- ▶ Select **System** by turning **⏪** the COMAND controller and press **⏩** to confirm.
- ▶ Select **Reset** and press **⏩** to confirm. A warning message appears asking whether you wish to reset.
- ▶ Select **Yes** or **No** and press **⏩** to confirm. If you select **Yes**, a prompt will appear again asking whether you really wish to reset to the factory settings.
- ▶ Select **Yes** or **No** and press **⏩** to confirm. If you select **Yes**, a message will be shown. COMAND is reset and restarted. If you select **No**, the process will be canceled.

Vehicle functions

Your COMAND equipment

These operating instructions describe all the standard and optional equipment for your COMAND system, as available at the time of going to print. Country-specific differences are possible. Please note that your COMAND system may not be equipped with all the features described.

Climate control status display



The climate status display in the COMAND display (example)

If you change the settings of the climate control system, the climate status display appears for three seconds at the bottom of the screen in the COMAND display. You will see the current settings of the various climate control functions.

Overview of climate control systems, see the separate vehicle operating instructions.

The climate status display appears when:

- ▶ You turn the temperature control and set the temperature.

or

- ▶ You turn the control to set the airflow.

or

- ▶ You press one of the following buttons:



Increases air flow



Decreases air flow



Switches climate control on/off



Switches the ZONE function on/off



Controls the air conditioning automatically



Sets the climate control style in automatic mode (FOCUS/MEDIUM/DIFFUSE)



Sets the air distribution



Sets the air distribution



Turns on the defrost function



Turns on maximum cooling

- i** The way that the climate control status display is called up depends on your vehicle's climate control system.



Example settings for the defrost function (top) and for the climate mode in automatic mode

- ▶ **To hide the display:** turn or press the COMAND controller.

or

- ▶ Press one of the buttons on COMAND.

Fuel consumption indicator

Overview

Depending on the vehicle equipment and the engine variant installed, fuel consumption can be shown in the COMAND display.

If your vehicle is a hybrid vehicle and the installed engine variant supports it, you can call up other displays (see the separate operating instructions).

Calling up/exiting the display

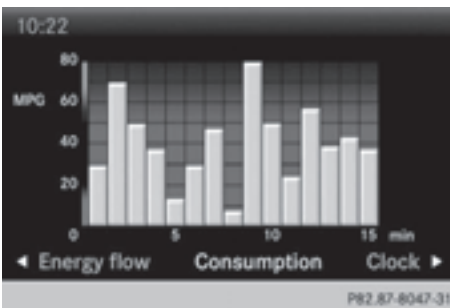

- ▶ **To call up the full screen display:** press the **sys** button.

- ▶ In the system menu, slide **↑** the COMAND controller up until the **Full Screen** option is selected.

- ▶ Press **⏻** the COMAND controller. The system display is shown as full screen (without system menu).

- ▶ Slide **←** the COMAND controller repeatedly until the fuel consumption indicator appears.

The COMAND display shows the fuel consumption for the last 15 minutes of the journey.

- ▶ **To exit the full-screen display:** press **⏻** the COMAND controller.

The system menu appears.

Every bar of the graph displays the average value for one minute.

The fuel consumption display may differ from the display in the **FROM START** trip computer in the **Trip** menu; see the vehicle Operator's Manual.

Driving conditions menu (Active Body Control)

General notes

On vehicles with Active Body Control (ABC), you can display some driving systems and additional information in the COMAND display.

Calling up drive status regulator (ABC)

- ▶ Press **sys**.

- ▶ In the system menu, slide **↑** the COMAND controller up until the display/selection window is selected.

- ▶ Slide **←** the COMAND controller repeatedly until the driving conditions menu (ABC) appears.

The corresponding displays appear in the COMAND display.

Details on the displays:

- for all vehicles except AMG vehicles, see the separate vehicle Operator's Manual
- for AMG vehicles, see the separate vehicle Operator's Manual.

Exiting the display

- ▶ Slide  the COMAND controller until the desired display (clock or fuel consumption) is shown.

Seat functions

Overview

Using the  button next to the COMAND controller or the Seat menu item in the system menu, you can call up different setting functions. The following settings depend on the type of seat and the vehicle model series:

- Seat cushion length
- Backrest side bolsters
- Lumbar
- Balance
- Seat cushion side bolsters
- Dynamics
- Massage







i You can also store and recall the current seat function settings using the memory button and the corresponding memory position switch; see the separate vehicle Operator's Manual.

The massage function cannot be started or stopped using the memory button.

Selecting the seat



First select the seat which you wish to adjust. This function is not available for all vehicles.

- ▶ Press the  or  button.
- ▶ Select **Seat** and press  to confirm.
- ▶ To switch to the lower line, for both options slide  the COMAND controller.
- ▶ Select **Driver's Seat** or **Passenger Seat** by turning  the COMAND controller and press  to confirm.



Adjustment functions



Adjusting the seat cushion length

The availability of this function depends on the type of seat and the vehicle model series.



This function allows you to adjust the height of the seat cushion.

- ▶ Select the seat (▷ page 314).
- ▶ Select **Seat Surface** by turning  the COMAND Controller and press  to confirm. A scale appears.





- ▶ Turn  or slide  the COMAND controller and press  to confirm.
- ▶ **To exit the menu:** press the **BACK** back button.

Adjusting the seat contour in the lumbar region of the seat backrest

The availability of this function depends on the type of seat and the vehicle model series.







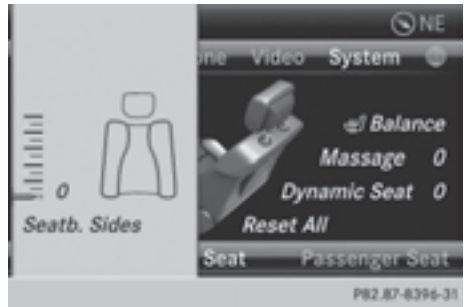

This function allows you to adjust the air cushions in the lumbar region of the backrest (4-way lumbar support).

- ▶ Select the seat (▷ page 314).
 - ▶ Select **Lumbar** by turning  the COMAND controller and press  to confirm.
- A crosshair appears. You can make two settings:
- **Vertical:** to move the point of greatest lumbar support up or down
 - **Horizontal:** to adjust the amount of support
- ▶ Slide  or  the COMAND controller and press  to confirm.
 - ▶ **To exit the menu:** press the **BACK** back button.

Adjusting the sides of the seat backrest (backrest side bolsters)

The availability of this function depends on the type of seat and the vehicle model series.



- ▶ Select the seat (▷ page 314).
 - ▶ Select **Seatb. Sides** by turning  the COMAND controller and press  to confirm.
- A scale appears.
- ▶ Turn  or slide  the COMAND controller and press  to confirm.
 - ▶ **To exit the menu:** press the **BACK** back button.





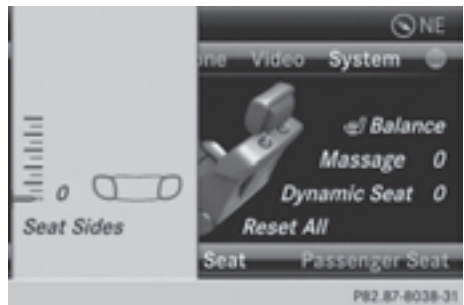

- ▶ **i** For vehicle model series with a dynamic multicontour seat: if the driving dynamics are activated and respond to a change of direction (e.g. when cornering), the backrest side bolsters cannot be temporarily adjusted.

Adjusting the seat side bolsters

The availability of this function depends on the type of seat and the vehicle model series.



This function allows you to adjust the air cushions in the seat side bolsters.

- ▶ Select the seat (▷ page 314).
- ▶ Select **Seat Sides** by turning  the COMAND controller and press  to confirm. A scale appears.
- ▶ Turn  or slide   the COMAND controller and press  to confirm.
- ▶ **To exit the menu:** press the **BACK** back button.



Balance

The availability of this function depends on the vehicle model series.







The Balance function controls the distribution of heat on the seat backrest and cushion.

The Balance function influences the currently set heating level of the seat heating; see the separate vehicle Operator's Manual.

- ▶ Select the seat (▷ page 314).
- ▶ Select **Balance** by turning  the COMAND controller and press  to confirm. A scale appears and shows the current setting. Positive values indicate the heat output for the seat backrest, negative values indicate the heat output for the seat cushion. The intensity is indicated by an orange bar in the stylized seat above the scale.

The values stand for:



- **0** - backrest and seat cushion are heated equally to the maximum level
 - **1 to 3** - the heat output to the seat cushion is reduced in one-third increments
 - **-1 to -3** - the heat output to the backrest is reduced in one-third increments
- ▶ Turn  or slide   the COMAND controller and press  to confirm.
 - ▶ **To exit the menu:** press the **BACK** back button.

Massage function

The availability of this function depends on the type of seat and the vehicle model series.



Example display (M-Class or GL-Class)

- ▶ Select the seat (▷ page 314).
- ▶ Select **Massage** by turning  the COMAND controller and press  to confirm. A list appears. You can select different types of massage function:
 - **0: Off**
 - **1: Slow and Gentle**
 - **2: Slow and Vigorous**
 - **3: Fast and Gentle**
 - **4: Fast and Vigorous**

- ▶ Turn **⌂** or slide **↑** **⌂** **↓** the COMAND controller and press **⌂** to confirm. The massage function runs for approximately 15 to 25 minutes, depending on the setting.
- ▶ **To exit the menu:** press the **BACK** back button.

Adjusting the driving dynamics

This function is available on vehicle model series with a dynamic multicontour seat.



- ▶ Select the seat (▷ page 314).
- ▶ Select **Dynamic Seat** by turning **⌂** the COMAND controller and press **⌂** to confirm. A scale appears. You can select:
 - **0:** Off
 - **1:** level 1 (medium setting)
 - **2:** level 2 (high setting)
- ▶ Turn **⌂** or slide **↑** **⌂** **↓** the COMAND controller and press **⌂** to confirm.
- ▶ **To exit the menu:** press the **BACK** back button.

Resetting all adjustments



- ▶ Select the seat (▷ page 314).
- ▶ Select **Reset All** by turning **⌂** the COMAND controller and press **⌂** to confirm. A prompt appears.
- ▶ Select **Yes** or **No** and press **⌂** to confirm. If you select **No**, the process will be canceled. After you select **Yes**, all seat adjustments are reset to the default values (factory setting).

Rear view camera

The rear view camera is only an aid. It is not a replacement for your attention to your immediate surroundings. You are always responsible for safe maneuvering and parking. When maneuvering or parking, make sure that there are no persons, animals or objects in the area in which you are maneuvering.

The image from the rear view camera is shown in the COMAND display when reverse gear is engaged if:

- your vehicle is equipped with a rear view camera
- COMAND is switched on
- the **Activation by R gear** function is activated.

If the function is activated, the COMAND display will automatically switch back to the previously selected display as soon as you shift out of reverse gear.

For further information on the rear view camera, see the vehicle Operator's Manual.

- ▶ Press the **sys** button.
The system menu appears.
- ▶ Select **Settings** by turning **⏪** the COMAND controller and press **⏩** to confirm.
- ▶ Select **Rear View Camera** and press **⏩** to confirm.
- ▶ Select **Activation by R gear** and press **⏩** to confirm.
The function is switched on or off , depending on the previous status.

Night View Assist Plus

On vehicles with Night View Assist Plus you can have the image from Night View Assist Plus shown on the COMAND display.

- ▶ Switch on COMAND (▷ page 295).
- ▶ Activate Night View Assist Plus, see the separate operating instructions.
The image from Night View Assist Plus appears in the COMAND display.
- ▶ **To adjust the brightness:** select **Brightness** by turning **⏪** the COMAND controller and press **⏩** to confirm.
- ▶ Turn **⏪** the COMAND controller and press **⏩** to confirm.
- ▶ **Switching automatic activation on/off:** select **Night View Assist Auto. Activation** and press **⏩** to confirm.
Switch the option on or off .

Option switched on: while using other functions e.g. the navigation system, Night View Assist Plus is active in the background. In the dark, in unlit surroundings and at speeds in excess of 37 mph (60 km/h), the Night View image is automatically displayed as soon as pedestrians or animals are detected.

- ▶ **To switch off the display:** select **Back** and press **⏩** to confirm or press the **BACK** button.

Navigation

Your COMAND equipment

These operating instructions describe all the standard and optional equipment for your COMAND system, as available at the time of going to print. Country-specific differences are possible. Please note that your COMAND system may not be equipped with all the features described.

Introduction

Important safety notes

WARNING

If you operate information systems and communication equipment integrated in the vehicle while driving, you will be distracted from traffic conditions. You could also lose control of the vehicle. There is a risk of an accident.

Only operate the equipment when the traffic situation permits. If you are not sure that this is possible, park the vehicle paying attention to traffic conditions and operate the equipment when the vehicle is stationary.

You must observe the legal requirements for the country in which you are currently driving when operating COMAND.

COMAND calculates the route to the destination without taking account of the following, for example:

- traffic lights
- stop and yield signs
- merging lanes
- parking or stopping in a no parking/no stopping zone
- other road and traffic rules and regulations
- narrow bridges

COMAND can give incorrect navigation commands if the actual street/traffic situation does not correspond with the digital map's data. Digital maps do not cover all areas nor all routes in an area. For example, a route may have been diverted or the direction of a one-way street may have changed.

For this reason, you must always observe road and traffic rules and regulations during your journey. Road and traffic rules and regulations always have priority over the system's driving recommendations.

Navigation announcements are intended to direct you while driving without diverting your attention from the road and driving.

Please always use this feature instead of consulting the map display for directions. Looking at the icons or map display can distract you from traffic conditions and driving, and increase the risk of an accident.

General notes

Operational readiness of the navigation system

The navigation system must determine the position of the vehicle before first use or whenever operational status is restored. Therefore, you may have to drive for a while before precise route guidance is possible.

GPS reception

Among other things, correct functioning of the navigation system depends on GPS reception. In certain situations, GPS reception may be impaired, there may be interference or there may be no reception at all, e.g. in tunnels or parking garages.

i Using roof carriers may impair the correct functioning of a roof antenna (phone, satellite radio, GPS).

Entry restriction

On vehicles for certain countries, there is a restriction on entering data.

The restriction is active from a vehicle speed of above approximately 3 mph (5 km/h). As

soon as the speed falls below approximately 2 mph (3 km/h), the restriction becomes inactive.

When the restriction is active, certain entries cannot be made. This will be indicated by the fact that certain menu items are grayed out and cannot be selected.

The following entries are not possible, for example:

- entering the destination city and street
- entering a destination via the map
- entering POIs in the vicinity of a city or via a name search
- editing entries
- using the number keypad for direct entry

Other entries are possible, such as entering points of interest in the vicinity of the destination or current position.

Switching to navigation mode



Map showing the menu; route guidance inactive

- ① Status bar
- ② Main function bar
- ③ Current vehicle position
- ④ Navigation menu bar

► Press the **NAVI** function button.

The map is displayed with the menu either shown or hidden.

or

► Select **Navi** in the main function bar by sliding **▲** and turning **⌚** the COMAND controller and press **⏹** to confirm.

The map is displayed with the menu shown.



PB2.89-0308-31

Map without the menu (route guidance inactive)

- ① Current vehicle position
- ② Map orientation selected
- ③ Map scale selected

i **Route guidance active** means that you have entered a destination and that COMAND has calculated the route. The display shows the route, changes of direction and lane recommendations. Navigation announcements guide you to your destination.

Route guidance inactive means that no destination has been entered yet and no route has been calculated yet.

Showing/hiding the menu

You can show or hide the menu on the map.

- ▶ **To hide the menu:** slide \uparrow \odot the COMAND controller and, when the **Full Screen** menu item is shown, press \odot to confirm.

or

- ▶ Press the **BACK** back button.
The map can be seen in the full-screen display.
- ▶ **To show the menu:** press \odot the COMAND controller when the map is shown in full-screen display.

Basic settings

Setting route type and route options

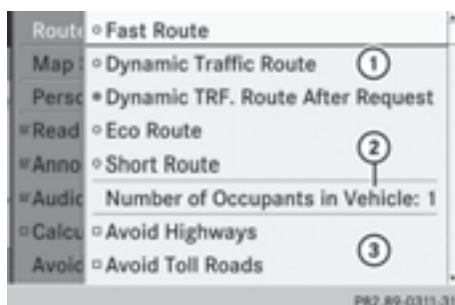

PB2.89-0311-31

Route settings menu (start of menu)

- ① To select the route type
- ② To set the number of persons in the vehicle for the use of carpool lanes
- ③ To set route options

- ▶ Select **Navi** in the main function bar by sliding \uparrow \odot and turning \leftarrow \odot the COMAND controller and press \odot to confirm.
- ▶ Select **Route Settings** and press \odot to confirm.
The route settings menu appears.
- ▶ Select a route type and press \odot to confirm.
A filled circle indicates the current setting.
- ▶ Select the route option(s) and press \odot to confirm.
The route options are switched on or off , depending on the previous status.

i If you change the route type and/or the route options while route guidance is active, COMAND will calculate a new route. If you change the route type and/or the route options while route guidance is inactive, COMAND uses the new setting for the next route guidance.

Route guidance active: a destination has been entered and the route has been calculated.

Route guidance inactive: no destination has been entered yet and no route has been calculated yet.

You can select the following route types:

- **Fast Route:** COMAND calculates a route with the shortest (minimized) journey time.
- **Dynamic Traffic Route:** is the same route type as **Fast Route**. In addition, COMAND takes into account any relevant traffic reports received during route guidance. The navigation system can help you avoid a traffic jam, for example, by recalculating the route.
- **Dynamic TRF. Route Only After Request:** is the same route type as **Dynamic Traffic Route**. After recalculating the route, COMAND asks you whether you want to adopt the new route or whether you want to continue along the original route.
- **Eco Route:** the **Eco Route** (economical route) is a variant of the **Fast Route** type. COMAND will attempt to minimize the journey distance at the expense of a slightly increased journey time.
- **Short Route:** COMAND calculates a route with the shortest possible (minimized) route distance.

i The route calculated may, for example, include ferry connections, even if the **Avoid Ferries** route option is switched on.

In some cases, COMAND may not be able to take all the selected route options into account, e.g. when calculating particularly long routes.

- ▶ **To exit the menu:** slide ←⊙→ the COMAND controller.

Setting the number of persons in the vehicle for the use of carpool lanes

For route calculation, you can take HOV or carpool lanes into account.

If you use HOV or carpool lanes, please observe the applicable laws as well as the local and time limitation conditions.

Carpool lanes may only be used under certain conditions. They can normally be used when there are two people in the vehicle. However, there are also carpool lanes which can only be used when there are three or more people in the vehicle. In California, lone drivers can use a carpool lane if their vehicle's emission level or fuel consumption is below a fixed threshold.

Carpool lanes may be reserved for specific times (e.g. during the peak period).

Carpool lanes are identified by HOV symbols on special road signs and by markings on the road. The road signs may also include the designation **CARPOOL**. The lanes are arranged as a separate lane next to the others or are built as a physically separate lane.

Depending on the setting under **Number of Occupants in Vehicle**, COMAND uses carpool lanes when calculating the route. COMAND then guides you in and out of carpool lanes using visual and acoustic driving directions.

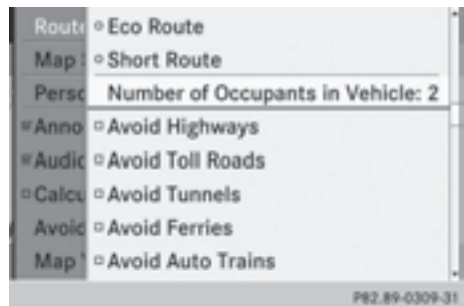

- ▶ In the route settings menu, select **Number of Occupants in Vehicle** by turning Ⓜ⊙ the COMAND controller.

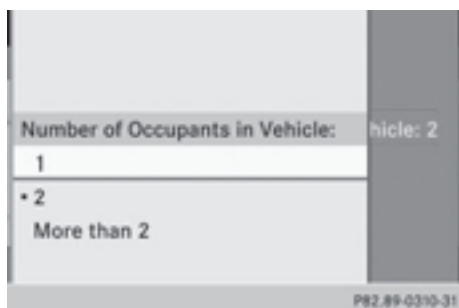

- ▶ Select **1**, **2** or **More than 2** by turning **⏮** and press **⏹** to confirm.
A • dot indicates the current setting.

Destination entry

Important safety notes

WARNING

If you operate information systems and communication equipment integrated in the vehicle while driving, you will be distracted from traffic conditions. You could also lose control of the vehicle. There is a risk of an accident. Only operate the equipment when the traffic situation permits. If you are not sure that this is possible, park the vehicle paying attention to traffic conditions and operate the equipment when the vehicle is stationary.

You must observe the legal requirements for the country in which you are currently driving when operating COMAND.

Entering a destination by address

Introduction

When entering an address as the destination, you have the following options:

- entering the state/province, city/ZIP code and street
- entering the state/province, city and center
- entering the state/province, city/ZIP code, street and house number

- entering the state/province, city/ZIP code, street and intersection
- entering the state/province, street, city and house number
- entering the state/province, street and house number
- entering the state/province, street and intersection

- ❗ You can only enter those cities, streets, ZIP codes etc. that are stored on the digital map. This means that for some countries, you cannot enter ZIP codes, for example.

The step-by-step instructions for entering an address use the following example data:

New York (state)

New York (city)

40 Broadway

Of course, you can freely enter information such as state/province, city, street and house number, for example to enter your home address.

Address entry menu

Calling up the address entry menu

- ▶ **To switch to navigation mode:** press the **NAVI** button.
- ▶ **To show the menu:** press **⏮** the COMAND controller.
- ▶ Select **Destination** by turning **⏮** the COMAND controller and press **⏹** to confirm.



Address entry menu



- ▶ Select **Address Entry** and press  to confirm.
The address entry menu appears. If you have previously entered a destination, this will be shown in the display.

Depending on the amount of the address entered and the data in the digital map, some menu items may not be available at all or may not yet be available.



Example: after entering the state/province, the menu items **Map, No., Center, Inter-section, Save** and **Start** are not available. The **ZIP** menu item will not be available unless the digital map contains ZIP codes.

Entering the state/province, city, street and number

Selecting a state/province

- ▶ Call up the address entry menu ([▷ page 322](#)).
- ▶ Select **State/Prov** in the address entry menu by turning  the COMAND controller and press  to confirm.
A menu with the available lists appears:
 - **Last States/Provinces**
 - **States (U.S.A.)**
 - **Provinces (Canada)**
- ▶ **To select a list:** turn  the COMAND controller and press  to confirm.
The list of selected states/provinces appears.
- ▶ **To select a state/province:** turn  the COMAND controller and press  to confirm.
The address entry menu appears again. The state/province selected has now been entered.

Entering a city

- ▶ Call up the address entry menu ([▷ page 322](#)).
- ▶ Select **City** in the address entry menu by turning  the COMAND controller and press  to confirm.
You will see the city list either with the character bar (option 1) or as a selection list (option 2).

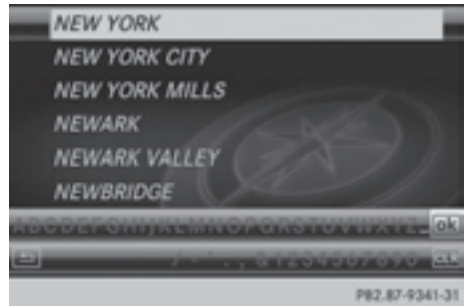

City list with character bar



Option 1: city list with the character bar

- ▶ Enter **NEW YORK**. Character entry, using city input as an example ([▷ page 301](#)).



List of cities as selection list

Option 2: city list as selection list

- ▶ Select an entry by turning  the COMAND controller.
- ▶ Irrespective of the option, press  to confirm your selection.
The address entry menu appears again. The city has now been entered.

Entering a street name

- ▶ Call up the address entry menu (▷ page 322).
- ▶ Select **Street** in the address entry menu by turning **⏪** and sliding **↑** the COMAND controller and press **⏩** to confirm.
You will see the street list either with the character bar (option 1) or as a selection list (option 2).

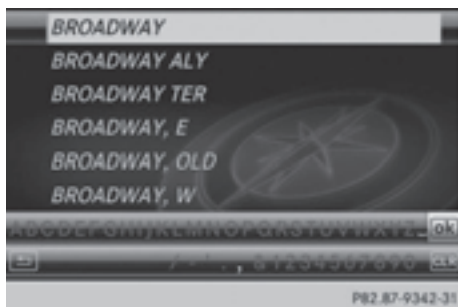

Street list with character bar

Option 1: street list with character bar

- ▶ Enter **BROADWAY**. Character entry, using city input as an example (▷ page 301).

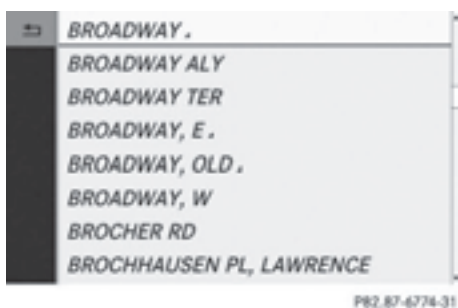

Street list as selection list

Option 2: street list as selection list

- ▶ Select a street by turning **⏪** the COMAND controller and press **⏩** to confirm.

If an entry has the **◻** symbol, it is ambiguous. You can select the entry you want from an additional selection list.

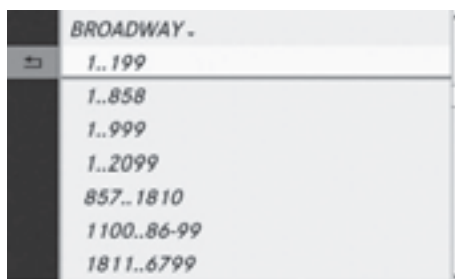

P82.87-6775-31

- ▶ Select an entry by turning **⏪** the COMAND controller.
- ▶ Irrespective of the option, press **⏩** to confirm your selection.
The address entry menu appears again. The street has now been entered.

Entering a house number

Entering a house number will delete a previously entered intersection.

- ▶ Call up the address entry menu (▷ page 322).
- ▶ Select **No.** in the address entry menu by turning **⏪** and sliding **↑** the COMAND controller and press **⏩** to confirm.
You will see the house number list either with the character bar (option 1) or as a selection list (option 2).



House number list with character bar

Option 1: house number list with character bar

- ▶ Enter **4** and **0**. Character entry, using city input as an example (▷ page 301).



House number list as selection list

Option 2: house number list as selection list

- ▶ Select an entry by turning **[⊙]** the COMAND controller.
- ▶ Irrespective of the option, press **[↵]** to confirm your selection.
The address entry menu appears again. The house number has now been entered.

Entering the ZIP code, center and intersection

Entering a ZIP code

- ▶ Call up the address entry menu (▷ page 322).
- ▶ Select **ZIP** in the address entry menu by turning **[⊙]** and sliding **↑⊙↓** the COMAND controller and press **[↵]** to confirm.
You will see the ZIP code list either with the character bar (option 1) or as a selection list (option 2).

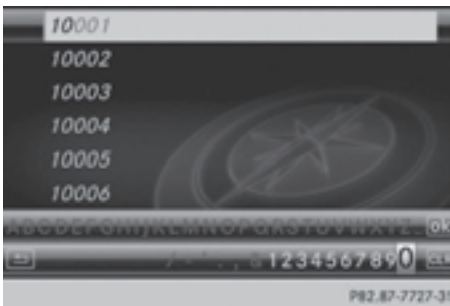

List of ZIP codes with character bar

Option 1: ZIP code list with character bar

- ▶ Enter a ZIP code. Character entry, using city input as an example (▷ page 301).

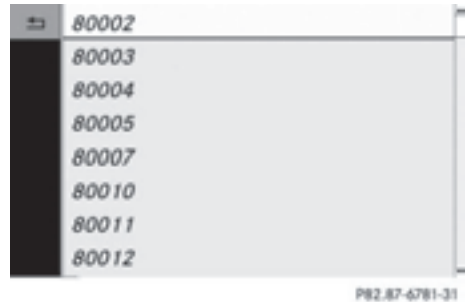

ZIP code list as selection list

Option 2: ZIP code list as selection list

- ▶ Select the desired zip code by turning **[⊙]** the COMAND controller.
- ▶ Irrespective of the option, press **[↵]** to confirm your selection.
If COMAND is able to assign the ZIP code unambiguously to a specific address, the address entry menu appears again. The ZIP code appears in place of the city's name.
If COMAND cannot assign the ZIP code unambiguously to a specific address, the address entry menu also appears again. The ZIP code is automatically entered. You can now enter the street for a more precise location. Only streets in the area covered by the entered ZIP code are available.
- ▶ Start route calculation (▷ page 327).

Entering a center

Entering a center will, for example, delete a previously entered street.

- ▶ Call up the address entry menu (▷ page 322).
- ▶ Select **Center** in the address entry menu by turning **[⊙]** and sliding **↑⊙↓** the COMAND controller and pressing **[↵]** to confirm.
You will see the center list either with the character bar (option 1) or as a selection list (option 2).



City center list with character bar

Option 1: center list with character bar

- ▶ Enter a center. Character entry, using city input as an example (▷ page 301).



Center list as selection list

Option 2: center list as selection list

- ▶ Select a center by turning **⏏** the COMAND controller.
- ▶ Irrespective of the option, press **⏏** to confirm your selection.
The address entry menu appears again. The center selected has been entered.
- ▶ Start route calculation (▷ page 327).

Entering an intersection

- ▶ Call up the address entry menu (▷ page 322).
- ▶ Select **Intersection** in the address entry menu by turning **⏏** and sliding **↑** **⏏** **↓** the

COMAND controller and pressing **⏏** to confirm.

You will see the intersection list either with the character bar (option 1) or as a selection list (option 2).



Intersection list with character bar

- ① List entry most closely resembling the characters entered so far
- ② List
- ③ Character bar

Option 1: intersection list with character bar

- ▶ Enter an intersection. Character entry, using city input as an example (▷ page 301).

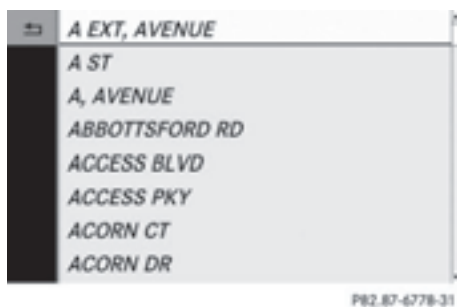

Intersection list as selection list

Option 2: intersection list as selection list

- ▶ Select an intersection by turning **⏏** the COMAND controller.

- ▶ Irrespective of the option, press to confirm your selection.
The address entry menu appears again. The intersection selected has been entered.
- ▶ Start route calculation (▷ page 327).

Starting route calculation



Address entry menu with destination address

- ① Destination address
- ② To start route calculation

You can have COMAND calculate a route to the destination address, or you can save the destination address (for example, as your home address (My address)) (▷ page 327).

- ▶ Call up the address entry menu (▷ page 322).
 - ▶ In the address entry menu, confirm **Start** by pressing .
- If no other route has been calculated, route calculation starts immediately (option 1). If another route has already been calculated (route guidance is active), a prompt appears (option 2).

i The **Continue** menu item is displayed instead of **Start** if **Calculate Alternative Routes** is activated in the navigation menu (option 2) (▷ page 349).

Option 1 – no route guidance active: route calculation starts. While route calculation is in progress, an arrow will indicate the direction to your destination. Below this, you will see a message, e.g. **Calculating Fast Route...**

Once the route has been calculated, route guidance begins.

If the vehicle is not on a digitized road, the following is displayed:

- the linear distance to the destination
- the direction to the destination
- the **Off Mapped Road** message

Option 2 – route guidance is already

active: if route guidance is already active, a prompt will appear asking whether you wish to terminate the currently active route guidance.

- ▶ Select **Yes** or **No** and press to confirm.
If you select **Yes**, COMAND will stop route guidance and start route calculation for the new destination.

If you select **No**, COMAND will continue with the active route guidance.

i Route calculation takes a certain amount of time. The time depends on the distance from the destination, for example. COMAND calculates the route using the digital map data.

The calculated route can differ from the ideal route, for example because of incomplete map data. Please also refer to the notes about the digital map (▷ page 375).

Entering and saving your home address

You can either enter your home address for the first time (option 1) or edit a previously stored home address (option 2).

- ▶ **Option 1:** enter the address, e.g. a city, street and house number (▷ page 323).
- ▶ After entering the address in the address entry menu, select **Save** by turning and sliding the COMAND controller and press .
- ▶ Select **Save as "My Address"** and press to confirm.
COMAND stores your home address as **My Address** in the destination memory.
- ▶ **Option 2:** proceed as described under "Option 1".
A prompt appears asking whether the current home address should be overwritten.

- ▶ Select **Yes** and press to confirm.
After selecting **Yes**, the **Data Saved** message appears.

Selecting a destination from the destination memory (e.g. My address)

Introduction

The destination memory always contains an entry named "My Address". You may wish to assign your home address to this entry, for example (▷ page 327), and select it for route guidance. This entry is always located at the top of the list in the destination memory.

- ▶ **To switch to navigation mode:** press the button.
- ▶ **To show the menu:** press the COMAND controller.
- ▶ Select **Destination** in the navigation system menu bar by turning the COMAND controller and press to confirm.
- ▶ Select **From Memory** and press to confirm.
You will see the destination memory list either with the character bar (option 1) or as a selection list (option 2).

Option 1: destination memory list with character bar



- ① Character entered by the user
- ② Characters automatically added by the system

- ③ List entry most closely resembling the characters entered so far
- ④ Switches to the selection list
- ⑤ Deletes an entry
- ⑥ Characters not currently available
- ⑦ Character bar
- ⑧ Currently selected character
- ⑨ Cancels an entry
- ⑩ Characters currently available

- ▶ Enter a destination, e.g. "My Address".
Character entry, using city input as an example (▷ page 301).

Option 2: destination memory list as selection list

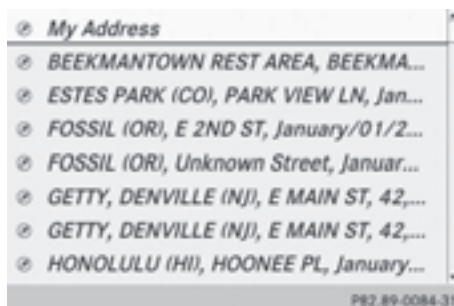

Destination memory list

- ▶ Select **My Address** by turning the COMAND controller.
- ▶ Irrespective of the option, press to confirm your selection.
The address entry menu appears again. "My Address" has been entered.
- ▶ **To start route calculation:** select **Start** and press to confirm.

Entering a destination from the list of last destinations

- ▶ **To switch to navigation mode:** press the button.
- ▶ **To show the menu:** press the COMAND controller.

- ▶ Select **Destination** in the navigation system menu bar by turning **[⊙]** the COMAND controller and press **[⊙]** to confirm.



- ▶ Select **From Last Destinations** and press **[⊙]** to confirm.
- ▶ Select the desired destination by turning **[⊙]** the COMAND controller and press **[⊙]** to confirm. The address entry menu appears again. The destination address selected has been entered.

- ▶ **To start route calculation:** select **Start** and press **[⊙]** to confirm.

Once the route has been calculated, route guidance begins (▷ page 327).

- i** “Last destinations” memory (▷ page 364).

Entering a destination using the map

Calling up the map

- ▶ **To switch to navigation mode:** press the **NAVI** button.
- ▶ **To show the menu:** press **[⊙]** the COMAND controller.
- ▶ Select **Destination** in the navigation system menu bar by turning **[⊙]** the COMAND controller and press **[⊙]** to confirm.



- ① Current vehicle position
- ② Crosshair
- ③ Details of the crosshair position
- ④ Map scale selected

- ▶ Select **Using Map** and press **[⊙]** to confirm. You will see the map with a crosshair.

Display ③ depends on the settings selected in "Map information in the display" (▷ page 368). You can see the current street name if the digital map contains the necessary data. You can see the coordinates of the crosshair if the geo-coordinate display is switched on and the GPS signal is strong enough.

Moving the map and selecting the destination

- ▶ **To scroll the map:** slide **←⊙→**, **↑⊙↓** or **[⊙]** the COMAND controller.
- ▶ **To set the map scale:** as soon as you turn **[⊙]** the COMAND controller, the scale bar appears.
- ▶ Turn **[⊙]** until the desired scale is set. Turning clockwise zooms out from the map; turning counter-clockwise zooms in.

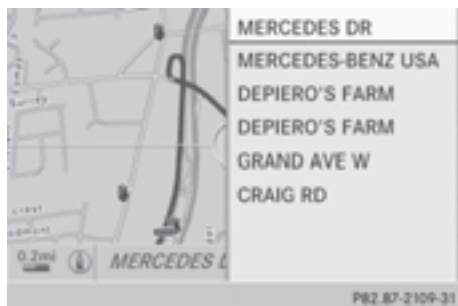

► **To select a destination:** press the COMAND controller once or several times. If COMAND is unable to assign a unique address, you will see either the address entry menu with the destination address or a selection list.

► Select a destination by turning the COMAND controller and press to confirm. If the destination is within the limits of the digital map, COMAND attempts to assign the destination to the map.

If the destination can be assigned, you will see the address entry menu with the address of the destination. If not, you will see the **Destination From Map** entry.

► **To start route calculation:** select **Start** and press to confirm.

Entering a destination using geo-coordinates

► **To switch to navigation mode:** press the button.

► **To show the menu:** press the COMAND controller.

► Select **Destination** in the navigation system menu bar by turning the COMAND controller and press to confirm.



► Select **Using Geo-Coordinates** and press to confirm. An entry menu appears.

You can now enter the latitude and longitude coordinates with the COMAND controller or the number keypad (► page 301).

► **To change a value:** turn the COMAND controller.

► **To move the mark within the line:** slide the COMAND controller.

► **To move the mark between the lines:** slide the COMAND controller.

► **To confirm the value:** press the COMAND controller.

i If the selected position is outside the digital map, COMAND uses the nearest digitized road for route calculation. You will see the **The co-ordinates are outside the map** message. If the selected position is located over a body of water, you will see the **The destination is in a body of water. Please select another destination.** message.

Entering a destination using Mercedes-Benz Apps

► **To switch to navigation mode:** press the button.

► **To show the menu:** press the COMAND controller.







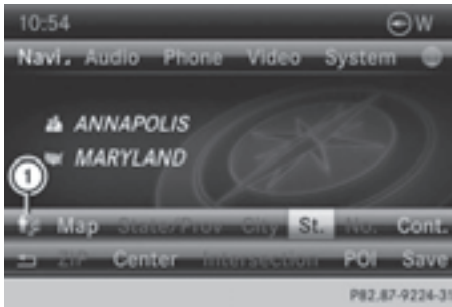

► Select **Destination** in the navigation system menu bar by turning the

COMAND controller and press  to confirm.

- ▶ Select **Mercedes-Benz Apps** and press  to confirm.
If an Internet connection is established, you will see the message: **Do you want to accept the navigation data sent via Mercedes-Benz Apps?**

Street View



- ▶ **To switch to navigation mode:** press the **NAVI** button.
- ▶ **To show the menu:** press  the COMAND controller.
- ▶ Select **Destination** in the lower menu bar by turning  the COMAND controller and press  to confirm.
- ▶ Select **Address Entry** and press  to confirm.
- ▶ Select icon  in the address entry menu and press  to confirm.
If an Internet connection is established, you will see the Street View basic display.
- ▶ **To explore the view of the street:** turn  or slide ,  the COMAND controller.
- ▶ **To return to navigation:** press the **BACK** button.

Entering way points

Introduction





You can map the route yourself by entering up to four way points. The sequence of the way points can be changed at any time.

COMAND provides a selection of predefined destinations in eight categories for this purpose, e.g. **GAS STATION** or **COFFEE SHOP**. You can also use the destination entry options to enter way points.

Creating way points



Way point menu (with destination, without way point)

- ▶ **To switch to navigation mode:** press the **NAVI** button.
- ▶ **To show the menu:** press  the COMAND controller.
- ▶ Select **Destination** in the navigation system menu bar by turning  the COMAND controller and press  to confirm.
- ▶ Select **Way Points** and press  to confirm.
The destination is entered into the intermediate destinations menu. The intermediate destinations are not yet entered.
- ▶ Confirm **Add:** by pressing  the COMAND controller.

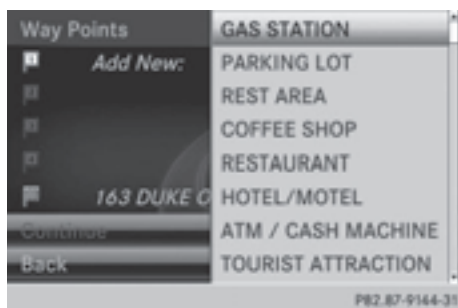

- ▶ Select the category or **Other** by turning the COMAND controller and press to confirm.

After selecting a category, the POIs which are available along the route and in the vicinity are displayed.

COMAND first searches for destinations along the route. Searching for destinations then continues within a radius of approximately 60 miles (100 km) of the vehicle position.

- ▶ After selecting **Other**, select one of the destination entry options from the list.

Selection	Action
Address Entry	▶ Enter a destination by address (▷ page 322).
From Memory	▶ Select a destination from the destination memory (▷ page 328).
From Last Destinations	▶ Select a destination from the list of last destinations (▷ page 328).
From POIs	▶ Select a point of interest (▷ page 334).

Selection	Action
From Personal POIs	▶ Enter a destination from the personal POIs (▷ page 342).
Using Map	▶ Enter a destination using the map (▷ page 329).
Using Geo-Coordinates	▶ Enter a destination using the geo-coordinates (▷ page 330).

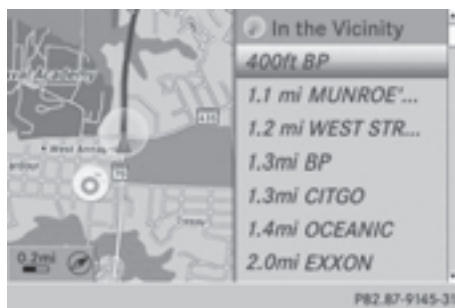

- ▶ Select POI and press to confirm. After selecting a POI or entering a destination, the address of the way point is displayed.

After entering a destination using the map, the address entry menu is displayed. **OK** is highlighted.

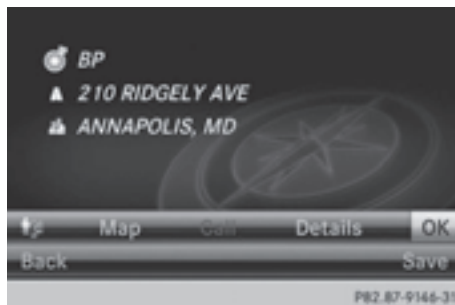

▶ **To accept the way point:** confirm **OK** by pressing **OK**.

Once you have accepted the way point, it is entered in the way point menu.

▶ **To display the details:** select **Details** by turning **Left** the COMAND controller and press **OK** to confirm.

▶ **To make a call:** select **Call** with the COMAND controller and press **OK** to confirm. COMAND switches to telephone mode (▷ page 387).

i This menu item is available if the way point has a telephone number and if a mobile phone is connected to COMAND (▷ page 381).

▶ **To call up the map:** select **Map** with the COMAND controller and press **OK** to confirm.

▶ You can move the map and select the destination.

▶ **To store the way point in the destination memory:** select **Presets** with the COMAND controller and press **OK** to confirm (▷ page 362).

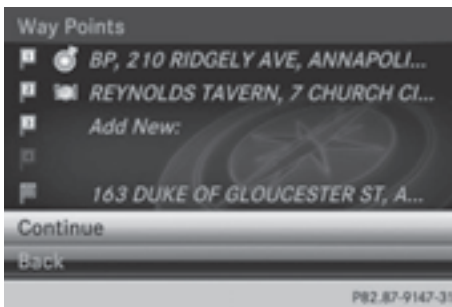

Way point menu with two way point entries

Editing way points

Way points can be:

- changed
- changed in sequence in the way point menu
- deleted

To change the sequence, at least one way point and the destination must be entered.

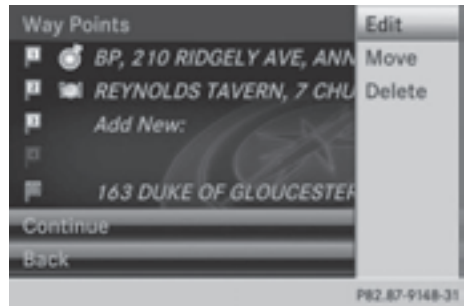

▶ Select a way point in the way point menu by turning **Left** the COMAND controller and press **OK** to confirm. A menu appears.

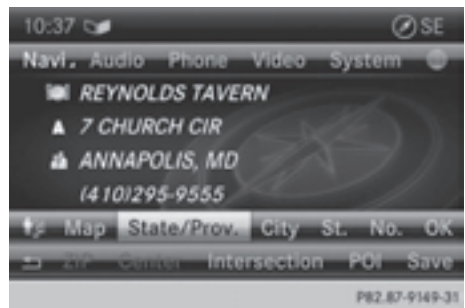

▶ **To change a way point:** select **Edit** from the menu and press **OK** to confirm.

▶ Change the address, e.g. the city and street, and confirm with **OK**. The way point menu appears and displays the modified way point.

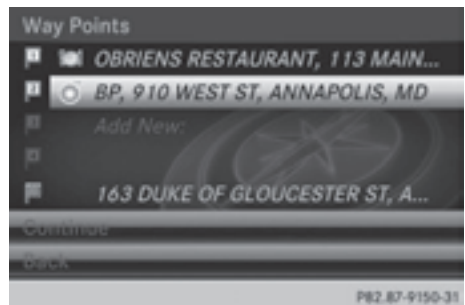

You can change the sequence of the way points and the destination.

- ▶ **To change the sequence:** from the menu, select **Move** by turning **[⏪]** the COMAND controller and press **[⏩]** to confirm.
- ▶ Turn **[⏪]** the COMAND controller and move the way point or destination to the desired position, then press **[⏩]** to confirm.
- ▶ **To delete way points:** from the menu, select **Delete** and press **[⏩]** to confirm.

Accepting way points for the route

- ▶ Select **Start** in the way point menu by turning **[⏪]** the COMAND controller and press **[⏩]** to confirm.
The route is calculated with the entered way points.

i **Continue** is displayed instead of **Start** when **Calculate Alternative Routes** is activated in the navigation menu (▷ page 349).

i If a way point has been passed during route guidance, the way point will be displayed in the way point menu with a green arrow. Once the route has been recalculated, the way point is deleted from the way point menu.

Searching for a gas station when the fuel level is low

If the reserve fuel warning is displayed, you will see the message: **Reserve Fuel Level//Do you want to start the search//for surrounding gas stations?**

- ▶ Select **Yes** or **No**.
If you select **Yes**, the gas station search starts. When the search is complete, a list of the gas stations available along the route or in the vicinity is displayed.
If you select **No**, the search is canceled.
- ▶ Select a gas station and press **[⏩]** to confirm.
The address of the gas station is displayed.
- ▶ Confirm **Start** by pressing **[⏩]**.
The selected gas station is entered into position 1 of the way points menu. Route guidance begins.

If the way points menu already contains four way points, a prompt will be displayed, asking you whether you wish to enter the gas station into position 1. If you select **Yes**, the gas station is transferred into the list and way point 4 is deleted.

Entering a POI

Calling up the points of interest menu

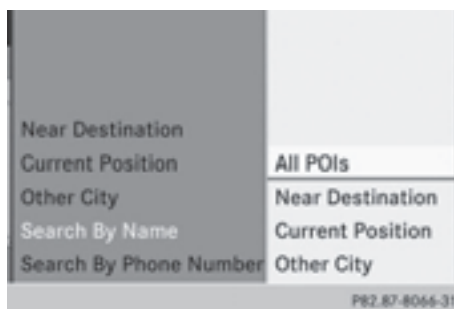







Example: POI menu

POIs are predefined destinations within categories, e.g. a gas station in the **AUTOMOTIVE** category.

- ▶ **To switch to navigation mode:** press the **[NAVI]** button.
- ▶ **To show the menu:** press **[⏪]** the COMAND controller.
- ▶ Select **Destination** in the navigation system menu bar by turning **[⏪]** the COMAND controller and press **[⏩]** to confirm.
- ▶ Select **From POIs** and press **[⏩]** to confirm.
A menu appears.
- ▶ Choose one of the options and press **[⏩]** to confirm.
Further steps are arranged in a table according to the option selected (▷ page 335).



Defining the position for the point of interest search

Selection	Characteristic	Instructions
Near Destination	Entry is only possible when route guidance is active.	<ul style="list-style-type: none"> ▶ Select Near Destination from the POI menu and press  to confirm. ▶ Select a POI category (▷ page 336).
Current Position	The system looks for a point of interest in the vicinity of the current vehicle position.	<ul style="list-style-type: none"> ▶ Select Current Position in the POI menu and press  to confirm. ▶ Select a POI category (▷ page 336).
Other City	After entering a city, the system looks for the POI within the city.	<p>Option 1</p> <ul style="list-style-type: none"> ▶ Select Other City in the POI menu and press  to confirm. ▶ If desired, select the state/province (▷ page 323). ▶ Enter the city. Proceed as described in the "Entering a city" section (▷ page 323). ▶ Select a POI category (▷ page 336). <p>Option 2:</p> <ul style="list-style-type: none"> ▶ Enter a city in the address entry menu (▷ page 322). ▶ Select POI and press  to confirm. ▶ Select a point of interest category.
Search By Name	You can call up all the points of interest in the digital map or focus your search on the three previously selected positions.	<ul style="list-style-type: none"> ▶ Select Search By Name in the POI menu and press  to confirm. ▶ Select All POIs or one of the three previously selected positions. The point of interest list with character bar appears. ▶ Proceed as described in the "POI list with character bar" section (▷ page 337).
Search By Phone Number	This function gives you access to all points of interest that have a phone number.	<ul style="list-style-type: none"> ▶ Select Search By Phone Number and press  to confirm. You will see a list of phone numbers. ▶ Proceed as described in the "POI list with character bar" section (▷ page 337).

Searching by point of interest category



POI category list

- ▶ Call up the POI menu (▷ page 334). After entering a city, the POI category list appears after choosing the menu item **Near Destination, Current Position** or **Other City**.
- ▶ Select a POI category by turning  the COMAND controller and press  to confirm. The  arrow behind an entry shows that other categories are available.

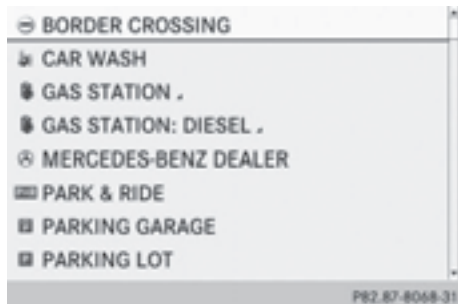

GAS STATION category selected

- ▶ Select an entry and press  to confirm. The search for points of interest begins in the vicinity of the selected position.

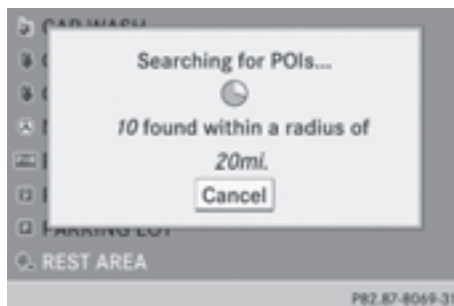

Point of interest search near the current position (example)

The POI search is canceled when 50 POIs have been found.

COMAND searches within a radius of approximately 60 miles (100 km).

Once the search is completed, the POI list is displayed.

If COMAND does not find any POIs within this radius, it extends its search range to approximately 125 miles (200 km).

If COMAND finds one POI within this radius, it finishes the search.

POI list

Introduction

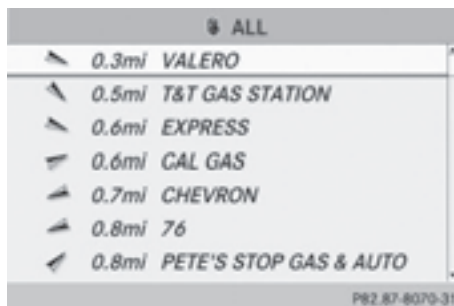

POI list (example)

The POI list displays the search results for the category in the vicinity of the selected position.

The search results display the following information:

- an arrow that shows the linear direction to the point of interest
- the linear distance to the point of interest
- the name of the point of interest

i The arrow and linear distance to the destination are not visible if you have entered a POI after entering another city.

The arrow is also not shown when searching for a POI in the vicinity of the destination.

Depending on the POI selected, COMAND uses different reference points in determining the linear distance to the destination:

- vicinity of current position: the linear distance is the distance of the point of interest from the current vehicle position.
- vicinity of destination: the linear distance is the distance from the destination entered to the point of interest.

Selecting a point of interest



- ① Point of interest with address
- ② To start route calculation
- ③ To store an address in the destination memory
- ④ To display details
- ⑤ To make a call (when available)
- ⑥ To cancel selection
- ⑦ To display a point of interest's position on the map

Further information on searching via POI categories (▷ page 336).

▶ Select the POI in the POI list by turning **⏪** the COMAND controller and press **⏩** to confirm.
The complete address of the point of interest selected is shown.

▶ **To start route calculation:** select **Start** ② and press **⏩** to confirm.

▶ **To store an address in the destination memory:** select **Save** ③ and press **⏩** to confirm. You can now select storing options (▷ page 362).

▶ **To show the detailed view:** select **Details** ④ and press **⏩** to confirm.

▶ **To make a call:** select **Call** ⑤ and press **⏩** to confirm. COMAND switches to telephone mode (▷ page 387).

i This menu item is available if the POI has a telephone number and a mobile phone is connected to COMAND (▷ page 381).

▶ **To call up the map:** select **Map** ⑦ and press **⏩** to confirm.

▶ You can move the map and select the destination (▷ page 329).

POI list with character bar

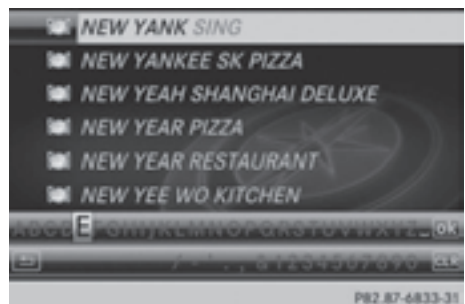

Search by name in the vicinity of the destination (example)

If you have selected **Search By Name** in the POI menu and then defined the position for the search (▷ page 335), the POI list with character bar appears.

Depending on your selection, you can select all available points of interest on the digital map or the points of interest in the vicinity of the selected position.

- ▶ Proceed as described in "Searching for a phone book entry" (▶ page 392). If COMAND can assign the characters entered to one entry unambiguously, the address entry appears automatically.
- ▶ **To start route calculation:** select **Start** and press to confirm.

ZAGAT® survey service



The Z icon before a search result shows that a ZAGAT® rating is available for this entry.

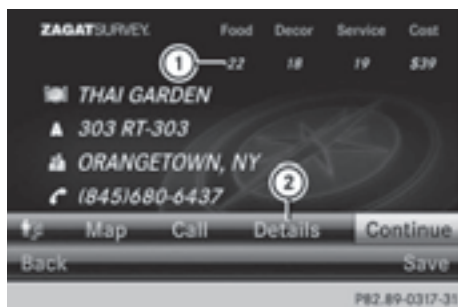

- ① ZAGAT ratings
 - ② To display details
- ▶ Select an entry with the "Z" icon by turning the COMAND controller and press to confirm. The ZAGAT evaluations appear.

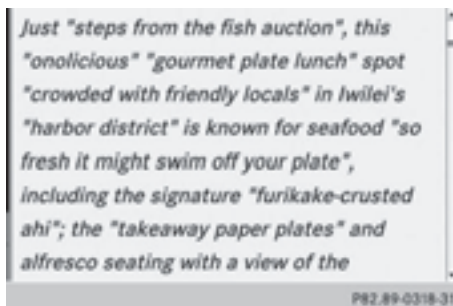

ZAGAT example description

- ▶ **To show the information:** select **Details** and press to confirm.

Selecting a POI using the map

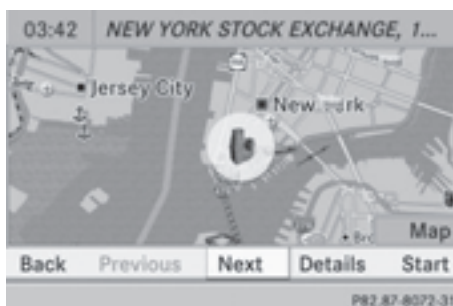

Point of interest on the map

You can select points of interest that are available in the selected (visible) section of the map. The POI is highlighted on the map, you will see further information on the upper edge of the display.

- ▶ **To switch to navigation mode:** press the button.
- ▶ **To show the menu:** press the COMAND controller.
- ▶ Select **Guide** in the navigation system menu bar by turning the COMAND controller and press to confirm. If points of interest are available: Depending on the map scale selected, point of interest icons appear on the map. The scale at which the icons are displayed on the map varies according to the icon.

You can select the icons that you want COMAND to display.

If no points of interest are available, you will see a message to this effect.

i You also see this message if you have selected the **No Symbols** menu item under "Map display" (▷ page 367).

- ▶ **To confirm the message:** press the COMAND controller.
- ▶ **To select a POI:** select **Next** or **Previous** and press to confirm.
- ▶ **To show details for the selection:** select **Details** and press to confirm.
- ▶ **To change to the map:** slide the COMAND controller. You can move the map and select the map section.
- ▶ **To start route calculation:** select **Start** and press to confirm. A prompt appears asking whether the point of interest should be used as the destination.
- ▶ Select **Yes** or **No** and press to confirm.
- i** **Cont.** is displayed instead of **Start** when **Calculate Alternative Routes** is activated in the navigation menu (▷ page 349).

Personal POIs

General notes

i The use of personal POIs for displaying traffic surveillance equipment is not permitted in every country. Please observe the country-specific regulations and adapt your speed accordingly when driving.

Settings

Calling up the "Personal POIs" menu

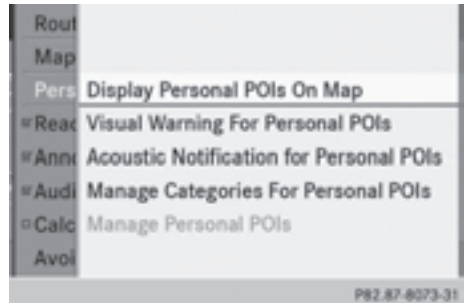

- ▶ **To switch to navigation mode:** press the **NAVI** button.
- ▶ **To show the menu:** press the COMAND controller.
- ▶ Select **Navi** in the main function bar by sliding and turning the COMAND controller and press to confirm.
- ▶ Select **Personal POIs** and press to confirm.

Displaying personal POIs on the map

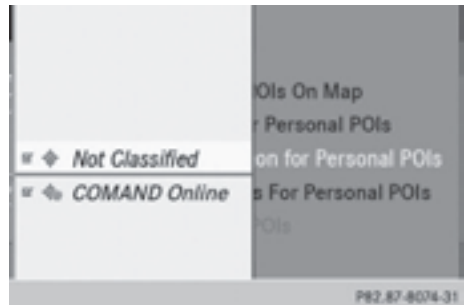



The personal POIs are shown on the map with an icon according to their category.

- ▶ Call up the "Personal POIs" menu (▷ page 339).
- ▶ Select **Display Personal POIs On Map** in the menu and press to confirm. You can select different categories.

Selection	Explanation
<input type="checkbox"/> Not Classified	Standard entry for personal POIs
<input type="checkbox"/> COMAND	Personal POIs (destinations, routes) that you have imported via the online function (▷ page 422).

If you have created your own categories (e.g. "Fishing", "Hotels"), they are also displayed (▷ page 340).

▶ Select a category and press  to confirm. The icon display is switched on or off , depending on the previous status.

 The icons will be displayed in the following map scales:

- 1/16 mile (50 m)
- 1/8 mile (100 m)
- 1/4 mile (200 m)
- 1/2 mile (500 m)

Visual warning for personal POIs





If the vehicle is approaching a personal POI, this is highlighted on the map. The display for the corresponding category must be activated for this.

- ▶ Call up the "Personal POIs" menu (▷ page 339).
- ▶ In the "Personal POIs" menu, select **Visual Warning For Personal POIs** and press  to confirm. The menu displays the available categories.

- ▶ Select a category and press  to confirm. This will switch the visual warning for all personal POIs of this category on or off , depending on the previous setting.

Acoustic notification for personal POIs

A gong sounds when the vehicle is approaching a personal POI. The function for the corresponding category must be activated for this.

- ▶ Call up the "Personal POIs" menu (▷ page 339).
- ▶ In the "Personal POIs" menu, select **Acoustic Notification for Personal POIs** and press  to confirm. The menu displays the available categories.
- ▶ Select a category and press  to confirm. This will switch the acoustic notification for all personal POIs of this category on or off , depending on the previous setting.

Managing categories for personal points of interest

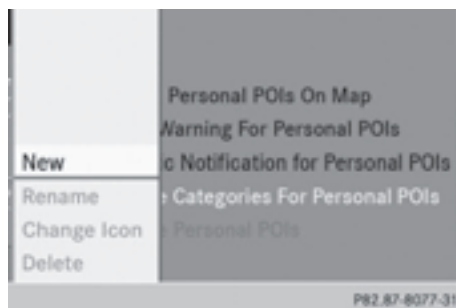

- ▶ Call up the "Personal POIs" menu (▷ page 339).
- ▶ In the "Personal POIs" menu, select **Manage Categories For Personal POIs** and press  to confirm.

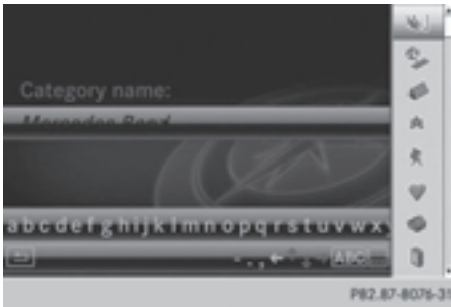

- ▶ **To create a new category:** select **New** and press to confirm.
 - ▶ Enter the name of the category. Character entry (> page 299).
 - ▶ Select the icon and press to confirm.
A list with icons appears. You can assign an icon to the category.
 - ▶ Select a symbol by turning the COMAND controller and press to confirm.
You have created a new category with a name and icon. This category appears when selecting the display on the map or when selecting the destination.
 - ▶ **To rename a category, to change an icon:** select **Rename** or **Change Icon** and press to confirm.
 - ▶ Proceed as described under "To create a new category".
 - ▶ **To delete a category:** select **Delete** and press to confirm.
A prompt appears asking whether the category should be deleted.
- i** If you delete a category, all points of interest of this category are also deleted.
- ▶ Select **Yes** and press to confirm.
If you select **Yes**, the category will be deleted.
If you select **No**, the process will be canceled.

Managing personal POIs

- ▶ Call up the "Personal POIs" menu (> page 339).
- ▶ Select **Manage Personal POIs** in the menu and press to confirm.
- ▶ Select **Not Classified, COMAND Online** or your own category and press to confirm.
- ▶ Select a personal POI and press to confirm.

The personal point of interest is displayed.

For further information on managing personal POI categories (> page 342):

- Renaming
- Changing the category
- Deleting

Saving personal POIs





There are three ways to save personal points of interest. You must insert an SD memory card to do so. The **No Memory Card** message otherwise appears.

Personal POIs and routes are saved on the memory card in the same data format in which the geographical data is stored. This format is based on the open GPX (GPS Exchange) format.



Option 1

- ▶ Insert the SD memory card (> page 445).
 - ▶ **To switch to navigation mode:** press the button.
 - ▶ Hide the menu to show the map in full screen mode (> page 320).
 - ▶ Press the COMAND controller for longer than two seconds.
The current position of the vehicle is saved as a personal POI on the SD memory card in the **Not Classified** category.
- i** The crosshair position is saved in the scrolling map function (> page 365).

Option 2:

- ▶ Insert the SD memory card (▷ page 445).
- ▶ **To switch to navigation mode:** press the **NAVI** button.
- ▶ **To show the menu:** press  the COMAND controller.
- ▶ Select **Position** in the navigation system menu bar by turning  the COMAND controller and press  to confirm.
- ▶ Select **Save Position As Personal POI** or **Save Crosshair Pos. as Personal POI** ("Move map" function active) and press  to confirm.
The list of personal categories appears.
- ▶ Select a category and press  to confirm.
- ▶ Name for the personal point of interest.
Character entry (▷ page 299).





Option 3

- ▶ Insert the SD memory card (▷ page 445).
- ▶ **To switch to navigation mode:** press the **NAVI** button.
- ▶ Call up the address entry menu (▷ page 322).
- ▶ Select **Save** from the address entry menu and press  to confirm.
- ▶ Select **Save As Personal POI** and press  to confirm.
- ▶ Select a category.
- ▶ Enter the name.
The current address is saved as a personal point of interest on the SD memory card.

Importing personal POIs via the online function

You can import personal POIs (destinations, routes) via the online function (▷ page 422). When importing, you can choose whether to write files to the SD memory card or to file them in the address book. The imported personal POIs have their own icon and are filed in the **COMAND Online** category.

Selecting as the destination

- ▶ Insert the SD memory card (▷ page 445).
- ▶ **To switch to navigation mode:** press the **NAVI** button.
- ▶ **To show the menu:** press  the COMAND controller.
- ▶ Select **Destination** in the navigation system menu bar by turning  the COMAND controller and press  to confirm.
- ▶ Select **From Personal POIs** and press  to confirm.
The categories of personal POIs appear.

Selection	Explanation
Not Classified	Standard entry for personal points of interest.
COMAND Online	Personal POIs which you have imported via the online function (▷ page 422).
Coffee Shops	Symbol and category that you have created yourself (▷ page 340).



In the example, the **Coffee Shops** category is selected.

The personal points of interest for this category are shown.



- ▶ Select a personal POI and press to confirm.
- ▶ **To rename a personal POI:** select **Rename** and press to confirm.
- ▶ **To change the category:** select **Change Category** and press to confirm.
- ▶ **To change to the map:** select **Map** and press to confirm.
The position of the personal point of interest is shown in the map.
- ▶ **To start route calculation:** select **Start** and press to confirm.
If route guidance has been activated, a prompt will appear asking whether you wish to accept the personal point of interest as the destination.

If route guidance has not been activated, route calculation for the personal point of interest will start immediately.

- ▶ Select **Yes** or **No** and press to confirm. If you select **Yes**, the personal POI is accepted as the destination.
If you select **No**, the process will be canceled.

- ▶ **To make a call:** select **Call** and press to confirm. COMAND switches to telephone mode (▷ page 388).

i **Call** is available if the personal POI has a telephone number and a mobile phone is connected to COMAND (▷ page 381).

- ▶ **To delete a personal POI:** select **Delete** and press to confirm.
A prompt appears asking whether you wish to delete the point of interest.
- ▶ Select **Yes** or **No** and press to confirm. If you select **Yes**, the personal POI is deleted.
If you select **No**, the process will be canceled.

Search & Send

Notes

- i** To use Search & Send, your vehicle needs to be equipped with mbrace, a navigation system and a valid mbrace subscription.

Search & Send is a service assisting you in entering destinations for the navigation system. This mbrace service can send a destination address directly from the Google Maps® website to the navigation system of your vehicle.

Selecting and sending a destination address

Please also refer to the notes about address entry online: maps.google.com.

- ▶ Call up the **maps.google.com** website and enter the destination address in the address entry field.
- ▶ Click the corresponding button to send the destination address to the e-mail address registered with mbrace.
- ▶ Enter the e-mail address you specified when setting up your mbrace account into the corresponding field in the "Send" dialog window.
- ▶ Click "Send".

Calling up destination addresses



- ▶ Press the  mbrace information button. Downloading of the destination address to the navigation system of your vehicle begins.
- i** If you have sent more than one destination address to your vehicle's navigation system, you will need to call up the information individually for every address to be downloaded.

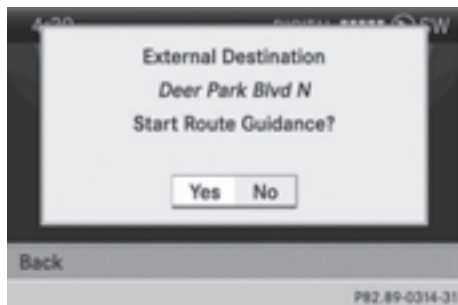

- ▶ Select **Yes** when the prompt for starting the navigation system is shown. The window

for starting the navigation system appears (▷ page 327).

- ▶ Select **Start**.

or

- ▶ Select **No** to store the downloaded destination in the destination memory for later use.

i The destination addresses are downloaded in the same order as they are sent.

If you own several Mercedes-Benz vehicles equipped with mbrace and a valid subscriber account: each destination address can be downloaded by each vehicle. This requires each vehicle to be registered with an e-mail address in your mbrace account.

Route guidance

Important notes

COMAND calculates the route to the destination without taking account of the following, for example:

- traffic lights
- stop and yield signs
- merging lanes
- parking or stopping in a no parking/no stopping zone
- other road and traffic rules and regulations
- narrow bridges

COMAND may give differing navigation commands if the actual street/traffic situation does not correspond with the digital map's data. For example, if the road layout or the direction of a one-way street has been changed.

For this reason, you must always observe road and traffic rules and regulations during your journey. Road and traffic rules and regulations always have priority over the system's driving recommendations.

Route guidance begins once a route has been calculated (▷ page 327).

COMAND guides you to your destination by means of navigation announcements in the

form of audible navigation announcements and route guidance displays. The route guidance displays can be seen if the display is switched to navigation mode. If you do not follow the navigation announcements or if you leave the calculated route, COMAND automatically calculates a new route to the destination.

If the digital map contains the corresponding information, the following applies:

- during route guidance, COMAND tries to avoid roads with restricted access. Those roads, for example, that are closed to through-traffic.
- roads that have time restrictions (e.g. closed on Sundays and public holidays) are considered for route guidance on days when they are open. For this purpose, the relevant times must be correctly stored in the database.

Displays during route guidance

Change of direction

Changes of direction have three phases:

- preparation phase
- announcement phase
- change-of-direction phase



Example: preparation phase

- ① Next road
- ② Point at which the change of direction takes place (light blue dot)

- ③ Current vehicle position (the tip of the triangle indicates the vehicle's direction of travel)
- ④ Current road

Display ④ depends on the setting selected for "Map information in the display" (> page 368).

COMAND prepares you for the upcoming change of direction. Based on the example display below, the change of direction is announced by the **Prepare to turn right** message. You see the full-screen map.

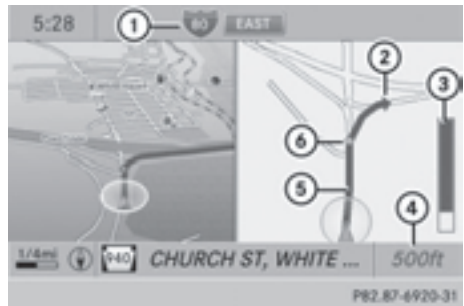

Example: announcement phase

- ① Next road
- ② Change of direction (turn right here)
- ③ Graphic representation of the distance to the next change of direction
- ④ Distance to the next change of direction
- ⑤ Route (highlighted in blue, shown in both the left and right displays)
- ⑥ Point at which the change of direction takes place (light blue dot, shown in both the left and right displays)
- ⓘ The filled-in section of visual display for distance ③ gets shorter the nearer you get to the announced change of direction.

COMAND announces the imminent change of direction. Based on the example display below, the change of direction is announced beforehand by the message: **Please turn right in 500 ft. and follow the <road name>**.

The distance announced before the next change of direction depends on the type of road and its permissible maximum speed.

The display is now split into two sectors. In the left half, you see the normal map view.

The right-hand half shows:

- an enlarged section of the area around the intersection (crossing zoom) or
- a 3D image of the road's course with the route indicating the next change of direction

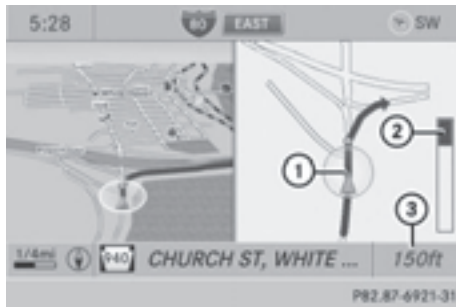

Example: change-of-direction phase

- ① Current vehicle position (the tip of the triangle indicates the vehicle's direction of travel)
- ② Graphic representation of the distance to the next change of direction
- ③ Distance to the next change of direction

COMAND announces the imminent change of direction.

Based on the example display below, the change of direction is announced 150 ft before the change of direction with the **Now turn right** message.

The display is split into two halves, as in the announcement phase.

Once the change of direction is completed, COMAND automatically switches back to full-screen display.

Example of a display without changes of direction



- ① Route (highlighted in blue)
- ② Current vehicle position
- ③ Current road
- ④ Map orientation selected
- ⑤ Map scale selected

Lane recommendations



Example: lane recommendations

- ① Point of the next change of direction
- ② Point of the change of direction after next
- ③ Next change of direction (in this case, turn off to the right)
- ④ Graphic representation of the distance to the next change of direction
- ⑤ Distance to the next change of direction
- ⑥ Possible lane (light blue)
- ⑦ Recommended lane (dark blue)
- ⑧ Lane not recommended (gray)
- ⑨ Current vehicle position, the tip of the triangle indicating the vehicle's direction of travel

On multi-lane roads, COMAND can display lane recommendations for the next change of direction. The corresponding data must be available in the digital map.

COMAND displays lane recommendation ⑦ based on the next two changes of direction. The number of lanes applies to the point at which the next change of direction is required.

i The multifunction display also shows lane recommendations.

Only the recommended lanes are displayed here, see the separate vehicle Operator's Manual.

Display and description of lane recommendations

Lane	Day mode	Night mode
Recommended lane In this lane, you will be able to complete the next two changes of direction without changing lanes.	Dark blue	Light blue
Possible lane In this lane, you will only be able to complete the next change of direction without changing lanes.	Light blue	Dark blue
Lane not recommended In this lane, you will not be able to complete the next change of direction without changing lanes.	Light brown or light gray	Gray

i The colors used in the lane recommendation display vary depending on whether day or night mode is switched on.

HOV or carpool lanes



- ① HOV symbol on the road sign
- ② HOV symbol on the car pool lane

A route may be calculated taking the use of HOV or carpool lanes into account. You can use HOV or carpool lanes depending on the number of persons in the vehicle as well as the local and time limitation conditions.

- i** This information is stored in the map data.
- i** You can enter the number of people in the vehicle (> page 321). In this section, you can also find more information on HOV or carpool lanes.



If the system guides you to or from a carpool lane, COMAND provides you with visual and acoustic driving instructions.

Navigation announcements





Repeating navigation announcements

Navigation announcements are intended to direct you while driving without diverting your attention from the road and driving. Please always use this feature instead of consulting the map display for directions. The symbols or the map display could distract you from traffic conditions and driving.

If you have missed an announcement, you can call up the current announcement at any time.





- ▶ **To show the menu:** press  the COMAND controller.
- ▶ Select **RPT** in the navigation system menu bar by turning  the COMAND controller and press  to confirm.

Switching navigation announcements on/off

- ▶ **To switch off:** press the  button during an announcement.
You will briefly see the message: **The guidance instructions have been muted.**
- ▶ **To switch on:** press  the COMAND controller.
- ▶ Select **RPT** in the navigation system menu bar by turning  the COMAND controller and press  to confirm.

- ❗ COMAND automatically switches the navigation announcements back on when:
 - you have a new route calculated.
 - you switch COMAND on again or start the engine.

Switching announcements and audio fadeout on/off

- ▶ Select **Nav**i in the main function bar by sliding  and turning  the COMAND controller and press  to confirm.
- ▶ Select **Announcements** and press  to confirm.

A menu appears.

You can activate/deactivate the following functions:

- **Announce Street Names**
Street names are announced during route guidance.
- **Audible Info During Phone Call**
During a phone call, navigation announcements and traffic reports are audible in the background.
- **Audio Fadeout**



The volume of an active audio or video source is automatically reduced during a navigation announcement.

- **Gas on Reserve**

Once you have reached reserve fuel level, you will see a prompt asking whether you wish to start the search for a gas station (> page 334).

- ▶ Select the function and press  to confirm. Switch the function on or off .





Setting the volume manually

- ▶ Adjust the volume using the  control knob during a navigation announcement.
- or
- ▶ Select **RPT** in the map view with the menu shown and adjust the volume using the  control knob.

Announce Street Names





If the function is switched on, the name of the street which you are turning into is announced.

Announcements are not made in the chosen language in all countries. They are made when relevant street names for the selected language are available in the database.

- ▶ **To switch to navigation mode:** press the  button.
- ▶ **To show the menu:** press  the COMAND controller.
- ▶ Select **Nav**i in the main function bar by sliding  the COMAND controller and press  to confirm.
- ▶ Select **Announce Street Names** and press  to confirm.
The function is switched on or off , depending on the previous status.

Canceling route guidance

Canceling or continuing route guidance

- ▶ **To switch to navigation mode:** press the **NAVI** button.
 - ▶ **To show the menu:** press  the COMAND controller.
 - ▶ Select **Destination** in the navigation system menu bar by turning  the COMAND controller and press  to confirm.
 - ▶ **To cancel route guidance:** select **Cancel Route Guidance** and press  to confirm.
- or
- ▶ **To continue route guidance:** select **Continue Route Guidance** and press  to confirm. COMAND calculates the route.

Destination or area of destination reached

When you reach your destination, COMAND displays a checkered flag and route guidance is automatically ended.







If the destination is not in close proximity to a digitized street, the **Area of destination reached** message appears when the destination is reached.

Influencing route guidance

Avoiding a section of the route blocked by a traffic jam

This function blocks a section of the route ahead of you. You can set the length of the blocked route section. If possible, COMAND calculates a detour around the blocked section of the route.

- ▶ **To switch to navigation mode:** press the **NAVI** button.
- ▶ **To show the menu:** press  the COMAND controller.

- ▶ Select **Route** in the navigation system menu bar by turning  the COMAND controller and press  to confirm.
- ▶ Select **Detour** and press  to confirm.
- ▶ **To block a section of the route:** select **Longer** or **Shorter** repeatedly and press  to confirm until the desired section has been selected.
 -  The total length of the section that can be blocked is defined by the digital map. The menu items are available accordingly.
- ▶ **To start route calculation:** select **Start** and press  to confirm.
- ▶ **To delete the blocked section:** select **Delete** while the message is shown and press  to confirm. COMAND calculates the route without the block.



Selecting an alternative route

With the "Alternative Route" function, routes other than the original one can be calculated. Routes 1 to 3 are calculated with the current settings for the route type and route options and are shown with a dark blue line (> page 320).

Route 4 is the economic route (eco route) and is shown with a green line.

On the right-hand side, you will see information on the currently selected alternative route, e.g. distance, estimated remaining driving time and estimated time of arrival. Route sections used (e.g. highways, tunnels) are displayed as symbols.

Option 1



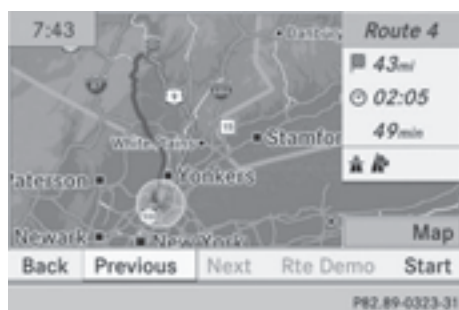
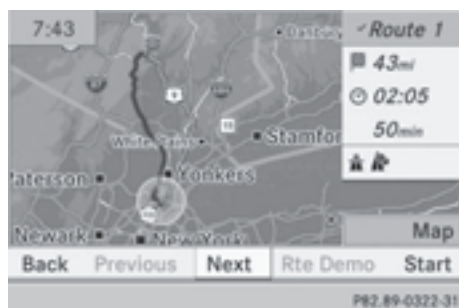

- ▶ **To switch to navigation mode:** press the **NAVI** button.
- ▶ **To show the menu:** press  the COMAND controller.
- ▶ Select **Route** in the navigation system menu bar by turning  the COMAND controller and press  to confirm.

- ▶ Select **Alternative Route** and press  to confirm.





Examples for route 1 (above) and route 4 (eco route)

Option 2:

- ▶ **To switch to navigation mode:** press the  button.
- ▶ **To show the menu:** press  the COMAND controller.
- ▶ Select **Navi** in the main function bar by sliding  the COMAND controller and press  to confirm.
- ▶ Select **Calculate Alternative Routes** and press  to confirm.
The function is switched on or off , depending on the previous status.
Function is activated: alternative routes are calculated directly after the destination is entered.

Menu functions

- ▶ **To select the next or previous alternative route:** select **Next** or **Previous** and press  to confirm.
- ▶ **To start route guidance using the selected alternative route:** select **Start** and press  to confirm.
COMAND begins route guidance on the selected alternative route.





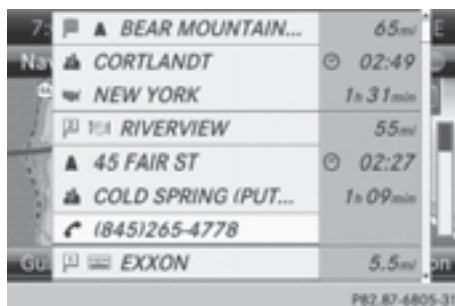

Route information

Displaying destination information



Example: destination information

The example shows information on distance, estimated time of arrival and estimated remaining driving time to the destination  and two way points.

- ▶ **To switch to navigation mode:** press the  button.
- ▶ **To show the menu:** press  the COMAND controller.
- ▶ Select **Route** in the navigation system menu bar by turning  the COMAND controller and press  to confirm.
- ▶ Select **Destination Information** and press  to confirm.
Destination information is displayed.
- ▶ **To call up further destination information:** turn  the COMAND controller.

- ▶ **To close the destination information:** slide ←○→ the COMAND controller or press the **BACK** back button.









i You can display destination information for the destination, for both way points and for the intermediate stop, if they are part of the route.

If a mobile phone is connected to COMAND and a phone number is included in the destination information, you can call it (▷ page 381).

Route overview

You can use the route overview to move along the active route section by section and view information and details about each section of the route.







You can see information relevant to the section of the route, such as the length of the road section you will be driving along and the road name. The highlighted route section is marked in white with a red border on the map.

- ▶ **To switch to navigation mode:** press the **NAVI** button.
- ▶ **To show the menu:** press  the COMAND controller.
- ▶ Select **Route** in the navigation system menu bar by turning  the COMAND controller and press  to confirm.
- ▶ Select **Route Browser** and press  to confirm.
- ▶ **To view the next or previous route section:** select **Next** or **Previous** and press  to confirm.
- i** If the first or last route section is highlighted, you cannot select **Previous** or **Next**.
- ▶ **To zoom in or out of the map:** select  or  and press  to confirm.
- ▶ **To close the route overview:** select **Back** and press  to confirm.

Route demonstration



You can see the route before starting your journey. This function is only available when the vehicle is stationary.

- ▶ **To switch to navigation mode:** press the **NAVI** button.
- ▶ **To show the menu:** press  the COMAND controller.
- ▶ Select **Route** in the navigation system menu bar by turning  the COMAND controller and press  to confirm.
- ▶ Select **Route Demonstration** and press  to confirm. The map with the crosshair appears.
- ▶ **To get to the destination:** press  to confirm the highlighted symbol.
- ▶ **To stop the route demonstration:** confirm the  symbol by pressing .



Example: route display stopped

- ① Road name and city display when route display has been stopped
 - ② Distance of the crosshair from current vehicle position
- ▶ **To get to the current vehicle position:** press to confirm the symbol for the current vehicle position.
 - ▶ **To change the map scale:** select **Scale** and press to confirm. The scale bar appears.
 - ▶ Turn the COMAND controller and press to confirm.

Recording the route

Notes

If you have activated COMAND and the SD memory card has been inserted, you should not take it out of the slot.

You can store up to 100 routes.

When you record a route, COMAND uses so-called support points and displays the route as a series of lines. If the route is then calculated, COMAND attempts to align the recorded route with the digital map.

The support points of the route may not be on a digitized road.

This is often the case for routes that have been calculated using map data from other sources.

Calling up the Routes menu

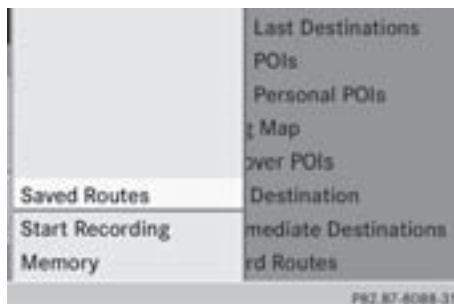

- ▶ Insert the SD memory card (▷ page 445).
- ▶ **To switch to navigation mode:** press the **NAVI** button.
- ▶ **To show the menu:** press the COMAND controller.
- ▶ Select **Destination** in the navigation system menu bar by turning the COMAND controller and press to confirm.
- ▶ Select **Routes**.

Starting/ending recording





- ▶ Call up the Routes menu (▷ page 352).
- ▶ **To start recording :** select **Start Recording** in the Routes menu by turning the COMAND controller and press to confirm. During the recording, the recorded route is shown behind the current vehicle position with gray strokes (symbol for tire tracks).
- ▶ **To end recording:** select **Stop Recording** in the Routes menu by turning the



COMAND controller and press  to confirm.



Displaying and editing the recorded route



- ▶ Insert the SD memory card (▷ page 445).
- ▶ Call up the Routes menu (▷ page 352).
- ▶ Select **List** in the Routes menu by turning  the COMAND controller and press  to confirm. Previously recorded routes are displayed.





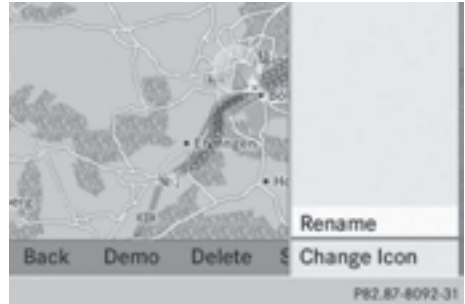

- ▶ Select a route and press  to confirm. The map appears with a menu. The recorded route is shown in the map with a blue dotted line.
- ▶ **To view a demonstration of the route on the map:** select **Demo** by turning  the COMAND controller and press  to confirm. The map with the crosshair appears.
- ▶ Proceed as described in the "Route demonstration" section (▷ page 351).

- ▶ **To begin route calculation:** select **Start** in the menu by turning  the COMAND controller and press  to confirm. COMAND attempts to align the recorded route with the digital map.





Changing route names and icons



- ▶ Select **Edit** in the menu by turning  the COMAND controller and press  to confirm.
- ▶ **To change the route name:** select **Rename** and press  to confirm.
 -  The name cannot be changed while the vehicle is in motion.
- ▶ **To change the icon:** select **Change Icon** and press  to confirm.

Observe the further information on managing categories for personal POIs (▷ page 340).

To change direction for route calculation: you can set the icon for the route to the starting point or to the destination, thereby changing the direction for route calculation.



During route calculation, one-way streets or turn restrictions, for example, are taken into account. Therefore, the outward and return routes may differ from each other.

- ▶ Select **Swap** in the menu by turning  the COMAND controller and press  to confirm.

- ▶ **To delete a route:** select **Delete** in the menu by turning  the COMAND controller and press  to confirm. A prompt appears asking whether the route should be deleted.
- ▶ Select **Yes** or **No** and press  to confirm. If you select **Yes**, the route will be deleted. If you select **No**, the process will be canceled.

Scanning the memory

The SD memory card is inserted.

- ▶ Call up the Routes menu (> page 352).
- ▶ Select **Memory Info** in the Routes menu by turning  the COMAND controller and press  to confirm. A message such as **Off-road Route Memory 90% Full**. is displayed.

Off-road and off-map

Notes

The navigation system may guide you to off-road routes that your vehicle cannot drive on without causing damage to the tires or wheels or the vehicle itself. It is the driver's sole responsibility to determine the suitability of the route. The condition of the off-road routes may vary, and their drivability may be affected by different factors such as time of day, season and current weather conditions, which the navigation system cannot judge or take into account.

Route guidance to a destination that is not on a digitized road



Example: route guidance to an off-road destination

- ① Off-road destination
- ② Off-road route section (blue dashes)
- ③ Current vehicle position (the tip of the triangle indicates the vehicle's direction of travel)
- ④ Off-road (if available)

COMAND can guide you to destinations which are within the area of the digital map, but which are not themselves recorded on the map.

These destinations are known as off-road destinations, which you can enter using the map, for example. In these cases, COMAND guides you for as long as possible with navigation announcements and displays on roads known to the system.

If the vehicle reaches an area which is not part of the digital map, the display appears as a split-screen view. On the right, an arrow appears that points to off-road destination ①. You will hear the announcement: "Please follow the arrow on the display". As the vehicle approaches the destination, the **Area of destination reached** message appears.

Route guidance from an off-road location to a destination

If the vehicle position is within the area covered by the digital map, but the map does not contain any information about that location, the vehicle is in an off-road location.

COMAND is also able to guide you to a destination even from an off-road location.

At the start of route guidance, you will see the **Off Mapped Road** message, an arrow and the distance to the destination. The arrow shows the compass heading to the actual destination.

The route is highlighted blue, starting from the last recognized street the vehicle was on before it left the map.

As soon as the vehicle is back on a road known to the system, route guidance continues in the usual way.

Route guidance from an off-map location to a destination

If the vehicle position is outside the area covered by the digital map, then the vehicle is in an off-map location. COMAND is also able to guide you to a destination even from an off-map location.

At the start of route guidance, you will see the **Off Mapped Road** message, an arrow and the distance to the destination. The direction arrow shows the compass heading to the destination.

The route is highlighted in blue from the nearest road known to the system.

As soon as the vehicle is back on a road known to the system, route guidance continues in the usual way.

Off-road during route guidance

Due to roadworks, for example, there may be differences between the data on the digital map and the actual course of the road.

In such cases, the system will temporarily be unable to locate the vehicle position on the digital map. The vehicle is therefore in an off-road position.

In the display, you will see the **Off Mapped Road** message, an arrow and the distance to the destination. The direction arrow shows the compass heading to the destination.

As soon as the system can assign the vehicle position to the map again, route guidance continues in the usual way.

Traffic reports

Prerequisites

- ① This function is currently not available for Canada.

To receive real-time traffic reports via satellite radio, you require:

- optional satellite radio equipment
- a subscription to SIRIUS XM Satellite Radio Traffic Message Service

Further information on satellite radio (▷ page 439).



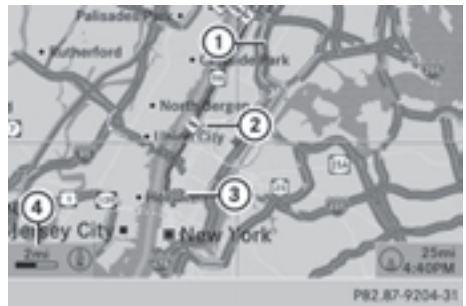

COMAND can receive traffic reports via satellite radio and take account of these for route guidance in the navigation system. Received traffic reports are displayed on the map either as text or as symbols.

Real-time traffic reports on the map



- ① Delimits the section of the route affected
- ② Indicates an incident on the route (traffic flow)
- ③ Destination
- ④ Map scale

COMAND can show certain traffic incidents on the map. Traffic reports are shown on the map at scales of 0.05 mi to 20 mi.

- ▶ **To hide the menu:** slide   the COMAND controller and, when the **Full Screen** menu item is shown, press  to confirm. The map can be seen in the full-screen display.
- ▶ Turn   the COMAND controller until the desired map scale is set.

Symbols used in real-time traffic reports

— Unimpeded traffic flow

Green line with arrows

The arrows can be seen on a map scale of 200 m (0.25 mi) and smaller.



Heavy/slow-moving traffic

Together with a yellow line

The symbol marks average speeds of 25 – 45 mph (40 – 72 km/h).



Caution, traffic incident



Traffic jam

Together with a red line and arrows

The symbol marks average speeds of 5 - 20 mph (8 - 32 km/h).

The arrows can be seen on a map scale of 200 m (0.25 mi) and smaller.



Warning message

Together with a red/white striped line and arrows

The arrows can be seen on a map scale of 200 m (0.25 mi) and smaller.



Blocked route section

Possibly in combination with X X X X

Displaying real-time traffic reports

Starting a search for traffic reports

► **To switch to navigation mode:** press the **NAVI** button.

► **To show the menu:** press the COMAND controller.

► Select **Traffic** by turning the COMAND controller and press to confirm.

A menu appears.

If **No Traffic Messages** appears, this means either:

- no traffic reports have been received yet, or
- no traffic reports are available.

► **To end the search:** select **Cancel** and press to confirm.

► **To close the report window:** select **OK** and press to confirm.

Traffic symbol information



Example display

- ① Affected roads with indication of direction
- ② Symbol for report type, e.g. traffic flow message

► **To switch to navigation mode:** press the **NAVI** button.

► **To show the menu:** press the COMAND controller.

- ▶ Select **Traffic** in the navigation system menu bar by turning the COMAND controller and press to confirm.
- ▶ Select **Traffic Symbol Information** by turning the COMAND controller and press to confirm.
- ▶ Select **Next** or **Previous** by turning the COMAND controller and press to confirm in order to continue highlighting traffic symbols.
- ▶ **To change the map scale:** select **Map** by sliding the COMAND controller and press to confirm. You can now zoom in or out of the map.

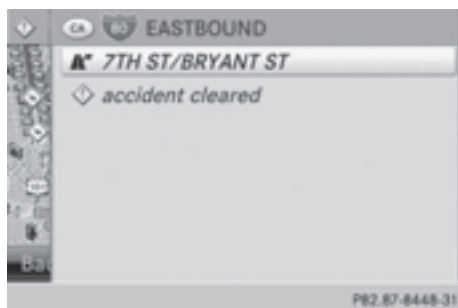

Example: details on traffic symbol information

- ▶ **To show the detailed view:** select **Details** and press to confirm.
- ▶ **To close the detailed view:** slide the COMAND controller.

Displaying reports on the route

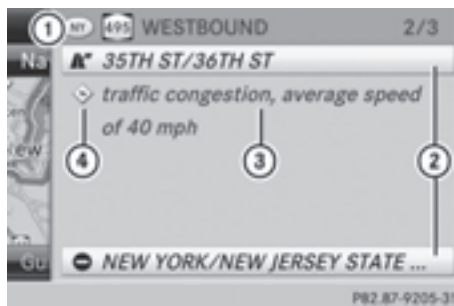

- ① State/province for the calculated route, road designation, direction and reports for the affected road (2/3)
- ② Section of the road to which the traffic report applies
- ③ Traffic report
- ④ Type of traffic report (slow-moving traffic)

- ▶ **To switch to navigation mode:** press the **NAVI** button.
- ▶ **To show the menu:** press the COMAND controller.
- ▶ Select **Traffic** in the navigation system menu bar by turning the COMAND controller and press to confirm.
- ▶ Select **Messages On Route** and press to confirm. The traffic report window appears. If there is more than one traffic report for a section of the route, this is indicated by 2/3, for example.
- ▶ **To scroll within a report or to access the next report:** turn the COMAND controller.
- ▶ **To return to the report list:** slide the COMAND controller.

Displaying all traffic reports

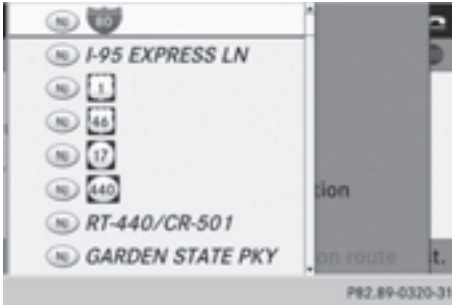

- ▶ **To switch to navigation mode:** press the **NAVI** button.
- ▶ **To show the menu:** press the COMAND controller.
- ▶ Select **Traffic** in the navigation system menu bar by turning the COMAND controller and press to confirm.
- ▶ Select **All Messages** and press to confirm.
A list is shown containing all roads, areas or regions affected by traffic reports. Roads, areas or regions not on the route also appear in the list.
- ▶ **To show a traffic report:** select a road, area or region and press to confirm.
The traffic report is displayed. There may be several traffic reports for the affected road. You can find an example of a traffic report here: (▷ page 358).
- ▶ **To close a report:** slide the COMAND controller.

Reading out traffic reports on the route

Introduction

The read-aloud function is only available while route guidance is active. It reads out traffic reports affecting the current route.

You can select the following text reader properties:

- Language (▷ page 308)
- Text reader speed (▷ page 308)

You can start the text reader function manually or set it to automatic.

Starting the text reader function manually

- ▶ **To switch to navigation mode:** press the **NAVI** button.
- ▶ **To show the menu:** press the COMAND controller.
- ▶ Select **Traffic** by turning the COMAND controller and press to confirm.
- ▶ Select **Read out all messages on route** and press to confirm.
COMAND reads out the reports in sequence.

i If there are no reports for the route, the **Read out all messages on route** menu item is shown in gray and cannot be selected.

- ▶ **To switch off the read-aloud function:** select **Cancel Read-Aloud Function** and press to confirm or press the button.
COMAND reads out the current report and then exits the read-aloud function.

Automatic read-aloud function

- ▶ **To switch to navigation mode:** press the **NAVI** button.
- ▶ **To show the menu:** press the COMAND controller.
- ▶ Select **Traffic** by sliding and turning the COMAND controller and press to confirm.
- ▶ Select **Read Traffic Messages Automatically** and press to confirm.
Depending on the previous state, switch the option on or off .

Recalculating the route dynamically

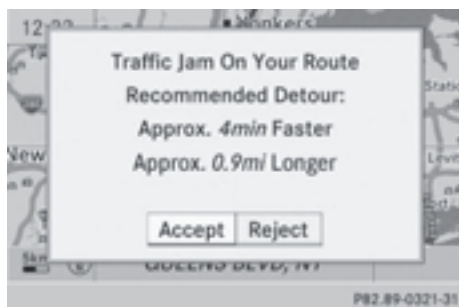

The route types [Dynamic Route](#) and [Dynamic Route Only After Request](#) take all relevant traffic messages into account when calculating a route (▷ page 320).

If you have selected [Dynamic Route](#) as the route type, COMAND guides you to your destination along the updated route.

If you have selected [Dynamic Route Only After Request](#) as the route type, a prompt will appear first.

You can now decide whether to:

- accept the route suggested by COMAND
 - continue your original route
- ▶ **To accept the suggested route:** press the COMAND controller.
- ▶ **To continue along the original route:** select [Reject](#) by turning the COMAND controller and press to confirm.

Destination memory

Home address (My Address)

Entering the home address via address entry

- ▶ Proceed as described under “Adopting an address book entry as a home address” (▷ page 360). Confirm [My Address](#) by pressing .
- ▶ **To enter the home address for the first time:** confirm [New Entry](#) by pressing .

- ▶ **To change the home address:** select [Change](#) in the menu showing the home address by turning the COMAND controller and press to confirm.
- ▶ Confirm [New Entry](#) by pressing .
- ▶ In both cases, enter the home address as a destination, e.g. as a city, street and house number (▷ page 323). Then, save the home address (▷ page 327).

Adopting an address book entry as a home address

- ▶ **To switch to navigation mode:** press the button.
- ▶ **To show the menu:** press the COMAND controller.
- ▶ Select [Destination](#) in the navigation system menu bar by turning the COMAND controller and press to confirm.
- ▶ Select [From Memory](#) and press to confirm.
- You will see the destination memory list either with the character bar (option 1) or as a selection list (option 2).

Option 1: destination memory list with character bar

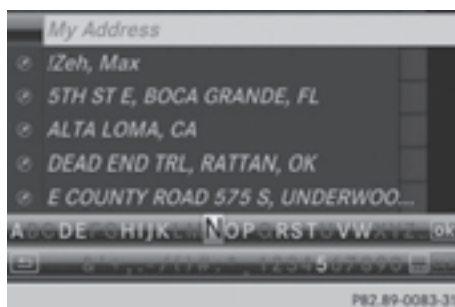

- ▶ Slide the COMAND controller repeatedly until the destination memory list appears as a selection list.

Option 2: destination memory list as selection list

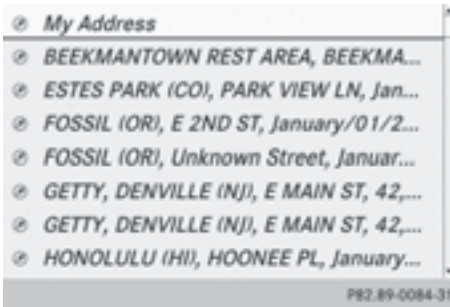

The **My Address** entry is listed as the first entry in the destination memory.

- ▶ Select **My Address** by turning **[OK]** the COMAND controller and press **[ENTER]** to confirm.

i If you have not yet entered any characters, **My Address** is automatically highlighted in the selection list.

If no home address has been stored yet, you can now assign an address book entry. If a home address already exists, it is displayed and you can alter it.

- i** If you select **New Entry**, you are also offered the option of entering the home address for the first time. You can then save the home address without having to start route guidance.
- ▶ **To enter the home address for the first time:** select **Assign to Address Book Entry** and press **[ENTER]** to confirm.
- ▶ Select **Home, Work** or **Not Classified** and press **[ENTER]** to confirm.
- ▶ **To change the home address:** select **Change** and press **[ENTER]** to confirm.
- ▶ Select **Assign to Address Book Entry** and press **[ENTER]** to confirm.
- i** If you select **New Entry**, you are also offered the option of changing the home address by entering an address. You can

then save the home address without having to start route guidance.

- ▶ Select **Home, Work** or **Not Classified** and press **[ENTER]** to confirm. In both cases, you will see the address book either with the character bar or as a selection list.

- ▶ Select an address book entry (▷ page 402).

- ▶ **To confirm the selection:** press **[ENTER]** the COMAND controller. If there is no existing home address, COMAND saves the entry. You will see a message and then the address menu with the selected address. **Start** is highlighted automatically.

If a home address has already been stored, you will see a prompt asking you whether the **My Address** entry should be overwritten.

- ▶ Select **Yes** or **No** and press **[ENTER]** to confirm. If you select **Yes**, COMAND overwrites the destination. You will see a message and then the address menu with the selected address. **Start** is highlighted automatically.

If you select **No**, the list will appear again.

Selecting the home address for route guidance

- ▶ Proceed as described under "Selecting a destination from the destination memory" (▷ page 328).

Save destination

General notes

This function also stores the destination in the address book.

When the address book is full, no destinations can be saved in the destination memory. You must first delete address book entries (▷ page 402).

After destination entry

- ▶ The destination has been entered and is shown in the address entry menu (▷ page 322).
- ▶ Select **Save** by sliding $\odot \downarrow$ and turning $\left[\odot \right]$ the COMAND controller and press \odot to confirm.
You can now select storing options (▷ page 362).

During route guidance

- ▶ **To show the menu:** press \odot the COMAND controller.
- ▶ Select **Destination** in the navigation system menu bar by turning $\left[\odot \right]$ the COMAND controller and press \odot to confirm.
- ▶ Select **Save Destination** and press \odot to confirm.
You can now select storing options (▷ page 362).

From the list of previous destinations

- ▶ **To show the menu:** press \odot the COMAND controller.
- ▶ Select **Destination** in the navigation system menu bar by turning $\left[\odot \right]$ the COMAND controller and press \odot to confirm.
- ▶ Select **From Last Destinations** and press \odot to confirm.
The list of last destinations appears.
- ▶ Select a destination by turning $\left[\odot \right]$ the COMAND controller and press \odot to confirm.
The destination address is shown.
- ▶ Select **Save** and press \odot to confirm.
You can now select storing options (▷ page 362).

Selecting storing options

Once you have chosen one of the following options for storing a destination, you can specify storage options:

- After destination entry (▷ page 362)
- During route guidance (▷ page 362)
- From the list of previous destinations (▷ page 328)

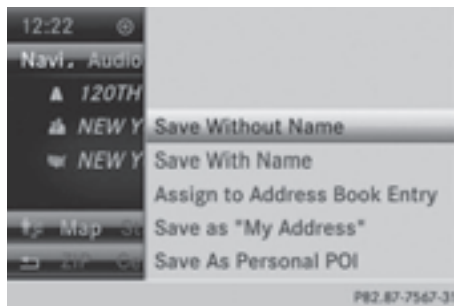

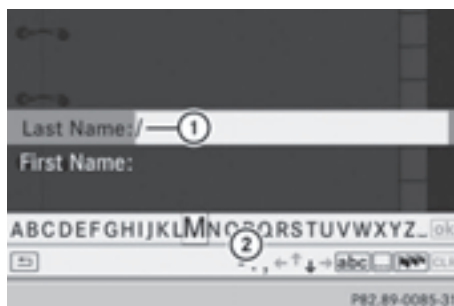

Storage options

- ▶ **To save the destination without a name:** select **Save Without Name** and press \odot to confirm.
COMAND stores the destination in the destination memory and uses the address as the destination name.







Example: saving a destination with a name



- ① Selected data field with cursor
- ② Character bar
- ▶ **To save the destination with a name:** select **Save With Name** and press \odot to confirm.

- ▶ Select a category, e.g. **Home**, and press  to confirm.
The input menu appears with data fields and the character bar.
- ▶ Proceed as described under "Character entry (navigation)" (▷ page 301).
- ▶ Then select  and press  to confirm.
COMAND stores the destination under the name entered.









An address with complete address data that is suitable for navigation can be assigned to a pre-existing address book entry.

- ▶ **To assign an address to an address book entry:** select **Assign to Address Book Entry** and press  to confirm.
- ▶ Select a category, e.g. **Home**, and press  to confirm.
You will see the address book either with the character bar or as a selection list.
- ▶ Select an address book entry (▷ page 402).
COMAND stores the data if the address book entry selected does not yet contain navigable address data.
If the selected address book entry already contains navigable address data, a prompt will appear asking whether you wish to overwrite the existing data.
- ▶ Select **Yes** or **No** and press  to confirm.
If you select **Yes**, COMAND stores the data.
You can now start route guidance to this address directly from the address book (▷ page 404).
- ▶ **To save the destination as My address:** select **Save as "My Address"** and press  to confirm.
COMAND stores the destination in the destination memory as **My Address**. If the selected address book entry already contains address data that can be used for navigation ( icon), a prompt will appear

asking whether you wish to overwrite the existing data.

- ▶ Select **Yes** or **No** and press  to confirm.
If you select **Yes**, the entry is overwritten. If you select **No**, the process will be canceled.
- ▶ **To save the destination as a personal POI:** insert the SD memory card (▷ page 445).
- ▶ Select **Save As Personal POI** and press  to confirm.
- ▶ Select a category.
- ▶ Enter the name.
The current address is saved as a personal point of interest on the SD memory card.

Deleting a destination or the home address

- ▶ **To switch to navigation mode:** press the  button.
- ▶ **To show the menu:** press  the COMAND controller.
- ▶ Select **Destination** in the navigation system menu bar by turning  the COMAND controller and press  to confirm.
- ▶ Select **From Memory** and press  to confirm.
You will see the destination memory list either with the character bar (option 1) or as a selection list (option 2).
- ▶ **Option 1: destination memory list with the character bar:** enter characters using the character bar (▷ page 301).
- ▶ **Option 2: destination memory list as selection list:** select a destination by turning  the COMAND controller and press  to confirm.
You see the address data of the selected entry.
- ▶ Select **Delete** and press  to confirm.
A prompt appears asking whether you wish to delete the destination.

- ▶ Select **Yes** or **No** and press  to confirm. If you select **Yes**, COMAND deletes the destination. You will see a message to this effect.

If you select **No**, the process will be canceled.

- i** If the navigable address data for the destination being deleted is also assigned to an address book entry, COMAND will also delete this data from there. If the corresponding address book entry does not contain any further data, such as telephone numbers, COMAND deletes the entire address book entry.

Previous destinations



Introduction



COMAND automatically stores the previous destinations for which route calculation has been started. If the memory is full, COMAND deletes the oldest destination. You can also save a destination from the list of previous destinations in the destination memory. It will be stored there permanently.

Storing a destination permanently in the destination memory

- ▶ Proceed as described in the "From the list of previous destinations" section (> page 328).





Storing the vehicle position in the list of previous destinations

- ▶ **To switch on navigation mode:** press the  function button.
- ▶ **To show the menu:** press  the COMAND controller.









- ▶ Select **Position** in the navigation system menu bar by turning  the COMAND controller and press  to confirm.
- ▶ Select **Save Vehicle Position** and press  to confirm. COMAND stores the current vehicle position as a destination in the list of previous destinations.

Storing the crosshair position in the list of previous destinations

A crosshair appears on the map if you have moved the map manually (> page 365). You can store the crosshair position as a destination in the list of previous destinations.

- ▶ **To show the menu:** press  the COMAND controller.
- ▶ Select **Position** in the navigation system menu bar by turning  the COMAND controller and press  to confirm.
- ▶ Select **Save Crosshair Position** and press  to confirm.

Deleting one of the previous destinations

- ▶ **To switch on navigation mode:** press the  function button.
- ▶ **To show the menu:** press  the COMAND controller.
- ▶ Select **Destination** in the navigation system menu bar by turning  the COMAND controller and press  to confirm.
- ▶ Select **From Last Destinations** and press  to confirm. The list of last destinations appears.
- ▶ Select the desired destination and press  to confirm. The destination address appears.
- ▶ Select **Delete** and press  to confirm. A prompt appears asking whether the entry should be deleted.
- ▶ Select **Yes** or **No** and press  to confirm. If you select **Yes**, the entry is deleted.

If you select **No**, the process will be canceled.

Map operation and map settings

General notes

Company logos displayed on the map are trademarks of the respective companies and used solely for the purpose of indicating the locations of these companies. The use of such logos on the map does not indicate approval of, support of or advertising by these companies for the navigation system itself.

Setting the map scale

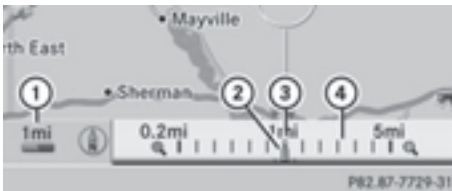

- ① Set map scale as a number with unit
- ② Currently set map scale as indicated by the needle on the scale bar
- ③ New map scale
- ④ Scale bar

Unit of measurement ① in the COMAND display depends on the selection made in the instrument cluster; see the separate vehicle Operator's Manual.

- ▶ **To hide the menu:** slide $\uparrow \odot$ the COMAND controller and, when the **Full Screen** menu item is shown, press \odot .
- ▶ **To call up the scale bar:** as soon as you turn \odot the COMAND controller, scale bar ③ appears.
- ▶ Turn \odot until the desired scale is set.

Moving the map

Showing the crosshair



Map with crosshair

- ① Current vehicle position
- ② Crosshair
- ③ Details of the crosshair position
- ④ Map scale selected

- ▶ **To hide the menu:** slide $\uparrow \odot$ the COMAND controller and, when the **Full Screen** menu item is shown, press \odot .

- ▶ **To scroll the weather map:** slide $\leftarrow \odot \rightarrow$, $\uparrow \odot \downarrow$ or $\odot \swarrow \nwarrow$ the COMAND controller. A crosshair appears on the map. If you slide it again, the map under the crosshair moves in the corresponding direction.

Display ③ may be the name of a street, for example, provided the digital map contains the necessary data. It shows the geo-coordinate position of the crosshair if the **Geo-coordinates** display is switched on (\triangleright page 368).



Hiding the crosshair and centering the map on the vehicle position or destination

- ▶ Press the \leftarrow back button twice. The crosshair disappears and the map is set to the vehicle position.

Centering the map on the vehicle's position





- ▶ **To show the menu:** press \odot the COMAND controller.
- ▶ Select **Position** in the navigation system menu bar by sliding $\odot \downarrow$ and turning \odot .

the COMAND controller and press  to confirm.

- ▶ Select **Vehicle Position Map** and press  to confirm or, if the crosshair is shown, press the  back button. This hides the crosshair.





Centering the map on the destination position

This function requires a calculated route to a destination. If the route includes way points and an intermediate stop, the map can also be set to these positions.

- ▶ **To show the menu:** press  the COMAND controller.
- ▶ Select **Position** in the navigation system menu bar by sliding  and turning  the COMAND controller and press  to confirm.
- ▶ Select **Destination Position Map** and press  to confirm. The crosshair position is set to the relevant destination.

Map settings

Calling up the map settings menu

- ▶ **To show the menu:** press  the COMAND controller.
- ▶ Select **Navi** in the main function bar by sliding  and turning  the COMAND controller and press  to confirm.
- ▶ Select **Map Settings** and press  to confirm. The map settings menu appears.





Map orientation



Example: map orientation

- ① Current map orientation ( or )



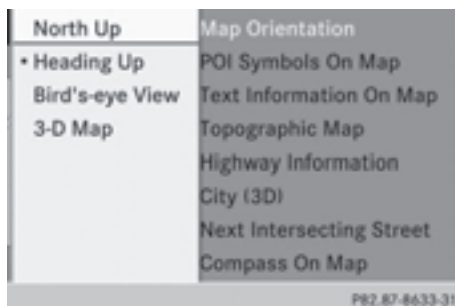

Possible map orientations:

-  North orientation (The map view is displayed so that north is always up)
-  Heading orientation (the map view is aligned to the direction of travel. The direction of travel is always at the top, the orange-color tip of the symbol points north.)
-  Bird's-eye view (the map view is aligned to the direction of travel. The map projection reproduces the curvature of the earth's surface, the orange-color tip of the symbol points north.)
-  3D map (the map view is aligned to the direction of travel. At a scale of 1 km the map displays elevation, the orange-color tip of the symbol points north.)



Map orientation menu

Setting the map orientation

- ▶ **To show the menu:** press  the COMAND controller.
- ▶ Select **Navi** in the main function bar by sliding  and turning  the COMAND controller and press  to confirm.

- ▶ Select **Map Settings** and press to confirm. The map settings menu appears.
- ▶ Select **Map Orientation** and press to confirm.
- ▶ Select **North up, Heading Up, Bird's-eye View** or **3-D Map** by turning the COMAND controller and press to confirm.
 - A ● dot indicates the new setting.

Selecting POI symbols

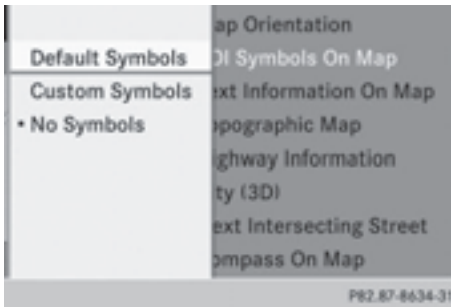

Setting the POI symbol display

You can set the points of interest you wish to have displayed as symbols on the map. Points of interest are, for example, gas stations, hotels, cinemas and restaurants.

- ▶ **To show the menu:** press the COMAND controller.
- ▶ Select **Navi** in the main function bar by sliding and turning the COMAND controller and press to confirm.
- ▶ Select **Map Settings** and press to confirm. The map settings menu appears.
- ▶ Select **POI Symbols On Map** and press to confirm.

The following settings are possible:

- **Standard Symbols**
Symbol display determined by the factory settings.
- **Personal Symbols**

You can determine the symbols yourself.

- **No Symbols**

The map does not show any symbols.

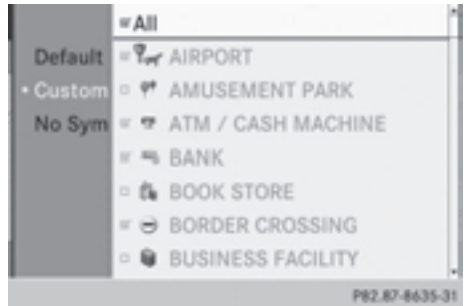









- ▶ Select **Standard Symbols**, **Personal Symbols** or **No Symbols**. If you select **Personal Symbols**, the POI list appears.
- ▶ **To switch the symbol display on/off:** select a POI by turning the COMAND controller and press to confirm. Depending on the previous state of the symbols, they will either be shown or hidden . You can switch on the symbol displays for more than one point of interest.
- ▶ **To switch all personal symbols on/off:** select **All** and press to confirm. Depending on the previous status of the symbols, they will either be shown or hidden .
 - If the function is switched on , the individual POIs are grayed out and the previously selected settings remain unchanged.
 - If the function is switched off , you can reselect the individual POIs. They show the most recently selected settings.
- ▶ **i** The list shows all symbols that are contained on the digital map across all countries. However, not all points of interest are available in all countries. As a result, certain point of interest symbols may not be displayed on the map, even if the symbol display is switched on.
- ▶ **To exit the menu:** press the **BACK** back button.

Selecting map information

Map information in the display

During route guidance, you can have map information shown at the bottom edge of the display.

- ▶ **To show the menu:** press  the COMAND controller.
- ▶ Select **Navi** in the main function bar by sliding  and turning  the COMAND controller and press  to confirm.
- ▶ Select **Map Settings** and press  to confirm.
The map settings menu appears.
- ▶ Select **Text Information On Map** and press  to confirm.
A ● dot indicates the current setting.
- ▶ Select **Current Street, Geo-coordinates** or **None** and press  to confirm.
- ▶ **To exit the menu:** slide  the COMAND controller.



Road display

- ① Road names or numbers, e.g. for highways



Geo-coordinate display

- ① Current height above average sea level (rounded to the nearest 10 m)
- ② Current vehicle position: latitude coordinates

- ③ Current vehicle position: longitude coordinates
- ④ Number of GPS satellites currently being used

There must be sufficient GPS reception for all displays to be shown. If this is not the case, the display will be grayed out. Height display ① may vary from the actual value, because the navigation system uses the GPS signals for the calculation.

During the "Move map" function, you will see the geo-coordinates of the crosshair position. Height display ① and number of satellites used ④ are not displayed.









Display switched off

- ① Current map orientation

While moving the map, you will see additional data, depending on the crosshair position, if the digital map supports this data. A street name, for example, can be shown here ([▷ page 365](#)).







Coordinates on the map

- ▶ **To show the menu:** press  the COMAND controller.
- ▶ Select **Navi** in the main function bar by sliding  and turning  the COMAND controller and press  to confirm.
- ▶ Select **Map Settings** and press  to confirm.
The map settings menu appears.
- ▶ Select **Compass On Map** and press  to confirm.
A menu appears.

- ▶ Select **Never**, **When Off-Road** or **When Route Guidance Inactive** and press  to confirm.

The selected setting is accepted.

Switching additional information on/off Switching the topographic map on/off

- ▶ **To show the menu:** press  the COMAND controller.
- ▶ Select **Navi** in the main function bar by sliding  and turning  the COMAND controller and press  to confirm.
- ▶ Select **Map Settings** and press  to confirm.
The map settings menu appears.
- ▶ Select **Topographic Map** and press  to confirm.
Depending on the previous status, switch the option on or off .

The topographical map uses different colors to depict elevation. The color key generally reflects the topography's dominant vegetation or the ground's perceived color when seen from the air, for example:

- green (grass) for lowland
- yellow, brown (woodland) for hills
- gray (stone) and white (snow) for mountains









Example: highway information

Switching highway information on/off

When driving on the highway, you can see the following information on the right of the display:

- the nearest gas stations
- the nearest rest areas, etc.
- and their distance from the current vehicle position

The entries show the number of the highway and the highway exits as well as their distance from the current vehicle position. The name of the highway exit continues to be displayed.

- ▶ **To switch to navigation mode:** press the **NAVI** button.
- ▶ **To show the menu:** press  the COMAND controller.
- ▶ Select **Navi** in the main function bar by sliding  and turning  the COMAND controller and press  to confirm.
- ▶ Select **Map Settings** and press  to confirm.
The map settings menu appears.
- ▶ Select **Highway Information** and press  to confirm.
Depending on the previous status, switch the option on or off .







Example: city model

Switching city view on/off

When the city model is switched on, the map shows buildings in 3D.

- ▶ **To show the menu:** press  the COMAND controller.

- ▶ Select **Navi** in the main function bar by sliding  and turning  the COMAND controller and press  to confirm.
- ▶ Select **Map Settings** and press  to confirm.
The map settings menu appears.
- ▶ Select **City (3D)** and press  to confirm.
Depending on the previous status, switch the option on or off .

i The city model is only shown for "Bird's-eye View" or "3D Map".

It is available in the 0.05 mi and 0.1 mi map scales.

The data required for displaying buildings is not available for all cities.







Example: intersecting roads on city routes/highways

Showing/hiding intersecting streets

If route guidance is inactive, intersecting streets can be shown on the upper edge of the display.

- ▶ **To show the menu:** press  the COMAND controller.





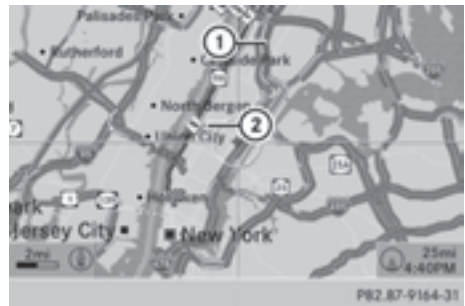

- ▶ Select **Navi** in the main function bar by sliding  and turning  the COMAND controller and press  to confirm.
- ▶ Select **Map Settings** and press  to confirm.
The map settings menu appears.
- ▶ Select **Next Intersecting Street** and press  to confirm.
Depending on the previous status, switch the option on or off .

Traffic information on the map



- ① Delimits the section of the route affected
- ② Indicates an incident on the route (traffic flow)

If you subscribe to the SIRIUS XM Satellite Radio Traffic Message Service, traffic information can be displayed on the map. You can select three categories for the display.

- ▶ **To switch the display on/off:** press  the COMAND controller to show the menu.
- ▶ Select **Navi** in the main function bar by sliding  and turning  the COMAND controller and press  to confirm.
- ▶ Select **Traffic Information On Map** and press  to confirm.
- ▶ Select **Incidents** and/or **Speed & Flow** and/or **Free Flow** and press  to confirm.
Depending on the previous status, switch the option on or off .

Traffic information	Display on the map
Incidents	Road sections with traffic incidents are illustrated with a yellow line and arrows.
Speed & Flow	Road sections with traffic jams are represented by yellow or red lines. Yellow lines: traffic jams, average speed 25 - 45 mph (40 - 72 km/h) Red lines: traffic jams, average speed 5 - 20 mph (8 - 32 km/h)
Free Flow	Free flowing road sections are illustrated with a green line and arrows.

Additional settings

Avoiding an area

General information

COMAND enables you to avoid areas you do not wish to drive through.

If you activate or deactivate a route block while route guidance is active, COMAND will calculate a new route. If you activate or deactivate a route block while route guidance is inactive, COMAND will use the new setting for the next route guidance.

The calculated route may include an area to be avoided if:

- your destination is located in such an area.
- the route uses roads that lead through an area to be avoided.

i Highways within blocked areas are always taken into consideration in the route calculation.

Defining an area for the first time

► **To switch to navigation mode:** press the **NAVI** button.

► **To show the menu:** press **COMAND** the COMAND controller.

► Select **Navi** in the main function bar by sliding **NAV** and turning **COMAND** the COMAND controller and press **COMAND** to confirm.

► Select **Avoid Area** and press **COMAND** to confirm.

If you have not previously blocked an area, a menu appears.

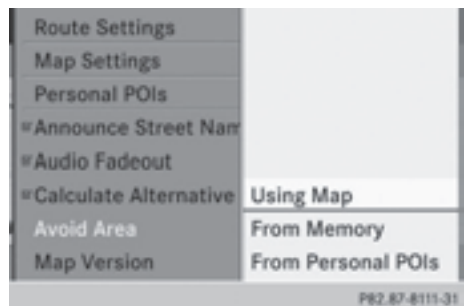

► Select **Using Map**, **From Memory** or **From Personal POIs** and press **COMAND** to confirm. If you select **Using Map**, the map with the crosshair appears.

If you select **From Memory** or **From Personal POIs**, either the destination memory or the list of categories for POIs appears.



- Destination memory (▷ page 328)
- List of categories for personal POIs (▷ page 342)

► Select the desired destination or personal POI and press **COMAND** to confirm.



► When the destination address is displayed, select **Continue** and press **COMAND** to confirm. The map appears.

The crosshair marks the center of the area that is to be avoided.

► **To scroll the weather map:** slide **NAV**, **NAV** or **COMAND** the COMAND controller.







- ▶ **To set the map scale:** as soon as you turn  the COMAND controller, the scale bar appears. Turning clockwise zooms out from the map; turning counter-clockwise zooms in.
- ▶ Turn  until the desired scale is set.
- ▶ **To apply a block:** press  the COMAND controller.
A red square appears on the map.



- ▶ **To adjust the size of the square:** turn  the COMAND controller.
The square is enlarged or reduced.
 - ▶ **To confirm the settings:** press .
- The list appears. The previously selected area to be avoided has been added and activated.



You can also determine additional areas to be avoided (▷ page 372).

Defining further areas



- ▶ **To switch to navigation mode:** press the  button.
- ▶ **To show the menu:** press  the COMAND controller.
- ▶ Select **Navi** in the main function bar by sliding  and turning  the COMAND controller and press  to confirm.
- ▶ Select **Avoid Area** and press  to confirm.
If you have already selected one or more areas to avoid, a list of areas appears.

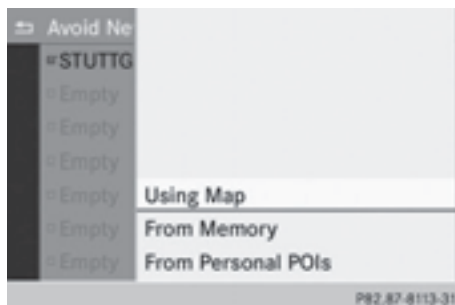

Example: list of areas

- ▶  Available positions in the list are named **Empty** and are shown in grey.
- ▶ Select **Avoid New Area** by turning  the COMAND controller and press  to confirm.
A menu appears.



- ▶ Select **Using Map**, **From Memory** or **From Personal POIs** and press  to confirm.
If you select **Using Map**, the map with the crosshair appears.
If you select **From Memory** or **From Personal POIs**, either the destination memory or the list of categories for POIs appears.
 - Destination memory (▷ page 328)
 - List of categories for personal POIs (▷ page 342)
- ▶ Select the desired destination or personal POI and press .
- ▶ When the destination address is displayed, select **Continue** and press  to confirm.
The map appears.

- ▶ **To avoid a new area:** call up the area menu again (▷ page 371).

Switching an avoided area on/off

- ▶ Call up the area list (▷ page 372).
- ▶ Select an entry in the list by turning **Ⓜ** the COMAND controller and press **Ⓜ** to confirm.
The avoided area is switched on or off depending on the previous status.

Displaying and changing an avoided area

- ▶ Call up the area list (▷ page 372).
- ▶ Select an entry in the list by turning **Ⓜ** the COMAND controller.
- ▶ Slide **Ⓜ** the COMAND controller and press **Ⓜ** to confirm.
- ▶ Select **Display / Change** and press **Ⓜ** to confirm.
The area to be avoided is indicated in the map.
- ▶ **To change the location of the area:** slide **Ⓜ**, **Ⓜ** or **Ⓜ** the COMAND controller.
The area is moved on the map.
- ▶ **To adjust the size of the area:** turn **Ⓜ** the COMAND controller.
The area is enlarged or reduced.
- ▶ **To confirm the change:** press **Ⓜ** the COMAND controller.
The list appears and the change is entered.

Deleting a set area

- ▶ Call up the area list (▷ page 372).
- ▶ Select an entry in the list by turning **Ⓜ** the COMAND controller.
- ▶ Slide **Ⓜ** the COMAND controller and press **Ⓜ** to confirm.
- ▶ Select **Delete** and press **Ⓜ** to confirm.
A query appears asking whether the entry should be deleted.
- ▶ Select **Yes** or **No**.
If you select **Yes**, the entry is deleted.

If you select **No**, the process will be canceled.

SIRIUS XM service

Displaying SIRIUS XM service information

You can display the SIRIUS XM service information.

- ▶ **To show the menu:** press **Ⓜ** the COMAND controller.
- ▶ Select **Navi** in the main function bar by sliding **Ⓜ** and turning **Ⓜ** the COMAND controller and press **Ⓜ** to confirm.
- ▶ Select **SIRIUS Service** and press **Ⓜ** to confirm.
The window on the right half of the display shows the telephone number of the provider (SIRIUS XM) and the serial number of your service module.

Registering for the SIRIUS XM traffic report service

- ▶ Call the traffic report provider's phone number shown on the screen.
- i** You can also have the satellite service activated online. To do so, visit the SIRIUS XM Radio website at **<http://www.sirius.com>** (USA).

Once the connection has been established:

- ▶ Follow the instructions of the operator.
The activation process may take up to ten minutes.

If registration is not included when purchasing the system, your credit card details will be required to activate your account.

Compass function

You can view the current direction of travel, the current height and the coordinates of the current vehicle position in the compass view.

- ▶ **To switch to navigation mode:** press the **NAVI** button.

- ▶ **To show the menu:** press the COMAND controller.
- ▶ Select **Position** in the navigation system menu bar by sliding and turning the COMAND controller and press to confirm.
- ▶ Select **Compass** and press to confirm.



Example: compass

- ① Current direction of travel
 - ② Current height above average sea level (rounded)
 - ③ Current vehicle position: longitude coordinates
 - ④ Number of GPS satellites currently being used
 - ⑤ Current vehicle position: latitude coordinates
 - ⑥ Currently set steering angle of the front wheels
- i** To display current elevation ②, the system must be able to receive at least four satellites. Steering angle ⑥ can be a maximum of 35° in both directions.
- ▶ **To exit the display:** confirm **Back** by pressing or press the back button.

Country-specific information

You can call up information on the traffic conditions in the country you are currently driving in via the COMAND Internet and online function.

The availability of information is country-dependent. Information can include maxi-

mum speeds, driving with low-beam headlamps or legal alcohol limits, for example.

- ▶ **To switch to navigation mode:** press the button.
- ▶ **To show the menu:** press the COMAND controller.
- ▶ Select **Position** in the navigation system menu bar by sliding and turning the COMAND controller and press to confirm.
- ▶ Select **Country Information** and press to confirm.
When the connection has been made, the available country information appears.
- ▶ **To return to navigation:** press the button.

Displaying the map data version



- ▶ **To show the map data menu:** press the COMAND controller.
- ▶ Select **Navi** in the main function bar by sliding and turning the COMAND controller and press to confirm.
- ▶ Select **Map Version** and press to confirm.

The number of the map data version is shown. Information about new versions of the digital map can be obtained from an authorized Mercedes-Benz Center.

Updating the digital map

Important safety notes

WARNING

Combustion engines emit poisonous exhaust gases such as carbon monoxide. Inhaling these exhaust gases leads to poisoning. There is a risk of fatal injury. Therefore never leave the engine running in enclosed spaces without sufficient ventilation.

Introduction

The digital maps generated by the map software become outdated in the same way as conventional road maps. Optimal route guidance can only be provided by the navigation system in conjunction with the most up-to-date map software.

Information about new versions of the digital map can be obtained from an authorized Mercedes-Benz Center. You can have the digital map updated there with a DVD, or you can update it yourself.

Carrying out a manual update

i The update process can take a long time (over an hour), depending on the size of the digital map. During this time, you will only be able to switch on radio mode and to accept incoming calls. The update will be completed more quickly if the vehicle is stationary.

If you start the update with the engine switched off and the starter battery has insufficient power, COMAND may automatically switch off. This protects the battery. If this occurs, restart the update with the engine running.

- ▶ Insert the DVD (▷ page 445).

COMAND checks whether the digital map on the DVD is compatible with the navigation system and system software.

A prompt then appears asking if you want to install the database. Versions of the

database currently installed and the database that is to be installed are displayed.

- ▶ Select **Yes** or **No** and press  to confirm. After selecting **Yes**, an activation code must be entered when installing a database for the first time. You will receive the activation code when you buy the navigation DVD.

If you select **No**, the process will be canceled.

- ▶ Enter the activation code. After entering the activation code correctly, COMAND starts updating the digital map. Once the update is finished, you will see a message.

- ▶ **To confirm the message:** press  the COMAND controller.

- ▶ Take the DVD out of the slot. While the update is running, you will see a message to this effect and a progress bar. The navigation system is not operational until the update is complete.

i You cannot eject the DVD during the update. If you switch off COMAND during the update, the update is interrupted. It then continues from where it was interrupted when the system is restarted.

COMAND may prompt you to change the DVD during the update.

- ▶ Press the  load/eject button.

- ▶ Take the DVD out of the slot.

- ▶ Insert the requested DVD. Once the update has been successfully completed, you will see a message to this effect.

- ▶ **To confirm the message:** press  the COMAND controller.

- ▶ Take the DVD out of the slot. The update is complete.

If the update is not successfully completed, you will see a message that the map update is not possible.

- ▶ **To confirm the message:** press  the COMAND controller.
- ▶ Take the DVD out of the slot.

Problems with the navigation system

Problem	Possible causes/consequences and ► Solutions
COMAND is unable to continue route guidance after the journey has been interrupted.	<p>Route guidance is canceled if you interrupt the journey for more than two hours.</p> <p>"Interrupting the journey" refers to stopping the vehicle.</p> <p>"Continuing route guidance" refers to switching COMAND back on and driving on.</p> <p>► Continue route guidance (► page 349).</p>

Problem	Possible causes/consequences and ► Solutions
COMAND is unable to determine the vehicle's position.	<p>COMAND has to redetermine the position of the vehicle if the vehicle has been transported.</p> <p>Example:</p> <ul style="list-style-type: none"> • After transporting the vehicle by ferry • After transporting the vehicle by motorail • After the vehicle has been towed <p>► Start the vehicle and pull away.</p> <p>COMAND determines the vehicle's position. Depending on the driving situation, this may take some time.</p> <p>Route guidance may be restricted during the determination of the vehicle's position.</p> <p>When positioning is complete, route guidance is resumed with navigation announcements and route guidance displays.</p>

Problem	Possible causes/consequences and ► Solutions
The Navigation Unavailable message appears.	<p>COMAND has an integrated hard drive on which the digital map is stored.</p> <p>To protect the integrated hard drive against damage, COMAND deactivates it at very high and low temperatures. The navigation system will then be temporarily unavailable.</p> <ul style="list-style-type: none"> ► Let the vehicle and COMAND cool down. ► To hide the message: switch COMAND off and then on again. <p>If an area of the hard disk has a malfunction, COMAND can no longer access the map data in this area. This may occur when calculating a route, for example.</p> <ul style="list-style-type: none"> ► To hide the message: switch COMAND off and then on again. The navigation system will be operational again until it has to access the faulty area of the hard drive once more. The message will then reappear. ► Consult an authorized Mercedes-Benz Center.

Problem	Possible causes/consequences and ► Solutions
You see a message informing you that the DVD containing the digital map is incompatible with the system software.	<p>The DVD containing the digital map cannot be used for the update.</p> <ul style="list-style-type: none"> ► To confirm the message: press  the COMAND controller. ► Eject the DVD. ► Have the system database checked at an authorized Mercedes-Benz Center.

Problem	Possible causes/consequences and ► Solutions
The map software update has failed.	<p>The DVD is dirty.</p> <ul style="list-style-type: none"> ► Clean the DVD. ► Restart the update. <p>The DVD is scratched.</p> <ul style="list-style-type: none"> ► Consult an authorized Mercedes-Benz Center. <p>There is overheating due to excessive temperatures in the vehicle interior.</p> <ul style="list-style-type: none"> ► Wait until the vehicle interior has cooled down. ► Restart the update. <p>COMAND's integrated hard disk is defective.</p> <ul style="list-style-type: none"> ► Consult an authorized Mercedes-Benz Center.

Problem	Possible causes/consequences and ► Solutions
COMAND asks for an activation code during the map update.	<p>The digital map is secured with an activation code.</p> <p>► Consult an authorized Mercedes-Benz Center.</p>

Telephone

Your COMAND equipment

These operating instructions describe all the standard and optional equipment for your COMAND system, as available at the time of going to print. Country-specific differences are possible. Please note that your COMAND system may not be equipped with all the features described.

General notes

Important safety notes



WARNING

If you operate mobile communication equipment while driving, you will be distracted from traffic conditions. You could also lose control of the vehicle. There is a risk of an accident. Only operate this equipment when the vehicle is stationary.

If you make a call on your mobile phone while driving, always use hands-free mode. Only use the mobile phone when road, weather and traffic conditions permit. Some jurisdictions prohibit the driver from using a mobile phone while driving a vehicle.

Bear in mind that at a speed of only 30 mph (approximately 50 km/h), the vehicle covers a distance of 44 feet (approximately 14 m) per second.

Excessive levels of electromagnetic radiation may cause damage to your health and the health of others.

There is scientific discussion surrounding the possible health risks posed by electromag-

netic fields. You can reduce this risk by using an exterior antenna.

Therefore, only use mobile communication equipment if it is connected to the exterior antenna of the vehicle.

Introduction

COMAND provides telephony via the Bluetooth® interface.

When connecting Bluetooth®-capable mobile phones with PBAP (Phone Book Access Profile), the contacts are automatically downloaded to COMAND.

With a suitable mobile phone, you can use the hands-free system and receive vCards via the Bluetooth® interface.

You can use the text message function (receiving and reading) if the mobile phone supports the MAP (Message Access Profile) Bluetooth® profile.

You can obtain more detailed information about suitable mobile phones and about connecting Bluetooth®-capable mobile phones to COMAND on the Internet at

<http://www.mbusa-mobile.com>. Or call the Mercedes-Benz Customer Assistance center at 1-800-FOR-MERCEdes(1-800-367-6372) for the USA or at 1-800-387-0100 for Canada.







Call disconnection while the vehicle is in motion

A call may be disconnected if:

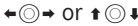
- there is insufficient network coverage in certain areas.
- you move from one transmitter/receiver area (cell) into another and no channels are free.
- you use a SIM card which is not compatible with the network available.

Operating options

You can operate the telephone by:

- using the COMAND controller:
 - turn 
 - slide  or 
 - press 
- using the  or  button and using the telephone keypad on COMAND
- using the  or  button on the multifunction steering wheel
- using the Voice Control System (see the separate Voice Control System operating instructions)

Unless stated otherwise, the descriptions and illustrations in this section refer to COMAND.

Function restrictions

The telephone is not ready for use in the following situations:

- The telephone automatically tries to log on to a network. If no network is available, you may not be able to make a "911" emergency call. If you attempt to make an outgoing call, the **No Service** message will appear for a short while.

"911" emergency call

The 911 emergency call is a public service. Using it without due cause is a criminal offense.

The following requirements must be fulfilled for a **911** emergency call:

- the mobile phone must be switched on.
- a network must be available.
- a valid and operational SIM card must be inserted in the mobile phone.
- the mobile phone is connected to COMAND via Bluetooth®.

If you cannot make an emergency call, you must arrange rescue measures yourself.

- ▶ Enter the number on COMAND (▷ page 387).
- ▶ Press . The telephone makes the connection.
- ▶ Wait until the emergency call center answers and describe the emergency situation.

Telephony via the Bluetooth® interface

Prerequisites

For telephony via COMAND's Bluetooth® interface, a Bluetooth®-capable mobile phone is required.

On COMAND

- ▶ Activate the Bluetooth® function in COMAND (▷ page 308).

On the mobile phone

- ▶ Switch on the mobile phone and enter the PIN when prompted to do so (see the mobile phone operating instructions).
- ▶ Activate Bluetooth® functions and, where necessary, Bluetooth® visibility on the mobile phone (see the mobile phone operating instructions).

The battery of the mobile phone should always be kept sufficiently charged in order to prevent malfunctions.

In preparation for telephoning via the Bluetooth® interface, you should check the following items on your mobile phone (see the mobile phone operating instructions):

- Hands-Free Profile

The mobile phone must support Hands-Free Profile 1.0 or above.

- Bluetooth® visibility

On certain mobile phones, the device itself must be made "visible" to other devices, as well as activating the Bluetooth® function (see the mobile phone operating instructions).

This visibility is for restricted periods of time on some mobile phones.

- Bluetooth® device name

Every Bluetooth® device has its own Bluetooth® device name. This device name is freely definable, but can be identical for all devices from the same manufacturer. It is therefore recommended that you change this name so that you can easily recognize your mobile phone (see the mobile phone operating instructions).

i Not all mobile phones available on the market are equally suitable. You can obtain more detailed information about suitable mobile phones and about connecting Bluetooth®-capable mobile phones to COMAND on the Internet at <http://www.mbusa-mobile.com>. Or call the Mercedes-Benz Customer Assistance Center at 1-800-FOR-MERCEdes (1-800-367-6372) (for the USA) or Customer Relations at 1-800-387-0100 (for Canada).

i Some displays (e.g. the signal strength) depend on the supported version of the Hands-Free Profile.

Connecting a mobile phone

General information

Before using your mobile phone with COMAND for the first time, you will need to:

- search for it (▷ page 382) and then
- authorize (register) it (▷ page 383).

When you authorize a new mobile phone, it is connected automatically.

You can authorize up to 15 mobile phones.

If the mobile phone supports PBAP (**Phone Book Access Profile**) and MAP (**Message Access Profile**), the following contacts and messages are downloaded into COMAND when connecting:

- phone book
- call lists
- text messages

Further information on the conditions for connecting (▷ page 380).

Searching for a mobile phone



Empty Bluetooth® telephone list

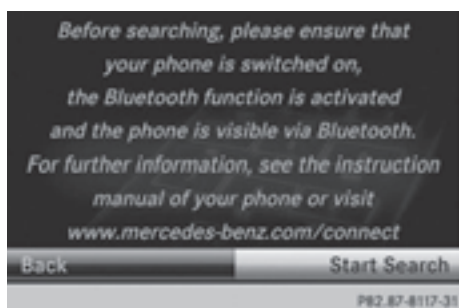

Conditions for searching



Bluetooth® telephone list after search is completed

- ▶ Press the **TEL** function button on COMAND.
- ▶ Select **Connect Dev.** from the telephone basic menu by sliding **⊙ ↓** and turning **⊗ ⊙ ⊗** the COMAND controller and press **⊗** to confirm.

- ▶ Select **Search for Phone from Vehicle** and press the **⊗** button to confirm. A message appears.

- ▶ Select **Start Search** and press the **⊗** button to confirm.





The Searching for Bluetooth Phones... message appears.

COMAND looks for Bluetooth® telephones within range and adds them to the Bluetooth® telephones list.

If a new phone is found, it appears in the list with the  symbol.

The duration of the search depends on the number of Bluetooth® telephones within range and their characteristics.

Symbols in the Bluetooth® phone list

Sym- bol	Explanation
	New mobile phone in range, but not yet authorized
	Authorized mobile phone
	Currently connected mobile phone
	Mobile phone in range and authorized
 (gray)	Mobile phone not in range, but already authorized

The Bluetooth® telephone list shows all mobile phones within range and all previously authorized mobile phones, whether or not they are in range.

- i** If the Bluetooth® telephones list is already full, you will be requested to de-authorize a mobile phone (▶ page 385). If COMAND does not find your mobile phone, external authorization may be necessary (▶ page 384).

- i** If you call up the telephone list again, the unauthorized devices are removed from the

list. In this case, start a new search to update the Bluetooth® telephone list.

Authorizing (registering) a mobile phone





Passkey entry



Telephone basic menu

Option 1: using the passkey (access code)

- ▶ Select the mobile phone using the  symbol in the Bluetooth® telephone list by turning  the COMAND controller and press  to confirm.

The input menu for the passkey appears.



The passkey is any one to sixteen-digit number combination which you can choose yourself. You must enter the same number combination in COMAND and in the Bluetooth®-capable mobile phone (see the mobile phone operating instructions).

- i** Some mobile phones require a passkey with four or more digits.
- i** If you want to reauthorize a mobile phone following deauthorization, you can select a different passkey.

- i** Mercedes-Benz recommends de-authorization in COMAND and on the mobile phone (▷ page 385). Subsequent authorization may otherwise fail.

- ▶ **To enter the passkey in COMAND:** press the number keys one after the other.

or

- ▶ Select the digits in the digit bar one by one by turning  the COMAND controller and press  to confirm.

 is highlighted after the first number has been entered.

- ▶ In both cases, select  and press  to confirm.

- ▶ **To enter the passkey on the mobile phone:** if the Bluetooth® connection is successful, you will be requested to enter the passkey (access code, passcode; see the mobile phone operating instructions).

- ▶ Enter the same passkey in the mobile phone as the one already entered in COMAND.

The **Connecting Bluetooth Profiles...** message appears.

The **Authorization successful** message appears once authorization is completed.

The mobile phone is connected to COMAND (authorized). You can now make phone calls using the COMAND hands-free system.

- i** After entering the passkey, you may also need to enter a confirmation in your mobile phone to connect calls. Please check your mobile phone display. On some mobile phones, this confirmation can be saved. In this case, you do not need to enter it again. If the COMAND display shows the **Authorization failed** message, you may have exceeded the prescribed time period. Repeat the procedure.

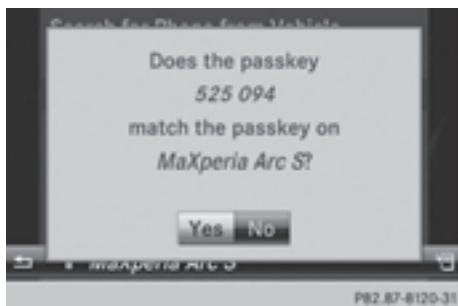

Option 2: use Secure Simple Pairing

The mobile phone (or the Bluetooth® audio device) must support the Bluetooth® version 2.1 for connection via Secure Simple Pairing. COMAND creates a six-digit code, which is displayed on both devices that are to be connected.

- ▶ If the code is the same on both devices, confirm **Yes** by pressing . If you select **Yes**, authorization is continued and the mobile phone is connected. If you select **No**, the process will be canceled.
- ▶ Confirm the message on the mobile phone.



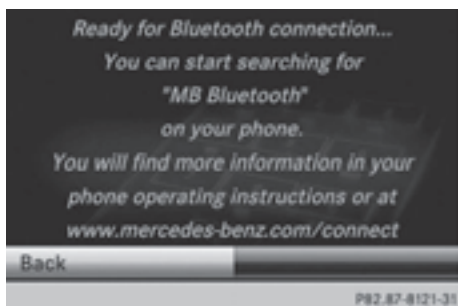

External authorization



If COMAND does not detect your mobile phone, this may be due to particular security settings on your mobile phone. In this case, you can test if your mobile phone can find COMAND. The Bluetooth® device name of COMAND is "**MB Bluetooth**".

Please note the following: some mobile phones require that you establish the con-

nection to COMAND again once you have entered the passkey (see the mobile phone operating instructions). The mobile phone cannot otherwise be authorized.

- ▶ Press the **TEL** function button on COMAND.
- ▶ Select **Connect Dev.** from the telephone basic menu by sliding  and turning  the COMAND controller and press  to confirm. The Bluetooth® telephone list appears.
- ▶ Select **Connect via Phone** and press  to confirm. The message on the left appears.
- ▶ Start the Bluetooth® search on the mobile phone; see the mobile phone operating instructions.
- ▶ Select COMAND (**MB Bluetooth**) on the mobile phone.
- ▶ **Option 1:** when requested to do so, enter the passkey first on the mobile phone and then in COMAND.
- ▶ **Option 2:** confirm the displayed codes on the mobile phone and in COMAND (Secure Simple Pairing).

With both options, you see the prompt **Do you want <device name> to be authorized?** on the COMAND display.

- ▶ If you select **Yes**, the mobile phone will be authorized. The messages **Waiting for a Connection to <name of B-tooth dev.>...** and **Connecting Bluetooth Profiles...** are displayed. If the connection is successful, you see the telephone basic menu and the connected mobile phone is entered. If you select **No**, the process will be canceled.

Switching between mobile phones

If you have authorized more than one mobile phone, you can switch between the individual phones.

- ▶ Select the mobile phone in the Bluetooth® telephone list by turning  the

COMAND controller and press  to confirm.







The selected mobile phone is searched for and connected if it is within Bluetooth® range and if Bluetooth® is activated.

Only one mobile phone can be connected at any one time. The currently connected mobile phone is indicated by the • dot in the Bluetooth® telephones list.

- i** You can only switch to another authorized mobile phone if you are not currently making a call.









De-authorizing (de-registering) a mobile phone

Mercedes-Benz USA, LLC recommends de-authorization in COMAND and on the mobile phone. Subsequent authorization may otherwise fail.

- ▶ Press the  function button on COMAND.
- ▶ Select **Connect Dev.** from the telephone basic menu by sliding  and turning  the COMAND controller and press  to confirm.
The Bluetooth® telephone list appears (▷ page 382).
- ▶ Select the desired mobile phone in the Bluetooth® telephones list.
- ▶ Select the list symbol to the right of the entry by sliding  the COMAND controller and press  to confirm.
- ▶ Select **Delete** and press  to confirm. A prompt appears asking whether you really wish to de-authorize this device.
- ▶ Select **Yes** or **No**.
If you select **Yes**, the device will be deleted from the Bluetooth® telephones list.
If you select **No**, the process will be canceled.

- i** Before re-authorizing the mobile phone, you should also delete the device name **MB Bluetooth** from your mobile phone's Bluetooth® list.

Displaying connection details



- ▶ Press the  function button on COMAND.
- ▶ Select **Connect Dev.** from the telephone basic menu by sliding  and turning  the COMAND controller and press  to confirm.
The Bluetooth® telephone list appears.
- ▶ Select the desired mobile phone in the Bluetooth® telephones list.
- ▶ Select the list symbol to the right of the entry by sliding  the COMAND controller and press  to confirm.
- ▶ Select **Details** and press  to confirm. The following information concerning the selected mobile phone is shown:
 - Bluetooth® name
 - Bluetooth® address
 - availability status (shown after a new search)
 - authorization status
- ▶ **To close the detailed view:** turn  or slide  the COMAND controller.

Telephone basic menu (Bluetooth® interface)

Basic menu display



Telephone basic menu (Bluetooth® interface)

- ① Telephone status
- ② Signal strength of mobile phone network 
- ③ Receiver icon  or 

- ④ To display call lists
- ⑤ Character bar
- ⑥ Bluetooth® name of the currently connected mobile phone
- ⑦ To display the COMAND phone book



▶ Press the **TEL** function button.

When the connected mobile phone is ready for use, the telephone basic menu appears.

i Display ② may vary, depending on the mobile phone connected.



Bars ② show the current signal strength of the mobile phone network. If all bars are filled, you have optimum reception.

If no bars are shown, reception is either very poor or there is none at all.

Receiver icon shows whether a call is active/being connected  or not .

Text message display in the telephone basic menu

The **Text Message** menu item is only available if the Bluetooth® phone supports the MAP Bluetooth® profile (**M**essage **A**ccess **P**rofile). The downloading of text messages from the Bluetooth® phone must have been completed. The menu item is otherwise grayed out. Further information on text messages (> page 398).









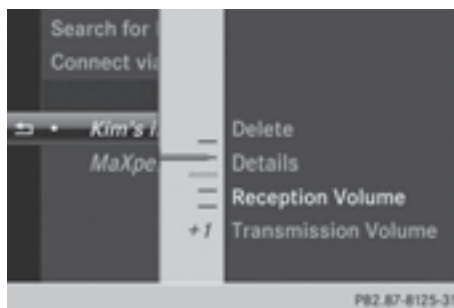

If you have an unread text message, the  mail symbol is displayed. The symbol disappears once you have read the text message. The  mail symbol is displayed as soon as the text message memory is full. The symbol disappears once you delete at least one text message.

Reception and transmission volume

Once the mobile phone has been authorized, you can optimize the transmission and reception volume settings. Find out more about the optimum settings for your mobile phone online at <http://www.mbusa-mobile.com>. Or call the Mercedes-Benz Customer Assistance center at 1-800-FOR-MERCEdes

(1-800-367-6372) (USA) or Customer Relations at 1-800-387-0100 (Canada).



- ▶ Press the **TEL** function button.
- ▶ Select **Connect Dev.** in the telephone basic menu by sliding  and turning  the COMAND controller and press  to confirm.
- ▶ Select an authorized mobile phone from the list by turning .
- ▶ Select the list symbol to the right of the entry by sliding  the COMAND controller and press  to confirm.
- ▶ Select **Reception Volume** or **Transmission Volume** and press .
- ▶ Select a volume setting by turning  the COMAND controller.
- ▶ **To close the setting scale:** press  or slide .

i Incorrect settings may have an impact on the quality of calls.

Using the telephone

Incoming call

Accepting a call

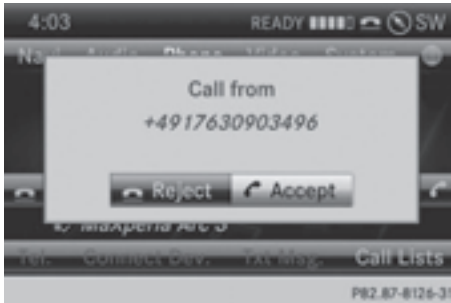

Example: incoming call

- ▶ **To accept:** confirm **Accept** by pressing .

or

- ▶ Press the  button on COMAND or on the multifunction steering wheel.

i You can also accept the call by voice command using the Voice Control System (see the separate operating instructions).

Once you have accepted the call, you can use hands-free mode.

The call volume can be adjusted (▷ page 296).

Other functions during a call (▷ page 388)



If the phone number of the caller is transferred, it appears in the display.

If an entry for the caller exists in the phone book, you will also see the name.



If the phone number is not transferred or the "Hide data" function is activated, **Unknown** appears in the display.

i You can also accept a call as described above when another main function is switched on in COMAND. Once you have accepted the call, the display switches to the telephone display. After the call is finished, you see the display of the previous main application again.

The display does not switch to telephone mode if you:

- press the  back button next to the COMAND controller and then
- accept the call using the  button on the multifunction steering wheel

Rejecting a call

- ▶ **To reject:** select **Reject** by turning  the COMAND controller and press  to confirm.

or







- ▶ Press the  button on COMAND or on the multifunction steering wheel.

Making a call



Using the number keypad

- ▶ Call up the telephone basic menu (▷ page 385).
- ▶ Enter the digits using the number keypad.
- ▶ **To connect the call:** press the  button on COMAND or on the multifunction steering wheel.

Using the telephone basic menu

- ▶ Call up the telephone basic menu (▷ page 385).
 - ▶ Select the digits one by one by turning  and sliding  the COMAND controller and press  to confirm.
 - ▶ **To make a call:** select  in the character bar and press  to confirm.
- or
- ▶ Press the  button on COMAND or on the multifunction steering wheel.

Redial

- ▶ Call up the telephone basic menu (▷ page 385).
- ▶ Select  in the character bar and press  to confirm.

or

- ▶ If the telephone basic menu is displayed, press the  button on COMAND. In both cases, the calls dialed list appears. The most recently dialed number is at the top.

▶ **To select a call:** turn  the COMAND controller.

▶ **To connect the call:** press  the COMAND controller.

Using the call list or COMAND phone book

▶ Open a call list and select an entry (▷ page 395).

or

▶ Call up the COMAND phone book and select an entry (▷ page 392).

▶ **To make a call:** press  the COMAND controller or the  button.



Making a call via speed dial



The speed dial list contains stored entries from the phone book (▷ page 397).

Option 1:

- ▶ Hold down one of the number keys for longer than two seconds. The telephone basic menu displays the selected entry. This initiates dialing.

Option 2:

- ▶ Call up the telephone basic menu (▷ page 385).
- ▶ Select **Call Lists** by sliding  and turning  the COMAND controller and press  to confirm. A menu appears.

- ▶ Select **Speed Dial Preset List** by turning  the COMAND controller and press  to confirm. The speed dial list appears.
- ▶ Select preset and press  to confirm. The telephone basic menu displays the selected entry. This initiates dialing.

Functions available during a call

Overview



Telephone operation with a single call

- ① Person you are calling
- ② Symbol for active telephone connection
- ③ To switch the microphone on/off (▷ page 388)
- ④ To send DTMF tones (not possible with all mobile phones) (▷ page 389)
- ⑤ To end a call

Available functions:

- Accepting a waiting call (▷ page 389)
- Making a second call (▷ page 390)
- Call waiting (▷ page 390)

Availability depends on the network (only possible in the GSM network) and on the Bluetooth® mobile phone.

Switching the microphone on/off

This function is also available during an active phone call.

- ▶ Call up the telephone basic menu (▷ page 385).

- ▶ **To switch off:** select **Mic Off** and press  to confirm.

If the microphone is switched off, the display shows the  icon, and the **The microphone is off** message appears for a short period.

- ▶ **To switch on:** select **Mic On** and press  to confirm.

The  symbol disappears. You will briefly see the **The microphone is on** message.

Sending DTMF tones





This function is not supported by all mobile phones.

Answering machines or other devices can be controlled by DTMF tones, e.g. for remote query functions.

- ▶ If you would like to listen to the messages on your answering machine, for example, dial the corresponding number.
- ▶ **To transmit individual characters:** once a connection has been established to the answering machine, select the desired characters in the character bar, pressing  to confirm each of them.

or

- ▶ Press the corresponding key on the COMAND number keypad. Every character selected will be transmitted immediately.
- ▶ **To send a phone book entry as a DTMF sequence:** select **Name** by turning  the

COMAND controller and press  to confirm.

- ▶ Select the desired phone book entry and press  to confirm. The entry is sent as a DTMF character string.

- ▶ **To return to the call display:** select **Back** and press  to confirm.

- i** You can also send DTMF tones using the Voice Control system; see the separate operating instructions.

Calls with several participants

Rejecting or accepting a waiting call

The mobile phone network provider must support and activate the call-waiting function. Depending on the mobile phone used, the system behavior differs when accepting a call.

If you have a call in progress and receive another call, a new window appears in the display. You also hear a tone. You can accept or reject the call.

- ▶ **To reject:** select **Reject** and press  to confirm.

or

- ▶ Press the  button on COMAND or on the multifunction steering wheel.

- ▶ **To accept:** select **Accept** and press  to confirm.

or

- ▶ Press the  button on COMAND or on the multifunction steering wheel.

The system behavior after accepting the incoming call depends on your mobile phone.

- The mobile phone supports the call waiting function (via Bluetooth®) when:
 - The previously active call is held. You can then switch back and forth between both calls (toggling) (▷ page 390).
- The mobile phone does not support the call waiting function (via Bluetooth®) when:
 - The previously active call is ended.

This is also the case if you accept the waiting call using the Voice Control System (see the separate operating instructions).

The COMAND display changes. If you continue to operate functions on the mobile phone, the COMAND display may differ from that of the mobile phone.

Making a second call

If the following requirements are met, you can make another call while on the phone with someone else:

- The function has to be supported by the mobile phone network.
- The mobile phone has to support the connection of a further call via Bluetooth®. This action puts the previous call on hold if the mobile phone supports this function.
- The appropriate setting has to be activated on the mobile phone.



① Symbol for making a second call

- ▶ Select symbol ① by turning the COMAND controller and press to confirm.

or

- ▶ Press the button on COMAND.
- ▶ Enter the phone number:
 - manually (▷ page 387)
 - using the phone book (▷ page 392)
 - using the call lists (▷ page 395)
 - using speed dial (▷ page 388)

Call waiting and conference calls

You can switch back and forth between two calls with the call waiting function. The function is available if your mobile phone supports the toggling function (via Bluetooth®).

You can interconnect various callers to create a conference call with the **Conference** function.

You can use the function if you are answering a second call or making a second call while talking to someone else.



① Active call

② Call on hold

③ To interconnect the call on hold and the active call to create a conference call.

To switch between the active call and the call on hold (call waiting):

- ▶ Select call on hold ② and press to confirm.

or

- ▶ Press the button on COMAND or on the multifunction steering wheel. The previous call on hold is activated.

- ▶ **To end the active call:** select in the telephone basic menu and press to confirm.

or



- ▶ Press the button on COMAND or on the multifunction steering wheel. The call on hold is activated.

To interconnect the call on hold and the active call to create a conference call:

- ▶ Select **Conference** and press  to confirm.



To call other participants:

- ▶ Select symbol  and press  to confirm. You can now switch between the new participant and the conference call or add the participant to the conference call.



Switching between a new participant and the conference call:

- ▶ Select **Conference Call** and press  to confirm. You will change to a conference call. The new participant is placed on hold.

Adding a new participant to the conference call:

- ▶ Select **Conference** and press  to confirm.

Using the phone book

Introduction

The phone book displays the names and phone numbers of all address book entries saved in the COMAND address book. If an address book entry does not have a telephone number, it does not appear in the phone book.

The phone book of the mobile phone is automatically downloaded to COMAND after connection.



In the telephone book, you can:

- save phone numbers (▶ page 393)
- search for entries (▶ page 392)
- delete entries (▶ page 393)
- import contacts (▶ page 406)
- delete contacts (▶ page 407)
- receive vCards (▶ page 407)

 The stored phone book and the vCards remain in COMAND even if you use COMAND with another mobile phone. The entries can be viewed without a mobile phone. For this reason, you should delete any phone book entries before handing over or selling the vehicle.

Calling up the phone book

Opening the phone book

- ▶ Press the **TEL** function button.
- ▶ Select **Name** in the telephone basic menu by turning  the COMAND controller and press  to confirm. If the phone book contains entries, they will be displayed in alphabetical order. The character bar at the bottom of the display is active.





The character bar is used for fast selection of an entry.

Enter the character using the character bar (▶ page 299).



i You can also call up the phone book using the multifunction steering wheel; see the separate vehicle Operator's Manual.





Closing the phone book

► Select the  symbol in the character bar by sliding  and turning  the COMAND controller and press  to confirm.

or

► Press the  button.



Symbol overview

Sym- bol	Explanation
	Address book entry that has been entered or changed via COMAND Imported contact that has been saved in the phone or address book
	Address book entry with voice tag These entries have also been assigned a voice tag. Voice tags are available in vehicles with the Voice Control System (see the separate operating instructions).
	Contact that has been imported from a mobile phone that supports PBAP
	Entry that has been imported from the memory card or USB device
	Entry imported via the Bluetooth® interface

Searching for a phone book entry

Using the character bar



You determine the first letter of the entry you are looking for with the first character you enter.

► Select a character by turning  the COMAND controller and press  to confirm.

The first entry in the list that starts with the letter selected is highlighted. If there are similar entries, the next different character is shown. For example, with entries such as **Christel** and **Christine**, the beginnings of the names are similar. In this case, you will be offered a choice between **E** and **I**.

► Select the characters of the entry you are searching for one by one and press  to confirm.

When the selection is clear, COMAND switches automatically to the selection list.

► **To complete the search:** slide  the COMAND controller repeatedly or press and hold  until the character bar disappears.

The selection list appears.

Information about character entry
(▷ page 299)

Using the number keypad

You determine the first letter of the entry you are looking for with the first character you enter.

► Press the appropriate number keys as many times as necessary and one after the other.

Further information on character entry using the number keypad (direct entry)
(▷ page 301).

Directly from the list

You can switch to the list at any time during character entry.

- ▶ Slide $\odot \uparrow$ the COMAND controller repeatedly or press and hold \odot until the character bar disappears.

or

- ▶ Select $\boxed{\text{ok}}$ and press \odot to confirm.
- ▶ **To select an entry:** turn $\{\odot\}$ the COMAND controller until the desired entry is highlighted and press \odot to confirm.

To select a phone number: the \blacksquare symbol indicates that an entry contains more than one phone number.

- ▶ Select a phone book entry with the \blacksquare symbol and press \odot to confirm. The sub-entries appear. The \blacksquare symbol changes to \blacktriangledown .

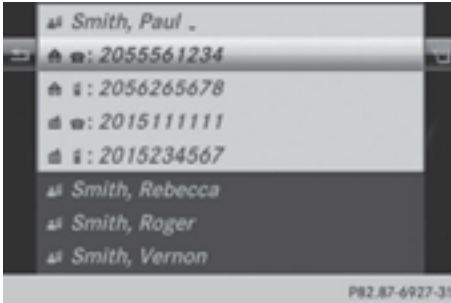

Phone book entry with several entries

- ▶ Select a sub-entry by turning $\{\odot\}$ and press \odot to confirm.
- ▶ **To return to the phone book using the character bar:** select $\boxed{\leftarrow}$ in the list and press \odot to confirm.

or

- ▶ Press the $\boxed{\text{BACK}}$ button.

Displaying details for an entry

- ▶ Select an entry in the selection list by turning $\{\odot\}$ the COMAND controller.
- ▶ Select the list symbol to the right of the entry by sliding $\odot \rightarrow$ the COMAND controller and press \odot to confirm.
- ▶ Select **Details** and press \odot to confirm. The detailed view appears.

- ▶ **To close the detailed display:** slide $\leftarrow \odot \rightarrow$ repeatedly until the entry is highlighted again.

or

- ▶ Press the $\boxed{\text{BACK}}$ back button.

Deleting an entry from the phone book

If the entry contains only phone numbers, it is deleted from the phone book and address book.

If it contains additional data, such as a navigable destination, the entry is deleted in the phone book. However, the entry is retained in the address book.

- ▶ Select an entry in the selection list by turning $\{\odot\}$ the COMAND controller.
- ▶ Select the list symbol to the right of the entry by sliding $\odot \rightarrow$ the COMAND controller and press \odot to confirm.
- ▶ Select **Delete** and press \odot to confirm. A prompt appears asking whether the entry should be deleted.
- ▶ Select **Yes** or **No** and press \odot to confirm. If you select **Yes**, the entry is deleted in accordance with the rules described above. If you select **No**, the process will be canceled.

Creating a new entry in the phone book

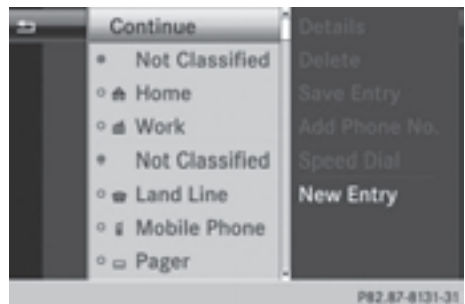

- ▶ Slide the COMAND controller repeatedly in the phone book until the selection list appears.
- ▶ Select the list symbol on the right in the selection list by sliding the COMAND controller and press to confirm.
- ▶ Select **New Entry** and press to confirm.
- ▶ Select a category for the number, e.g. **Home**, and press to confirm.
- ▶ Select a category for the phone, e.g. **Mobile**, and press to confirm.
- ▶ Select **Continue** and press to confirm. The input menu with data fields appears.



- ① Selected data field with cursor
- ② Character bar

- ▶ Enter characters (▷ page 299)
- ▶ **To save an entry:** select the symbol in the character bar by turning the COMAND controller and press to confirm. The entry is created in the phone book and in the address book.

Adding to a phone book entry

You can add telephone numbers to an existing phone book entry.

- ▶ Select an entry in the selection list by turning the COMAND controller.
- ▶ Select the list symbol to the right of the entry by sliding the COMAND controller and press to confirm.
- ▶ Select **Add Phone No.** and press to confirm.

- ▶ Select a category for the number, e.g. **Home**, and press to confirm.
- ▶ Select a category for the phone, e.g. **Mobile**, and press to confirm.
- ▶ Select **Continue** and press to confirm. COMAND stores the data if there are fewer than five numbers assigned to the entry you are searching for in the selected number category. If five numbers are stored for the entry in the selected number category, a prompt will appear. You can then choose whether to overwrite one of the existing numbers.
- ▶ Select **Yes** or **No** and press to confirm. If you select **Yes**, a selection list will appear containing the five existing numbers. If you select **No**, the process will be canceled.
- ▶ Select the number to be overwritten by turning the COMAND controller and press to confirm. An input menu appears. The data field for entering the new phone number is highlighted.

- ▶ Enter characters (▷ page 299)
- ▶ Store the entry (▷ page 300)

Using call lists

Introduction

While the telephone is being used, COMAND stores individual lists for both incoming and outgoing calls (including missed calls). Call lists are not available unless a mobile phone is connected to COMAND.

COMAND supports the PBAP Bluetooth® profile. How COMAND processes call lists depends on the model of the mobile phone connected:

- Bluetooth® telephone with PBAP Bluetooth® profile:

The call lists are downloaded automatically from the mobile phone by COMAND as

soon as the mobile phone is connected to COMAND.

- Bluetooth® telephone without PBAP Bluetooth® profile:
COMAND creates the call lists from both incoming and outgoing calls (including missed calls) as soon as the mobile phone is connected to COMAND.

i For Bluetooth® telephones without the PBAP Bluetooth® profile, the call lists in COMAND are not synchronized with those on your mobile phone. These calls may or may not be listed on your mobile phone, depending on the model.

i If no mobile phone is connected, then the **Call Lists** menu item is grayed out and cannot be selected. If you connect a mobile phone other than the previous one to COMAND, the previously available call lists and their entries will be deleted automatically. They are still available on the mobile phone itself.

i You will only be able to select the respective menu items once calls have been received or dialed from COMAND.

Displaying missed calls in the COMAND display is not supported by all mobile phones.

Opening the call list and selecting an entry

- ▶ Press the **TEL** function button.
- ▶ Select **Call Lists** in the telephone basic menu by sliding $\odot \downarrow$ and turning $\{\odot\}$ the COMAND controller and press \odot to confirm.
A menu appears.
- ▶ Select **Calls Received** or **Calls Dialed** by turning $\{\odot\}$ and press \odot to confirm. The corresponding list appears.

i You can also call up the list of dialed calls by pressing the  button when the tele-

phone basic menu is shown. In this case, the list will only show phone numbers.

- ▶ Select an entry by turning $\{\odot\}$ the COMAND controller.
- ▶ **To dial a phone number:** press \odot .
- ▶ **To close the list:** select the  symbol and press \odot to confirm.

or

- ▶ Press the **BACK** back button.

Displaying details from a list entry

COMAND can also show a shortened list entry in full.



- ▶ Select a list entry by turning $\{\odot\}$ the COMAND controller.
- ▶ Select the list symbol to the right of the entry by sliding $\odot \rightarrow$ the controller and press \odot to confirm.
- ▶ Select **Details** and press \odot to confirm. The detailed view appears.
- ▶ **To go back to the list:** slide $\leftarrow \odot$ repeatedly until the list is highlighted.





Storing a phone number

New address book entry

For incoming calls from a person who is not in the address book, COMAND displays the phone number in the call list. You can save this entry.

- ▶ Open a call list and select an entry (\triangleright page 395).
- ▶ Select the list symbol to the right of the entry by sliding $\odot \rightarrow$ the COMAND controller and press \odot to confirm.
- ▶ Select **Save** and press \odot to confirm.
- ▶ Select **New Entry** and press \odot to confirm.
- ▶ Select a category for the number, e.g. **Home**, and press \odot to confirm.
- ▶ Select a category for the phone, e.g. **Mobile**, and press \odot to confirm.

Number category	Display (phone book and address book)
Not Classified	No symbol
Home	
Work	

Telephone category	Display (phone book and address book)
Not Classified	
Mobile	
Car	
Pager	



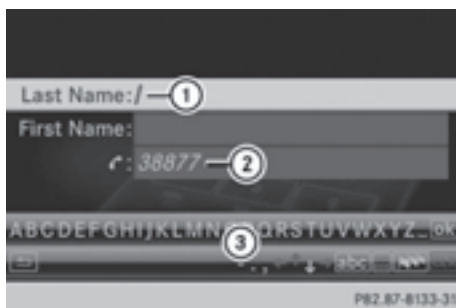



- ▶ Select **Save** and press  to confirm. An input menu with data fields is shown. The data field for the telephone number is filled in automatically.



- ① Data field with cursor
- ② Telephone number and symbol for the phone category (automatically entered)
- ③ Character bar



Adding information to an address book entry

For incoming calls from a person who is not in the address book, COMAND displays the phone number in the call list. You can save this entry.

- ▶ Open a call list and select an entry (▷ page 395).
- ▶ Select the list symbol to the right of the entry by sliding  the COMAND controller and press  to confirm.
- ▶ Select **Save** and press  to confirm.
- ▶ **Save** is shown in gray if the selected list entry has already been saved.
- ▶ Select **Add Phone No.** and press  to confirm.
- ▶ Select a category for the number, e.g. **Home**, and press  to confirm.
- ▶ Select a category for the phone, e.g. **Mobile**, and press  to confirm.
- ▶ Select **Save**. The search menu for address book entries appears.
- ▶ Search for the desired entry (▷ page 392).
- ▶ Press  when you have finished searching. COMAND stores the data if there are fewer than five numbers assigned to the entry you are searching for in the selected number category.

You will see a message to this effect.

If five numbers are stored for the entry you are searching for, a prompt will appear asking whether you wish to overwrite one of the existing numbers.

- ▶ Select **Yes** or **No** and press  to confirm. If you select **Yes**, a selection list with the five existing numbers is displayed. If you select **No**, the process will be canceled.
- ▶ Select the number to be overwritten in the list by turning  the COMAND controller and press  to confirm. COMAND overwrites the selected number with the new data.

Deleting call lists

If you are using a Bluetooth® phone that does not support the PBAP Bluetooth® profile, the call lists are generated and managed by

COMAND. You can delete these call lists in COMAND.

If you download call lists from a Bluetooth® phone that supports the PBAP Bluetooth® profile, you cannot delete them from COMAND.

- ▶ Select **Call Lists** in the telephone basic menu by turning **Ⓜ** the COMAND controller and press **Ⓜ** to confirm.
- ▶ Select **Delete Call Lists** and press **Ⓜ** to confirm.
A prompt appears asking whether you wish to delete all call lists.
- ▶ Select **Yes** or **No** and press **Ⓜ** to confirm. If you select **Yes**, the call lists are deleted. If you select **No**, the process will be canceled.

i If you delete these call lists from the mobile phone (see the separate mobile phone operating instructions), COMAND updates the call list display the next time it connects.

Using the speed dial list

Storing an entry

You can assign ten speed dial presets (0 – 9) to the speed dial list. There are two options available for this purpose.

Option 1:

- ▶ Search for a phone book entry in the phone book (▷ page 392).
- ▶ If an entry has several phone numbers, select the desired number by turning **Ⓜ** the COMAND controller.
- ▶ Select the list symbol to the right of the entry by sliding **Ⓜ** the COMAND controller and press **Ⓜ** to confirm.
A menu appears.
- ▶ Select **Speed Dial** by turning **Ⓜ** the COMAND controller and press **Ⓜ** to confirm.
A menu appears.

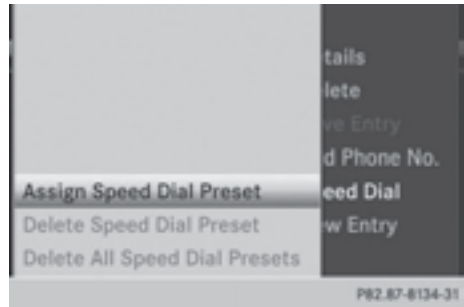

Speed dial menu

- ▶ Select **Assign Speed Dial Preset** and press **Ⓜ** to confirm.
The speed dial list appears. The selected phone book entry is listed as the first entry. The next available speed dial preset is highlighted.

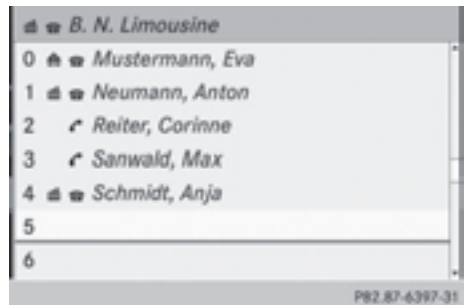

- ▶ Select the speed dial preset by turning **Ⓜ** the COMAND controller and press **Ⓜ** to confirm.
The phone book entry is saved in the speed dial preset.

Option 2:

- ▶ Call up the telephone basic menu (▷ page 385).
- ▶ Select **Call Lists** by sliding **Ⓜ** and turning **Ⓜ** the COMAND controller and press **Ⓜ** to confirm.
- ▶ Select **Speed Dial Preset List** and press **Ⓜ** to confirm.
The speed dial list appears.

- ▶ Select the list symbol to the right of the entry by sliding the COMAND controller and press to confirm.
- ▶ Select **Assign Speed Dial Preset** and press to confirm.
The speed dial list appears. The selected phone book entry is listed as the first entry. The next available speed dial preset is highlighted.

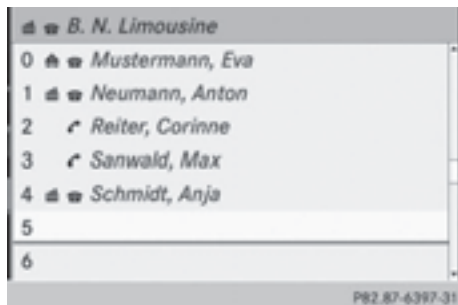

- ▶ Select the speed dial preset by turning the COMAND controller and press to confirm.
The phone book entry is saved in the speed dial preset.

Making a call via speed dial

The speed dial list contains stored phone book entries (> page 397).

Option 1:

- ▶ Hold down one of the number keys for longer than two seconds.
The telephone basic menu displays the selected entry. This initiates dialing.

Option 2:

- ▶ Call up the telephone basic menu (> page 385).
- ▶ Select **Call Lists** by sliding and turning the COMAND controller and press to confirm.
The speed dial list appears.

- ▶ Select **Speed Dial Preset List** by turning the COMAND controller and press to confirm.
The speed dial list appears.
- ▶ Select preset and press to confirm.
The telephone basic menu displays the selected entry. This initiates dialing.

Deleting a speed dial number

- ▶ **To delete a speed dial number:** select **Delete Speed Dial Preset** in the "Speed dial" menu by turning the COMAND controller and press to confirm.
The speed dial number is deleted.
- ▶ **To delete all speed dial numbers:** select **Delete All Speed Dial Presets** in the "Speed dial" menu by turning the COMAND controller and press to confirm.
You will be asked whether you want to continue.
- ▶ Select **Yes** or **No** and press to confirm.
If you select **Yes**, all speed dial presets will be deleted from the speed dial list.
If you select **No**, the process will be canceled.

Text messages

Information and requirements

In order to be able to use the text message function, the mobile phone has to support the MAP Bluetooth® profile (**M**essage **A**ccess **P**rofile).

If the above conditions are met, new incoming text messages appear in the COMAND text message inbox. The symbol appears in the status bar. The symbol disappears once you have read the text message. The mail symbol is displayed if the text message memory is full. The symbol is no longer displayed once you delete at least one text message.

i COMAND may not load all of the most recent text messages:

This may occur in exceptional cases, for example when using certain mobile phones/brackets and if the mobile phone inbox holds a large number of text messages.

Displaying the text message inbox

Calling up the inbox

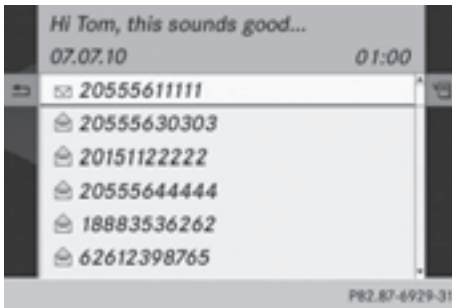

Text message inbox

- ▶ Press the **TEL** function button.
- ▶ Select **Txt Msg.** in the telephone basic menu by turning **⏻** the COMAND controller and press **⏻** to confirm. The text message inbox appears.

Reading a text message

- ▶ Call up the text message (SMS) inbox (> page 399)
- ▶ Select a text message in the text message inbox by turning **⏻** the COMAND controller and press **⏻** to confirm. The text message appears.
- ▶ **To scroll through the display or select phone numbers in a text message:** turn **⏻** the COMAND controller. The display scrolls up or down line by line, or skips to the next or previous telephone number and automatically highlights it.
- ▶ **To return to the list:** press **⏻** and select **Back**.

Text message read-aloud function

Settings for the read-aloud function:

- Language (> page 308)
- Speed (> page 308)
- ▶ Press **⏻** while a text message is being displayed, select **Read Aloud** and press **⏻** to confirm. COMAND reads out the text message.

- ▶ **To cancel the read-aloud function:** press the **⏻** button.

or

- ▶ Press **⏻**, select **Cancel Read-Aloud Function** and press **⏻** to confirm.

Sender or text display

You can switch between displaying the text message sender or the text message content. The sender display shows the sender of the text message. If the sender is stored in the COMAND phone book, the name is displayed. The text display shows the first few words of the text message.

- ▶ Select a text message in the text message inbox by turning **⏻** the COMAND controller.
- ▶ **To switch to the text display:** select the list symbol to the right of the text message by sliding **⏻** the COMAND controller and press **⏻** to confirm.
- ▶ Select **Display Text** and press **⏻** to confirm. The view changes.
- ▶ **To switch to the sender display:** select the list symbol to the right of the text message by sliding **⏻** the COMAND controller and press **⏻** to confirm.
- ▶ Select **Display Sender** and press **⏻** to confirm. The view changes.
- ▶ **To return to the telephone basic menu:** press the **BACK** button.

Displaying details and phone numbers

COMAND can also show a shortened sender display in full.

- ▶ Select a text message in the text message inbox by turning **⏏** the COMAND controller.
- ▶ Select the list symbol to the right of the text message by sliding **⏏** the COMAND controller and press **⏏** to confirm.
- ▶ Select **Details** and press **⏏** to confirm. The detailed view appears.
- ▶ **To close the detailed view:** slide **⏏** the COMAND controller.
- ▶ **To return to the telephone basic menu:** press the **BACK** button.

Managing text messages

Calling a text message sender

- ▶ Press **⏏** the COMAND controller while the text message is being displayed.
- ▶ Select **Call Sender** and press **⏏** to confirm. The telephone makes the call to the sender.

Using phone numbers in the text

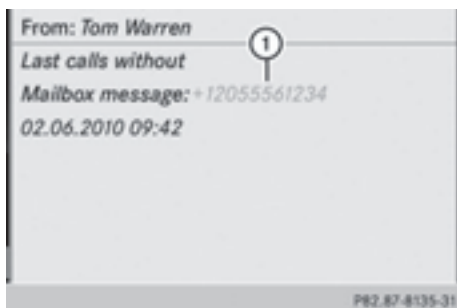

- ① Usable numerical sequence

Numbers in text messages that are highlighted in red can be used.

- ▶ Select a usable number when the text message is displayed.

- ▶ Press **⏏** the COMAND controller and select **Use**.
- ▶ Select **Call**. The phone makes the call.

i It is possible that a highlighted numerical sequence may not contain a telephone number.

i You can use the "New entry" or "Add no." functions to save this telephone number or to add it to an existing entry.

Storing the sender of a text message in the address book

This function is not available if the sender's telephone number is already stored in the address book.



- ▶ Press **⏏** the COMAND controller while the text message is being displayed.
- ▶ Select **Save Number** and press **⏏** to confirm.
- ▶ Select **New Entry** and press **⏏** to confirm.
- ▶ Store the phone number (▷ page 395)

Adding the sender of a text message to an address book entry

- ▶ Press **⏏** the COMAND controller while the text message is being displayed.
- ▶ Select **Save Number** and press **⏏** to confirm.
- ▶ Select **Add Phone No.** and press **⏏** to confirm.
- ▶ Proceed from the step "Select a number category" (▷ page 394).

Deleting a text message

- ▶ Select a text message in the text message inbox by turning **⏏** the COMAND controller.
- ▶ Select the list symbol to the right of the text message by sliding **⏏** the COMAND controller and press **⏏** to confirm.

- ▶ Select **Delete** and press  to confirm. A deletion prompt appears.
 - ▶ Select **Yes** or **No** and press  to confirm. If you select **Yes**, the text message is deleted. If you select **No**, the process will be canceled.
- i** This delete function is not supported by all mobile phones. The **Delete failed** message appears.

Using the address book

Introduction

Always pay attention to traffic conditions.

Before starting the journey, familiarize yourself with the address book functions.

Only use COMAND when the road and traffic conditions permit. You could otherwise become involved in an accident in which you or others could be injured.

The address book organizes and stores entries that are entered from different sources (mobile phone, memory card, USB device, COMAND phone book, navigation system).

You can use these entries to make telephone calls and for navigation.

- i** **Number of contacts in the address book:** the address book can store a total of 4000 contacts.

1500 entries each are reserved in the address book for:

- contacts from the mobile phone
- contacts that you create in COMAND or import from other sources

The remaining 1,000 entries are assigned by COMAND as necessary.

- i** **Display of mobile phone contacts:** contacts downloaded from the mobile phone remain in the address book even if you disconnect the mobile phone from COMAND. Contacts that have previously been available can be displayed as soon as the mobile

phone is reconnected. COMAND downloads the contacts again so that any new contacts that have been added to the mobile phone can be displayed.

As soon as you connect a new mobile phone to COMAND all the contacts from the previous mobile phone are replaced by those from the new phone's address book.



Address book entries remain stored when the mobile phone is disconnected. For this reason, delete your personal data using the reset function before selling your vehicle, for example (▷ page 311).

Calling up the address book



Using the function button:

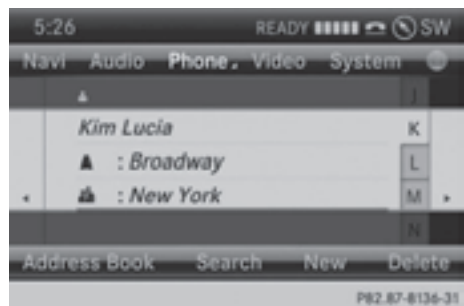

- ▶ Press the **[TEL]** function button. You see either the telephone basic menu or the address book, depending on which was last active.
- ▶ If the telephone basic menu is displayed, press the **[TEL]** function button again.

Using the telephone basic menu:

- ▶ When the telephone basic menu is displayed select **Phone** by sliding  the COMAND Controller and press  to confirm.
- ▶ Select **Address Book** from the menu and press  to confirm.



Address book with address book entry  and navigable data 

- ▶ **To browse in the address book:** turn  the COMAND controller.
- ▶ **To close the address book:** press the  button.





 An address book entry can contain the following information:

- name
- first name
- company
- two addresses
- geo-coordinates
- up to five telephone numbers

Searching for an address book entry



Search menu with character bar

-  Address book entry
-  Complete address data from the navigation system
-  Character bar
-  Phone book entry on the mobile phone
-  Entry with voice tag



For more symbols, see the symbol overview (▷ page 392)

- ▶ Find entry (▷ page 392)

Creating a new entry in the address book



You can enter address data directly into the address book. If you store telephone numbers in the COMAND phone book, these are also saved in the address book. If you store a navigation destination, COMAND creates an

address book entry which includes the complete navigable address data.

- ▶ Calls up the address book (▷ page 401)
- ▶ Select **New** in the address book by sliding  and turning  the COMAND controller and press  to confirm. An input menu with data fields appears.









Input menu with data fields

-  Selected data field with cursor
-  Character bar

- ▶ Enter characters (▷ page 299)
- ▶ Store the entry (▷ page 300)

Deleting an address book entry

- ▶ **Option 1:** select **Delete** by sliding  and turning  the COMAND controller and press  to confirm.
- ▶ **Option 2:** search for an address book entry (▷ page 392).
- ▶ Select the list symbol to the right of the entry by sliding  the COMAND controller and press  to confirm.
- ▶ Select **Delete** and press  to confirm. Irrespective of the option chosen, a prompt will appear.
- ▶ Select **Yes** or **No** and press  to confirm. If you select **Yes**, the entry will be deleted. If you select **No**, the process will be canceled.

Displaying the detailed view for an address book entry

Selecting an entry

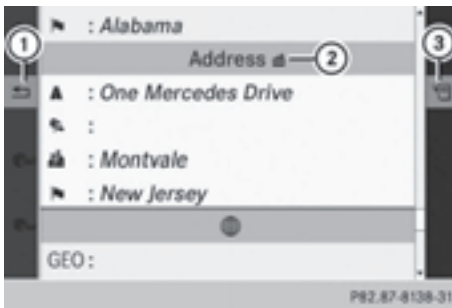

Detailed display of address book

- ① To return to the previous menu
 - ② Business details
 - ③ List symbol (to call up options)
- ▶ Searching for an address book entry (▷ page 392)
 - ▶ Make a selection in the selection list by turning the COMAND controller.
- or
- ▶ Call up the address book (▷ page 401)
 - ▶ Select an entry by turning the COMAND controller.
 - ▶ Press the COMAND controller. The detailed view appears.

Starting route guidance to an address

- ▶ Select the address data field by turning the COMAND controller and press to confirm. The route to the destination address is calculated and route guidance starts (▷ page 327).

Calling a telephone number

- ▶ Select the phone number data field by turning the COMAND controller and press to confirm. This initiates dialing and you can then make your call (▷ page 388).

Showing the details of an address book entry

- ▶ Select the list symbol to the right of the entry by sliding the COMAND controller and press to confirm.
- ▶ Select **Details** and press to confirm. The display is shown in full.
- ▶ **To close the detailed display:** press the back button.

Changing an address book entry

- ▶ **Option 1:** search for an address book entry (▷ page 392).
- ▶ Make a selection in the selection list by turning the COMAND controller.
- ▶ Select the list symbol to the right of the entry by sliding the COMAND controller and press to confirm. A menu appears.

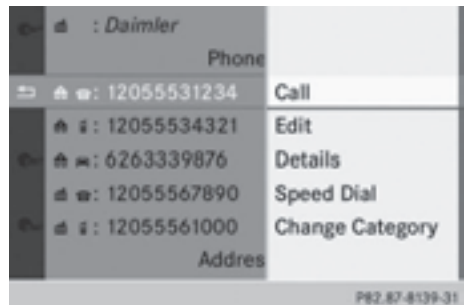

- ▶ Select **Edit** and press to confirm.
- ▶ **Option 2:** call up the detailed view for an address book entry (▷ page 403).
- ▶ Select the list symbol to the right of the entry by sliding the COMAND controller and press to confirm.
- ▶ Select **Edit** and press to confirm. Irrespective of the option chosen, the input menu containing data fields appears.

Information about character entry (▷ page 299)

Changing the category of a telephone number data field

- ▶ Display details for an address book entry (▷ page 403).
- ▶ Select the telephone number data field.
- ▶ Select the list symbol to the right of the entry by sliding the COMAND controller and press to confirm.
- ▶ Select **Change Category** and press to confirm.
- ▶ Select a number category, e.g. **Home**.
- ▶ Select a telephone category, e.g. **Mobile**.
- ▶ If desired, select **Preferred** and press to confirm.

Depending on the previous status, switch the option on or off . The phone number is displayed as the first number in the phone book and can be dialed immediately.

- ▶ Select **Save** and press to confirm. The new category is stored.

Calling a number stored in an entry

Prerequisites

The mobile phone must be connected via the Bluetooth® Interface (▷ page 381).

Dialing a number

- ▶ Display details for an address book entry (▷ page 403).
- ▶ Select the phone number data field by turning the COMAND controller.
- ▶ Press the COMAND controller to confirm.

or

- ▶ Select the list symbol to the right of the data field by sliding the COMAND controller.
- ▶ Press the COMAND controller to confirm.
- ▶ Select **Call** and press to confirm. The phone makes the call. The display switches to telephone mode.

Storing the phone number as a speed dial number

- ▶ Display details for an address book entry (▷ page 403).
- ▶ Select the phone number data field by turning the COMAND controller.
- ▶ Select the list symbol to the right of the data field by sliding the COMAND controller and press to confirm.
- ▶ Select **Speed Dial** and press to confirm.

You can now store the number in one of the ten speed dial presets (▷ page 397).

Starting route guidance to an entry

Address book entry with navigable data

This function is available as soon as you have stored a destination in the destination memory (▷ page 361).

- ▶ Search for an address book entry with the symbol and select it from the list (▷ page 402).
- ▶ Display details for an address book entry (▷ page 403).
- ▶ Select the address data field by turning the COMAND controller and press to confirm. Route guidance begins.

or

- ▶ Select the list symbol to the right of the entry by sliding the COMAND controller and press to confirm.
- ▶ Select **Navigate** and press to confirm. Route guidance begins.

Address book entry without navigable data

Route guidance can also be started for an address book entry without the symbol. If the address data or designations do not match the digital map, COMAND prompts you to re-enter the address.

- ▶ Enter the destination address (▷ page 322)
 - ▶ Start route guidance.
The navigable address is automatically added to the address book entry.
- i** This will provide you with an address book entry that is suitable for navigation. The next time the navigation is started, the address data in the navigation, rather than the postal address, is used if you have changed address in the address entry menu. Therefore, make sure that the destination address is the desired destination when starting navigation from the address book.

Voice tags

Introduction

You can enter voice tags via the Voice Control System (see the separate operating instructions). Once you have assigned a voice tag to an address book entry, you can call up this entry with a voice command and dial a phone number, for example. You can add one voice tag per address book entry.

Adding or changing a voice tag

- ▶ Search for an address book entry with or without a voice tag (☎) (▷ page 402).
- ▶ Select the list symbol to the right of the entry by sliding Ⓞ→ the COMAND controller and press Ⓞ to confirm.
- ▶ Select **Voice Name** and press Ⓞ to confirm.
- ▶ Select **Add** or **Change** and press Ⓞ to confirm.
Subsequent operation is voice-controlled. The Voice Control System guides you through the dialogs.

Deleting a voice tag

- ▶ Search for an address book entry with a voice tag (▷ page 402).
- ▶ Select the list symbol to the right of the entry by sliding Ⓞ→ the COMAND controller and press Ⓞ to confirm.
- ▶ Select **Voice Name** and press Ⓞ to confirm.
- ▶ Select **Delete** and press Ⓞ to confirm. A deletion prompt appears.
- ▶ Select **Yes** or **No** and press the (OK) button to confirm.
If you select **Yes**, COMAND deletes the voice tag.
If you select **No**, the process will be canceled.

Listening to a voice tag

- ▶ Search for an address book entry with a voice tag (▷ page 402).
- ▶ Select the list symbol to the right of the entry by sliding Ⓞ→ the COMAND controller and press Ⓞ to confirm.
- ▶ Select **Voice Name** and press Ⓞ to confirm.
- ▶ Select **Listen** and press Ⓞ to confirm.
You hear the voice tag.





Importing phone book entries

This function allows you to store phone book entries from the mobile phone in the address book.

The following can be used as a source:

- the mobile phone
- the memory card
- the USB device
- the Bluetooth® Interface

Imported phone book entries are indicated in the phone book by different symbols (▷ page 392).

- ▶ Search for an entry in the phone book on the mobile phone  (▷ page 392).
- ▶ Select the list symbol to the right of the entry by sliding  the COMAND controller and press  to confirm.
- ▶ Select **Save Entry** and press  to confirm.

The **Data Saved** message appears. The phone book entry is now saved as an address book entry.

The  symbol is replaced by the  symbol.

Importing contacts

Information and requirements

You can import contacts (vCards) from the memory card and a USB device into the address book, or receive vCards via Bluetooth®.

- i** Up to 2500 entries can be imported into the address book. A message notifies you when the maximum number is reached. You then have to delete existing entries in order to import new entries (▷ page 402).

Depending on the source of the contact data, different requirements apply:

Source	Prerequisites
Memory card	The SD memory card is inserted (▷ page 445). It contains importable contact details.
USB device	The USB device is inserted into the USB port (▷ page 445). It contains importable contact details.

Requirements for receiving vCards via Bluetooth®

You can receive vCards from devices (e.g. from a PC) that support the sending of vCards via Bluetooth®.

It is not necessary to authorize the device in COMAND to do so.

Please bear the following in mind:







- Bluetooth® must be activated in COMAND and on the Bluetooth® device, see the operating instructions for the device.
- the Bluetooth® device must be able to send vCards via Bluetooth® (see operating instructions for the device).
- the Bluetooth® device in the vehicle must be switched on.

Importing from the memory card or USB device

Entries imported from the memory card or from a USB device have the  symbol.

The following conditions must be fulfilled in order to import vCards:

- vCards (vcf files) may be located in the main directory or in folders. COMAND allows you to select the relevant folders directly.
- vCards must have the file extension ".vcf".
- i** One vcf file may contain several vCards. COMAND supports vCards in versions 2.1 and 3.0.

- ▶ Select **Address Book** in the address book or, if the telephone basic menu is shown, select **Telephone** by sliding  and turning  the COMAND controller and press  to confirm.
- ▶ Select **Import Contacts** and press  to confirm. A menu appears.
- ▶ Select **From the Memory Card** or **From USB Device** in the menu by turning  the COMAND controller and press  to confirm.
- ▶ Select **Add** or **Overwrite** and press  to confirm. **Add** imports the entries from the memory card or USB device into the address book. **Overwrite** imports the entries from the memory card or USB device and overwrites

all entries in the address book with the  symbol. The previous entries are then no longer available.

After the contact data has been imported successfully, you will see a message to this effect. The address book or the respective telephone basic menu is displayed.

- ❗ You can select **Overwrite** if the address book already contains corresponding entries. A message notifies you when the address book is full.

Receiving vCards via Bluetooth®



- ▶ Select **Address Book** in the address book or, if the telephone basic menu is shown, select **Telephone** by sliding $\odot \downarrow$ and turning $\left\{ \odot \right\}$ the COMAND controller and press \odot to confirm. A menu appears.
- ▶ Select **Import Contacts** and press \odot to confirm.
- ▶ Select **Receive Contacts From Phone** in the menu by turning $\left\{ \odot \right\}$ the COMAND controller and press \odot to confirm. This interrupts the Bluetooth® connection between COMAND and your active mobile phone. COMAND is, however, ready to receive vCards from another Bluetooth® device (PC, mobile phone).
- ▶ Start the data transfer on the external Bluetooth® device (see the operating instructions for the device).

The number of vCards received is displayed.

- ▶ **To end reception:** press \odot or the  back button. COMAND then reconnects to the mobile phone.

Received vCards are identified by the  symbol in the address book.

- ❗ If you switch to another main function, e.g. navigation, while receiving vCards, the reception of vCards will be terminated.

Deleting contacts

- ▶ Select **Address Book** in the address book or, if the telephone basic menu is shown, select **Telephone** by sliding $\odot \downarrow$ and turning $\left\{ \odot \right\}$ the COMAND controller and press \odot to confirm. A menu appears.
- ▶ Select **Delete Contacts** and press \odot to confirm.
- ▶ Select one of the following options:
 - **Internal Contacts**
 - **Contacts From Storage Devices**
 - **Received Business Cards**
 - **Delete All**
 A prompt corresponding to your selection appears.
- ▶ Select **Yes** or **No** and press \odot to confirm. If you select **Yes**, the contacts are deleted according to your selection. If you select **No**, the process will be canceled.

Switching importing of contacts on/off

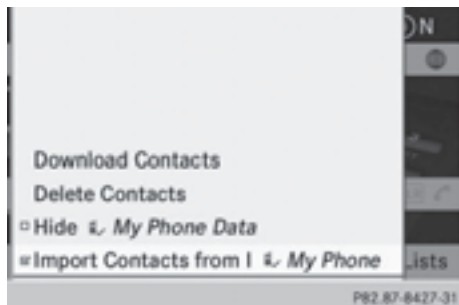

You can choose whether contacts are automatically downloaded when a mobile phone is connected to COMAND, or whether the automatic download is suppressed.

Connecting a mobile phone (▷ page 381)

▶ Select **Te1** in the telephone basic menu by sliding and turning the COMAND controller and press to confirm. A menu appears.

▶ Select **Import Contacts from <my phone>** and press to confirm.

You can allow or suppress the automatic download.

Proceed as follows if you do not want to save sensitive contacts in the address book:

▶ Connect the mobile phone to COMAND. Contacts are automatically downloaded to the address book.

▶ Delete sensitive contacts in the address book.

▶ Switch off the **Import Contacts from <my phone>** function .

The next time you connect your mobile phone to COMAND, no more contacts will be downloaded, not even newly-added contacts.

Switching the display of contact details (privacy) on/off

Using the **Hide Data** setting, you can decide whether the phone and address book data are to be visible on the screen. You can therefore,

for example, prevent a passenger from seeing the name of a caller.

Activating the function has the following effects:

- The mobile phone's phone book and address book data are hidden. They can therefore not be used to make calls, send text messages or to navigate. You still have access to the phone book and address book stored on COMAND.
- During incoming calls, the caller's name is not displayed if there is an address book entry for the number that is calling.
- During outgoing calls where the number is entered manually, the recipient's name is not displayed, even if there is an address book entry for the entered number.
- The call list is hidden.
- Redialing is not possible.
- The received text messages list is hidden. There is still a notification for incoming text messages. For this to be the case, the connected mobile phone must support the MAP profile. However, it is not possible that, for example, the passenger could see the phone number or have access to the message.

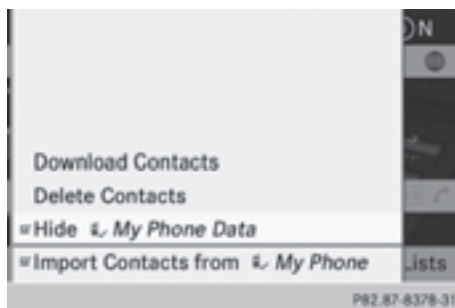

Connecting a mobile phone (▷ page 381)

▶ Select **Te1** in the telephone basic menu by sliding and turning the COMAND controller and press to confirm. A menu appears.

A menu appears.

- **To hide details:** select **Hide <My Phone> Data** and press  to confirm.
You can allow access to address data or you can prevent access .

Online and Internet functions

Your COMAND equipment

These operating instructions describe all the standard and optional equipment for your COMAND system, as available at the time of going to print. Country-specific differences are possible. Please note that your COMAND system may not be equipped with all the features described.

General notes

Conditions for access

WARNING

If you operate information systems and communication equipment integrated in the vehicle while driving, you will be distracted from traffic conditions. You could also lose control of the vehicle. There is a risk of an accident. Only operate the equipment when the traffic situation permits. If you are not sure that this is possible, park the vehicle paying attention to traffic conditions and operate the equipment when the vehicle is stationary.

You must observe the legal requirements for the country in which you are currently driving when operating COMAND Online.

USA only:

To use COMAND Online Mercedes-Benz Apps and Internet access, the following conditions must be fulfilled:

- mbrace is activated and operational
- mbrace is activated for COMAND Online Mercedes-Benz Apps and Internet access

Priority of connections: an emergency call has the highest priority. When a service call, e.g. a breakdown service call or the MB Info

Call, is active, an emergency call can still be initiated.

A service call, on the other hand, has priority over a current Internet connection. Therefore, you cannot establish an Internet connection during a service call.

- **i** The availability of individual COMAND Online Mercedes-Benz Apps may vary depending on the country.
- **i** The terms of use are shown when COMAND Online is used for the first time and then once a year thereafter. Only read and accept the terms of use when the vehicle is stationary.
- **i** Internet pages cannot be shown on the driver's side while the vehicle is in motion.

Canada only:

The COMAND Online Mercedes-Benz Apps and the Internet access are available via the Bluetooth® interface.

In order to use the functions, the following conditions are necessary:

- The mobile phone supports the DUN Bluetooth® profile (**Dial-Up Networking**) and is connected to COMAND via the Bluetooth® interface (▷ page 381). The DUN Bluetooth® profile enables the mobile phone to establish a dial-up connection to the Internet.
- You need a valid mobile service contract with a data option, which is used to calculate the associated connection costs.
- The access data of the mobile phone network provider must be set on COMAND for the connected mobile phone (▷ page 411).
- **i** If the connected mobile phone supports the PAN Bluetooth profile (Personal Area Network), you can use the automatic configuration function (▷ page 411).
- **i** You can obtain more detailed information about suitable mobile phones on the Internet at <http://www.mercedes->

benz.com/connect or from your authorized Mercedes-Benz Center.

- i** If you use incorrect access data, additional costs may be incurred. This can happen when you use details that are different from the contract or details from another contract/data package.
- i** The availability of individual Mercedes-Benz Apps may vary depending on the country.
- i** The terms of use are shown when COMAND Online is used for the first time and then once a year thereafter. Only read and accept the terms of use when the vehicle is stationary.
- i** Internet pages cannot be shown on the driver's side while the vehicle is in motion.

Connection difficulties while the vehicle is in motion (Canada only)

The following could be the cause of call disconnection:

- insufficient GSM/UMTS network coverage
- the vehicle has moved into a GSM cell with no free channels
- the SIM card used is not compatible with the network available
- you are using a mobile phone with "Twin-card" and the mobile phone with the second SIM card is logged into the network at the same time

Function restrictions (Canada only)

You will not be able to use the mobile phone, will no longer be able to use the mobile phone, or you may have to wait before using it, in the following situations:

- when the mobile phone is switched off
- if the Bluetooth® function is switched off in COMAND
- if the Bluetooth® function is switched off on the mobile phone while you are using Bluetooth® interface telephony

- if the mobile phone has not logged on to a mobile phone network
- if neither the mobile phone network nor the mobile phone allow simultaneous use of a phone and an Internet connection

- i** It is possible that you may not be able to receive calls when an Internet connection is active. This depends on the mobile phone and the mobile phone network used.

Roaming (Canada only)

When you are driving your vehicle in a different country and using COMAND Online and Internet functions, additional costs may be incurred (roaming fees). When you are in a different country, your SIM card must be enabled for data roaming. If your mobile phone network provider does not have a data roaming agreement with the roaming partner, it may not be possible to establish an Internet connection. Deactivate this function on your mobile phone if you want to avoid data roaming when you are in a different country.

Setting access data (Canada only)

Introduction

To use online and Internet functions, you need Internet access data for the connected mobile phone. You can obtain this from your mobile phone network provider.

A selected/manually set mobile phone network provider is only valid for the mobile phone connected when the selection/setting is made. The mobile phone network provider is set automatically upon reconnection.



- i** When you are driving your vehicle in a different country and using the online and Internet functions on COMAND, you may incur additional costs (roaming fees).
- i** While initializing the mobile phone for the Internet connection, access data which is already on the mobile phone may be overwritten. You should therefore check the

settings on the mobile phone (see the mobile phone operating instructions).



- ▶ **i** Adjust the access data settings when the vehicle is stationary. You may otherwise be distracted from the traffic conditions, cause an accident and injure yourself and others.

Selecting/setting Internet access data

Calling up mobile network providers

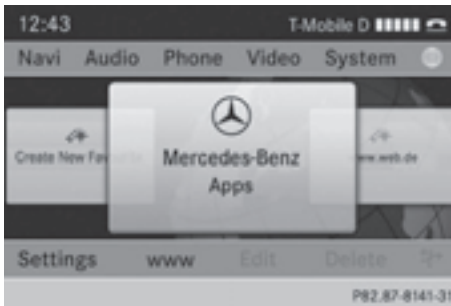
- ▶ Select the  icon in the main function bar by turning  the COMAND controller and press  to confirm. The carousel view appears.



- ▶ Select **Settings** by sliding  and turning  the COMAND controller and press  to confirm. When you connect the mobile phone to COMAND for the first time (▷ page 381), there is no mobile phone network provider preset. **Provider:** is followed by the words **Not Selected**.

If a mobile phone is connected and a mobile phone network provider has been selected, the name of the mobile phone network is shown after **Provider:**.

- ▶ Press  the COMAND controller. The list of mobile phone network providers appears.

In order to set the access data of the mobile phone network provider you can:



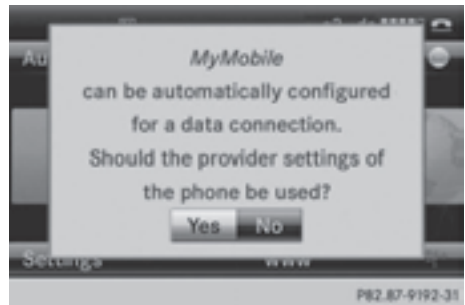

- select the predefined access data of the mobile phone network provider (▷ page 412)
- configure automatically – this option only appears in the list of providers if the connected mobile phone supports the Bluetooth® PAN (Personal Area Network) profile (▷ page 411).
- manually set the access data of the mobile phone network provider (▷ page 413)

Configuring access data automatically



Requirement: your telephone must be connected to COMAND via Bluetooth® and must support the Bluetooth® PAN profile.

Option 1 if your telephone is not yet configured for Internet access:

- ▶ Select the  icon in the main function bar by sliding  and turning  the COMAND controller and press  to confirm. You will see a message informing you that automatic configuration is possible.
- ▶ Select **Yes** and press  to confirm.

Option 2:

- ▶ In the list of mobile phone network providers, select **Autom. Configuration <Device_name>** by turning **⏏** the COMAND controller and press **⏏** to confirm (▷ page 411).
The configuration data is transferred from the mobile phone. If the configuration is successful, a **•** dot appears in front of **Autom. Configuration <Device_name>**.

Selecting access data of the mobile phone network provider

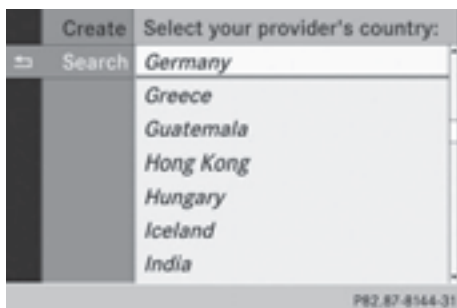

Searching for providers

- ▶ Select **Search for Providers** in the mobile phone network providers list by turning **⏏** the COMAND controller and press **⏏** to confirm (▷ page 411).
A list of countries appears.
- ▶ Select the country of your mobile phone network provider, e.g. **Germany**, and press **⏏** to confirm.
The list of available mobile phone network providers appears.
- i** The access data for the mobile phone network provider is selected once for the mobile phone connected and is loaded again each time the mobile phone is connected (▷ page 411).



- i** You must set the access data of the mobile phone network provider who provides the SIM card and the associated data package (access settings) for the connected mobile phone. The access data remains the same when you are in a different country (roaming). The access data of another network is **not** selected.

There are mobile phone network providers who offer multiple access data. This depends on the data package used, for example.

The mobile phone network only has one access setting

- ▶ Select the mobile phone network provider by turning **⏏** the COMAND controller and press **⏏** to confirm.
A menu appears.
- ▶ **To check preset access data:** select **Edit** and confirm with **⏏**.
The list of access data appears (▷ page 413).
- ▶ Check the access data.
- ▶ **If the access data is correct:** press the **⏏** reset button or the **⏏** symbol and press **⏏** to confirm.
You can now accept the access data of the mobile phone network provider.
- ▶ Select **Save** and press **⏏** to confirm.
The list of mobile phone network providers appears; the access data of the provider has been accepted.

- ▶ **To edit the access data:** proceed as described for manually entering the access data (▷ page 413).

When you confirm the edited access data, the list of mobile phone network providers appears and displays the selected provider.

If, after selecting a mobile phone network provider, several access settings are displayed:

- ▶ Select the appropriate access setting by turning **⏪** the COMAND controller and press **⏩** to confirm. A menu appears.

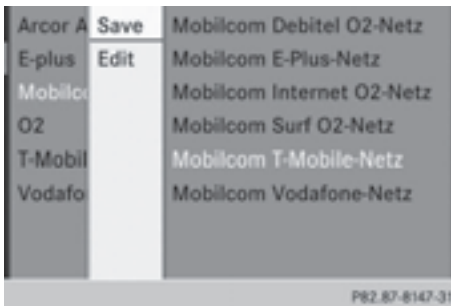

- ▶ **To check access settings:** select **Edit** and press **⏩** to confirm. The list of access data appears (▷ page 413).
- ▶ Check the access data.
- ▶ **If the access data is correct:** press the **⏪** reset button or the **⏩** symbol and press **⏩** to confirm. You can now accept the access data of the mobile phone network provider.
- ▶ Select **Save** and press **⏩** to confirm. The list of mobile phone network providers appears; the access data of the provider has been accepted.
- ▶ **To edit the access data:** proceed as described in "Manually setting the access data of the mobile phone network provider" (▷ page 413). When you confirm the edited access data, the list of mobile phone network providers appears and displays the selected provider.

The currently selected access settings (● dot in front of the entry) are used for the connected mobile phone.

- ▶ **To return to the carousel view:** press the **⏪** back button twice.
- or
- ▶ Press **⏩** the COMAND controller and then the **⏪** back button.

Manually setting the access data of the mobile phone network provider



List of access data (new provider)

Calling up the list of access data

- ▶ Confirm **Create New Provider** in the list of mobile phone network providers by pressing **⏩** the COMAND controller. The list of access data appears. The standard name **provider <x>** is automatically entered into the **Provider:** field. You can now make the entries.

i The access data of the mobile phone network provider is set once for the connected mobile phone.

Explanation of the access data





Input field	Meaning
Provider:	Name of the provider to be displayed in the list of mobile phone network providers. The name can be freely selected. The standard entry is provider <x> .
Te1. Number:	Access number for establishing the connection i The access number depends on the mobile phone used. For GSM/UMTS mobile phones, *99***1# is used as a standard.
Access Point:	APN network access point (A ccess P oint N ame) You can obtain this information from your mobile phone network provider. i Entry is not necessary for all mobile phone network providers and mobile phones.
User ID:	The user identification can be obtained from your mobile phone network provider. i Entry is not necessary for all mobile phone network providers.
Password:	The password can be obtained from your mobile phone network provider. i Entry is not necessary for all mobile phone network providers.

Input field	Meaning
DNS Address:	The DNS addresses (D omain N ame S ervice) can be negotiated automatically or entered manually. The required information can be obtained from your mobile phone network provider. i Most mobile phone network providers support the Automatic function. If you selected the Manual option, you are usually required to enter a DNS address.
DNS 1: DNS 2:	Fields for entering the DNS server addresses manually. The address can be obtained from your mobile phone network provider.

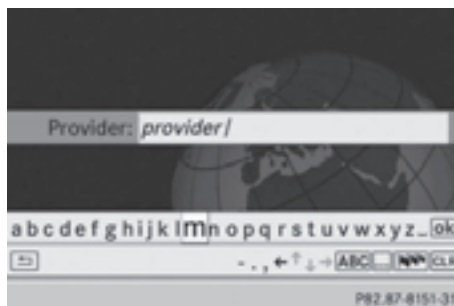
Entering access data

- In the list of access data, confirm the **Provider** input field by pressing  (▷ page 413).
An input menu appears.





- Enter the provider (▷ page 299).
- **To enter the phone number:** in the list of access data, select the **Te1. Number:** input field by sliding   or turning  

the COMAND controller and press  to confirm.

The input menu for the phone number appears.



- ▶ Enter the telephone number.
- ▶ **To enter the access data:** in the list of access data, select the **Access Point:** input field and confirm by pressing .
- ▶ Enter the access data.
- ▶ **To enter the user ID:** in the list of access data, select the **User ID:** input field and confirm by pressing .
- ▶ Enter the user ID.
- ▶ **To enter the password:** in the list of access data, select the **Password:** input field and confirm by pressing .
- ▶ Enter the password.

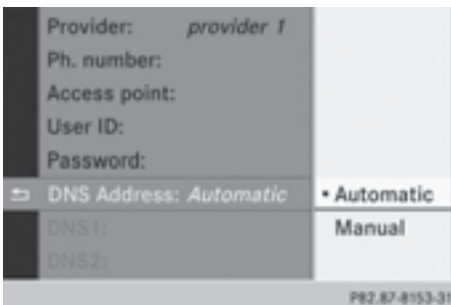

- ▶ **To set the DNS address:** select **Automatic** or **Manual** with the COMAND controller and press  to confirm.
Automatic: the DNS address is set automatically.

Manual: uses the entries in DNS 1 and DNS 2.



Entering the DNS 1



Entering the example DNS

- ▶ After selecting **Manual**, select the **DNS1** input field with the COMAND controller and press  to confirm.
- ▶ Enter **172.28.4.81**, for example.

Internet access data for other mobile phones

If the access data is already available in the list of mobile phone network providers, you can use it for additional mobile phones.

The following prerequisites are required for this:

- the additional mobile phone must be connected.
- the access data must apply to the mobile phone contract of the currently connected mobile phone.
- ▶ Select a provider from the list of mobile phone network providers by turning  the COMAND controller and press  to confirm (▷ page 412).
After you select the provider, the list of mobile phone network providers is closed. The selected provider is entered.

Managing access data of the mobile phone network provider

Overview

The access data of the mobile phone network provider can be:

- edited
- copied, then edited and accepted for a new provider name
- deleted

i Changes that you make to the access data of a mobile phone network provider apply to all mobile phones that use this access data.

i When the Internet connection is active, you cannot edit or delete the access data of the currently set mobile phone network provider.

Editing the access data

- ▶ Select a provider from the list of mobile phone network providers by turning **⌘** the COMAND controller (▷ page 412).
- ▶ Select the symbol to the right of the entry by sliding **⊙** the COMAND controller and press **⌘** to confirm.

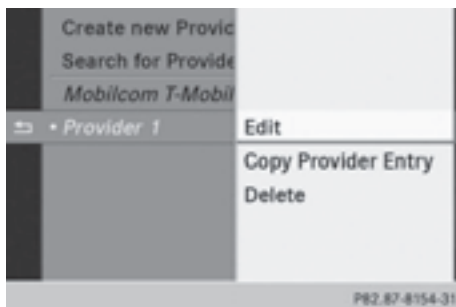

- ▶ Confirm **Edit** by pressing **⌘**. The access data is displayed.
- ▶ Edit the access data. A description of the entry can be found under "Manually setting the access data of the mobile phone network provider" (▷ page 413).

Saving access data under a new provider name

- ▶ Select a provider from the list of mobile phone network providers by turning **⌘** the COMAND controller (▷ page 412).
- ▶ Select the symbol to the right of the entry by sliding **⊙** the COMAND controller and press **⌘** to confirm.
- ▶ Confirm **Copy Provider Entry** by pressing **⌘**. The access data is displayed.
- ▶ Edit the access data. A description of the entry can be found under "Making entries" in the "Manually setting the access data of the mobile phone network provider" section (▷ page 413).

Deleting the access data of the mobile phone network provider

- ▶ Select a provider from the list of mobile phone network providers by turning **⌘** the COMAND controller (▷ page 412).
- ▶ Select the symbol to the right of the entry by sliding **⊙** the COMAND controller and press **⌘** to confirm.
- ▶ Confirm **Delete** by pressing **⌘**. A prompt appears asking whether you wish to delete the access data.
- ▶ Select **Yes** or **No** and press **⌘** to confirm.

Selecting the length of time for automatic disconnection from the Internet



If a preset time has elapsed during which neither the online functions nor the Internet have

been used, COMAND Online automatically disconnects from the Internet.

- ▶ Select **Settings** in the carousel view by sliding and turning the COMAND controller and press to confirm.
- ▶ Select **Disconnect Automatically After:** and press to confirm.
The **•** dot indicates the current setting.
- ▶ Select **5 min**, **15 min** or **Off** and press to confirm.
Off switches the function off.

An active Internet connection is identified by the double arrows on the top right of the display.

Establishing/ending the connection

Establishing the connection

Preconditions for establishing a connection can be found under "General notes" (▷ page 409).

- ▶ **Option 1:** select the icon in the main function bar by turning the COMAND controller and press to confirm.
The carousel view appears.
- ▶ Turn or slide the COMAND controller until the **Mercedes-Benz Apps** panel or a favorite is brought to the front, if these have been previously created (▷ page 431).
- ▶ **Option 2:** enter a web address (▷ page 427).

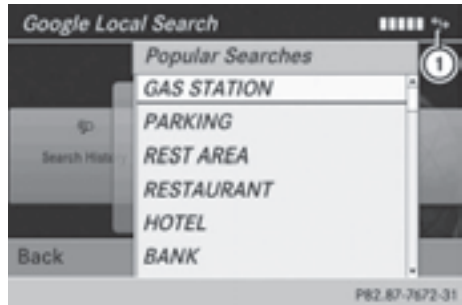
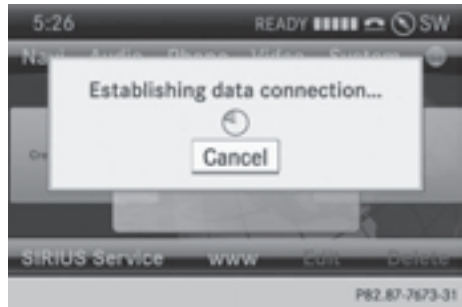

- ▶ For both options, press the COMAND controller.
The Internet connection is established. An active Internet connection is identified with symbol . The example shows the menu in the Google™ Local Search (▷ page 418) function.
 - ▶ **To cancel the connection:** while the connection is being established, confirm **Cancel** by pressing .
- or
- ▶ Press the button on COMAND or on the multifunction steering wheel.

Ending the connection

US only: you cannot cancel the connection yourself.

The Internet connection is automatically terminated if the system does not recognize any user input within a five-minute time period.

The button is inoperative.

Canada only:

- ▶ Press the  button on COMAND or on the multifunction steering wheel.

or









- ▶ Select the scissors symbol on the bottom right of the carousel view and press  to confirm.

i If the mobile phone Internet connection is canceled, COMAND tries to reconnect. You should therefore always close the connection on COMAND or via the multifunction steering wheel.

Google™ Local Search

Calling up the Local Search menu



- ▶ Select the  icon in the main function bar by turning  the COMAND controller and press  to confirm. A list with active Mercedes-Benz Apps appears.
- ▶ Bring the **Mercedes-Benz Apps** panel to the front by turning  the COMAND controller and pressing  to confirm. The Mercedes-Benz Apps menu is displayed.
- ▶ Confirm the **Google Local Search** entry by pressing . The Google Local Search menu appears.
- ▶ **To exit the menu:** select **Back** by sliding  and turning  the COMAND controller and press  to confirm.

Search



Entry restriction

It is only possible to enter a search term in the input menu when the vehicle is stationary.

Entering a search term

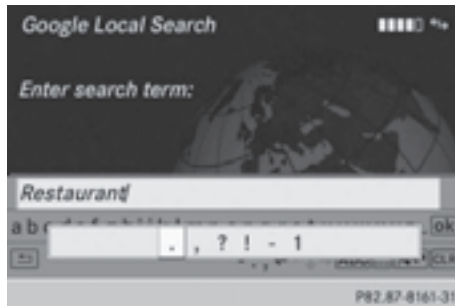

Input menu

- ▶ Confirm **Search** in the Google Local Search menu by pressing . The input menu appears.
 - ▶ **To enter using the character bar:** enter the search term.
 - ▶ **To enter characters using the number pad:** press the number keys in rapid succession. The character appears when the key is pressed. The first available character is highlighted.
- 
- ▶ After entering the search term, select **ok** by turning  the COMAND controller and press  to confirm. A menu appears. Here, you can select where the destination search should begin.

Selecting the search position

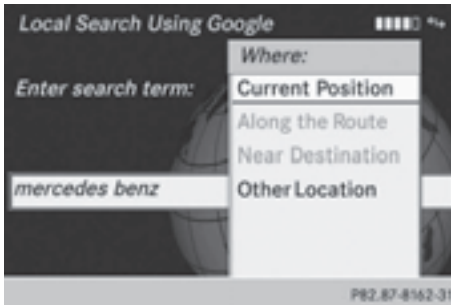

- ▶ After a search term has been entered and confirmed, a menu appears. COMAND searches for available POIs for the search term entered:
 - near the current vehicle position
 - along the calculated route
 - If a destination has previously been entered, the function is available.
 - near the destination
 - If a destination has previously been entered, the function is available.
 - near an address
- ▶ After selecting **Near Destination**, enter an address and confirm. The search results are displayed.

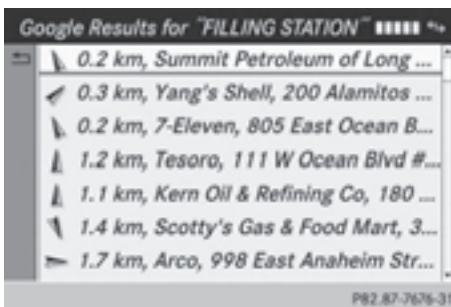

Example: search results

Using search results

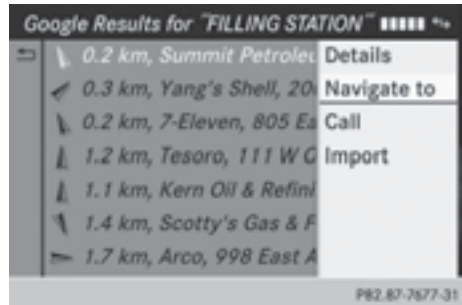

- ▶ Select an entry in the list of search results by turning $\left[\odot \right]$ the COMAND controller and press $\left[\odot \right]$ to confirm. A menu appears.
 - ▶ **To show the detailed view:** confirm **Details** by pressing $\left[\odot \right]$ the COMAND controller. The address of the selected entry is displayed.
 - ▶ **To use a search result as the destination:** select **Navigate to** by turning $\left[\odot \right]$ the COMAND controller and press $\left[\odot \right]$ to confirm. You then switch to navigation mode and can start route calculation (▷ page 327). You then switch to navigation mode and can start route calculation.
 - i** The search result is stored in the "Last destinations" memory at the same time (▷ page 364). You can take the destination from this memory and save it permanently in the destination memory (▷ page 361).
 - ▶ **To call up a destination:** select **Call** with the COMAND controller and press $\left[\odot \right]$ to confirm. You then switch to the telephone function and make the call (▷ page 387). You then switch to the telephone function and make the call.
 - i** If there is no phone number available, the menu item cannot be selected.

- ▶ **To import a destination:** select **Import** with the COMAND controller and press  to confirm.



You can choose whether you want to save the POI as a personal POI on the SD memory card or in the address book.

- i** If there is no SD memory card in the slot, the **Save As Personal POI** menu item cannot be selected.

- ▶ Insert the SD memory card (▷ page 445).

- ▶ **To save as a personal POI:** confirm **Save As Personal POI** by pressing  the COMAND controller. The entry is saved as a personal POI on the SD memory card.

- i** You can use a personal POI in navigation mode for route calculation (▷ page 342). If the personal POI is saved on the SD memory, you can also use it for route calculation in another vehicle.

- ▶ **To save to the address book:** select **Save to Address Book** by turning  the COMAND controller and press  to confirm. The entry is stored in the address book.

Popular searches



This function allows you to search using predefined search criteria.

- ▶ Bring **Popular Searches** in the Local Search menu to the front by turning  the

(the COMAND controller and press  to confirm.

A menu displays the available search criteria.

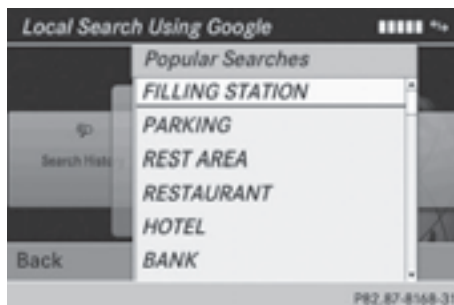



Example: popular searches

- ▶ Select the search criteria and press  to confirm.
- ▶ Proceed as described in the "Selecting the search position" section (▷ page 419). If the vehicle is stationary, the search results can be supplemented manually, e.g. "Hotel Adler".

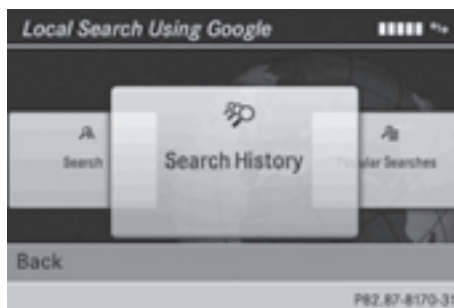
Search History



This function offers you the previous search queries.

- ▶ Bring **Search History** in the Local search menu to the front by turning  the COMAND controller and press  to confirm.

The previous search queries are shown with the most recent at the top.



- ▶ Select the search criteria and press to confirm.
- ▶ Proceed as described in the "Selecting the search position" section (▶ page 419). If the vehicle is stationary, the search results can be supplemented manually, e.g. "Hotel Adler".

Destination/route download

Introduction

You can send destinations and routes from Google™ maps to the server and download these via this function. You can use the destinations and routes for route guidance and save them for further use.

In order to use the download destination/route function, the mbrace system must be:

- activated
- set up
- and activated for COMAND and Internet access services.

For information on the mbrace system, see the separate vehicle Operator's Manual.

Sending destinations to the server

- ▶ Call up the website for Google™ Maps on the Internet.
- ▶ Enter a destination.
- ▶ Click "More" at the destination.
- ▶ Click "Send".
- ▶ Click "Send to vehicle".

- ▶ Select Mercedes-Benz as the vehicle brand.
- ▶ Enter the mbrace e-mail address or the vehicle identification number.
- ▶ Enter the vehicle identification number.
- ▶ Click "Send".

The destination is sent to the server.

- i** The availability of the destination/route download function is country-dependent.

Downloading destinations from the server

Proceed as follows to use destinations/routes that have been sent to the server:

- ▶ Select the symbol in the main function bar by turning the COMAND controller and press to confirm. The carousel view appears.
- ▶ Bring the [Mercedes-Benz Apps](#) panel to the front by turning the COMAND controller and press to confirm. The Mercedes-Benz Apps menu is displayed.

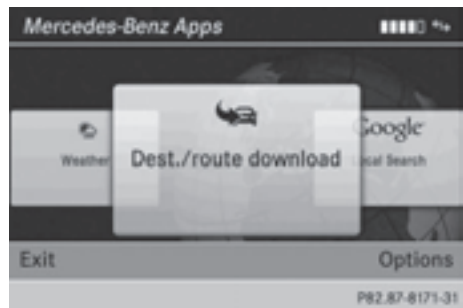

- ▶ Bring the [Dest./Route Download](#) panel to the front and press to confirm.

- i** With [Exit](#), you quit the destination/route download.

With [Options](#), you set the options for the destination/route download (▶ page 424).

- ▶ Confirm the [Dest./Route Download](#) panel by pressing .
- Available routes and destinations are shown in the list.

You can save up to 20 routes and 50 destinations for your vehicle on the server and display these in the list. If you send further routes or destinations to the server, the existing entries are deleted from the list.

- i** The routes/destinations sent from Google™ maps to the server are automatically deleted from there after seven days.

Using destinations

Calling up the menu

- ▶ Select an entry in the list by turning **[⊙]** the COMAND controller and press **[↵]** to confirm.
A menu appears.

Displaying details

- ▶ Confirm **Details** in the menu by pressing **[↵]** the COMAND controller.
The route or destination is displayed.

- ▶ **To call up a POI:** confirm the entry by pressing **[↵]**.

- i** You can use the function if:
 - a mobile phone is connected (▷ page 381)
 - the destination address contains a telephone number

Using as the destination

- ▶ Select **Navigate to** in the menu by turning **[⊙]** the COMAND controller and press **[↵]** to confirm.
You then switch to navigation mode and can start route calculation (▷ page 327).

- i** A route can only be stored as a personal POI on an SD memory card or taken directly for route calculation (▷ page 422).

Calling up the destination

- ▶ Select **Call** in the menu by turning **[⊙]** the COMAND controller and press **[↵]** to confirm.
You then switch to the telephone function and make the call (▷ page 387).

Importing a destination/route

When importing, you can choose whether you want to save the destination as a personal POI on an SD memory card or in the address book. You can only save routes as personal POIs to an SD memory card, but not in the address book.

- ▶ Select **Import** in the menu with the COMAND controller and press **[↵]** to confirm.

- i** If there is no SD memory card in the slot, the **As Personal POI** menu item is grayed out.

- ▶ Insert the SD memory card (▷ page 445).

- ▶ **To save as a personal POI:** confirm **As Personal POI** by pressing **[↵]** the COMAND controller.
The entry is saved as a personal POI on the SD memory card.

- i** You can use a personal POI in navigation mode for route calculation (▷ page 342).
You can also use a personal POI in another vehicle for route calculation.

- ▶ **To save to the address book:** select **To Address Book** by turning **[⊙]** the COMAND controller and press **[↵]** to confirm.
The entry is stored in the address book.

Deleting a destination/route from the server

- ▶ Select an entry in the list by turning **[⊙]** the COMAND controller and press **[↵]** to confirm.
- ▶ Select **Delete** and press **[↵]** to confirm.
A query appears asking whether the destination or the route should be deleted.
- ▶ Select **Yes** or **No** and press **[↵]** to confirm.

Options









Introduction

You can select options for the following Mercedes-Benz Apps on COMAND:

- Local Search (▷ page 423)
- Destination download (▷ page 424)

You can reset the selected options to the default settings (▷ page 425).







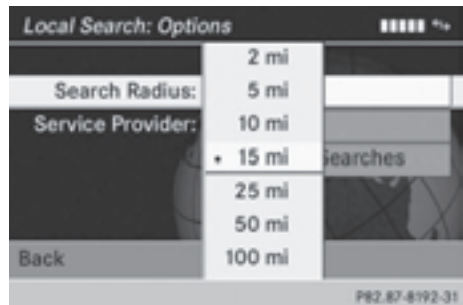
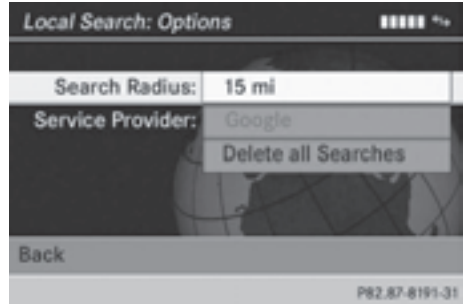

Calling up the options menu

- ▶ Select the  symbol in the main function bar by turning  the COMAND controller and press  to confirm. The carousel view appears.
- ▶ Bring the [Mercedes-Benz Apps](#) panel to the front by turning  the COMAND controller and press  to confirm.
- ▶ Select [Options](#) by sliding  and turning  the COMAND controller and press  to confirm.

Selecting options for the Local Search

Setting the search radius



- ▶ Select [Local Search](#) in the Options menu by turning  the COMAND controller and press  to confirm. The menu shows the current settings.
- ▶ Confirm the entry after [Search radius:](#) by pressing . The  dot indicates the currently selected search radius.
- ▶ Select an entry by turning  the COMAND controller and press  to confirm. The selected setting is accepted.
- ▶ **To exit the menu:** select [Back](#) by turning  the COMAND controller and press  to confirm.

Selecting a service provider

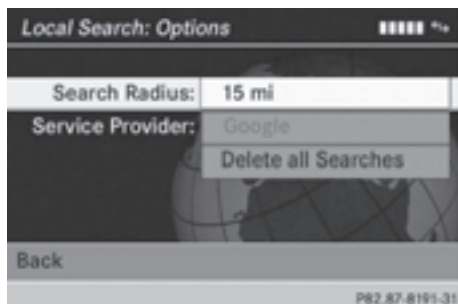

- ▶ Select **Local Search** in the Options menu by turning **Ⓜ** the COMAND controller and press **Ⓜ** to confirm. The menu shows the current settings.
- ▶ Select the entry after **Service provider:** by turning **Ⓜ** the COMAND controller and press **Ⓜ** to confirm. The **•** dot indicates the currently selected service provider.

i If the entry is grayed out, you cannot select the service provider.

- ▶ Select an entry and press **Ⓜ** to confirm. The selected service provider is accepted.
- ▶ **To exit the menu:** select **Back** by turning **Ⓜ** the COMAND controller and press **Ⓜ** to confirm.

Deleting/saving searches

- ▶ Select the **Delete all searches** entry by turning **Ⓜ** the COMAND controller and press **Ⓜ** to confirm. A prompt appears, asking whether you really wish to delete the search.
- ▶ Select **Yes** or **No** and press **Ⓜ** to confirm.

Setting options for destination/route download

Setting the type of import

You can choose between manual and automatic importing.

- ▶ Select the entry after **Import:** by turning **Ⓜ** the COMAND controller and press **Ⓜ** to confirm. The **•** dot indicates the current setting.
- ▶ Select **Manual** or **Automatic** and press **Ⓜ** to confirm. The setting is accepted.
- ▶ **To exit the menu:** select **Back** by turning **Ⓜ** the COMAND controller and press **Ⓜ** to confirm.

Deleting/saving POIs after they have been imported to the server

- ▶ Select the entry after **Import & Delete:** by turning **Ⓜ** the COMAND controller and press **Ⓜ** to confirm. The **•** dot indicates the current setting.
- ▶ Select **Yes** or **No** and press **Ⓜ** to confirm. The setting is accepted. **Yes** deletes the POIs after importing to the server. **No** does not delete the POIs on the server.
- ▶ **To exit the menu:** select **Back** by turning **Ⓜ** the COMAND controller and press **Ⓜ** to confirm.

i Routes and destinations are automatically deleted on the server after seven days.











Conditions of use

You can review the terms of use for the COMAND Mercedes-Benz Apps and Google™.

- ▶ Select **Terms and Conditions** in the options menu by sliding **Ⓜ** the COMAND controller and press **Ⓜ** to confirm (▷ page 423).
- ▶ Select **Mercedes-Benz Apps** or **Google** and press **Ⓜ** to confirm. The respective start page appears.
- ▶ Select **Continue** to view further content.

Resetting adjustments

With the reset function, all Mercedes-Benz Apps settings are reset to the factory settings.

- ▶ Select the  symbol in the main function bar by turning  the COMAND controller and press  to confirm. The carousel view appears.
- ▶ Bring the **Mercedes-Benz Apps** panel to the front by turning  the COMAND controller and press  to confirm.
- ▶ Select **Options** by sliding  and turning  the COMAND controller and press  to confirm.
- ▶ Select **Reset** and press  to confirm. A prompt appears asking whether you really wish to reset.
- ▶ Select **Yes** or **No** and press  to confirm.





Other services

Mercedes-Benz Mobile Website



For individual Mercedes-Benz Apps, it may be necessary to pay license fees before using. Use is then limited to a certain period of time. License fees must be paid again for use beyond this time period.







The COMAND functions include the Mercedes-Benz Mobile Website as a predefined favorite.

- ▶ Select the  icon in the main function bar by turning  the COMAND controller and press  to confirm. The carousel view appears.
 - ▶ Bring the **Mercedes-Benz Mobile Website** panel to the front by turning  the COMAND controller and press  to confirm. The Mercedes-Benz home page appears.
- i** You cannot delete the **Mercedes-Benz Mobile Website** panel.

Further Mercedes-Benz Apps

You can call up additional Mercedes-Benz Apps, such as Facebook, or Google™ services, such as Street View or Panoramio, here. The following examples show how to call up a Mercedes-Benz App, for example Facebook, and generally how to call up Google™ services.

To call up Facebook:

- ▶ Select the  icon in the main function bar by turning  the COMAND controller and press  to confirm. The carousel view appears.
 - ▶ Bring the **Mercedes-Benz Apps** panel to the front by turning  the COMAND controller and pressing  to confirm. The Mercedes-Benz Apps menu is displayed.
 - ▶ Select **Facebook** by turning  the COMAND controller and press  to confirm. The Facebook home page appears.
 - ▶ **To call up Google™ services:** this is done through Google™ Local Search (▷ page 420).
- i** Facebook is a social network. This App allows you to log in from your vehicle and use Facebook's many functions. Google™ Street View allows you to view streets in 360-degree panoramas. Google™ Panoramio expands Google Local Search to include photos at the selected position.

Internet radio

General notes

A good Internet connection is required to transmit audio data efficiently. To ensure the best-possible reception, your mobile phone should be connected to the vehicle's exterior antenna via the phone bracket (optional).

Bear in mind that a relatively large volume of data can be transmitted when using the Internet radio. An average 128 kbit per second data transfer rate can transfer 56 MB of data in one hour.

The data transfer rate of a station is displayed while receiving data.

Calling up the Internet radio



- ▶ Select the icon in the main function bar by sliding and turning the COMAND controller and press to confirm.

The carousel view appears.

- ▶ Bring the **Internet Radio** panel to the front by turning the COMAND controller and press to confirm. The Internet radio menu appears.

Searching for stations

- ▶ Select **Search** in the Internet radio menu. A list with search criteria appears.
- ▶ Select criterion and press to confirm.

i For example as a search criterion, you can set an Internet radio station that is located close to your navigation destination.

Connecting to a station

- ▶ Search for a station (▷ page 426).
- ▶ Select (play) in the Internet radio menu and press to confirm. The call is placed.

If the data stream is interrupted, an automatic attempt is made to re-establish the connection.

Manually re-establishing a connection

- ▶ Select (play) again in the Internet radio menu and press to confirm.

Ending data transfer:

- ▶ Select (stop) in the Internet radio menu and press to confirm.

or

- ▶ Change to another audio source, for example **Disc**.

If you change to a main function that is not an audio source, e.g. navigation, the data connection remains on. You can continue listening to the set station.

Internet



Display restriction

Internet pages cannot be shown while the vehicle is in motion.

Calling up a website

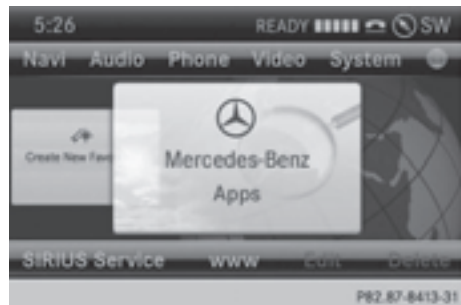
Calling up the carousel view





- ▶ Select the  symbol in the main function bar by turning  the COMAND controller and press  to confirm. The carousel view appears.

You can now enter a web address (option 1 (▷ page 427)) or select it in the carousel view (option 2 (▷ page 428)).

To select in the carousel view, you must first create favorites (▷ page 432).

Option 1: entering the web address

You can enter the web address using either the character bar or the number keypad (▷ page 301).

- ▶ Call up the carousel view (▷ page 426).
- ▶ Select **www** by sliding  and turning  the COMAND controller and press  to confirm. An input menu appears.



- ▶ **To enter using the character bar:** enter the web address in the input line. Character entry (▷ page 299).

As soon as the first letter has been entered in the input line, a list appears below it. The list shows web addresses which begin with the letters you have entered and web addresses which have already been called up.





The list is empty the first time you call it up.



- ▶ **To enter characters using the number pad:** press the number keys in rapid succession.

The character appears when the key is pressed. The first available letter is highlighted. Enter the character using the character bar (▷ page 301).



- ▶ After entering the web address, select the  symbol by turning  or sliding  the COMAND controller and press  to confirm. The website is called up.
- ▶ **To select a web address in the list:** slide  the COMAND controller in the input menu with character bar. The list is activated.



- ▶ Select the web address by turning or sliding the COMAND controller and press to confirm. The web address is entered in the input line.
- ▶ Press the COMAND controller. The website is called up. The **Establishing data connection to <provider name>...** message appears.

Option 2: selecting favorites

You must create at least one favorite in the carousel view for this function (▷ page 432).



- ▶ Call up the carousel view (▷ page 426).
- ▶ In the carousel view, bring a favorite to the front by turning or sliding the COMAND controller and press to confirm. The website is called up.

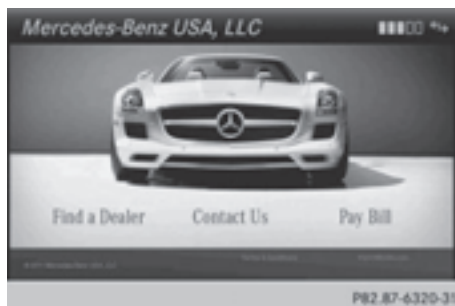

Navigating the website

Overview

Action	Result
<ul style="list-style-type: none"> ▶ Turn the controller. 	Navigates from one item that can be selected (e.g. link, text field or selection list) to the next and highlights the respective element on the website.
Slide the controller: <ul style="list-style-type: none"> ▶ Left or right ▶ Up or down ▶ Diagonally 	Moves the pointer on the page.
<ul style="list-style-type: none"> ▶ Press the controller. 	Calls up the menu or opens the selected item.
<ul style="list-style-type: none"> ▶ Press the BACK button. 	Calls up the previous page.
<ul style="list-style-type: none"> ▶ Press the CLR button. 	Closes the Internet browser. If several windows are open, the current window is closed.

Example: highlighting an item that can be selected



- ▶ Turn $\left[\text{OK} \right]$ the COMAND controller. A button is highlighted in the example.

Example: entering text



- ▶ Select an input line by turning $\left[\text{OK} \right]$ the COMAND controller and press $\left[\text{OK} \right]$ to confirm. The character bar appears.



- ▶ Enter the text using the character bar or the number keypad. Character entry (\triangleright page 299).
- ▶ If the text has been entered, select the $\left[\text{OK} \right]$ symbol by turning $\left[\text{OK} \right]$ the COMAND controller and press $\left[\text{OK} \right]$ to confirm. The text has now been entered.

Menu functions

Calling up the menu



- ▶ **To call up the short menu:** highlight the selectable item on the page by turning $\left[\text{OK} \right]$ the COMAND controller and press $\left[\text{OK} \right]$ to confirm.

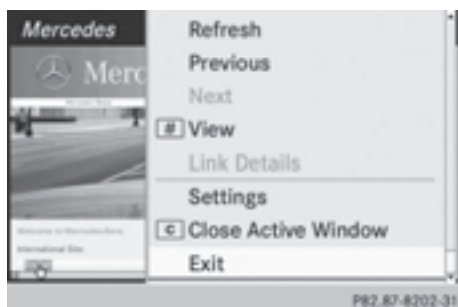
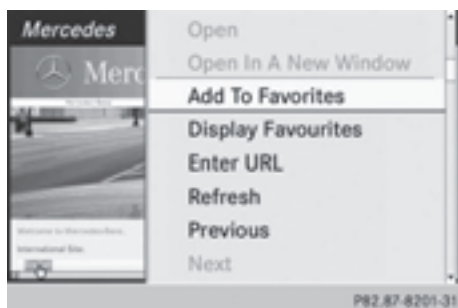

- ▶ **To call up the entire menu:** when the short menu is displayed, slide $\odot \downarrow$ the COMAND controller downwards.

or

- ▶ Select a free area on the website by sliding $\uparrow \odot \downarrow$, $\leftarrow \odot \rightarrow$ or $\curvearrowright \odot \curvearrowleft$ the COMAND controller and press \odot to confirm.

Open

Opens the website to the selectable item.

- ▶ Call up the menu (▷ page 429).
- ▶ Confirm **Open** by pressing \odot the COMAND controller.

Entering a URL

- ▶ Call up the menu (▷ page 429).
- ▶ Select **Enter URL** by turning $\left[\odot \right]$ or sliding $\uparrow \odot \downarrow$ the COMAND controller and press \odot to confirm.
- ▶ Enter a web address (URL) (▷ page 427).

Calling up the previous website

- ▶ Call up the menu (▷ page 429).
- ▶ Select **Previous** by turning $\left[\odot \right]$ or sliding $\uparrow \odot \downarrow$ the COMAND controller and press \odot to confirm.

Calling up the next website

- ▶ Call up the menu (▷ page 429).
- ▶ Select **Next** by turning $\left[\odot \right]$ or sliding $\uparrow \odot \downarrow$ the COMAND controller and press \odot to confirm.

View

You can use this function to:

- position a selection window on websites that are larger than the display
- select a window that is already open
- ▶ Call up the menu (▷ page 429).
- ▶ Select **View** by turning $\left[\odot \right]$ or sliding $\uparrow \odot \downarrow$ the COMAND controller and press \odot to confirm.

or

- ▶ Press the $\left[\# \right]$ key on the number keypad.

- i** You cannot use the $\left[\# \right]$ key if a phone call is being made.

- ▶ **To position the selection window:** confirm **Fullscreen View of Current Page** by pressing \odot the COMAND controller. A selection window appears on the website.
- ▶ Slide $\leftarrow \odot \rightarrow$, $\uparrow \odot \downarrow$ or $\curvearrowright \odot \curvearrowleft$ the COMAND controller and position the selection window on the website.
- ▶ Press \odot the COMAND controller. The selected section is enlarged.
- ▶ **To display and select open windows:** select **Display Open Windows** by turning $\left[\odot \right]$ or sliding $\uparrow \odot \downarrow$ the COMAND controller and press \odot to confirm. The carousel view appears.
- ▶ Press \odot the COMAND controller. The website is displayed.

Exiting the menu

- ▶ Call up the menu (▷ page 429).
- ▶ Select **Exit** by turning **⏻** or sliding **⏻** the COMAND controller and press **⏻** to confirm.
The Internet browser is closed. If other windows are opened in the background, another prompt appears.

Other menu functions

Opening in a new window

You can open up to five windows simultaneously.

- ▶ Call up the menu (▷ page 429).
- ▶ Select **Open In A New Window** by turning **⏻** or sliding **⏻** the COMAND controller and press **⏻** to confirm.
- ▶ **To select a window:** select **View** and press **⏻** to confirm.
- ▶ Select the website in the carousel view by turning **⏻** or sliding **⏻** the COMAND controller and press **⏻** to confirm.

Add To Favorites

Adds the current website to the favorites. The website can then be called up using the carousel view. You can save up to 20 favorites in the carousel view.

- ▶ Call up the menu (▷ page 429).
- ▶ Select **Add To Favorites** by turning **⏻** or sliding **⏻** the COMAND controller and press **⏻** to confirm.
The following message appears: **The page has been added to your favorites.**

Displaying favorites

- ▶ Call up the menu (▷ page 429).
- ▶ Select **Display Favorites** by turning **⏻** or sliding **⏻** the COMAND controller and press **⏻** to confirm.
The favorites are shown in the carousel view.

Further information on favorites (▷ page 431).

Refreshing a website

- ▶ Call up the menu (▷ page 429).
- ▶ Select **Reload** by turning **⏻** or sliding **⏻** the COMAND controller and press **⏻** to confirm.

Closing the active window

- ▶ Call up the menu (▷ page 429).
- ▶ Select **Close Active Window** by turning **⏻** or sliding **⏻** the COMAND controller and press **⏻** to confirm.

or

- ▶ Press the **CLR** button to the right of the COMAND controller.

i You cannot use the **CLR** button if a phone call is being made.

Displaying the complete web address of the selected link

- ▶ Call up the menu (▷ page 429).
- ▶ Select **Link Details** by turning **⏻** or sliding **⏻** the COMAND controller and press **⏻** to confirm.
The URL appears.
- ▶ Press **⏻** the COMAND controller and close the display.

Settings

The settings are described in a separate section (▷ page 433).

Favorites

Introduction

Favorites are frequently visited websites. You have the following options for creating a favorite:

- in the carousel view (▷ page 432)
- via the menu item **Add to Favorites** (▷ page 431)

Before creating a favorite in the carousel view, you must first close active connections (▷ page 417).

You can select and edit favorites that you have created.

Creating favorites

Creating favorites in the carousel view

- ▶ Call up the carousel view (▷ page 426).
- ▶ Bring the **Create New Favorite** panel to the front by turning **⏏** or sliding **←→** the COMAND controller.
- ▶ Press **⏏** the COMAND controller. An input menu appears.



- ▶ Enter the web address (URL) and name using either the character bar or the number keypad. Entering characters (▷ page 299)
- ▶ Select the **ok** icon and press **⏏** to confirm. The favorite has been created.

Adding a favorite via the menu

- ▶ When a website is displayed, call up the menu.
- ▶ Select **Add To Favorites** in the menu and press **⏏** to confirm (▷ page 431).

Selecting favorites

- ▶ Call up the carousel view (▷ page 426).
- ▶ Select the favorite in the carousel view by turning **⏏** or sliding **←→** the COMAND controller and press **⏏** to confirm. The favorite is opened.

Editing favorites

Editing favorites in the carousel view

- ▶ Call up the carousel view (▷ page 426).
- ▶ Select **Edit** by sliding **⏏** and turning **⏏** the COMAND controller and press **⏏** to confirm. An input menu appears.
- ▶ Enter the web address (URL) and name using either the character bar or the number keypad (▷ page 299).

Editing favorites in the Favorites menu

- ▶ Call up the menu (▷ page 429).
- ▶ Select **Display Favorites** by turning **⏏** the COMAND controller and press **⏏** to confirm. The favorite is displayed.
- ▶ Press **⏏** the COMAND controller. The favorites menu appears.
- ▶ Select **Edit** by turning **⏏** or sliding **⏏** the COMAND controller and press **⏏** to confirm.

or

- ▶ Press the **★** button on the number keypad (this function is not available if you are using the telephone at the same time). An input menu appears.
- ▶ Enter the web address (URL) and name using either the character bar or the number keypad. Character entry (▷ page 299).

Other functions in the favorites menu

Opening current favorites

- ▶ Call up the Favorites menu (▷ page 432).
- ▶ Confirm **Open** by pressing **⏏** the COMAND controller.

Opens the current favorites in a new window.

Opening in a new window

- ▶ Call up the Favorites menu (▷ page 432).
- ▶ Select **Open In A New Window** by turning **⏏** or sliding **⏏** the COMAND controller and press **⏏** to confirm.

Calling up details

- ▶ Call up the Favorites menu (▷ page 432).
- ▶ Select **Details** by turning **⏏** or sliding **↑** the COMAND controller and press **⏏** to confirm.

or

- ▶ Press the **#** button on the number keypad (this function is not available if you are using the telephone at the same time). The detailed view appears.

Exiting

- ▶ Call up the Favorites menu (▷ page 432).
- ▶ Select **Exit** by turning **⏏** or sliding **↑** the COMAND controller and press **⏏** to confirm.

or

- ▶ Press the **BACK** back button on the left next to the COMAND controller. The Favorites menu closes.

Deleting favorites

Deleting favorites in the carousel view

- ▶ Call up the carousel view (▷ page 426).
- ▶ Select **Delete** by sliding **⏏** and turning **⏏** the COMAND controller and press **⏏** to confirm. A prompt appears.
- ▶ Select **Yes** and press **⏏** to confirm. The favorite is deleted.

If you select **No**, the process will be canceled.

Deleting favorites in the Favorites menu

- ▶ Select **Delete** by turning **⏏** or sliding **↑** the COMAND controller and press **⏏** to confirm.

or

- ▶ Press the **CLR** button to the right of the COMAND controller. The favorite is deleted.

Settings

Settings menu

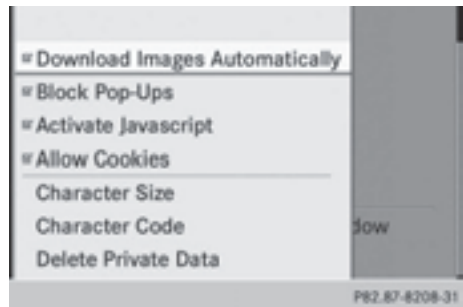

- ▶ Call up the menu (▷ page 429).
- ▶ Select **Settings** by turning **⏏** or sliding **↑** the COMAND controller and press **⏏** to confirm.

You can activate/deactivate the following settings:

- **Download Images Automatically**

It may take some time to download the contents of websites that contain a large amount of images. Therefore, it may be useful to deactivate this option.

- **Block Pop-Ups**

Pop-ups are windows (usually with advertisements) which are displayed automatically when you call up a website. You can block these displays.

- **Activate Javascript**

Javascript makes it possible to display and interact with dynamic content on the website.

- **Allow Cookies**

Some websites save information in small text files (cookies) in COMAND. You can determine whether cookies may be stored.

- **Character Size**

You can select the font size which is used when displaying the website.

- **Character Code**

You can select a different character set here, e.g. if the characters of a website appear distorted.

- **Delete Private Data**

Deletes data which has been saved by the browser during Internet use.

Changing settings

- ▶ Select a setting by turning **⏮** or **⏭** the COMAND controller and press **⏵** to confirm.
Switch the setting on or off .
- ▶ Select **Character Size** or **Character Code** by turning **⏮** or **⏭** or sliding **↑** or **↓** the COMAND controller and press **⏵** to confirm.
- ▶ Select a setting using the COMAND controller and press **⏵** to confirm.

i If you change the settings, the websites may not be displayed correctly.

Delete Private Data

- ▶ Select **Delete Private Data** and press **⏵** to confirm.
A menu appears.

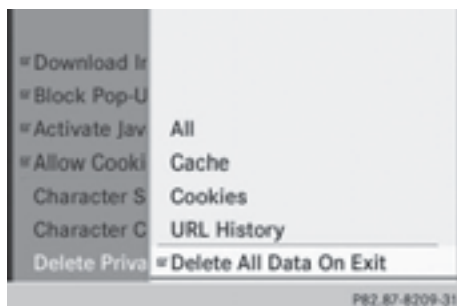

- ▶ Select the setting by turning **⏮** or **⏭** or sliding **↑** or **↓** the COMAND controller and press **⏵** to confirm.

The • dot in front of an entry indicates which setting is active.

or

- ▶ Select **Delete All Data On Exit** and press **⏵** to confirm.
Switch the setting on or off .

Option	Function
All	Deletes all private data.
Cache	Deletes data in the cache.
Cookies	Deletes cookies that are created by websites which you have called up.
URL History	Deletes all websites visited (path).
<input checked="" type="checkbox"/> Delete All Data On Exit	If this function is activated <input checked="" type="checkbox"/> , all private data is deleted when you exit the Internet browser.

i If you reset COMAND to the factory settings (reset function), these settings are deleted (▷ page 311).

Calling up the carousel view and closing the Internet browser

- ▶ **To call up the carousel view:** press the **BACK** back button for longer than two seconds.
- ▶ **To close the Internet browser:** press the **BACK** back button again for longer than two seconds.

Audio

Your COMAND equipment

These operating instructions describe all the standard and optional equipment for your COMAND system, as available at the time of going to print. Country-specific differences are possible. Please note that your COMAND system may not be equipped with all the features described.

Radio mode

Important notes

Portable electronic devices in the vehicle may seriously impair radio reception.

Switching to radio mode

Switching modes using the function button

▶ Press the **RADIO** function button.
The radio display appears. You will hear the last station played on the last waveband.

i Repeatedly pressing this function button switches through the wavebands in this order: FM, AM, WB. You then call up satellite radio mode. Pressing the button again takes you back to FM radio mode.

Switching modes via the audio menu



Example: audio menu

- ① Current audio operating mode
- ② Main function bar
- ③ Audio menu

▶ Select **Audio** in the main function bar by sliding **↑** and turning the COMAND controller and press **⏻** to confirm.
If radio mode was the last mode selected, it will now be active.

If another audio mode is switched on, you can now switch to radio mode in the audio menu.

▶ Select **Audio** by sliding **↑** the COMAND controller and press **⏻** to confirm.
The audio menu appears.



Example: HD Radio display



- ① Display window with station settings
- ② Preset position of the selected station
- ③ Name of the selected station (symbol for HD Radio™ and number of subprogram)
- ④ Frequency of the selected station
- ⑤ Sound settings
- ⑥ FM radio, AM radio or WB radio
- ⑦ Program information
- ⑧ Preset functions
- ⑨ Radio functions

▶ Select **FM/AM Radio** by turning the COMAND controller and press **⏻** to confirm.

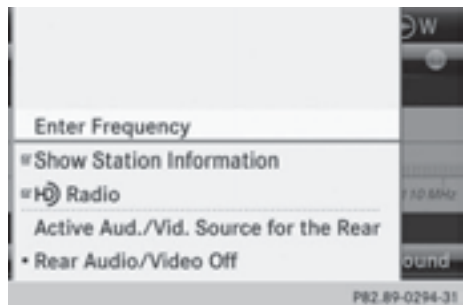
Switching HD Radio on/off



You can switch off HD Radio™ in the radio submenu:

- ▶ Select **Radio** in the radio display by sliding  the COMAND controller and press  to confirm.
- ▶ Select **HD Radio** and press  to confirm.
HD Radio™ on:
HD Radio™ off:

Notes on HD Radio™:

HD Radio™ is a digital radio system from the U.S.A. When HD Radio is off, you will hear only analog programs on all frequencies.

HD Radio™ provides:

- digital transmission on the same wavebands as analog AM/FM. The analog AM/FM stations remain in the same position when selecting a station.
- broadcasting of several program streams over a single FM frequency (e.g. HD1, HD2, etc.).
- clear, interference free reception.
- FM: CD quality sound.
AM: analog FM station sound quality.
- the display of text-based information (e.g. artist, track name) in the display

For further information on HD Radio™, visit <http://www.hdradio.com>.

Switching wavebands

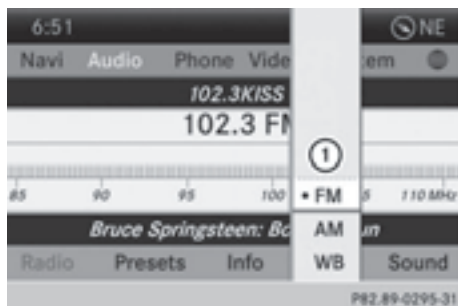

You can switch the radio between the FM, AM and WB wavebands.





① Waveband submenu

- ▶ **Option 1:** press the  function button until the desired waveband is set.

 Repeatedly pressing this function button switches through the wavebands in this order: FM, AM, WB. You then call up satellite radio mode. Pressing the button again takes you back to FM radio mode.

- ▶ **Option 2:** select **FM**, **AM** or **WB** in the radio display by sliding  and turning  the COMAND controller and press  to confirm.



- ▶ The waveband submenu is opened.
- ▶ Select a waveband and press  to confirm. You will hear the last station played on the selected waveband. The  dot shows the currently selected waveband.

Selecting a station

Selects stations via the station search function

- ▶ Press the  or  button.



or

- ▶ Turn  or slide  the COMAND controller while the display/selection window in the radio display is active. Station search scans up or down and stops at the next station found.



Selecting station via the station presets

- ▶ **Quick setting:** press a number key, e.g.

.

- ▶ **Directly in the station presets:** select **Presets** by sliding  and turning  the COMAND controller and press  to confirm.

or

- ▶ When the display/selection window is active, press  the COMAND controller. The station preset memory appears. The  dot indicates under which preset the currently selected station is stored.

- ▶ Select a station by turning **⏪** and pressing **⏩** to confirm or press a number key, e.g. **2**.

Selecting stations by entering the frequency manually

- ▶ **Option 1:** press the **⏪** button.
- ▶ **Option 2:** select **Radio** in the radio display by sliding **⏪** and turning **⏪** the COMAND controller and press **⏩** to confirm.
- ▶ Select **Enter Frequency** and press **⏩** to confirm. Irrespective of the option chosen, an input menu will appear.
- ▶ Enter a frequency using the number keys. COMAND sets the frequency entered.

Waveband	Frequency
AM (MF)	530 - 1700 kHz
FM (VHF)	87.7 - 107.9 MHz
WB (Weather Band)	Weather report channels

- i** You can only enter currently permitted numbers.
- i** If you enter a frequency in the FM or AM wavebands which is outside the frequency range, COMAND sets the next lower frequency.

Storing station

Storing station manually

There are ten presets available for the FM and AM wavebands.

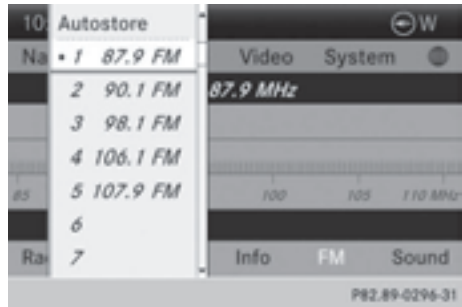

Example: station presets

- ▶ **Quick save:** press and hold a number key, e.g. **2**, until you hear a tone. The station is stored.
- ▶ **Directly in the station presets:** press **⏩** the COMAND controller when the display/selection window is active.
 - or
 - ▶ Select **Presets** by sliding **⏪** and turning **⏪** the COMAND controller and press **⏩** to confirm. In both cases, the station presets appear. The **•** dot indicates under which preset the currently selected station is stored.
 - ▶ Select a preset by turning **⏪** the COMAND controller and press and hold **⏩** until you hear a tone. The station is stored under the preset.

Storing station automatically

This function automatically stores stations with adequate reception under the presets. The search starts at the lowest frequency. COMAND stores any stations found, beginning with preset 1. When the highest frequency is reached or 10 stations have been found, the storing process ends. Any stations stored manually under the presets will be lost. COMAND may not occupy all memory slots when storing.

- ▶ **Option 1:** press **⏩** the COMAND controller when the display/selection window is active. The channel preset memory appears.

- ▶ **Option 2:** select **Presets** by sliding $\odot \downarrow$ and turning $\left\{ \odot \right\}$ the COMAND controller and press \odot to confirm. The channel preset memory appears.
- ▶ Irrespective of the option, select **Autostore** and press \odot to confirm. In both cases, COMAND searches for stations that can be received. You will see a message to this effect. The available stations are automatically stored in the preset positions.
- ▶ **To cancel storing:** select **Cancel** and press \odot to confirm.

Weather Band

Activating

- ▶ Press the **RADIO** function button repeatedly until the Weather Band is switched on.
- or
- ▶ Select the currently set waveband **FM** or **AM** by sliding $\odot \downarrow$ and turning $\left\{ \odot \right\}$ the COMAND controller and press \odot to confirm.
- ▶ Select **WB** from the menu and press \odot to confirm.

Searching for a channel

- ▶ **Quick select:** turn $\left\{ \odot \right\}$ or slide $\leftarrow \odot \rightarrow$ the COMAND controller while the display/selection window is active.
- or
- ▶ Press the **⏪** or **⏩** button. Channel search scans up or down and stops at the next channel found.

Selecting a channel from the channel list

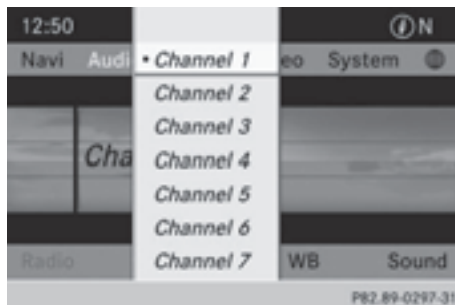

- ▶ Select **Channel 1** by sliding $\odot \downarrow$ and turning $\left\{ \odot \right\}$ the COMAND controller and press \odot to confirm. The channel list appears.
- ▶ Select a channel by turning $\left\{ \odot \right\}$ the COMAND controller and press \odot to confirm.
- or
- ▶ Press a number key on the control panel, e.g. **4**, at any time.

Displaying station information

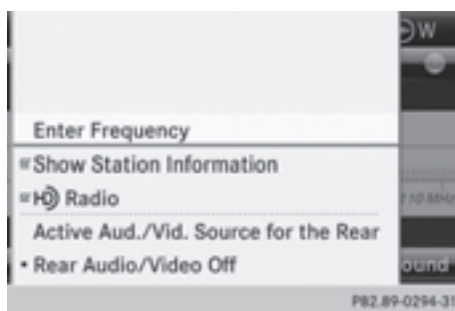

This function is only available for analog FM programs and digital AM/FM programs (HD Radio™).

Information relevant to the current station is shown below the main function bar.

- ▶ Select **Show Station Information** by sliding and turning the COMAND controller and press to confirm. Depending on the previous status, you switch **Show Station Information** on or off .

Displaying program information



This function is only available for analog FM programs and digital AM/FM programs (HD Radio™).

Information relevant to the current station is shown in the display window.

- ▶ Select **Info** in the radio display by sliding and turning the COMAND controller and press to confirm. Information on the currently selected station is displayed. Content is dependent on the station.
- ▶ **To return to the radio display:** confirm **Info** by pressing .
- ▶ Slide the COMAND controller up.

Satellite radio

Important notes

- i** The SatRadio mode described below requires optional satellite radio equipment and registration with a satellite radio provider.
- i** Note that the categories and channels shown in the illustrations depend on the program content offered by the provider.

The program content may vary. The illustrations and descriptions in these operating instructions may therefore differ from the channels and categories offered by the provider.

SatRadio mode may be temporarily unavailable or interrupted for a variety of reasons. These reasons include environmental or topographical conditions as well as other issues beyond the control of Mercedes-Benz USA, LLC. This means operation may not be possible in certain areas.

These include:

- tunnels
- parking garages
- locations inside or next to buildings
- locations in the vicinity of other structures

- i** SIRIUS XM Radio offers more than 130 radio stations in digital quality, for example 100% commercial-free music, sports, news and entertainment.

SIRIUS XM Radio employs a fleet of high-performance satellites to broadcast around the clock in the contiguous USA and Canada.

The satellite radio program is available for a monthly fee. Details are available from the SIRIUS XM Service Center and at

http://www.sirius.com (USA) or **http://www.siriuscanada.com** (Canada).

Registering SatRadio



Service information screen

- ① Provider's phone number (SIRIUS XM)
 - ② SIRIUS XM ID of your satellite receiver
- ▶ Switch on SatRadio mode (▷ page 440). The satellite radio main menu appears, showing the weather channel. You cannot select any other stations.
 - ▶ In the lower menu line, select **Sat** and press to confirm.
 - ▶ Select **Service** and press to confirm. The service information screen appears.

Once the connection has been established:

- ▶ Follow the instructions of the service staff. The activation process may take up to ten minutes. If the activation is completed successfully, the **No Service** message appears in the display, followed by the satellite radio main menu.

i You can also have the satellite service activated online. To do so, visit the SIRIUS XM Radio website at

<http://www.sirius.com> (USA) or

<http://www.siriuscanada.com> (Canada).

i If registration is not included when purchasing the system, your credit card details will be required to activate your account. If the satellite receiver is not installed or is not installed correctly, the **Device Unavailable** message will appear.

Switching on satellite radio mode

Notes

For example, to select a channel or scroll in the lists, you can also use the buttons on the multifunction steering wheel, see the separate vehicle Operator's Manual.

Important information on registering the satellite radio (▷ page 440).

Option 1

- ▶ Press the function button. The **No Service** message appears after switching on or if no signal is being received. Once COMAND receives the signal, the satellite radio display appears. The station last selected is played.

i Repeatedly pressing this function button switches through the wavebands in this order: FM, AM, WB and subsequently switches on the satellite radio. Pressing the button again takes you back to FM radio mode.

Option 2:

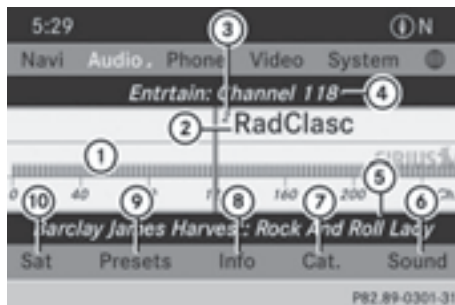

Satellite radio main menu

- ① Satellite radio main display
- ② Channel name
- ③ Preset
- ④ Selected category/channel number
- ⑤ Channel information (in brief)
- ⑥ Sound settings
- ⑦ Category list
- ⑧ Channel information (in detail)

- ⑨ Channel preset list
- ⑩ Satellite radio menu

Channel information ⑤ can be viewed in detail (▷ page 443).

- ▶ Select **Audio** in the main function bar by sliding ↑⊙ and turning Ⓚ the COMAND controller and press ⊙ to confirm. If satellite radio mode was the last mode selected, it will now be active. If another audio mode is switched on, you can now switch to satellite radio mode in the audio menu.
- ▶ Select **Audio** by sliding ↑⊙ the COMAND controller and press ⊙ to confirm. The audio menu appears.
- ▶ Select **Sat** and press ⊙ to confirm.

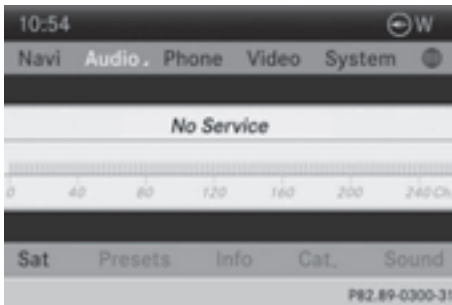

The **No Service** message appears when starting up or if no signal is being received. If the satellite receiver is not installed or is not installed correctly, the **Device Unavailable** message will appear.

Changing the category

Satellite radio channels are sorted into various categories. You can choose between various categories such as News/Discussions, Sports and Country (if available). The category list is sorted alphabetically.

- ▶ **To call up the category list:** select **Category** by turning Ⓚ the COMAND controller and press ⊙ to confirm. The category list appears.

- ▶ **To select a category:** select a category by turning Ⓚ the COMAND controller and press ⊙ to confirm. The category selected is shown in the display. You hear the station last selected for this category.

The **All Channels** category is at the top of the category list. This category is sorted by channel number and allows you to browse all available channels.

Selecting a channel

Channel search

- ▶ Turn Ⓚ or slide ←⊙→ the COMAND controller while the display/selection window in the SatRadio display is active.

or

- ▶ Press the ⏪ or ⏩ button. COMAND searches in both directions (ascending and descending) and stops at the next channel found in the selected category.

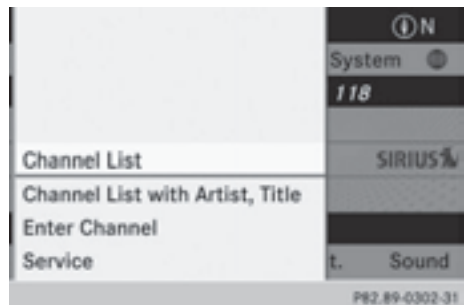

Satellite radio menu

- ▶ Select **Sat** in the submenu bar by turning Ⓚ the COMAND controller and press ⊙ to confirm. The satellite radio menu appears.

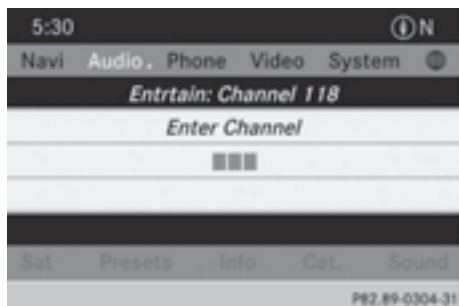

Entering channel numbers directly

- ▶ **Option 1:** press the button. An input menu appears.
- ▶ **Option 2:** select **Sat** in the submenu bar by turning $\left(\odot\right)$ the COMAND controller and press $\left(\odot\right)$ to confirm.
- ▶ Select **Enter Channel** and press $\left(\odot\right)$ to confirm. An input menu appears.

Entering the channel

- ▶ With both options, press the corresponding number buttons on the control unit in succession. COMAND sets the selected channel.

i You can only select currently permitted digits.

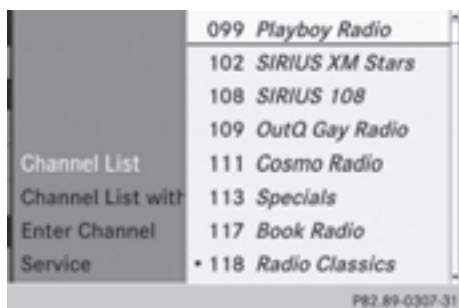

Selecting a channel from the SatRadio channel list

You can select the channel from the channel list (option 1) or via the channel list that shows the artists and tracks that are currently being played (option 2).

- ▶ Select **Sat** in the submenu bar by turning $\left(\odot\right)$ the COMAND controller and press $\left(\odot\right)$ to confirm.

Option 1

- ▶ Select **Channel List** and press $\left(\odot\right)$ to confirm. The channel list appears.
- ▶ Select a channel by turning $\left(\odot\right)$ the COMAND controller and press $\left(\odot\right)$ to confirm.

Option 2:

- ▶ Select **Channel List with Artist, Title** and press $\left(\odot\right)$ to confirm. The channel list appears and displays the artists and tracks currently being played.



- ▶ Select a channel by turning $\left(\odot\right)$ the COMAND controller and press $\left(\odot\right)$ to confirm.



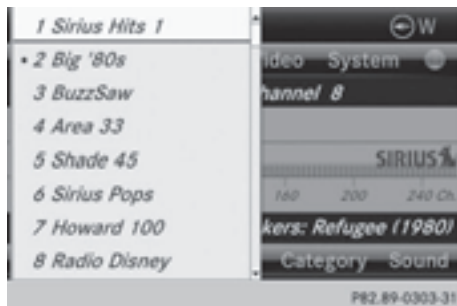



Memory functions



Channel presets









There are ten presets available.

Storing channels





- ▶ Press  the COMAND controller when the display/selection window is active.
- or
- ▶ Select **Presets** in the submenu bar by turning  the COMAND controller and press  to confirm.
In both cases, the channel presets appear. The  dot in front of a preset entry indicates that the currently selected channel is stored under this preset.
- ▶ Select a preset by turning  the COMAND controller and press and hold  until you hear a tone.
- or
- ▶ Press and hold a number button, e.g. , until you hear a tone.
The channel is stored under the preset.

Storing channels automatically

This function automatically stores channels with adequate reception in the preset memory. Channels stored manually in the preset memory will be overwritten.





- ▶ **Option 1:** press  the COMAND controller when the display/selection window is active.
- ▶ Select **Autostore** in the presets by turning  the COMAND controller and press  to confirm.
- ▶ **Option 2:** select **Presets** in the submenu bar by sliding  and turning  the COMAND controller and press  to confirm.
- ▶ Select **Autostore** and press  to confirm. In both cases, COMAND searches for channels that can be received. You will see a message to this effect. The available channels are automatically stored in the preset positions.
- ▶ **To cancel storing:** select **Cancel** and press  to confirm.

Selecting a channel from the preset list

- ▶ **To call up the preset list:** select **Presets** by turning  the COMAND controller and press  to confirm.
The channel preset list appears.
- ▶ **To set a channel:** select a preset by turning  the COMAND controller and press  to confirm.
- or
- ▶ Press a number key, such as .

Displaying information



- ▶ Select **Info** in the submenu bar by turning  the COMAND controller and press  to confirm.
Information on the currently received program is displayed.
- If available, you will see:
 - the full channel name
 - the artist of the track that is currently being played
 - the track that is currently being played
- ▶ **To return to the radio display:** confirm **Info** by pressing .
- ▶ Slide  the COMAND controller up.

Displaying service information



- ① Provider's phone number (SIRIUS XM) or [Call Service Provider](#)
- ② SIRIUS ID of your satellite receiver

The provider's customer service center is available by phone at any time to answer any general questions or questions on the versions available.

- ▶ Select **Sat Radio** in the submenu bar by turning the COMAND controller and press to confirm.
- ▶ Select **Service** and press to confirm. The provider's details appear.
- ▶ **To return to the SatRadio main display:** slide the COMAND controller.

Channel list updates

When receiving a new channel list, the display shows the [Updating Channels...](#) message.

The station last selected is switched to mute until the update has been completed. SatRadio mode is not available during this process.

Once the update has been completed, the SatRadio basic menu appears. The station last selected is played.

Sound settings

Information on sound settings (> page 296).

Audio CD and MP3 mode

Important safety notes

WARNING

The CD/DVD drive is a class 1 laser product. If you open the housing of the CD/DVD drive, there is a risk of exposure to invisible laser radiation. This laser radiation could damage your retina. There is a risk of injury.

Never open the housing. Always have maintenance and repair work carried out at a qualified specialist workshop.

WARNING

Handling discs while driving may distract you from traffic conditions. You could also lose control of the vehicle. There is a risk of an accident.

Handle discs only when the vehicle is stationary.

Bear in mind that at a speed of only 30 mph (approximately 50 km/h), your vehicle covers a distance of 44 feet (approximately 14 m) every second.

WARNING

SD memory cards are small parts. They can be swallowed and cause asphyxiation. This poses an increased risk of injury or even fatal injury.

Keep SD memory cards out of the reach of children. If an SD memory card is swallowed, seek immediate medical attention.

Inserting/ejecting CDs/DVDs

Notes

If the CD/DVD has a printed side, this must face upwards when the CD/DVD is inserted. If neither side is printed, the side to be played should face downwards. CDs/DVDs with copy protection may not be able to be played by the system.

- i** If a medium contains other files in addition to music files, the loading time before the first track starts to play may be longer.

Inserting

- ▶ Press the  button.
If there is a disc already inserted, it will be ejected.
- ▶ Take the disc out of the slot.
- ▶ Insert a disc into the slot.
When a suitable data carrier is correctly inserted, the drive draws it in and plays it.

Removing

- ▶ Press the  button.
- ▶ Take the disc out of the slot.
If you do not take the disc out of the slot, it is drawn in again automatically after a short while and reloaded.

Inserting and ejecting an SD memory card

General information

COMAND supports SD memory cards (**S**ecure **D**igital), SDHC memory cards (**S**ecure **D**igital **H**igh **C**apacity) and SDXC memory cards (**S**ecure **D**igital **eX**tended **C**apacity).

- i** Not all memory cards available on the market are designed for the temperatures which may be reached in the vehicle.
If the SD memory card is no longer in use, you should remove it from COMAND. High temperatures can damage the card.
Due to the wide range of SD memory cards available on the market, playback cannot be guaranteed for all brands of SD memory card.
The readable storage capacity depends on the memory card used. You can obtain further information at any authorized Mercedes-Benz Center.

Inserting an SD memory card

- ▶ Insert the memory card into the slot on the control panel until it engages in place. The side with the contacts must face downwards and point towards the slot.
If no MP3 tracks can be found, you will see a message to this effect.
The first 100 MP3 tracks are loaded. The first MP3 track is then played. Further tracks are loaded in the background; this is indicated by an hourglass symbol.

Ejecting an SD memory card

- ▶ Press the memory card.
The memory card is ejected.
- ▶ Remove the memory card from slot.

Connecting a USB device

The USB port is located in the stowage compartment in the center console.

Electrical consumption at this connection must not exceed a continuous current of 500 mA. If the electrical consumption is higher, use a separate source to provide power for the USB device (e.g. 12 V power supply).

- ▶ Connect the USB device (e.g. USB stick) to the USB port.
If no MP3 tracks can be found, you will see a message to this effect.
The first 100 MP3 tracks are loaded. The first MP3 track is then played. Further tracks are loaded in the background; this is indicated by an hourglass symbol.
- i** Due to the wide range of USB devices available on the market, playback cannot be guaranteed for all brands of USB device.
Information about suitable USB devices can be obtained from an authorized Mercedes-Benz Center.
MP3 players must support Media Transfer Protocol (MTP). The MTP mode must be active.

Switching to audio CD or MP3 mode

Inserting or connecting a medium

- ▶ Insert CDs (▷ page 444)
- or
- ▶ Insert an SD memory card (▷ page 445)
- or
- ▶ Connect a USB device (▷ page 445).
COMAND loads the medium inserted and starts to play it.

Switching on using the button

- ▶ Press the **DISC** button one or more times.

By pressing the **DISC** button repeatedly, you can switch modes in the following order:

-
- CD/video DVD/MP3 CD/MP3 DVD in the single DVD drive (disc mode)
- Memory card mode
- MUSIC REGISTER
- USB storage device
- Media Interface or audio AUX mode
- Bluetooth® audio mode
- ▶ Select an audio medium from the media list (▷ page 447).

Switching modes via the audio menu

- ▶ Select **Audio** in the main function bar by sliding **↑** and turning **⌂** the COMAND controller and press **⏵** to confirm.
The last active audio source is now activated.
You can activate a different audio source using the audio menu.
- ▶ Select **Audio** by sliding **↑** and turning **⌂** the COMAND controller and press **⏵** to confirm.
The audio menu appears.
- ▶ Select **Disc**, **Memory Card**, **Music Register**, **USB storage** or **Media Interface** and press **⏵** to confirm.
This switches to the desired audio source.

- ▶ Select an audio medium from the media list (▷ page 447).

Example display: audio CD mode



- ① CD cover (if available)
- ② Gracenote® media data found, then the elapsed track time
- ③ Track number and track name (if stored on the disc as CD text or if Gracenote® data is available)
- ④ Graphic time and track display
- ⑤ Disc type, disc position in the media list and disc name (if stored on the disc as CD text or if Gracenote® data is available)
- ⑥ Artist (if stored on the disc as CD text or if Gracenote® data is available)
- ⑦ CD mode menu

Example display: MP3 mode





- ① Cover (if available)
- ② Track time
- ③ Track number and name
- ④ Graphic time and track display

- ⑤ Medium type, position of medium in the media list, current folder or current album
- ⑥ Artist (if available)
- ⑦ MP3 mode menu

Pause function

CD and MP3 mode

► **To pause playback:** briefly press the  button.





The  symbol appears at the top left in the status bar.

► **To continue playback:** briefly press the  button again.

The  symbol disappears.

Selecting a CD or MP3 disc



Selecting via the media list

► **In CD and MP3 mode:** select **Media** using the COMAND controller  (slide) and  (turn) and confirm with . The media list appears. The  dot indicates the current medium being played.



Media list

The media list shows the discs currently available.

► Select the data medium by turning  the COMAND controller and press  to confirm.

Positions in the media list

Single DVD drive, position 1: readable data media are audio CDs, MP3 CDs or MP3 DVDs and video DVDs

Memory card, position 2

MUSIC REGISTER, position 3

USB storage device, position 4

Media Interface, position 5

Bluetooth® audio: position 6

 If a disc cannot be read, an entry appears next to the corresponding magazine tray.

 If you select a video DVD, the system switches to video DVD mode (▷ page 473).

Selecting a track using the number keypad



► When the display/selection window is active, press a number key, e.g. . The medium at the corresponding position in the media list is loaded and then played.

Selecting a track

Selecting by skipping to a track

► **To skip forwards or back to a track:** turn  the COMAND controller when the display/selection window is active.

or

► Press the  or  button. The skip forward function skips to the next track.

The skip back function skips to the beginning of the current track if the track has been playing for more than 8 seconds. If the track has been playing for less than 8 seconds, it skips to the start of the previous track.

If the **Random Tracks** or **Random Folder** playback option has been selected, the track order is random.

Selecting a track using the number keypad

- ▶ Press the  key on the number keypad. A numerical entry field appears. The number of positions offered corresponds to the number of tracks on the CD. Only numbers that correspond to a track number on the CD can be entered.
- ▶ Enter the desired track number using the number keys. The track plays after the last possible number is entered.
- ❗ Pressing and holding a number key for more than 2 seconds completes the entry, and the corresponding track is played.

Selecting a track using music search



- ▶ Select **Current Tracklist**, **Folder** or a category and press  to confirm.

Select music via categories (e.g. album, artist) with the music search function.



If you select a category, COMAND starts a search for track information if the following conditions are fulfilled:

- the data carriers are inserted or connected
- the track information from these data carriers is not yet contained in the COMAND music database.

COMAND imports track information from the following data carriers:



- Disc (CD/MP3)
- Memory card
- MUSIC REGISTER
- USB storage device

The **Track information is complete** message appears once the search is completed. COMAND stores the music data in its own database. You can now select the available music data within the desired category. You will find further information on searching for music in the "Music search" section ([▶ page 452](#)).

- ▶ In audio CD or MP3 mode, select **Search** by sliding  and turning  the COMAND controller and then press  to confirm. The category list appears.





Example: current track list

- ▶ Select the track by turning  the COMAND controller and press  to confirm. The basic display appears and the track is played.

Fast forwarding/rewinding

- ▶ While the display/selection window is active, slide  and hold the COMAND controller until the desired position has been reached.

or

- ▶ Press and hold the  or  button until the desired position is reached.

Gracenote® Media Database

Introduction

This function is only available in audio CD mode.



There is a version of Gracenote® music recognition technology on the COMAND hard drive. You will recognize this by the logo which can be seen in the bottom right-hand corner of certain audio displays.

Many audio CDs contain CD text. COMAND uses the information contained therein to display the artist, album and track name.

If the audio CD does not contain any CD text information, COMAND can use the Gracenote® Media Database to identify unknown audio tracks when in audio CD mode. This is only possible if the relevant information is saved in the Gracenote® Media Database and if the "Gracenote Media Database" function is activated.

If this is the case, COMAND will display the corresponding data such as artist, album and track name in the relevant displays and lists.

Selecting Gracenote® data to be displayed

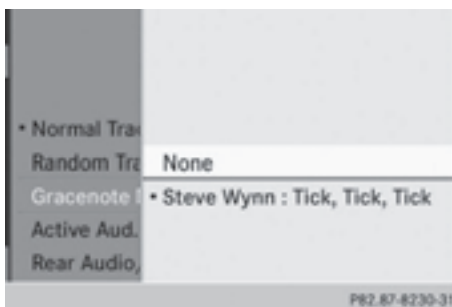

- ▶ Switch on CD mode (▷ page 446).
- ▶ Select **CD** by sliding and turning the COMAND controller and press to confirm.
- ▶ Select **Gracenote Media Database** by turning the COMAND controller and press to confirm.

A menu appears.
The **•** dot indicates the current selection for the display.

If several entries exist for the CD of a particular artist, you can select which of the entries should be shown.

If the inserted CD does not contain any Gracenote® data, the **Gracenote Media Database** menu item is shown in grey and cannot be selected.

- ▶ Select an entry by turning the COMAND controller and press to confirm.

Switching the Gracenote® data display on/off

- ▶ Switch on CD mode (▷ page 446).
- ▶ Select **CD** by sliding and turning the COMAND controller and press to confirm.
- ▶ Select **Gracenote Media Database** by turning the COMAND controller and press to confirm.
- ▶ **To switch off the display:** select **None** and press to confirm.
In the basic display, **Track 1, Track 2** etc. are shown instead of the Gracenote® data, for example (▷ page 446).
- ▶ **To switch on the display:** select an entry in the menu by turning the COMAND controller and press to confirm.

Updating Gracenote® music recognition technology and the Gracenote Media Database

Due to the release of new CDs, the digital data on the Gracenote Media Database must be updated. Optimum functionality can only be

attained with up-to-date Gracenote® music recognition technology. Information about new versions can be obtained from an authorized Mercedes-Benz Center.

You can have your music recognition software updated there with a DVD, or you can update it yourself.

- i** The Gracenote Media Database is updated in conjunction with the navigation system's digital map (▷ page 375).





Displaying the track and album

- ▶ Press the  button.
The current track and album are displayed in a window.

Displaying metadata (MP3 mode)





COMAND can also display the album name and artist (metadata) during playback if this information has been entered into the system.

For all media that contain MP3 data (e.g. MP3 CD, SD memory card, MUSIC REGISTER), you can determine whether:





- the metadata contained in the tags of the encoded music data should be displayed
- the file and directory names should be displayed during playback
- ▶ **To display the album and artist name:**
select **MP3** or **USB** in the basic display by sliding  and turning  the COMAND controller and press  to confirm.
- ▶ Select **Display Track Information** and press  to confirm.

Selecting an active partition (USB mass storage devices only)

You can select this function for USB mass storage devices when the storage device is partitioned. Up to 5 partitions (primary or logical, FAT, FAT32 and NTFS) are supported.

- ▶ Select **MP3** in the basic display by sliding  and turning  the COMAND controller and press  to confirm.
- ▶ Select **Select Active Partition** and press  to confirm.

Playback options

- ▶ **To select options:** switch on audio CD or MP3 mode (▷ page 446).
- ▶ Select **CD** or **MP3** mode by sliding  and turning  the COMAND controller and then pressing  to confirm.
The options list appears. The • dot indicates the option selected.
- ▶ Select an option by turning  and press  to confirm.
The option is switched on. For all options except **Normal Track Sequence**, you will see a corresponding display in the display/selection window.

The following options are available to you:

- **Normal Track Sequence**

The tracks are played in the normal order (e.g. track 1, 2, 3, etc.).

In MP3 mode, the track order is determined by the order in which the tracks are written to the MP3 data carrier when it is created. Alphabetical order is the most common. Once all the tracks in a folder have been played, the tracks in the next folder are played.

- **Random Medium**

All the tracks on the medium are played in random order (e.g. track 3, 8, 5 etc.).

- **Random Track List** (MP3 mode only)

You will hear the tracks in the current playlist or currently active folder (including all subfolders) in random order.

- i** The **Normal Track Sequence** option is automatically selected when you change the disc you are currently listening to or when you select a different medium. If an option is selected, it remains selected after COMAND is switched on or off.

Notes on MP3 mode

General notes

Depending on the volume and format of the MP3 data, the length of time required for reading the data may increase.

Permissible data carriers

- CD-R and CD-RW
- DVD-R and DVD-RW
- DVD+R and DVD+RW
- SD memory card
- USB storage device

Permissible file systems

- ISO 9660/Joliet standard for CDs
- UDF for video DVDs
- FAT16, FAT32 and NTFS for SD memory card and USB storage media

Multisession CDs

For multisession CDs, the content of the first session determines how COMAND will process the CD. COMAND plays only one session and gives priority to the audio CD session. If possible, use COMAND to play only CDs that have been written in one session.

File structure of a data carrier

When you create a disc with compressed music files, the tracks can be organized in folders. A folder may also contain subfolders. The disc may contain no more than eight directory levels. Files beyond the eighth level will not be recognized by the system.

- ❗ COMAND loads up to 15,000 tracks from an SD memory card or USB storage medium.

Track and file names

When you create a disc with compressed music files, you can assign names to the tracks and folders.

COMAND uses these names accordingly for the display. Folders that contain data other than MP3 or WMA tracks are not displayed by COMAND.

If MP3 or WMA files are stored in the root directory itself, the root directory will also be treated as a folder. COMAND will then show the name of the root directory as the folder name.

You should observe the following when assigning track names:

- track names must have at least one character.
- track names must have the extension "mp3" or "wma".
- there must be a dot between the track name and the extension.

Example of a correct track name:
"Track 1.mp3".

Permissible formats

COMAND supports the following formats:

- MPEG1 Audio Layer 3 (MP3)
- Microsoft Windows Media Audio V8 and V9 (WMA) without copy protection
Microsoft Windows Media Audio V2, V7, V8 and V9 (WMA)
- additional music files in AAC format with the file extensions .aac, .mp4, .m4a and .m4b, but not copy-protected iTunes music files with the extension .m4p.

- ❗ If, in addition to MP3 files, there are other music files in these audio formats stored on the disc, the loading process may require a longer time before the first track is played.

- ❗ The MP3 audio encoding method is under license from Fraunhofer IIS (Institut Integrierte Schaltungen – Institute for Integrated Circuits) and Thomson.

Permissible bit and sampling rates

COMAND supports **MP3** files of the following types:

- fixed and variable bit rates from 32 kbit/s to 320 kbit/s
- sampling rates of 8 kHz to 48 kHz

COMAND supports **WMA** files of the following types:

- fixed bit rates from 5 kbit/s to 384 kbit/s
- sampling rates of 8 kHz to 48 kHz

COMAND does **not** support **WMA** files of the following types:

- DRM (Digital Rights Management) encrypted files
- variable bit rate
- WMA Pro
- 5.1 surround sound

i Only use tracks with a bit rate of at least 128 kbit/s and a sampling rate of at least 44.1 kHz. Lower rates can cause a noticeable deterioration in quality. This is especially the case if you have activated a surround sound function.

Notes on copyright

MP3 or WMA tracks that you create or play back are generally subject to copyright protection in accordance with the applicable international and national regulations.

In many countries, reproductions, even for private use, are not permitted without the prior consent of the copyright holder.

Make sure that you know about the applicable copyright regulations and that you comply with these.

If you own these rights yourself, e.g. for your own compositions and recordings, or if the copyright holder has granted you permission, these restrictions do not apply.

Notes on CDs/DVDs

i COMAND is designed to play discs that comply with the EN 60908 standard. Therefore, you can only use discs with a maximum thickness of 1.3 mm.

If you insert thicker discs, e.g. those that contain data on both sides (DVD on one side and audio data on the other), they cannot be ejected and can damage the device.

Only use round discs with a diameter of 12 cm. Do not use discs with a diameter of 8 cm, even with an adapter.

Discs with copy protection are not compatible with the audio CD standard and therefore may not be able to be played by COMAND.

Playback problems may occur when playing copied discs. There is a wide range of data carriers, disc-writing software and writers available. This variety means that there is no guarantee that the system will be able to play discs that you have copied yourself.

There may be playback problems if you play CDs that you have copied yourself with a storage capacity of more than 700 MB. CDs of this type do not conform to the currently applicable standards.

i COMAND is able to play back audio CDs in multichannel audio format.

Music search

Calling up a category list



Category list

- ▶ Switch on an audio source and call up the basic display, e.g. MP3 mode (▷ page 446).
- ▶ Select **Search** by sliding **⊙** and turning **⌂** the COMAND controller and press **⊙** to confirm.

The category list appears.

The categories are displayed according to the data available. The categories **Current Tracklist**, **Folder**, **Playlists** (if available) and **Photos** (if available) are already

assigned. The other available categories are filled by the music search.

Selecting a category

Starting a music search

Select music via categories (e.g. album, artist) with the music search function.

If you select a category, COMAND starts a music search under the following conditions:

- the data carriers are inserted or connected.
- the music tracks on these data carriers are not yet in the COMAND music database.

COMAND reads music tracks from the following data carriers:

- Disc (CD/MP3)
- Memory card
- MUSIC REGISTER
- USB storage device



- ▶ Select a category in the category list by turning **⏻** the COMAND controller and press **⏻** to confirm. The **Reading Data...** message appears. The search may take some time, depending on the number of tracks available.

The **Track information is complete** message appears once the search is completed. Playback then starts with the previously active audio source.

- ▶ **To cancel the music search:** confirm **Cancel** by pressing **⏻**.

Selecting artists

- ▶ Select **Artists** in the category list by turning **⏻** the COMAND controller and press **⏻** to confirm. The available artists are displayed alphabetically.

Selecting an album

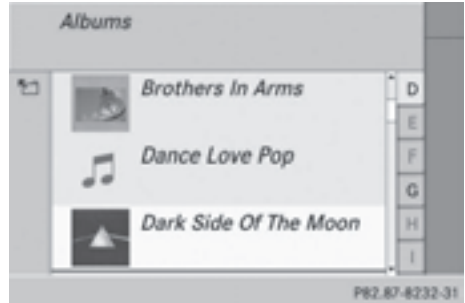

- ▶ Select **Albums** in the category list by turning **⏻** the COMAND controller and press **⏻** to confirm. The available albums are displayed alphabetically. If there is a cover available for an album, it is displayed in front of the album name.

Selecting a track



- ▶ Select **Tracks** in the category list (▷ page 452) by turning **⏻** the COMAND controller and press **⏻** to confirm. The available tracks are displayed.

Selecting a year of publication



- ▶ Select **Year** in the category list (▷ page 452) by turning **⏪** the COMAND controller and press **⏩** to confirm.
- ▶ Select an entry and press **⏩** to confirm. The genre list is displayed.
- ▶ Select a genre, e.g. pop, and press **⏩** to confirm. The track list is displayed.
- ▶ Select a track and press **⏩** to confirm. Playback starts.

Selecting composers

- ▶ Select **Composers** in the category list by turning **⏪** the COMAND controller and press **⏩** to confirm. The available composers are displayed alphabetically.

Selecting music genres

- ▶ Select **Genres** in the category list by turning **⏪** the COMAND controller and press **⏩** to confirm. The available music genres are displayed alphabetically.

Selecting a cover

- ▶ Select **Select By Cover** in the category list (▷ page 452) by turning **⏪** the COMAND controller and press **⏩** to confirm. The available covers are displayed in alphabetical order of the artists.

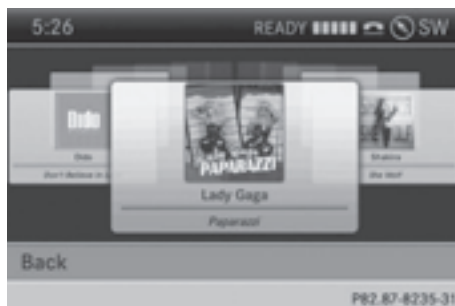

- ▶ Select the desired cover by turning **⏪** the COMAND controller and press **⏩** to confirm. The corresponding album is played.

Selecting via keyword search

- ▶ Select **Keyword Search** in the category list by turning **⏪** the COMAND controller and press **⏩** to confirm. An input menu appears.



- ▶ **To change the character set used in the character bar:** highlight **Select** by sliding **⏪** and turning **⏪** the COMAND controller and press **⏩** to confirm. A list of available character sets is shown.
- ▶ Select the desired character set and press **⏩** to confirm.
- ▶ Enter characters and confirm the entry. Character entry (▷ page 299). Depending on the entry, the hits are shown in a list.



- ▶ Select an entry by turning **⏪** the COMAND controller and press **⏩** to confirm.



- ▶ Select a track and press **⏩** to confirm. Playback starts and the basic display appears.



- ▶ Select an entry, e.g. **Artists**, and press **⏩** to confirm. The album and cover (if available) are displayed.



- ▶ Confirm the album with **⏩**. The tracks on the album are displayed.

MUSIC REGISTER

General notes

- ! Retain the original music files in a secure location. An error in COMAND might result in the loss of the music files stored in the MUSIC REGISTER. Mercedes-Benz is not liable for any loss of data.

You can store music files in a compressed format in the MUSIC REGISTER (▷ page 456). The memory has a capacity of 10 GB.

Switching to the MUSIC REGISTER

MUSIC REGISTER basic display



Example: MUSIC REGISTER

- ① Cover (if available)
- ② Track time
- ③ Track number and name

- ④ Graphic time and track display
- ⑤ Position of the medium in the media list and name of the medium, followed by the current playback option (no display for **Normal Track Sequence**)
- ⑥ Artist
- ⑦ MUSIC REGISTER menu bar

Switching on using the DISC button

- ▶ Press the **[Disc]** button repeatedly until the MUSIC REGISTER is switched on.

By pressing the **[Disc]** button repeatedly, you can switch modes in the following order:

- CD/MP3 (disc)
- Memory card mode
- MUSIC REGISTER
- USB storage device
- Media Interface or audio AUX mode
- Bluetooth® audio mode

If music files are available, playback begins at the point last listened to.

If there are no music files, you will see a message to this effect.

- ▶ Confirm the message by pressing **[OK]** and store the music data (▷ page 456).

Switching modes via the audio menu

- ▶ Select **Audio** in the main function bar by sliding **[Left]** and turning **[Right]** the COMAND controller and press **[OK]** to confirm.

If MUSIC REGISTER was the last mode selected, it is now switched on.

If another audio source is switched on, you can now switch on the MUSIC REGISTER in the audio menu.

- ▶ Select **Audio** by sliding **[Left]** and turning **[Right]** the COMAND controller and press **[OK]** to confirm.
The audio menu appears.
- ▶ Select **Music Register** and press **[OK]** to confirm.

Switching on with the number buttons

- ▶ Make sure that neither radio nor disc is activated.
- ▶ Press the **[3 Disc]** number key.
The MUSIC REGISTER is switched on.

Importing music files

Introduction

You can import music files from a CD in the following file formats:

- MP3
- WMA
- AAC (with file extensions .m4p, .m4a, .m4b and .aac)
- ▶ Switch on CD mode (▷ page 446).
- ▶ With an audio CD inserted, select **REC** in the basic CD display by sliding **[Left]** and turning **[Right]** the COMAND controller and press **[OK]** to confirm.

- ① CD information such as album name, disc name, artist and track is provided by the Gracenote Media Database (▷ page 448).

Step 1: selecting tracks to import



- ① To record all music files (standard)
- ② To copy single tracks
- ③ Confirming your selection

- ▶ Select the **Track** by turning **[Right]** the COMAND controller and pressing **[OK]** to confirm.
- ▶ Select **Continue** by turning **[Right]** the COMAND controller and press **[OK]** to confirm.

If you do not select any tracks, every track on the CD will be imported.

Step 2: selecting the target folder

- ▶ Select **Folder** by turning **[⏪]** the COMAND controller and press **[⏩]** to confirm.

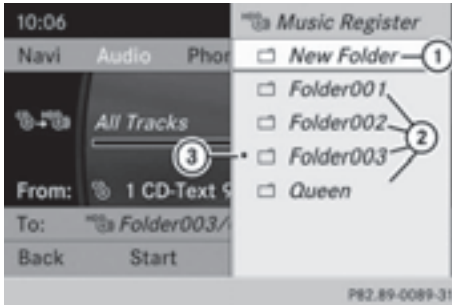

- ① To create a new folder (standard)
- ② Existing folders
- ③ Currently selected folder

- ▶ Select a folder by turning **[⏪]** the COMAND controller and press **[⏩]** to confirm.

If you do not select a target folder, a new one will be created.

Step 3: beginning the import

- ▶ Select **Start** by turning **[⏪]** the COMAND controller and press **[⏩]** to confirm. Information about the import source and target as well as the progress is displayed. The Audio CD basic display automatically appears after successful import.

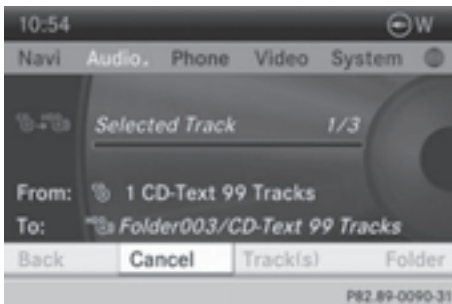

- ▶ **To cancel importing:** during importing, confirm **Cancel** by pressing **[⏪]** the COMAND controller. The Audio CD basic display appears.

Deleting all music files

- ❗ In order to prevent malfunctions, do not use COMAND during this time.

This function deletes all music files from the MUSIC REGISTER.

- ▶ Switch to the MUSIC REGISTER (▷ page 455).
- ▶ Select **Music Register** by sliding **[⏪]** and turning **[⏪]** the COMAND controller and press **[⏩]** to confirm.
- ▶ Select **Delete All Music Files** and press **[⏩]** to confirm. A prompt appears. **No** is highlighted. If you select **Yes**, all music files are deleted. You see the **Please Wait...** message. You will then see the **Data deleted** message. If you select **No**, the process will be canceled.

Calling up memory space info

- ▶ Switch to the MUSIC REGISTER (▷ page 455).
- ▶ Select **Music Register** by sliding **[⏪]** and turning **[⏪]** the COMAND controller and press **[⏩]** to confirm.
- ▶ Select **Memory Info** and press **[⏩]** to confirm. The following is displayed:
 - storage capacity
 - available memory
 - occupied memory
 - content (folders, tracks)

Music search

Introduction

The music search finds tracks via all available media. The search begins with the audio source that is currently active.

The following media are included for the music search:

- Disc (CD/MP3)
 - Memory card
 - MUSIC REGISTER
 - USB storage device
- ▶ Switch to the MUSIC REGISTER (▷ page 455).
- ▶ Select **Search** by sliding $\odot \downarrow$ and turning $\{\odot\}$ the COMAND controller and press \odot to confirm.
The category list appears.
- ▶ Select a track in a category (▷ page 452).

Example: opening a folder

- ▶ Select **Folder** in the category list by turning $\{\odot\}$ the COMAND controller and press \odot to confirm.
You see the content of the current folder.



The name of the current folder is at the top and the track currently playing is indicated by a • dot.

- ▶ **To switch to the next folder up:** press the \leftarrow back button or slide $\leftarrow \odot$ the COMAND controller.

Changing the folder/track name

- ▶ Switch to the MUSIC REGISTER (▷ page 455).
- ▶ Select **Music Register** by sliding $\odot \downarrow$ and turning $\{\odot\}$ the COMAND controller and press \odot to confirm.
- ▶ Select **Rename / Delete Files** and press \odot to confirm.
- ▶ Select a folder/track by turning $\{\odot\}$.
- ▶ Select **Options** by sliding $\odot \rightarrow$ and press \odot to confirm.
- ▶ Select **Change** and press \odot to confirm.
- ▶ Enter a name for the folder/track (▷ page 299).
- ▶ **To save the changes:** select $\boxed{\text{ok}}$ and press \odot to confirm.

Deleting folders/tracks





- ▶ Switch to the MUSIC REGISTER (▷ page 455).
- ▶ Select **Music Register** by sliding $\odot \downarrow$ and turning $\{\odot\}$ the COMAND controller and press \odot to confirm.
- ▶ Select **Rename / Delete Files** and press \odot to confirm.
- ▶ Select a folder/track by turning $\{\odot\}$.
- ▶ Select **Options** by sliding $\odot \rightarrow$ and press \odot to confirm.
- ▶ Select **Delete** and press \odot to confirm.
A prompt appears. **No** is highlighted.
If you select **Yes**, the folders/tracks are deleted. You see the **Please Wait...** message. You will then see the **Data deleted** message.
If you select **No**, the process will be canceled.

Playback options

The following options are available:

- **Normal Track Sequence**
The tracks are played in the normal order (e.g. track 1, 2, 3, etc.).
- **Random Medium**

All the tracks on the medium are played in random order.

- **Random Track List** (MP3 mode only)
The tracks in the currently active folder or the current track list are played in a random order.
- ▶ **To select options:** switch to the MUSIC REGISTER (▶ page 455).
- ▶ Select **Music Register** by sliding  and turning  the COMAND controller and the press  to confirm.
The options list appears. The • dot indicates the option selected.
- ▶ Select an option and press  to confirm.
The option is switched on. For all options except **Normal Track Sequence**, you will see a corresponding display in the display/selection window.

i The **Normal Track Sequence** option is automatically selected when you change the disc you are currently listening to or when you select a different medium. If an option is selected, it remains selected after COMAND is switched on or off.

Bluetooth® audio mode

Preconditions for the Bluetooth® audio device

Bluetooth® audio mode requires a Bluetooth®-capable audio device. Observe the information in the Bluetooth® audio device's operating instructions.

Before using Bluetooth® audio mode, you should check your Bluetooth® audio device for the following:

- Bluetooth® audio profile
The Bluetooth® audio device must support the A2DP and AVRCP Bluetooth® audio profiles.
- Bluetooth® visibility
Certain Bluetooth® audio devices do not just require activation of the Bluetooth®

function. In addition, your device must be made "visible" to other devices.

- Bluetooth® device name
This device name is predetermined but can usually be changed. To make a clear selection of the Bluetooth® device possible, Mercedes-Benz recommends that you customize the device name.
- i** A2DP (**A**dvanced **A**udio **D**istribution **P**rofile): Bluetooth® audio profile for audio data transmission
AVRCP (**A**udio **V**ideo **R**emote **C**ontrol **P**rofile): Bluetooth® audio profile for audio data playback.
- i** Not all Bluetooth® audio devices available on the market are equally suitable. To obtain more information about suitable Bluetooth® audio devices and about connecting Bluetooth® audio devices to COMAND, visit <http://www.mbusa-mobile.com> (USA). Or call the Mercedes-Benz Customer Assistance center at 1-800-FOR-MERCEDES (1-800-367-6372) (USA) or Customer Relations at 1-800-387-0100 (Canada).
- ▶ Activate Bluetooth® and Bluetooth® visibility on the Bluetooth® audio device.

Preconditions in COMAND

- ▶ Activate the Bluetooth® function in COMAND (▶ page 308).

Connecting Bluetooth® audio devices

General information

Before using your Bluetooth® audio device with COMAND for the first time, you will need to authorize it.

When you authorize a new Bluetooth® audio device, it is connected automatically. Connection involves first searching for a Bluetooth® audio device and then authorizing it.

You can authorize up to fifteen Bluetooth® devices.

- ❶ If you authorize a mobile phone that supports Bluetooth® audio, the A2DP and AVRCP Bluetooth® audio profiles are connected automatically.

The mobile phone is then entered:

- in the Bluetooth® telephone list (▷ page 383)
- in the Bluetooth® device list (▷ page 460).

Mercedes-Benz recommends authorizing a mobile phone in Bluetooth® telephony (▷ page 383).

Searching for and authorizing a Bluetooth® audio device



Example: Bluetooth® device list

- ❶ Newly detected mobile phone with Bluetooth® audio function in range
- ❷ Bluetooth® audio player not within range but previously authorized (symbol appears in gray)

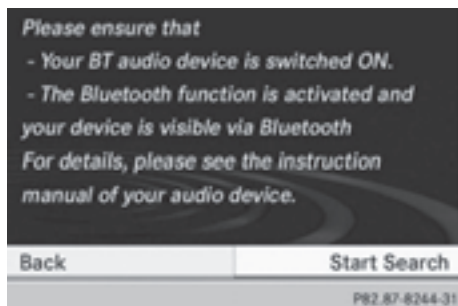

The Bluetooth® device list displays all authorized devices, whether they are within range or not. After a device search, devices which are within range but not authorized are also displayed.

- ▶ Switch on Bluetooth® audio mode (▷ page 463).
If you see the **No Bluetooth Audio Device Authorized** message, you will need to authorize the Bluetooth® audio device first.
- ▶ Select **BT Audio** by sliding $\odot \downarrow$ and turning $\left\{ \odot \right\}$ the COMAND controller and press \rightarrow to confirm.
- ▶ Confirm **Bluetooth Audio Device List** by pressing \rightarrow the COMAND controller.
- ▶ **To search:** confirm **Search for BT Audio Devices** by pressing the COMAND controller \rightarrow .

COMAND searches for Bluetooth® audio devices within range and adds them to the Bluetooth® device list. If Bluetooth® audio devices support the Bluetooth® audio profiles (A2DP, AVRCP), the devices are detected.

The duration of the search depends on the number of Bluetooth® audio devices within range and their characteristics.





- ▶ **To authorize:** select a Bluetooth® audio device that has not yet been authorized from the list (❶ in the example) by turning $\left\{ \odot \right\}$ the COMAND controller.
- ▶ Select the symbol to the right of the Bluetooth® audio device by sliding $\odot \rightarrow$ the COMAND controller and press \rightarrow to confirm.
- ▶ Select **Authorize** and press \rightarrow to confirm. Depending on the Bluetooth® audio device used, you now have two options for continuing with authorization.

- ▶ **Option 1:** enter the passkey (▷ page 383). After successful authorization, the Bluetooth® audio device is connected and starts playing.
- ▶ **Option 2 (Secure Simple Pairing):** if the digit codes displayed in COMAND and on the Bluetooth® audio device are the same, confirm **Yes** by pressing . If you select **Yes**, authorization continues and the Bluetooth® audio device is connected. Playback starts.
If you select **No**, authorization will be canceled.
- i** The Bluetooth® audio device must support Bluetooth® version 2.1 for connection via Secure Simple Pairing. COMAND creates a six-digit code, which is displayed on both devices that are to be connected

External authorization



If COMAND does not find your Bluetooth® audio device, this may be due to particular security settings on your Bluetooth® audio device. In this case, check whether your Bluetooth® audio device can locate COMAND. The Bluetooth® device name of COMAND is **MB Bluetooth**.

- ▶ Switch on Bluetooth® audio mode (▷ page 463).
- ▶ Select **BT Audio** by sliding  and turning  the COMAND controller and press  to confirm.
- ▶ Confirm **Bluetooth Audio Device List** by pressing  the COMAND controller.

- ▶ **To search:** confirm **Connect via BT Audio Device** by pressing the COMAND controller .
The duration of the search depends on the number of Bluetooth® audio devices within range and their characteristics.
- ▶ **To authorize:** start the authorization on the Bluetooth® audio device, see the operating instructions of the Bluetooth® audio device.
After successful authorization, the Bluetooth® audio device is connected and starts playing.
- i** With some Bluetooth® audio devices, playback must first be started on the device itself so that COMAND can play the audio files.

Reconnecting a Bluetooth® audio device

The Bluetooth® audio profiles are connected automatically under the following circumstances:

- one of the last two mobile phones to have been connected has also been used as a Bluetooth® audio player (if this function is supported by the mobile phone).
- the mobile phone takes over the automatic connection itself.

A Bluetooth® audio player without telephone functions is not automatically reconnected, even if it was the last device connected.

If the **No Bluetooth Audio Device Connected** message appears, you have two options to connect a Bluetooth® audio device:

Connecting last device

- ▶ Confirm **Connect Last Device** in the basic display by pressing  the COMAND controller.
If COMAND can locate the Bluetooth® audio device, it will be connected and start playing.
- i** With some Bluetooth® audio devices, playback must first be started on the device

itself so that COMAND can play the audio files.

Connecting a device from a list

- ▶ Select **BT Audio** by turning the COMAND controller and press to confirm.
- ▶ Confirm **Bluetooth Audio Device List** by pressing the COMAND controller.
- ▶ Select a Bluetooth® audio device by turning the COMAND controller and press to confirm.

If COMAND can locate the Bluetooth® audio device, it will be connected and start playing.

- i** With some Bluetooth® audio devices, playback must be initially started on the device itself so that COMAND can play the audio files.

Bluetooth® audio device and simultaneous search for mobile phones

During the search for mobile phones, the connection with the Bluetooth® audio device is terminated (> page 382). In the Bluetooth® audio basic display, you will see the **No Bluetooth Audio Device Connected** message and the **Connect Last Device** menu item cannot be selected.

Displaying details

- ▶ Select a Bluetooth® audio device in the Bluetooth® device list.
- ▶ Select the symbol to the right of the Bluetooth® audio device by sliding the COMAND controller and press to confirm.
- ▶ Select **Details** and press to confirm. The following information concerning the selected mobile phone is shown:
 - Bluetooth® name
 - Bluetooth® address

- availability status (shown after an update)
- authorization status

- ▶ **To close the detailed view:** turn or slide the COMAND controller.

De-authorizing (deregistering) a Bluetooth® audio device

- ▶ Select a Bluetooth® audio device in the Bluetooth® device list.
- ▶ Select the symbol to the right of the Bluetooth® audio device by sliding the COMAND controller and press to confirm.
- ▶ Select **Delete** and press to confirm. A prompt appears asking whether you really wish to deauthorize this device.
- ▶ Select **Yes** or **No**.

If you select **Yes**, the device will be deleted from the Bluetooth® device list.

If you select **No**, the process will be canceled.

- i** Before re-authorizing the Bluetooth® audio device, you should also delete the device name **MB Bluetooth** from your Bluetooth® audio device's Bluetooth® list. See the Bluetooth® audio device's operating instructions.

Switching to Bluetooth® audio mode

The Bluetooth® audio basic display



Example: Bluetooth® audio basic display

- ① Track name
 - ② Current playback settings (no symbol for "Normal track sequence")
 - ③ Album name
 - ④ Sound settings
 - ⑤ Media list
 - ⑥ Artist
 - ⑦ To stop or start playback
 - ⑧ To connect a Bluetooth® audio device, to increase the volume on COMAND
 - ⑨ Bluetooth® audio data medium type
 - ⑩ Data medium position in the media list
- i** If the Bluetooth® audio device connected supports metadata and corresponding data is available, then the artist, track and album name can be displayed.

Using the Bluetooth® audio basic display

- ▶ Connect Bluetooth® audio devices (▷ page 459)

or

- ▶ Reconnect the Bluetooth® audio device (▷ page 461).
COMAND activates the Bluetooth® audio device. The basic display appears and the device starts playing.

Using the DISC button

- ▶ Press the button one or more times.
By pressing the button repeatedly, you can switch modes in the following order:

- CD/MP3 (disc)
- Memory card mode
- MUSIC REGISTER
- USB storage device
- Media Interface or audio AUX mode
- Bluetooth® audio mode

Using the media list

- ▶ Select **Bluetooth Audio** in the media list by turning the COMAND controller and press to confirm (▷ page 447).
COMAND activates the connected device. You will see a message to this effect. The basic display then appears.

Starting/stopping playback

- ▶ **To start playback:** select by sliding and turning the COMAND controller and press to confirm.
Playback starts. is selected.
- ▶ **To stop playback:** select by turning the COMAND controller and press to confirm.
A message appears. is selected.
- ▶ **To continue playback:** select by turning the COMAND controller and press to confirm.
A message appears. is selected.

Restarting playback after stopping



During the search for mobile phones, the connection with the Bluetooth® audio device is terminated (▷ page 382). In the Bluetooth® audio basic display (▷ page 463), you will see the **No Bluetooth Audio Device Connected** message and the **Connect Last Device** menu item cannot be selected.



When the search is finished, the Bluetooth® audio device can be reconnected.

- ▶ Confirm **Connect Last Device** by pressing .

Depending on the Bluetooth® audio device used, playback starts immediately or you must start playback manually.









In this case, you will see the **Bluetooth Audio Device Paused** message.



- ▶ **To start playback:** select  by turning  the COMAND controller and press  to confirm. Playback resumes from the beginning.

Selecting a track

The function is not supported by all Bluetooth® audio devices.

- ▶ **To skip forward or back to a track:** press the  or  button on COMAND.
- or
- ▶ Press the  or  button briefly on the multifunction steering wheel.
- ▶ **Rapid scroll:** press and hold the  or  button on the multifunction steering wheel until the desired track is reached. If you press and hold the  or  button, the rapid scrolling speed is increased.

Selecting playback options

If the Bluetooth® audio device supports the corresponding function, the following options are available:







- **Normal Track Sequence**

The tracks are played in the normal order (e.g. track 1, 2, 3, etc.).

Audio data playback is determined by the order in which the tracks are written to the data carrier. Alphabetical order is the most common. Once all the tracks in a folder have been played, the tracks in the next folder are played.

- **Random Tracks**

All the tracks on the medium are played in random order (e.g. track 3, 8, 5 etc.).

- ▶ Select **BT Audio** by sliding  and turning  the COMAND controller and press  to confirm. The  dot indicates the option selected.
- ▶ Select the option by turning  the COMAND controller and press  to confirm.

If you select **Random Tracks**, you will see a corresponding symbol in the display/selection window.

Increasing the volume on COMAND

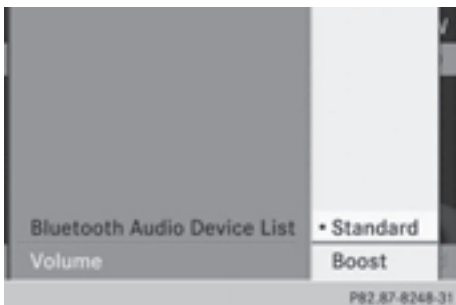

- ▶ Select **BT Audio** by sliding $\odot \downarrow$ and turning $\left\{ \odot \right\}$ the COMAND controller and press \odot to confirm.
- ▶ Select **Volume** and press \odot to confirm. A menu appears. The \bullet dot indicates the current setting.
- ▶ Select **Standard** or **Boost** and press \odot to confirm.

Information about sound settings
(▶ page 296)

You will find further information in the "Audio AUX mode" section (▶ page 471)

Operation with the Media Interface

Connection options

Overview

You will find the connection sockets in the center console stowage compartment.

Device-specific adapter cables are required to connect external devices to the Media Interface. Country-specific versions are supplied with the Media Interface (▶ page 465).

You can connect the following data carriers to COMAND via the Media Interface:

- iPod®
- iPhone®
- certain MP3 players

- i** Store individual parts in a safe place.
Only use genuine Mercedes-Benz connection cables.

i iPod® and iPhone® are registered trademarks of Apple Inc., Cupertino, California, USA.

i MP3 players that support MTP (**M**edia **T**ransfer **P**rotocol) can be used.

This allows the MP3 player to be easily connected to the Media Interface and removed after use. Audio data is played without problem.

On some MP3 players, you have to activate the relevant function; see the MP3 player operating instructions.

Supported devices

For details and a list of supported devices, visit <http://www.mbusa-mobile.com>. Or call the Mercedes-Benz Customer Assistance Center at 1-800-FOR-MERCEdes (1-800-367-6372) (for the USA) or Customer Relations at 1-800-387-0100 (for Canada).

Connecting an external device

Do not leave external devices in the vehicle. They may malfunction in extreme temperatures; see the operating instructions for the respective device. Examples of extreme temperatures are direct sunlight or very low outside temperatures. Mercedes-Benz USA, LLC accepts no liability for damage to external devices.

i Never connect more than one device at a time. You will otherwise not be able to play back from the external device.

USB hubs (devices with several USB connections) are not supported.

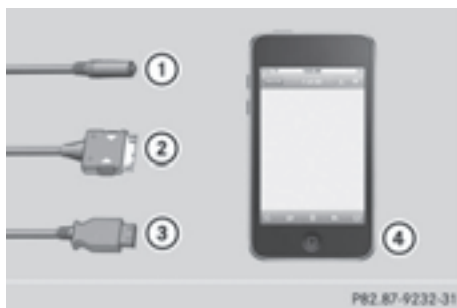

- ① Four-pin socket for 1/8 inch stereo jack, e.g. for MP3 players (audio and video)
- ② iPod® plug for connecting an iPod®
- ③ USB socket for connecting an MP3 player
- ④ Example of device: iPod®

► Connect the external device with suitable socket ①, ② or ③.
COMAND activates the device, a display appears (when connecting an iPod® plug or USB socket).

If you remove a device, the **No Device Connected** message appears.

i A connected iPod® or MP3 player should not be simultaneously operated via the Media Interface and the remote control (e.g. Bluetooth® remote control) or directly via the device itself. This may cause unforeseen technical difficulties.

Applications (Apps) that are activated on the connected device may lead to malfunctions.

i Connecting a fully discharged iPod® or MP3 player can result in an extended initialization period.

Malfunction messages appear while the device is being activated if:

- the connected device is not supported (**External Device Unavailable** message).
- the connected device consumes too much power.

- the Media Interface connection is faulty.
- a mass storage device (e.g. a USB memory stick or USB hard drive) is connected to the Media Interface.

In this case the **Please connect the device to the other USB port** message appears.

i The separate USB connection ensures quick access and expanded media content options.

i Consult an authorized Mercedes-Benz Center if you have further questions.

Disconnecting an iPod®

- Press the release catch on iPod® plug ② and pull the iPod® cable from the iPod®, see the separate cable kit instructions.

Switching to Media Interface mode

General notes

In extreme cases, starting up individual functions can take up to several minutes – this depends on the external device and its content (e.g. video podcasts).

Only use the original software to save files on iPods® or MP3 players. Otherwise, some or all functions may not be available.

Switching on automatically

- Connect an external device (> page 465). COMAND activates the device (if connected via the iPod® connector or USB socket). The basic display then appears.

Switching on using the DISC button

The external device is connected to the Media Interface.

- Press the **DISC** button one or more times.

By pressing the DISC button repeatedly, you can switch modes in the following order:

- CD/MP3 (disc)
- Memory card mode
- MUSIC REGISTER

- USB storage device
- Media Interface or audio AUX mode
- Bluetooth® audio mode

Switching on using a number key

- ▶ Press the **[5 JKL]** number key (single DVD drive).

This selects the connected external audio device directly.

Switching on via the media list



Media Interface mode (iPod® mode)

- ① Cover (if available) or representation of device
 - ② Track number
 - ③ Elapsed track time (also in format 00:00:00 for audio books)
 - ④ Track name
 - ⑤ Graphic time display
 - ⑥ Track position in playlist
 - ⑦ Album name (if available)
 - ⑧ Artist (if available)
 - ⑨ Music search
 - ⑩ Position in the media list
 - ⑪ Type of data medium
 - ⑫ Playback options
- ▶ In the media list, turn **[⏪]** the COMAND controller to select the entry under position 5 and press **[⏩]** to confirm (> page 447). COMAND activates the connected device. You will see a message to this effect. The basic display then appears.

If no device is connected, you will see the **Media Interface** entry instead of a device name.

The type of device connected is indicated by the corresponding symbol for iPod® (iPhone®) or MP3 player.

The current playback option is shown with a symbol after the album name (no display for **Normal Track Sequence**) (> page 470).

- ❗ If the device connected does not contain any playable tracks, a message appears to this effect.

Selecting music files

Note

COMAND displays the data stored on the iPod®, iPhone® or MP3 player according to the file structure used in the respective medium.

Selecting by skipping to a track

- ▶ **To skip forwards or back to a track:** turn **[⏪]** the COMAND controller when the display/selection window is active.

or

- ▶ Press the **[⏪]** or **[⏩]** button.

The skip forward function skips to the next track. The skip back function skips to the beginning of the current track if the track has been playing for more than eight seconds. If the track has been playing for less than eight seconds, it skips to the start of the previous track. If you have selected a playback option other than **Normal Track Sequence**, the track sequence is random.

Selecting using the number keypad

- ▶ **To make an entry:** press the **[*]** button. An input menu appears. The number of characters available for input depends on the number of stored tracks.

► **To enter a track number:** press a number key, e.g. .

The digit is entered in the first position in the input line.

i COMAND will ignore and not display an invalid digit.



► Enter more numbers if desired.
The track plays after the last possible number is entered.

i Pressing and holding a number key for more than two seconds completes the entry, and the corresponding track is played.

Fast forwarding/rewinding

► While the display/selection window is active, slide ◀ ○ ▶ and hold the COMAND controller until the desired position has been reached.

or

► Press and hold the  or  button until the desired position is reached.

i On an iPod® or iPhone®, fast rewind only functions within the current track.

Selecting a category/playlist/folder

Overview

For an iPod®, iPhone® or certain MP3 players, you can select tracks using categories or folders.

Depending on the device connected, the following categories may be available, for example:

- [Current Track List](#)
- [Selecting By Cover](#)
- [Keyword Search](#)
- [Playlists](#) (e.g. [All](#))
- [Artists](#)
- [Albums](#)
- [Title](#)
- [Podcasts](#)
- [Genres](#)
- [Composers](#)

- [Audiobooks](#)

- [Videos](#) (except for Hong Kong)

i Some playback categories contain the entry [All](#). If this entry has been selected, the entire content of the category selected will be played.

The [Videos](#) category is available for iPods® and iPhones® (except for Hong Kong).

i The functions are available as soon as the entire media content has been read and analyzed. For certain functions, such as keyword search and selection by cover, this can take several minutes, depending on the scope of media and the connected device.

If the same device is reconnected with unchanged media content, these functions are available much more quickly.

However, if you change the media content, it has to be read and analyzed again.

Calling up a category list

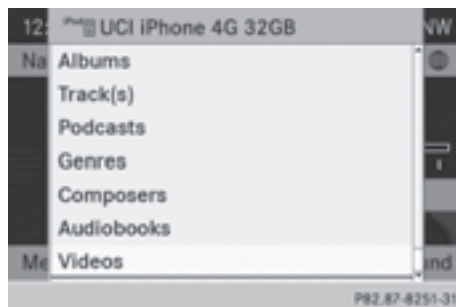

Example: category list

- ▶ Select **Search** in the basic display by sliding $\odot \downarrow$ and turning $\{\odot\}$ the COMAND controller and press \odot to confirm. The category list appears.

i **Search** is not available until the device has been activated.

i **Reading:** if the media content of the connected device is being read, this is indicated on the upper right by a symbol. When reading has ended, the categories **Select By Cover** and **Keyword Search** are available.

Depending on the connected device and the size of the media content, reading may take several minutes. When the device is next started or reconnected, the advanced functions will be quickly available.

However, if you change the media content on your iPod®/iPhone®, it has to be read and analyzed again.

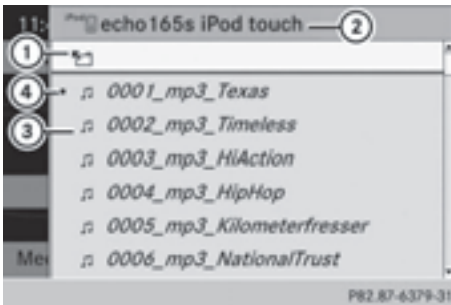

Example: current track list

- ① Symbol for next folder up
 - ② Device icon and device name
 - ③ Track symbol
 - ④ Current title
- ▶ Select **Current Tracklist** by turning $\{\odot\}$ the COMAND controller and press \odot to confirm. The content of the current track list appears.
 - ▶ Select the track by turning $\{\odot\}$ the COMAND controller and press \odot to confirm. The track is played.

- ▶ **To switch to the next folder up:** slide $\leftarrow \odot$ the COMAND controller.

or

- ▶ Press the **BACK** back button.

Playing back the content of a category or folder

- ▶ Select the category or folder by turning $\{\odot\}$ the COMAND controller.
- ▶ Press \odot the COMAND controller for longer than 2 seconds.

The content of the category or folder selected is played in accordance with the playback option selected (▶ page 470).

Alphabetical track selection

iPod®, iPhone® and MP3 player

This function is available for alphabetically sorted categories and folders. This function is not available for albums or playlists, for example.

- ▶ Select a category, e.g. **Artists**, by turning $\{\odot\}$ the COMAND controller and press \odot to confirm.

The available artists are displayed.

- ▶ Press the corresponding number key once or repeatedly to select the initial letter of the desired artist. For example, to select an artist whose name begins with C, press the **2** number key three times.

The available letters are listed at the lower edge of the display.

After a message, the first entry in the list which matches the letter entered is highlighted.

- i** If no corresponding entry exists, the last entry corresponding to a previous letter is highlighted instead.

i iPods and MP3 players: the quality of the search results is highly dependent on the version and language variant of the software used to populate the device. A well-known example of such software is iTunes®.

If different sorting rules are defined (e.g. in iTunes®), the search is canceled without any result.

Additional selection functions

• Select By Cover

Albums can be chosen by cover using the menu item.

The first time the **Select By Cover** function is used, additional data must be loaded from the iPod®/iPhone®. The current music playback is interrupted to allow access to this data. The process may take a few minutes and should not be canceled. Otherwise it will start again from the beginning the next time **Select By Cover** is selected. Covers are initially searched for in the Gracenote Media Database and are then added to during playback from the connected device (▷ page 448). The availability depends on the use and the tracks already selected.

• Keyword Search

Selecting keyword search allows you to search through all categories on the connected device for keywords.

i More information on **Select By Cover** and **Keyword Search** can be found under "Music search, selecting category" (▷ page 468).

i For an iPod®/iPhone®, the available covers are added most efficiently if the entire media content is in the current playlist. This is the case if you have selected the playback option **Tracks** or **Random Medium** (▷ page 470).

Special feature in iPod®/iPhone® mode

i If the connected iPod®/iPhone® is not functioning or paused, you can search for tracks but cannot select them. After confirming a new track, the **Function Unavailable** message appears.

Playback options

► **To select a playback option:** select **Media Interface** in the basic display by sliding ⏪ ↓ and turning ⏸ ⏩ the COMAND controller and press ⏹ to confirm.

The options list appears. The • dot indicates the option selected.

► Select an option and press ⏹ to confirm.

The following options are available:

• Normal Track Sequence

Normal track sequence: you hear the tracks in their normal order (e.g. numerical or alphabetical).

• Random Medium

All the tracks on the medium are played in random order.

• Random Track List

The tracks in the currently active category or folder, including any subfolders, are played in random order.

i If the connected iPod®/iPhone® is not functioning or paused, the playback options are inactive. The display of options is grayed out.

MP3 player instructions

General information

Up to 30,000 tracks per medium are supported.

You can speed up some functions and improve the search results by:

- making sure the names of tracks, albums and artists, for example, are written the same way
- labeling albums featuring various artists as "compilations"

i Multiple entries of tracks in playlists are filtered out for some players.

Data formats

MP3 and WMA are supported as data formats with fixed and variable bit rates (up to 320 kbits/s).

Special considerations when using MP3 players

Up to eight directory levels with up to 1,000 tracks per directory are supported.

Do not use USB extension leads or adapters. They can impair functionality.

- i** DRM (Digital Rights Management) protected files are not supported by the Media Interface.

Audio AUX mode

Notes on audio AUX mode

External audio sources may have different volumes, which can mean that system messages such as traffic announcements and navigation system announcements are much louder. If necessary, deactivate the system messages or adjust their volume manually.

You can connect an external audio source (AUX) to COMAND.

Depending on the vehicle model series, the connection is made using a jack in the stowage compartment in the center console or a USB port (▷ page 445).

If COMAND is equipped with the Media Interface, external audio sources are connected using the cable set provided. An AUX socket is not provided. The connections for the Media Interface are located in the stowage compartment in the center console.

- i** You will find further information online at <http://www.mbusa-mobile.com>. Or call the Mercedes-Benz Customer Assistance Center at 1-800-FOR-MERCEdes (1-800-367-6372) (for the USA) or Customer Relations at 1-800-387-0100 (for Canada).

Switching to audio AUX mode

Switching on using the DISC button

The external device is connected to the audio AUX input.

- ▶ Press the **DISC** button one or more times.

By pressing the function button repeatedly, you can change the operating mode in the following order:

- CD/MP3 (disc)
- Memory card mode
- MUSIC REGISTER
- USB storage device
- Media Interface or audio AUX mode
- Bluetooth® audio mode

Switching modes via the audio menu

When you connect an external audio source, audio AUX is not selected automatically.

- ▶ Select **Audio** in the main function bar by sliding **↑** and turning **⏪** the COMAND controller and press **⏩** to confirm. If AUX mode was the last mode selected, it will now be active.

If another audio source is switched on, you can now switch to audio AUX mode in the audio menu.

- ▶ Select **Audio** using **↑** and press **⏩** to confirm. The audio menu appears.
- ▶ Select **Aux** by turning **⏪** and press **⏩** to confirm. The audio AUX menu appears. The medium in the external audio source is played if the source is connected and playback selected.







Please see the respective operating instructions for how to operate the external audio source.

Information on:

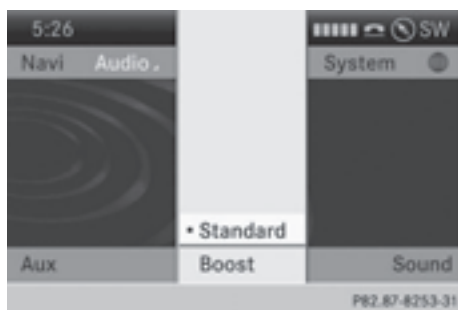
- Volume settings (▷ page 295)
- Sound settings (▷ page 296)

Increasing the volume on COMAND



- ▶ Select **Volume** in the AUX display by turning  the COMAND controller and press  to confirm.
A menu appears. The • dot indicates the current setting.
- ▶ Select **Standard** or **Boost** and press  to confirm.
Standard: the volume of the external audio source is adjusted to a standard value.
Boost: the volume of the external audio source is raised by approximately 10 dB.

A device which is connected as an external audio source may seem quieter or louder in the vehicle, or the usual maximum volume cannot be achieved. On some devices, it is

possible to adjust the volume separately. In this case, start at a medium volume and increase it gradually. This enables you to determine whether the system is able to play the music at high volume without distorting it.

Video

Your COMAND equipment

These operating instructions describe all the standard and optional equipment for your COMAND system, as available at the time of going to print. Country-specific differences are possible. Please note that your COMAND system may not be equipped with all the features described.

General information

Automatic picture shutoff

The video image is only displayed for the driver when the transmission lever is in position **P**.







SPLITVIEW allows the front passenger to view the video image (▷ page 303).

When the transmission lever is disengaged from position **P**, the following message appears in the display: **In order not to distract you from the traffic situation, the picture is faded out while the vehicle is in motion.**







As soon as the selector lever of the transmission is returned to position **P**, the video image is shown.

Basic settings

Adjusting the brightness, contrast or color

- ▶ In video DVD or video AUX mode, press the  COMAND Controller. The menu is shown.
- ▶ Select **DVD-Video** or **Aux** by turning  the COMAND controller and press  to confirm. A menu appears.
- ▶ Select **Brightness**, **Contrast** or **Color** by turning  the COMAND controller and press  to confirm.
- ▶ Set the value between - 5 and + 5 and press  to confirm.

Changing the picture format

- ▶ Press  the COMAND controller. The menu is shown.
- ▶ Select **DVD-Video** by sliding  and turning  the COMAND controller and press  to confirm. A menu appears.
- ▶ Select **16:9 Optimized**, **4:3** or **Wide-screen** and press  to confirm. The dot in front of the entry indicates the currently selected format.
- ▶ Select a setting by turning  the COMAND controller and press  to confirm.

Video DVD mode

Important safety notes

WARNING

The CD/DVD drive is a class 1 laser product. If you open the housing of the CD/DVD drive, there is a risk of exposure to invisible laser radiation. This laser radiation could damage your retina. There is a risk of injury.

Never open the housing. Always have maintenance and repair work carried out at a qualified specialist workshop.

WARNING

Handling discs while driving may distract you from traffic conditions. You could also lose control of the vehicle. There is a risk of an accident.

Handle discs only when the vehicle is stationary.

Bear in mind that at a speed of only 30 mph (approximately 50 km/h), your vehicle covers a distance of 44 feet (approximately 14 m) every second.

Notes on discs

 Do not affix stickers or labels to the discs. They could peel off and damage COMAND. Stickers can cause the disc to bend, which can result in read errors and disc recognition problems.

 COMAND is designed to play discs that comply with the EN 60908 standard. Therefore, you can only use discs with a maximum thickness of 1.3 mm.

If you insert thicker discs, e.g. those that contain data on both sides (DVD on one side and audio data on the other), they cannot be ejected and can damage the device.

Only use round discs with a diameter of 12 cm. Do not use discs with a diameter of 8 cm, even with an adapter.

Playback problems may occur when playing copied discs. There are a large variety of discs, DVD authoring software, writing software and writers available. This variety means that there is no guarantee that the system will be able to play discs that you have copied yourself.

DVD playback conditions

If video DVDs do not conform to the NTSC or PAL TV standards, they may create picture, sound or other problems during playback.

COMAND is capable of playing back video DVDs produced according to the following standards:

- Region code 1 or region code 0 (no region code)
- PAL or NTSC standard

You will generally find the relevant details either on the DVD itself or on the DVD case.

i If you insert a video DVD with a different region code, you will see a message to this effect.

i COMAND is set to region code 1 at the factory. This setting can be changed at an authorized Mercedes-Benz Center. This will allow you to play video DVDs with a different region code, provided that they are produced in accordance with the PAL or NTSC standard. The region code can be changed up to five times.

Function restrictions

Depending on the DVD, it is possible that certain functions or actions will be temporarily blocked or may not function at all. As soon as you try to activate these functions or actions, you will see the  symbol in the display.

Inserting and removing DVDs

- ▶ Proceed as described in the "Inserting and ejecting CDs and DVDs" section (> page 444).

Switching to video DVD mode





Switching on automatically

- ▶ Insert a video DVD.
COMAND loads the medium inserted and starts to play it.



Switching on using the DISC button

- ▶ Press the  button.
COMAND switches to the previous disc operating mode.



By pressing the  button repeatedly, you can switch modes in the following order:

- video DVD/CD/MP3 in the single DVD drive (disc mode)
- memory card mode
- MUSIC REGISTER
- USB storage device
- Media Interface or audio AUX mode
- Bluetooth® audio mode
- ▶ Select **Media** by sliding  and turning  the COMAND controller and press  to confirm.
- ▶ Select a  video DVD from the media list (> page 476).

Switching on with the video menu

- ▶ Select **Video** in the main function bar by sliding  and turning  the COMAND controller and press  to confirm.
Video DVD mode is switched on.

Showing/hiding the control menu

- ▶ **To show:** in DVD video mode, slide  the COMAND controller.
 - ▶ **To hide:** slide  the COMAND controller.
- or
- ▶ Wait for approximately eight seconds.

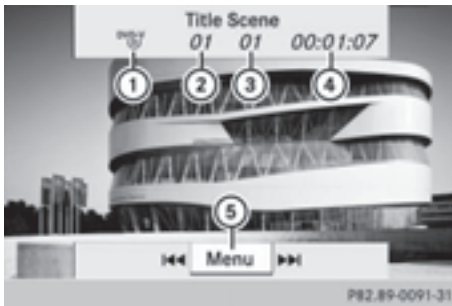

Control menu displayed

- ① Type of data medium
- ② Current title
- ③ Current scene
- ④ Track time
- ⑤ Shows the menu

i This function is not available while the DVD's own menu is being displayed.

Showing/hiding the menu

▶ **To show:** in full-screen DVD video mode, press the COMAND controller.

or

▶ Select **Menu** while the control menu is shown and press to confirm.

▶ **To hide:** slide the COMAND controller and confirm **Full Screen** by pressing .



Menu shown

- ① Video DVD options
- ② Pause function
- ③ Stop function

④ Media selection

⑤ Sound settings

i This function is not available while the DVD's own menu is being displayed.

Fast forwarding/rewinding

▶ In full-screen DVD video mode, slide and hold the COMAND controller until the desired position is reached.

or

▶ Press and hold the or button until the desired position is reached. You see the control menu.

Stop function

▶ Show the menu (▶ page 475).

▶ **To interrupt playback:** select by turning the COMAND controller and press to confirm. The display changes to . The video image is hidden.

▶ **To continue playback:** select and press to confirm. Playback continues from the point where it was interrupted.







▶ **To stop playback:** while playback is interrupted, select again and press to confirm.

or

▶ During playback, confirm by pressing twice in rapid succession. is selected.

▶ **To restart playback:** confirm by pressing . Playback restarts from the beginning.







Pause function

- ▶ Show the menu (▷ page 475).
- ▶ **To pause playback:** select  by turning  the COMAND controller and press  to confirm.
The  display changes to .
- ▶ **To continue playback:** select  and press  to confirm.
The menu is hidden.

Selecting a scene/chapter

If the film is divided into scenes or chapters, you can select them directly while the film is running, or skip forwards step by step. Some DVDs do not permit this at certain points (e.g. during the opening credits).

It may also be possible to select the scene/chapter from within the menu stored on the DVD.

- ▶ **To skip forwards or back:** in full screen mode, turn  the COMAND controller.
or
- ▶ Slide    the COMAND controller.
or
- ▶ Press the  or  button on the control panel.
The navigation menu (▷ page 474) appears for approximately eight seconds.

Selecting a film/track

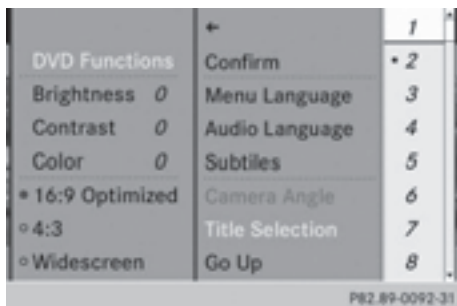







DVD function menu







This function is only available if the DVD is divided into several films/titles. If the DVD

contains several films, these can be selected directly. A film can be selected either when the DVD is being played back or when it is stopped.

The film can also be selected from the menu on the DVD itself.

- ▶ Show the menu (▷ page 475).
- ▶ Select **DVD-Video** by turning  the COMAND controller and press  to confirm.
- ▶ Select **DVD Functions** and press  to confirm.
A menu appears.
- ▶ Select **Title Selection** by turning  the COMAND controller and press  to confirm.
- ▶ Select a film/title and press  to confirm.

Selecting a video DVD from the media list

- ▶ Show the menu (▷ page 475).
- ▶ Select **Media** by sliding  and turning  the COMAND controller and press  to confirm.
The media list appears. The  dot indicates the current medium being played. Video DVDs are indicated by the  icon.
- ▶ Press  the COMAND controller.
COMAND loads the video DVD and begins playing it.

- i** If you select a CD or an MP3 medium, you switch to the respective audio mode.
Further information on the media list (▷ page 447).

DVD menu

Calling up the DVD menu

The DVD menu is the menu stored on the DVD itself. It is structured in various ways according to the individual DVD and permits certain actions and settings.

In the case of multi-language DVDs, for example, you can change the DVD language in the DVD menu.

- ▶ Show the menu (▷ page 475).
- ▶ Select **DVD-Video** in the menu by turning **⏪** the COMAND controller and press **⏹** to confirm.
- ▶ Select **DVD Functions** and press **⏹** to confirm.
- ▶ Select **Menu** and press **⏹** to confirm. The DVD menu appears.

Selecting menu items in the DVD menu

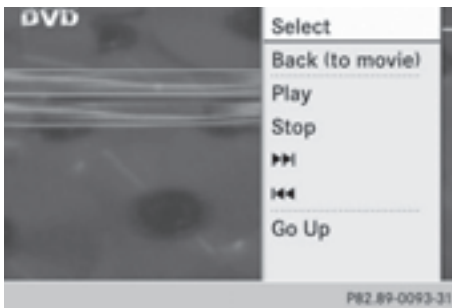

- ▶ Show the DVD menu (▷ page 476).
 - ▶ Select a menu item by sliding **↑** the COMAND controller and press **⏹** to confirm.
- or
- ▶ Select a menu item by sliding **←** the COMAND controller and press **⏹** to confirm. The menu appears.

- ▶ **To reconfirm your selection:** confirm **Select** by pressing **⏹**. COMAND carries out the action. Make a selection from the further options, if necessary. COMAND then switches back to the DVD menu.

i Menu items which cannot be selected are shown in gray.

i Depending on the DVD, the menu items: **Back (to the movie)**, **Play**, **Stop**, **⏪**, **⏩** or **Go Up** may either not function at all

or may not function at certain points in the DVD menu. To indicate this, the **⊘** symbol appears in the display.

Moving up one level in the DVD menu

- ▶ Show the DVD menu (▷ page 476).
 - ▶ Select the corresponding menu item in the DVD menu and press **⏹** the COMAND controller to confirm.
- or
- ▶ Select any menu item in the DVD menu and press **⏹** the COMAND controller to confirm.
 - ▶ Select **Go Up** and press **⏹** to confirm.

Back to the film

- ▶ Press the **BACK** back button repeatedly until you see the movie.
- or
- ▶ Select the corresponding menu item from the DVD menu.
 - ▶ Select the **Back (to the movie)** menu item in the menu and press **⏹** to confirm.

Setting the language and audio format

This function is not available on all DVDs. If it is available, you can set the DVD menu language, the audio language or the audio format. The number of settings is determined by the DVD content. It is possible that the settings may also be accessed in the DVD menu (▷ page 476).

- ▶ Show the DVD menu (▷ page 476).
- ▶ In full-screen mode, press **⏹** the COMAND controller to show the menu.
- ▶ Select **DVD-Video** in the menu by turning **⏪** the COMAND controller and press **⏹** to confirm.
- ▶ Select **DVD Functions** and press **⏹** to confirm.

- ▶ Select **Menu Language** or **Audio Language** and press to confirm. In both cases, a menu appears after a few seconds. The • dot in front of an entry indicates the currently selected language.
- ▶ Select a setting by turning the COMAND controller and press to confirm.

Subtitles and camera angle

These functions are not available on all DVDs. The number of subtitle languages and camera angles available depends on the content of the DVD. It may also be possible to access the settings from the DVD menu.

- ▶ Show the DVD menu (▷ page 476).
- ▶ Select **DVD-Video** in the menu by turning the COMAND controller and press to confirm.
- ▶ Select **DVD Functions** and press to confirm.
- ▶ Select **Subtitles** or **Camera Angle** and press to confirm. In both cases, a menu appears. The • dot in front of an entry indicates the current setting.
- ▶ Select a setting by turning the COMAND controller and press to confirm.

Interactive content

DVDs can contain interactive content (e.g. a video game). In a video game, for example, you may be able to influence events by selecting and triggering actions. The type and number of actions depend on the DVD.

- ▶ Select an action by sliding or the COMAND controller and press to execute it. A menu appears and the first entry, **Select**, is highlighted.
- ▶ Press the COMAND controller.

Video AUX mode

Connecting external video sources

External video sources may have different volumes, which can mean that system messages such as traffic announcements and navigation system announcements are much louder. If necessary, deactivate the system messages or adjust their volume manually.

If your vehicle is equipped with Media Interface, you can connect an external video source (AUX video) (▷ page 465).

The 1/8 inch audio/video jacks are in the center console stowage compartment.

- In vehicles with a rear view camera, the AUX video jack cannot be used for external video sources.

Switching to AUX video mode

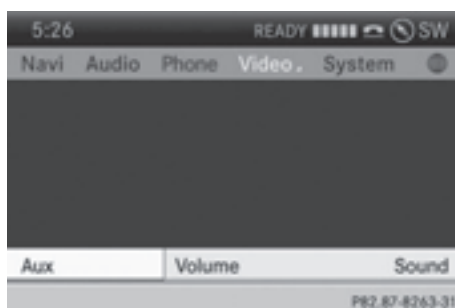

AUX video mode

- ▶ Press the function button repeatedly until Media Interface mode is selected.
- or
- ▶ Select **Video** in the main function bar by turning the COMAND controller and press to confirm. If AUX video mode was the last mode selected, it will now be active. If another video source is switched on, you can now switch to AUX video mode in the video menu.

- ▶ Select **Video** and press to confirm.
- ▶ Select **Aux** and press to confirm.
The AUX video menu appears. You will hear and see the content of the external video source if it is connected and switched to playback.

Showing/hiding the menu

- ▶ **To show:** in video AUX mode, press the COMAND controller.
- ▶ **To hide:** slide the COMAND controller and confirm **Full Screen** by pressing .

Volume and sound settings

Information on:

- Volume settings (▶ page 295)
 - Sound settings (▶ page 296)
- i** A device which is connected as an external video source may seem quieter or louder in the vehicle, or the usual maximum volume cannot be achieved. On some devices, it is possible to adjust the volume separately. In this case, start at a medium volume and increase it gradually. This enables you to determine whether the system is able to play the sound at high volume without distorting it.

Increasing the volume on COMAND

- ▶ Show the video AUX menu (▶ page 479).
- ▶ Select **Volume** by turning the COMAND controller and press to confirm.
A menu appears. The **•** dot indicates the current setting.
- ▶ Select **Standard** or **Boost** and press to confirm.
Standard: the volume of the external video source is adjusted to a standard value.
Boost: the volume of the external video source is raised by approximately 10 dB.

Picture viewer

Introduction

If there are pictures on the active data medium, you can look at them. You can display pictures with a resolution of up to 20 megapixels.

Data medium	Supported picture formats
CD/DVD with picture files	bmp, jpeg, jpg, png
USB devices (sticks, hard drives)	bmp, jpeg, jpg, png
SD memory card	

Calling up a category list

- ▶ Select a data medium with pictures (e.g. a memory card):
 - in the Audio menu (▶ page 435)
 - in the media list (▶ page 447)
- ▶ Select **Search** in the basic display by sliding and turning the COMAND controller and press to confirm.
The category list appears (▶ page 452).

Displaying pictures

- ▶ Select (▶ page 452) **Photos** in the category list by turning the COMAND controller and press to confirm.
A folder directory appears.
- ▶ Select a folder with photos and press to confirm.
The folder displays the existing picture files (example).

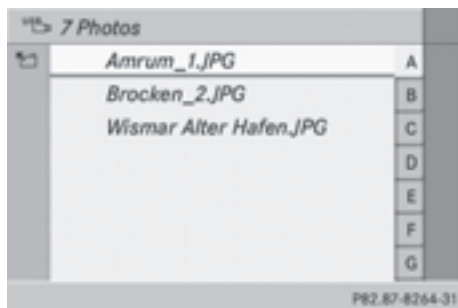

- ▶ Select a photo and press to confirm. The photo is displayed and the music is stopped.



Changing the picture view

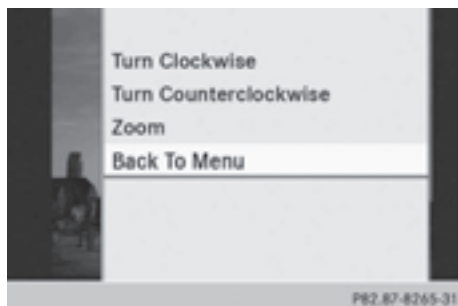

- ▶ While viewing a picture (▷ page 479), press the COMAND controller. A menu appears.
- ▶ **To turn the picture clockwise:** confirm **Turn Clockwise** by pressing the COMAND controller.
- ▶ **To turn the picture counter-clockwise:** select **Turn Counterclockwise** by turn-

ing the COMAND controller and press to confirm.

- ▶ **To zoom into a picture:** select **Zoom** by turning the COMAND controller and press to confirm. After you have zoomed into the picture, you can move the section of the picture.
 - ▶ Slide and the COMAND controller.
 - ▶ **To revert to the original size:** press the COMAND controller.
- or
- ▶ Press the **BACK** button.

Exiting the picture viewer

- ▶ Select **Back To Menu** in the menu by turning the COMAND controller and press to confirm.



Rear Seat Entertainment System

Your COMAND equipment

These operating instructions describe all the standard and optional equipment for your COMAND system, as available at the time of going to print. Country-specific differences are possible. Please note that your COMAND system may not be equipped with all the features described.

Overview

Important safety notes

WARNING

The CD/DVD drive is a class 1 laser product. If you open the housing of the CD/DVD drive, there is a risk of exposure to invisible laser radiation. This laser radiation could damage your retina. There is a risk of injury.

Never open the housing. Always have maintenance and repair work carried out at a qualified specialist workshop.

WARNING

If objects such as headphones/headsets or external audio/video sources are not secured in the passenger compartment, they can be flung around and hit vehicle occupants. There is a risk of injury, for example in the event of sudden braking or a sudden change in direction.

Always stow these items or similar objects carefully so that they cannot be flung around, for example in a lockable vehicle stowage compartment.

Components

The Rear Seat Entertainment System includes:

- two screens for the rear behind the front-seat head restraints
- two remote controls
- a CD/DVD drive
- AUX jacks on both screens (AUX display) and on the CD/DVD drive (AUX drive)
- two sets of cordless headphones

Rear-compartment screens



- ① AUX jacks, detailed view in the "CD/DVD drive and AUX jacks" section (▷ page 483).
- ② Display

Remote control

Overview



- ① Switches the screen on/off
- ② Switches the button lighting on/off
- ③ Selects the screen for the remote control
- ④ Selects a menu or menu item
- ⑤ Confirms a selection or setting
- ⑥ Switches the sound on or off
- ⑦ Adjusts the volume
- ⑧ Skips to a track, fast-forward/fast-rewind
- ⑨ Selects a track; direct entry
- ⑩ Exits a menu (back)

i Two remote controls are supplied for the US and Canadian markets.

Selecting the screen for the remote control

The remote control can be used to operate one of the two rear-compartment screens or SPLITVIEW for the front passenger. To do so, you must switch the remote control to the desired screen (▷ page 482).

- ▶ To select the left-hand screen: turn thumbwheel ③ until "L REAR" is highlighted in the window.
- ▶ To select the right-hand screen: turn thumbwheel ③ until "R REAR" is highlighted in the window.
- ▶ To select SPLITVIEW: turn thumbwheel ③ until "SPLITVIEW" is highlighted in the window.

Switching the screen on/off

If the SmartKey is in position **0** or **1** in the ignition lock (see vehicle Operator's Manual), or if it is not in the ignition lock, the rear-compartment screens will switch off after 30 minutes. Before the screens switch off, they show a message to this effect.

You can switch the screens back on. However, this will discharge the starter battery.

- ▶ Point the remote control at the rear-compartment screen which has been selected for remote operation.
- ▶ Press button ① on the remote control (▷ page 482).
The respective rear-compartment screen switches on or off.
- ❗ You can only switch the screens on using the remote control if the ignition is switched on.





Switching the button lighting on/off

- ▶ Press button ② on the remote control (▷ page 482).
Depending on the previous status, the button lighting is switched on or off.
- ❗ If you do not use the remote control for about 15 seconds, the button lighting switches off automatically.

Switching the sound on or off

- ▶ Press button ⑥ on the remote control (▷ page 482).
The sound is switched on/off.

Selecting a menu/menu item and confirming your selection

- ▶ Select a menu/menu item using the     buttons on the remote control and press the  button to confirm.

CD/DVD drive and AUX jacks

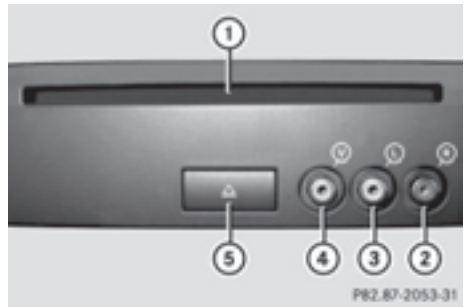

- ① CD/DVD slot
- ② AUX, right-hand (R) jack for audio signal (red)
- ③ AUX, left-hand (L) jack for audio signal (white)
- ④ AUX, video (V) jack (yellow)
- ⑤ CD/DVD eject button

The AUX jacks shown are for the AUX drive. Identical jacks can be found on the right-hand side of the rear-compartment screens (AUX display) (▷ page 482).

Cordless headphones

Overview



- ▶ **To adjust the headphones:** open both sides of the headphones.
- ▶ Adjust the fit of the headphones by pulling the headphone band in the direction of the arrow.
- ▶ **To switch the headphones on/off:** press on/off switch ②.
- ▶ **To adjust the volume:** turn volume control ③ until the desired volume is set. If you have connected corded headphones to a rear-compartment screen, you can adjust the volume using the remote control (> page 482).
- ▶ **To check the battery condition of charge:** check the state of the batteries using indicator lamp ①.

i To preserve the batteries, the headphones automatically switch off if they have not received an audio signal for approximately 3 minutes.

Indicator lamp on the cordless headphones

The color of the indicator lamp shows:

- whether the device is switched on or off
- the condition of the inserted batteries.

LED display	Status
Green	The batteries are fine.
Red	The batteries are almost discharged.
Lit continuously	The headphones are switched on and connected to a screen.

LED display	Status
Flashing	The headphones are searching for the connection to a screen.
No display (dark)	The headphones are switched off or the batteries are discharged.

i The function of the headphones may be impaired by other radio-based electronic devices such as mobile phones or laptops.

Selecting the screen for the headphones



- ▶ Slide switch ① to **L** (left-hand screen) or **R** (right-hand screen).

Connecting additional headphones

Up to two cordless headphones can be used at the same time for each screen.

You can also connect one additional set of corded headphones to each of the two rear-compartment screens (▷ page 482). The socket is designed for headphones with a 3.5 mm stereo jack plug and an impedance of 32 ohms.

Replacing batteries

Notes

WARNING

Batteries contain toxic and corrosive substances. If batteries are swallowed, it can result in severe health problems. There is a risk of fatal injury.

Keep batteries out of the reach of children. If a battery is swallowed, seek medical attention immediately.

Environmental note



Batteries contain dangerous substances. It is against the law to dispose of them with

the household rubbish. They must be collected separately and recycled to protect the environment.



Dispose of batteries in an environmentally friendly manner. Take discharged batteries to a qualified specialist workshop or a special collection point for used batteries.

Batteries are required for the remote control and for the two sets of cordless headphones. The batteries can be replaced (▷ page 485).

Replacing the batteries of the remote control



- ① Battery compartment
- ② Catch tab
- ③ Battery compartment cover
- ④ Retaining lugs
- ⑤ Batteries

The remote control contains 2 type AAA, 1.5 V batteries.

- ▶ **To open the battery compartment:** remove battery compartment cover ③ on the back of the remote control.
- ▶ To do so, press down retaining lug ② and take off battery compartment cover ③.

- ▶ Remove discharged batteries ⑤ from the tray.
- ▶ Insert the new batteries. Observe the polarity markings on the batteries and battery compartment when doing so.
Left-hand battery: the positive pole (+) must face upwards.
Right-hand battery: the positive pole (+) must face downwards.
- ▶ **To close the battery compartment:** insert battery compartment cover ③ starting with retaining lugs ④ into the battery compartment and allow catch tab ② to engage in place.

- ▶ Insert the new batteries. Observe the polarity markings on the batteries and battery tray when doing so.
- ▶ **To close the battery compartment:** replace battery housing cover ① and turn it clockwise until it engages.
If the batteries have been inserted correctly, the indicator lamp will light up green when the headphones are switched on.

i The operating duration of the headphones with a set of batteries is up to 40 hours.

Basic functions

Using headphones

You can use the cordless headphones supplied and/or up to two sets of corded headphones connected to the corresponding jack of the rear-compartment screens (▷ page 482).

Information on the cordless headphones (▷ page 484).

Using the main loudspeakers

This function is available in conjunction with COMAND.

You can use the vehicle loudspeakers to listen to a disc inserted in the rear-compartment drive. To do so, at least one of the rear-compartment screens must be set to disc mode.

- ▶ **To set on COMAND:** press the **RADIO** button, for example, to switch on an audio mode.
- ▶ Select **Audio** by sliding **↑** ① the COMAND controller and press **⏻** to confirm.
The Audio menu appears.
- ▶ Select **Rear** by turning **⏻** ② the COMAND controller and press **⏻** to confirm.

i The headphones' volume setting does not affect the main loudspeakers.

Replacing cordless headphone batteries









The battery compartment is located on the left headphone. The cordless headphones require two type AAA, 1.5 V batteries.

- ▶ **To open the battery compartment:** turn battery compartment cover ① counter-clockwise and remove.
- ▶ Remove the discharged batteries from the tray.

Selecting sound settings

You can select the sound settings in the CD/MP3, video DVD and AUX modes.

- ▶ Switch on an operating mode (e.g. audio CD mode) (▷ page 489).
- ▶ Select **Treble** or **Bass** using the    buttons on the remote control and press the  button to confirm. An adjustment scale appears.
- ▶ Select a setting using the   buttons and press the  button to confirm.

Multiple users

Simultaneous use of the rear-compartment disc drive

The two rear-compartment screens can be operated almost entirely independently from one another. However, there can be a conflict in some menus if the two screens are used simultaneously.

If the rear-compartment disc drive is being used for both screens simultaneously, selecting certain menus or settings on one of the screens also affects the other screen.

The following functions affect both screens:

- changing playback options
- selecting a track (from a track list or folder)
- using the play, pause and stop functions
- fast forwarding/rewinding or scrolling
- calling up the DVD menu and navigating within it
- setting the language, subtitles and camera angle
- calling up interactive DVD content

The following functions affect only one screen:

- audio and video functions as well as picture settings
- switching between full screen and the menu

Switching between operating modes

When you exit an operating mode (e.g. audio CD mode), the current setting is saved. If you call up this operating mode again later, there are two possibilities:

- the operating mode has been changed on the other screen.
- the operating mode has not been changed.

In the first case, the operating mode appears as it is on the other screen.

In the second case, the setting appears on the screen as it was when you last exited the operating mode.

Picture settings

Overview

You can select picture settings in video DVD and AUX mode (▷ page 498).

Adjusting the brightness, contrast and color

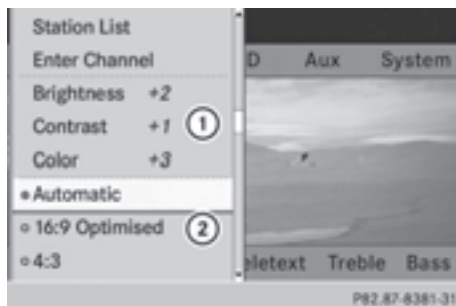

Example: TV mode











- ① Brightness, contrast and color
- ② Picture formats

- ▶ Switch on video DVD mode (▷ page 492).









- ▶ **To show the menu:** press the  button on the remote control.

or

- ▶ While the navigation menu is shown, (▷ page 474) select **Menu** and press the  button to confirm.

- ▶ Select **DVD-Video** using the    buttons and press the  button to confirm.
- ▶ Select **Brightness**, **Contrast** or **Color** using the   buttons and press the  button to confirm. An adjustment scale appears.
- ▶ Select a setting using the   buttons and press the  button to confirm.

Changing the picture format





- ▶ **To show the menu:** press the  button on the remote control.
- or
- ▶ While the navigation menu is shown, (▷ page 474) select **Menu** and press the  button to confirm.
 - ▶ Select **DVD-Video** using the    buttons and press the  button to confirm. The dot in front of one of the menu items **16:9 Optimized**, **4:3** or **Widescreen** indicates the format currently selected.
 - ▶ Select a format using the   buttons and press the  button to confirm.









System settings

Note





You can adjust almost all system settings individually for each screen without affecting the other screen. You make these settings using the remote control (▷ page 482).

Selecting the display language

- ▶ Select **System** using the    buttons on the remote control and press  to confirm. You see the system menu on the selected rear screen.









- ▶ Select **Settings** using the  button and press  to confirm.
- ▶ Select **Language** using the   buttons and press the  button to confirm. The list of languages appears. A • dot indicates the current setting.
- ▶ Select a language using the   buttons and press the  button to confirm. The Rear Seat Entertainment System activates the selected language.

Switching the display design





- ▶ Select **Settings** using the  button and press  to confirm.
- ▶ Select **Day Mode**, **Night Mode** or **Automatic** using the   buttons and press the  button to confirm. The dot indicates the current setting.

Design	Explanation
Day Mode	The display is set permanently to day design.
Night Mode	The display is set permanently to night design.
Automatic	The display design changes depending on the vehicle instrument cluster illumination.

Setting the brightness

- ▶ Select **Settings** using the  button and press  to confirm.
- ▶ Select **Brightness** using the   buttons and press the  button to confirm. A scale appears.
- ▶ Adjust the brightness using the   buttons and press the  button to confirm. The brightness bar moves up or down. The picture becomes lighter or darker in accordance with the scale.

Showing/hiding the picture

- ▶ **To hide the picture:** select **Display Off** in the system menu using the   buttons on the remote control and press the  button to confirm. The picture is hidden.
- ▶ **To display the picture:** press the  button.

CD/audio DVD and MP3 mode

Important safety notes

WARNING

The CD/DVD drive is a class 1 laser product. If you open the housing of the CD/DVD drive, there is a risk of exposure to invisible laser radiation. This laser radiation could damage your retina. There is a risk of injury.

Never open the housing. Always have maintenance and repair work carried out at a qualified specialist workshop.

General notes

You will find information on the following topics in the Audio section:

- notes on CDs/DVDs (▷ page 452)
- notes on MP3 mode (▷ page 451)
- notes on copyright (▷ page 452)

Inserting a CD/DVD



- ① Disc slot
- ② Disc eject button

Depending on the vehicle model and equipment level, the CD/DVD drive is found:

- behind the center console in a folding compartment, or
- under the rear bench seat, or
- in the stowage box between the rear seats

The CD/DVD drive is a single disc drive. If there is already a disc inserted, this must be ejected before another is inserted.

- ▶ Insert a disc into the disc slot.

The printed side of the disc must face upwards. If neither side of the disc is printed, the side you wish to play must face downwards.





The CD/DVD drive draws in the disc.

The CD/DVD drive plays the disc:

- if it has been inserted correctly and is a permissible disc, and
- after you have switched to disc mode (audio CD/audio DVD/MP3 mode) (▷ page 489)

Data on an MP3 CD first needs to be loaded by the drive. Loading may take some time, depending on the number of folders and tracks.



Switching to audio CD, audio DVD or MP3 mode

- ▶ Insert a CD/DVD (▷ page 489). The Rear Seat Entertainment System loads the inserted disc.
- ▶ Select **Disc** in the menu using the    buttons on the remote control and confirm by pressing the  button. The corresponding mode is switched on. The Rear Seat Entertainment System plays the disc.



- i** Variable bit rates in MP3 tracks can result in the elapsed time shown being different from the actual elapsed time.

Selecting a track

Selecting by skipping to a track

- ▶ To skip forwards or backwards to a track: press the  or  button on the remote control.

or

- ▶ Press the  or  button. The skip forward function skips to the next track.





If the elapsed track time has passed 8 seconds, the function skips back to the beginning of the track. If the elapsed time is shorter, it will skip to the start of the previous track.

If the **Random Tracks** or **Random Folder** playback option has been selected, the track order is random.





Selecting by track list

In audio CD mode, the track list contains all tracks on the disc currently playing. In audio DVD mode, the track list contains all tracks in the currently active group.

In MP3 mode, the track list shows all tracks in the currently active folder as well as the folder structure, allowing you to select any track on the MP3 CD.

- ▶ Select **Track List** (audio CD/DVD mode) or **Folder** (MP3 mode) using the    buttons on the remote control, and confirm by pressing the  button.

or

- ▶ Press the  button when the display/selection window is active. The track list appears. The  dot indicates the current track.
- ▶ Select a track using the   buttons and press the  button to confirm.

Making a selection by entering the track number directly

- ▶ Press the  button on the remote control. The track entry display appears.

Example: track 2



- ▶ Press number button 2.

Example: track 12



- ▶ Press the corresponding number keys in rapid succession.
- ▶ Wait for approximately three seconds after making the entry. You will hear the track which has been entered. The corresponding basic menu then reappears.

 It is not possible to enter numbers that exceed the number of tracks on the CD or in the currently active folder.

Fast forwarding/rewinding





- ▶ With the display/selection window active, press the  or  button on the remote control repeatedly until you reach the desired position.

or

- ▶ Press and hold the  or  button until the desired position is reached.

Selecting a folder

This function is only available in MP3 mode.

- ▶ Select **Folder** in MP3 mode using the    buttons on the remote control and press the  button to confirm.

or

- ▶ Press the  button when the display/selection window is active. The folder content appears.

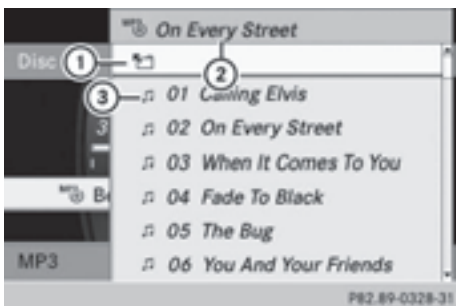

- ① Folder selection symbol
- ② Current folder name
- ③ Track symbol

► **To switch to the superordinate folder:** select symbol ① using the buttons on the remote control and press the button to confirm. The display shows the next folder up.

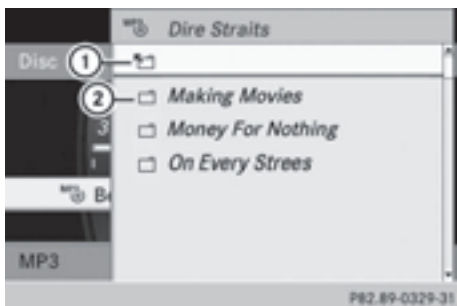

- ① Folder selection symbol
 - ② Folder symbol
- Select a folder using the buttons and press the button to confirm. You will see the tracks in the folder.
- Select a track using the buttons and press the button to confirm. The track is played and the corresponding folder is now the active folder.

Pause function

This function is only available in audio DVD mode.

- **To pause playback:** select using the buttons on the remote control and press the button to confirm. The display changes to .
- **To continue playback:** select and press the button to confirm. The display changes to .

Stop function





This function is only available in audio DVD mode.

- **To interrupt playback:** select using the buttons on the remote control and press the button to confirm. The display changes to .
- **To continue playback:** select and press the button to confirm. Playback continues from the point where it was interrupted.
- **To stop playback:** while playback is interrupted, select again and press the button to confirm. Playback stops and returns to the beginning of the DVD. is highlighted.
- **To restart playback:** select and press the button to confirm. Playback starts from the beginning of the DVD.

Setting the audio format





The content of an audio DVD can be divided into up to 9 groups. The availability and type of group depends on the respective DVD. A group can contain music in different sound qualities (stereo and multichannel formats, for example), or bonus tracks.



- Select **DVD-Audio** using the buttons on the remote control and press to confirm.
- Select **Group** using the buttons and press the button to confirm. The list of available audio formats appears. The ● dot indicates the format currently selected.

- ▶ Select an audio format using the   buttons and press the  button to confirm.
- ▶ **To exit the menu:** press the  or  button.

Playback options

Further information on playback options is available in the "Audio" section (▷ page 450).

- ▶ Select **CD, DVD-Audio** or **MP3** using the    buttons on the remote control and press the  button to confirm. The options list appears. The  dot indicates the option currently selected.

- ▶ Select **Normal Track Sequence, Random Tracks** or **Random Folder** using the   buttons and press the  button to confirm.







The option is switched on. For all options except **Normal Track Sequence**, you will see a corresponding display in the display/selection window.

-  If you switch the data carrier which you are currently listening to, the **Normal Track Sequence** option is activated automatically. If an option is selected, it remains selected after the Rear Seat Entertainment System is switched on or off.

Switching track information on/off (MP3 mode only)

If the function is switched on, folder and track names are displayed.

If the function is switched off, disc and file names are displayed.

- ▶ Select **MP3** using the    buttons on the remote control and press the  button to confirm.
- ▶ Select **Display Track Information** using the   buttons and press the  button to confirm. The function is switched on or off , depending on the previous status.

Video DVD mode

Important safety notes

WARNING

The CD/DVD drive is a class 1 laser product. If you open the housing of the CD/DVD drive, there is a risk of exposure to invisible laser radiation. This laser radiation could damage your retina. There is a risk of injury.

Never open the housing. Always have maintenance and repair work carried out at a qualified specialist workshop.

General notes

DVD playback conditions

Playback problems may occur when playing copied discs. There is a large variety of discs, DVD authoring software, writing software and writers available. This variety means that there is no guarantee that the Rear Seat Entertainment System will be able to play video DVDs that you have copied yourself.

Further information can be found under video (▷ page 474). Information regarding COMAND also applies to the Rear Seat Entertainment System.





Function restrictions

Depending on the DVD, it is possible that certain functions or actions described in this section will be temporarily blocked or may not function at all. As soon as you try to activate these functions or actions, you will see the  symbol in the display.

Switching to video DVD mode

- ▶ Insert a video DVD (▷ page 489). The Rear Seat Entertainment System loads the disc. If disc mode was the last mode selected, it will now be active.

If it was not, switch on video DVD mode as described in the following instruction.

- ▶ Select **Disc** in the menu using the    buttons on the remote control and confirm by pressing the .

If the video DVD fulfills the playback criteria, the film either starts automatically or the menu stored on the DVD appears. If the DVD menu appears, you must start the film manually.

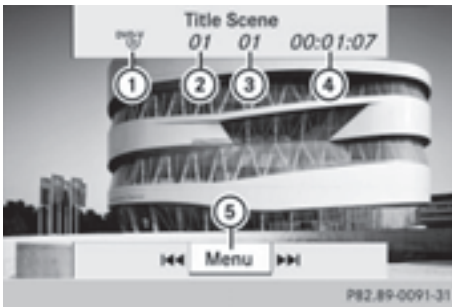

- ▶ Select the corresponding menu item in the DVD menu.

Showing/hiding the control menu



Control menu displayed

- ① Type of data medium
- ② Current title
- ③ Current scene
- ④ Track time
- ⑤ Shows the menu

- ▶ **To show:** press the  or  button on the remote control.

- ▶ **To hide:** press the  or  button.

or

- ▶ Wait about eight seconds.

Showing/hiding the menu





Example: menu shown

- ① Video DVD options
- ② Pause function
- ③ Stop function
- ④ Media selection
- ⑤ Sound settings



- ▶ **To show:** press the  button on the remote control.

or

- ▶ Select **Menu** while the control menu is shown and press the  button to confirm.

- ▶ **To hide:** press the  button, select **Full Screen** and press the  button to confirm.

Fast forwarding/rewinding





- ▶ Press and hold the  or  button on the remote control until the desired position has been reached.
You see the control menu.



Pause function

- ▶ **To show the menu:** press the  button on the remote control.

or

- ▶ Select **Menu** while the control menu is shown and press the  button to confirm.

- ▶ **To pause playback:** select  and press the  button to confirm.
The  display changes to .





- ▶ **To continue playback:** select  and press the  button to confirm. The menu is hidden.



Stop function



- ▶ **To show the menu:** press the  button on the remote control.



or

- ▶ Select **Menu** while the control menu is shown and press the  button to confirm.

- ▶ **To interrupt playback:** select  and press the  button to confirm. The  display changes to . The video image is hidden.

- ▶ **To continue playback:** select  and press the  button to confirm. Playback continues from the point where it was interrupted. The menu is hidden.

- ▶ **To stop playback:** while playback is interrupted, select  again and press the  button to confirm. Playback stops and returns to the beginning of the DVD.  is highlighted.



- ▶ **To restart playback:** select  and press the  button to confirm. Playback starts from the beginning of the DVD.

Selecting a scene/chapter



General notes

Observe the information on DVD video mode (▷ page 476).

Skipping forwards/backwards









- ▶ Press the  or  button on the remote control.

or

- ▶ Press the  or  button. The navigation menu (▷ page 474) appears for approximately eight seconds.



Selecting a scene/chapter directly

These examples illustrate how to select scene/chapter 5.



- ▶ **Option 1:** while the film is playing, press the  button on the remote control.
- ▶ Press the corresponding number key, such as **5**.
- ▶ **Option 2:** while the film is playing, press the  button on the remote control and show the menu.
- ▶ Select **DVD-V** and press the  button to confirm.
- ▶ Select **DVD Functions** and press the  button to confirm.
- ▶ Select **Scene Selection** and press the  button to confirm.
- ▶ Select **5** using the  or  button and press the  button to confirm. In both cases, playback will begin from the fifth scene/chapter after a brief pause.

Selecting a film/track

Option 1:

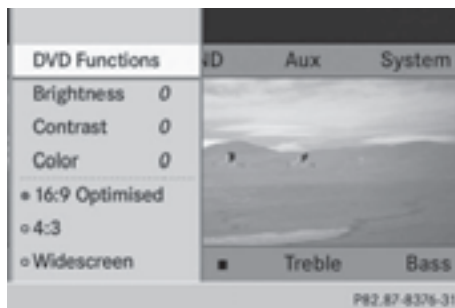
- ▶ Press the  button on the remote control and show the menu.
- ▶ Select **DVD-Video** and press the  button on the remote control to confirm.



- ▶ Select **DVD Functions** and press the  button to confirm.
- ▶ Select **Title Selection** and press the  button to confirm.

- ▶ **To call up the selection list:** press the **OK** button.
- ▶ Select a film/title.

Option 2:

Example: selecting film 2

- ▶ Press button **2**.
After a brief pause, the second film is played.

DVD menu

Calling up the DVD menu

The DVD menu is the menu stored on the DVD itself. It is structured in various ways according to the individual DVD and permits certain actions and settings.

In the case of multi-language DVDs, for example, you can change the DVD language in the DVD menu.

- ▶ Press the **OK** button on the remote control and show the menu.
- ▶ Select **DVD-Video** and press the **OK** button on the remote control to confirm.
- ▶ Select **DVD Functions** and press the **OK** button to confirm.
- ▶ Select **Menu** and press the **OK** button to confirm.
The DVD menu appears.

Selecting menu items in the DVD menu



- ▶ Select a menu item using the **▲** **▼** **◀** **▶** buttons on the

remote control and press the **OK** button to confirm.

A menu appears.

- ▶ Confirm **Select** by pressing the **OK** button. The Rear Seat Entertainment System carries out the action or shows a submenu.
- ▶ If available, additional options can now be selected. The Rear Seat Entertainment System then switches back to the DVD menu.

i Menu items which cannot be selected are shown in gray.

i Depending on the DVD, the menu items: **Back (to the movie)**, **Play**, **Stop**, **◀◀**, **▶▶** or **Go Up** may either not function at all or may not function at certain points in the DVD menu. To indicate this, the **⊘** symbol appears in the display.

Stopping a film or skipping to the beginning or end of a scene

- ▶ Select any menu item from the DVD menu. The menu appears.
- ▶ **To stop the film:** select the **Stop** menu item and press the **OK** button on the remote control to confirm.
- ▶ **To skip to the end of a scene:** select the **▶▶** menu item and press the **OK** button to confirm.
- ▶ **To skip to the beginning of a scene:** select the **◀◀** menu item and press the **OK** button to confirm.

Moving up one level in the DVD menu

- ▶ Show the DVD menu.
- ▶ Press the **⏪** back button on the remote control or select the corresponding menu item in the DVD menu.

or

- ▶ Select any menu item in the DVD menu and press **⊘** the COMAND controller to confirm.
- ▶ Select **Go Up** and press **⊘** to confirm.

Back to the film

- ▶ Press the **BACK** button repeatedly until you see the movie.
- or
- ▶ Select any menu item in the DVD menu and press **OK** to confirm.
- ▶ Select the **Back (to the movie)** menu item in the menu and press the **OK** button to confirm.

Setting the audio format

This function is not available on all DVDs. If it is available, you can set the audio language or the audio format. The number of settings is determined by the DVD content. It may also be possible to access the settings from the DVD menu.

- ▶ Press the **OK** button on the remote control and show the menu.
- ▶ Select **DVD-Video** and press the **OK** button on the remote control to confirm.
- ▶ Select **DVD Functions** and press the **OK** button to confirm.
- ▶ Select **Audio Language** and press the **OK** button to confirm.
A menu appears after a short while. The • dot in front of an entry indicates the currently selected language.
- ▶ Select a language using the **▲** **▼** buttons and press the **OK** button to confirm.
- ▶ **To exit the menu:** press the **◀** or **▶** button.

Subtitles and camera angle

These functions are not available on all DVDs. The number of subtitle languages and camera angles available depends on the content of the DVD. It may also be possible to access the settings from the DVD menu.

- ▶ Press the **OK** button on the remote control and show the menu.
- ▶ Select **DVD-Video** and press the **OK** button on the remote control to confirm.

- ▶ Select **DVD Functions** and press the **OK** button to confirm.
- ▶ Select **Subtitles** or **Camera Angle** and press the **OK** button to confirm.
In both cases, a menu appears after a few seconds. The • dot in front of an entry indicates the current setting.
- ▶ Select a setting using the **▲** **▼** buttons and press the **OK** button to confirm.
- ▶ **To exit the menu:** press the **◀** or **▶** button.

Interactive content

DVDs can also contain interactive content (e.g. a video game). In a video game, you may be able to influence events by selecting and triggering actions. The type and number of actions depend on the DVD.

- ▶ Select an action using the **▲** **▶** **▼** **◀** buttons on the remote control and press the **OK** button to execute it.
A menu appears and the first entry, **Select**, is highlighted.
- ▶ Press the **OK** button.

Operation with an active COMAND source

Switching the function on/off in COMAND

You can transfer an audio or video source selected in COMAND to the Rear Seat Entertainment System. If you subsequently switch modes in COMAND, the new source will not be transmitted to the Rear Seat Entertainment System.

- ▶ **To switch on the function in COMAND:** switch to the desired audio mode in COMAND, e.g. CD mode (▷ page 446), or show the menu in video DVD mode (▷ page 474).
- ▶ Select the menu item at the bottom left, e.g. **CD** in audio CD mode, by sliding **⊙** ↓

and turning **[OK]** the COMAND controller and press **[OK]** to confirm.

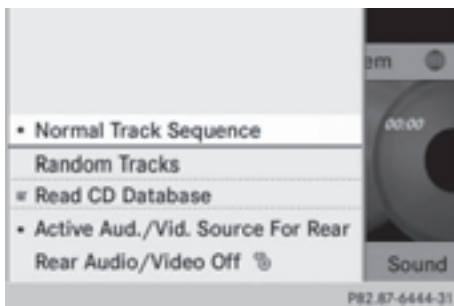

- ▶ Select **Active Aud./Vid. Source For Rear** and press **[OK]** to confirm.

In the status bar at the top, you will see the headphones icon and the **[CD]** icon for the source that has been switched on.

- ▶ **To switch off the function in COMAND:** switch on the desired audio mode in COMAND or show the menu in video DVD mode.

- ▶ Select the menu item at the bottom left, e.g. **CD** in audio CD mode, by sliding **[CD]** and turning **[OK]** the COMAND controller and press **[OK]** to confirm.
- ▶ Select **Rear Audio/Video Off** **[CD]** and press **[OK]** the COMAND controller to confirm.

Selecting an active COMAND source on the rear-compartment screen

Loading the active COMAND source

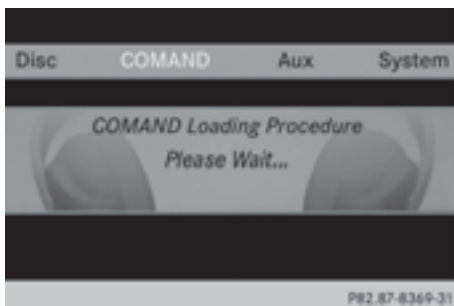

- ▶ Select **COMAND** using the **[Up]** **[Left]** **[Right]** buttons on the remote control and press **[OK]** to confirm.

The audio or video source selected in COMAND is loaded in the Rear Seat Entertainment System.

When the loading process is complete, the audio or video source is set in the Rear Seat Entertainment System.

If **Rear Audio/Video Off** is activated in COMAND, the **COMAND is off or there is no active COMAND source** message appears.

Audio CD mode

- ▶ **To select by skipping to a track:** press the **[Left]** or **[Right]** button.

or

- ▶ Press the **[Fast Left]** or **[Fast Right]** button.

The skip forward function skips to the next track.

If the elapsed track time has exceeded 8 seconds, the function skips back to the beginning of the track.

If the elapsed track time is less than 8 seconds, the function skips back to the beginning of the previous track.

Additional setting option:

- Adjusting the sound settings (> page 487)

Audio DVD mode

- ▶ **To skip to the next/previous group:** press the **[Down]** button on the remote control.

- ▶ To select **[Fast Left]** **[Fast Right]**: highlight using the **[Left]** or **[Right]** button and press **[OK]**.

Additional setting option:

- Adjusting the sound settings (> page 487)

MP3 mode

▶ To select a track by skipping to a track:

press the  or  button on the remote control.

or

▶ Press the or button.

The skip forward function skips to the next track.

If the elapsed track time has exceeded 8 seconds, the function skips back to the beginning of the track.

If the elapsed track time is less than 8 seconds, the function skips back to the beginning of the previous track.

▶ To select a folder: press the button on the remote control.

▶ Highlight one of the two folder symbols with the or button and press to confirm.

Depending on your selection, the previous or next folder is selected and the first track is played.

Additional setting option:

- Adjusting the sound settings (▷ page 487)

Video DVD mode

▶ To hide a menu: confirm **Menu** with the button.

The video image is played in full screen mode.

Additional setting options:

- Adjusting the brightness, contrast and color (▷ page 487)
- Changing the picture format (▷ page 488)
- Adjusting the sound settings (▷ page 487)

AUX mode

Introduction

You can connect one external video source to each of the displays of the Rear Seat Entertainment System (AUX display) and also one external video source to the rear-compartment

CD/DVD drive (AUX drive) with a sound and video signal.

Please see the corresponding operating instructions for information on how to operate the external video source.

For further details about external video sources, please consult an authorized Mercedes-Benz Center.

Connecting AUX equipment

AUX drive

The AUX drive jacks are located on the CD/DVD drive next to the CD/DVD eject button (▷ page 483).

Displaying AUX







The AUX display jacks are on the side of the screen (▷ page 482).

Audio and video connection







- ▶ Insert the audio plugs for the left and right signals into the corresponding **L** and **R** jacks.
- ▶ Insert the video plug into the **V** jack.

Activating AUX mode





AUX drive

- ▶ Select **Aux** in the menu using the    buttons on the remote control and press the  button to confirm. The AUX menu appears.
- ▶ Select **Source** from the AUX menu and press the  button to confirm.
- ▶ Select **Disc Drive Aux** and press the  button to confirm. You will hear and see the content of the external video source if it is connected to the CD/DVD drive and switched to playback. If no video image is available from the AUX source connected, you will see an audio menu.





Displaying AUX

- ▶ Select the screen by turning the scroll wheel on the remote control (▷ page 482) until "L REAR " (left screen) or "REAR R" (right screen) is highlighted in the window.
- ▶ Select **Aux** in the menu using the    buttons on the remote control and press the  button to confirm.
- ▶ Select **Source** from the AUX menu and press the  button to confirm.
- ▶ Select **Display Aux** and press the  button to confirm.
You will see and hear the content of the video source if it is switched to playback. If no video image is available from the AUX source connected, you will see an audio menu.





Adjusting treble and bass

- ▶ Select **Treble** or **Bass** in the AUX menu and press the  button on the remote control to confirm.
An adjustment scale appears.
- ▶ Select a setting using the  or  button and press the  button to confirm.

Adjusting the brightness, contrast or color

- ▶ Select **Display Aux** or **Disc Drive Aux** in the AUX menu and press the  button to confirm.
- ▶ Select **Brightness, Contrast** or **Color** and press the  button to confirm.
An adjustment scale appears.
- ▶ Select a setting using the  or  button and press the  button to confirm.

Changing the picture format

- ▶ Select **Display Aux** or **Disc Drive Aux** in the AUX menu and press the  button to confirm.
- ▶ Select **16:9 Optimized, 4:3** or **Wide-screen** using the   buttons and press the  button to confirm.
The dot in front of a menu item indicates the current setting.

SIRIUS weather

Your COMAND equipment

These operating instructions describe all the standard and optional equipment for your COMAND system, as available at the time of going to print. Country-specific differences are possible. Please note that your COMAND system may not be equipped with all the features described.

Introduction

-  This function is currently not available for Canada.

For the reception of weather forecasts via satellite radio, you will need a SIRIUS XM Satellite Weather subscription.

When the **Call SIRIUS to activate system at 888-539-7474** message with the SIRIUS device identification number appears, you will first have to obtain access to the weather service. A description of the procedure can be found in the "Registering satellite radio" section (▷ page 440).

COMAND can receive weather forecasts via satellite radio for the entire USA (including Alaska and Hawaii). The received weather data can be displayed as an information chart (daily forecast, five-day forecast, detailed information) or on the weather map.

The weather data received from a weather station is stored in COMAND for one hour. It can therefore be displayed again immediately

after restarting the engine (for example after refueling).

The weather map can display the following weather data with symbols:

- rain radar
- storm characteristics
- areas of high-pressure/low-pressure, weather fronts
- course of tropical cyclones (hurricanes, typhoons)
- wind direction and speeds

i The rain radar cannot be displayed for Alaska, Hawaii and Puerto Rico.

i Hurricane: term used to describe the tropical cyclones that primarily develop in the Atlantic, North Pacific and South Pacific oceans. The wind speeds are above 74 mph (118 km/h). Five categories are used to classify the strength of a hurricane.

Typhoon: term used to describe a tropical cyclone that develops in the northwestern Pacific. The wind speeds are in the category of a hurricane.

Switching the SIRIUS Weather display on/off

Activating

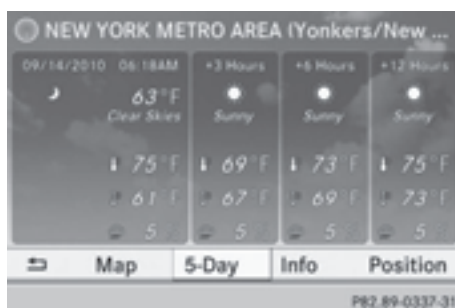
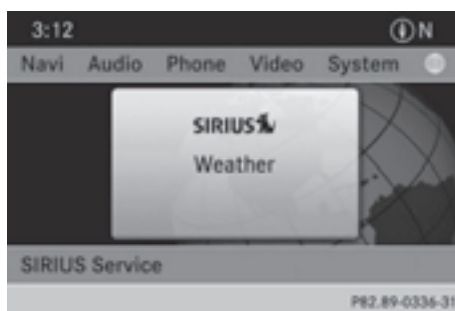

Example: daily forecast as an information chart

- Select the symbol in the main function bar by sliding and turning the COMAND controller and pressing to confirm.

The SIRIUS Weather basic display appears.

- Confirm **SIRIUS Weather** by pressing . The information chart shows the daily forecast at the current vehicle position.

You see the following information:

- the date and time of the weather message received last
- information on the current weather (temperature, cloud cover) and forecast for the next 3, 6, 12 hours
- the current highest temperature and forecast
- the current lowest temperature and forecast
- the probability of rain

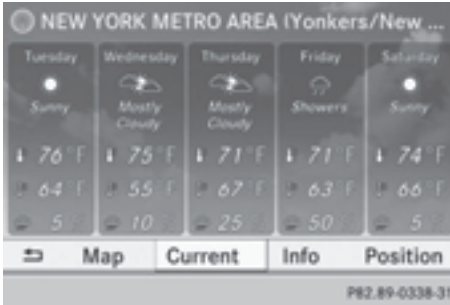

Example: five-day forecast as an information chart

- ▶ **To switch to the five-day forecast:** confirm **5-Day** by pressing

The information chart displays the forecast for the next five days in the currently selected location.

- ▶ **To return to the daily forecast:** confirm **Current** by pressing .

Deactivating

- ▶ Press the **BACK** back button.

or

- ▶ Select **Back** by turning the COMAND controller and confirm by pressing . Both options appear in the SIRIUS Weather basic display.

Displaying detailed information

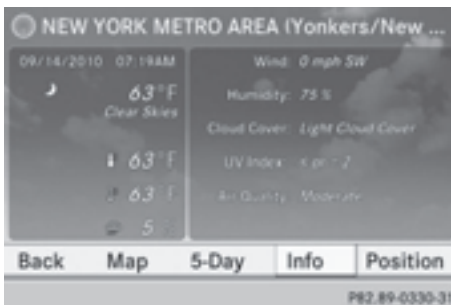

Besides the current temperatures, you can display information such as wind speeds and UV index.

- ▶ Select **Info** in the information chart by turning the COMAND controller and press to confirm. The information chart shows detailed information for the selected area.

Selecting the area for the weather forecast

Introduction

You can select the following areas:

- the current vehicle position
- vicinity of the destination
- a winter sports area
- an area within the USA

You can select an area in the information chart (option 1), on the map (option 2) or from the memory. To select from the memory you must first save an area (▶ page 503).

- ▶ **i** COMAND receives weather forecast data from the nearest weather station at the selected location.

Selecting the location in the information chart



"Selecting the area for the weather forecast" menu

- ▶ Select **Position** in the information chart by turning the COMAND controller and press to confirm. A menu appears.
 - ▶ **To select the current vehicle position:** select **Current Position** and press to confirm. COMAND receives the weather data for the current vehicle position from the nearest weather station and displays it automatically.
 - ▶ **To select the vicinity of the destination:** select **Near Destination** in the menu by turning the COMAND controller and press to confirm.
- i** You can select **Near Destination** once a route has been calculated (> page 327). The menu item is otherwise grayed out.



Selecting a state (searching for winter sport areas)

- ▶ **To select winter sport areas:** select **In Winter Sports Areas** in the menu, and confirm by pressing .
- ▶ Select a state, e.g. **Colorado**, and press to confirm.
- ▶ Select a winter sports area from the menu and press to confirm. The weather data and other information is displayed for the winter sports area that has been selected. The data is supplied by the nearest weather station. The information chart shows the following information (if available):
 - ski slopes/ski lifts
 - snowboarding and nighttime opening
 - snow conditions (e.g. snow depth)
 - temperature



Selecting a state (searching for an area)



- ▶ **To search for an area:** select a state, e.g. **Florida** and press .

- ▶ Select a category, e.g. **Daytona Beach**, and press to confirm. The information chart shows the weather forecast for the selected area. The data is supplied by the nearest weather station.

Selecting the location in the weather map

- ▶ Call up the weather map (▷ page 503).
- ▶ Move the weather map so that the cross-hair is over the desired area (▷ page 504).
- ▶ Press the COMAND controller. The information chart shows the weather forecast for the selected area. The data is supplied by the nearest weather station.

Memory functions

Storing the area in the weather memory

For areas that are frequently called up, 10 presets (0 – 9) are available in the weather memory.

- ▶ **In the weather memory:** select the area for the weather forecast (▷ page 501). The selected area is shown at the top in the status bar.
- ▶ Select **Position** in the information chart by turning the COMAND controller and press to confirm.
- ▶ Select **Memory** and press to confirm.
- ▶ Select the preset by turning or sliding the COMAND controller.
- ▶ Press and hold the COMAND controller until you hear a tone. The area is entered on the selected preset.
- ▶ **To store rapidly:** in the daily forecast (▷ page 500) press and hold a number key, e.g. , until the preset position number

is shown in the status bar in front of the area name.

- i** You can also use this function:
 - in the five-day forecast (▷ page 501)
 - in the detailed information view (▷ page 501).

Selecting an area from the weather memory

- ▶ **From the weather memory:** in the information chart, select **Position** by turning the COMAND controller and press to confirm.
- ▶ Select **Memory** and press to confirm.
- ▶ Select a preset that contains an entry by turning or sliding the COMAND controller and press to confirm. The weather data for the selected area is displayed.
- ▶ **Rapid selection:** if there is an entry available in the weather memory, e.g. when the daily forecast is shown, briefly press a number key, such as . The weather data for the selected area is displayed.

Weather map

Calling up the weather map



Example: weather map

- ▶ Select **Map** in the information chart by turning **Ⓜ** the COMAND controller and press **Ⓜ** to confirm.

The weather map is shown on a 500-mi or 500-km scale.

- i** For the map display, you can activate the topographic map style (▷ page 369).

Moving the weather map

- ▶ Slide **←→**, **↑↓** or **↻** the COMAND controller. The weather map moves in the corresponding direction under the crosshair.

Changing the scale



- ▶ As soon as you turn **Ⓜ** the COMAND controller, you see the scale bar.
- ▶ Turn **Ⓜ** until the desired scale is set.

Showing/hiding the menu in the weather map



- ▶ **To show:** press **Ⓜ** the COMAND controller in the weather map.
- ▶ **To hide:** slide up **↑** the COMAND controller.

Selecting a weather station in the map

- ▶ Move the weather map and crosshair to the desired position (▷ page 504).
- ▶ Press **Ⓜ** the COMAND controller. The menu is shown.
- ▶ Confirm **Display Weather** by pressing **Ⓜ**. COMAND receives the weather data for the selected position from the nearest weather station and displays it automatically as a daily forecast.

Switching layers on the map on/off

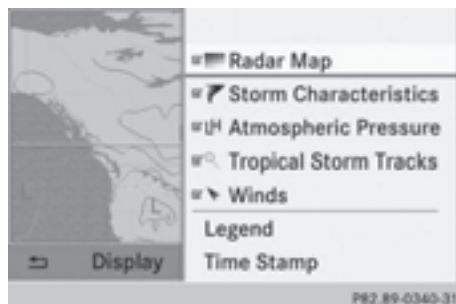

You can switch on different layers, for example to display the rain radar, weather fronts and the course of tropical storms on the map.

- ▶ Display the menu on the weather map (▷ page 504).
- ▶ Select **Map Options** by turning **Ⓜ** the COMAND controller and pressing **Ⓜ** to confirm. A menu appears.
- ▶ Select the layer by turning **Ⓜ** or sliding **↑↓** the COMAND controller and press **Ⓜ** to confirm. Switch the display on or off .

Explanation of the layers on the weather map

Layer	Map display	Selectable scales
Radar Map	Shows the rain radar as a colored area on the map. For an explanation of the colors, see the legend (▷ page 508).	All
Storm Characteristics	Shows the characteristics of a storm Characteristics are: <ul style="list-style-type: none"> • tornadic storm: storm cell with strong winds (super cell), from which a tornado can develop. Tornadoes are also known as twisters. • cyclone: storm cells from which a tornadic storm can develop • hailstorm • the likelihood of a hailstorm 	All
Atmospheric Pressure	Shows the position of high and low-pressure areas (H, L), weather fronts and isobars	200 miles (200 km) 500 miles (500 km)
Tropical Storm Tracks	Shows the path/directional movement speed of a tropical storm with time and strength information	All
Winds	Shows the wind direction and wind speed	5 miles (5 km)

Sample displays of weather data in the map



Weather map showing the rain radar

Conditions: the [Radar Map](#) layer is active (▷ page 504) and weather data is available.

The precipitation radar legend can be called up at (▷ page 508).



Displaying storm characteristics

Conditions: the **Storm Characteristics** layer is active (▷ page 504) and weather data is available.

The example shows hail showers and tornadic storms together with direction and speed of propagation.

The storms legend can be called up (▷ page 508).

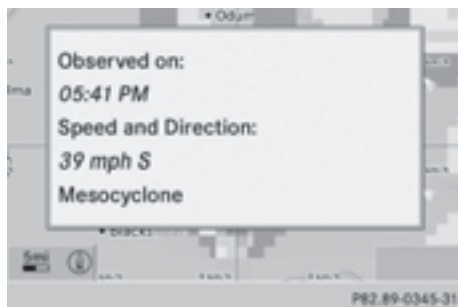

Example: weather map with information on a cyclone

► Slide ←→, ↑↓ or ↻ the COMAND controller and move the crosshair onto a corresponding symbol.

► Press the COMAND controller.

The following information is shown (if available):

- characteristics of the storm cell
- date and time of observation (time stamp)
- directional movement speed and path

i The directional movement speed is the speed at which the storm cell moves.



Example: weather map showing weather fronts

Conditions: the **Atmospheric Pressure** layer is switched on (▷ page 504) and weather data is available.

The example shows the position of high and low-pressure areas (H, L), weather fronts and isobars.

i Isobars are lines that show where the air pressure is the same.

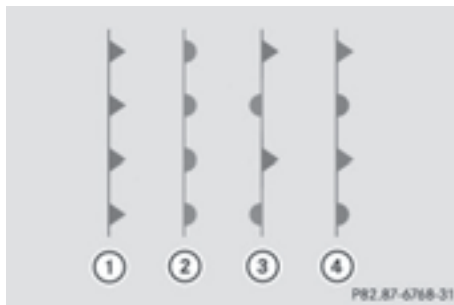

Legend: weather fronts

- ① Cold front (blue line with blue triangles)
- ② Warm front (red line with red semi-circles)
- ③ Stationary front (red-blue line with red semi-circles and blue triangles)
- ④ Occlusion (violet line with a violet semi-circle and triangles)

Weather front	Explanation
Cold front	If a cold front moves in, the weather remains changeable and there are often rain showers and thunderstorms. The air temperature decreases.
Warm front	This can mean longer periods of rain and can lead to an increase in cloud cover and a slow increase in temperature.

Weather front	Explanation
Stationary front	The weather front moves minimally. The weather remains changeable in this area.
Occlusion	This occurs when a faster cold front reaches an advancing warm front and combines with it. The weather remains changeable and rainy within an occlusion.



Example: weather map showing the progress of a tropical storm

- ① Position on the forecast path
- ② Current position of the cyclone
- ③ Position on the previous path

Conditions: the **Tropical Storm Tracks** layer is switched on (▷ page 504) and weather data is available.

A dotted line shows the previous path and the forecast path of a tropical low-pressure area (cyclone).

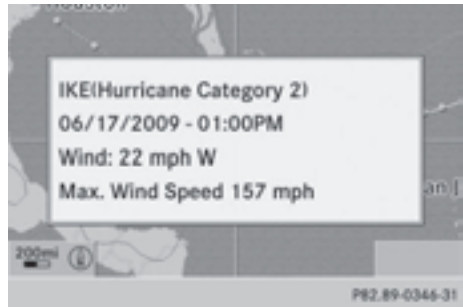

Information on a cyclone

You can select individual points (①, ② and ③) on the path and display further information on them.

- ▶ In the map, slide ←⊙→, ↑⊙↓ or ↻⊙↻ the COMAND controller and slide the crosshair to ①, ② or ③.
- ▶ Press ⊙ the COMAND controller.

Showing information (if available):

- name of the tropical storm and category
- Time stamp
- directional movement speed and path (**Wind**)
- maximum wind speed (**Max. Wind Speed**)

- ❗ The directional movement speed is the speed at which the storm cell of a tropical storm moves.

A tropical storm is separated into different categories according to the location at which it develops.

Region of origin	Category
Atlantic, North and South Pacific Oceans	Tropical Low Pressure System
Atlantic, North and South Pacific Oceans	Tropical Rain Zone
Atlantic, North and South Pacific Oceans	Tropical Storm

Region of origin	Category
Atlantic, North and South Pacific Oceans	Hurricane Category 1 to Hurricane Category 5
Northwestern Pacific Ocean	Tropical Low Pressure System
Northwestern Pacific Ocean	Tropical Cyclone
Northwestern Pacific Ocean	Typhoon
Northwestern Pacific Ocean	Super-Typhoon



You can also see the time stamp for the weather data on map scales of 50 miles and smaller.

The weather map shows wind directions and wind speeds.

Legend (precipitation radar and storms)

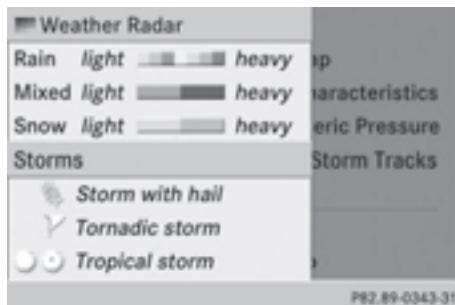

- ▶ Display the menu on the weather map (▷ page 504).
- ▶ Select **Map Options** by turning the COMAND controller and pressing to confirm.
- ▶ Select **Legend** and press to confirm.
- i** The symbol for a tornadoic storm is also valid for a cyclone (mesocyclone).

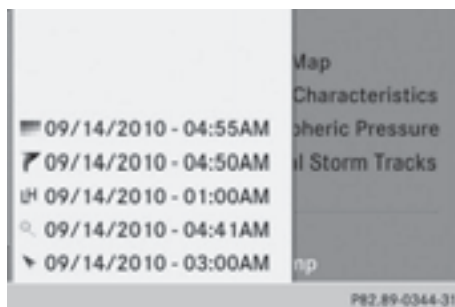

Precipitation type	Color scale
Rain	Seven color levels from light (light green) to heavy (red)
Mixed	Light (light violet) to heavy (violet)
Snow	Light (light turquoise) to heavy (turquoise)

Time stamp



The time stamp shows when the weather data was created by the weather station.

A time stamp corresponds to the time at the vehicle's current position. The changeover from summer time to standard time is performed automatically.

- ▶ Display the menu on the weather map (▷ page 504).
- ▶ Select **Map Options** by turning  the COMAND controller and pressing  to confirm.
- ▶ Select **Time Stamp** and press  to confirm.

Changing to the information chart

- ▶ Display the menu on the weather map (▷ page 504).
- ▶ Select **Display Weather** and press  to confirm.

Useful information	512
Stowage areas	512
Features	516

Useful information

- i** This Operator's manual describes all models and all standard and optional equipment of your vehicle available at the time of publication of the Operator's manual. Country-specific differences are possible. Please note that your vehicle may not be equipped with all features described. This also applies to safety-related systems and functions.
- i** Read the information on qualified specialist workshops (▷ page 35).

Stowage areas

Stowage space

Important safety notes

⚠ WARNING

If you do not correctly store objects in the vehicle interior, they can slip or be flung around, thus striking vehicle occupants. There is a risk of injury, especially when braking or abruptly changing directions.

- Always store objects so that they cannot be flung around in these or in similar situations.
- Always make sure that objects do not protrude from stowage compartments, parcel nets or stowage nets.
- Close lockable stowage compartments while driving.
- Stow and secure objects that are heavy, hard, pointy, sharp-edged, fragile or too large in the trunk.

Glove box



- ▶ **To open:** pull handle ① and open glove box flap ②.
- ▶ **To close:** fold glove box flap ② upwards until it engages.

In the glove box, there are a coin holder, a map holder and a pen holder.

- i** The glove box can be ventilated (▷ page 148).

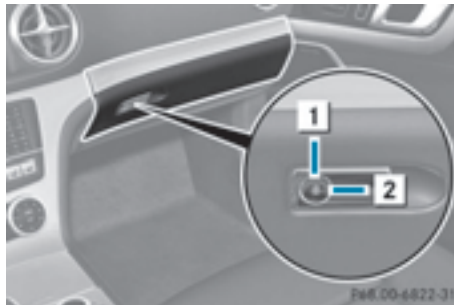

The glove box can be locked and unlocked using the mechanical key.

- ▶ **To lock:** insert the mechanical key into the lock and turn it to position ②.
- ▶ **To unlock:** insert the mechanical key into the lock and turn it to position ①.

Stowage compartment/telephone compartment under the armrest

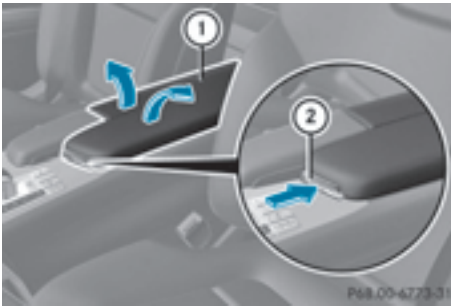

- ▶ **To open:** press button (2).
Armrest (1) opens.

In the stowage compartment, there is a stowage tray.

- i** Depending on the vehicle equipment, a 12 V power socket, USB port or a Media Interface is installed in the stowage compartment. A Media Interface is a universal interface for mobile audio equipment, e.g. for an iPod® or MP3 Player (▷ page 465).

Eyeglasses compartment

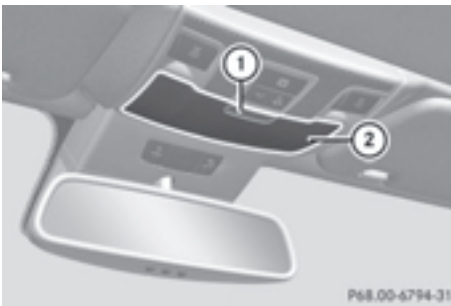

- ▶ **To open:** press marking (1).
Eyeglasses compartment (2) opens.

Make sure that the eyeglasses compartment is always closed while the vehicle is in motion.

Stowage compartment in the center console



- ▶ **To open:** press the trim element on cover (1).
- ▶ **To remove the rubber mat:** grasp the tabs on the rubber mat and pull up to remove.
- ▶ **To insert the rubber mat:** press the rubber mat into the housing.
- ▶ **To close:** swing cover (1) downwards until it engages.

You can remove the rubber mat from the stowage compartment to clean it. Clean with clear, lukewarm water only.

Depending on the vehicle's equipment, there is a cup holder and an ashtray in the center console stowage compartment.

Umbrella holder



Example: vehicle side, left

There are umbrella holders in the door stowage compartments on both sides of the vehicle. One compact umbrella can be stowed per side.

- ▶ **To remove:** grab strap ② and pull umbrella holder ① out of the stowage compartment in the direction of the arrow.
- ▶ **To insert:** push umbrella holder ① in the opposite direction to the arrow, into the stowage compartment until it engages.

You can remove the umbrella holder to clean it. Clean with clear, lukewarm water only.

Stowage compartment in the rear center console



- ▶ **To open:** slide cover ① in the direction of the arrow.

On vehicles equipped with a bottle holder, the bottle holder is located in the stowage compartment (▷ page 516).

Stowage compartment in the rear

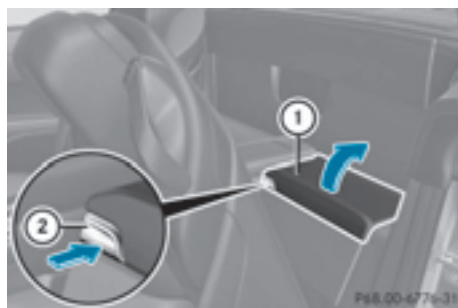

There is a stowage compartment in the rear on the left-hand side only.

- ▶ Open the seat belt guide and remove the seat belt (▷ page 111).
- ▶ Move the left-hand front seat forwards (▷ page 111) and fold the backrest forwards.
- ▶ **To open:** press release button ②. Cover ① folds upwards.
- ▶ **To close:** fold down cover ① and let it engage.
- ▶ Fold the backrest of the left-hand front seat back and move the seat backwards (▷ page 111).
- ▶ Route the seat belt back through the seat belt guide.

Stowage net



There is a stowage net ① in the front-passenger footwell.

Loading aid in the trunk

Raising/lowering the roof

WARNING

Body parts can become trapped when the roof is being raised or lowered. There is a risk of injury.

When raising or lowering the roof, make sure that no parts of the body are in the vicinity of moving parts. Press the switch again if someone becomes trapped.

! Only close the trunk once the roof is lowered completely. Otherwise, you could damage the roof.

If you close the trunk lid before the roof is lowered completely, the loading aid switch lights up and a warning tone sounds.

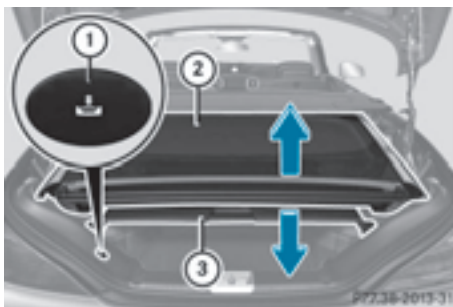

To make it easier to load your luggage, you can raise the stowed roof after you have opened the trunk lid.

You can only raise roof (2) if trunk partition (3) is closed and the trunk lid is opened completely.

- ▶ **To raise the roof:** press switch (1).
The roof is raised slightly. Switch (1) lights up brightly.
- ▶ Slide trunk partition (3) back (▷ page 103).

You can only lower roof (2) if trunk partition (3) is closed and the trunk lid is opened completely.

- ▶ **To lower the roof:** close the trunk partition (▷ page 103).
- ▶ Press switch (1).
The roof is lowered slightly. Switch (1) lights up dimly.

Vehicles with trunk lid remote closing feature: when the trunk lid is opened, the loading aid raises automatically. It lowers automatically when the trunk lid is closed.

Problems with the loading aid

Problem	Possible causes/consequences and ► Solutions
It is no longer possible to lower the stowed roof in the trunk using the loading aid.	You cannot close the trunk any more. ► Call a qualified specialist workshop.

Stowage well under the trunk floor



- **To open:** open trunk partition ③ (► page 103).
- Swing trunk floor ④ up by loop ②.
- Pull hook with Velcro attachment ① off the underside of trunk floor ④.
- Attach hook with Velcro attachment ① to trunk partition ③ by its handle.

The TIREFIT kit, tire-change tool kit, etc. are located in the stowage compartment.

Features

Cup holder

Important safety notes

WARNING

If you do not correctly store objects in the vehicle interior, they can slip or be flung around, thus striking vehicle occupants. There is a risk of injury, especially when braking or abruptly changing directions.

- Always store objects so that they cannot be flung around in these or in similar situations.
- Always make sure that objects do not protrude from stowage compartments, parcel nets or stowage nets.
- Close lockable stowage compartments while driving.
- Stow and secure objects that are heavy, hard, pointy, sharp-edged, fragile or too large in the trunk.

 Only use the cup holders for containers of the right size and which have lids. The drinks could otherwise spill.

Cup holder in the center console

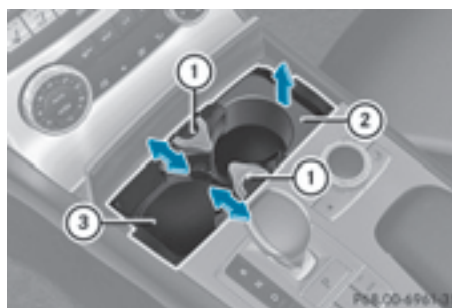

- **To open:** open stowage compartment ③ (► page 513).
- **To remove the insert:** slide catches ① inwards in the direction of the arrow.
- Remove the cup holder insert upwards.

- ▶ **To re-install the insert:** place the insert in stowage compartment ③.
- ▶ Slide catches ① outwards in the direction of the arrow until they engage.

You can remove the cup holder's rubber mat for cleaning. Clean with clear, lukewarm water only.

Reducer ② can be removed. Large and small containers can then be placed in the cup holder.

- ▶ **To remove:** grasp reducer ② and pull upwards in the direction of the arrow.
- ▶ **To insert:** insert reducer ② into the cup holder in the opposite direction of the arrow and press it down firmly.

Bottle holder

Observe the "Important safety notes" in the "Stowage compartments" section (▷ page 512).

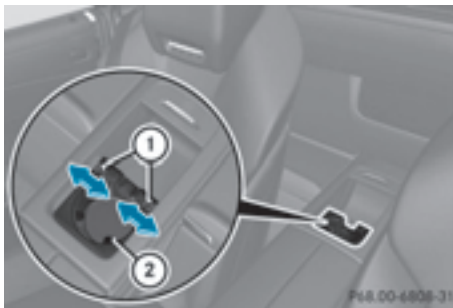

- ▶ **To open:** open the stowage compartment (▷ page 514).
- ▶ **To remove the insert:** slide catches ① inwards in the direction of the arrow.
- ▶ Lift bottle holder insert ② up and remove.
- ▶ **To re-install the insert:** place insert ② in the stowage compartment.
- ▶ Slide catches ① outwards in the direction of the arrow until they engage.

The bottle holder does not secure the bottles; it merely prevents them from tipping over.

Sun visors

Overview

⚠ WARNING

If the mirror cover of the vanity mirror is folded up when the vehicle is in motion, you could be blinded by incident light. There is a risk of an accident.

Always keep the mirror cover folded down while driving.

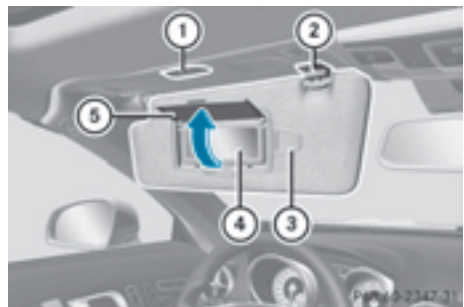

- ① Mirror light
- ② Bracket
- ③ Retaining strip, e.g. for a parking lot ticket
- ④ Vanity mirror
- ⑤ Mirror cover

Vanity mirror in the sun visor

Mirror light ① only functions if the sun visor is clipped into bracket ② and mirror cover ⑤ has been folded up.

Glare from the side

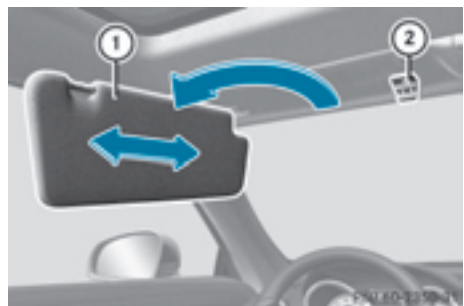

- ▶ Fold down sun visor ①.
- ▶ Pull sun visor ① out of retainer ②.
- ▶ Swing sun visor ① to the side.
- ▶ Slide sun visor ① horizontally as required.

Ashtray

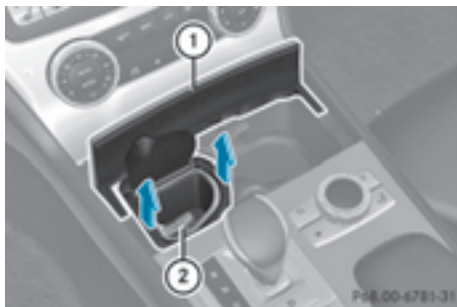

- ▶ **To open:** open stowage compartment ① (▷ page 513).
- ▶ **To remove the insert:** pull insert ② up in the direction of the arrow, out of the cup holder.
- ▶ **To re-install the insert:** push insert ② on the left-hand side into the cup holder.

i Only re-install insert ② on the left-hand side of the cup holder.

Cigarette lighter

⚠ WARNING

You can burn yourself if you touch the hot heating element or the socket of the cigarette lighter.

In addition, flammable materials can ignite if:

- the hot cigarette lighter falls
- a child holds the hot cigarette lighter to objects, for example

There is a risk of fire and injury.

Always hold the cigarette lighter by the knob. Always make sure that the cigarette lighter is out of reach of children. Never leave children unsupervised in the vehicle.

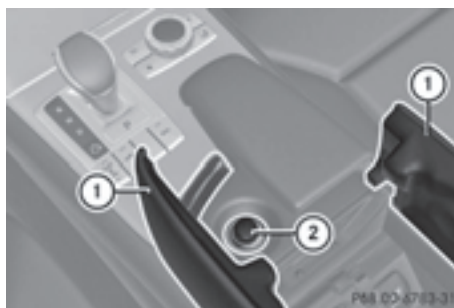

Your attention must always be focused on the traffic conditions. Only use the cigarette lighter when road and traffic conditions permit.

- ▶ Turn the SmartKey to position **2** in the ignition lock (▷ page 151).
- ▶ **To open:** open stowage compartment ① under the armrest (▷ page 513).
- ▶ Press in cigarette lighter ②. Cigarette lighter ② will pop out automatically when the heating element is red-hot.

12 V sockets

General notes

- ▶ Turn the SmartKey to position **1** in the ignition lock (▷ page 151).

The sockets can be used for accessories with a maximum draw of 180 W (15 A). Accessories include such items as lamps or chargers for mobile phones.

If you use the sockets for long periods when the engine is switched off, the battery may discharge.

- i** An emergency cut-out ensures that the on-board voltage does not drop too low. If the on-board voltage is too low, the power to the sockets is automatically cut. This ensures that there is sufficient power to start the engine.

Socket in the front-passenger footwell

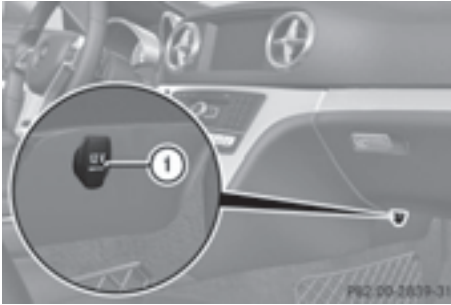

- ▶ Lift up the cover of socket ①.

Socket under the armrest

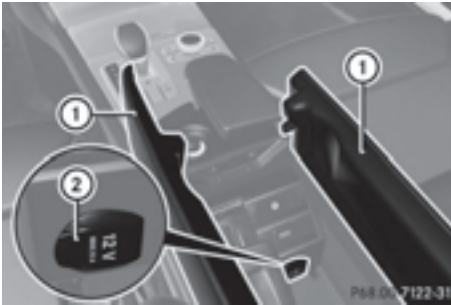

- ▶ Open the stowage compartment under armrest ① (▷ page 513).
- ▶ Lift up the cover of socket ②.

Socket in the trunk

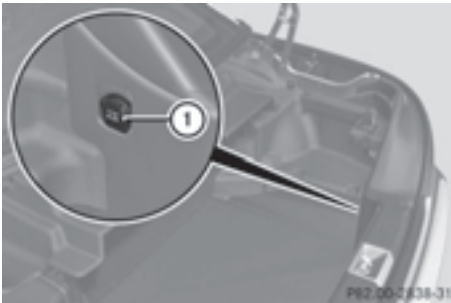

- ▶ Lift up the cover of socket ①.

mbrace

General notes

You must have a license agreement to activate the mbrace service. Make sure that your system is activated and operational. To log in, press the  MB Info call button. If any of the steps mentioned are not carried out, the system may not be activated.

If you have questions about the activation, contact one of the following telephone hot-lines:

- **USA:** Mercedes-Benz Customer Assistance Center at 1-800-FOR-MERCEdes (1-800-367-6372) or 1-866-990-9007
- **Canada:** Customer Service at 1-888-923-8367

Shortly after successfully registering with the service, a user ID and password will be sent to you by post.

USA only: you can use this password to log onto the mbrace area under "Owners Online" at <http://www.mbusa.com>.



The system is available if:

- it has been activated and is operational
- the corresponding mobile phone network is available for transmitting data to the Customer Center
- a service subscription is available
- the starter battery is sufficiently charged

- i Determining the location of the vehicle on a map is only possible if:
 - GPS reception is available.
 - the vehicle position can be forwarded to the Customer Assistance Center.

The mbrace system

To adjust the volume during a call, proceed as follows:

- ▶ Press the  or  button on the multifunction steering wheel.

or

- ▶ Use the volume controller of COMAND.

The system offers various services, e.g.:





- Automatic and manual emergency call
- Roadside Assistance call
- MB Info call

USA only: you can find information and a description of all available features under "Owners Online" at <http://www.mbusa.com>.

System self-test

After you have switched on the ignition, the system carries out a self-diagnosis.

A malfunction in the system has been detected if one of the following occurs:

- The indicator lamp in the SOS button does not come on during the system self-test.
- The indicator lamp in the  Roadside Assistance button does not light up during self-diagnosis of the system.
- The indicator lamp in the  MB Info call button does not light up during self-diagnosis of the system.
- The indicator lamp in one or more of the following buttons continues to light up red after the system self-diagnosis:
 - SOS button
 -  Roadside Assistance call button
 -  MB Info call button
- After the system self-diagnosis, the **Inoperative** or **Service Not Activated** message appears in the multifunction display.

If a malfunction is indicated as outlined above, the system may not operate as expected. In the event of an emergency, help will have to be summoned by other means.

Have the system checked at the nearest authorized Mercedes-Benz Center or contact the following service hotlines:

- **USA:** Mercedes-Benz Customer Assistance Center at 1-800-FOR-MERCEdes (1-800-367-6372) or 1-866-990-9007
- **Canada:** Customer Service at 1-888-923-8367

Emergency call

Important safety notes

WARNING

It can be dangerous to remain in the vehicle, even if you have pressed the SOS button in an emergency if:

- you see smoke inside or outside of the vehicle, e.g. if there is a fire after an accident
- the vehicle is on a dangerous section of road
- the vehicle is not visible or cannot easily be seen by other road users, particularly when dark or in poor visibility conditions

There is a risk of an accident and injury.

Leave the vehicle immediately in this or similar situations as soon as it is safe to do so. Move to a safe location along with other vehicle occupants. In such situations, secure the vehicle in accordance with national regulations, e.g. with a warning triangle.

You must have a license agreement to activate the mbrace service. Make sure that your system is activated and operational. To register, press the  MB Info call button. If any of the steps mentioned are not carried out, the system may not be activated.

If you have questions about the activation, contact one of the following telephone hotlines:

- **USA:** Mercedes-Benz Customer Assistance Center at 1-800-FOR-MERCEdes (1-800-367-6372) or 1-866-990-9007
- **Canada:** Customer Service at 1-888-923-8367

General notes

An emergency call is dialed automatically if an air bag or Emergency Tensioning Device is triggered.

- i** You cannot end an automatically triggered emergency call yourself.

An emergency call can also be initiated manually.

As soon as the emergency call has been initiated, the indicator lamp in the SOS button flashes. The multifunction display shows the **Connecting Call** message.

The audio output is muted.

Once the connection has been made, the **Call Connected** message appears in the multifunction display.

All important information on the emergency is transmitted, for example:

- current location of the vehicle (as determined by the GPS system)
- vehicle identification number
- information on the severity of the accident

Shortly after the emergency call has been initiated, a voice connection is automatically established between the Customer Assistance Center and the vehicle occupants.

- If the vehicle occupants respond, the Mercedes-Benz Customer Assistance Center attempts to get more information on the emergency.
- If there is no response from the vehicle occupants, an ambulance is immediately sent to the vehicle.

If no voice connection can be established to the Mercedes-Benz Customer Assistance Center, the system has been unable to initiate an emergency call.

This can occur, for example, if the relevant mobile phone network is not available. The indicator lamp in the SOS button flashes continuously.

The **Call Failed** message appears in the multifunction display and must be confirmed.

In this case, summon assistance by other means.

Making an emergency call



- ▶ **To initiate an emergency call manually:** press cover ① briefly to open.
- ▶ Press SOS button ② briefly. The indicator lamp in SOS button ② flashes until the emergency call is concluded.
- ▶ Wait for a voice connection to the Mercedes-Benz Customer Assistance Center.
- ▶ After the emergency call, close cover ①.

- i** If the mobile phone network is unavailable, mbrace will not be able to make the emergency call. If you leave the vehicle immediately after pressing the SOS button, you will not know whether mbrace placed the emergency call. In this case, always summon assistance by other means.

Roadside Assistance button



- ▶ Press Roadside Assistance button ①. This initiates a call to the Mercedes-Benz Customer Assistance Center. The indicator lamp in Roadside Assistance button ① flashes while the call is active. The multifunction display shows the **Connecting Call** message. The audio output is muted.

If a connection can be made, the **Call Connected** message appears in the multifunction display.

If a mobile phone network and GPS reception are available, the system transfers data to the Mercedes-Benz Customer Assistance Center, for example:

- current location of the vehicle
- vehicle identification number

- ① The COMAND display indicates that a call is active. During the call, you can change to the navigation menu by pressing the NAVI button on COMAND, for example.

Voice output is not available.

A voice connection is established between the Mercedes-Benz Customer Assistance Center and the vehicle occupants.

From the vehicle remote malfunction diagnosis, the Mercedes-Benz Customer Assistance Center can ascertain the nature of the problem (▶ page 526).

The Mercedes-Benz Customer Assistance Center either sends a qualified Mercedes-Benz technician or makes arrangements for your vehicle to be transported to the nearest authorized Mercedes-Benz Center.

You may be charged for services such as repair work and/or towing.

Further details are available in your mbrace manual.

- ① The system has not been able to initiate a Roadside Assistance call, if:

- the indicator lamp for Roadside Assistance call button ① is flashing continuously.
- no voice connection to the Mercedes-Benz Customer Assistance Center was established.

This can occur if the relevant mobile phone network is not available, for example.

The **Call Failed** message appears in the multifunction display.

- ▶ **To end a call:** press the  button on the multifunction steering wheel.

or

- ▶ Press the corresponding button for ending a phone call on COMAND.

MB Info call button



- ▶ Press MB Info call button ①. This initiates a call to the Mercedes-Benz Customer Assistance Center. The indicator lamp in MB Info call button ① flashes while the connection is being made. The multifunction display shows the **Connecting Call** message. The audio system is muted.

If a connection can be made, the **Call Connected** message appears in the multifunction display.

If a mobile phone network and GPS reception are available, the system transfers data to the Mercedes-Benz Customer Assistance Center, for example:

- current location of the vehicle
- vehicle identification number

i The COMAND display indicates that a call is active. During the call, you can change to the navigation menu by pressing the NAVI button on COMAND, for example.

Voice output is not available.

A voice connection is established between the Mercedes-Benz Customer Assistance Center and the vehicle occupants.

You receive information about operating your vehicle, about the nearest authorized Mercedes-Benz Center and about other products and services from Mercedes-Benz.

USA only: you can find further information on the mbrace system under "Owners Online" at <http://www.mbusa.com>.

i The system has not been able to initiate an MB Info call, if:

- the indicator lamp in MB Info call button  is flashing continuously.
- no voice connection to the Mercedes-Benz Customer Assistance Center was established.

This can occur if the relevant mobile phone network is not available, for example.

The **Call Failed** message appears in the multifunction display.

▶ **To end a call:** press the  button on the multifunction steering wheel.

or

▶ Press the corresponding button for ending a phone call on COMAND.

Call priority

When service calls are active, e.g. Roadside Assistance or MB Info calls, an emergency call can still be initiated. In this case, an emer-

gency call will take priority and override all other active calls.

The indicator lamp of the respective button flashes until the call is ended.

An emergency call can only be terminated by the Mercedes-Benz Customer Assistance Center.

All other calls can be ended by pressing:

- the  button on the multifunction steering wheel
- or the corresponding COMAND button for ending a telephone call

i When a call is initiated, the audio system is muted. The mobile phone is no longer connected to COMAND. However, if you want to use your mobile phone, do so only when the vehicle is stationary and in a safe location.

Downloading destinations in COMAND

Downloading destinations

Downloading destinations gives you access to a database with over 15 million points of interest (POIs). These can be downloaded on the navigation system in your vehicle. If you know the destination, the address can be downloaded. Alternatively, you can obtain the location of Points of Interest (POIs)/important destinations in the vicinity.

Furthermore, you can download routes with up to 20 way points.

You are prompted to confirm route guidance to the address entered.

The system calculates the route and subsequently starts the route guidance with the address entered.

i If you select **No**, the address can be saved in the address book.

i The destination download function is available if the relevant mobile phone network is available and data transfer is possible.

- i** The destination download function can only be used if the vehicle is equipped with a navigation system.

Route Assistance

This service is part of the mbrace PLUS Package and cannot be purchased separately.

- i** You can also use the Route Assistance function if your vehicle is not equipped with a navigation system.

Within the framework of this service, you receive a professional and reliable form of navigation support without having to leave your vehicle.

The customer service representative finds a suitable route depending on your vehicle's current position and the desired destination. You will then be guided live through the current route section.

Search and Send

General notes

- i** To use "Search & Send", your vehicle must be equipped with mbrace and a navigation system. Additionally, an mbrace service subscription must be completed.

"Search & Send" is a destination entry service. A destination address which is found on Google Maps® can be transferred via mbrace directly to your vehicle's navigation system.



Specifying and sending the destination address

- ▶ Go to the website <http://www.maps.google.com> and enter a destination address into the entry field.
- ▶ **To send the destination address to the e-mail address of your mbrace account:** click on the corresponding button on the website.
- i** Example:
If you select 'Send to vehicle' and then 'Mercedes-Benz', the destination address will be sent to your vehicle.

- ▶ When the "Send" dialog window appears:
Enter the e-mail address you specified when setting up your mbrace account into the corresponding field.
- ▶ Click "Send".

- i** Information on specific commands such as "Address entry" or "Send" can be found on the website.

Calling up destination addresses

- ▶ Switch on the ignition.
The destination address is loaded into the vehicle's navigation system.
A display message appears, asking whether navigation should be started.
- ▶ Select **Yes** by turning  or sliding  the COMAND controller and press  to confirm.
The system calculates the route and subsequently starts the route guidance with the address entered.

- i** If you select **No**, the address can be saved in the address book.

- i** If you have sent more than one destination address, each individual destination must be confirmed separately.

- i** Destination addresses are loaded in the same order as the order in which they were sent.

If you own multiple Mercedes-Benz vehicles with mbrace and activated mbrace accounts:

If multiple vehicles are registered under the same e-mail address, the destination will be sent to all the vehicles.

Vehicle remote opening

You can use the vehicle remote opening if you have unintentionally locked your vehicle and a replacement SmartKey is not available.

The vehicle can be opened by the Mercedes-Benz Customer Assistance Center.

The vehicle can be immediately opened remotely within four days of the ignition being turned off. After this time, the remote unlocking may be delayed by 15 to 60 minutes. After 30 days, the vehicle can no longer be opened remotely.

- ▶ Contact the following service hotlines:
 - **USA:** Mercedes-Benz Customer Assistance Center at 1-800-FOR-MERcedes (1-800-367-6372) or 1-866-990-9007
 - **Canada:** Customer Service at 1-888-923-8367

You will be asked for your password.

- ▶ Return to your vehicle at the time agreed upon with the Mercedes-Benz Customer Assistance Center.

USA only: alternatively, the vehicle can be opened via:

- the Internet, under the "Owners Online" section
- the telephone applications (e.g. iPhone®, Blackberry)

To do this, you will need your identification number and password.

- i** Vehicle remote opening is only possible if the corresponding mobile phone network is accessible.

Vehicle remote closing

The vehicle remote locking feature can be used when you have forgotten to lock the vehicle and you are no longer nearby.

The vehicle can then be locked by the Mercedes-Benz Customer Assistance Center.

The vehicle can be immediately remotely locked within four days of the ignition being turned off. After this time, remote locking may be delayed by 15 to 60 minutes. After 30 days the vehicle can no longer be locked remotely.

- ▶ Contact the following service hotlines:

- **USA:** Mercedes-Benz Customer Assistance Center at 1-800-FOR-MERcedes (1-800-367-6372) or 1-866-990-9007
- **Canada:** Customer Service at 1-888-923-8367

You will be asked for your password.

The next time you are inside the vehicle and you switch on the ignition, the **Doors Locked Remotely** message appears in the multifunction display.

USA only: alternatively, the vehicle can be locked via:

- the Internet, under the "Owners Online" section
- the telephone applications (e.g. iPhone®, Blackberry)

To do this, you will need your identification number and password.

- i** The vehicle remote closing feature is available when the relevant mobile phone network is available and data connection is possible.

Stolen vehicle recovery service

If your vehicle has been stolen:

- ▶ Notify the police.
The police will issue a numbered incident report.
- ▶ This number will be forwarded to the Mercedes-Benz Customer Assistance Center together with your PIN.
The Mercedes-Benz Customer Assistance Center then tries to locate the system. The Mercedes-Benz Customer Assistance Center contacts you and the local law enforcement agency if the vehicle is located.
However, only the law enforcement agency is informed of the location of the vehicle.

- i** If the anti-theft alarm system is activated for longer than 30 seconds, the Mercedes-Benz Customer Assistance Center is automatically notified.

Vehicle remote malfunction diagnosis

With the vehicle remote malfunction diagnosis (Vehicle Health Check), the Customer Assistance center can provide improved support for problems with your vehicle. During an existing call, vehicle data is transferred to the Customer Assistance center. The customer service representative can use the received data to decide what kind of assistance is required. You are then, for example, guided to the nearest authorized Mercedes-Benz Center or a recovery vehicle is called.

If vehicle data needs to be transferred during an MB Info call or a Roadside Assistance call, this is initiated by the Customer Assistance center. You will see the **Roadside Assistance Connected** message in the COMAND display. If the vehicle remote malfunction diagnosis can be started, the **Request for vehicle diagnosis received. Start vehicle diagnosis?** message appears in the display.

- ▶ Confirm the message with **Yes**.
- ▶ When the **Vehicle Diagnosis Please start ignition** message appears, turn the SmartKey to position **2** in the ignition lock (▷ page 151).
- ▶ When the **Please follow the instructions received by phone and move your vehicle to a safe position.** message appears, follow the customer service representative's instructions. The message in the display disappears. If you select **Cancel**, the vehicle remote malfunction diagnosis is canceled completely. The vehicle operating state check begins. You will see the **Vehicle diagnosis activated.** message.

When the diagnosis is completed, the **Send vehicle diagnostics data/(Voice connection may be//interrupted during data transfer)** message appears. The vehicle data can now be sent to the Customer Assistance center.

- ▶ Press **OK** to confirm the message. The voice connection with the Customer Assistance center is terminated. You will see the **Vehicle Diagnosis: Transferring data...** message. The vehicle data is sent to the Customer Assistance center.

Depending on what the customer service representative agreed with you, the voice connection is re-established after the transfer is complete. If necessary, you will be contacted at a later time by another means, e.g. by e-mail or phone.

Further functions of the vehicle remote malfunction diagnosis include, for example:

- transfer of service data to the Customer Assistance center. If a service is overdue, the COMAND display shows a message about various special offers at your workshop.
- monthly status information e-mail on oil level, air pressure, maintenance, brakes, etc. If applicable, you will receive information on special offers in the e-mail. USA only: this information can also be called up under "Owners Online" at <http://www.mbusa.com>.

Information on the data stored in the vehicle (▷ page 36).

Information on Roadside Assistance (▷ page 32).

Downloading routes

Downloading routes allows you to transfer and save predefined routes in the navigation system. To do this, an SD memory card must be inserted into the COMAND system. If no SD memory card is inserted, you must insert the card into the card slot on the COMAND system before saving.

A route can be prepared and sent either by a customer service representative or via the mbrace portal on the Internet.

Each route can include up to 20 way points. Once a route has been received by the navi-

gation system, you will see the <route name> has been saved to memory card. Do you want to start route guidance? message in the COMAND display. The route is saved to the SD memory card.

► **To start route guidance:** select **Yes**.

An overview of the route is shown in the display.

i If you select **No**, the saved route can be called up later via the navigation menu.

► Select **Start**.

Route guidance is started.

i Downloaded and saved data can be called up again in COMAND.

Further information can be found in the "COMAND", "Online and Internet functions", "Destination/route download" section..

Speed alert

You can define the upper speed limit, which must not be exceeded by the vehicle.

If this selected speed is exceeded by the vehicle, a message will be sent to the Customer Assistance Center. The Customer Assistance Center then forwards this information to you.

You can select the way in which you receive this information beforehand. Possible options include text message, e-mail or an automated call.

The data you receive contains the following information:

- the location where the speed limit was exceeded
- the time at which the speed limit was exceeded
- the selected speed limit which was exceeded

Geo fencing

Geo fencing allows you to select areas which the vehicle should not enter or leave. You will be informed if the vehicle crosses the bound-

aries of the selected areas. You can select the way in which you receive this information beforehand. Possible options include text message, e-mail or an automated call.

The area can be determined as either a circle or a polygon with a maximum of ten corners. You can specify up to ten areas simultaneously. Different settings are possible for each area.

USA only: these settings can be called up under "Owners Online" at <http://www.mbusa.com>.

Alternatively, you can trigger an MB Info call and inform the customer service representative that you wish to activate geo fencing.

Currently inactive areas can be activated by text message.

Triggering the vehicle alarm

With this function, you can trigger the vehicle's panic alarm via text message. An alarm sounds and the exterior lighting flashes. Depending on the setting, the panic alarm lasts five or ten seconds. Afterwards, the alarm switches off.

Garage door opener

General notes

The HomeLink® garage door opener integrated in the rear-view mirror allows you to operate up to three different door and gate systems.

Use the integrated garage door opener only on garage doors that:

- have safety stop and reverse features and
- meet current U.S. federal safety standards

Once programmed, the integrated garage door opener in the rear-view mirror will assume the function of the garage door system's remote control. Please also read the operating instructions for the garage door system.

When programming a garage door opener, park the vehicle outside the garage. Do not run the engine while programming.

Certain garage door drives are incompatible with the integrated garage door opener. If you have difficulty programming the integrated garage door opener, contact an authorized Mercedes-Benz Center.

Alternatively, you can call the following telephone assistance services:

- **USA:** Mercedes-Benz Customer Assistance Center at 1-800-FOR-MERCEdes
- **Canada:** Customer Service at 1-800-387-0100
- HomeLink® hotline 1-800-355-3515 (free of charge)

More information on HomeLink® and/or compatible products is also available online at <http://www.homelink.com>.

Notes on the declaration of conformity (> page 34).

USA: FCC ID: CB2HMIHL4

Canada: IC: 279B-HMIHL4

Important safety notes

WARNING

When you operate or program the garage door with the integrated garage door opener, persons in the range of movement of the garage door can become trapped or struck by the garage door. There is a risk of injury.

When using the integrated garage door opener, always make sure that nobody is within the range of movement of the garage door.

WARNING

Combustion engines emit poisonous exhaust gases such as carbon monoxide. Inhaling these exhaust gases leads to poisoning. There is a risk of fatal injury. Therefore never leave the engine running in enclosed spaces without sufficient ventilation.

Programming

Programming buttons

Pay attention to the "Important safety notes" (> page 528).

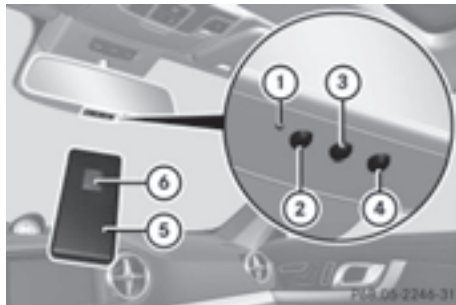

Garage door remote control ⑤ is not included with the integrated garage door opener.

- ▶ Turn the SmartKey to position **2** in the ignition lock (> page 151).
- ▶ Select one of buttons ② to ④ to use to control the garage door drive.
- ▶ **To start programming mode:** press and hold one of buttons ② to ④ on the integrated garage door opener. The garage door opener is now in programming mode. After a short time, indicator lamp ① lights up yellow. Indicator lamp ① lights up yellow as soon as button ②, ③ or ④ is programmed for the first time. If the selected button has already been programmed, indicator lamp ① will only light up yellow after ten seconds have elapsed.
- ▶ Release button ②, ③ or ④. Indicator lamp ① flashes yellow.
- ▶ **To program the remote control:** point garage door remote control ⑤ towards buttons ② to ④ on the rear-view mirror at a distance of 2 to 8 inches (5 to 20 cm).
- ▶ Press and hold button ⑥ on remote control ⑤ until indicator lamp ① lights up green. When indicator lamp ① lights up green: programming is finished.

When indicator lamp ① flashes green: programming was successful. The next step is to synchronize the rolling code.

- ▶ Release button ⑥ on remote control ⑤ for the garage door drive system. If indicator lamp ① lights up red: repeat the programming procedure for the corresponding button on the rear-view mirror. When doing so, vary the distance between remote control ⑤ and the rear-view mirror.

The required distance between remote control ⑤ and the integrated garage door opener depends on the garage door drive system. Several attempts might be necessary. You should test every position for at least 25 seconds before trying another position.

Synchronizing the rolling code

Pay attention to the "Important safety notes" (▷ page 528).

If the garage door system uses a rolling code, you will also have to synchronize the garage door system with the integrated garage door opener in the rear-view mirror. To do this you will need to use the programming button on the door drive control panel. The programming button may be positioned at different locations depending on the manufacturer. It is usually located on the door drive unit on the garage ceiling.

Familiarize yourself with the garage door drive operating instructions, e.g. under "Programming of additional remote controls", before carrying out the following steps.

Your vehicle must be within reach of the garage door or gate opener drive. Make sure that neither your vehicle nor any persons/objects are present within the sweep of the door or gate.

- ▶ Turn the SmartKey to position **2** in the ignition lock (▷ page 151).
- ▶ Get out of the vehicle.
- ▶ Press the programming button on the door drive unit.

Usually, you now have 30 seconds to initiate the next step.

- ▶ Get into the vehicle.
- ▶ Press previously programmed button ②, ③ or ④ on the integrated garage door opener until the door closes. The rolling code synchronization is then complete.

Notes on programming the remote control

Canadian radio frequency laws require a "break" (or interruption) of the transmission signals after broadcasting for a few seconds. Therefore, these signals may not last long enough for the integrated garage door opener. The signal is not recognized during programming. Comparable with Canadian law, some U.S. garage door openers also feature a "break".

Proceed as follows:

- if you live in Canada
- if you have difficulties programming the garage door opener (regardless of where you live) when using the programming steps.
- ▶ Press and hold one of buttons ② to ④ on the integrated garage door opener. After a short time, indicator lamp ① lights up yellow.
- ▶ Release the button. Indicator lamp ① flashes yellow.
- ▶ Press button ⑥ of garage door remote control ⑤ for two seconds, then release it for two seconds.
- ▶ Press button ⑥ again for two seconds.
- ▶ Repeat this sequence on button ⑥ of remote control ⑤ until indicator lamp ① lights up green. When indicator lamp ① lights up green: programming is finished.

When indicator lamp ① flashes green: programming was successful. The next step is to synchronize the rolling code.

- ▶ Release button ⑥ of remote control ⑤ of the garage door drive.

If indicator lamp ① lights up red: repeat the programming process for the corresponding button on the rear-view mirror. When doing so, vary the distance between remote control ⑤ and the rear-view mirror.

The required distance between remote control ⑤ and the integrated garage door opener depends on the garage door drive system. Several attempts might be necessary. You should test every position for at least 25 seconds before trying another position.

Problems when programming

If you are experiencing problems programming the integrated garage door opener on the rear-view mirror, take note of the following instructions:

- Check the transmitter frequency used by garage door drive remote control ⑤ and whether it is supported. The transmitter frequency can usually be found on the back of the garage door drive remote control.

The integrated garage door opener is compatible with devices that have units which operate in the frequency range of 280 to 433 MHz.

- Replace the batteries in garage door remote control ⑤. This increases the likelihood that garage door remote control ⑤ will transmit a strong and precise signal to the integrated garage door opener.
- When programming, hold remote control ⑤ at varying distances and angles from the button which you are programming. Try various angles at a distance between 2 and 12 inches (5 to 30 cm) or at the same angle but at varying distances.
- If another remote control is available for the same garage door drive, repeat the same programming steps with this remote control.

Before performing these steps, make sure that new batteries have been installed in garage door drive remote control ⑤.

- Note that some remote controls only transmit for a limited amount of time (the indicator lamp on the remote control goes out). Press button ⑥ on remote control ⑤ again before transmission ends.
- Align the antenna cable of the garage door opener unit. This can improve signal reception/transmission.

Opening/closing the garage door

After it has been programmed, the integrated garage door opener performs the function of the garage door system remote control. Please also read the operating instructions for the garage door system.

- ▶ Turn the SmartKey to position **2** in the ignition lock (▷ page 151).
- ▶ Press button ②, ③ or ④ which you have programmed to operate the garage door.
 - Garage door system with a fixed code: indicator lamp ① lights up green.
 - Garage door system with a rolling code: indicator lamp ① flashes green.

The transmitter will transmit a signal as long as the button is pressed. The transmission is halted after a maximum of ten seconds and indicator lamp ① lights up yellow. Press button ②, ③ or ④ again if necessary.

Clearing the memory

Make sure that you clear the memory of the integrated garage door opener before selling the vehicle.

- ▶ Turn the SmartKey to position **2** in the ignition lock (▷ page 151).
- ▶ Press and hold buttons ② and ④. The indicator lamp initially lights up yellow and then green.
- ▶ Release buttons ② and ④. The memory of the integrated garage door opener in the rear-view mirror is cleared.

Floormats

WARNING

Objects in the driver's footwell can restrict the pedal travel or obstruct a depressed pedal.

The operating and road safety of the vehicle is jeopardized. There is a risk of an accident.

Make sure that all objects in the vehicle are stowed correctly, and that they cannot enter the driver's footwell. Install the floormats securely and as specified in order to ensure sufficient clearance for the pedals. Do not use loose floormats and do not place floormats on top of one another.

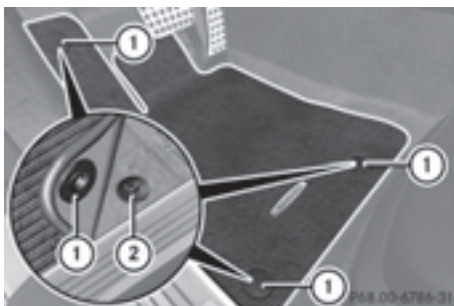

- ▶ Slide the seat backwards.
- ▶ **To install:** place the floormat in the footwell.
- ▶ Press studs ① onto retainers ②.
- ▶ **To remove:** pull the floormat off retainers ②.
- ▶ Remove the floormat.

Useful information	534
Engine compartment	534
ASSYST PLUS	538
Care	539

Useful information

- i** This Operator's manual describes all models and all standard and optional equipment of your vehicle available at the time of publication of the Operator's manual. Country-specific differences are possible. Please note that your vehicle may not be equipped with all features described. This also applies to safety-related systems and functions.
- i** Read the information on qualified specialist workshops (▷ page 35).

Engine compartment

Hood

Important safety notes

WARNING

If the hood is unlatched, it may open up when the vehicle is in motion and block your view. There is a risk of an accident. Never unlatch the hood while driving.

WARNING

When opening and closing the hood, it may suddenly fall into the closed position. There is a risk of injury to persons within range of movement of the hood.

Open and close the hood only when no one is within its range of movement.

WARNING

Opening the hood when the engine is overheated or when there is a fire in the engine compartment could expose you to hot gases or other service products. There is a risk of injury.

Let an overheated engine cool down before opening the hood. If there is a fire in the engine compartment, keep the hood closed and contact the fire department.

WARNING

The engine compartment contains moving components. Certain components, such as the radiator fan, may continue to run or start again suddenly when the ignition is off. There is a risk of injury.

If you need to do any work inside the engine compartment:

- switch off the ignition
- never reach into the area where there is a risk of danger from moving components, such as the fan rotation area
- remove jewelry and watches
- keep items of clothing and hair, for example, away from moving parts

Opening the hood

WARNING

Certain components in the engine compartment, such as the engine, radiator and parts of the exhaust system, can become very hot. Working in the engine compartment poses a risk of injury.

Where possible, let the engine cool down and touch only the components described in the following.

WARNING

When the hood is open and the windshield wipers are set in motion, you can be injured by the wiper linkage. There is a risk of injury.

Always switch off the windshield wipers and the ignition before opening the hood.

- !** Make sure that the windshield wipers are not folded away from the windshield. You could otherwise damage the windshield wipers or the hood.



- ▶ Make sure that the windshield wipers are turned off.
- ▶ Pull release lever ① on the hood. The hood is released.



- ▶ Reach into the gap, pull hood catch handle ② up and lift the hood. If you lift the hood by approximately 15 in (40 cm), the hood is opened and held open automatically by the gas-filled strut.

Closing the hood

- ▶ Lower the hood and let it fall from a height of approximately 8 in (20 cm).
- ▶ Check that the hood has engaged properly. If the hood can be raised slightly, it is not properly engaged. Open it again and close it with a little more force.

Engine oil

Notes on the oil level

Depending on your driving style, the vehicle consumes up to 0.9 US qt (0.8 liters) of oil per 600 miles (1,000 km). The oil consumption may be higher than this when the vehicle is new or if you frequently drive at high engine speeds.

Depending on the engine, the oil dipstick may be in a different location.

When checking the oil level:

- park the vehicle on a level surface.
- the engine should be switched off for approximately five minutes if the engine is at normal operating temperature.
- if the engine is not at normal operating temperature, e.g. if the engine was only started briefly, wait about 30 minutes before carrying out the measurement.

Checking the oil level using the oil dipstick

WARNING

Certain components in the engine compartment, such as the engine, radiator and parts of the exhaust system, can become very hot. Working in the engine compartment poses a risk of injury.

Where possible, let the engine cool down and touch only the components described in the following.

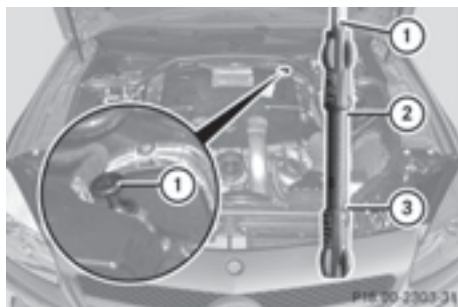

Example

- ▶ Pull oil dipstick ① out of the dipstick guide tube.
- ▶ Wipe off oil dipstick ①.
- ▶ Slowly slide oil dipstick ① into the guide tube to the stop, and take it out again. If the level is between MIN mark ③ and MAX mark ②, the oil level is correct.
- ▶ If the oil level has dropped to MIN mark ③ or below, add 1.1 US qt (1.0 liter) of engine oil.

Adding engine oil

WARNING

Certain components in the engine compartment, such as the engine, radiator and parts of the exhaust system, can become very hot. Working in the engine compartment poses a risk of injury.

Where possible, let the engine cool down and touch only the components described in the following.

WARNING

If engine oil comes into contact with hot components in the engine compartment, it may ignite. There is a risk of fire and injury.

Make sure that engine oil is not spilled next to the filler neck. Let the engine cool down and thoroughly clean the engine oil off the components before starting the engine.

Environmental note

When adding oil, take care not to spill any. If oil enters the soil or waterways, it is harmful to the environment.

- ❗ Only use engine oils and oil filters that have been approved for vehicles with a service system. You can obtain a list of the engine oils and oil filters tested and approved in accordance with the Mercedes-Benz Specifications for Service Products at any Mercedes-Benz Service center.

Damage to the engine or exhaust system is caused by the following:

- using engine oils and oil filters that have not been specifically approved for the service system
- replacing engine oil and oil filters after the interval for replacement specified by the service system has been exceeded
- using engine oil additives.

- ❗ Do not add too much oil. If the oil level is above the "max" mark on the dipstick, too much oil has been added. This can lead to damage to the engine or the catalytic converter. Have excess oil siphoned off.



Example: engine oil cap

- ▶ Turn cap ① counter-clockwise and remove it.
- ▶ Add engine oil. If the oil level is at or below the MIN mark on the oil dipstick, add 1.1 US qt (1.0 l) of engine oil.

- ▶ Replace cap ① on the filler neck and turn clockwise. Ensure that the cap locks into place securely.
- ▶ Check the oil level again with the oil dipstick (▷ page 535).

Further information on engine oil (▷ page 603).

Checking and adding other service products

Checking coolant level

⚠ WARNING

Certain components in the engine compartment, such as the engine, radiator and parts of the exhaust system, can become very hot. Working in the engine compartment poses a risk of injury.

Where possible, let the engine cool down and touch only the components described in the following.

⚠ WARNING

The engine cooling system is pressurized, particularly when the engine is warm. When opening the cap, you could be scalded by hot coolant spraying out. There is a risk of injury.

Let the engine cool down before opening the cap. Wear eye and hand protection when opening the cap. Open the cap slowly half a turn to allow pressure to escape.

- ▶ Park the vehicle on a level surface. Only check the coolant level when the vehicle is on a level surface and the engine has cooled down.
- ▶ Turn the SmartKey to position **2** in the ignition lock (▷ page 151). On vehicles with KEYLESS-GO, press the Start/Stop button twice (▷ page 151).
- ▶ Check the coolant temperature gauge in the multifunction display. The coolant temperature must be below 158 °F (70 °C).
- ▶ Turn the SmartKey to position **0** (▷ page 151) in the ignition lock.
- ▶ Slowly turn cap ② half a turn counter-clockwise to allow excess pressure to escape.
- ▶ Turn cap ② further counter-clockwise and remove it. If the coolant is at the level of marker bar ③ in the filler neck when cold, there is enough coolant in coolant expansion tank ①. If the coolant level is approximately 0.6 in (1.5 cm) above marker bar ③ in the fuel filler neck when warm, there is enough coolant in expansion tank ①.
- ▶ If necessary, add coolant that has been tested and approved by Mercedes-Benz.
- ▶ Replace cap ② and turn it clockwise as far as it will go.

For further information on coolant, see (▷ page 605).

Windshield washer system

⚠ WARNING

Certain components in the engine compartment, such as the engine, radiator and parts of the exhaust system, can become very hot. Working in the engine compartment poses a risk of injury.

Where possible, let the engine cool down and touch only the components described in the following.

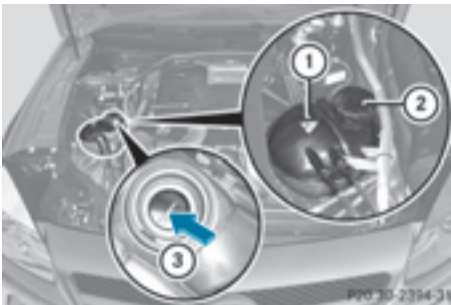

Example

⚠ WARNING

Windshield washer concentrate could ignite if it comes into contact with hot engine components or the exhaust system. There is a risk of fire and injury.

Make sure that no windshield washer concentrate is spilled next to the filler neck.



Example

- ▶ **To open:** pull cap ① upwards by the tab.
- ▶ Add the premixed washer fluid.
- ▶ **To close:** press cap ① onto the filler neck until it engages.

If the washer fluid level drops below the recommended minimum of 1 liter, a message appears in the multifunction display prompting you to add washer fluid (▷ page 267). Further information on windshield washer fluid/antifreeze (▷ page 606).

ASSYST PLUS**Service messages**

The ASSYST PLUS service interval display informs you of the next service due date.

Information on the type of service and service intervals (see the separate Maintenance Booklet).

You can obtain further information from an authorized Mercedes-Benz Center or at <http://www.mbusa.com> (USA only).

- ❗ The ASSYST PLUS service interval display does not show any information on the

engine oil level. Observe the notes on the engine oil level (▷ page 535).

The multifunction display shows a service message for several seconds, e.g.:

- Service A in .. Days
- Service A Due
- Service A Exceeded by .. Days

Depending on the operating conditions of the vehicle, the remaining time or distance until the next service due date is displayed.

The letter **A** or **B**, possibly in connection with a number or another letter, shows the type of service. **A** stands for a minor service and **B** for a major service.

You can obtain further information from an authorized Mercedes-Benz Center.

The ASSYST PLUS service interval display does not take into account any periods of time during which the battery is disconnected.

Maintaining the time-dependent service schedule:

- ▶ Note down the service due date displayed in the multifunction display before disconnecting the battery.





or

- ▶ After reconnecting the battery, subtract the battery disconnection periods from the service date shown on the display.

Hiding a service message

- ▶ Press the or button on the steering wheel.

Displaying service messages

- ▶ Switch on the ignition.
- ▶ Press the  or  button on the steering wheel to select the **Serv.** menu.
- ▶ Press the  or  button to select the **ASSYST PLUS** submenu and confirm by pressing the  button.
The service due date appears in the multi-function display.

Information about Service

Resetting the ASSYST PLUS service interval display

! If the ASSYST PLUS service interval display has been inadvertently reset, this setting can be corrected at a qualified specialist workshop.

Have service work carried out as described in the Maintenance Booklet. This may otherwise lead to increased wear and damage to the major assemblies or the vehicle.

A qualified specialist workshop, e.g. an authorized Mercedes-Benz Center, will reset the ASSYST PLUS service interval display after the service work has been carried out. You can also obtain further information on maintenance work, for example.

Special service requirements

The specified maintenance interval takes only the normal operation of the vehicle into account. Under arduous operating conditions or increased load on the vehicle, maintenance work must be carried out more frequently, for example:

- regular city driving with frequent intermediate stops
- if the vehicle is primarily used to travel short distances

- use in mountainous terrain or on poor road surfaces
- if the engine is often left idling for long periods

Under these or similar conditions, have, for example, the air filter, engine oil and oil filter replaced or changed more frequently. Under arduous operating conditions, the tires must be checked more often. Further information can be obtained at a qualified specialist workshop, e.g. an authorized Mercedes-Benz Center.

Driving abroad

An extensive Mercedes-Benz Service network is also available in other countries. You can obtain further information from any authorized Mercedes-Benz Center.

Care

Notes on care

Environmental note

Dispose of empty packaging and cleaning cloths in an environmentally responsible manner.

! For cleaning your vehicle, do not use any of the following:

- dry, rough or hard cloths
- abrasive cleaning agents
- solvents
- cleaning agents containing solvents

Do not scrub.

Do not touch the surfaces or protective films with hard objects, e.g. a ring or ice scraper. You could otherwise scratch or damage the surfaces and protective film.

! Do not park the vehicle for an extended period straight after cleaning it, particularly after having cleaned the wheels with wheel cleaner. Wheel cleaners could cause increased corrosion of the brake discs and brake pads/linings. For this reason, you

should drive for a few minutes after cleaning. Braking heats the brake discs and the brake pads/linings, thus drying them. The vehicle can then be parked.

Regular care of your vehicle is a condition for retaining the quality in the long term.

Use care products and cleaning agents recommended and approved by Mercedes-Benz.

Washing the vehicle and cleaning the paintwork

Automatic car wash

WARNING

Braking efficiency is reduced after washing the vehicle. There is a risk of an accident.

After the vehicle has been washed, brake carefully while paying attention to the traffic conditions until full braking power is restored.

! If DISTRONIC PLUS or the HOLD function is activated, the vehicle brakes automatically in certain situations. To prevent damage to the vehicle, deactivate DISTRONIC PLUS and the HOLD function in the following or other similar situations:

- when towing the vehicle
- in the car wash

! It is preferable to use car washes with adjustable high-pressure pre-cleaning that corresponds to the specification for the Cabriolet program. In car washes that use high water pressures, there is a risk that a small amount of water may leak into the vehicle.

! Vehicles with HANDS-FREE ACCESS: if a SmartKey with KEYLESS-GO is within the detection range of the KEYLESS-GO antenna, the following situations could lead to the unintentional opening of the trunk lid:

- using a car wash
- using a power washer

Make sure that the SmartKey is at least 6.5 ft (2 m) away from the vehicle.

! Never clean your vehicle in a Touchless Automatic Car Wash as these use special cleaning agents. These cleaning agents can damage the paintwork or plastic parts.

! Make sure that the automatic transmission is in position **N** when washing your vehicle in a tow-through car wash. The vehicle could be damaged if the transmission is in another position.

! Make sure that:

- the side windows and the roof are completely closed
- the climate control blower is switched off
- the windshield wiper switch is at position **0**

The vehicle could otherwise be damaged.

You can wash the vehicle in an automatic car wash from the very start.

If the vehicle is very dirty, pre-wash it before cleaning it in an automatic car wash.

After using an automatic car wash, wipe off wax from the windshield and the wiper blades. This will prevent smears and reduce wiping noises caused by residue on the windshield.

Washing by hand

In some countries, washing by hand is only allowed at specially equipped washing bays. Observe the legal requirements in all countries concerned.

- ▶ Do not use hot water and do not wash the vehicle in direct sunlight.
- ▶ Use a soft sponge to clean.
- ▶ Use a mild cleaning agent, such as a car shampoo approved by Mercedes-Benz.
- ▶ Thoroughly hose down the vehicle with a gentle jet of water.
- ▶ Do not point the water jet directly towards the air inlet.

- ▶ Use plenty of water and rinse out the sponge frequently.
- ▶ Rinse the vehicle with clean water and dry thoroughly with a chamois.
- ▶ Do not let the cleaning agent dry on the paintwork.

When using the vehicle in winter, remove all traces of road salt deposits carefully and as soon as possible.

Power washers

WARNING

The water jet from a circular jet nozzle (dirt blasters) can cause invisible exterior damage to the tires or chassis components. Components damaged in this way may fail unexpectedly. There is a risk of an accident.

Do not use power washers with circular jet nozzles to clean the vehicle. Have damaged tires or chassis components replaced immediately.

- ❗ Always maintain a distance of at least 11.8 in (30 cm) between the vehicle and the power washer nozzle. Information about the correct distance is available from the equipment manufacturer.

Move the power washer nozzle around when cleaning your vehicle.

Do not aim directly at any of the following:

- tires
- door gaps, roof gaps, joints, etc.
- electrical components
- battery
- connectors
- lights
- seals
- trim
- ventilation slots

Damaged seals or electrical components can lead to leaks or failures.

- ❗ Vehicles with HANDS-FREE ACCESS: if a SmartKey with KEYLESS-GO is within the detection range of the KEYLESS-GO antenna, the following situations could lead to the unintentional opening of the trunk lid:

- using a car wash
- using a power washer

Make sure that the SmartKey is at least 6.5 ft (2 m) away from the vehicle.

Cleaning the paintwork

- ❗ Do not affix:

- stickers
 - films
 - magnetic plates or similar items
- to painted surfaces. You could otherwise damage the paintwork.

Scratches, corrosive deposits, areas affected by corrosion and damage caused by inadequate care cannot always be completely repaired. In such cases, visit a qualified specialist workshop.

- ▶ Remove dirt immediately, where possible, while avoiding rubbing too hard.
- ▶ Soak insect remains with insect remover and rinse off the treated areas afterwards.
- ▶ Soak bird droppings with water and rinse off the treated areas afterwards.
- ▶ Remove coolant, brake fluid, tree resin, oils, fuels and greases by rubbing gently with a cloth soaked in petroleum ether or lighter fluid.
- ▶ Use tar remover to remove tar stains.
- ▶ Use silicone remover to remove wax.

If water no longer forms "beads" on the paint surface, use the paint care products recommended and approved by Mercedes-Benz. This is the case approximately every three to five months, depending on the climate conditions and the care product used.

If dirt has penetrated the paint surface or if the paint has become dull, the paint cleaner

recommended and approved by Mercedes-Benz should be used.

Do not use these care products in the sun or on the hood while the hood is hot.

- ▶ Use a suitable touch-up stick, e.g. MB Touch-Up Stick, to repair slight damage to the paintwork quickly and provisionally.

Matte finish care

❗ Never polish the vehicle or the light alloy wheels. Polishing causes the finish to shine.

❗ The following may cause the paint to become shiny and thus reduce the matte effect:

- Vigorous rubbing with unsuitable materials.
- Frequent use of car washes.
- Washing the vehicle in direct sunlight.

❗ Never use paint cleaner, buffing or polishing products, or gloss preserver, e.g. wax. These products are only suitable for high-gloss surfaces. Their use on vehicles with matte finish leads to considerable surface damage (shiny, spotted areas).

Always have paintwork repairs carried out at a qualified specialist workshop.

❗ Do not use wash programs with a hot wax treatment under any circumstances.

Observe these notes if your vehicle has a clear matte finish. This will help you to avoid damage to the paintwork due to incorrect treatment.

These notes also apply to light alloy wheels with a clear matte finish.

- i The vehicle should preferably be washed by hand using a soft sponge, car shampoo and plenty of water.
- i Use only insect remover and car shampoo from the range of recommended and approved Mercedes-Benz care products.

Cleaning the vehicle parts

Cleaning the wheels

- ❗ Do not use acidic wheel cleaning products to remove brake dust. This could damage wheel bolts and brake components.
- ❗ Do not park the vehicle for an extended period straight after cleaning it, particularly after having cleaned the wheels with wheel cleaner. Wheel cleaners could cause increased corrosion of the brake discs and brake pads/linings. For this reason, you should drive for a few minutes after cleaning. Braking heats the brake discs and the brake pads/linings, thus drying them. The vehicle can then be parked.

Cleaning the windows

WARNING

You could become trapped by the windshield wipers if they start moving while cleaning the windshield or wiper blades. There is a risk of injury.

Always switch off the windshield wipers and the ignition before cleaning the windshield or wiper blades.

- ❗ Only fold the windshield wipers away from the windshield when vertical. Otherwise, you will damage the hood.
- ❗ Do not use dry cloths, abrasive products, solvents or cleaning agents containing solvents to clean the inside of the windows. Do not touch the insides of the windows with hard objects, e.g. an ice scraper or ring. There is otherwise a risk of damaging the windows.
- ❗ Clean the water drainage channels of the windshield and the rear window at regular intervals. Deposits such as leaves, petals and pollen may under certain circumstances prevent water from draining away. This can lead to corrosion damage and damage to electronic components.

- ▶ Clean the inside and outside of the windows with a damp cloth and a cleaning agent that is recommended and approved by Mercedes-Benz.

Cleaning wiper blades

WARNING

You could become trapped by the windshield wipers if they start moving while cleaning the windshield or wiper blades. There is a risk of injury.

Always switch off the windshield wipers and the ignition before cleaning the windshield or wiper blades.

- ❗ Do not pull the wiper blade. Otherwise, the wiper blade could be damaged.
- ❗ Do not clean wiper blades too often and do not rub them too hard. Otherwise, the graphite coating could be damaged. This could cause wiper noise.
- ❗ Hold the wiper arm securely when folding back. The windshield could be damaged if the wiper arm smacks against it suddenly.
- ▶ Fold the windshield wiper arms away from the windshield.
- ▶ Carefully clean the wiper blades with a damp cloth.
- ▶ Fold the windshield wiper arms back again before switching on the ignition.

Cleaning the exterior lighting

- ❗ Only use cleaning agents or cleaning cloths which are suitable for plastic light lenses. Unsuitable cleaning agents or cleaning cloths could scratch or damage the plastic light lenses.
- ▶ Clean the plastic lenses of the exterior lighting using a wet sponge and a mild cleaning agent, e.g. Mercedes-Benz car shampoo or cleaning cloths.

Mirror turn signals

- ❗ Only use cleaning agents or cleaning cloths that are suitable for plastic lenses. Unsuitable cleaning agents or cleaning cloths could scratch or damage the plastic lenses of the mirror turn signals.
- ▶ Clean the plastic lenses of the mirror turn signals in the exterior mirror housing using a wet sponge and mild cleaning agent, e.g. Mercedes-Benz car shampoo or cleaning cloths.

Cleaning the sensors

- ❗ If you clean the sensors with a power washer, make sure that you keep a distance of at least 11.8 in (30 cm) between the vehicle and the power washer nozzle. Information about the correct distance is available from the equipment manufacturer.

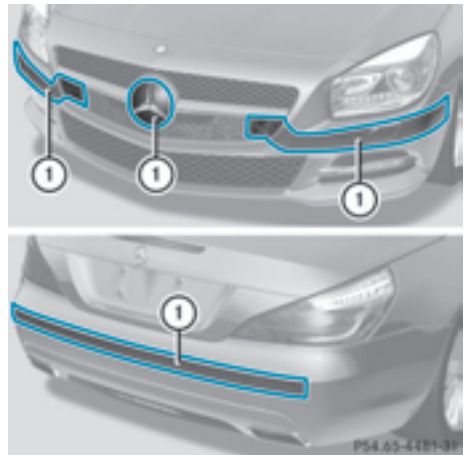

- ▶ Clean sensors ① of the driving systems with water, car shampoo and a soft cloth.

Cleaning the rear view camera

- ❗ Do not clean the camera lens and the area around the rear view camera with a power washer.



- ▶ Use clear water and a soft cloth to clean camera lens ①.

Cleaning the exhaust pipe

WARNING

The exhaust tail pipe and tail pipe trim can become very hot. If you come into contact with these parts of the vehicle, you could burn yourself. There is a risk of injury.

Always be particularly careful around the exhaust tail pipe and the tail pipe trim. Allow these components to cool down before touching them.

- ▶ **!** Do not clean the exhaust pipe with acid-based cleaning agents such as sanitary cleansers or wheel cleaners.
- ▶ Clean the exhaust pipe with a chrome care product tested and approved by Mercedes-Benz.

Impurities combined with the effects of road grit and corrosive environmental factors may cause flash rust to form on the surface. You can restore the original shine of the exhaust pipe by cleaning it regularly, especially in winter and after washing.

Interior care

Cleaning the display

- ▶ **!** For cleaning, do not use any of the following:
 - alcohol-based thinner or gasoline
 - abrasive cleaning agents
 - commercially-available household cleaning agents
 These may damage the display surface. Do not put pressure on the display surface when cleaning. This could lead to irreparable damage to the display.
- ▶ Before cleaning the display, make sure that it is switched off and has cooled down.
- ▶ Clean the display surface using a commercially available microfiber cloth and TFT/LCD display cleaner.
- ▶ Dry the display surface using a dry microfiber cloth.

Cleaning Night View Assist Plus

- ▶ **!** Never clean the camera lens. When cleaning the field of vision of the driving systems, make sure that you do not spray glass cleaner on the camera lens. If the camera lens is dirty, visit a qualified specialist workshop.



- ▶ **To clean the windshield on the inside front of the camera lens:** fold down the cover of camera ② using the recess.
- ▶ Use a soft cloth to clean the windshield in front of camera ②.

To clean the thermal imaging camera in the radiator trim: thermal imaging camera ① is cleaned at regular intervals when the windshield washer system is operated.

- ▶ Use clear water and a soft cloth to clean thermal imaging camera ① when it is very dirty.

Cleaning the plastic trim

WARNING

Care products and cleaning agents containing solvents cause surfaces in the cockpit to become porous. As a result, plastic parts may come loose in the event of air bag deployment. There is a risk of injury.

Do not use any care products and cleaning agents to clean the cockpit.

! Do not affix the following to plastic surfaces:

- stickers
- films
- scented oil bottles or similar items

You can otherwise damage the plastic.

! Do not allow cosmetics, insect repellent or sunscreen to come into contact with the plastic trim. This maintains the high-quality look of the surfaces.

- ▶ Wipe the plastic trim with a damp, lint-free cloth, e.g. a microfiber cloth.
- ▶ **Heavy soiling:** use car care and cleaning products recommended and approved by Mercedes-Benz.

The surface may change color temporarily. Wait until the surface is dry again.

Cleaning the steering wheel and gear or selector lever

- ▶ Thoroughly wipe with a damp cloth or use leather care agents that have been recommended and approved by Mercedes-Benz.

Cleaning genuine wood and trim elements

! Do not use solvent-based cleaning agents such as tar remover, wheel cleaners, polishes or waxes. There is otherwise a risk of damaging the surface.

! Do not use chrome polish on trim pieces. The trim pieces have a chrome look but are mostly made of anodized aluminum and can lose their shine if chrome polish is used. Use a damp, lint-free cloth instead when cleaning the trim pieces.

If the chrome-plated trim pieces are very dirty, you can use a chrome polish. If you are unsure as to whether the trim pieces are chrome-plated or not, consult an authorized Mercedes-Benz Center.

- ▶ Wipe the wooden trim and trim pieces with a damp, lint-free cloth, e.g. a microfiber cloth.
- ▶ **Heavy soiling:** use car care and cleaning products recommended and approved by Mercedes-Benz.

Cleaning the seat covers

General notes

! Do not use microfiber cloths to clean genuine leather, artificial leather or DINAMICA covers. If used often, these can damage the cover.

i Note that regular care is essential to ensure that the appearance and comfort of the covers is retained over time.

Genuine leather seat covers

- !** To retain the natural appearance of the leather, observe the following cleaning instructions:
- Clean genuine leather covers carefully with a damp cloth and then wipe the covers down with a dry cloth.
 - Make sure that the leather does not become soaked. It may otherwise become rough and cracked.
 - Only use leather care agents that have been tested and approved by Mercedes-Benz. You can obtain these from a qualified specialist workshop.

Leather is a natural product.

It exhibits natural surface characteristics, for example:

- differences in the texture
- marks caused by growth and injury
- slight nuances of color

These are characteristics of leather and not material defects.

Seat covers of other materials

- !** Observe the following when cleaning:
- Clean artificial leather covers with a cloth moistened with a solution containing 1% detergent (e.g. dish washing liquid).
 - Clean cloth covers with a microfiber cloth moistened with a solution containing 1% detergent (e.g. dish washing liquid). Rub carefully and always wipe entire seat sections to avoid leaving visible lines. Leave the seat to dry afterwards. Cleaning results depend on the type of dirt and how long it has been there.
 - Clean Alcantara® covers with a damp cloth. Make sure that you wipe entire seat sections to avoid leaving visible lines.

Cleaning the seat belts

WARNING

Seat belts can become severely weakened if bleached or dyed. This could cause the seat belts to tear or fail, for instance, in the event of an accident. This poses an increased risk of injury or fatal injury.

Never bleach or dye the seat belts.

- !** Do not clean the seat belts using chemical cleaning agents. Do not dry the seat belts by heating at temperatures above 176 °F (80 °C) or in direct sunlight.

- ▶ Use clean, lukewarm water and soap solution.

Cleaning the headliner and carpets

- ▶ **Headliner:** if it is very dirty, use a soft brush or dry shampoo.
- ▶ **Carpets:** use the carpet and textile cleaning agents recommended and approved by Mercedes-Benz.

Useful information	548
Where will I find...?	548
Flat tire	548
Battery (vehicle)	553
Jump-starting	557
Towing and tow-starting	559
Fuses	562

Useful information

i This Operator's manual describes all models and all standard and optional equipment of your vehicle available at the time of publication of the Operator's manual. Country-specific differences are possible. Please note that your vehicle may not be equipped with all features described. This also applies to safety-related systems and functions.

i Read the information on qualified specialist workshops (▷ page 35).

Where will I find...?

Vehicle tool kit

General notes

The vehicle tool kit consists of a towing eye and test gauge for measuring the brake pad thickness (▷ page 178). The towing eye is located in the trunk in a bracket below the trunk lid lock. The gauge for measuring brake pad/lining thickness is in the vehicle document wallet. If the vehicle is equipped with a TIREFIT kit, it is located in the stowage compartment under the trunk floor. MOE as standard, optional equipment - standard tires with TIREFIT. →

Vehicles with a TIREFIT kit

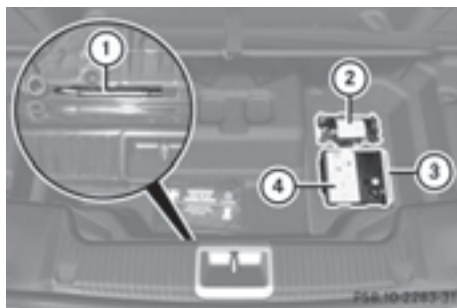

- ① Towing eye
- ② Tire sealant filler bottle

- ③ Fuse allocation chart
- ④ Tire inflation compressor

- ▶ Open the trunk lid.
- ▶ Open the trunk partition (▷ page 103).
- ▶ Lift the trunk floor upwards (▷ page 516).
- ▶ Use the TIREFIT kit (▷ page 550).

Tire-change tool kit



- ① Bag containing the tire-changing tools
- ▶ Open the trunk lid.
- ▶ Open the trunk partition (▷ page 103).
- ▶ Lift the trunk floor upwards (▷ page 516).

i Depending on the equipment, tools required for a wheel change, such as a jack or a lug wrench, are not available in all vehicles. Tools approved for your vehicle are available at a qualified specialist workshop.

Bag with the tire-changing tools ① contains:

- Jack
- Lug wrench
- Alignment bolt
- Wheel chock
- Gloves

Flat tire

Preparing the vehicle

Your vehicle may be equipped with:

- MOExtended tires (tires with run-flat properties) (▷ page 549)

Vehicle preparation is not necessary on vehicles with MOExtended tires

- a TIREFIT kit (▷ page 548)

Information on changing/mounting a wheel (▷ page 588).

- ▶ Stop the vehicle on solid, non-slippery and level ground, as far away as possible from traffic.
- ▶ Switch on the hazard warning lamps.
- ▶ Secure the vehicle against rolling away (▷ page 171).
- ▶ If possible, bring the front wheels into the straight-ahead position.
- ▶ Switch off the engine.
- ▶ **Vehicles without KEYLESS-GO:** remove the SmartKey from the ignition lock.
- ▶ **Vehicles with KEYLESS-GO:** open the driver's door.
The on-board electronics now have status **0**. This is the same as the SmartKey having been removed.
- ▶ **Vehicles with KEYLESS-GO:** remove the Start/Stop button from the ignition lock (▷ page 151).
- ▶ All occupants must get out of the vehicle. Make sure that they are not endangered as they do so.
- ▶ Make sure that no one is near the danger area while a wheel is being changed. Anyone who is not directly assisting in the wheel change should, for example, stand behind the barrier.
- ▶ Get out of the vehicle. Pay attention to traffic conditions when doing so.
- ▶ Close the driver's door.

MOExtended tires (tires with run-flat properties)

General notes

With MOExtended tires (tires with run flat characteristics), you can continue to drive your vehicle even if there is a total loss of

pressure in one or more tires. The affected tire must not show any clearly visible damage. You can recognize MOExtended tires by the MOExtended marking which appears on the sidewall of the tire. You will find this marking next to the tire size designation, the load-bearing capacity and the speed index (▷ page 582).

MOExtended tires may only be used in conjunction with an active tire pressure monitor.

If the pressure loss warning message appears in the multifunction display:

- Observe the instructions in the display messages (▷ page 263).
- Check the tire for damage.
- If driving on, observe the following notes.

The maximum driving distance is approximately 50 miles (80 km) when the vehicle is partially laden and approximately 18 miles (30 km) when the vehicle is fully laden.

In addition to the vehicle load, the driving distance possible depends upon:

- Speed
- Road condition
- Outside temperature

The driving distance possible in run-flat mode may be reduced by extreme driving conditions/maneuvers, or it can be increased through a moderate style of driving.

The maximum permissible distance which can be driven in run-flat mode is counted from the moment the tire pressure loss warning appears in the multifunction display.

You must not exceed a maximum speed of 50 mph (80 km/h).

i When replacing one or all tires, make sure that you use only tires:

- of the size specified for the vehicle and
- marked "MOExtended"

If a tire has gone flat and cannot be replaced with a MOExtended tire, a standard tire may be used as a temporary measure. Make sure that you use the proper size and type (summer or winter tire).

i Vehicles equipped with MOExtended tires are not equipped with a TIREFIT kit at the factory. It is therefore recommended that you additionally equip your vehicle with a TIREFIT kit if you mount tires that do not feature run-flat properties, e.g. winter tires. A TIREFIT kit is available, for example, from a qualified specialist workshop.

Important safety notes

WARNING

When driving in emergency mode, the driving characteristics deteriorate, e.g. when cornering, accelerating quickly and when braking. There is a risk of an accident.

Do not exceed the stated maximum speed. Avoid abrupt steering and driving maneuvers, and driving over obstacles (curbs, potholes, off-road). This applies in particular to a laden vehicle.

Stop driving in emergency mode if:

- you hear banging noises.
- the vehicle starts to shake.
- you see smoke and smell rubber.
- ESP® is intervening constantly.
- there are tears in the sidewalls of the tire.

After driving in emergency mode, have the wheel rims checked at a qualified specialist workshop with regard to their further use. The defective tire must be replaced in every case.

TIREFIT kit

Important safety notes

TIREFIT is a tire sealant.

You can use TIREFIT to seal punctures of up to 0.16 in (4 mm), particularly those in the tire tread. You can use TIREFIT at outside temperatures down to -4 °F (-20 °C).

WARNING

In the following situations, the tire sealant is unable to provide sufficient breakdown assistance, as it is unable to seal the tire properly:

- there are cuts or punctures in the tire larger than those mentioned above.
- the wheel rim is damaged.
- you have driven at very low tire pressures or on a flat tire.

There is a risk of an accident.

Do not drive the vehicle. Contact a qualified specialist workshop.

WARNING

The tire sealant is harmful and causes irritation. It must not come into contact with your skin, eyes or clothing or be swallowed. Do not inhale TIREFIT fumes. Keep tire sealant away from children. There is a risk of injury.

If you come into contact with the tire sealant, observe the following:

- Rinse off the tire sealant from your skin immediately with water.
- If the tire sealant comes into contact with your eyes, immediately rinse them thoroughly with clean water.
- If tire sealant is swallowed, immediately rinse your mouth out thoroughly and drink plenty of water. Do not induce vomiting, and seek medical attention immediately.
- Immediately change out of clothing which has come into contact with tire sealant.
- If an allergic reaction occurs, seek medical attention immediately.

! Do not operate the tire inflation compressor for longer than eight minutes at a time without a break. It may otherwise overheat.

The tire inflation compressor can be operated again once it has cooled down.

Comply with the manufacturer's safety instructions on the sticker on the tire inflation compressor.

Using the TIREFIT kit

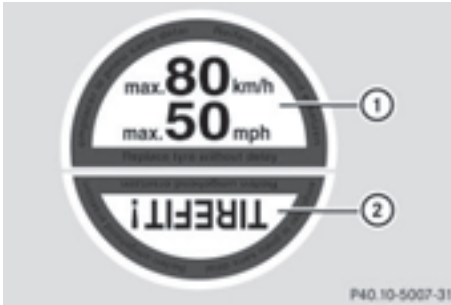

TIREFIT sticker, 2-part

- ▶ Do not remove any foreign objects which have penetrated the tire, e.g. screws or nails.
- ▶ Remove the tire sealant bottle, the accompanying TIREFIT sticker and the tire inflation compressor from the stowage well underneath the trunk floor (▷ page 548).
- ▶ Affix part ① of the TIREFIT sticker within the driver's field of vision.
- ▶ Affix part ② of the TIREFIT sticker near the valve on the wheel with the defective tire.

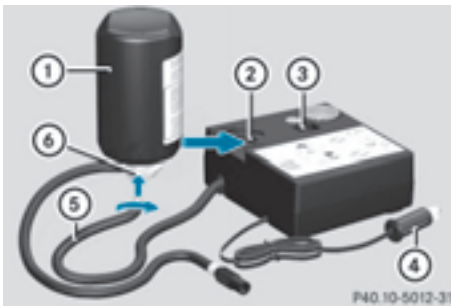

- ▶ Pull plug ④ with the cable and hose ⑤ out of the housing.
- ▶ Screw hose ⑤ onto flange ⑥ of tire sealant bottle ①.
- ▶ Place tire sealant bottle ① head downwards into recess ② of the tire inflation compressor.

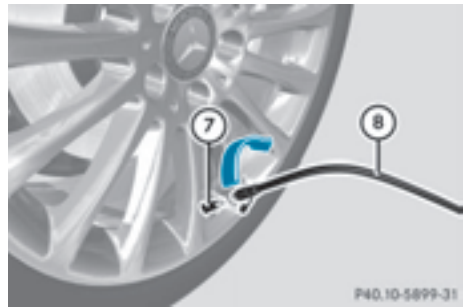

- ▶ Remove the cap from valve ⑦ on the faulty tire.
- ▶ Screw filler hose ⑧ onto valve.
- ▶ Insert plug ④ into the socket of the cigarette lighter or into a 12 V power socket in your vehicle. Observe the notes on the cigarette lighter (▷ page 518). Observe the notes on sockets (▷ page 518).
- ▶ Turn the SmartKey to position 1 in the ignition lock (▷ page 151).
- ▶ Press on/off switch ③ on the tire inflation compressor to I. The tire inflation compressor is switched on. The tire is inflated.

i First, tire sealant is pumped into the tire. The pressure can briefly rise to approximately 500 kPa (5.0 bar/73 psi).

Do not switch off the tire inflation compressor during this phase.

- ▶ Allow the tire inflation compressor to run for five minutes. The tire should then have attained a pressure of at least 180 kPa (1.8 bar/26 psi).

If a tire pressure of 180 kPa (1.8 bar/26 psi) has been attained after five minutes: (▷ page 552).

If a tire pressure of 180 kPa (1.8 bar/26 psi) has not been attained after five minutes: (▷ page 552).

- i** If tire sealant leaks out, allow it to dry. It can then be removed like a layer of film.

If your clothes are soiled with tire sealant, have them cleaned with perchloroethylene at a dry cleaner as soon as possible.

Tire pressure not reached

If a pressure of 180 kPa (1.8 bar/26 psi) has not been attained after five minutes:

- ▶ Switch off the tire inflation compressor.
 - ▶ Unscrew the filler hose from the valve of the faulty tire.
 - ▶ Very slowly drive forwards or reverse approximately 30 ft (10 m).
 - ▶ Pump up the tire again.
- After a maximum of five minutes the tire pressure must be at least 180 kPa (1.8 bar/26 psi).

WARNING

If the required tire pressure is not reached after the specified time, the tire is too badly damaged. The tire sealant cannot repair the tire in this instance. Damaged tires and a tire pressure that is too low can significantly impair the vehicle's braking and driving characteristics. There is a risk of accident.

Do not continue driving. Contact a qualified specialist workshop.

Tire pressure reached

WARNING

A tire temporarily sealed with tire sealant impairs the driving characteristics and is not suitable for higher speeds. There is a risk of accident.

You should therefore adapt your driving style accordingly and drive carefully. Do not exceed the specified maximum speed with a tire that has been repaired using tire sealant.

- ❗ Residue from the tire sealant may come out of the filler hose after use. This could cause stains.

Therefore, place the filler hose in the plastic bag which contained the TIREFIT kit.

Environmental note

Have the used tire sealant bottle disposed of professionally, e.g. at a qualified specialist workshop.

If a tire pressure of 180 kPa (1.8 bar/26 psi) has been achieved after a maximum period of ten minutes:

- ▶ Switch off the tire inflation compressor.
- ▶ Unscrew the filler hose from the valve of the faulty tire.
- ▶ Stow the tire sealant bottle and the tire inflation compressor.

▶ Pull away immediately.

The maximum speed for a tire sealed with tire sealant is 50 mph (80 km/h). The upper part of the TIREFIT sticker must be affixed to the instrument cluster in the driver's field of vision.

- ▶ Stop after driving for approximately ten minutes and check the tire pressure with the tire inflation compressor.
- The tire pressure must now be at least 130 kPa (1.3 bar/19 psi).

WARNING

If the required tire pressure is not reached after driving for a short period, the tire is too badly damaged. The tire sealant cannot repair the tire in this instance. Damaged tires and a tire pressure that is too low can significantly impair the vehicle's braking and driving characteristics. There is a risk of accident.

Do not continue driving. Contact a qualified specialist workshop.

- ❗ In cases such as the one mentioned above, contact an authorized Mercedes-Benz Center. Or call 1-800-FOR-MERCEDES (in the USA) or 1-800-387-0100 (in Canada).
- ▶ Correct the tire pressure if it is still at least 130 kPa (1.3 bar/19 psi) (for the values, see the Tire and Loading Information plac-

ard on the driver's side B-pillar or tire pressure table on the fuel filler flap).

- ▶ **To increase the tire pressure:** switch on the tire inflation compressor.

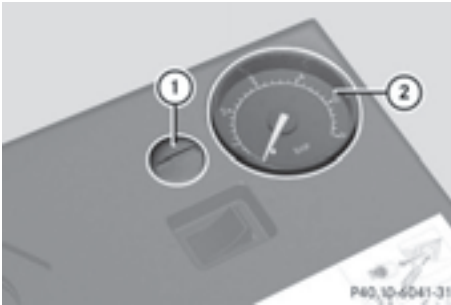

- ▶ **To reduce the tire pressure:** depress pressure release button ① next to pressure gauge ②.
- ▶ When the tire pressure is correct, unscrew the filler hose from the valve of the sealed tire.
- ▶ Screw the valve cap onto the tire valve of the sealed tire.
- ▶ Pull the tire sealant bottle out of the tire inflation compressor.
The filler hose remains attached to the tire sealant bottle.
- ▶ Stow the tire sealant bottle and the tire inflation compressor.
- ▶ Drive to the nearest qualified specialist workshop and have the tire changed there.
- ▶ Have the tire sealant bottle replaced as soon as possible at a qualified specialist workshop.
- ▶ Have the tire sealant bottle replaced every four years at a qualified specialist workshop.

Battery (vehicle)

Important safety notes

Special tools and expert knowledge are required when working on the battery, e.g. removal and installing. You should therefore

have all work involving the battery carried out at a qualified specialist workshop.

WARNING

Work carried out incorrectly on the battery can lead, for example, to a short circuit and thus damage the vehicle electronics. This can lead to function restrictions applying to safety-relevant systems, e.g. the lighting system, ABS (anti-lock braking system) or ESP® (Electronic Stability Program). The operating safety of your vehicle may be restricted. You could lose control of the vehicle, for example:

- braking
- in the event of abrupt steering maneuver and/or when the vehicle's speed is not adapted to the road conditions

There is a risk of an accident.

In the event of a short circuit or a similar incident, contact a qualified specialist workshop immediately. Do not drive any further. You should have all work involving the battery carried out at a qualified specialist workshop.

For further information about ABS and ESP®, see (▷ page 72) and (▷ page 74).

WARNING

Electrostatic build-up can lead to the creation of sparks, which could ignite the highly explosive gases of a battery. There is a risk of an explosion.

Before handling the battery, touch the vehicle body to remove any existing electrostatic build-up.

The highly flammable gas mixture forms when charging the battery as well as when jump-starting.

Always make sure that neither you nor the battery is electrostatically charged. A build-up of electrostatic charge can be caused, for example:

- by wearing clothing made from synthetic fibers
- due to friction between clothing and seats

- if you push or pull the battery across the carpet or other synthetic materials
- if you wipe the battery with a cloth

WARNING

During the charging process, a battery produces hydrogen gas. If a short circuit occurs or sparks are created, the hydrogen gas can ignite. There is a risk of an explosion.

- Make sure that the positive terminal of a connected battery does not come into contact with vehicle parts.
- Never place metal objects or tools on a battery.
- It is important that you observe the described order of the battery terminals when connecting and disconnecting a battery.
- When jump-starting, make sure that the battery poles with identical polarity are connected.
- It is particularly important to observe the described order when connecting and disconnecting the jumper cables.
- Never connect or disconnect the battery terminals while the engine is running.

WARNING

Battery acid is caustic. There is a risk of injury. Avoid contact with the skin, eyes or clothing. Do not inhale any battery gases. Do not lean over the battery. Keep children away from batteries. Wash battery acid immediately with water and seek medical attention.

Environmental note



Batteries contain dangerous substances. It is against the law to dispose of them with the household rubbish. They must be collected separately and recycled to protect the environment.



Dispose of batteries in an environmentally friendly manner. Take discharged batteries to a qualified spe-

cialist workshop or a special collection point for used batteries.

- ❗ Have the battery checked regularly at a qualified specialist workshop. Observe the service intervals in the Maintenance Booklet or contact a qualified specialist workshop for more information.
- ❗ You should have all work involving the battery carried out at a qualified specialist workshop. In the exceptional case that it is necessary for you to disconnect the battery yourself, make sure that:
 - you switch off the engine and remove the SmartKey. On vehicles with KEYLESS-GO, ensure that the ignition is switched off. Check that all the indicator lamps in the instrument cluster are off. Otherwise, electronic components, such as the alternator, may be damaged.
 - you first remove the negative terminal clamp and then the positive terminal clamp. Never swap the terminal clamps. Otherwise, the vehicle's electronic system may be damaged.
 - the transmission is locked in position **P** after disconnecting the battery. The vehicle is secured against rolling away. You can then no longer move the vehicle.

The battery and the cover of the positive terminal clamp must be installed securely during operation.

In order for the battery to achieve the maximum possible service life, it must always be sufficiently charged.

Comply with safety precautions and take protective measures when handling batteries.



Risk of explosion.



Fire, open flames and smoking are prohibited when handling the battery. Avoid creating sparks.



Battery acid is caustic. Avoid contact with skin, eyes or clothing.

Wear suitable protective clothing, especially gloves, apron and face-guard.

Rinse any acid spills immediately with clear water. Contact a physician if necessary.



Wear eye protection.



Keep children away.



Observe this Operator's Manual.

The vehicle battery, like other batteries, can discharge over time if you do not use the vehicle. In this case, have the battery disconnected at a qualified specialist workshop. You can also charge the battery with a charger recommended by Mercedes-Benz. Contact a qualified specialist workshop for further information.

Have the battery condition of charge checked more frequently if you use the vehicle mainly for short trips or if you leave it standing idle for a lengthy period. Consult a qualified specialist workshop if you wish to leave your vehicle parked for a long period of time.

- i** Remove the SmartKey if you park the vehicle and do not require any electrical consumers. The vehicle will then use very little energy, thus conserving battery power.
- i** After an interruption to the power supply, e.g. due to a discharged battery, you must reset the clock (▷ page 306).

Charging the battery

WARNING

During charging and jump-starting, explosive gases can escape from the battery. There is a risk of an explosion.

Particularly avoid fire, open flames, creating sparks and smoking. Ensure there is sufficient ventilation while charging and jump-starting. Do not lean over a battery.

WARNING

Battery acid is caustic. There is a risk of injury. Avoid contact with the skin, eyes or clothing. Do not inhale any battery gases. Do not lean over the battery. Keep children away from batteries. Wash battery acid immediately with water and seek medical attention.

WARNING

A discharged battery can freeze at temperatures below freezing point. When jump-starting the vehicle or charging the battery, gases can escape from the battery. There is a risk of an explosion.

Allow the frozen battery to thaw out before charging it or jump-starting.

! Only use battery chargers with a maximum charging voltage of 14.8 V.

! Only charge the battery using the jump-starting connection point.

The jump-starting connection point is in the engine compartment.

If, at low temperatures, the indicator lamps/warning lamps in the instrument cluster do not light up, it is highly likely that the discharged battery has frozen. In this case, you may neither charge the battery nor jump-start the vehicle. The service life of a thawed-out battery may be shorter. The starting characteristics can be impaired, particularly at low temperatures. Have the thawed-out battery checked at a qualified specialist workshop.

Read the battery charger's operating instructions before charging the battery.

- ▶ Open the hood.
- ▶ Connect the battery charger to the positive terminal and ground point in the same order as when connecting the donor battery in the jump-starting procedure (▷ page 557).

Jump-starting

For the jump-starting procedure, use only the jump-starting connection point, consisting of a positive terminal and a ground point, in the engine compartment.

WARNING

Battery acid is caustic. There is a risk of injury.

Avoid contact with the skin, eyes or clothing. Do not inhale any battery gases. Do not lean over the battery. Keep children away from batteries. Wash battery acid immediately with water and seek medical attention.

WARNING

During charging and jump-starting, explosive gases can escape from the battery. There is a risk of an explosion.

Particularly avoid fire, open flames, creating sparks and smoking. Ensure there is sufficient ventilation while charging and jump-starting. Do not lean over a battery.

WARNING

During the charging process, a battery produces hydrogen gas. If a short circuit occurs or sparks are created, the hydrogen gas can ignite. There is a risk of an explosion.

- Make sure that the positive terminal of a connected battery does not come into contact with vehicle parts.
- Never place metal objects or tools on a battery.
- It is important that you observe the described order of the battery terminals when connecting and disconnecting a battery.
- When jump-starting, make sure that the battery poles with identical polarity are connected.
- It is particularly important to observe the described order when connecting and disconnecting the jumper cables.
- Never connect or disconnect the battery terminals while the engine is running.

WARNING

A discharged battery can freeze at temperatures below freezing point. When jump-starting the vehicle or charging the battery, gases can escape from the battery. There is a risk of an explosion. Allow the frozen battery to thaw out before charging it or jump-starting.

! Avoid repeated and lengthy starting attempts. Otherwise, the catalytic converter could be damaged by the non-combusted fuel.

If, at low temperatures, the indicator lamps/warning lamps in the instrument cluster do not light up, it is highly likely that the discharged battery has frozen. In this case, you may neither charge the battery nor jump-start the vehicle. The service life of a thawed-out battery may be shorter. The starting characteristics can be impaired, particularly at low temperatures. Have the thawed-out battery checked at a qualified specialist workshop.

Do not start the vehicle using a rapid charging device. If your vehicle's battery is discharged, the engine can be jump-started from another vehicle or from a second battery using jumper cables. Observe the following points:

- The battery is not accessible in all vehicles. If the other vehicle's battery is not accessible, jump-start the vehicle using a second battery or a jump-starting device.
- You may only jump-start the vehicle when the engine and exhaust system are cold.
- Do not start the engine if the battery is frozen. Let the battery thaw first.
- Only jump-start from batteries with a 12 V voltage rating.
- Only use jumper cables which have a sufficient cross-section and insulated terminal clamps.
- If the battery is fully discharged, leave the battery that is being used to jump-start connected for a few minutes before attempting to start. This charges the battery slightly.
- Make sure that the two vehicles do not touch.

Make sure that:

- the jumper cables are not damaged.
 - when the jumper cables are connected to the battery, uninsulated sections of the terminal clamp do not come into contact with other metal sections.
 - the jumper cables cannot come into contact with parts which can move when the engine is running, such as the V-belt pulley or the fan.
- ▶ Secure the vehicle by applying the electric parking brake.
- ▶ Shift the transmission to position **P**.
- ▶ Turn the SmartKey to position **0** in the ignition lock and remove it (▶ page 151). On vehicles with KEYLESS-GO, make sure the ignition is switched off (▶ page 151). All indicator lamps in the instrument cluster must be off.
- ▶ Switch off all electrical consumers, e.g. rear window defroster, lighting, etc.
- ▶ Open the hood.

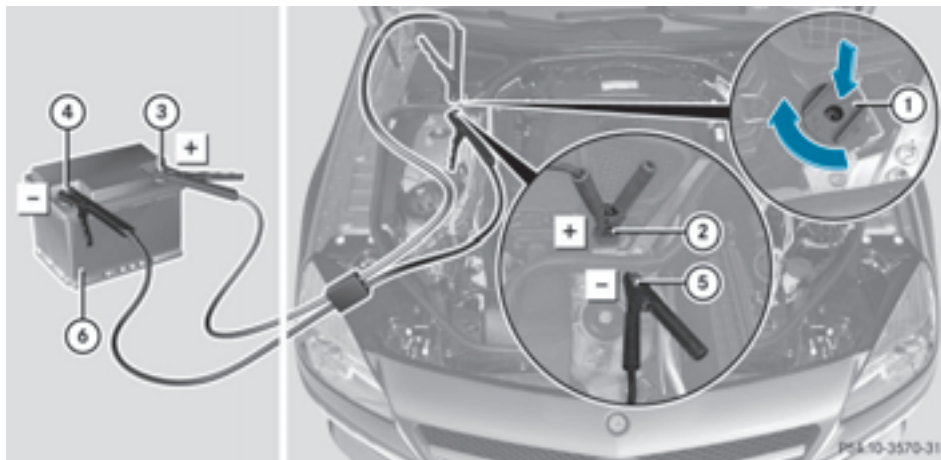

Position number ⑥ identifies the charged battery of the other vehicle or an equivalent jump-starting device.

- ▶ Press cover ① of positive terminal ② down (in the direction of the arrow) and turn it clockwise. Cover ① is held down in the lowered position, which exposes positive terminal ②.
- ▶ Connect positive terminal ② on your vehicle to positive terminal ③ of donor battery ⑥ using the jumper cable, always begin with positive terminal ② on your own vehicle first.
- ▶ Start the engine of the donor vehicle and run it at idling speed.
- ▶ Connect negative terminal ④ of donor battery ⑥ to ground point ⑤ of your vehicle using the jumper cable, connecting the jumper cable to battery of other vehicle ⑥ first.
- ▶ Start the engine.
- ▶ Before disconnecting the jumper cables, let the engine run for several minutes.
- ▶ First, remove the jumper cables from ground point ⑤ and negative terminal ④, then from positive clamp ② and positive terminal ③. Begin each time at the contacts on your own vehicle first.
- ▶ After removing the jumper cables, press down cover ① of positive terminal ② and turn it counter-clockwise. Cover ① returns to its original position. Positive terminal ② is covered up and thus insulated again.
- ▶ Have the battery checked at a qualified specialist workshop.

i Jump-starting is not considered to be a normal operating condition.

i Jumper cables and further information regarding jump-starting can be obtained at any qualified specialist workshop.

Towing and tow-starting

Important safety notes

! Vehicles with automatic transmission must not be tow-started. You could otherwise damage the automatic transmission.

WARNING

If the weight of the vehicle to be towed or tow-started is greater than the permissible gross weight of your vehicle:

- the towing eye could detach itself
- the vehicle/trailer combination could roll-over.

There is a risk of an accident.

When towing or tow-starting another vehicle, its weight should not be greater than the permissible gross weight of your vehicle.

! If DISTRONIC PLUS or the HOLD function is activated, the vehicle brakes automatically in certain situations. To prevent damage to the vehicle, deactivate DISTRONIC PLUS and the HOLD function in the following or other similar situations:

- when towing the vehicle
- in the car wash

! Only secure the tow rope or tow bar at the towing eyes. Otherwise, the vehicle could be damaged.

! Do not use the towing eye for recovery, this could damage the vehicle. If in doubt, recover the vehicle with a crane.

! When towing, pull away slowly and smoothly. If the tractive power is too high, the vehicles could be damaged.

- ❗ Do not tow with sling-type equipment. This could damage the vehicle.
- ❗ When towing vehicles with KEYLESS-GO, use the key instead of the Start/Stop button. Otherwise, the automatic transmission may shift to position **P** when the driver's or front-passenger door are opened, which could lead to damage to the transmission.
- ❗ Make sure that the electric parking brake is released. If the electric parking brake is faulty, visit a qualified specialist workshop.
- ❗ The vehicle can be towed a maximum of 30 miles (50km). The towing speed of 30 mph (50 km/h) must not be exceeded. If the vehicle has to be towed more than 30 miles (50km), the entire vehicle must be raised and transported.
- ❗ If you tow or tow-start another vehicle, its weight must not exceed the maximum permissible gross vehicle weight of your vehicle.
- ℹ Information on your vehicle's gross vehicle weight rating can be found on the vehicle identification plate (▷ page 600).

It is better to have the vehicle transported than to have it towed.

The automatic transmission must be in position **N** when the vehicle is being towed.

The battery must be connected and charged. Otherwise, you:

- cannot turn the SmartKey to position **2** in the ignition lock
- cannot shift the automatic transmission to position **N**

- ℹ Disarm the automatic locking feature before the vehicle is towed (▷ page 234). You could otherwise be locked out when pushing or towing the vehicle.

Installing/removing the towing eye

Installing the towing eye

⚠ WARNING

The exhaust tail pipe may be very hot. There is a risk of burns when removing the rear cover. Do not touch the exhaust pipe. Take particular care when removing the rear cover.

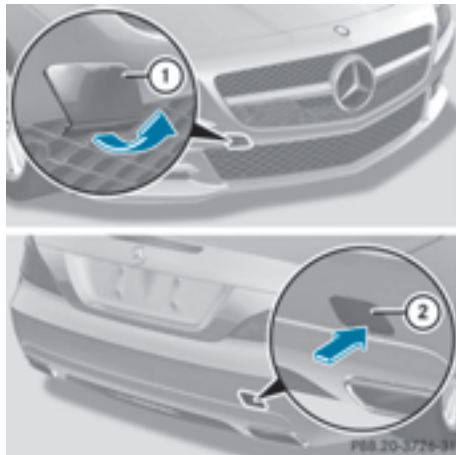

Example: towing eye mounting covers

- ① Front cover
- ② Back cover

The mountings for the screw-in towing eyes are located in the bumpers. They are at the front and at the rear, behind the covers.

- ▶ Remove the towing eye from the vehicle tool kit (▷ page 548).
- ▶ **Front bumper:** insert a finger into the recess on the bottom edge of cover ①.
- ▶ Pull cover ① out of the bumper towards you in the direction of the arrow. Cover ① is attached to the opening with a strap.
- ▶ **Rear bumper:** press the mark on cover ② inwards in the direction of the arrow.
- ▶ Take cover ② off the opening.
- ▶ Screw in and tighten the towing eye clockwise to the stop.

Removing the towing eye

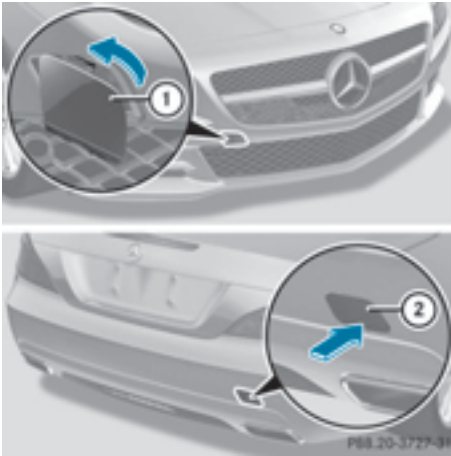

Example: towing eye mounting covers

- ① Front cover
- ② Back cover

- ▶ Unscrew and remove the towing eye.
- ▶ **Front bumper:** position cover ① on the opening in the bumper, as shown.
- ▶ Twist cover ① into the opening in the direction of the arrow.
Cover ① is now attached at the top edge of the opening.
- ▶ To close, press the lower section of cover ①.
- ▶ **Rear bumper:** position cover ② on the bumper and press until it engages.
- ▶ Place the towing eye in the vehicle tool kit (▷ page 548).

Towing the vehicle with the rear axle raised

- ❗ The ignition must be switched off if you are towing the vehicle with the rear axle raised. Intervention by ESP® could otherwise damage the brake system.

- ▶ Switch on the hazard warning lamps (▷ page 126).
- ▶ Bring the front wheels into the straight-ahead position.
- ▶ Turn the SmartKey to position **0** in the ignition lock and remove the SmartKey from the ignition lock.
- ▶ When leaving the vehicle, take the SmartKey or the KEYLESS-GO key with you.

When towing your vehicle with the rear axle raised, it is important that you observe the safety instructions (▷ page 559).

Towing a vehicle with both axles on the ground

WARNING

You can no longer steer the vehicle if the steering wheel lock has been engaged. There is a risk of an accident.

Always switch off the ignition when towing the vehicle with a tow cable or a tow bar.

The automatic transmission automatically shifts to position **P** when you open the driver's or front-passenger door or when you remove the SmartKey from the ignition lock.

In order to ensure that the automatic transmission stays in position **N** when towing the vehicle, you must observe the following points:

- ▶ Switch on the hazard warning lamps (▷ page 126).
- ▶ In order to signal a change of direction when towing the vehicle with the hazard warning lamps switched on, use the combination switch as usual. In this case, only the indicator lamps for the direction of travel flash. When you reset the combination switch, the hazard warning flashers start flashing again.
- ▶ Make sure that the vehicle is stationary and the SmartKey in the ignition lock is in position **0**.

- ▶ Turn the SmartKey to position **2** in the ignition lock.

On vehicles with KEYLESS-GO, use the SmartKey instead of the Start/Stop button (▷ page 151).

- ▶ Depress and hold the brake pedal.
- ▶ Shift the automatic transmission to position **N**.
- ▶ Release the brake pedal.
- ▶ Release the electric parking brake.
- ▶ Leave the SmartKey in position **2** in the ignition lock.

It is important that you observe the safety instructions when towing away your vehicle (▷ page 559).

Transporting the vehicle

- ❗ You may only secure the vehicle by the wheels, not by parts of the vehicle such as axle or steering components. Otherwise, the vehicle could be damaged.

The towing eye can be used to pull the vehicle onto a trailer or transporter for transporting purposes.

- ▶ Turn the SmartKey to position **2** in the ignition lock.
- ▶ Shift the automatic transmission to position **N**.

As soon as the vehicle has been loaded:

- ▶ Prevent the vehicle from rolling away by applying the electric parking brake.
- ▶ Shift the automatic transmission to position **P**.
- ▶ Turn the SmartKey to position **0** in the ignition lock and remove it.
- ▶ Secure the vehicle.

Tow-starting (emergency engine starting)

- ❗ Vehicles with automatic transmission must not be tow-started. You could otherwise damage the automatic transmission.
- i You can find information on "Jump-starting" under (▷ page 557).

Fuses

Important safety notes

WARNING

If you manipulate or bridge a faulty fuse or if you replace it with a fuse with a higher amperage, the electric cables could be overloaded. This could result in a fire. There is a risk of an accident and injury.

Always replace faulty fuses with the specified new fuses having the correct amperage.

- ❗ Only use fuses that have been approved for Mercedes-Benz vehicles and which have the correct fuse rating for the system concerned. Otherwise, components or systems could be damaged.

The fuses in your vehicle serve to close down faulty circuits. If a fuse blows, all the components on the circuit and their functions stop operating.

Blown fuses must be replaced with fuses of the same rating, which you can recognize by the color and value. The fuse ratings are listed in the fuse allocation chart.

If a newly inserted fuse also blows, have the cause traced and rectified at a qualified specialist workshop, e.g. an authorized Mercedes-Benz Center.

Before changing a fuse

- ▶ Secure the vehicle against rolling away (▷ page 171).
- ▶ Switch off all electrical consumers.

- ▶ Turn the SmartKey to position **0** in the ignition lock and remove it (▷ page 151).
- or
- ▶ On vehicles with KEYLESS-GO, make sure the ignition is switched off (▷ page 151).

All indicator lamps in the instrument cluster must be off.

The fuses are located in various fuse boxes:

- Fuse box in the engine compartment on the right-hand side of the vehicle, when viewed in the direction of travel
- Dashboard fuse box
- Fuse box in the rear compartment on the right-hand side of the vehicle, when viewed in the direction of travel

The fuse allocation chart is located in the vehicle tool kit in the stowage compartment under the trunk floor (▷ page 548).

Dashboard fuse box

- i** Observe the "Important safety notes" section (▷ page 562).
- !** Do not use a pointed object such as a screwdriver to open the cover in the dashboard. You could damage the dashboard or the cover.
- !** Make sure that no moisture can enter the fuse box when the cover is open.
- !** When closing the cover, make sure that it is lying correctly on the fuse box. Moisture seeping in or dirt could otherwise impair the operation of the fuses.



- ▶ Open the driver's door.
- ▶ **To open:** pull cover ① outwards in the direction of the arrow and remove it.
- ▶ **To close:** clip in cover ① on the front of the dashboard.
- ▶ Fold cover ① inwards until it engages.

Fuse box in the engine compartment

- i** Observe the "Important safety notes" section (▷ page 562).

⚠ WARNING

When the hood is open and the windshield wipers are set in motion, you can be injured by the wiper linkage. There is a risk of injury. Always switch off the windshield wipers and the ignition before opening the hood.

- !** Make sure that no moisture can enter the fuse box when the cover is open.
- !** When closing the cover, make sure that it is lying correctly on the fuse box. Moisture seeping in or dirt could otherwise impair the operation of the fuses.

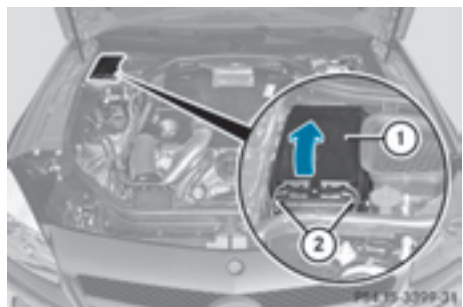

- ▶ Open the hood.
- ▶ Use a dry cloth to remove any moisture from the fuse box.
- ▶ **To open:** open clamps ②.
- ▶ Fold cover ① of the fuse box up in the direction of the arrow and remove it.



- ▶ **To close:** check whether the seal is seated correctly in cover ①.
- ▶ Insert both openings ③ at the rear of cover ① into the brackets on the fuse box. The brackets on the fuse box must be completely visible in the two openings ③ on the fuse box.
- ▶ Fold down cover ①.
- ▶ Hook clamps ② into the fuse box and close.
- ▶ Close the hood.

Fuse box in the rear

- i** Observe the "Important safety notes" section (▷ page 562).
- !** Make sure that no moisture can enter the fuse box when the cover is open.
- !** When closing the cover, make sure that it is lying correctly on the fuse box. Moisture seeping in or dirt could otherwise impair the operation of the fuses.

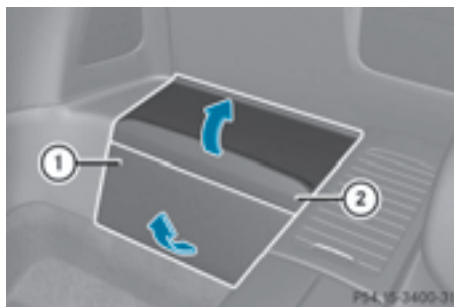

The fuse box in the rear is located on the right-hand side when viewed in the direction of travel.

- ▶ **To open:** open the seat belt guide on the right-hand seat and remove the seat belt (▷ page 111).
- ▶ Move the right-hand front seat as far forward as possible (▷ page 111).
- ▶ Insert your fingers at the bottom of front cover ① between the cover and floor covering.
- ▶ Remove front cover ① towards the front by pulling it in the direction of the arrow.
- ▶ Lift off top cover ② by pulling it in the direction of the arrow.



Fuses ③ are accessible through the two openings in the top of the fuse box.

- ▶ **To close:** insert the securing tags underneath top cover ② in the recesses at the top of the fuse box.
- ▶ Fold down top cover ② until it engages audibly.
- ▶ Insert the securing tags underneath top cover ① in the recesses at the front of the fuse box.

- ▶ Push front cover ① towards the rear until it engages audibly.
- ▶ Move the right-hand seat backwards (▷ page 111).
- ▶ Hook the seat belt into the seat belt guide on the right-hand seat (▷ page 111).

Useful information	568
Important safety notes	568
Operation	568
Winter operation	570
Tire pressure	572
Loading the vehicle	578
All about wheels and tires	581
Changing a wheel	588
Wheel and tire combinations	593

Useful information

- i** This Operator's manual describes all models and all standard and optional equipment of your vehicle available at the time of publication of the Operator's manual. Country-specific differences are possible. Please note that your vehicle may not be equipped with all features described. This also applies to safety-related systems and functions.
- i** Read the information on qualified specialist workshops (▷ page 35).

Important safety notes

WARNING

If wheels and tires of the wrong size are used, the wheel brakes or suspension components may be damaged. There is a risk of an accident.

Always replace wheels and tires with those that fulfill the specifications of the original part.

When replacing wheels, make sure to use the correct:

- designation
- model

When replacing tires, make sure to use the correct:

- designation
- manufacturer
- model

WARNING

A flat tire severely impairs the driving, steering and braking characteristics of the vehicle. There is a risk of accident.

Tires without run-flat characteristics:

- do not drive with a flat tire.
- immediately replace the flat tire with your emergency spare wheel or spare wheel, or consult a qualified specialist workshop.

Tires with run-flat characteristics:

- pay attention to the information and warning notices on MOExtended tires (tires with run-flat characteristics).

Accessories that are not approved for your vehicle by Mercedes-Benz or are not being used correctly can impair operating safety. Before purchasing and using non-approved accessories, visit a qualified specialist workshop and inquire about:

- suitability
- legal stipulations
- factory recommendations

Information on dimensions and types of wheels and tires for your vehicle can be found (▷ page 593).

Information on air pressure for the tires on your vehicle can be found:

- on the vehicle's Tire and Loading Information placard on the B-pillar (▷ page 578)
- on the tire pressure label on the fuel filler flap (▷ page 169)
- in the "Tire pressure" section

Operation

Information on driving

If the vehicle is heavily loaded, check the tire pressures and correct them if necessary.

While driving, pay attention to vibrations, noises and unusual handling characteristics, e.g. pulling to one side. This may indicate that the wheels or tires are damaged. If you suspect that a tire is defective, reduce your speed immediately. Stop the vehicle as soon as possible to check the wheels and tires for damage. Hidden tire damage could also be causing the unusual handling characteristics. If you find no signs of damage, have the tires and wheels checked at a qualified specialist workshop.

When parking your vehicle, make sure that the tires do not get deformed by the curb or

other obstacles. If it is necessary to drive over curbs, speed humps or similar elevations, try to do so slowly and at an obtuse angle. Otherwise, the tires, particularly the sidewalls, may be damaged.

Regular checking of wheels and tires

WARNING

Damaged tires can cause tire inflation pressure loss. As a result, you could lose control of your vehicle. There is a risk of accident.

Check the tires regularly for signs of damage and replace any damaged tires immediately.

Regularly check the wheels and tires of your vehicle for damage at least once a month, as well as after driving off-road or on rough roads. Damaged wheels can cause a loss of tire pressure. Pay particular attention to damage such as:

- cuts in the tires
- punctures
- tears in the tires
- bulges on tires
- deformation or severe corrosion on wheels

Regularly check the tire tread depth and the condition of the tread across the whole width of the tire (▷ page 569). If necessary, turn the front wheels to full lock in order to inspect the inner side of the tire surface.

All wheels must have a valve cap to protect the valve against dirt and moisture. Do not mount anything onto the valve other than the standard valve cap or other valve caps approved by Mercedes-Benz for your vehicle. Do not use any other valve caps or systems, e.g. tire pressure monitoring systems.

Regularly check the pressure of all the tires particularly prior to long trips. Adjust the tire pressure as necessary (▷ page 572).

The service life of tires depends on the following factors amongst other things:

- Driving style
- Tire pressure
- Distance covered

Important safety notes on the tire tread

WARNING

Insufficient tire tread will reduce tire traction. The tire is no longer able to dissipate water. This means that on wet road surfaces, the risk of hydroplaning increases, in particular where speed is not adapted to suit the driving conditions. There is a risk of accident.

If the tire pressure is too high or too low, tires may exhibit different levels of wear at different locations on the tire tread. Thus, you should regularly check the tread depth and the condition of the tread across the entire width of all tires.

Minimum tire tread depth for:

- Summer tires: $\frac{1}{8}$ in (3 mm)
- M+S tires: $\frac{1}{4}$ in (4 mm)

For safety reasons, replace the tires before the legally prescribed limit for the minimum tire tread depth is reached.

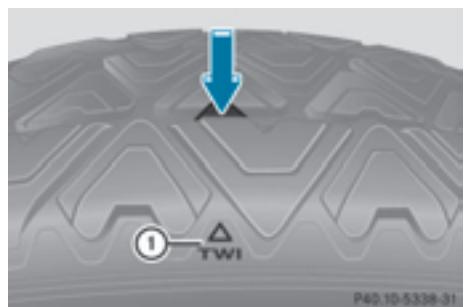

Bar indicator ① for tread wear is integrated into the tire tread.

Treadwear indicators (TWI) are required by law. Six indicators are positioned on the tire tread. They are visible once the tread depth is

approximately $\frac{1}{16}$ in (1.6 mm). If this is the case, the tire is so worn that it must be replaced.

Selecting, mounting and replacing tires

- Only mount tires and wheels of the same type and make.
Exception: it is permissible to install a different type or make in the event of a flat tire. Observe the "MOExtended tires (tires with run-flat characteristics)" section (▷ page 549).
- Only mount tires of the correct size onto the wheels.
- Break in new tires at moderate speeds for the first 60 miles (100 km). They only reach their full performance after this distance.
- Do not drive with tires which have too little tread depth, as this significantly reduces the traction on wet roads (hydroplaning).
- Replace the tires after six years at the latest, regardless of wear.

MOExtended tires (tires with run-flat properties)

With MOExtended tires (tires with run flat characteristics), you can continue to drive your vehicle even if there is a total loss of pressure in one or more tires.

MOExtended tires may only be used in conjunction with an active tire pressure monitor and only on wheels specifically tested by Mercedes-Benz.

Notes on driving with MOExtended tires with a flat tire (▷ page 549).

- ❗ Vehicles equipped with MOExtended tires are not equipped with a TIREFIT kit at the factory. It is therefore recommended that you additionally equip your vehicle with a TIREFIT kit if you mount tires that do not feature run-flat properties, e.g. winter tires.

A TIREFIT kit can be obtained from a qualified specialist workshop.

Winter operation

General notes

Have your vehicle winter-proofed at a qualified specialist workshop at the onset of winter.

Observe the notes in the "Changing a wheel" section (▷ page 588).

Driving with summer tires

At temperatures below 45 °F (+7 °C), summer tires lose elasticity and therefore traction and braking power. Change the tires on your vehicle to M+S tires. Using summer tires at very cold temperatures could cause cracks to form, thereby damaging the tires permanently. Mercedes-Benz cannot accept responsibility for this type of damage.

WARNING

Damaged tires can cause tire inflation pressure loss. As a result, you could lose control of your vehicle. There is a risk of accident.

Check the tires regularly for signs of damage and replace any damaged tires immediately.

M+S tires

WARNING

M+S tires with a tire tread depth of less than $\frac{1}{8}$ in (4 mm) are not suitable for use in winter and do not provide sufficient traction. There is a risk of an accident.

M+S tires with a tread depth of less than $\frac{1}{8}$ in (4 mm) must be replaced immediately.

At temperatures below 45 °F (+7 °C), use winter tires or all-season tires. Both types of tire are identified by the M+S marking.

Only winter tires bearing the  snowflake symbol in addition to the M+S marking pro-

vide the best possible grip in wintry road conditions.

Only these tires will allow driving safety systems such as ABS and ESP® to function optimally in winter. These tires have been developed specifically for driving in snow.

Use M+S tires of the same make and tread on all wheels to maintain safe handling characteristics.

Always observe the maximum permissible speed specified for the M+S tires you have mounted.

Once the winter tires are mounted:

- ▶ Check the tire pressures (▷ page 575).
- ▶ Restart the tire pressure monitor (▷ page 575).

Snow chains

WARNING

If snow chains are installed to the front wheels, they may drag against the vehicle body or chassis components. This could cause damage to the vehicle or the tires. There is a risk of an accident.

To avoid hazardous situations:

- never install snow chains to the front wheels
- always install snow chains in pairs to the rear wheels.

! You must drive at raised vehicle level (height 1) if snow chains have been installed. The vehicle may otherwise be damaged.

! On some tire sizes there is not enough space for snow chains. To avoid damage to the vehicle or tires, observe the "Wheel and tire combinations" section under "Tires and wheels".

For safety reasons, Mercedes-Benz recommends that you only use snow chains that have been specially approved for your vehicle

by Mercedes-Benz, or are of a corresponding standard of quality.

If you intend to mount snow chains, please bear the following points in mind:

- Snow chains may not be mounted on all wheel/tire combinations. Permissible wheel-tire combinations (▷ page 593).
- Only use snow chains when driving on roads completely covered by snow. Remove the snow chains as soon as possible when you come to a road that is not snow-covered.
- Local regulations may restrict the use of snow chains. Observe the appropriate regulations if you wish to install snow chains.
- Do not exceed the maximum permissible speed of 30 mph (50 km/h).
- On vehicles with Active Body Control (ABC), you must drive at a raised vehicle level if snow chains have been installed (▷ page 194).

i You may wish to deactivate ESP® when pulling away with snow chains installed (▷ page 74). You can thereby allow the wheels to spin in a controlled manner, achieving an increased driving force (cutting action).

Tire pressure

Tire pressure specifications

Important safety notes

⚠ WARNING

Tires with tire pressures that are too low or too high are associated with the following hazards:

- they can burst, in particular if the vehicle is heavily laden or when driven at high speeds.
- the tires can wear excessively and/or unevenly, which can severely impair tire traction.
- the driving, steering and braking characteristics may be severely impaired.

There is a risk of accident.

Follow recommended tire inflation pressures and check the pressure of all the tires including the spare wheel:

- monthly, at least
- if the load changes
- before beginning a long journey
- under different operating conditions, e.g. off-road driving

If necessary, correct the tire pressure.

i The specifications on the sample Tire and Loading Information placard and tire pressure tables are examples. Tire pressure specifications are vehicle-specific and may deviate from the data shown here. The tire pressure specifications that are valid for your vehicle can be found on the Tire and Loading Information placard and tire pressure table on the vehicle.

General notes

The recommended tire pressures for the tires mounted at the factory can be found on the labels described here.

Further information on tire pressures can be obtained at a qualified specialist workshop.

Tire and Loading Information placard

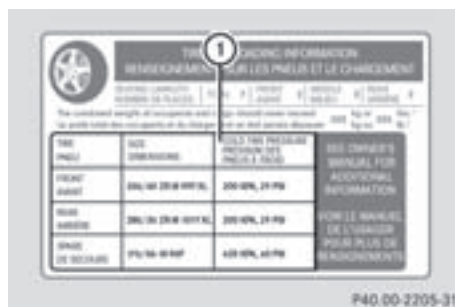

① Recommended tire pressures

The Tire and Loading Information placard is on the B-pillar on the driver's side (▷ page 578).

The Tire and Loading Information placard contains the recommended tire pressures for cold tires. The recommended tire pressures are valid for the maximum permissible load and up to the maximum permissible vehicle speed.

Tire pressure table

The tire pressure table is on the inside of the fuel filler flap.

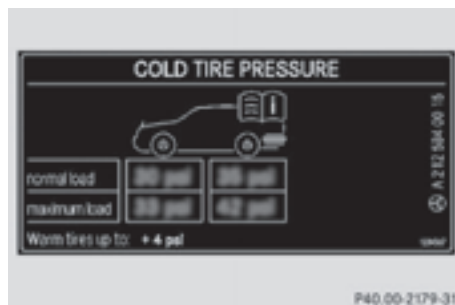

Example: tire pressure table for all tires permitted for this vehicle by the factory

The tire pressure table contains the recommended pressures for cold tires for various operating conditions, i.e. differing load and speed conditions.

LUFTDRUCK, PRESSURE, PRESSION, PRESIÓN
for cold tires for cold tires des pneus froids de infuso

100 kPa = 1 bar

	FR	FR	FR	FR
195/55 R16	2.3	2.5	2.8	3.0
215/45 R17	2.3	2.5	2.8	3.0
215/40 R18	2.3	2.5	2.8	3.0

Warning: Inflate to 30 psi (+ 4 psi) Mercedes-Benz

P40-00-2183-31

Example: tire pressure table with tire dimensions
If a tire size precedes a tire pressure, the tire pressure information following is only valid for that tire size. The load conditions "partially laden" and "fully laden" are defined in the table for different numbers of occupants and amounts of luggage. The actual number of seats may differ.

LUFTDRUCK, PRESSURE, PRESSION, PRESIÓN
100 kPa = 1 bar

	FR	FR	FR	FR
R18	2.3	2.5	2.8	3.0
R19	2.3	2.5	2.8	3.0

Warning: Inflate to 30 psi (+ 4 psi) Mercedes-Benz

P40-00-2184-31

Some tire pressure tables show only the rim diameters instead of the full tire size, e.g. **R18**. The rim diameter is part of the tire size and can be found on the tire sidewall (▷ page 582).

If the tire pressures have been set to the lower values for lighter loads and/or lower road speeds, the pressures should be reset to the higher values:

- if you want to drive with an increased load and/or
- if you want to drive at higher road speeds.

i The tire pressures for increased loads and/or higher road speeds, shown in the tire pressure table, may have a negative effect on driving comfort.

If the tire pressure is not set correctly, this can lead to an excessive build up of heat and a sudden loss of pressure.

For more information, contact a qualified specialist workshop.

Important notes on tire pressure

⚠ WARNING

If the tire pressure drops repeatedly, the wheel, valve or tire may be damaged. Tire pressure that is too low may result in a tire blow-out. There is a risk of an accident.

- Check the tire for foreign objects.
- Check whether the wheel is losing air or the valve is leaking.

If you are unable to rectify the damage, contact a qualified specialist workshop.

⚠ WARNING

If you fit unsuitable accessories onto tire valves, the tire valves may be overloaded and malfunction, which can cause tire pressure loss. Due to their design, retrofitted tire pressure monitors keep the tire valve open. This can also result in tire pressure loss. There is a risk of an accident.

Only screw the standard valve cap or other valve caps approved by Mercedes-Benz for your vehicle onto the tire valve.

Use a suitable pressure gauge to check the tire pressure. The outer appearance of a tire does not permit any reliable conclusion about the tire pressure. On vehicles equipped with the electronic tire pressure monitoring system, the tire pressure can be checked using the on-board computer.

The tire temperature and pressure increase when the vehicle is in motion. This is dependent on the driving speed and the load.

Therefore, you should only correct tire pressures when the tires are cold.

The tires are cold:

- if the vehicle has been parked without direct sunlight on the tires for at least three hours and
- if the vehicle has been driven for less than 1 mile (1.6 km).

The tire temperature changes depending on the outside temperature, the vehicle speed and the tire load. If the tire temperature changes by 18 °F (10 °C), the tire pressure changes by approximately 10 kPa (0.1 bar/ 1.5 psi). Take this into account when checking the pressure of warm tires. Only correct the tire pressure if it is too low for the current operating conditions. If you check the tire pressure when the tires are warm, the resulting value will be higher than if the tires were cold. This is normal. Do not reduce the tire pressure to the value specified for cold tires. The tire pressure would otherwise be too low.

Observe the recommended tire pressures for cold tires:

- on the Tire and Loading Information placard on the B-pillar on the driver's side
- in the tire pressure table on the inside of the fuel filler flap

Underinflated or overinflated tires

Underinflation

WARNING

Tires with pressure that is too low can overheat and burst as a consequence. In addition, they also suffer from excessive and/or irregular wear, which can severely impair the braking properties and the driving characteristics. There is a risk of an accident.

Avoid tire pressures that are too low in all the tires, including the spare wheel.

Underinflated tires may:

- overheat, leading to tire defects
- have an adverse effect on handling characteristics

- wear quickly and unevenly
- have an adverse effect on fuel consumption

Overinflation

WARNING

Tires with excessively high pressure can burst because they are damaged more easily by road debris, potholes etc. In addition, they also suffer from irregular wear, which can severely impair the braking properties and the driving characteristics. There is a risk of an accident.

Avoid tire pressures that are too high in all the tires, including the spare wheel.

Overinflated tires may:

- increase the braking distance
- have an adverse effect on handling characteristics
- wear quickly and unevenly
- have an adverse effect on ride comfort
- be more susceptible to damage

Maximum tire pressures



- ① Example: maximum permissible tire pressure

Never exceed the maximum permissible tire inflation pressure. Always observe the recommended tire pressure for your vehicle when adjusting the tire pressure (> page 572).

- i** The actual values for tires are vehicle-specific and may deviate from the values in the illustration.

Checking the tire pressures

Important safety notes

Observe the notes on tire pressure (▷ page 572).

Information on air pressure for the tires on your vehicle can be found:

- on the vehicle's Tire and Loading Information placard on the B-pillar
- on the tire pressure label on the fuel filler flap
- in the "Tire pressure" section

Checking tire pressures manually

To determine and set the correct tire pressure, proceed as follows:

- ▶ Remove the valve cap of the tire that is to be checked.
- ▶ Press the tire pressure gauge securely onto the valve.
- ▶ Read the tire pressure and compare it with the recommended value on the Tire and Loading Information placard (▷ page 572).
- ▶ If the tire pressure is too low, increase it to the recommended value.
- ▶ If the tire pressure is too high, release air by pressing down the metal pin in the valve. Use the tip of a pen, for example. Then, check the tire pressure again using the tire pressure gauge.
- ▶ Screw the valve cap onto the valve.
- ▶ Repeat these steps for the other tires.

Tire pressure monitor

General notes

If a tire pressure monitor is installed, the vehicle's wheels have sensors that monitor the

tire pressures in all four tires. The tire pressure monitor warns you if the pressure drops in one or more of the tires. The tire pressure monitor only functions if the correct sensors are installed on all wheels.

Information on tire pressures is displayed in the multifunction display. After a few minutes of driving, the current tire pressure of each tire is shown in the **Service** menu of the multifunction display.



Example: current tire pressure display

For information on the message display, refer to the "Checking the tire pressure electronically" section (▷ page 577).

Important safety notes

⚠ WARNING

Each tire, including the spare (if provided), should be checked at least once a month when cold and inflated to the pressure recommended by the vehicle manufacturer on the Tire and Loading Information placard on the driver's door B-pillar or the tire pressure label on the inside of the fuel filler flap. If your vehicle has tires of a different size than the size indicated on the Tire and Loading Information placard or the tire pressure label, you should determine the proper tire pressure for those tires.

As an added safety feature, your vehicle has been equipped with a tire pressure monitoring system (TPMS) that illuminates a low tire pressure telltale when one or more of your tires are significantly underinflated. Accordingly, when the low tire pressure telltale illuminates, you should stop and check your tires as soon as possible, and inflate them to the proper pressure. Driving on a significantly underinflated tire causes the tire to overheat and can

lead to tire failure. Underinflation also reduces fuel efficiency and tire tread life, and may affect the vehicle's handling and stopping ability.

Please note that the TPMS is not a substitute for proper tire maintenance, and it is the driver's responsibility to maintain correct tire pressure, even if underinflation has not reached the level to trigger illumination of the TPMS low tire pressure telltale.

USA only:

Your vehicle has also been equipped with a TPMS malfunction indicator to indicate if the system is not operating properly. The TPMS malfunction indicator is combined with the low tire pressure telltale. When the system detects a malfunction, the warning lamp will flash for approximately a minute and then remain continuously illuminated. This sequence will be repeated every time the vehicle is started as long as the malfunction exists.

When the malfunction indicator is illuminated, the system may not be able to detect or signal low tire pressure as intended. TPMS malfunctions may occur for a variety of reasons, including the mounting of incompatible replacement or alternate tires or wheels on the vehicle that prevent the TPMS from functioning properly. Always check the TPMS malfunction telltale after replacing one or more tires or wheels on your vehicle to ensure that the replacement or alternate tires and wheels allow the TPMS to continue to function properly.

It is the driver's responsibility to set the tire pressure to that recommended for cold tires which is suitable for the operating situation (> page 572). Note that the correct tire pressure for the current operating situation must first be taught-in to the tire pressure monitor. If there is a substantial loss of pressure, the warning threshold for the warning message is aligned to the reference values taught-in. Restart the tire pressure monitor after adjusting the pressure of the cold tires

(> page 577). The current pressures are saved as new reference values. As a result, a warning message will appear if the tire pressure drops significantly.

The tire pressure monitor does not warn you of an incorrectly set tire pressure. Observe the notes on the recommended tire pressure (> page 572).

The tire pressure monitor is not able to warn you of a sudden loss of pressure, e.g. if the tire is penetrated by a foreign object. In the event of a sudden loss of pressure, bring the vehicle to a halt by braking carefully. Avoid abrupt steering maneuvers.

The tire pressure monitor has a yellow warning lamp in the instrument cluster for indicating a pressure loss or malfunction. Whether the warning lamp flashes or lights up indicates whether a tire pressure is too low or the tire pressure monitor is malfunctioning:

- if the warning lamp is lit continuously, the tire pressure on one or more tires is significantly too low. The tire pressure monitor is not malfunctioning.
- if the warning lamp flashes for around a minute and then remains lit constantly, the tire pressure monitor is malfunctioning.

i In addition to the warning lamp, a message appears in the multifunction display. Further information can be found on (> page 263).

If the tire pressure monitor is malfunctioning, it may take more than ten minutes for the tire pressure warning lamp to inform you of the malfunction by flashing for approximately one minute and then remaining lit. When the malfunction has been rectified, the tire pressure warning lamp goes out after a few minutes of driving.

The tire pressure values indicated by the on-board computer may differ from those measured at a gas station with a pressure gauge. The tire pressures shown by the on-board computer refer to those measured at sea level. At high altitudes, the tire pressure val-

ues indicated by a pressure gauge are higher than those shown by the on-board computer. In this case, do not reduce the tire pressures. The operation of the tire pressure monitor can be affected by interference from radio transmitting equipment (e.g. radio headphones, two-way radios) that may be being operated in or near the vehicle.

Checking the tire pressure electronically

- ▶ Make sure that the SmartKey is in position 2 in the ignition lock (▷ page 151).
- ▶ Press the ◀ or ▶ button on the steering wheel to select the **Service** menu.
- ▶ Press the ▲ or ▼ button to select **Tire Pressure**.
- ▶ Press the **OK** button.
The current tire pressure of each tire is shown in the multifunction display.

If the vehicle has been parked for over 20 minutes, the **Tire pressure will be displayed after driving a few minutes** message appears.

After a teach-in process, the tire pressure monitor automatically detects new wheels or new sensors. As long as a clear allocation of the tire pressure value to the individual wheels is not possible, the **Tire Pressure Monitor Active** display message is shown instead of the tire pressure display. The tire pressures are already being monitored.

Tire pressure monitor warning messages

If the tire pressure monitor detects a pressure loss in one or more tires, a warning message is shown in the multifunction display and the yellow tire pressure monitor warning lamp comes on.

- If the **Please Correct Tire Pressure** message appears in the multifunction display, the tire pressure in at least one tire is

too low and must be corrected at the next opportunity.

- If the **Check Tires** message appears in the multifunction display, the tire pressure in one or more tires has dropped significantly and the tires must be checked.
- If the **Warning Tire Malfunction** appears in the multifunction display, the tire pressure in one or more tires has dropped suddenly and the tires must be checked.







Observe the instructions and safety notes in the display messages in the "Tires" section (▷ page 263).

- ❗ If the wheel positions on the vehicle are rotated, the tire pressures may be displayed for the wrong positions for a short time. This is rectified after a few minutes of driving, and the tire pressures are displayed for the correct positions.

Restarting the tire pressure monitor

When you restart the tire pressure monitor, all existing warning messages are deleted and the warning lamps go out. The monitor uses the currently set tire pressures as the reference values for monitoring. In most cases, the tire pressure monitor will automatically detect the new reference values after you have changed the tire pressure. However, you can also define reference values manually as described here. The tire pressure monitor then monitors the new tire pressure values.

- ▶ Set the tire pressure to the value recommended for the corresponding driving situation on the Tire and Loading Information placard on the driver's side B-pillar (▷ page 572).
Additional tire pressure values for different loads can also be found on the tire pressure table on the inside of the fuel filler flap (▷ page 572).
- ▶ Make sure that the tire pressure is correct on all four wheels.

- ▶ Make sure that the SmartKey is in position 2 in the ignition lock.
- ▶ Press the  or  button on the steering wheel to select the **Service** menu.
- ▶ Press the  or  button to select **Tire Pressure**.
- ▶ Press the  button.
The multifunction display shows the current tire pressure for the individual tires or the **Tire pressure will be displayed after driving a few minutes** message.
- ▶ Press the  button.
The **Use Current Pressures as New Reference Values** message appears in the multifunction display.

If you wish to confirm the restart:

- ▶ Press the  button.
The **Tire Pressure Monitor Restarted** message appears in the multifunction display.
After driving for a few minutes, the system checks whether the current tire pressures are within the specified range. The new tire pressures are then accepted as reference values and monitored.

If you wish to cancel the restart:

- ▶ Press the  button.
The tire pressure values stored at the last restart will continue to be monitored.

Radio type approval for the tire pressure monitor

Country	Radio type approval number
USA	FCC ID: MRXMW2433A FCC ID: MRXGG4 FCC ID: MRXMC34MA4
Canada	IC: 2546A-MW2433A IC: 2546A-GG4 IC: 2546A-MC34MA4

Loading the vehicle

Instruction labels for tires and loads

WARNING

Overloaded tires can overheat, causing a blowout. Overloaded tires can also impair the steering and driving characteristics and lead to brake failure. There is a risk of accident.

Observe the load rating of the tires. The load rating must be at least half of the GAWR of your vehicle. Never overload the tires by exceeding the maximum load.

Two instruction labels on your vehicle show the maximum possible load.

- (1) The Tire and Loading Information placard is on the B-pillar on the driver's side. The Tire and Loading Information placard shows the maximum permissible number of occupants and the maximum permissible vehicle load. It also contains details of the tire sizes and corresponding pressures for tires installed at the factory.
- (2) The vehicle identification plate is on the B-pillar on the driver's side. The vehicle identification plate informs you of the gross vehicle weight rating. It is made up of the vehicle weight, all vehicle occupants, the fuel and the cargo. You can also find information about the maximum gross axle weight rating on the front and rear axle.

The maximum gross axle weight rating is the maximum weight that can be carried by one axle (front or rear axle). Never exceed the maximum load or the maximum gross axle weight rating for the front or rear axle.



① B-pillar, driver's side

Maximum permissible gross vehicle weight rating

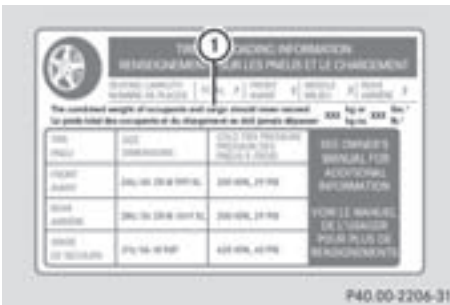

- Specification for maximum gross vehicle weight ① is listed in the Tire and Loading Information placard: "The combined weight of occupants and cargo should never exceed XXX kilograms or XXX lbs."

The gross weight of all vehicle occupants, load and luggage must not exceed the specified value.

- ① The specifications shown on the Tire and Loading Information placard in the illustration are examples. The maximum permissible gross vehicle weight rating is vehicle-specific and may differ from that in the illustration. You can find the valid maximum permissible gross vehicle weight rating for your vehicle on the Tire and Loading Information placard.

Number of seats

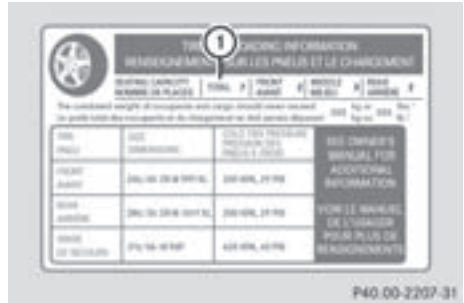

Maximum number of seats ① indicates the maximum number of occupants allowed to travel in the vehicle. This information can be found on the Tire and Loading Information placard.

- ① The specifications shown on the Tire and Loading Information placard in the illustration are examples. The number of seats is vehicle-specific and can differ from the details shown. The number of seats in your vehicle can be found on the Tire and Loading Information placard.

Determining the correct load limit

Step-by-step instructions

The following steps have been developed as required of all manufacturers under Title 49, Code of U.S. Federal Regulations, Part 575 pursuant to the "National Traffic and Motor Vehicle Safety Act of 1966".

- **Step 1:** Locate the statement "The combined weight of occupants and cargo should never exceed XXX kg or XXX lbs." on your vehicle's Tire and Loading Information placard.
- **Step 2:** Determine the combined weight of the driver and passengers that will be riding in your vehicle.
- **Step 3:** Subtract the combined weight of the driver and passengers from XXX kilograms or XXX lbs.

- ▶ **Step 4:** The resulting figure equals the available amount of cargo and luggage load capacity. For example, if the "XXX" amount equals 1,400 lbs and there will be five 150 lbs passengers in your vehicle, the amount of available cargo and luggage load capacity is 650 lbs ($1,400 - 750 (5 \times 150) = 650$ lbs).
- ▶ **Step 5:** Determine the combined weight of luggage and cargo being loaded on the vehicle. That weight may not safely exceed the available cargo and luggage load capacity calculated in step 4.

Example: steps 1 to 3

The following table shows examples on how to calculate total and cargo load capacities with varying seating configurations and number and size of occupants. The following examples use a maximum load of 1,500 lbs (680 kg). **This is for illustration purposes only.** Make sure you are using the actual load limit for your vehicle stated on your vehicle's Tire and Loading Information placard (▷ page 578).

The higher the weight of all the occupants, the smaller the maximum load for luggage.

Step 1

	Example 1	Example 2
Combined maximum weight of occupants and cargo (data from the Tire and Loading Information placard)	1500 lbs (680 kg)	1500 lbs (680 kg)

Step 2

	Example 1	Example 2
Number of people in the vehicle (driver and occupants)	1	2
Weight of the occupants	Occu- pant 1: 175 lbs (80 kg)	Occu- pant 1: 175 lbs (80 kg) Occu- pant 2: 195 lbs (88 kg)
Gross weight of all occupants	175 lbs (80 kg)	370 lbs (168 kg)

Step 3

	Example 1	Example 2
Permissible load (maximum gross vehicle weight rating from the Tire and Loading Information placard minus the gross weight of all occupants)	1500 lbs (680 kg) - 175 lbs (80 kg) = 1325 lbs (600 kg)	1500 lbs (680 kg) - 370 lbs (168 kg) = 1130 lbs (512 kg)

Vehicle identification plate

Even if you have calculated the total load carefully, you should still make sure that the gross vehicle weight rating and the gross axle weight rating are not exceeded. Details can be found on the vehicle identification plate on the B-pillar on the driver's side of the vehicle (▷ page 578).

Permissible gross vehicle weight: the gross weight of the vehicle, all passengers and the load must not exceed the permissible gross vehicle weight.

Gross axle weight rating: the maximum permissible weight that can be carried by one axle (front or rear axle).

To ensure that your vehicle does not exceed the maximum permissible values (gross vehicle weight and maximum gross axle weight rating), have your loaded vehicle (including driver, occupants and the load) weighed on a suitable vehicle weighbridge.

All about wheels and tires

Uniform Tire Quality Grading Standards

Overview of Tire Quality Grading Standards

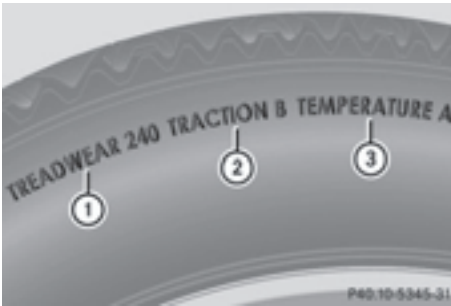

Uniform Tire Quality Grading Standards are U.S. government specifications. Their purpose is to provide drivers with uniform reliable information on tire performance data. Tire manufacturers have to grade tires using three performance factors: treadwear grade ①, traction grade ② and temperature grade ③. These regulations do not apply to Canada. Nevertheless, all tires sold in North America are provided with the corresponding quality grading markings on the sidewall of the tire. Where applicable, the tire grading information can be found on the tire sidewall between the tread shoulder and maximum tire width.

Example:

- **Treadwear grade:** 200
- **Traction grade:** AA
- **Temperature grade:** A

All passenger car tires must conform to the statutory safety requirements in addition to these grades.

- i** The actual values for tires are vehicle-specific and may deviate from the values in the illustration.

Treadwear

The treadwear grade is a comparative rating based on the wear rate of the tire when tested under controlled conditions on a specified U.S. government course. For example, a tire graded 150 would wear one and one-half times as well on the government course as a tire graded 100.

The relative performance of tires depends upon the actual conditions of their use, however, and may depart significantly from the norm, due to variations in driving habits, service practices and differences in road characteristics and climate conditions.

Traction

⚠ WARNING

The traction grade assigned to this tire is based on straight-ahead braking traction tests, and does not include acceleration, cornering, hydroplaning, or peak traction characteristics.

- !** Avoid wheelspin. This can lead to damage to the drive train.

The traction grades, from highest to lowest, are AA, A, B, and C. Those grades represent the tire's ability to stop on a wet surface as measured under controlled conditions on specified government test surfaces of asphalt and concrete. A tire marked C may have poor traction performance.

The safe speed on a wet, snow covered or icy road is always lower than on dry road surfaces.

You should pay special attention to road conditions when temperatures are around freezing point.

Mercedes-Benz recommends a minimum tread depth of $\frac{1}{8}$ in (4 mm) on all four winter tires. Observe the legally required minimum tire tread depth (▷ page 569). Winter tires can reduce the braking distance on snow-covered surfaces in comparison with summer tires. The braking distance is still much further than on surfaces that are not icy or covered with snow. Take appropriate care when driving. Further information on winter tires (M+S tires) (▷ page 570).

Temperature

WARNING

The temperature grade for this tire is established for a tire that is properly inflated and not overloaded. Excessive speed, underinflation, or excessive loading, either separately or in combination, can cause excessive heat build-up and possible tire failure.

The temperature grades are A (the highest), B, and C. These represent the tire's resistance to the generation of heat and its ability to dissipate heat when tested under controlled conditions on a specified indoor laboratory test wheel. Sustained high temperature can cause the material of the tire to degenerate and reduce tire life, and excessive temperature can lead to sudden tire failure. The grade C corresponds to a level of performance which all passenger car tires must meet under the Federal Motor Vehicle Safety Standard No. 109. Grades B and A represent higher levels of performance on the laboratory test wheel than the minimum required by law.

Tire labeling

Overview

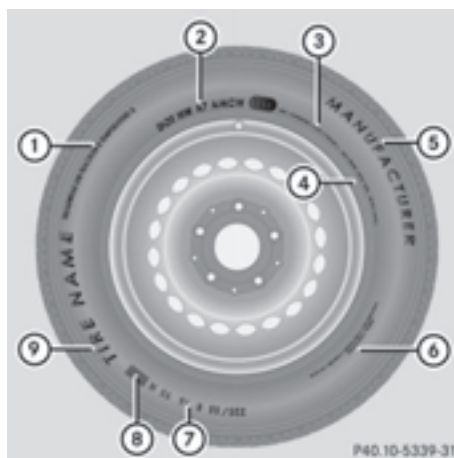

- ① Uniform Tire Quality Grading Standard (▷ page 586)
- ② DOT, Tire Identification Number (▷ page 585)
- ③ Maximum tire load (▷ page 585)
- ④ Maximum tire pressure (▷ page 574)
- ⑤ Manufacturer
- ⑥ Tire material (▷ page 586)
- ⑦ Tire size designation, load-bearing capacity and speed index (▷ page 582)
- ⑧ Load index (▷ page 585)
- ⑨ Tire name

The markings described above are on the tire in addition to the tire name (sales designation) and the manufacturer's name.

-  Tire data is vehicle-specific and may deviate from the data in the example.

Tire size designation, load-bearing capacity and speed rating

WARNING

Exceeding the stated tire load-bearing capacity and the approved maximum speed could lead to tire damage or the tire bursting. There is a risk of accident.

Therefore, only use tire types and sizes approved for your vehicle model. Observe the tire load rating and speed rating required for your vehicle.

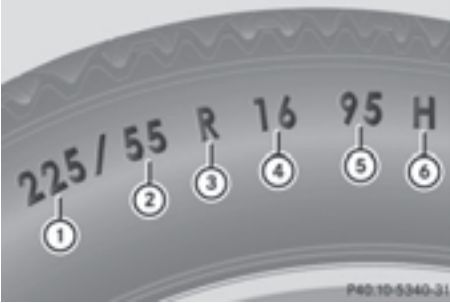

- ① Tire width
- ② Nominal aspect ratio in %
- ③ Tire code
- ④ Rim diameter
- ⑤ Load bearing index
- ⑥ Speed rating

General: depending on the manufacturer's standards, the size imprinted in the tire wall may not contain any letters or may contain one letter that precedes the size description. If there is no letter preceding the size description (as shown above): these are passenger vehicle tires according to European manufacturing standards.

If "P" precedes the size description: these are passenger vehicle tires according to U.S. manufacturing standards.

If "LT" precedes the size description: these are light truck tires according to U.S. manufacturing standards.

If "T" precedes the size description: these are compact emergency spare wheels at high tire pressure, to be used only temporarily in an emergency.

Tire width: tire width ① shows the nominal tire width in millimeters.

Height-width ratio: aspect ratio ② is the size ratio between the tire height and tire width and is shown in percent. The aspect

ratio is calculated by dividing the tire width by the tire height.

Tire code: tire code ③ specifies the tire type. "R" represents radial tires; "D" represents diagonal tires; "B" represents diagonal radial tires.

Optionally, tires with a maximum speed of over 149 mph (240 km/h) may have "ZR" in the size description, depending on the manufacturer (e.g. 245/40 ZR 18).

Rim diameter: rim diameter ④ is the diameter of the bead seat, not the diameter of the rim flange. The rim diameter is specified in inches (in).

Load-bearing index: load-bearing index ⑤ is a numerical code that specifies the maximum load-bearing capacity of a tire.

Do not overload the tires by exceeding the specified load limit. The maximum permissible load can be found on the vehicle's Tire and Loading Information placard on the B-pillar on the driver's side (▷ page 578).

Example:

Load-bearing index 91 indicates a maximum load of 1,356 lb (615 kg) that the tires can bear. For further information on the maximum tire load in kilograms and lbs, see (▷ page 585).

For further information on the load bearing index, see "Load index" (▷ page 585).

Speed rating: speed rating ⑥ specifies the approved maximum speed of the tire.

- ❗ Tire data is vehicle-specific and may deviate from the data in the example.

Regardless of the speed rating, always observe the speed limits. Drive carefully and adapt your driving style to the traffic conditions.

Index	Speed rating
Q	up to 100 mph (160 km/h)
R	up to 106 mph (170 km/h)
S	up to 112 mph (180 km/h)
T	up to 118 mph (190 km/h)
H	up to 130 mph (210 km/h)
V	up to 149 mph (240 km/h)
W	up to 168 mph (270 km/h)
Y	up to 186 mph (300 km/h)
ZR...Y	up to 186 mph (300 km/h)
ZR...(..Y)	over 186 mph (300 km/h)
ZR	over 149 mph (240 km/h)

- Optionally, tires with a maximum speed of over 149 mph (240 km/h) may have "ZR" in the size description, depending on the manufacturer (e.g. 245/40 ZR 18).

The service specification is made up of load-bearing index ⑤ and speed rating ⑥.

- If the size description of your tire includes "ZR" and there are no service specifications, ask the tire manufacturer in order to find out the maximum speed.

If a service specification is available, the maximum speed is limited according to the speed rating in the service specification. Example: 245/40 ZR 18 97 Y. In this example, "97 Y" is the service specification. The letter "Y" represents the speed rating. The maximum speed of the tire is limited to 186 mph (300 km/h).

- The size description for all tires with maximum speeds of over 186 mph (300 km/h) must include "ZR", **and** the service specification must be given in parentheses. Exam-

ple: 275/40 ZR 18 (99 Y). Speed rating "(Y)" indicates that the maximum speed of the tire is over 186 mph (300 km/h). Ask the tire manufacturer about the maximum speed.

Index	Speed rating
Q M+S ¹	up to 100 mph (160 km/h)
T M+S ¹	up to 118 mph (190 km/h)
H M+S ¹	up to 130 mph (210 km/h)
V M+S ¹	up to 149 mph (240 km/h)

- i** Not all tires with the M+S marking provide the driving characteristics of winter tires. In addition to the M+S marking, winter tires also have the  snowflake symbol on the tire wall. Tires with this marking fulfill the requirements of the Rubber Manufacturers Association (RMA) and the Rubber Association of Canada (RAC) regarding the tire traction on snow. They have been especially developed for driving on snow.

An electronic speed limiter prevents your vehicle from exceeding the following speeds:

- 130 mph (210 km/h):
 - All vehicles (except AMG vehicles)
- 155 mph (250 km/h):
 - SL 63 AMG
 - SL 65 AMG
- 186 mph (300 km/h):
 - SL 63 AMG (Performance Package)
 - SL 65 AMG with increased maximum speed

The speed rating of tires mounted at the factory may be higher than the maximum speed that the electronic speed limiter permits.

¹ Or M+S  for winter tires.

Make sure that your tires have the required speed rating, e.g. when buying new tires. The required speed rating for your vehicle can be found in the "tires" section (▷ page 593).

Further information about reading tire data can be obtained from any qualified specialist workshop.

Load index



In addition to the load bearing index, load rating ① may be imprinted after the letters that identify speed rating on the sidewall of the tire (▷ page 582).

- If no specification is given: no text (as in the example above), represents a standard load (SL) tire
 - XL or Extra Load: represents a reinforced tire
 - Light Load: represents a light load tire
 - C, D, E: represents a load range that depends on the maximum load that the tire can carry at a certain pressure
- ① Tire data is vehicle-specific and may deviate from the data in the example.

Maximum load rating

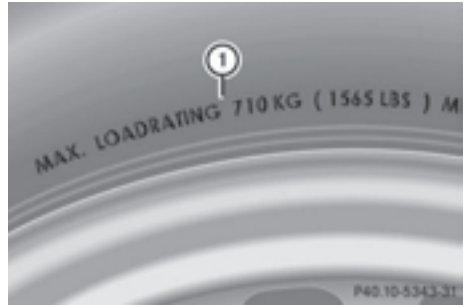

Maximum load rating ① is the maximum permissible weight for which the tire is approved. Do not overload the tires by exceeding the specified load limit. The maximum permissible load can be found on the vehicle's Tire and Loading Information placard on the B-pillar on the driver's side (▷ page 578).

- ① The actual values for tires are vehicle-specific and may deviate from the values in the illustration.

DOT, Tire Identification Number (TIN)

U.S. tire regulations prescribe that every tire manufacturer or retreader must imprint a TIN in or on the sidewall of every tire produced.

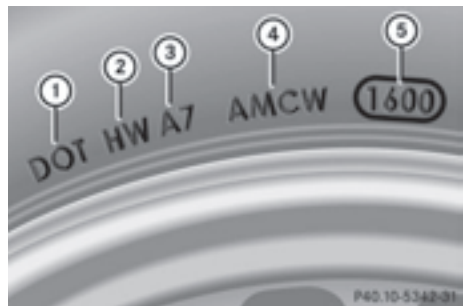

The TIN is a unique identification number. The TIN makes it easier for tire manufacturers or retreaders to notify customers of recalls or other safety-related matters. It makes it possible for the purchaser to easily identify the affected tires.

The TIN consists of the manufacturer identification code ②, tire size ③, tire type code ④ and manufacturing date ⑤.

DOT (Department of Transportation): tire symbol ① indicates that the tire complies with the requirements of the U.S. Department of Transportation.

Manufacturer identification code: manufacturer identification code ② provides details on the tire manufacturer. New tires have a code with two symbols. Retreaded tires have a code with four symbols.

For further information about retreaded tires, see (▷ page 568).

Tire size: identifier ③ describes the tire size.

Tire type code: tire type code ④ can be used by the manufacturer as a code to describe specific characteristics of the tire.

Date of manufacture: date of manufacture ⑤ provides information about the age of a tire. The first and second positions represent the week of manufacture, starting with "01" for the first calendar week. Positions three and four represent the year of manufacture. For example, a tire that is marked with "3208", was manufactured in week 32 in 2008.

i Tire data is vehicle-specific and may deviate from the data in the example.

Tire characteristics



This information describes the type of tire cord and the number of layers in sidewall ① and under tire tread ②.

i Tire data is vehicle-specific and may deviate from the data in the example.

Definition of terms for tires and loading

Tire ply composition and material used

Describes the number of plies or the number of layers of rubber-coated fabric in the tire tread and sidewall. These are made of steel, nylon, polyester and other materials.

Bar

Metric unit for tire pressure. 14.5038 pounds per square inch (psi) and 100 kilopascals (kPa) are the equivalent of 1 bar.

DOT (Department of Transportation)

DOT marked tires fulfill the requirements of the United States Department of Transportation.

Normal occupant weight

The number of occupants which the vehicle is designed for, multiplied by 68 kilograms (150 lb).

Uniform Tire Quality Grading Standards

A uniform standard to grade the quality of tires with regards to tread quality, tire traction and temperature characteristics. Ratings are determined by tire manufacturers using U.S. government testing procedures. The ratings are molded into the sidewall of the tire.

Recommended tire pressure

The recommended tire pressure applies to the tires mounted at the factory.

The Tire and Loading Information placard contains the recommended tire pressures for cold tires on a fully loaded vehicle and for the maximum permissible vehicle speed.

The tire pressure table contains the recommended pressures for cold tires for various operating conditions, i.e. differing load and speed conditions.

Increased vehicle weight due to optional equipment

This is the combined weight of all standard and optional equipment available for the vehicle, regardless of whether it is actually installed on the vehicle or not.

Rim

This is the part of the wheel on which the tire is mounted.

GAWR (Gross Axle Weight Rating)

The GAWR is the maximum permissible axle weight. The actual load on an axle must never exceed the gross axle weight rating. The gross axle weight rating can be found on the vehicle identification plate on the B-pillar on the driver's side.

Speed rating

The speed rating is part of the tire identification. It specifies the speed range for which the tire is approved.

GVW (Gross Vehicle Weight)

The gross vehicle weight includes the weight of the vehicle including fuel, tools, the spare wheel, accessories installed, occupants, luggage and the drawbar noseweight, if applicable. The gross vehicle weight must not exceed the gross vehicle weight rating GVWR as specified on the vehicle identification plate on the B pillar on the driver's side.

GVWR (Gross Vehicle Weight Rating)

The GVWR is the maximum permissible gross weight of a fully loaded vehicle (the weight of the vehicle including all accessories, occupants, fuel, luggage and the drawbar noseweight, if applicable). The gross vehicle weight rating is specified on the vehicle identification plate on the B-pillar on the driver's side.

Maximum loaded vehicle weight

The maximum weight is the sum of:

- the curb weight of the vehicle
- the weight of the accessories

- the load limit
- the weight of the factory installed optional equipment

Kilopascal (kPa)

Metric unit for tire pressure. 6.9 kPa corresponds to 1 psi. Another unit for tire pressure is bar. There are 100 kilopascals (kPa) to 1 bar.

Load index

In addition to the load-bearing index, the load index may also be imprinted on the sidewall of the tire. This specifies the load-bearing capacity more precisely.

Curb weight

The weight of a vehicle with standard equipment including the maximum capacity of fuel, oil and coolant. It also includes the air-conditioning system and optional equipment if these are installed in the vehicle, but does not include passengers or luggage.

Maximum load rating

The maximum tire load is the maximum permissible weight in kilograms or lbs for which a tire is approved.

Maximum permissible tire pressure

Maximum permissible tire pressure for one tire.

Maximum load on one tire

Maximum load on one tire. This is calculated by dividing the maximum axle load of one axle by two.

PSI (pounds per square inch)

A standard unit of measure for tire pressure.

Aspect ratio

Relationship between tire height and tire width in percent.

Tire pressure

This is pressure inside the tire applying an outward force to each square inch of the tire's surface. The tire pressure is specified in

pounds per square inch (psi), in kilopascal (kPa) or in bar. The tire pressure should only be corrected when the tires are cold.

Cold tire pressure

The tires are cold:

- if the vehicle has been parked without direct sunlight on the tires for at least three hours and
- if the vehicle has been driven for less than 1 mile (1.6 km).

Tread

The part of the tire that comes into contact with the road.

Bead

The tire bead ensures that the tire sits securely on the wheel. There are several steel wires in the bead to prevent the tire from coming loose from the wheel rim.

Sidewall

The part of the tire between the tread and the bead.

Weight of optional extras

The combined weight of those optional extras that weigh more than the replaced standard parts and more than 2.3 kilograms (5 lbs).

These optional extras, such as high-performance brakes, level control, a roof rack or a high-performance battery, are not included in the curb weight and the weight of the accessories.

TIN (Tire Identification Number)

This is a unique identifier which can be used by a tire manufacturer to identify tires, for example for a product recall, and thus identify the purchasers. The TIN is made up of the manufacturer's identity code, tire size, tire type code and the manufacturing date.

Load bearing index

The load bearing index (also load index) is a code that contains the maximum load bearing capacity of a tire.

Traction

Traction is the result of friction between the tires and the road surface.

Treadwear indicators

Narrow bars (tread wear bars) that are distributed over the tire tread. If the tire tread is level with the bars, the wear limit of $\frac{1}{16}$ in (1.6 mm) has been reached.

Occupant distribution

The distribution of occupants in a vehicle at their designated seating positions.

Total load limit

Rated cargo and luggage load plus 68 kilograms (150 lb) multiplied by the number of seats in the vehicle.

Changing a wheel

Flat tire

The "Breakdown assistance" section (> page 548) contains information and notes on how to deal with a flat tire. Information on driving with MOExtended tires in the event of a flat tire can be found under "MOExtended tires (tires with run-flat characteristics)" (> page 549).

Rotating the wheels

WARNING

Interchanging the front and rear wheels may severely impair the driving characteristics if the wheels or tires have different dimensions. The wheel brakes or suspension components may also be damaged. There is a risk of accident.

Rotate front and rear wheels only if the wheels and tires are of the same dimensions.

- ❗ On vehicles equipped with a tire pressure monitor, electronic components are located in the wheel.

Tire-mounting tools should not be used near the valve. This could damage the electronic components.

Only have tires changed at a qualified specialist workshop.

Always pay attention to the instructions and safety notes when changing a wheel (▷ page 589).

The wear patterns on the front and rear tires differ, depending on the operating conditions. Rotate the wheels before a clear wear pattern has formed on the tires. Front tires typically wear more on the shoulders and the rear tires in the center.

If your vehicle's tire configuration allows, you can rotate the wheels according to the intervals in the tire manufacturer's warranty book in your vehicle documents. If no warranty book is available, the tires should be rotated every 3,000 to 6,000 miles (5,000 to 10,000 km), or earlier if tire wear requires. Do not change the direction of wheel rotation.

Clean the contact surfaces of the wheel and the brake disc thoroughly every time a wheel is rotated. Check the tire pressure and reactivate the tire pressure monitor if necessary.

Direction of rotation

Tires with a specified direction of rotation have additional benefits, e.g. if there is a risk of hydroplaning. You will only gain these benefits if the correct direction of rotation is maintained.

An arrow on the sidewall of the tire indicates its correct direction of rotation.

Storing wheels

Store wheels that are not being used in a cool, dry and preferably dark place. Protect the tires from oil, grease, gasoline and diesel.

Cleaning the wheels

WARNING

The water jet from a circular jet nozzle (dirt blasters) can cause invisible exterior damage to the tires or chassis components. Components damaged in this way may fail unexpectedly. There is a risk of an accident.

Do not use power washers with circular jet nozzles to clean the vehicle. Have damaged tires or chassis components replaced immediately.

Mounting a wheel

Preparing the vehicle

- ▶ Stop the vehicle on solid, non-slippery and level ground.
- ▶ Unload the vehicle. The jack can only be used when the vehicle is unladen.
- ▶ Apply the electric parking brake manually.
- ▶ Bring the front wheels into the straight-ahead position.
- ▶ Shift the transmission to position **P**.
- ▶ Switch off the engine.
- ▶ **Vehicles without KEYLESS-GO:** remove the SmartKey from the ignition lock.
- ▶ **Vehicles with KEYLESS-GO:** open the driver's door.
The on-board electronics now have status **0**. This is the same as the SmartKey having been removed.
- ▶ **Vehicles with KEYLESS-GO:** remove the Start/Stop button from the ignition lock (▷ page 151).
- ▶ If included in the vehicle equipment, remove the tire-change tool kit from the vehicle.
- ▶ Secure the vehicle to prevent it from rolling away.

Securing the vehicle to prevent it from rolling away

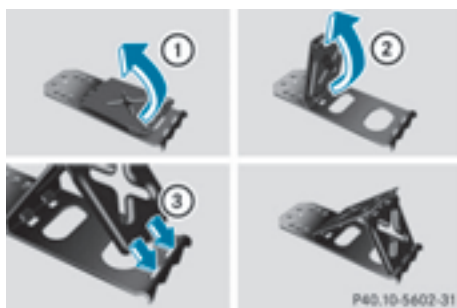

If your vehicle is equipped with a wheel chock, it can be found in the tire-change tool kit (▷ page 548).

The folding wheel chock is an additional securing measure to prevent the vehicle from rolling away, for example when changing a wheel.

- ▶ Fold both plates upwards ①.
- ▶ Fold out lower plate ②.
- ▶ Guide the lugs on the lower plate fully into the openings in base plate ③.

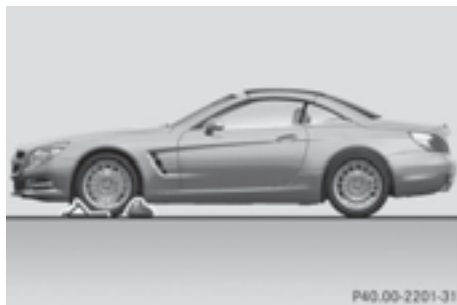

Securing the vehicle on level ground

- ▶ **On level ground:** place chocks or other suitable items under the front and rear of the wheel that is diagonally opposite the wheel you wish to change.

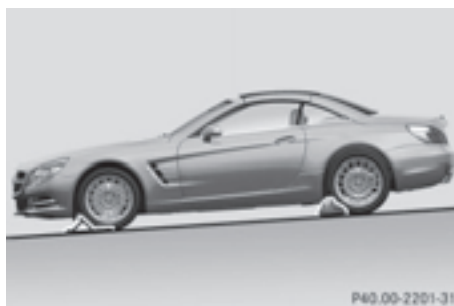

Securing the vehicle on slight downhill gradients

- ▶ **On light downhill gradients:** place chocks or other suitable items in front of the wheels of the front and rear axle.

Raising the vehicle

WARNING

If you do not position the jack correctly at the appropriate jacking point of the vehicle, the jack could tip over with the vehicle raised. There is a risk of injury.

Only position the jack at the appropriate jacking point of the vehicle. The base of the jack must be positioned vertically, directly under the jacking point of the vehicle.

- ❗ The jack is designed exclusively for jacking up the vehicle at the jacking points. Otherwise, your vehicle could be damaged.

The following must be observed when raising the vehicle:

- to raise the vehicle, only use the vehicle-specific jack that has been tested and approved by Mercedes-Benz. If used incorrectly, the jack could tip over with the vehicle raised.
- the jack is designed only to raise and hold the vehicle for a short time while a wheel is being changed. It is not suited for performing maintenance work under the vehicle.
- avoid changing the wheel on uphill and downhill slopes.

- before raising the vehicle, secure it from rolling away by applying the parking brake and inserting wheel chocks. Never disengage the parking brake while the vehicle is raised.
- the jack must be placed on a firm, flat and non-slip surface. On a loose surface, a large, flat, load-bearing underlay must be used. On a slippery surface, a non-slip underlay must be used, e.g. rubber mats.
- do not use wooden blocks or similar objects as a jack underlay. Otherwise, the jack will not be able to achieve its load-bearing capacity due to the restricted height.
- make sure that the distance between the underside of the tires and the ground does not exceed 1.2 in (3 cm).
- never place your hands and feet under the raised vehicle.
- do not lie under the vehicle.
- do not start the engine when the vehicle is raised.
- do not open or close a door or the trunk lid when the vehicle is raised.
- make sure that no persons are present in the vehicle when the vehicle is raised.

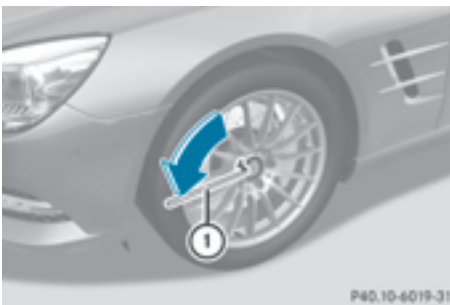

- Using lug wrench ①, loosen the bolts on the wheel you wish to change by about one full turn. Do not unscrew the bolts completely.

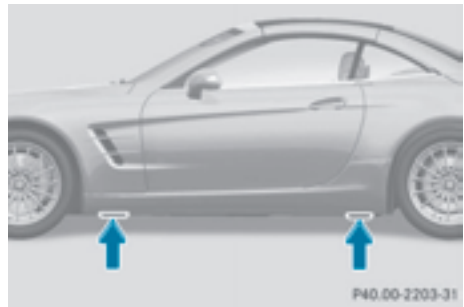

The jacking points are located just behind the front wheel housings and just in front of the rear wheel housings (arrows).

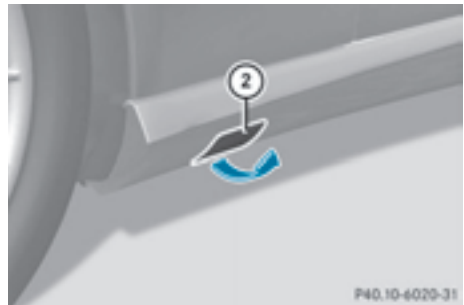

Covers, front (example: vehicles with AMG equipment)

AMG vehicles and vehicles with AMG equipment: to protect the vehicle body, the vehicle has covers next to the jacking points on the outer sills.

- **AMG vehicles and vehicles with AMG equipment:** fold cover ② upwards.

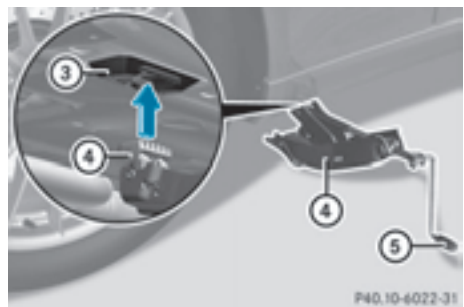

- Position jack ④ at jacking point ③.

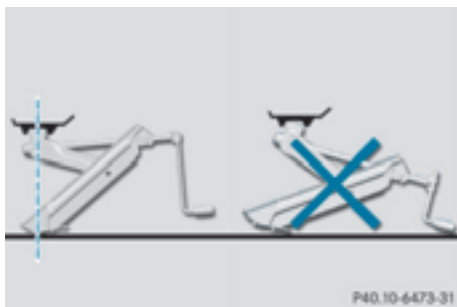

Example

- ▶ Make sure the foot of the jack is directly beneath the jacking point.
- ▶ Turn crank ⑤ clockwise until jack ④ sits completely on jacking point ③ and the base of the jack lies evenly on the ground.
- ▶ Turn crank ⑤ until the tire is raised a maximum of 1.2 in (3 cm) from the ground.

Removing a wheel

! **AMG vehicles:** during removal and repositioning of the wheel, the wheel rim can strike the ceramic-brake disc and damage it. Therefore, you should proceed carefully and get a second person assist to you. Alternatively, you can use a second alignment bolt.

! Do not place wheel bolts in sand or on a dirty surface. The bolt and wheel hub threads could otherwise be damaged when you screw them in.

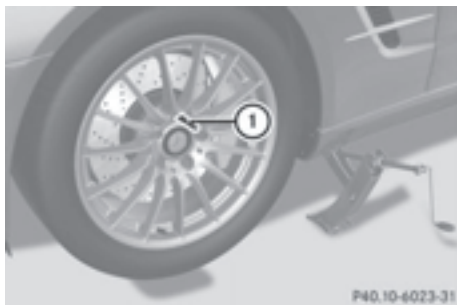

- ▶ Unscrew the uppermost wheel bolt completely.
- ▶ Screw alignment bolt ① into the thread instead of the wheel bolt.
- ▶ Unscrew the remaining wheel bolts fully.
- ▶ Remove the wheel.

Mounting a new wheel

WARNING

Oiled or greased wheel bolts or damaged wheel bolts/hub threads can cause the wheel bolts to come loose. As a result, you could lose a wheel while driving. There is a risk of accident.

Never oil or grease wheel bolts. In the event of damage to the threads, contact a qualified specialist workshop immediately. Have the damaged wheel bolts or hub threads replaced/renewed. Do not continue driving.

WARNING

If you tighten the wheel bolts or wheel nuts when the vehicle is raised, the jack could tip over. There is a risk of injury.

Only tighten the wheel bolts or wheel nuts when the vehicle is on the ground.

Always pay attention to the instructions and safety notes in the "Changing a wheel" section (> page 588).

Only use wheel bolts that have been designed for the wheel and the vehicle. For safety reasons, Mercedes-Benz recommends that you only use wheel bolts which have been approved for Mercedes-Benz vehicles and the respective wheel.

! **AMG vehicles:** during removal and repositioning of the wheel, the wheel rim can strike the ceramic-brake disc and damage it. Therefore, you should proceed carefully and get a second person assist to you. Alternatively, you can use a second alignment bolt.

- ! To prevent damage to the paintwork, hold the wheel securely against the wheel hub while screwing in the first wheel bolt.

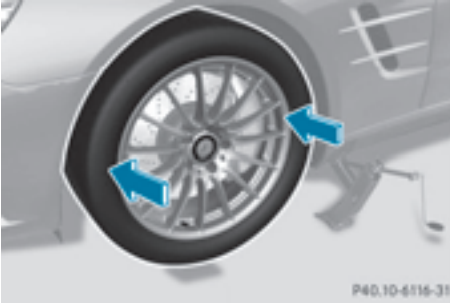

P40.10-6116-31

- ▶ Clean the wheel and wheel hub contact surfaces.
- ▶ Slide the wheel to be mounted onto the alignment bolt and push it on.
- ▶ Tighten the wheel bolts until they are finger-tight.
- ▶ Unscrew the alignment bolt.
- ▶ Tighten the last wheel bolt until it is finger-tight.
- ▶ Turn the crank of the jack counter-clockwise until the vehicle is once again standing firmly on the ground.
- ▶ Place the jack to one side.
- ▶ Tighten the wheel bolts evenly in a cross-wise pattern in the sequence indicated (① to ⑤). The specified tightening torque is **96 lb-ft (130 Nm)**.
- ▶ Turn the jack back to its initial position.
- ▶ Stow the jack and the rest of the vehicle tools in the trunk again.
- ▶ **AMG vehicles and vehicles with AMG equipment:** insert the cover into the outer sill.
- ▶ Check the tire pressure of the newly mounted wheel and adjust it if necessary. Observe the recommended tire pressure (▷ page 572).

- i When you are driving with the emergency spare wheel mounted, the tire pressure monitor cannot function reliably. Only restart the tire pressure monitor when the defective wheel has been replaced with a new wheel.

All mounted wheels must be equipped with functioning sensors for the tire pressure monitor.

Lowering the vehicle

WARNING

The wheels could work loose if the wheel nuts and bolts are not tightened to the specified tightening torque. There is a risk of accident. Have the tightening torque immediately checked at a qualified specialist workshop after a wheel is changed.

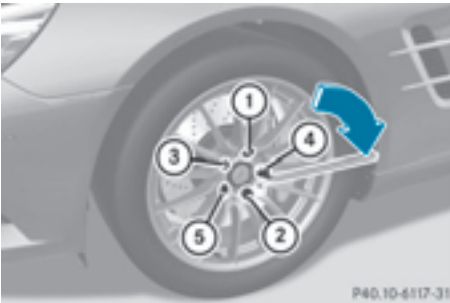

P40.10-6117-31

Wheel and tire combinations

General notes

- ! For safety reasons, Mercedes-Benz recommends that you only use tires and wheels which have been approved by Mercedes-Benz specifically for your vehicle.

These tires have been specially adapted for use with the control systems, such as ABS or ESP[®], and are marked as follows:

- MO = Mercedes-Benz Original
- MOE = Mercedes-Benz Original Extended (tires featuring run-flat characteristics)
- MO1 = Mercedes-Benz Original (only certain AMG tires)

Mercedes-Benz Original Extended tires may only be used on wheels that have been specifically approved by Mercedes-Benz.

Only use tires, wheels or accessories tested and approved by Mercedes-Benz. Certain characteristics, e.g. handling, vehicle noise emissions or fuel consumption, may otherwise be adversely affected. In addition, when driving with a load, tire dimension variations could cause the tires to come into contact with the bodywork and axle components. This could result in damage to the tires or the vehicle.

Mercedes-Benz accepts no liability for damage resulting from the use of tires, wheels or accessories other than those tested and approved.

Information on tires, wheels and approved combinations can be obtained from any qualified specialist workshop.

! Retreaded tires are neither tested nor recommended by Mercedes-Benz, since previous damage cannot always be detected on retreaded tires. As a result, Mercedes-Benz cannot guarantee vehicle safety if retreaded tires are mounted. Do not mount used tires if you have no information about their previous usage.

Overview of abbreviations used in the following tire tables:

- BA: both axles
- FA: front axle
- RA: rear axle

The recommended pressures for various operating conditions can be found:

- on the Tire and Loading Information placard with the recommended tire pressures on the B-pillar on the driver's side
- in the tire pressure table on the inside of the fuel filler flap

Observe the notes on recommended tire pressures under various operating conditions (▷ page 572).

Check tire pressures regularly, and only when the tires are cold. Comply with the maintenance recommendations of the tire manufacturer in the vehicle document wallet.

Notes on the vehicle equipment – always equip the vehicle with:

- tires of the same size on a given axle (left/right)
- the same type of tires at a given time (summer tires, winter tires, MOExtended tires)
Exception: it is permissible to install a different type or make in the event of a flat tire. Observe the "MOExtended tires (tires with run-flat characteristics)" section (▷ page 549).

Vehicles equipped with MOExtended tires are not equipped with a TIREFIT kit at the factory. It is therefore recommended that you additionally equip your vehicle with a TIREFIT kit if you mount tires that do not feature run-flat properties, e.g. winter tires. A TIREFIT kit may be obtained from a qualified specialist workshop.

- i** Not all wheel and tire combinations are available at the factory for all countries.
- i** The following pages contain information on approved wheel rims and tire sizes for equipping your vehicle with winter tires. Winter tires are not available at the factory as standard equipment or optional extras. If you want to equip your vehicle with approved winter tires, it may be necessary to obtain wheel rims in the corresponding size. The size of the approved winter tires may differ from the standard tires. This is

dependent on the model and the equipment installed at the factory.

The tires and wheel rims, as well as further information, can be obtained at a qualified specialist workshop.

Tires

SL 400

Summer tires

R18

Tires	Alloy wheels
FA: 255/40 R18 95 Y ² RA: 285/35 R18 97 Y ^{4,3}	FA: 8.5 J x 18 H2 Wheel offset: 1.40 in (35.5 mm) RA: 9.5 J x 18 H2 Wheel offset: 1.87 in (47.5 mm)

R19

Tires	Alloy wheels
FA: 255/35 R19 96 Y XL ⁴ RA: 285/30 R19 98 Y XL ^{4,5}	FA: 8.5 J x 19 H2 Wheel offset: 1.36 in (34.5 mm) RA: 9.5 J x 19 H2 Wheel offset: 1.89 in (48 mm)
FA: 255/35 R19 96 Y XL ⁴ RA: 285/30 R19 98 Y XL ^{4,5}	FA: 8.5 J x 19 H2 Wheel offset: 1.40 in (35.5 mm) RA: 9.5 J x 19 H2 Wheel offset: 1.87 in (47.5 mm)
FA: 255/35 R19 96 Y XL ⁴ RA: 285/30 R19 98 Y XL ^{4,5}	FA: 8.5 J x 19 H2 Wheel offset: 1.40 in (35.5 mm) RA: 9.5 J x 19 H2 Wheel offset: 1.89 in (48 mm)

Winter tires

R18

Tires	Alloy wheels
BA: 255/40 R18 99 V XL M+S  ⁴	BA: 8.5 J x 18 H2 Wheel offset: 1.40 in (35.5 mm)

² Available as MOExtended tires.

⁴ Available as MOExtended tires.

³ The use of snow chains is not permitted. Observe the notes in the "Snow chains" section.

⁵ The use of snow chains is not permitted. Observe the notes in the "Snow chains" section.

SL 550

Summer tires

R18

Tires	Alloy wheels
FA: 255/40 R18 95 Y ⁴ RA: 285/35 R18 97 Y ^{4, 5}	FA: 8.5 J x 18 H2 Wheel offset: 1.40 in (35.5 mm) RA: 9.5 J x 18 H2 Wheel offset: 1.87 in (47.5 mm)

R19

Tires	Alloy wheels
FA: 255/35 R19 96 Y XL ⁴ RA: 285/30 R19 98 Y XL ^{4, 5}	FA: 8.5 J x 19 H2 Wheel offset: 1.36 in (34.5 mm) RA: 9.5 J x 19 H2 Wheel offset: 1.89 in (48 mm)
FA: 255/35 R19 96 Y XL ⁴ RA: 285/30 R19 98 Y XL ^{4, 5}	FA: 8.5 J x 19 H2 Wheel offset: 1.40 in (35.5 mm) RA: 9.5 J x 19 H2 Wheel offset: 1.87 in (47.5 mm)
FA: 255/35 R19 96 Y XL ⁴ RA: 285/30 R19 98 Y XL ^{4, 5}	FA: 8.5 J x 19 H2 Wheel offset: 1.40 in (35.5 mm) RA: 9.5 J x 19 H2 Wheel offset: 1.89 in (48 mm)

Winter tires

R18

Tires	Alloy wheels
BA: 255/40 R18 99 V XL M+S  ⁴	BA: 8.5 J x 18 H2 Wheel offset: 1.40 in (35.5 mm)

AMG vehicles

Summer tires

i **AMG vehicles with 20 inch wheels on the rear axle:** if replaced with 19 inch wheels, ETS may intervene noticeably earlier for the first few kilometers. After approximately 10 km, ETS

⁴ Available as MOExtended tires.

⁵ The use of snow chains is not permitted. Observe the notes in the "Snow chains" section.



functions as usual again. Information on ETS can be found under "ETS (Electronic Traction System)" (▷ page 74).

R19/R20

Tires	Alloy wheels
FA: 255/35 ZR19 (96 Y) XL RA: 285/30 ZR19 (98 Y) XL	FA: 9.0 J x 19 H2 Wheel offset: 1.06 in (27 mm) RA: 10.0 J x 19 H2 Wheel offset: 1.89 in (48 mm)
FA: 255/35 ZR19 (96 Y) XL RA: 285/30 ZR20 (99 Y) XL ⁵	FA: 9.0 J x 19 H2 Wheel offset: 1.06 in (27 mm) RA: 10.0 J x 20 H2 Wheel offset: 1.89 in (48 mm)

Winter tires

R19

Tires	Alloy wheels
FA: 255/35 R19 96 V XL M+S  RA: 285/30 R19 98 V XL M+S 	FA: 9.0 J x 19 H2 Wheel offset: 1.06 in (27 mm) RA: 10.0 J x 19 H2 Wheel offset: 1.89 in (48 mm)

⁵ The use of snow chains is not permitted. Observe the notes in the "Snow chains" section.

Useful information	600
Information regarding technical data	600
Identification plates	600
Service products and filling capaci- ties	601
Vehicle data	607

Useful information

- i** This Operator's manual describes all models and all standard and optional equipment of your vehicle available at the time of publication of the Operator's manual. Country-specific differences are possible. Please note that your vehicle may not be equipped with all features described. This also applies to safety-related systems and functions.
- i** Read the information on qualified specialist workshops (► page 35).

Information regarding technical data

- i** The data stated here specifically refers to a vehicle with standard equipment. Consult an authorized Mercedes-Benz Center for the data for all vehicle variants and trim levels.

Identification plates

Vehicle identification plate with vehicle identification number (VIN)



- Open the driver's door. You will see vehicle identification plate ①.



Example: vehicle identification plate (USA only)

- ② VIN
- ③ Vehicle model



Example: vehicle identification plate (Canada only)

- ② VIN
- ③ Paint code

- i** The data shown on the vehicle identification plate is used only as an example. This data is different for every vehicle and can deviate from the data shown here. You can find the data applicable to your vehicle on the vehicle identification plate.

VIN

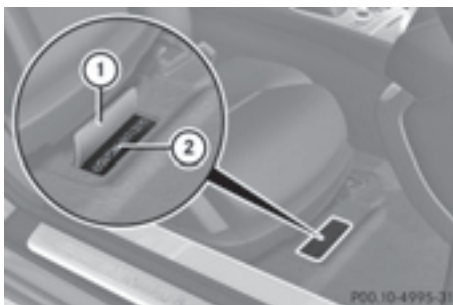

- ▶ Move the front-passenger front seat to its rearmost position.
- ▶ Fold up floor covering ① in front of the front-passenger seat. You will see VIN ②.

The VIN can also be found in the following locations:

- on the lower edge of the windshield (▷ page 601)
- on the vehicle identification plate (▷ page 600)

Engine number



- ① Emission control information plate, including the certification of both federal and Californian emissions standards
- ② Engine number (stamped into the crankcase)
- ③ VIN (on the lower edge of the windshield)

Service products and filling capacities

Important safety notes

⚠ WARNING

Service products may be poisonous and hazardous to health. There is a risk of injury.

Comply with instructions on the use, storage and disposal of service products on the labels of the respective original containers. Always store service products sealed in their original containers. Always keep service products out of the reach of children.

♻ Environmental note

Dispose of service products in an environmentally responsible manner.

Service products include the following:

- Fuels
- Lubricants (e.g. engine oil, transmission oil)
- Coolant
- Brake fluid
- Windshield washer fluid
- Climate control system refrigerant

Comply with all valid regulations with respect to handling, storing, and disposing of service fluids.

Components and service products must be matched. You should therefore only use products that have been tested and approved by Mercedes-Benz.

Information about tested and approved products can be obtained from an authorized Mercedes-Benz Center or on the Internet at <http://bevo.mercedes-benz.com>.

You can recognize service products approved by Mercedes-Benz by the following inscription on the containers:

- MB-Freigabe (e.g. MB-Freigabe 229.51)
- MB Approval (e.g. MB Approval 229.51)

Other designations or recommendations indicate a level of quality or a specification in accordance with an MB Sheet Number (e.g.

MB 229.51). They have not necessarily been approved by Mercedes-Benz.

Fuel

Important safety notes

WARNING

Fuel is highly flammable. If you handle fuel incorrectly, there is a risk of fire and explosion.

You must avoid fire, open flames, creating sparks and smoking. Switch off the engine and, if applicable, the auxiliary heating before refueling.

WARNING

Fuel is poisonous and hazardous to health. There is a risk of injury.

You must make sure that fuel does not come into contact with your skin, eyes or clothing and that it is not swallowed. Do not inhale fuel vapors. Keep fuel away from children.

If you or others come into contact with fuel, observe the following:

- Wash away fuel from skin immediately using soap and water.
- If fuel comes into contact with your eyes, immediately rinse them thoroughly with clean water. Seek medical assistance without delay.
- If fuel is swallowed, seek medical assistance without delay. Do not induce vomiting.
- Immediately change out of clothing which has come into contact with fuel.

Tank capacity

Model	Total capacity
All models	19.8 US gal (75.0 l)

Model	Of which reserve
AMG vehicles	Approx. 3.7 US gal (14.0 l)
All other models	Approx. 2.4 US gal (9.0 l)

Gasoline

Fuel grade

 Do not use diesel to refuel vehicles with a gasoline engine. Do not switch on the ignition if you accidentally refuel with the wrong fuel. Otherwise, the fuel will enter the fuel system. Even small amounts of the wrong fuel could result in damage to the fuel system and the engine. Notify a qualified specialist workshop and have the fuel tank and fuel lines drained completely.

 Only refuel using unleaded premium grade gasoline with at least 91 AKI/95 RON.

 Only use the fuel recommended. Operating the vehicle with other fuels can lead to engine failure.

 Do not use the following:

- E85 (gasoline with 85% ethanol)
- E100 (100% ethanol)
- M15 (gasoline with 15% methanol)
- M30 (gasoline with 30% methanol)
- M85 (gasoline with 85% methanol)
- M100 (100% methanol)
- Gasoline with metalliferous additives
- Diesel

Do not mix such fuels with the fuel recommended for your vehicle. Do not use additives. This can otherwise lead to engine damage. This does not include cleaning additives for the removal and prevention of residue build-up. Gasoline may only be mixed with cleaning additives recommen-

ded by Mercedes-Benz; see "Additives". You can obtain further information from any authorized Mercedes-Benz Center.

! To ensure the longevity and full performance of the engine, only premium-grade unleaded gasoline must be used.

If standard unleaded gasoline is unavailable and you have to refuel with unleaded gasoline of a lower grade, observe the following precautions:

- Only fill the fuel tank to half full with regular unleaded gasoline and fill the rest with premium-grade unleaded gasoline as soon as possible.
- Do not drive at the maximum speed.
- Avoid sudden acceleration and engine speeds over 3,000 rpm.

Using mixtures of methanol and ethanol is not permitted. E10 fuel or E15 fuel (unleaded gasoline with 10% or 15% ethanol) can be used. You will usually find information about the fuel grade on the pump. If you cannot find the label on the pump, ask the staff for assistance.

i For further information, consult a qualified specialist workshop or visit <http://www.mbusa.com> (USA only).

As a temporary measure, if the recommended fuel is not available, you may also use unleaded gasoline with an octane rating of 87 AKI/91 RON. This may reduce engine performance and increase fuel consumption. Avoid driving at full throttle and sudden acceleration. Never refuel using fuel with a lower AKI. Information on refueling (> page 168).

Additives in gasoline

! Operating the engine with fuel additives added later can lead to engine failure. Do not mix fuel additives with fuel. This does not include additives for the removal and prevention of residue buildup. Gasoline must only be mixed with additives recommended by Mercedes-Benz. Comply with the instructions for use on the product

label. More information about recommended additives can be obtained from any authorized Mercedes-Benz Center.

Mercedes-Benz recommends that you use branded fuels that have additives.

The quality of the fuel available in some countries may not be sufficient. Residue could build up in the injection system as a result. In such cases, and in consultation with an authorized Mercedes-Benz Center, the gasoline may be mixed with the cleaning additive recommended by Mercedes-Benz. You must observe the notes and mixing ratios specified on the container.

Engine oil

General notes

! Never use engine oil or an oil filter of a specification other than is necessary to fulfill the prescribed service intervals. Do not change the engine oil or oil filter in order to achieve longer replacement intervals than those prescribed. You could otherwise cause engine damage or damage to the exhaust gas aftertreatment.

Follow the instructions in the service interval display regarding the oil change. Otherwise, you may damage the engine and the exhaust gas aftertreatment.

When handling engine oil, observe the important safety notes on service products (> page 601).

The engine oils are matched to the performance of Mercedes-Benz engines and service intervals. You should therefore only use engine oils and oil filters that are approved for vehicles with maintenance systems.

For a list of approved engine oils and oil filters, consult an authorized Mercedes-Benz Center. Or visit the website <http://bevo.mercedes-benz.com>.

The table shows which engine oils have been approved for your vehicle.

Model	Engine model	MB Approval
SL 400	276	229.5
SL 550	278	229.5
SL 63 AMG	157	229.5
SL 65 AMG V12	279	229.5

Use only SAE 0W-40 or SAE 5W-40 engine oils for AMG vehicles.

- MB approval is indicated on the oil containers.

Filling capacities

The following values refer to an oil change including the oil filter.

Model	Capacity
SL 400	6.9 US qt (6.5 l)
SL 550	8.5 US qt (8.0 l)
SL 63 AMG	Without external oil cooler: 9.0 US qt (8.5 l) With external oil cooler: 10 US qt (9.5 l)
SL 65 AMG V12	Without external oil cooler: 10.6 US qt (10.0 l) With external oil cooler: 11.6 US qt (11.0 l)

Additives

- Do not use any additives in the engine oil. This could damage the engine.

Engine oil viscosity

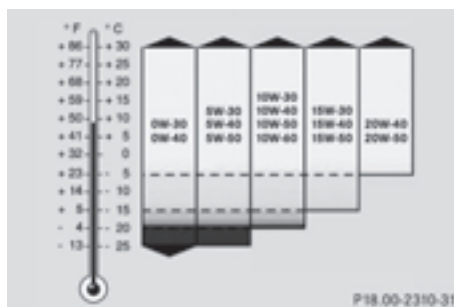

Viscosity describes the flow characteristics of a fluid. If an engine oil has a high viscosity, this means that it is thick; a low viscosity means that it is thin.

Select an engine oil with an SAE classification (viscosity) suitable for the prevailing outside temperatures. The table shows you which SAE classifications are to be used. The low-temperature characteristics of engine oils can deteriorate significantly, e.g. as a result of aging, soot and fuel deposits. It is therefore strongly recommended that you carry out regular oil changes using an approved engine oil with the appropriate SAE classification.

Brake fluid

⚠ WARNING

The brake fluid constantly absorbs moisture from the air. This lowers the boiling point of the brake fluid. If the boiling point of the brake fluid is too low, vapor pockets may form in the brake system when the brakes are applied hard. This would impair braking efficiency. There is a risk of an accident.

You should have the brake fluid renewed at the specified intervals.

When handling brake fluid, observe the important safety notes on service products (> page 601).

The brake fluid change intervals can be found in the Maintenance Booklet.

Only use brake fluid approved by Mercedes-Benz according to MB Approval 33 1.0.

Information about approved brake fluid can be obtained at any qualified specialist workshop or on the Internet at <http://bevo.mercedes-benz.com>.

- i** Have the brake fluid regularly replaced at a qualified specialist workshop and the replacement confirmed in the Maintenance Booklet.

Coolant

Important safety notes

WARNING

If antifreeze comes into contact with hot components in the engine compartment, it may ignite. There is a risk of fire and injury.

Let the engine cool down before you add antifreeze. Make sure that antifreeze is not spilled next to the filler neck. Thoroughly clean the antifreeze from components before starting the engine.

- !** Only add coolant that has been premixed with the desired antifreeze protection. You could otherwise damage the engine. Further information on coolants can be found in the Mercedes-Benz Specifications for Service Products, MB BeVo 310.1, e.g. on the Internet at <http://bevo.mercedes-benz.com>. Or contact a qualified specialist workshop.

- !** Always use a suitable coolant mixture, even in countries where high temperatures prevail.

Otherwise, the engine cooling system is not sufficiently protected from corrosion and overheating.

- i** Have the coolant regularly replaced at a qualified specialist workshop and the replacement confirmed in the Maintenance Booklet.

Comply with the important safety precautions for service products when handling coolant (▷ page 601).

The coolant is a mixture of water and antifreeze/corrosion inhibitor. It performs the following tasks:

- corrosion protection
- antifreeze protection
- raising the boiling point

If the coolant has antifreeze protection down to -35 °F (-37 °C), the boiling point of the coolant during operation is approximately 266 °F (130 °C).

The antifreeze/corrosion inhibitor concentration in the engine cooling system should:

- be at least 50%. This will protect the engine cooling system against freezing down to approximately -35 °F (-37 °C).
- not exceed 55% (antifreeze protection down to -49 °F [-45 °C]). Otherwise, heat will not be dissipated as effectively.

If the vehicle has lost coolant, add equal amounts of water and antifreeze/corrosion inhibitor.

Mercedes-Benz recommends an antifreeze/corrosion inhibitor concentrate in accordance with MB Specifications for Service Products 310.1.

- i** When the vehicle is first delivered, it is filled with a coolant mixture that ensures adequate antifreeze and corrosion protection.
- i** The coolant is checked with every maintenance interval at a qualified specialist workshop.

Filling capacities

Model	Capacity
SL 400	Approx. 11.9 US qt (11.3 l)
SL 550	Approx. 13.0 US qt (12.3 l)

Model	Capacity
SL 63 AMG	Approx. 11.6 US qt (11.0 l)
SL 65 AMG V12	Approx. 13.5 US qt (12.8 l)

i Use MB 325.0 or MB 326.0 approved antifreeze/corrosion inhibitor.

Windshield washer system and headlamp cleaning system

Important safety notes

WARNING

Windshield washer concentrate could ignite if it comes into contact with hot engine components or the exhaust system. There is a risk of fire and injury.

Make sure that no windshield washer concentrate is spilled next to the filler neck.

! Only use washer fluid that is suitable for plastic lamp lenses, e.g. MB SummerFit or MB WinterFit. Unsuitable washer fluid could damage the plastic lenses of the headlamps.

! Do not add distilled or de-ionized water to the washer fluid container. Otherwise, the level sensor may be damaged.

! Only MB SummerFit and MB WinterFit washer fluid should be mixed together. The spray nozzles may otherwise become blocked.

When handling washer fluid, observe the important safety notes on service products (> page 601).

At temperatures above freezing:

- ▶ Fill the washer fluid reservoir with a mixture of water and windshield washer fluid, e.g. MB SummerFit.
- ▶ Add 1 part MB SummerFit to 100 parts water.

At temperatures below freezing:

- ▶ Fill the washer fluid reservoir with a mixture of water and washer fluid, e.g. MB WinterFit.

Adapt the mixing ratio to the outside temperature.

- Down to 14 °F (-10 °C): mix 1 part MB WinterFit to 2 parts water.
- Down to -4 °F (-20 °C): mix 1 part MB WinterFit to 1 part water.
- Down to -20.2 °F (-29 °C): mix 2 parts MB WinterFit to 1 part water.

i Add windshield washer fluid, e.g. MB SummerFit or MB WinterFit, to the washer fluid all year round.

Climate control system refrigerant

Important safety notes

The climate control system of your vehicle is filled with refrigerant R-134a.

The instruction label regarding the refrigerant type used can be found on the radiator cross member.

! Only the refrigerant R-134a and the PAG oil approved by Mercedes-Benz may be used. The approved PAG oil may not be mixed with any other PAG oil that is not approved for R-134a refrigerant. Otherwise, the climate control system may be damaged.

Service work, such as topping up refrigerant or replacing components, may only be carried out by a qualified specialist workshop. All applicable regulations must be adhered to, SAE standard J639 included.

Always have work on the climate control system carried out at a qualified specialist workshop.

Refrigerant instruction label



Example: refrigerant instruction label

- ① Warning symbol
- ② Refrigerant filling capacity
- ③ Applicable standards
- ④ PAG oil part number
- ⑤ Type of refrigerant

Warning symbol ① advises you about:

- possible dangers
- having service work carried out at a qualified specialist workshop

Filling capacities

Model	Refrigerant
AMG vehicles	22.2 ± 0.4 oz (630 ± 10 g)
All other models	19.4 ± 0.4 oz (550 ± 10 g)

Model	PAG oil
AMG vehicles	2.8 oz (80 g)
All other models	4.2 oz (120 g)

Vehicle data

General notes

Please note that for the specified vehicle data:

- the heights specified may vary as a result of:
 - tires
 - load
 - condition of the suspension
 - optional equipment
- optional equipment reduces the maximum payload.

Dimensions and weights

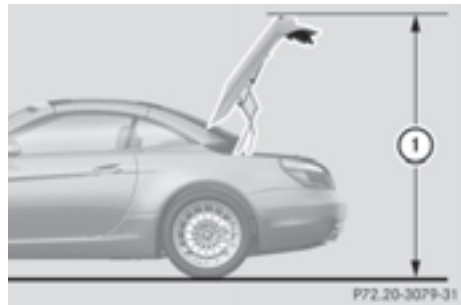

Model	① Opening height
AMG vehicles	76.0 in - 76.6 in (1931 mm - 1945 mm)
All other models	75.7 in (1923 mm)

SL 63 AMG and SL 65 AMG V12

Vehicle length	182.4 in (4633 mm)
Vehicle length when opening/closing the roof	191.3 in (4858 mm)

**SL 63 AMG and
SL 65 AMG V12**

Vehicle width including exterior mirrors	82.6 in (2099 mm)
Vehicle height	51.2 in - 51.5 in (1300 mm - 1308 mm)
Vehicle height, when opening/closing the roof	66.5 in - 67.4 in (1688 mm - 1713 mm)
Wheelbase	101.8 in (2585 mm)
Turning radius	36.3 ft (11.05 m)
Maximum trunk load	220 lb (100 kg)

All other models

Vehicle length	181.6 in (4612 mm)
Vehicle length when opening/closing the roof	188.9 in (4798 mm)
Vehicle width including exterior mirrors	82.6 in (2099 mm)
Vehicle height	51.8 in (1315 mm)
Vehicle height, when opening/closing the roof	66.8 in (1696 mm)
Wheelbase	101.8 in (2585 mm)
Turning radius	36.2 ft (11.04 m)
Maximum trunk load	220 lb (100 kg)